

***BOSE***<sup>®</sup>



---

**Bose<sup>®</sup> SoundLink<sup>®</sup>**  
**Mini *Bluetooth*<sup>®</sup> Speaker**

---

Owner's Guide

# Safety Information

---

## Please read this guide

Please take the time to follow the instructions in this owner's guide carefully. It will help you set up and operate your system properly and enjoy its advanced features. Please save this guide for future reference.

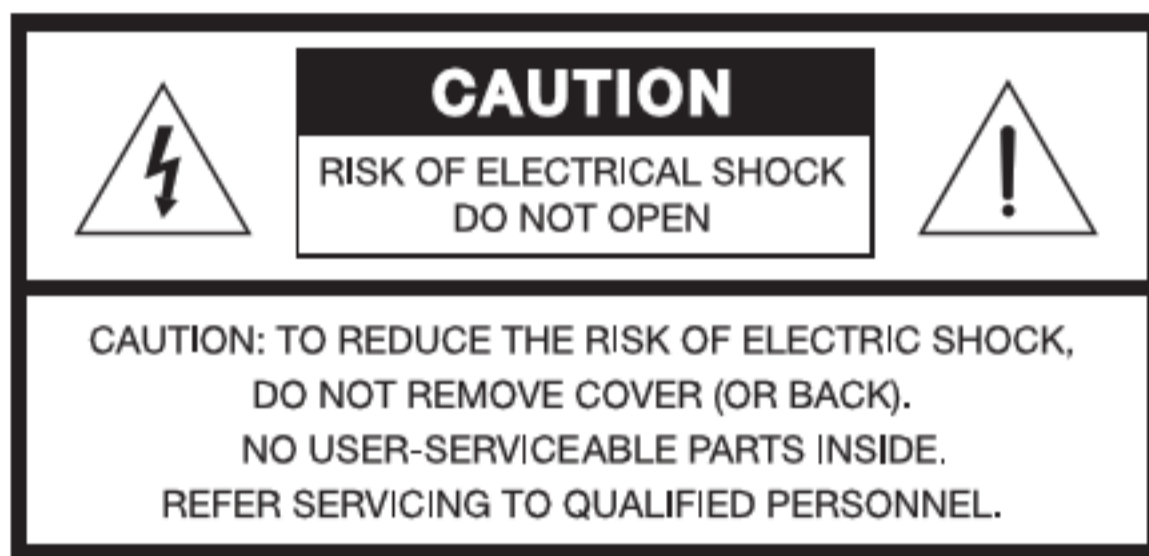

The lightning flash with arrowhead symbol within an equilateral triangle alerts the user to the presence of uninsulated, dangerous voltage within the system enclosure that may be of sufficient magnitude to constitute a risk of electric shock.



The exclamation point within an equilateral triangle, as marked on the system, is intended to alert the user to the presence of important operating and maintenance instructions in this owner's guide.



## WARNINGS:

- To reduce the risk of fire or electrical shock, do not expose the product to rain or moisture.
  - Do not expose this apparatus to dripping or splashing, and do not place objects filled with liquids, such as vases, on or near the apparatus. As with any electronic products, use care not to spill liquids into any part of the system. Liquids can cause a failure and/or a fire hazard.
  - Do not place any naked flame sources, such as lighted candles, on or near the apparatus.
  - The battery pack shall not be exposed to excessive heat such as sunshine, fire or the like.
  - Do not dismantle, open or shred battery pack.
  - Do not short-circuit the battery or battery pack. Do not store the battery pack haphazardly in a box or drawer where it may short-circuit by other metal objects.
  - Do not subject battery pack to mechanical shock.
  - In the event of a battery pack leaking, do not allow the liquid to come in contact with the skin or eyes. If contact has been made, wash the affected area with copious amounts of water and seek medical advice.
- 

©2013 Bose Corporation. No part of this work may be reproduced, modified, distributed, or otherwise used without written permission.

## Safety Information

---



### WARNINGS

- Do not use any charger other than that specifically provided for use with the equipment.
  - Do not use any battery pack which is not designed for use with the equipment.
  - Keep battery pack out of the reach of children.
  - Replace the battery pack only with a genuine replacement battery pack from Bose or an authorized Bose dealer. Bose cannot warrant the safety and compatibility or assure the operability of batteries from other manufacturers for use in operating this product. Keep battery pack clean and dry.
  - The battery needs to be charged before use. Always use the correct charger and refer to the manufacturer's instructions or equipment manual for proper charging instructions.
  - After extended periods of storage, it may be necessary to charge and discharge the battery pack several times to obtain maximum performance.
  - The battery pack gives its best performance when it is operated at normal room temperature (20°C +/- 5°C).
  - Use only the battery in the application for which it was intended.
- 



**WARNING:** This product contains magnets which can be harmful to pacemaker wearers.

---



**CAUTION:** Make no modifications to the system or accessories. Unauthorized alterations may compromise safety, regulatory compliance, and system performance.

---



- Please dispose of used batteries properly, following any local regulations. Do not incinerate.

### NOTES:

- The product label is located on the inside of the battery cover on the bottom of the product.
- Where the mains plug or appliance coupler is used as the disconnect device, such disconnect device shall remain readily operable.
- The power supply provided with this product must be used indoors. It is neither designed nor tested for use outdoors, in recreation vehicles, or on boats.
- This product is intended to be used only with the power supply provided, or Bose® power supply or charger designed for use with this product.

# Safety Information

---

## Important Safety Instructions

1. Read these instructions.
2. Keep these instructions.
3. Heed all warnings.
4. Follow all instructions.
5. Do not use this apparatus near water.
6. Clean only with a dry cloth.
7. Do not block any ventilation openings. Install in accordance with the manufacturer's instructions.
8. Do not install near any heat sources such as radiators, heat registers, stoves, or other apparatus (including amplifiers) that produce heat.
9. Only use attachments/accessories specified by the manufacturer.
10. Unplug this apparatus during lightning storms or when unused for long periods of time.
11. Refer all servicing to qualified personnel. Servicing is required when the apparatus has been damaged in any way, such as power-supply cord or plug is damaged, liquid has been spilled or objects have fallen into the apparatus, the apparatus has been exposed to rain or moisture, does not operate normally, or has been dropped.

4 - English

## Information about products that generate electrical noise

This device complies with FCC and Industry Canada RF radiation exposure limits set forth for general population. It must not be co-located or operating in conjunction with any other antennas or transmitters.

This device complies with Part 15 of the FCC Rules. Operation is subject to the following two conditions: (1) This device may not cause harmful interference, and (2) this device must accept any interference received, including interference that may cause undesired operation.

### U.S.A. only

NOTE: This equipment has been tested and found to comply with the limits for a Class B digital device, pursuant to Part 15 of the FCC Rules. These limits are designed to provide reasonable protection against harmful interference in a residential installation. This equipment generates, uses, and can radiate radio frequency energy and, if not installed and used in accordance with the instructions, may cause harmful interference to radio communications. However, there is no guarantee that interference will not occur in a particular installation. If this equipment does cause harmful interference to radio or television reception, which can be determined by turning the equipment off and on, the user is encouraged to try to correct the interference by one or more of the following measures:

## Safety Information

- Reorient or relocate the receiving antenna.
- Increase the separation between the equipment and receiver.
- Connect the equipment into an outlet on a circuit different from that to which the receiver is connected.
- Consult the dealer or an experienced radio/TV technician for help.
- Changes or modifications not expressly approved by Bose Corporation could void the user's authority to operate this equipment.

### Canada

This Class B digital apparatus complies with Canadian ICES-003.

This device complies with Industry Canada licence-exempt RSS standard(s). Operation is subject to the following two conditions: (1) This device may not cause interference, and (2) this device must accept any interference, including interference that may cause undesired operation of the device.

Output power: 4 mW @ 2400 MHz



This product conforms to all applicable EU directive requirements. The complete Declaration of Conformity can be found at [www.Bose.com/compliance](http://www.Bose.com/compliance).

Per EN300220-1 this product contains a category 3 receiver.

Names and Contents of Toxic or Hazardous Substances or Elements						
Part Name	Toxic or Hazardous Substances and Elements					
	Lead (Pb)	Mercury (Hg)	Cadmium (Cd)	Hexavalent (CR(VI))	Polybrominated Biphenyl (PBB)	Polybrominated Diphenyl Ether (PBDE)
PCBs	X	0	0	0	0	0
Metal parts	X	0	0	0	0	0
Plastic parts	0	0	0	0	0	0
Speakers	X	0	0	0	0	0
Cables	X	0	0	0	0	0

O: Indicates that this toxic or hazardous substance contained in all of the homogeneous materials for this part is below the limit requirement in SJ/T 11363-2006.

X: Indicates that this toxic or hazardous substance contained in at least one of the homogeneous materials used for this part is above the limit requirement in SJ/T 11363-2006.

## Safety Information

---

**Please complete and retain for your records:**

The serial number is located on the rubber foot at the bottom of the speaker. The model number is located on the inside surface of the rubber foot (pull the rubber foot away from the speaker to read the model number).

Serial number (on bottom of speaker) \_\_\_\_\_

Model number (inside rubber base of speaker) \_\_\_\_\_

Purchase date \_\_\_\_\_

We suggest you keep your receipt with this owner's guide.

# Contents

---

## Introduction

Overview.....	8
Unpacking.....	8

## Setup

Connecting to AC power.....	10
Connect to AC power via the charging cradle.....	10
Connect to AC power via the speaker.....	12
Pairing a device to the speaker.....	13

## Operation

Connecting a paired device.....	15
Speaker memory.....	15
Clearing memory.....	15
Control buttons.....	16
System status indicators.....	17

Using the AUX connector.....	18
Operating on battery power.....	20
Checking the battery.....	20
Battery protection mode.....	20
Charging the battery.....	20
Tips on placing the speaker.....	21

## Maintenance and Care

Troubleshooting.....	23
Replacing the battery.....	28
Cleaning.....	28
Contacting customer service.....	28
Limited warranty.....	29
Technical information.....	29

# Introduction

---

## Overview

---

Thank you for purchasing the Bose® SoundLink® Mini *Bluetooth*® speaker. Enjoy music wirelessly from your smartphone, tablet, laptop, or other *Bluetooth*® device anywhere you choose.

### Features

- Wireless *Bluetooth* link eliminates the need to physically connect your *Bluetooth* capable audio source.
- Rechargeable lithium-ion battery provides hours of Bose® performance.
- AUX connector lets you connect your *Bluetooth* device or other music source device directly to your speaker.
- Pair up to six *Bluetooth* devices.
- Easy grab-and-go mobility.

## Unpacking

---

Check the carton for the Bose® SoundLink® Mini speaker, power supply, and charging cradle. Be sure to save all of the packing materials. These provide the safest means for any necessary shipping or transporting.

If any part of the product appears to be damaged, do not attempt to use it. Contact your authorized Bose dealer immediately or call Bose Customer Service. For contact information, refer to the contact list at the end of this guide.



# Introduction

---

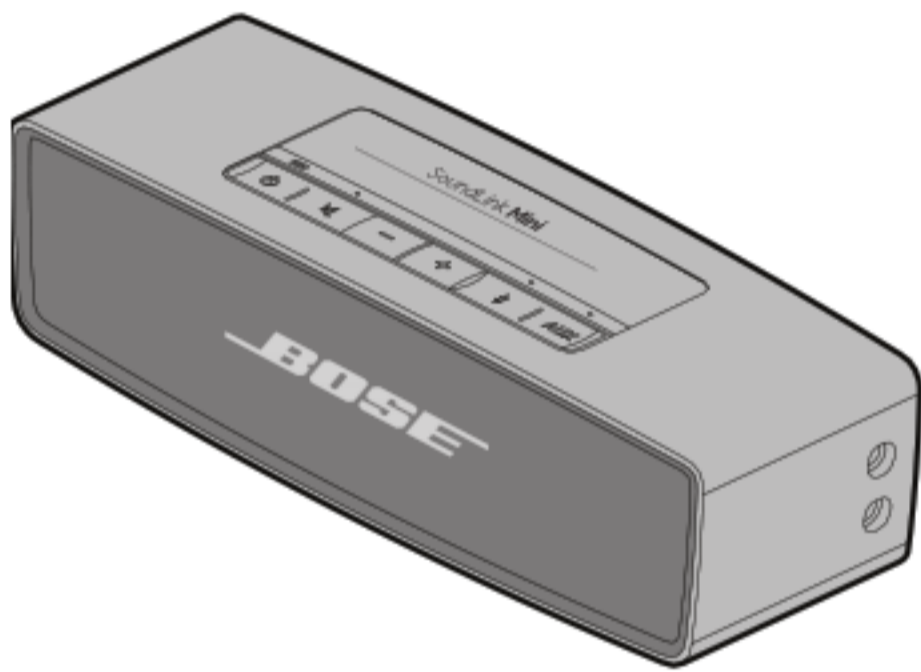

Soundlink® Bluetooth® Mini speaker



AC power supply

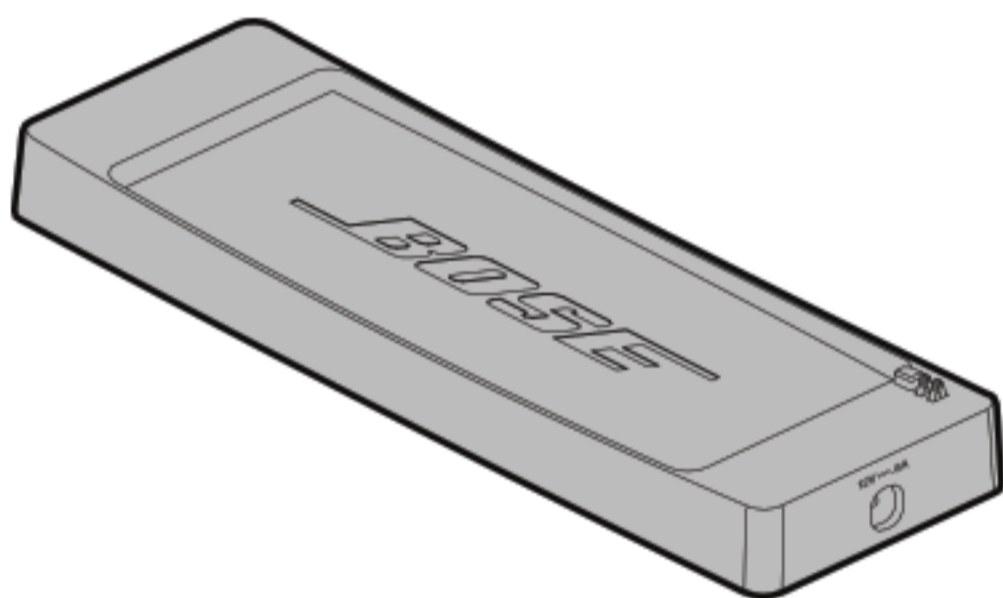

Charging Cradle



Adapters

# Setup

---

## Connecting to AC power

---

Before using your Bose® SoundLink® Mini speaker the first time, connect it to AC (mains) power and charge the battery. You can connect the power supply cord into the charging cradle, or directly into the speaker. While the battery is charging, you can begin using the speaker.

### Connect to AC power via the charging cradle

The charging cradle provides a home base for your Bose® SoundLink® Mini speaker. You can connect to AC power through the charging cradle and, with the speaker placed on the charging cradle, charge the battery.

1. Extend the power supply prongs.
2. If needed, snap on the adapter for your region (2a). To remove an adapter, press back on the release and lift the adapter up and off (2b).

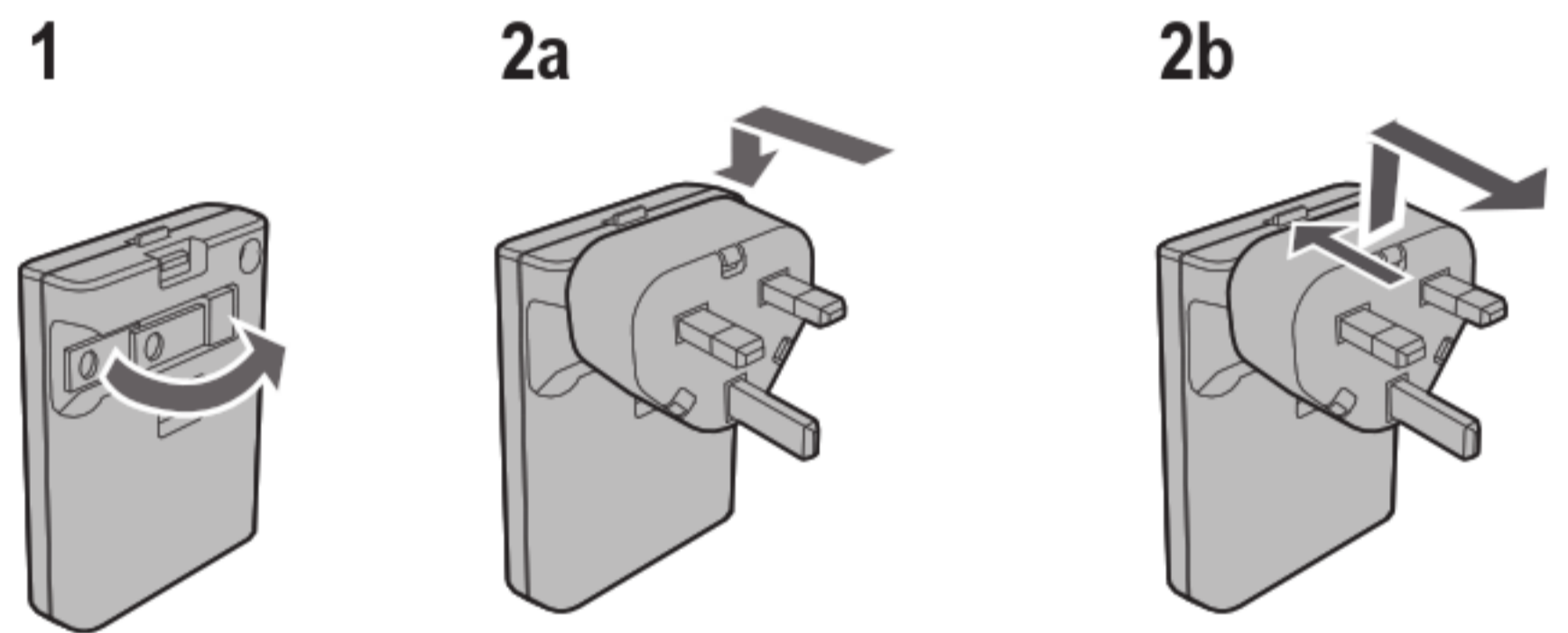

## Setup

3. Plug the DC power cord on the power supply into the DC connector on the charging cradle.

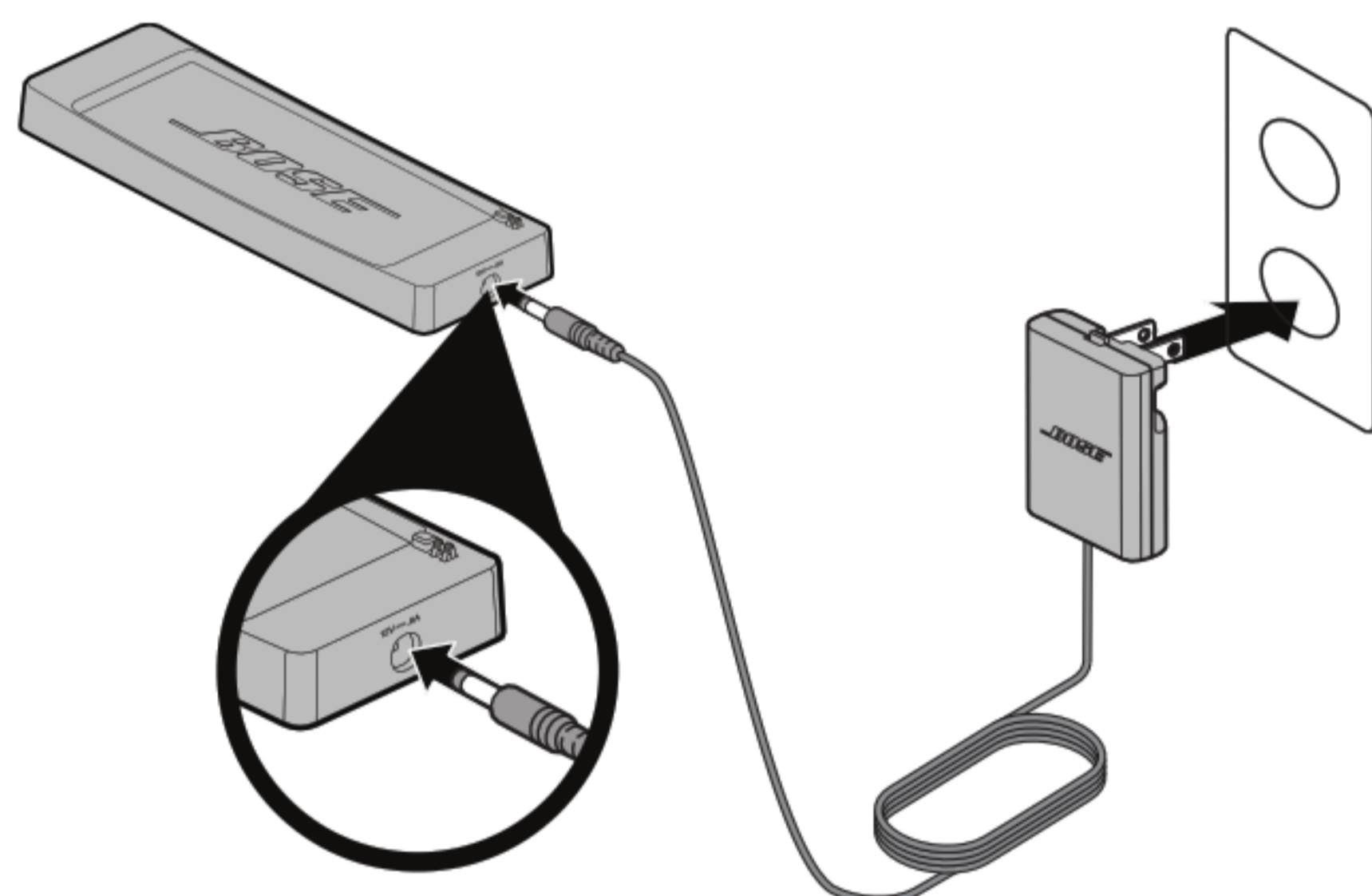

4. Place the speaker on top of the cradle, so the pin connectors line up.

**Important! Do not force the speaker into the cradle.**

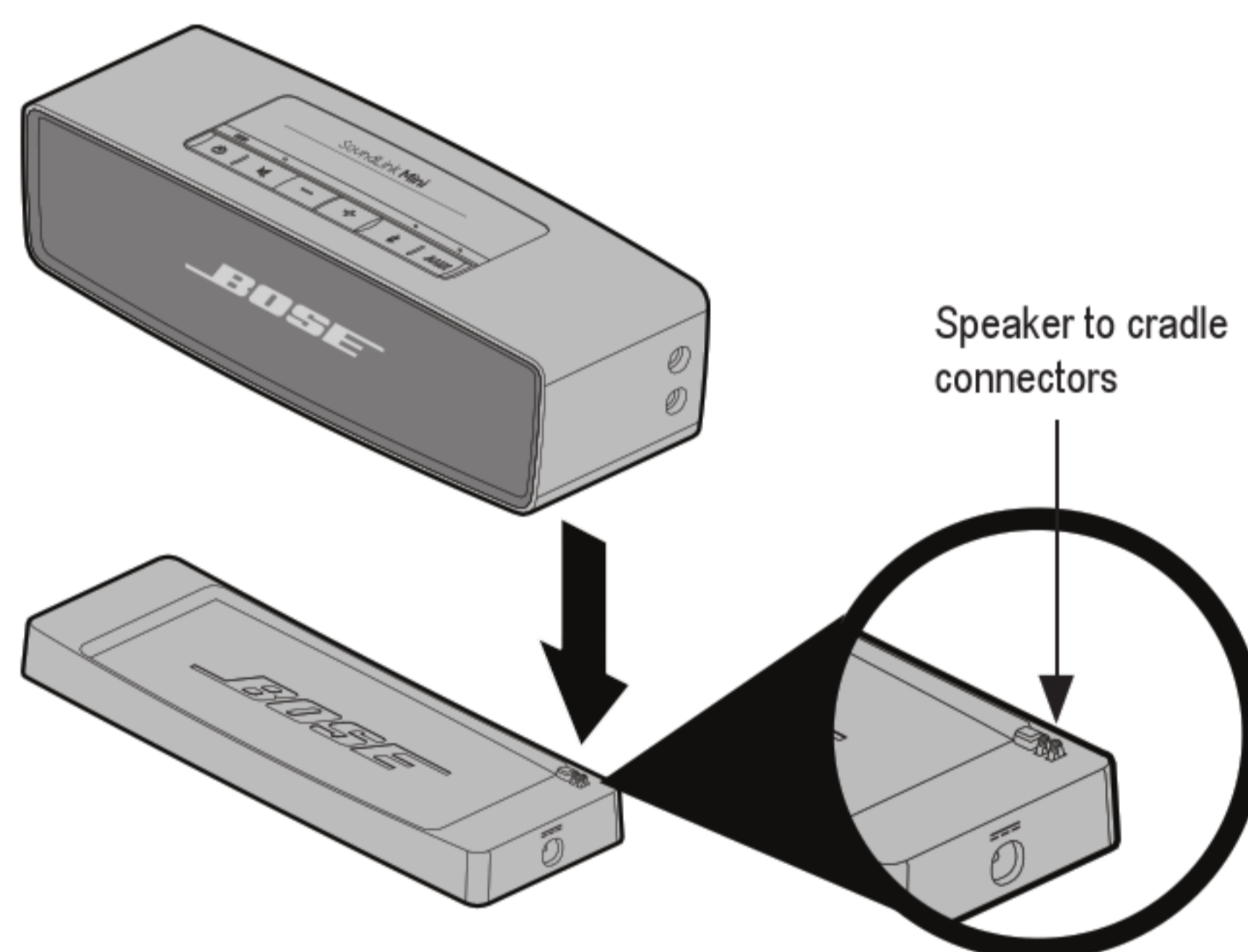

## Setup

---

5. Plug the power supply into a live AC (mains) outlet.
  - The speaker emits a tone to confirm connection to AC power, and charging begins. A blinking yellow battery icon  indicates the battery is charging.
  - Once connected to AC power, your Bose® SoundLink® Mini speaker is ready for use.

### Connect to AC power via the speaker

You can connect to AC power by connecting the DC power cord directly into the speaker.

1. Follow steps 1 and 2 from “Connecting to AC power” on page 10.

2. Plug the DC power cord on the power supply into the DC connector on the Bose® SoundLink® Mini speaker.

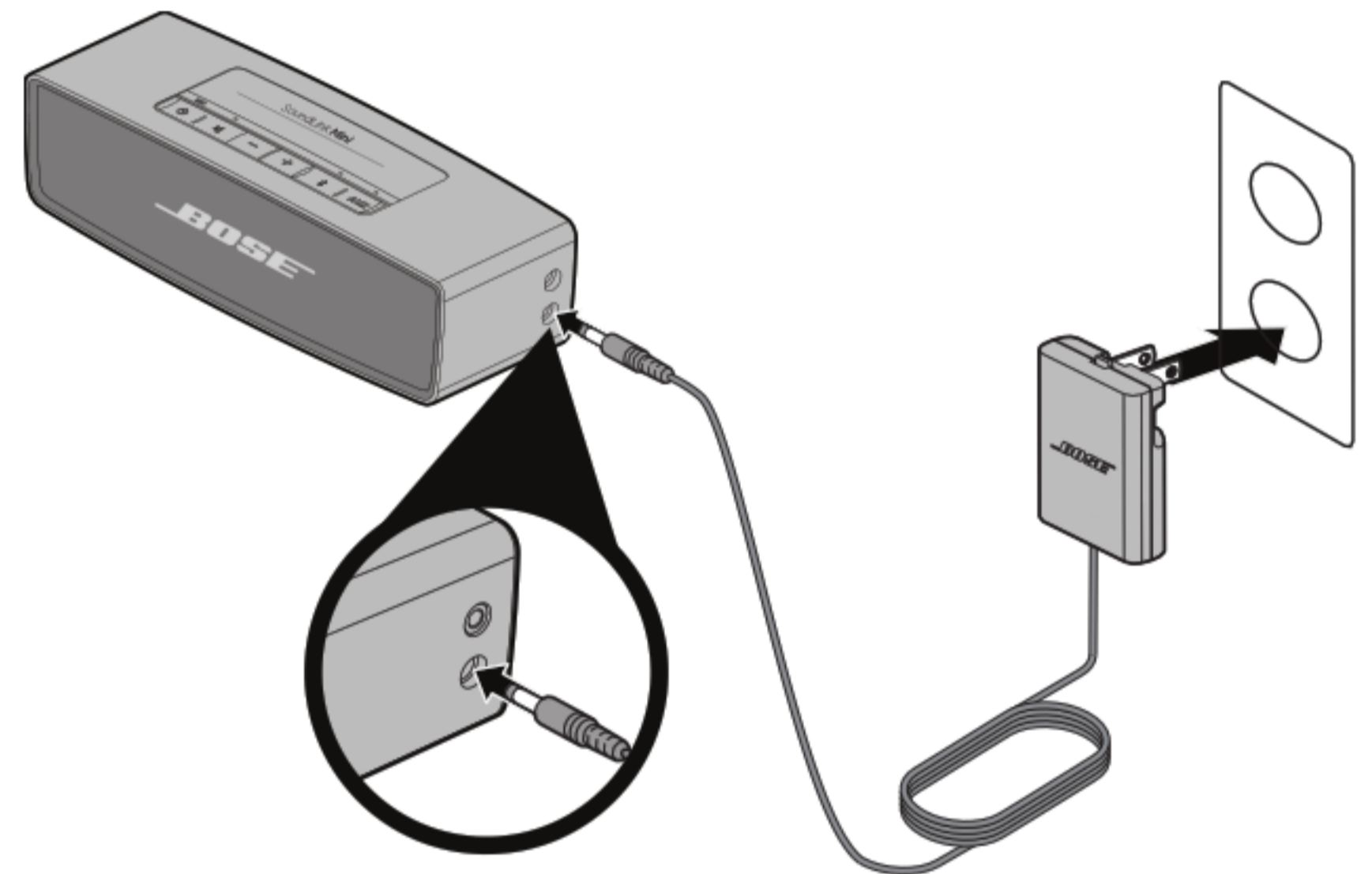

3. Follow step 5 from “Connecting to AC power” on page 10.

---

### Pairing a device to the speaker

---

#### To pair with a *Bluetooth* device:

1. With your *Bluetooth* device and the Bose® SoundLink® Mini speaker both turned on, press the *Bluetooth button*  on the speaker to make the speaker discoverable.  
  
The *Bluetooth* indicator on the Bose® SoundLink® Mini speaker blinks blue to show that the speaker is discoverable.
2. Set your *Bluetooth* device to discoverable so it can discover (detect) the Bose® SoundLink® Mini speaker. Locate the *Bluetooth* device list in the user interface of your device.
3. From the *Bluetooth* device list, select the device named “Bose Mini SoundLink.”



4. If your *Bluetooth* device prompts you for a passcode, enter digits 0000 (four zeros) and press **OK**. Some devices also ask you to accept the connection.

Your *Bluetooth* device indicates when pairing is complete.

The Bose® SoundLink® Mini speaker indicates pairing is complete when the *Bluetooth* indicator changes from blinking blue to solid white and the speaker emits a tone.

## Setup

---

**Note:** If you are unable to pair your device, reset the speaker by pressing and holding Mute  on the speaker for 10 seconds until the indicators briefly flash. Your Bluetooth device is disconnected and the Soundlink® Mini speaker turns off. Press Power  to turn the Bose® SoundLink® Mini speaker on again and reconnect.

**Note:** If the speaker turns off after five minutes, it has not discovered your Bluetooth device.

### To pair additional devices:

You can pair up to six devices. With your *Bluetooth* device and the Bose® SoundLink® Mini speaker both turned on, press the *Bluetooth* button  on the speaker to make the speaker discoverable again. Follow steps 2–4 from “Pairing a device to the speaker” on page 13.

### Connecting a paired device

---

To connect a previously paired device, turn on the device and press *Bluetooth*  on the Bose® SoundLink® Mini speaker. Until the device connects, the *Bluetooth* indicator on the speaker blinks white. When the speaker and *Bluetooth* device have successfully connected, the *Bluetooth* indicator remains on.

**Note:** If the speaker is in discoverable mode (blinking blue), and you want to go back into connecting mode, press the Bluetooth button. The indicator blinks white and the Bose® SoundLink® Mini speaker goes into connecting mode.

### Speaker memory

---

The Bose® SoundLink® Mini speaker memory can hold up to six paired devices. When the memory is full with six devices and an additional device is paired, the least recently used device is deleted from memory and replaced by the newly paired device.

#### Clearing memory

To clear the Bose® SoundLink® Mini speaker memory of all devices, press and hold the *Bluetooth* button  on the speaker (about 10 seconds) until you hear a tone.

All *Bluetooth* devices are cleared from the Bose® SoundLink® Mini speaker, and the Bose® SoundLink® Mini speaker becomes discoverable.

# Operation



---

## Control buttons

---

The control buttons are located on the top of the speaker.



-  • Press to turn the speaker on or off.
-  • Press and hold to check the battery charge state. See “Checking the battery” on page 20.

-  • Press to mute/unmute sound from the speaker.

-  • Minus (-) decreases speaker volume. Press and hold the button to continuously decrease the volume.

-  • Plus (+) increases speaker volume. Press and hold the button to continuously increase the volume.

The source indicator blinks as the volume increases or decreases. When the source indicator blinks twice, the maximum or minimum volume has been reached.



## Operation



- Press to select the *Bluetooth* source. The speaker attempts to connect to the last paired device. If there are no paired devices, the speaker goes into discoverable mode. See “Pairing a device to the speaker” on page 13.
- Once *Bluetooth* is selected, press again to set the speaker to discoverable mode and allow pairing with another *Bluetooth* device. Press again to go back to connecting mode.
- While the *Bluetooth* source is selected, and no device connects within five minutes, the speaker turns itself off.



- Press to select the source connected to the AUX (→) input. See “Using the AUX connector” on page 18.

### System status indicators

The status indicators, located above the buttons on the top of the Bose® SoundLink® Mini speaker, illuminate to indicate when a source is activated.

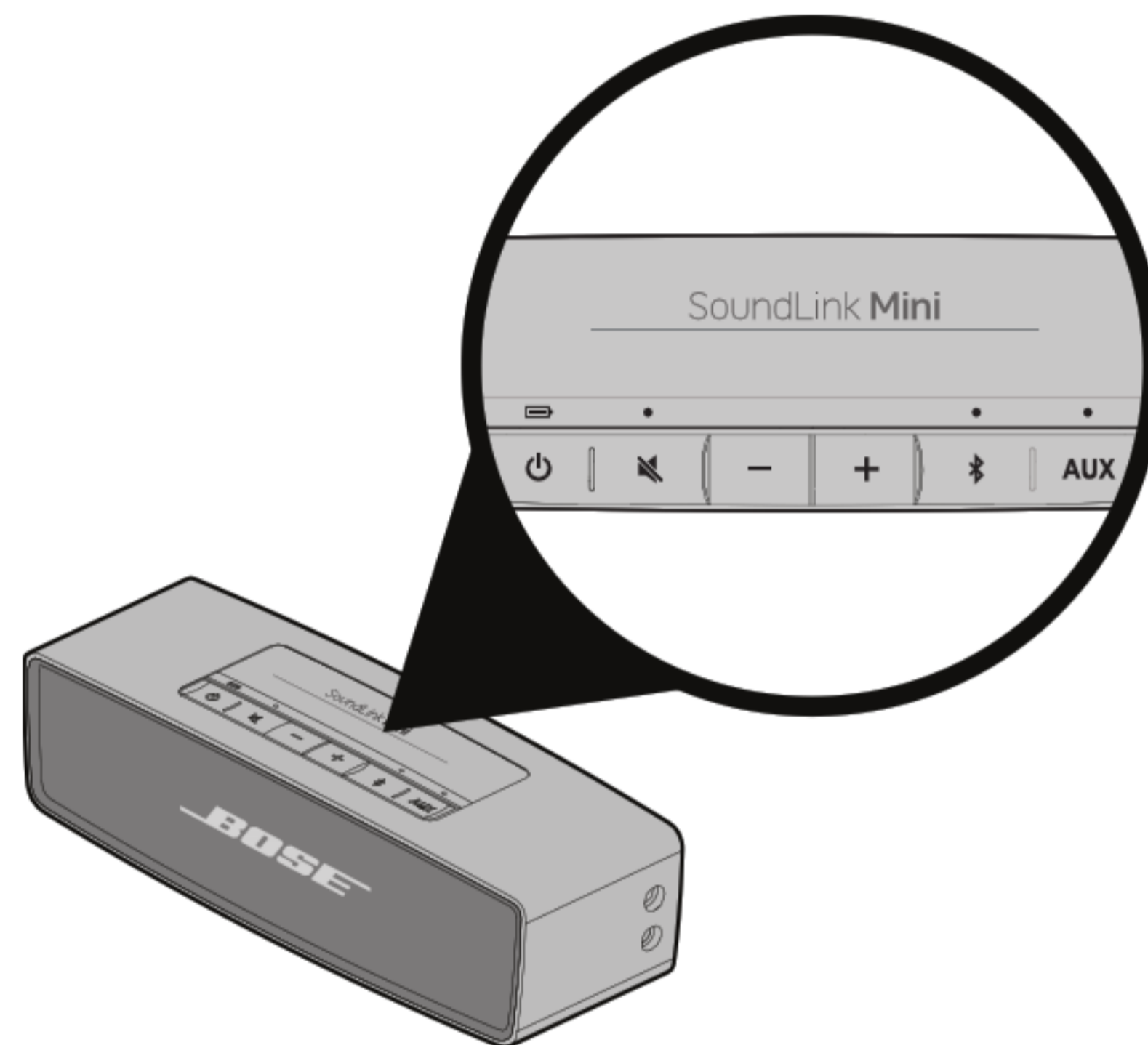

## Operation

---



Indicates the battery power level, or the charging state. See “Checking the battery” on page 20.



The indicator blinks to indicate that the sound is muted.



Indicates the speaker state when the *Bluetooth* source is selected:



- **Blinking blue light** – Discoverable and ready to pair or reconnect with a device.
- **Blinking white light** – Attempting to connect to a paired device.
- **Solid white light** – Connected to a paired device.

See “Pairing a device to the speaker” on page 13.



The speaker is playing the source connected to the AUX (→) input.

AUX

## Using the AUX connector

---

You can use your Bose® SoundLink® Mini speaker with any device that features headphone or audio output, such as a portable digital music player. This feature requires using a stereo audio cable with a 3.5 mm plug on each end to connect the audio output of your device to the AUX input on the speaker. This type of cable is available for purchase at electronics stores.

## Operation

### To use the AUX connector:

1. Plug the cable from the audio device into the  (AUX) connector on the side of the Bose® SoundLink® Mini speaker.

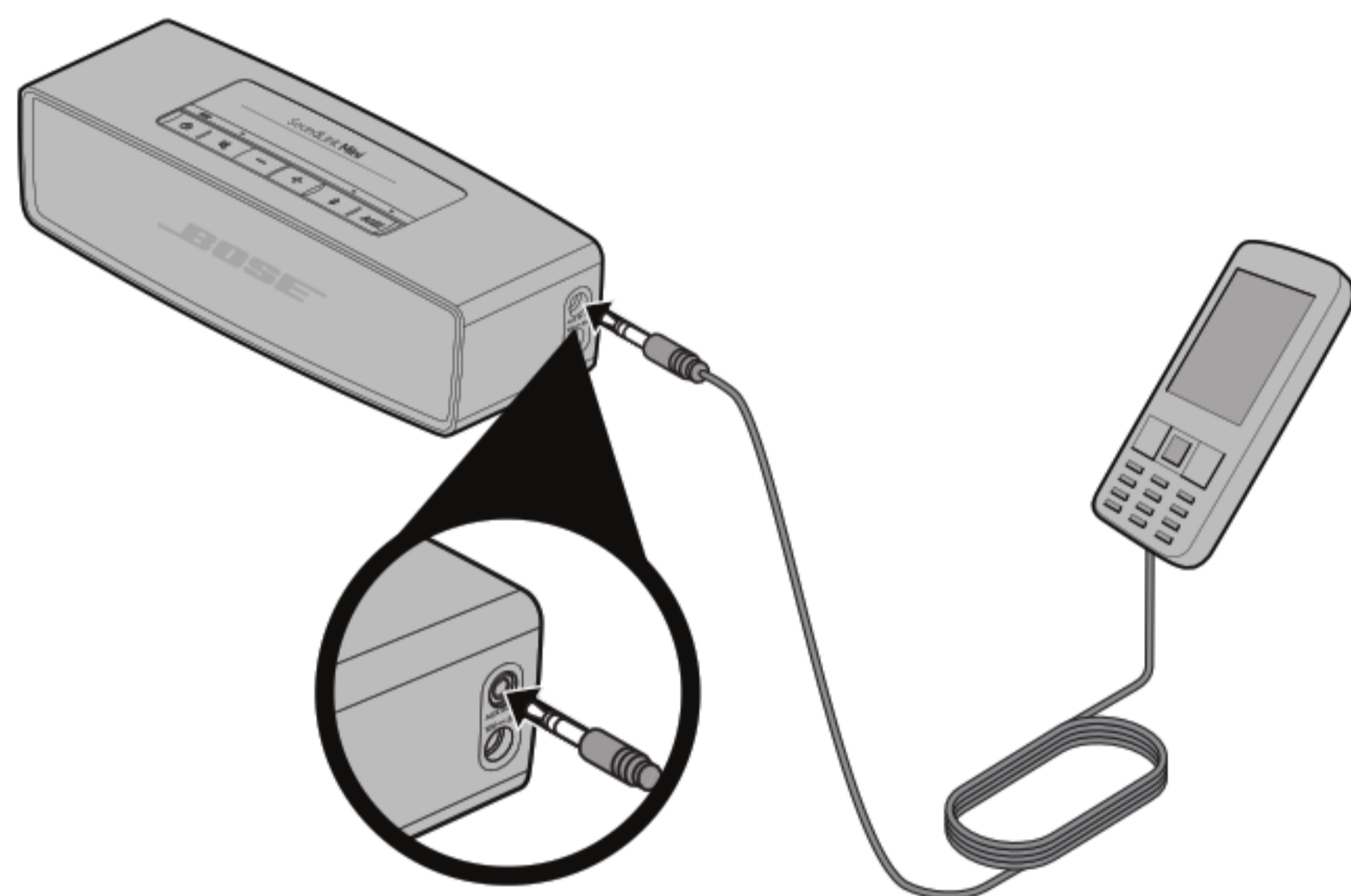

2. Press Power  on the Bose® SoundLink® Mini speaker.
3. Press **AUX** on the Bose® SoundLink® Mini speaker.
4. Adjust the volume on the connected device to *near* maximum, then use the Bose® SoundLink® Mini speaker volume buttons to adjust the volume level.

**Note:** If a connected device stops playing audio for 30 minutes, the speaker automatically turns off to conserve battery power.

**Note:** The connector on the bottom of the speaker is for service only and does not play audio from any connected device.

# Operation

---

## Operating on battery power

---

Battery performance varies with the content played and loudness at which it is played. In typical usage, the Bose® SoundLink® Mini speaker battery lasts up to 12 hours.

### Checking the battery

When the speaker is turned on, the battery indicator turns on for ten seconds, then turns off to conserve battery power. To check the battery charge level, press and hold Power  on the speaker and observe the battery indicator.

-  Green: ..... 70% or more of full charge
- Yellow: ..... 20% to 70% of full charge
- Red: ..... less than 20% (charge is needed)

### Battery protection mode

When the Bose® SoundLink® Mini speaker is unplugged and unused for more than 24 days, it enters battery protection mode to preserve battery power. To reactivate the speaker, connect it to AC power (see “Connecting to AC power” on page 10).

### Charging the battery

The battery status indicator on the Bose® SoundLink® Mini speaker blinks red when the battery needs charging. You can use the speaker while charging the battery.

## Operation

---

To charge the battery, connect the speaker to AC power. See “Connecting to AC power” on page 10. The speaker emits a tone to confirm the power connection. Recommended charging time is three hours to fully charge the battery. The battery status indicator indicates charging status.

 Blinking yellow: ..... Battery is charging  
Solid green: ..... Charging cycle is done

**Note:** When the battery status indicator blinks red, storing the speaker for extended periods of time may put the speaker into battery protection mode.

### Tips on placing the speaker

---

When using your Bose® SoundLink® Mini speaker indoors, the tonal quality can vary depending on where the speaker is placed in a room.

When using your speaker outdoors, you should expect the tonal quality to change as you move farther away from the speaker.

Keep the following guidelines in mind when placing your speaker:

- For optimal sound, the front of the speaker, which has the Bose® logo on the grille, should face the user.

## Operation

---

- For best bass response, the back of the speaker should be placed near a wall, but not directly against a wall. Bass response decreases as the speaker is moved away from a wall. Do not lay the speaker on its back. Sound is emitted from both the front and rear of the unit.
- Do not place the speaker in small areas that are enclosed on all sides except the front, as this will adversely affect sound quality.
- Do not place the speaker on wet or dirty surfaces.
- Place the speaker only on its rubber base. Standing the speaker on any side other than its rubber base can cause damage to the speaker and adversely affect sound quality.



## Maintenance and Care

### Troubleshooting

Problem	What to do
Speaker will not turn on (AC power)	<ul style="list-style-type: none"><li>• Make sure your system is connected to a working AC (mains) outlet.</li><li>• Make sure you are using the Bose power supply that shipped with your speaker, or a Bose accessory charger designed for the Soundlink® mini speaker.</li><li>• Make sure you are using the Bose power supply that shipped with your speaker, or a Bose accessory charger designed for the Soundlink® mini speaker.</li></ul>
Speaker will not turn on (battery power)	<ul style="list-style-type: none"><li>• Battery may be in protection mode or discharged. Connect to working AC outlet to restore the battery to operational mode.</li></ul>
Paired <i>Bluetooth</i> device will not connect to the speaker	<ul style="list-style-type: none"><li>• If your device requires a passcode, make sure the one you entered is correct.</li><li>• Make sure <i>Bluetooth</i> functionality is turned on or enabled on your source device.</li><li>• Your <i>Bluetooth</i> device may be out of range—try moving it closer to the speaker.</li><li>• If possible, turn off all other nearby <i>Bluetooth</i> devices or disable their <i>Bluetooth</i> functionality.</li><li>• Reset the speaker. Press the Mute button for ten seconds, until the indicators briefly flash. Your <i>Bluetooth</i> device is disconnected and the SoundLink® Mini speaker turns off. Press the Power button to turn the speaker back on, and reconnect.</li><li>• Clear the speaker memory (see “Clearing memory” on page 15). Pair the <i>Bluetooth</i> device and the speaker again.</li><li>• Turn the power off and back on, and reconnect.</li></ul>

## Maintenance and Care

---

Problem	What to do
The speaker indicates a connection, but is not playing music	<ul style="list-style-type: none"><li>• Make sure your device is connected to the speaker.</li><li>• Make sure the transport controls of the audio device are set to playback audio.</li><li>• Make sure the speaker is not muted and the speaker volume is up.</li><li>• Make sure your <i>Bluetooth</i> device is playing audio, and the device volume is up.</li><li>• Turn off or disable <i>Bluetooth</i> functionality on all other paired devices nearby (including Bose® preferred devices) and reconnect the device you want to hear.</li><li>• Turn the speaker off and back on.</li></ul>
No audio from a <i>Bluetooth</i> device	<ul style="list-style-type: none"><li>• Make sure your device is connected to the speaker.</li><li>• Make sure the speaker is not muted and the speaker volume is up.</li><li>• Make sure your <i>Bluetooth</i> device is playing audio, and the device volume is up.</li><li>• Your <i>Bluetooth</i> device may be out of range—try moving it closer to the speaker.</li><li>• Move your <i>Bluetooth</i> device and/or the speaker is set away from other devices that generate electromagnetic interference. Examples are cordless phones, microwave ovens, wireless network routers, or other <i>Bluetooth</i> devices.</li><li>• If possible, turn off all other nearby <i>Bluetooth</i> devices or disable their <i>Bluetooth</i> functionality.</li><li>• Refer to the owner's guide, help system, or technical support for your <i>Bluetooth</i> device to learn how it pairs with other <i>Bluetooth</i> devices.</li><li>• Turn the speaker off and back on.</li></ul>



## Maintenance and Care

Problem	What to do
Cannot pair the speaker with my <i>Bluetooth</i> device	<ul style="list-style-type: none"><li>• Make sure your speaker is discoverable. Press the <i>Bluetooth</i> button until the <i>Bluetooth</i> indicator slowly blinks blue.</li><li>• Make sure the <i>Bluetooth</i> capability of your <i>Bluetooth</i> device is turned on.</li><li>• Make sure you select “Bose Mini SoundLink” in the pairing list on your device and that connection is confirmed by your device.</li><li>• Your <i>Bluetooth</i> device may be out of range—try moving it closer to the speaker.</li><li>• If possible, turn off all other nearby <i>Bluetooth</i> devices or disable their <i>Bluetooth</i> functionality.</li><li>• Refer to the owner’s guide, help system, or technical support for your <i>Bluetooth</i> device to learn how it pairs with other <i>Bluetooth</i> devices.</li><li>• Make sure your <i>Bluetooth</i> device supports the A2DP (stereo <i>Bluetooth</i>) profile.</li><li>• When connecting to a PC or Mac computer, make sure that you select the Bose® SoundLink® Mini speaker as the audio output device within the audio settings menu of the device. You may need to play an audio track to finalize the connection (see the device manufacturer for detailed instructions).</li><li>• Reset the speaker: Press the Mute button for ten seconds. Your <i>Bluetooth</i> device is disconnected and the Bose® SoundLink® Mini speaker turns off. Press the Power button to turn the speaker back on, and reconnect.</li><li>• Check for updated software for your <i>Bluetooth</i> device, or go to <a href="http://owners.Bose.com">owners.Bose.com</a> for updates to the Bose® SoundLink® Mini speaker.</li></ul>
Poor sound quality from an AUX device	<ul style="list-style-type: none"><li>• Reduce the volume level on the AUX device.</li><li>• Make sure the 3.5 mm plug is fully inserted into the speaker.</li></ul>

## Maintenance and Care

---

Problem	What to do
Poor sound quality from a <i>Bluetooth</i> device	<ul style="list-style-type: none"><li>• Try connecting your <i>Bluetooth</i> device to the speaker using the AUX connection. If sound quality improves using the AUX connection, try the following solutions.</li><li>• Your <i>Bluetooth</i> device may be out of range—try moving it closer to the Bose® SoundLink® Mini speaker.</li><li>• Move your <i>Bluetooth</i> device away from any device that generates electromagnetic interference, such as another <i>Bluetooth</i> enabled device, cordless phone, microwave oven, or wireless router.</li><li>• Reduce the number of applications running on your <i>Bluetooth</i> device. Running multiple applications can reduce the amount of internal resources available to transmit audio. Closing non-essential applications may improve audio quality.</li><li>• Try turning off Wi-Fi® to improve audio quality.</li><li>• Try clearing your <i>Bluetooth</i> device from the Bose® SoundLink® Mini speaker by disabling <i>Bluetooth</i> on your device. Pair the device and speaker again.</li><li>• Turn the speaker off and back on.</li><li>• If your <i>Bluetooth</i> device is in your pocket, try placing it in open air, without your body between the device and the Bose® SoundLink® Mini speaker.</li><li>• Reset the speaker: (1) Press the Mute button for 10 seconds. Your <i>Bluetooth</i> device disconnects and the speaker turns off. (2) Press the Power button to turn the speaker back on.</li><li>• Try connecting your <i>Bluetooth</i> device to the speaker using the AUX connection to verify that the poor sound quality is <i>Bluetooth</i> related.</li><li>• Check for updated software for your <i>Bluetooth</i> device, or go to <a href="http://owners.Bose.com">owners.Bose.com</a> for updates to the Bose® SoundLink® Mini speaker.</li><li>• Apple device users may need to adjust the default bitpool setting for <i>Bluetooth</i> audio to improve signal quality. Please visit <a href="http://owners.Bose.com">owners.Bose.com</a> for detailed instructions.</li></ul>

## Maintenance and Care

---

Problem	What to do
No audio from the AUX source	<ul style="list-style-type: none"><li>• Make sure your connected device is on and playing.</li><li>• Press the AUX button and check that the AUX source indicator is on.</li><li>• Make sure the 3.5 mm plug is fully inserted into the speaker, and fully inserted into the source device.</li><li>• Make sure the speaker is not muted and the speaker volume is up.</li><li>• Increase the volume level on the AUX device.</li><li>• Increase the speaker volume.</li><li>• Try using a different AUX cable.</li></ul>

## Maintenance and Care

---

### Replacing the battery

---

The battery should be replaced when:

- The battery status indicator remains yellow after ten hours of charging.
- The period of battery operation noticeably decreases.
- Only use Bose authorized batteries.

For replacement batteries, contact Bose® in your country/region (visit <http://global.Bose.com> for Bose contact information in your country or region).

### Cleaning

---

To clean the exterior surface of your product, you can wipe it using a soft, dry cloth.

- Do not use solvents, chemicals, or sprays.
- Do not allow liquids to spill or objects to drop into any openings.

### Contacting customer service

---

For questions about the Bose® SoundLink® Mini speaker, contact your local Bose dealer. To contact Bose directly, see the contact list at the end of this guide, or visit [owners.Bose.com](http://owners.Bose.com).

## Maintenance and Care

---

### Limited warranty

---

Your Bose® SoundLink® Mini speaker is covered by a limited warranty. Details of the limited warranty are provided on the product registration card that is included in the carton. Please refer to the card for instructions on how to register. Failure to register will not affect your limited warranty rights.

### Technical information

---

#### Power supply rating

Input: 100 - 240V $\sim$ , 50/60Hz, 360mA  
Output: 12VDC, 0.833A Max

#### Input power rating

Input: 12VDC, 0.833A Max

#### Dimensions

2.0" H x 7.1" W x 2.3" D  
(5.08 cm x 18.03 cm x 5.84 cm)

#### Weight

1.44 lb. (0.655 kg)

#### Temperature range for use

0° - 45°C (32° - 131°F)

The *Bluetooth*® word mark and logos are registered trademarks owned by Bluetooth SIG, Inc. and any use of such marks by Bose Corporation is under license.

Wi-Fi is a registered mark of the Wi-Fi Alliance.

# Bose Corporation

---

## USA

Bose Corporation, The Mountain  
Framingham, MA 01701-9168  
1-800-901-0472  
Phone hours - ET (Eastern Time):  
Weekdays 8:30 a.m. to 8 p.m.  
Saturdays 9 a.m. to 3 p.m.  
[owners.Bose.com](http://owners.Bose.com)

## Canada

Bose Limited  
280 Hillmount Road, Unit 5  
Markham, Ontario  
Canada L6C 3A1  
1-800-465-2673  
Phone hours - ET (Eastern Time):  
Weekdays 9 a.m. to 5 p.m.  
[www.Bose.ca](http://www.Bose.ca)

## Australia

Bose Pty Limited, Unit 3/2 Holker Street  
Newington NSW 2127  
TEL 1 800 061 046 (AU)  
TEL 008 501 511 (NZ)  
FAX 612 8737 9924  
[www.Bose.com.au](http://www.Bose.com.au)  
[www.Bose.com.nz](http://www.Bose.com.nz)

## Belgique/België

Bose N.V., Limesweg 2  
B-3700 Tongeren  
TEL 012-259960  
FAX 012-390840  
[www.Bosebelgium.be](http://www.Bosebelgium.be)

## China

Bose Greater China Operations  
1st Floor, EYON Building, No. 118  
East Dong Baoxing Road  
Shanghai 200080 P.R.C.  
People's Republic of China  
TEL 400-880-2266  
FAX 021-65105380

## Danmark

Bose A/S, Industrivej 7  
2605 Brøndby  
TEL 04343-7777  
FAX 04343-7818  
[www.Bose.dk](http://www.Bose.dk)

## Deutschland

Bose GmbH  
Kundenbetreuung  
Neuenhauser Str. 73  
D-48527 Nordhorn  
TEL 0800 2673444  
[www.Bose.de](http://www.Bose.de)

## Finland

Bose Finland  
Kornetintie 6B  
00380 Helsinki  
TEL 10 778 69 00  
FAX 10 778 69 09  
[www.Bose.fi](http://www.Bose.fi)

## France

Bose S.A.S.  
12 rue de Témara  
78100 Saint Germain en Laye  
TEL 01 30 61 63 63  
FAX 01 30 61 63 60  
[www.Bosefrance.fr](http://www.Bosefrance.fr)

---

**Hong Kong**

Suite 1203, Midas Plaza, 1 lai  
Yau Street, San Po Kong  
Kowloon, Hong Kong  
TEL 852 2123 9000

**India**

Bose Corporation India Private Limited  
The Bose Service Centre  
C13, Ground Floor  
SDA Commercial Complex  
Community Centre  
New Delhi, India 110016  
TEL 1 800 102 2673  
FAX +91 11 47168650

**Ireland**

Bose SMS Ltd.  
Castleblayney Road  
Carrickmacross, Co Monaghan  
TEL 1-800-932-436  
FAX (042) 9671502  
[www.Bose.ie](http://www.Bose.ie)

**Italia**

Bose S.p.A.  
Via della Magliana 876  
00148 Roma  
TEL 06 60 292 292  
[www.Bose.it](http://www.Bose.it)

**Japan**

Bose K.K.  
Sumitomo Fudosan Shibuya  
Garden Tower 5F,  
16-17 Nampeidai-cho  
Shibuya-ku, Tokyo 150-0036  
TEL 0570-080-021  
FAX 03-5489-1041  
[www.Bose.co.jp](http://www.Bose.co.jp)

**Luxemburg**

Bose N.V.  
Limesweg 2  
B-3700 Tongeren  
TEL +32 12 259 960  
FAX +32 12 390840  
[www.Bosebelgium.be](http://www.Bosebelgium.be)

**Mexico**

Bose de Mexico S. de R.L. de C.V.  
Paseo de las Palmas # 405  
Despacho 204  
Lomas de Chapultepec  
C.P. 11000, Mexico D.F., Mexico  
TEL +52 (55) 52 02 35 45  
TEL +52 (55) 52 02 41 95  
FAX +52 (55) 52 02 37 28  
[www.Bose.com.mx](http://www.Bose.com.mx)

**Nederland**

Bose B.V.  
Nijverheidstraat 8  
1135 GE Edam  
TEL 0299-390290  
FAX 0299-390109  
[consumenteninfo@Bose.com](mailto:consumenteninfo@Bose.com)  
[www.Bose.nl](http://www.Bose.nl)

**New Zealand**

TEL 0800 501 511  
[www.Bose.co.nz](http://www.Bose.co.nz)

# Bose Corporation

---

## **Norge**

Bose A/S  
Kongsvinger Festning  
2213 Kongsvinger  
TEL +47 62 82 75 00  
FAX +47 62 82 15 69

## **Poland**

Bose sp. z o.o.  
ul. Woloska 12  
02-675 Warszawa  
TEL 22-852-2928  
FAX 22-852-2927  
[www.Bose.pl](http://www.Bose.pl)

## **Österreich**

Bose Ges.m.b.H.  
Vienna Business Park  
Wienerbergstrasse 7 (10.OG)  
A-1100 Vienna  
TEL 01-60404340  
FAX 01-604043423  
[www.Bose.at](http://www.Bose.at)

## **Schweiz**

Bose AG  
Hauptstrasse 134  
4450 Sissach  
TEL 061-9757733  
FAX 061-9757744  
[www.Bose.ch](http://www.Bose.ch)

## **Sverige**

Bose A/S  
Johannefredsgatan 4  
S-43153 Mölndal  
TEL +46 774 - 450 450  
FAX +46 31 - 274 89 15

## **United Kingdom**

Bose Limited  
1 Ambley Green  
Gillingham Business Park  
Gillingham, Kent ME8 ONJ  
TEL 0800 081 3569  
FAX 0870-741-4545  
[www.Bose.co.uk](http://www.Bose.co.uk)

## **World Wide Web**

[www.Bose.com](http://www.Bose.com)  
[www.Bose.eu](http://www.Bose.eu)  
[global.Bose.com](http://global.Bose.com)



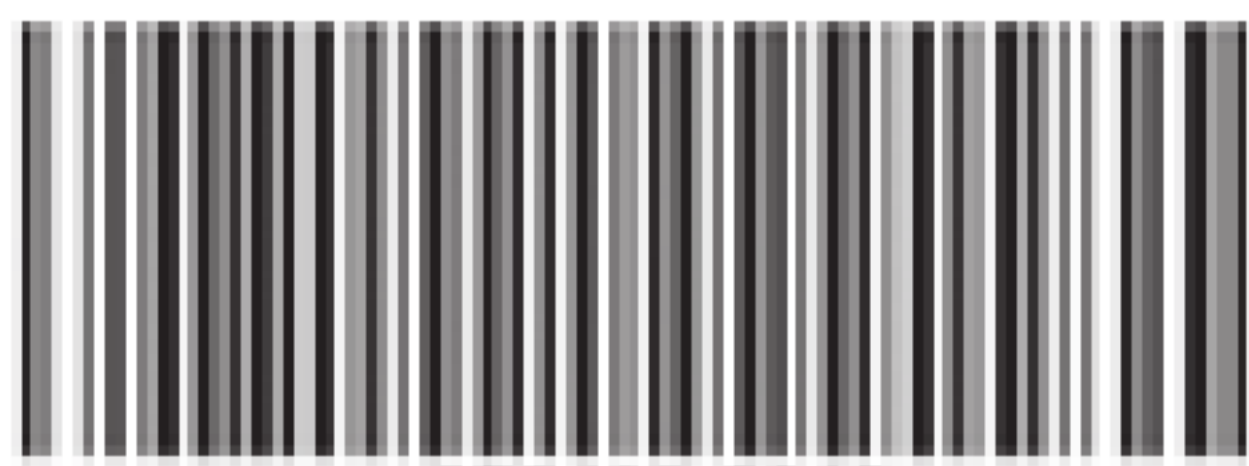

372402-0010

***BOSE***<sup>®</sup>  
***Better sound through research***<sup>®</sup>

©2013 Bose Corporation, The Mountain,  
Framingham, MA 01701-9168 USA  
AM372402 Rev. 00