



# SAFETY INFORMATION

## Please read this owner's guide

Please take the time to follow the instructions in this owner's guide carefully. It will help you set up and operate your system properly and enjoy all of its advanced features. Please save this owner's guide for future reference.

-  **WARNING:** To reduce the risk of fire or electrical shock, do not expose the product to rain or moisture.
-  **WARNING:** The apparatus shall not be exposed to dripping or splashing, and objects filled with liquids, such as vases, shall not be placed on the apparatus. As with any electronic product, use care not to spill liquids into any part of the system. Liquids can cause a failure and/or a fire hazard

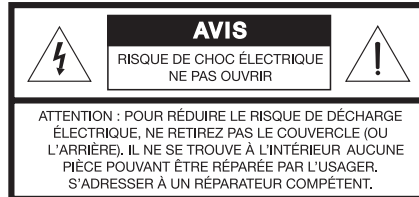
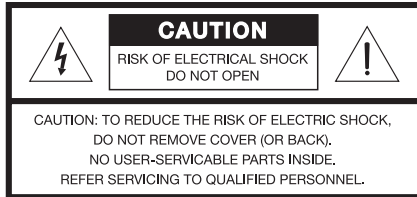

The lightning flash with arrowhead symbol, within an equilateral triangle, alerts the user to the presence of uninsulated dangerous voltage within the system enclosure that may be of sufficient magnitude to constitute a risk of electric shock.



The exclamation point within an equilateral triangle alerts the user to the presence of important operating and maintenance instructions in this owner's guide.

-  **WARNING:** No naked flame sources, such as lighted candles, should be placed on the apparatus.

-  **Note:** The product label is located on the bottom of the product.

This product is intended to be used only with the power supply provided. Where the mains plug is used as the disconnect device, such disconnect device shall remain readily operable.

This product **MUST** be used indoors. It is neither designed or tested for use outdoors, in recreation vehicles, or on boats.

## Important safety instructions

1. **Read these instructions** – for all components before using this product.
2. **Keep these instructions** – for future reference.
3. **Heed all warnings** – on the product and in the owner's guide.
4. **Follow all instructions.**
5. **Do not use this apparatus near water or moisture** – Do not use this product near a bathtub, washbowl, kitchen sink, laundry tub, in a wet basement, near a swimming pool, or anywhere else that water or moisture are present.
6. **Clean only with a dry cloth** – and as directed by Bose Corporation. Unplug this product from the wall outlet before cleaning.
7. **Do not block any ventilation openings. Install in accordance with the manufacturer's instructions** – To ensure reliable operation of the product and to protect it from overheating, put the product in a position and location that will not interfere with its proper ventilation.
8. **Do not install near any heat sources, such as radiators, heat registers, stoves or other apparatus (including amplifiers) that produce heat.**
9. **Only use attachments/accessories specified by the manufacturer.**
10. **Unplug this apparatus during lightning storms or when unused for long periods of time** – to prevent damage to this product.
11. **Refer all servicing to qualified service personnel. Servicing is required when the apparatus has been damaged in any way: such as power supply cord or plug is damaged; liquid has been spilled or objects have fallen into the apparatus; the apparatus has been exposed to rain or moisture, does not operate normally, or has been dropped.**

<b>INTRODUCTION</b>	<b>4</b>
The Bose® link AL8 Homewide Wireless Audio Link	4
Unpacking the carton	4
What distinguishes the two units	5
Choosing a place for each unit	5
<b>SETUP</b>	<b>6</b>
Making the connections	6
For the transmitter	6
For the receiver	7
Instructions for non-Bose or older Bose products	7
Check the indicators and settings	8
The Status LED	8
The transmitter Channel button	9
Your Bose® link expansion room remote control	9
Your Bose link expansion room product	9
Your Bose link expansion room system	9
Enjoy your wireless entertainment	9
<b>REFERENCE</b>	<b>10</b>
Accessories	10
Troubleshooting	10
Contacting Customer Service	11
Limited warranty	11
Technical Information	11

## ***Information about products that generate electrical noise***

### **U.S.A.**

This equipment has been tested and found to comply with the limits for a Class B digital device, pursuant to Part 15 of the FCC rules. These limits are designed to provide reasonable protection against harmful interference in a residential installation. This equipment generates, uses, and can radiate radio frequency energy and, if not installed and used in accordance with the instructions, may cause harmful interference to radio communications. However, there is no guarantee that interference will not occur in a particular installation.

If this equipment does cause harmful interference to radio or television reception, which can be determined by turning the equipment off and on, you are encouraged to try to correct the interference by one or more of the following measures:

- Reorient or relocate the receiving antenna.
- Increase the separation between the equipment and receiver.
- Connect the equipment to an outlet on a different circuit than the one to which the receiver is connected.
- Consult the dealer or an experienced radio/TV technician for help.

Any modifications made to this equipment may void the user's authority to operate this equipment.

### **Canada**

This product complies with the Canadian ICES-003 Class B specification.

Operation is subject to the following two conditions: (1) this device may not cause interference and (2) this device must accept any interference, including interference that may cause undesired operation of the device.

## ***For Your Records***

Serial numbers are located on the bottom of the AL8 transmitter and the receiver.

Serial numbers: Transmitter \_\_\_\_\_ Receiver \_\_\_\_\_

Dealer name: \_\_\_\_\_

Dealer phone: \_\_\_\_\_ Purchase date: \_\_\_\_\_

Bose recommends that you keep your sales slip and a copy of your product registration card together with this guide.

# INTRODUCTION

## The Bose® link AL8 Homewide Wireless Audio Link

Congratulations on your choice of Bose to provide an audio expansion solution free from the need to run cumbersome wires between rooms.

The audio link consists of a transmitter and receiver. They deliver audio signals from your LIFESTYLE® 18 or 28 Series II system or LIFESTYLE® 38 or 48 system in one area of your house to the system or speakers you have set up another area.

One transmitter can also send signals to as many as 8 receivers, making it simple to add on to your system whenever you like.

♪ **Note:** For future expansion possibilities, we recommend that you keep this owner's guide as a reference.

In combination with a Bose link remote control or the PERSONAL® music center II, the Bose® link AL8 Homewide Wireless Audio Link gives you numerous options for expanding your enjoyment.

## Unpacking the carton

Carefully unpack the carton and save all packing materials for possible future use. They provide the most secure way to transport the product.

Check to be sure your system includes all of the parts shown (Figure 1). If any part appears damaged, do not attempt to use it. Notify Bose or your authorized Bose dealer immediately. For Bose contact information, refer to the address sheet included in the carton.

**Figure 1**

Carton contents

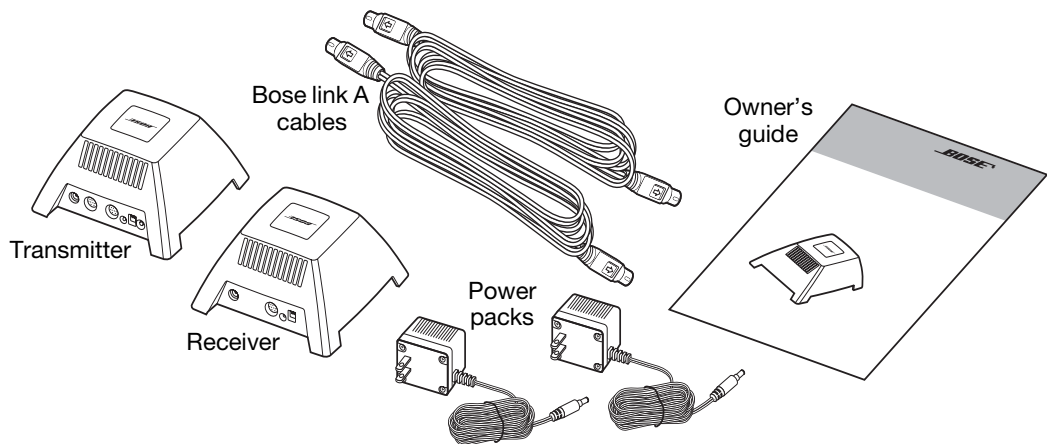

♪ **Note:** Now is a good time to find the serial numbers on the bottom of the transmitter and the receiver. Copy them onto your product registration card and in the space provided on "For Your Records" on page 3.

## What distinguishes the two units

The connection panel on each unit identifies it by name: TRANSMITTER or RECEIVER. Two Bose® link jacks and a Channel button further distinguish the transmitter.

For compatibility, the two units have a matching Setup Code, set at the factory with both switches in the “up” position (Figure 2). A Status LED lights when each unit is plugged in and the two units are communicating.

**Figure 2**

Connection panels on the two units

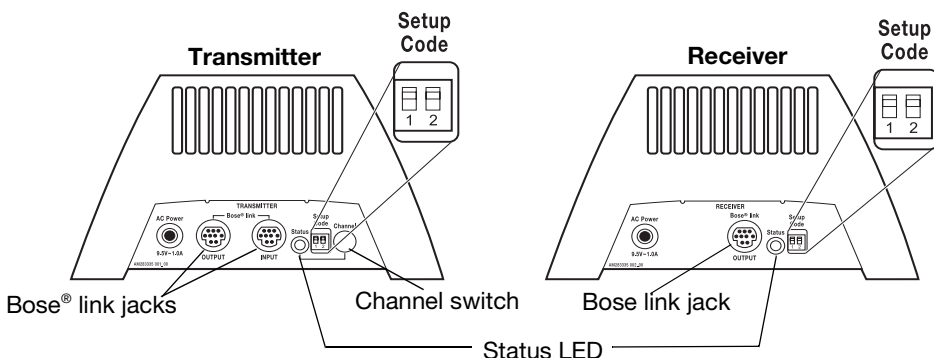

♪ **Note:** For information on the meaning of the different Status LED lights, refer to “Check the indicators and settings” on page 8.

## Choosing a place for each unit

Place the transmitter in the same room with the LIFESTYLE® system media center. Place the receiver in the same room with your Bose link expansion product.

♪ **Note:** Use of the audio link with products that are not Bose link compatible requires an adapter cable. For further information, refer to “Instructions for non-Bose or older Bose products” on page 7.

Considerations for positioning:

- Place each unit upright with all feet flat on a level surface, such as a floor, table, or shelf.
- Do not tip either unit on its side.
- Place each part within 7 feet (2 meters) of the product it serves and connects to (using the supplied Bose link A cable).
- Keep the two units within 80 feet (24 meters) of each other (and the range of the Bose® link remote control that works with them).
- Be aware that the strongest signal direction is above and around the transmitter, not below it).

# SETUP

## Making the connections

You can connect one transmitter and up to 8 receivers per household.

The transmitter and receiver each use one of the two supplied Bose® link A cables, which are 7 feet (2 meters) long. Each unit also connects to power using one of the two supplied power packs.

**Note:** Instructions for use with a non-Bose tuner/receiver vary slightly from those below. For details, refer to “Instructions for non-Bose or older Bose products” on page 7..

### For the transmitter

1. Connect one end of a Bose® link A cable to the jack labeled Bose® link INPUT on the transmitter connection panel.
2. Connect the other end of the cable to the Bose link Speaker jack, below the Main Speaker jack, on the LIFESTYLE® media center connection panel (Figure 3).

**Figure 3**

Transmitter connecting to a LIFESTYLE® media center

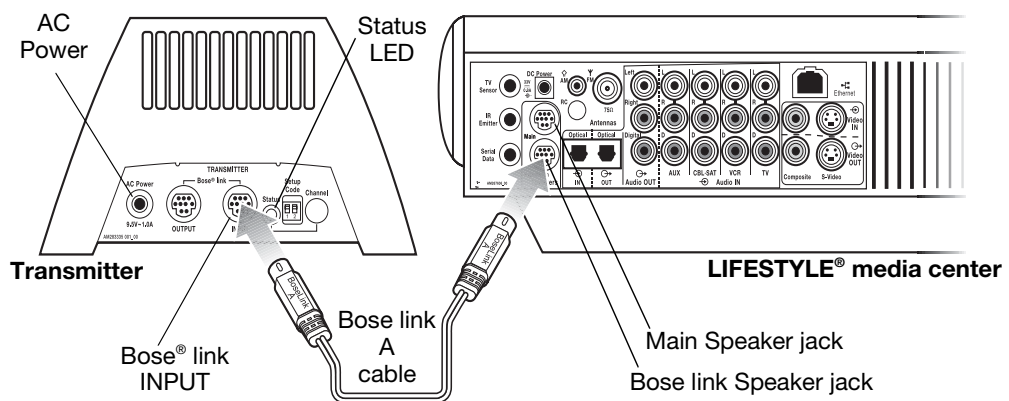

**Note:** If another product is already connected to the Bose link Speaker jack on the media center, disconnect it there. You can use the wireless audio link to replace that wired connection. Or, to continue using that connection, reconnect the cable to the jack labeled Bose link OUTPUT on the transmitter connection panel (Figure 4).

**Figure 4**

Transmitter and another product connecting to a LIFESTYLE® media center

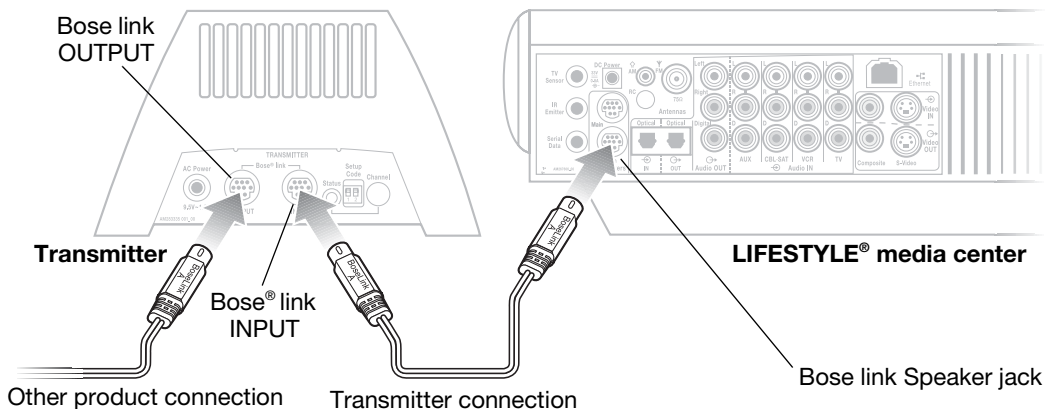

3. Insert the small plug on the power pack cable into the AC Power jack on the transmitter and plug the pack into a wall outlet.

The Status LED lights to verify this power connection.

**Note:** For information on the meaning of the different Status LED lights, refer to “Check the indicators and settings” on page 8.

**For the receiver**

1. Connect one end of the second Bose® link A cable into the jack labeled Bose® link OUTPUT on the receiver.
2. Connect the other end of the cable to the Bose link Input jack on the expansion room system, amplifier, or powered speaker (Figure 5).

**Figure 5**

Connection to a Bose link amplifier, as an example

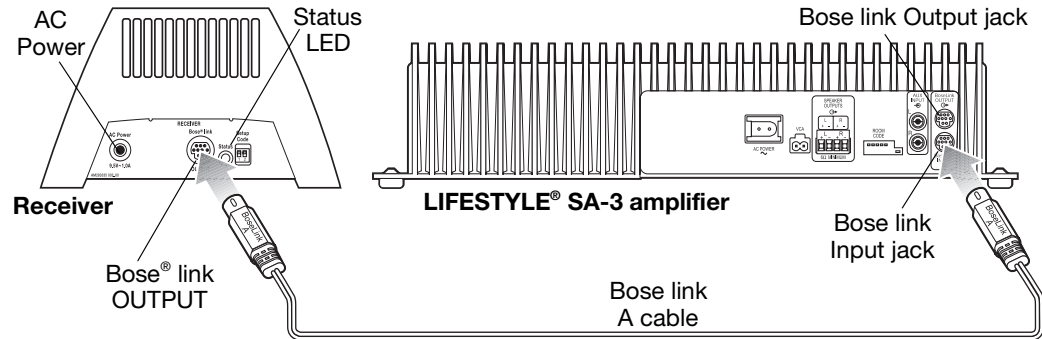

3. Insert the small plug on the power pack cable into the AC Power jack on the receiver and plug the pack into a wall outlet.

The Status LED lights to verify this power connection.

**Note:** For information on the meaning of the different Status LED lights, refer to “Check the indicators and settings” on page 8.

**Instructions for non-Bose or older Bose products**

The Bose® link AL8 Homewide Wireless Audio Link also works with some products that are not Bose link compatible.

You can use non-Bose products in the following ways:

- A tuner/receiver as sound source connected to the transmitter or in an expansion room connected to the receiver
- Powered speakers connected to the receiver

You can use older Bose products as follows:

- Powered speakers, a radio, or system with its own volume and on/off controls and line-level female RCA input jacks connected to the receiver.

Any of the above products require the use of an RCA to DIN adapter cable for connecting to the transmitter, the receiver, or both. An adapter kit, which contains two of these cables, is available from Bose.

**Note:** To order the adapter kit, contact Bose and request Part Number 275474-004. For Bose contact information, refer to the address sheet included in the carton.

**To use an adapter cable**

The RCA connectors are color coded, red for right and white for left.

1. Insert the adapter cable DIN connector into the Bose® link jack on transmitter (INPUT) or receiver (OUTPUT) jack, as appropriate.
2. Insert the adapter cable RCA connectors into the Audio Out jack on the connection panel of the audio source or the Audio In jack on the expansion room product. Match left to left and right to right.

**Figure 6**

Connections using that adapter cable

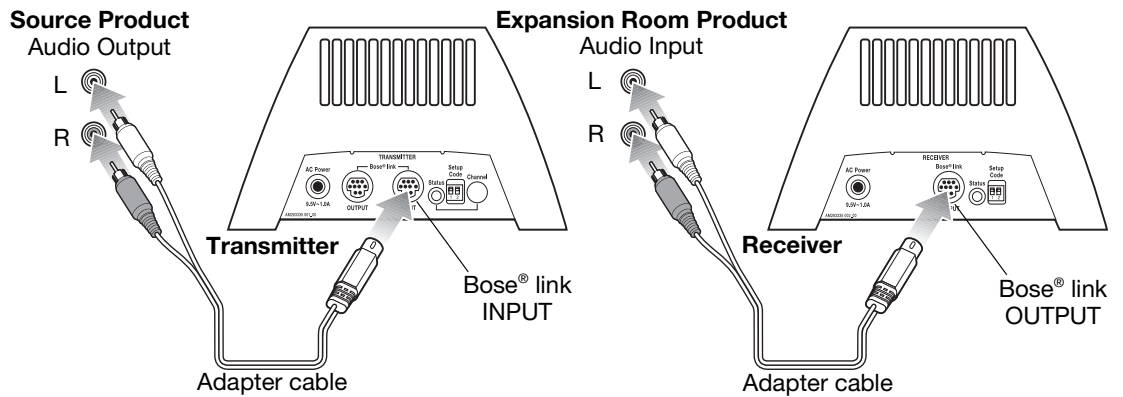

3. Complete the connections using the power pack:
  - Insert the small plug on the power pack cable into the AC Power jack.
  - Plug the pack into an AC wall outlet.

The Status LED lights to verify this power connection.

**Note:** For information on the meaning of the different Status LED lights, refer to “Check the indicators and settings” on page 8.

**To control volume when a non-Bose product is the sound source:**

- There is no need for an expansion room remote control
- Use the remote that came with the tuner/receiver in the room where it is connected to the transmitter.
- Use the volume control on the system, radio, or powered speakers connected to the receiver in the other room.

**To control non-Bose or older Bose products in the expansion room**

- Use a Bose link remote control or the PERSONAL music center II to select audio from the LIFESTYLE system in the main room.
- Use the product remote or console control for local volume adjustments.

**Check the indicators and settings**

Before you use the audio link, you may want to check some of the indicators and settings that make your expansion products work together smoothly.

**The Status LED**

On the connection panel of both the transmitter and the receiver, the Status LED indicates how the two units are communicating, as shown in the table below.

Status LED	Blinking Green	Solid Green	Blinking Orange	Solid Orange
<b>On the transmitter</b>	Searching for receiver	Receiver located	Not applicable	Powered on, no communication
<b>On the receiver</b>	Searching for transmitter	Solid signal received	Weak signal received	Weak or no signal received

On the receiver, a blinking or solid orange light indicates a communications problem. Repositioning the transmitter or receiver, or both, may resolve the problem and cause both LEDs to change to solid green. For further information, refer to “Troubleshooting” on page 10.

### **The transmitter Channel button**

You can use the Channel button to narrow the selection of frequencies the transmitter uses.

At the factory, the transmitter is set for use of any frequency. This may cause noticeable performance problems (slow or intermittent data transmissions) for a nearby wireless (WiFi) network. To eliminate this problem, you can use the Channel button to reserve one channel for use by your Wifi network.

#### **To reserve a channel for use by your WiFi network**

1. In the grouping below, locate the channel used by your nearby WiFi network :  
NO WIFI NETWORK...6...11...1...2...3...4...5...7...8...9...10.
2. Count the number of forward moves it takes from the NO WIFI NETWORK setting to reach the Wifi network channel. For example, if your Wife network uses channel 3, you need to move forward 5 times to reserve channel 3 for Wifi network use only.
3. Press the Channel button for less than 3 seconds to move forward once. Repeat as many times as needed to reach the channel you want to reserve. The Status LED will blink red each time you do.

To start over, press and hold the Channel button for more than 3 seconds to return to All. The Status LED blinks red three times to confirm that move.

If the WiFi network channel is unknown to you, use the Channel button to switch off one channel at a time. Test the WiFi network to see which setting gives you the best effect.

### **Your Bose® link expansion room remote control**

- Room code

If you have more than one LIFESTYLE® system expansion room, make sure the remote used in each one has a unique room code.

- House code

The house code setting on the remote must match the setting on your LIFESTYLE® system. It may not match if you changed the system house code due to interference with another system.

For information on these house code and room code settings and how to change them, refer to the owner's guide that came with your remote.

 **Note:** Setup codes for the transmitter and receiver, which must be identical to each other, do NOT need to match House codes on the remote or LIFESTYLE® system.

### **Your Bose link expansion room product**

- Room code

Make sure the system, amplifier, or powered speaker room code setting matches that of the remote you are using in the expansion room.

For information on room code settings and how to change them, refer to the owner's guide that came with your Bose link product.

## **Enjoy your wireless entertainment**

With the settings confirmed, your Bose link Bose® link AL8 Homewide Wireless Audio Link is ready for use.

To explore and enjoy all of the capabilities provided by your expansion products, refer to the owner's guide provided with each product.



# REFERENCE

## Accessories

Bose offers additional receivers as well as extension/expansion cables and adapter kits for use with the Bose® link AL8 Homewide Wireless Audio Link.

For further information, contact your Bose® dealer or Bose Customer Service. For Bose contact information, refer to the address sheet included in the carton

## Troubleshooting

<b>Problem</b>	<b>What to do</b>
No sound	<ul style="list-style-type: none"> <li>• For both the transmitter and the receiver, make sure:               <ul style="list-style-type: none"> <li>– the audio source is plugged in, turned on, and working.</li> <li>– the Bose® link A cable is securely connected at both ends. Refer to “Making the connections” on page 6.</li> <li>– the small connector end of the power cord is inserted firmly into the AC Power jack on the connection panel and the power pack is plugged securely into a working AC outlet.</li> <li>– the Setup code switches on the connection panel of the transmitter and the receiver are set identically. There are four options: 1 &amp; 2 up; 1 &amp; 2 down; 1 up &amp; 2 down; 1 down and 2 up.</li> <li>– the Status LEDs are lit a solid green to indicate solid communication between the two parts. If not, refer to the next Problem in this table.</li> </ul> </li> <li>• For the expansion room products, make sure:               <ul style="list-style-type: none"> <li>– the system, amplifier, or powered speaker is plugged in and turned on. On an SA-2 or SA-3 amplifier in that room, make sure the status LED is lit to indicate the amplifier is working.</li> <li>– the Room code is set on the Bose® link remote control or PERSONAL® music center II to match the room codes on the amplifier or powered speaker and are unique to this expansion room.</li> <li>– the House code is set on the Bose link remote control or PERSONAL music center II to match the house code of the LIFESTYLE® system in the main room.</li> </ul> </li> </ul>
Above problem persists and the Status LED lights are not green	<ul style="list-style-type: none"> <li>• Move the receiver and transmitter closer together.</li> <li>• Move the receiver, the transmitter or both so the transmission path between them does not intersect with large metal objects (like a refrigerator), impervious construction materials (like thick masonry) or other obstructions (like a pool of water).</li> <li>• Check to see if the Status LEDs turn green as a result of the above efforts. For details, refer to “Check the indicators and settings” on page 8.</li> </ul>
Interference with a WiFi network, telephone, TV, microwave oven, or other electronic device	<ul style="list-style-type: none"> <li>• For interference with a Wifi network, use the Channel button on the connection panel of the transmitter to alleviate the problem. For details, refer to “The transmitter Channel button” on page 9.</li> <li>• For interference with a telephone, TV, microwave oven, or other electronic device:               <ul style="list-style-type: none"> <li>– Move the transmitter or receiver farther from the device</li> <li>– Do not use the audio link and the problem device at the same time</li> </ul> </li> </ul>
Sound heard in the expansion room is not coming from your media center or audio source	<p>Change the Setup code switches on both the transmitter and the receiver, making sure they are identical. This may prevent signals from another AL8 transmitter in the vicinity from reaching your receiver.</p> <p>There are four possible switch combinations: 1 &amp; 2 up (as set at the factory); 1 &amp; 2 down; 1 up &amp; 2 down; 1 down &amp; 2 up.</p>
Unexpected sound from the media center	<p>Change the House code settings in both your LIFESTYLE® system and any remote controls you are using with it.</p> <p>This may prevent another nearby LIFESTYLE® system from affecting the operation of your system. For further information on House codes and how to change them, refer to the owner’s guides that came with your LIFESTYLE® system and Bose link remote controls.</p>

### **Contacting Customer Service**

For additional help in solving problems, contact Bose® Customer Service. Refer to the address sheet included in the carton.

### **Limited warranty**

This system is covered by a transferable limited warranty.

Details of the limited warranty are provided on the Product Registration Card that came with your system. Please fill out the information section on the card and mail it to Bose. Failure to do so, however, will not affect your limited warranty rights.

### **Technical Information**

#### **Power rating**

9.5V $\sim$ , 1.0A

#### **Frequency band**

2.4000 MHz to 2.4835 MHz

#### **Transmitter Audio Input Level**

2 Vrms (fixed)

#### **Receiver Audio Output Level**

2 Vrms (fixed)

#### **Dimensions**

Transmitter: 3"H x 6"W x 6"D (7.6 x 15.2 x 15.2 cm)

Receiver: 3"H x 6"W x 6"D (7.6 x 15.2 x 15.2 cm)

#### **Weight**

Transmitter: 1 lb (0.5 kg)

Receiver: 1 lb (0.5 kg)