



BOWFLEX[®]

BXE216

ASSEMBLY / OWNER'S MANUAL



Manual en Español
Latino Americano:
www.support.nautilus.com

Welcome to the Bowflex® BXE216 fitness machine!

You're about to experience an incredible workout that can help you lose weight and reshape your entire body so you'll look and feel better than ever before. We thank you for trusting in the Bowflex brand.

Use this Manual as a guide to getting started on your Bowflex® workouts and for tips to keep your machine well maintained.

Yours in Health,
The Bowflex Family

Table of Contents

Important Safety Instructions	3	Power Up / Idle Mode	41
Safety Warning Labels and Serial Number.....	5	Initial Setup	41
Grounding Instructions	6	User Profiles	41
Specifications / Before Assembly	7	Workout Programs	42
Parts	8	Pausing or Stopping	45
Hardware / Tools	9	Workout Complete / Results	45
Assembly	10	Fitness Score Display	46
Moving Your Machine	24	Celebrations	47
Leveling Your Machine	24	Machine Settings Mode	48
Features	25	Maintenance	49
Connectivity with the Fitness App	29	Maintenance Parts.....	50
Fitness Basics	33	Troubleshooting.....	51
Operations	40	Body Weight Loss Guide	54
Adjusting the Pedals	40	Warranty	63
Mounting and Dismounting	40		

To validate warranty support, keep the original proof of purchase and record the following information:

Serial Number _____ Date of Purchase _____

To register your product warranty, go to: www.bowflex.com/register

Or call 1 (800) 605-3369.

If you have questions or problems with your product, please call 1 (800) 605-3369.

Nautilus, Inc., (800) NAUTILUS / (800) 628-8458, www.NautilusInc.com - Customer Service: North America (800) 605-3369, csnls@nautilus.com | outside U.S. www.nautilusinternational.com | Printed in China | © 2016 Nautilus, Inc. | ® indicates trademarks registered in the United States. These marks may be registered in other nations or otherwise protected by common law. Bowflex, the B logo, Bowflex Connect, Bowflex Trainer, Switch Select, Nautilus, Schwinn, and Universal are trademarks owned by or licensed to Nautilus, Inc. Loctite®, Polar®, OwnCode®, Android™, iTunes®, Google Play™, and Nut Thins® are trademarks of their respective owners. Apple and the Apple logo are trademarks of Apple Inc., registered in the U.S. and other countries. App Store is a service mark of Apple Inc. The Bluetooth® word mark and logos are registered trademarks owned by Bluetooth SIG, Inc., and any use of such marks by Nautilus, Inc. is under license.

When using an electrical appliance, basic precautions should always be followed, including the following:

 This icon means a potentially hazardous situation which, if not avoided, could result in death or serious injury.

Obey the following warnings:

 Read and understand all Warnings on this machine.
Carefully read and understand the Assembly/Owner's Manual.

▲ DANGER Carefully read and understand the Assembly instructions. Read and understand the complete Manual. Keep the Manual for future reference.

▲ DANGER To reduce the risk of electrical shock or unsupervised usage of the equipment, always unplug this machine from the electrical outlet immediately after using and before cleaning.

▲ WARNING To decrease the risk of burns, electric shock, or injury to persons, read and understand the complete Assembly/Owner's Manual. Failure to follow these guidelines can cause a serious or possibly fatal electrical shock or other serious injury.

- Keep bystanders and children away from the product you are assembling at all times.
- Do not connect power supply to the machine until instructed to do so.
- The machine should never be left unattended when plugged in. Unplug from outlet when not in use, and before putting on or taking off parts.
- Before each use, examine the machine for damage to power cord, loose parts or signs of wear. Do not use if found in this condition. Contact Nautilus Customer Service for repair information.
- Do not drop or put objects into any opening of the machine.
- Do not assemble this machine outdoors or in a wet or moist location.
- Make sure assembly is done in an appropriate work space away from foot traffic and exposure to bystanders.
- Some components of the machine can be heavy or awkward. Use a second person when doing the assembly steps involving these parts. Do not do steps that involve heavy lifting or awkward movements on your own.
- Set up this machine on a solid, level, horizontal surface.
- Do not try to change the design or functionality of this machine. This could compromise the safety of this machine and will void the warranty.
- If replacement parts are necessary, use only genuine Nautilus replacement parts and hardware. Failure to use genuine replacement parts can cause a risk to users, keep the machine from operating correctly and void the warranty.
- Do not use until the machine has been fully assembled and inspected for correct performance in accordance with the Manual.
- Use this machine only for its intended use as described in this manual. Do not use attachments not recommended by the manufacturer.
- Do all assembly steps in the sequence given. Incorrect assembly can lead to injury or incorrect function.
- Connect this machine to a properly grounded outlet only (see Grounding Instructions).
- Keep the power cord away from heat sources and hot surfaces.
- Do not operate where aerosol products are being used.
- To disconnect, turn all controls to the off position, then remove plug from outlet.
- Silicone lubricant is not intended for human consumption. Keep out of reach of children. Store in a safe place.
- SAVE THESE INSTRUCTIONS.

Before using this equipment, obey the following warnings:



Read and understand the complete Manual. Keep the Manual for future reference.

Read and understand all Warnings on this machine. If at any time the Warning stickers become loose, unreadable or dislodged, contact Nautilus Customer Service for replacement stickers.



To reduce the risk of electrical shock or unsupervised usage of the equipment, always unplug the power cord from the wall outlet and/or the machine and wait 5 minutes before cleaning, maintaining or repairing the machine. Place the power cord in a secure location.

- Children must not be let on or near to this machine. Moving parts and other features of the machine can be dangerous to children.
- Not intended for use by anyone under 14 years of age.
- Consult a physician before you start an exercise program. Stop exercising if you feel pain or tightness in your chest, become short of breath, or feel faint. Contact your doctor before you use the machine again. Use the values calculated or measured by the machine's computer for reference purposes only.
- Before each use, examine this machine for damage to power cord, power receptacle, loose parts or signs of wear. Do not use if found in this condition. Contact Nautilus Customer Service for repair information.
- Always connect the power cord to a circuit capable of handling 10 amperes with no other loads applied.
- Connect this machine to a correctly grounded outlet; consult a licensed electrician for assistance.
- Do not let liquids touch the electronic controller. If it does, the controller must be inspected and tested for safety by an approved technician before it can be used again.
- The electrical wiring for the residence in which the machine will be used must obey the applicable local and provincial requirements.
- Maximum user weight limit: 400 lbs. (181 kg). Do not use if you are over this weight.
- This machine is for home use only.
- Do not wear loose clothing or jewelry. This machine contains moving parts. Do not put fingers, feet, or other objects into moving parts of the exercise equipment.
- Always wear rubber soled athletic shoes when you use this machine. Do not use the machine with bare feet or only wearing socks.
- Set up and operate this machine on a solid, level, horizontal surface.
- Make the Foot Pedals stable before you step on them. Use caution when you step on and off the machine.
- Do not operate this machine outdoors or in moist or wet locations.
- Keep at least 24" (0.6 m) on each side of the machine clear. This is the recommended safe distance for access and passage around and emergency dismounts from the machine. Keep third parties out of this space when machine is in use.
- Do not over exert yourself during exercise. Operate the machine in the manner described in this manual.
- Correctly adjust and safely engage all Positional Adjustment Devices. Make sure that the Adjustment Devices do not hit the user.
- Keep the Foot Pedals and Handlebars clean and dry.
- Perform all regular and periodic maintenance procedures recommended in the Owner's Manual.
- Do not drop or put objects into any opening of the machine.
- Keep power cord away from heat source and hot surfaces.
- This machine must be connected to an appropriate, dedicated electrical circuit. Nothing else must be connected to the circuit.
- Connect this machine to a correctly grounded outlet; consult a licensed electrician for assistance.
- Do not operate where aerosol products are being used.
- Exercise on this machine requires coordination and balance. Be sure to anticipate that changes in speed, incline angle and resistance level can occur during workouts, and be attentive in order to avoid loss of balance and possible injury.
- A machine should never be left unattended when plugged in. Unplug from outlet when not in use, and before putting on or taking off parts.
- Use this machine only for its intended use as described in this manual. Do not use attachments not recommended by the manufacturer.
- This appliance is not intended for use by persons with reduced physical, sensory or mental capabilities, or lack of knowledge, unless they have been given supervision or instruction concerning use of the appliance by a person responsible for their safety. Keep children under the age of 14 away from this machine.

Safety Warning Labels and Serial Number

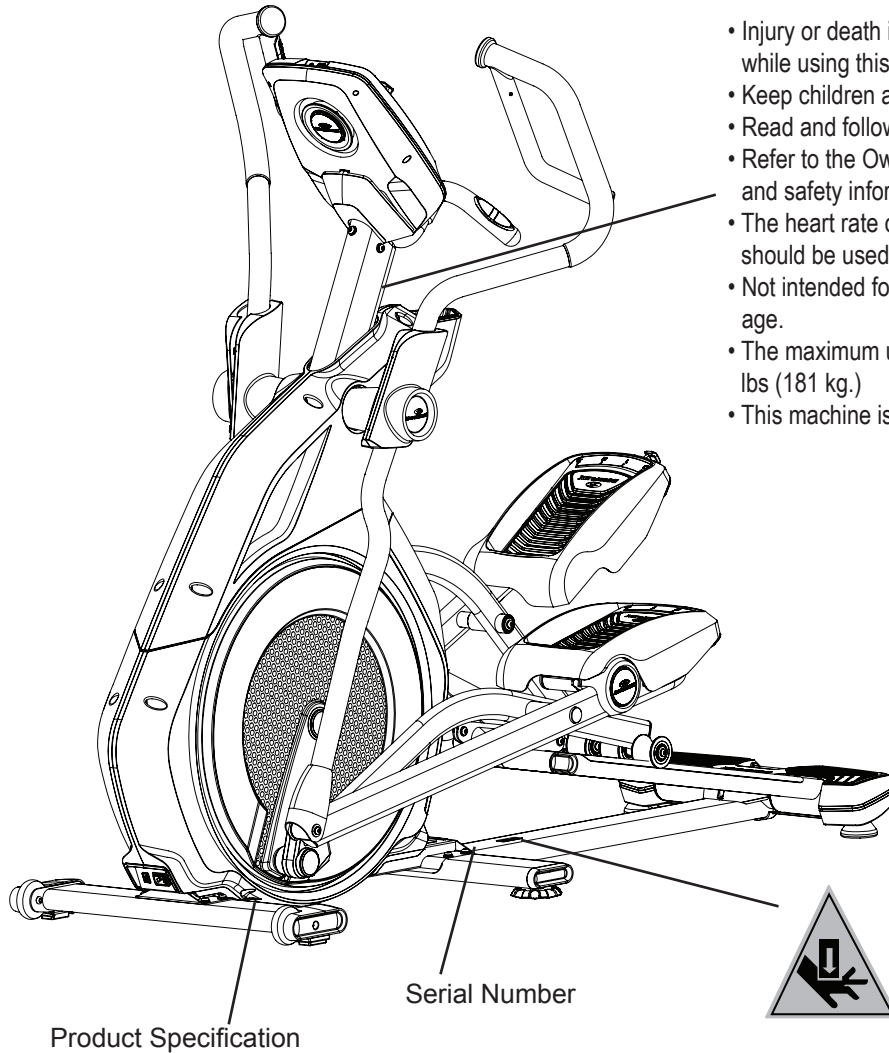

WARNING!

- Injury or death is possible if caution is not used while using this machine.
- Keep children and pets away.
- Read and follow all warnings on this machine.
- Refer to the Owner's Manual for additional warnings and safety information.
- The heart rate displayed is an approximation and should be used for reference only.
- Not intended for use by anyone under 14 years of age.
- The maximum user weight for this machine is 400 lbs (181 kg.)
- This machine is for home use only.

WARNING!

Keep hands and feet away.

Grounding Instructions

This product must be grounded. If it should malfunction or break down, grounding provides a path of least resistance for electric current to reduce the risk of electric shock. This product is equipped with a cord having an equipment-grounding conductor and a grounding plug. The plug must be plugged into an appropriate outlet that is properly installed and grounded in accordance with all local codes and ordinances.

⚠ DANGER Improper connection of the equipment-grounding conductor can result in a risk of electric shock. Check with a qualified electrician or serviceman if you are in doubt as to whether the product is properly grounded. Do not modify the plug provided with the product – if it will not fit the outlet, have a proper outlet installed by a qualified electrician.

If you connect the machine to an outlet with GFI (ground fault interrupt) or AFI (arc fault interrupt), machine operation can cause the circuit to trip.

⚠ This machine is for use on a nominal 120-V circuit, and has a grounding plug that looks like the plug illustrated below. A temporary adapter that looks like the adapter illustrated may be used to connect this plug to a 2-pole receptacle as shown if a properly grounded outlet is not available.

The temporary adapter should be used only until a properly grounded outlet can be installed by a qualified electrician. The tab for the grounding screw must be connected to a permanent ground such as a properly grounded outlet box cover. Whenever the adapter is used, it must be held in place by a metal screw.

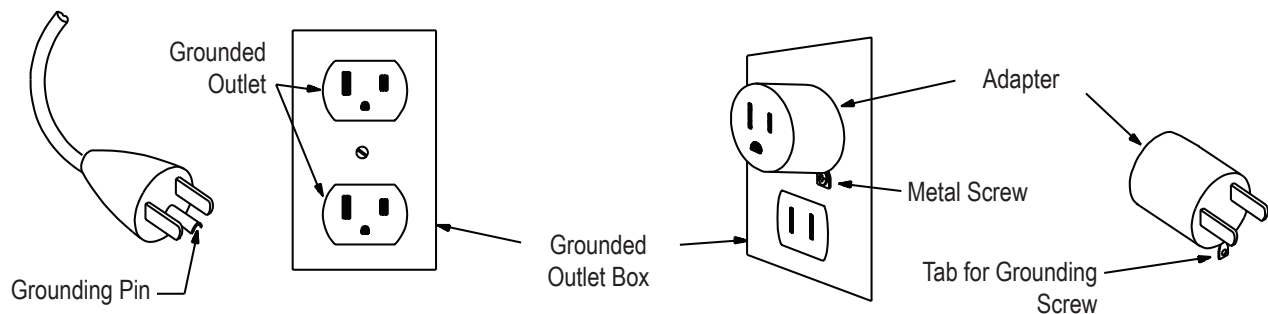

FCC Compliance

⚠ Changes or modifications to this unit not expressly approved by the party responsible for compliance could void the user's authority to operate the equipment.

The machine and power supply comply with Part 15 of the FCC rules. Operation is subject to the following two conditions: (1) This device may not cause harmful interference, and (2) this device must accept any interference received, including interference that may cause undesired operation.

Note: This machine and power supply have been tested and found to comply with the limits for a Class B digital device, pursuant to Part 15 of the FCC Rules. These limits are designed to provide reasonable protection against harmful interference in a residential installation. This equipment generates, uses and can radiate radio frequency energy and, if not installed and used in accordance with the instructions, may cause harmful interference to radio communications.

However, there is no guarantee that interference will not occur in a particular installation. If this equipment does cause harmful interference to radio or television reception, which can be determined by turning the equipment off and on, the user is encouraged to try to correct the interference by one or more of the following measures:

- Reorient or relocate the receiving antenna.
- Increase the separation between the equipment and receiver.
- Connect the equipment into an outlet on a circuit different from that to which the receiver is connected.
- Consult the dealer or an experienced radio/TV technician for help.

Maximum User Weight:	400 lbs (181.4 kgs)
Maximum Pedal Height - with full incline:	29" (73.7 cm)
Machine Weight:	approx. 263 lbs (119 kg)
Power Requirements:	
Operational Voltage:	120V AC @60Hz
Operating Current:	2 A
Heart Rate Chest Strap:	1 CR2032 battery

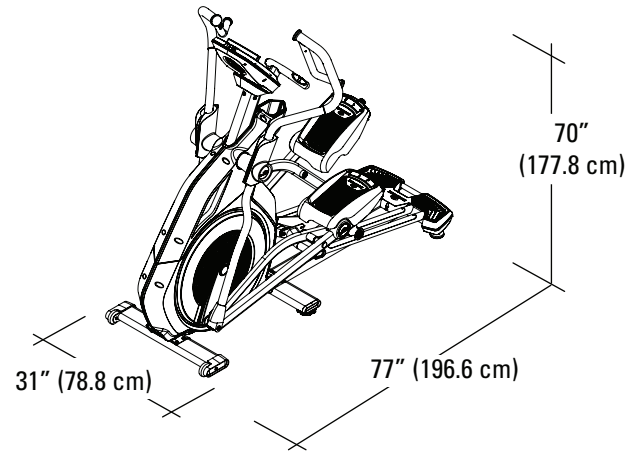

⚠ WARNING This product, its packaging, and components contain chemicals known to the State of California to cause cancer, birth defects, or reproductive harm. This Notice is provided in accordance with California's Proposition 65. If you would like additional information, please refer to our web site at www.nautilus.com/prop65.

Before Assembly

Select the area where you are going to set up and operate your machine. For safe operation, the location must be on a hard, level surface. Allow a minimum workout area of 79" x 125" (200.7 cm x 317.5 cm). Be sure that the workout space you are utilizing has adequate height clearance, taking into consideration the height of the user and the maximum incline of the elliptical machine.

Basic Assembly

Follow these basic points when you assemble your machine:

- Read and understand the "Important Safety Instructions" before assembly.
- Collect all the pieces necessary for each assembly step.
- Using the recommended wrenches, turn the bolts and nuts to the right (clockwise) to tighten, and the left (counterclockwise) to loosen, unless instructed otherwise.
- When attaching 2 pieces, lightly lift and look through the bolt holes to help insert the bolt through the holes.
- The assembly requires 2 people.
- Do not use any power tools for assembly.

Note: The Bowflex® fitness machine is designed to plug into a grounded, non-GFI/non-AFCI outlet only. To determine if your outlet or circuit breaker is GFI/AFCI, look for a test and reset button on them. If they have the test and reset button, it is a GFI/AFCI outlet or circuit breaker.

Machine Mat

The Bowflex™ Machine Mat is an optional accessory that helps keep your workout area clear and adds a layer of protection to your floor. The rubber machine mat provides a non-slip, rubber surface which limits static discharge and reduces the possibility of display errors. If possible, put your Bowflex™ Machine Mat in your selected workout area before you begin assembly.

To order the optional machine mat, go to: www.bowflex.com, or call 1 (800) 605-3369.

Parts

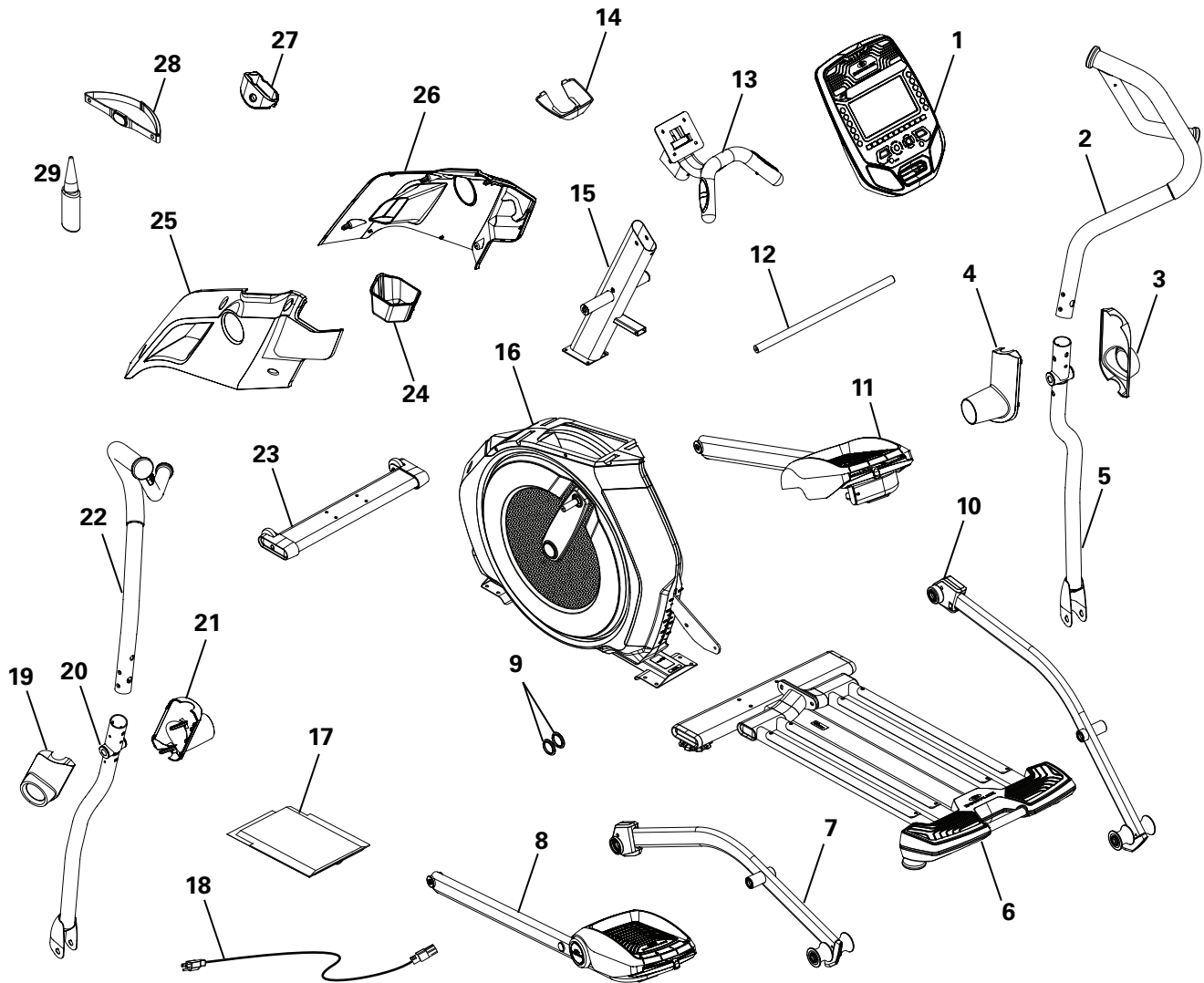

A right (“ R ”) and left (“ L ”) decal has been applied to some parts to assist with assembly.

Item	Qty	Description	Item	Qty	Description
1	1	Console Assembly	16	1	Frame Assembly
2	1	Upper Handlebar, Right	17	1	Document Kit
3	1	Pivot Cover, Right Exterior	18	1	Power Cord
4	1	Pivot Cover, Right Interior	19	1	Pivot Cover, Left Exterior
5	1	Lower Handlebar, Right	20	1	Lower Handlebar, Left
6	1	Rail Assembly	21	1	Pivot Cover, Left Interior
7	1	Leg, Left	22	1	Upper Handlebar, Left
8	1	Pedal, Left	23	1	Front Stabilizer
9	2	Cap	24	1	Tray
10	1	Leg, Right	25	1	Upper Shroud, Left
11	1	Pedal, Right	26	1	Upper Shroud, Right
12	1	Pivot Rod	27	1	Console Mast Collar
13	1	Static Handlebars	28	1	Chest Strap
14	1	Console Shroud	29	1	Silicone Lubricant, Bottle
15	1	Console Mast			

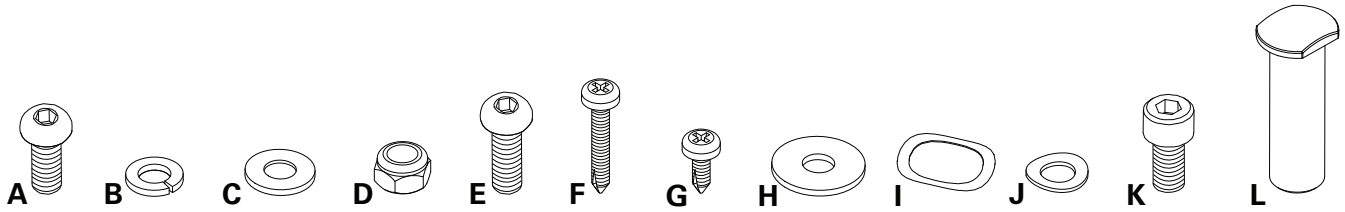

Item	Qty	Description	Item	Qty	Description
A	29	Button Head Screw, M8x1.25x16	G	6	Pan Phillips Screw M3.9x16
B	31	Lock Washer, M8	H	8	Flat Washer, M8x24 Large
C	18	Flat Washer, M8x18	I	6	Wave Washer, M8
D	2	Lock Nut, M8	J	9	Curved Washer, M8
E	2	Button Head Screw, M8x1.25x25	K	2	Socket Head Cap Screw, M8x16
F	4	Pan Phillips Screw M3.9x38	L	2	Pivot Pin

Note: Select pieces of Hardware have been provided as spares on the Hardware Card. Be aware that there may be remaining Hardware after the proper assembly of your machine.

Tools

Included



6mm - short
6mm - long



#2
13mm
15mm
19mm

Not Included



(recommended)



Assembly

! Some components of the machine can be heavy or awkward. Use a second person when doing the assembly steps involving these parts. Do not do steps that involve heavy lifting or awkward movements on your own.

1. Safely Remove the Stabilizing Block(*) and Attach the Front Stabilizer to Frame Assembly

! In order to avoid possible serious injury, when placing the Frame Assembly onto the Front Stabilizer be careful to avoid fingers or hands being caught or pinched.

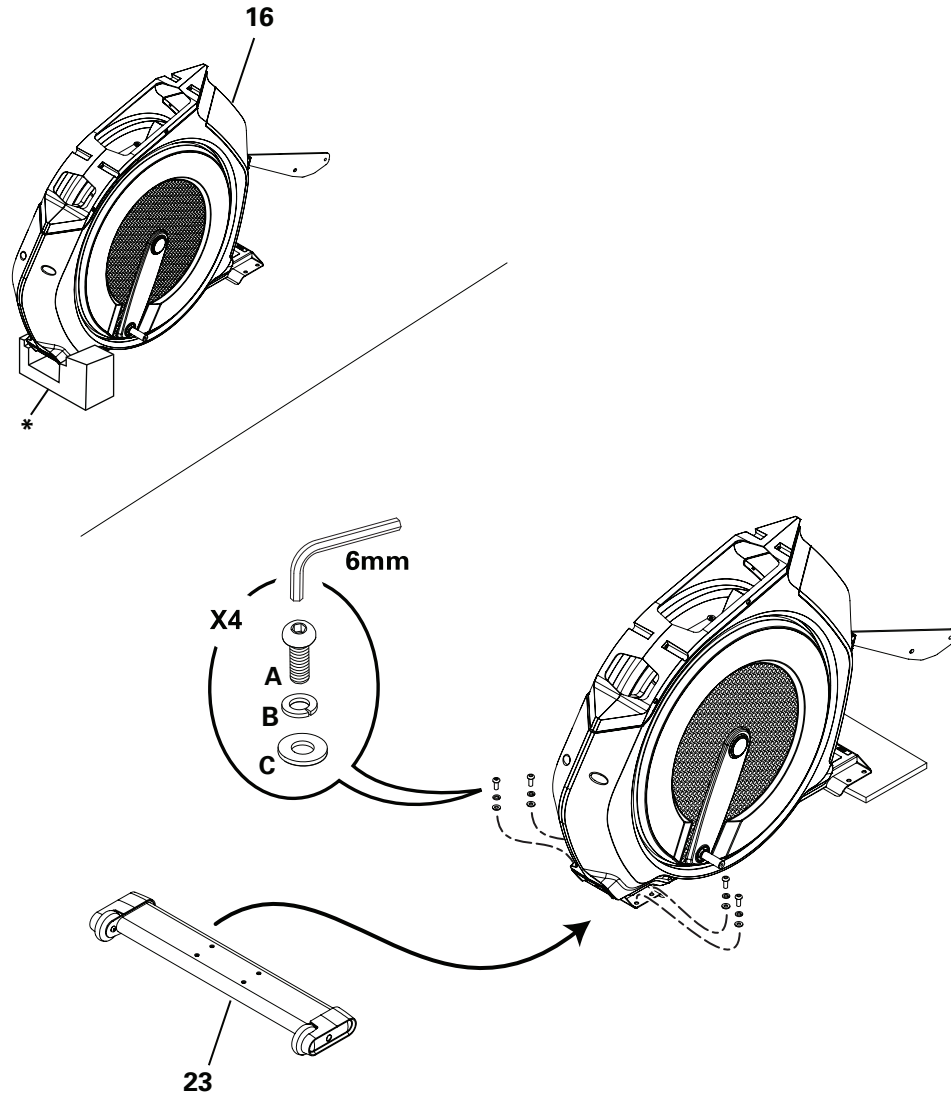

2. Attach Rail Assembly to Frame Assembly

! In order to avoid possible serious injury, when attaching the Rail Assembly to the Frame Assembly be careful to avoid fingers or hands being caught or pinched. Do not place fingers or hands below any pivoting parts of the Rail Assembly.

Note: Do not fully tighten until all hardware has been installed. Some parts can be slightly shifted to assist with alignment. The plastic scratch guard strips on the Rails help to protect the finish during assembly.

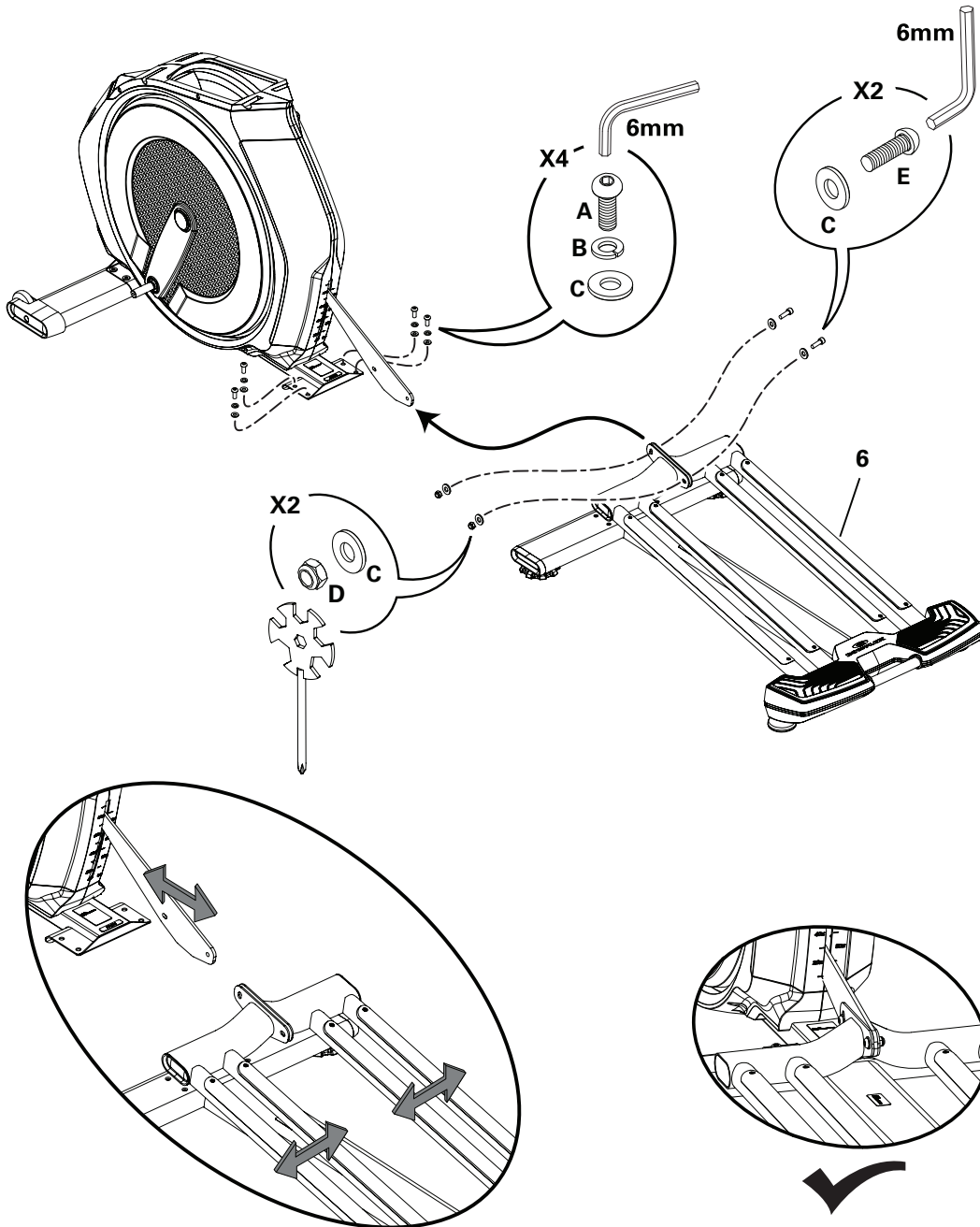

3. Connect Cables and Attach Console Mast to Frame Assembly

Note: Do not crimp the Lower I/O Cable.

Be sure to **FULLY** tighten hardware with hex wrench when all hardware has been finger tightened.

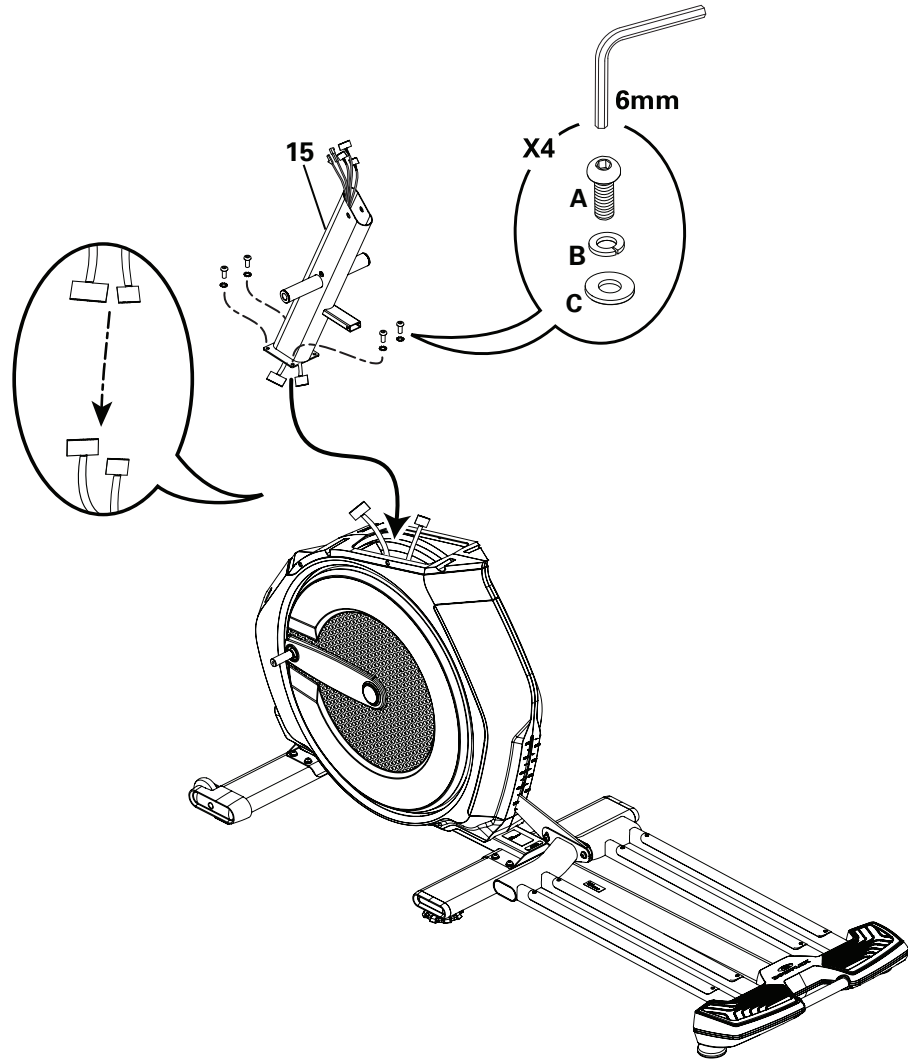

4. Route Handlebar Cables through Upper Shrouds and Attach the Upper Shrouds and Tray

Note: Do not crimp the Cables. This step may require two people. Do not fully tighten until all hardware has been installed. To assist, the short screws go into the metal Frame and the longer screws go through to the other Upper Shroud

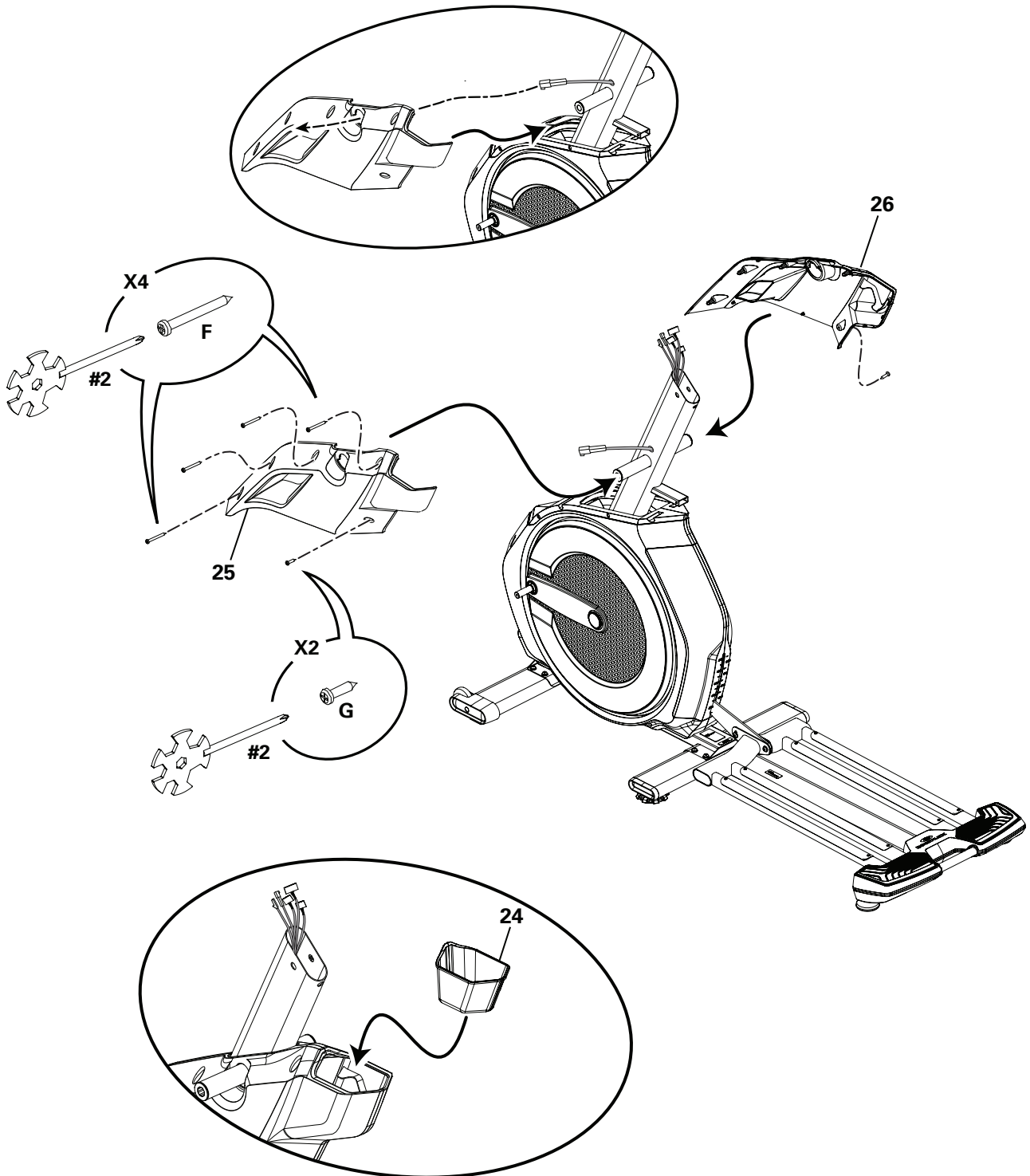

5. Attach Legs and then the Caps to Frame Assembly

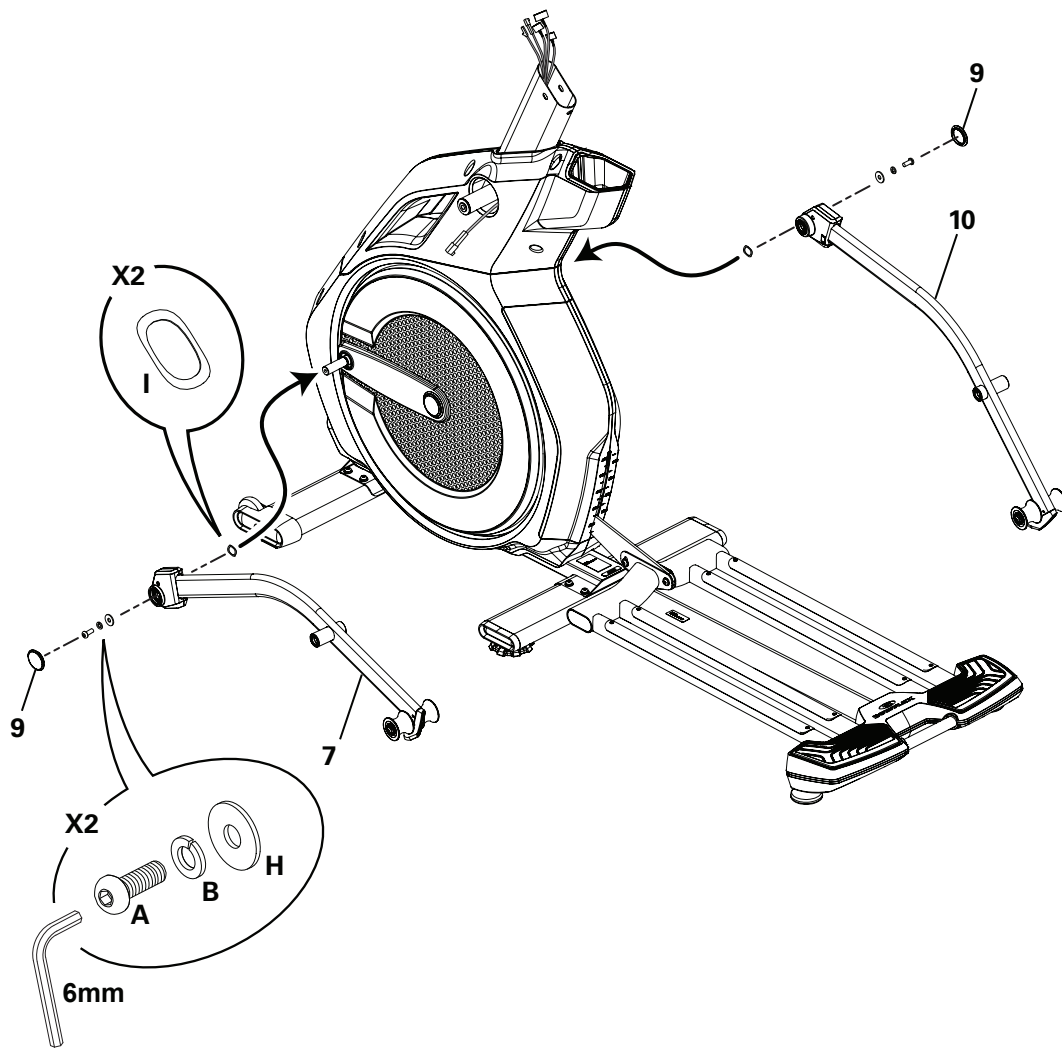

6. Attach the Lower and Upper Handlebar Arms

! In order to avoid possible serious injury, when inserting the tube ends onto the Lower Handlebar Arms be careful to avoid fingers or hands being caught or pinched.

Note: Do not crimp the Cables. A right (" R ") and left (" L ") decal has been applied to some parts to assist with assembly.

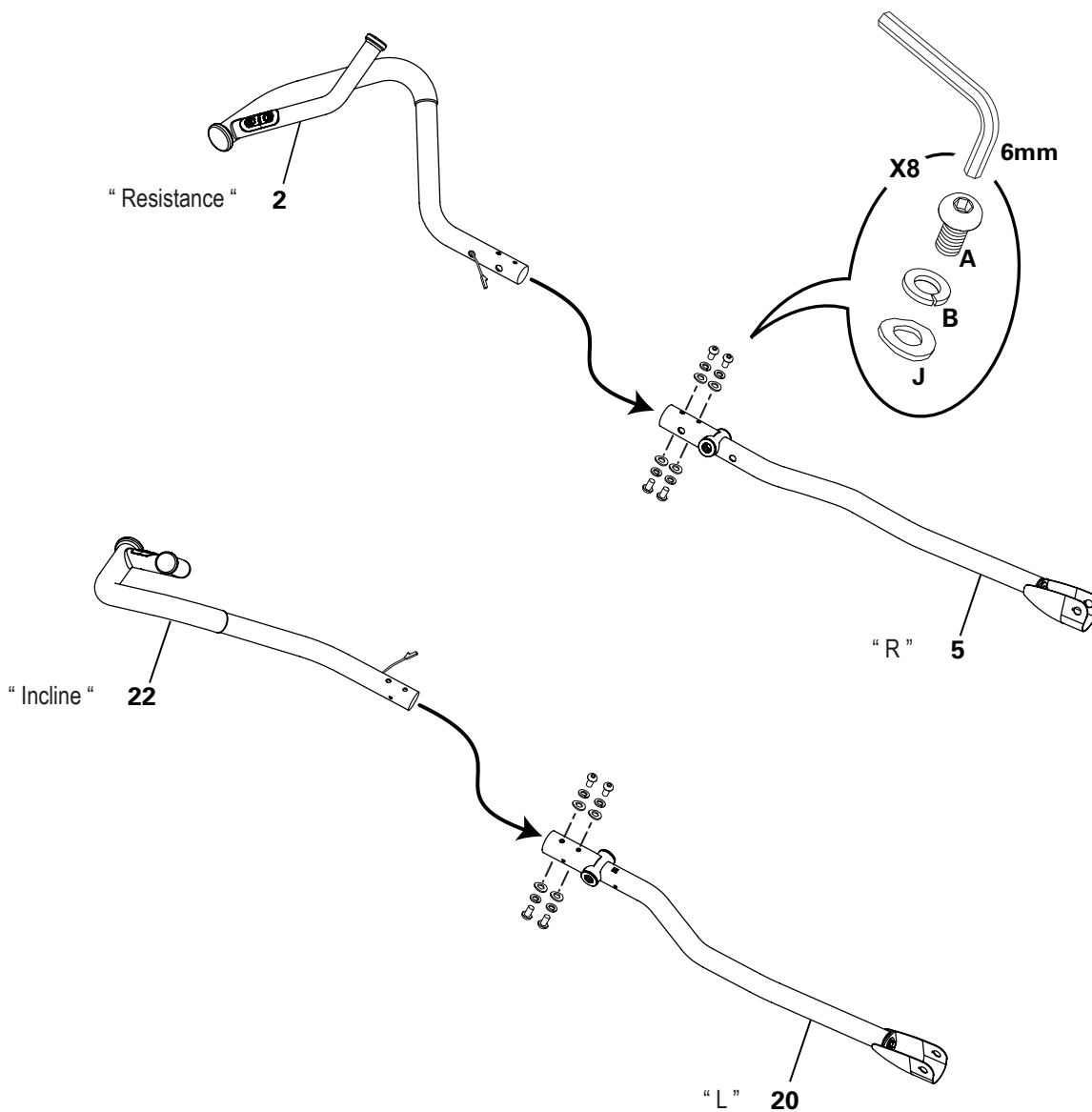

7. Insert Pivot Rod, Attach Interior Pivot Covers and Handlebar Arms, and Connect Cables

! Be aware that the Handlebars are top heavy, and will want to pivot when attached onto the Pivot Rod. Be sure to stay out of the path of the Handlebars and to gently allow it to pivot to a rest. Do not fully rotate the Handlebars or damage to the Cables will occur.

Note: Do not crimp the Cables. Be sure to route the Cables through the additional opening of the Interior Pivot Covers. A decal has been applied to all right ("R") and left ("L") parts to assist with assembly.

Do not fully tighten hardware until cables have been connected.

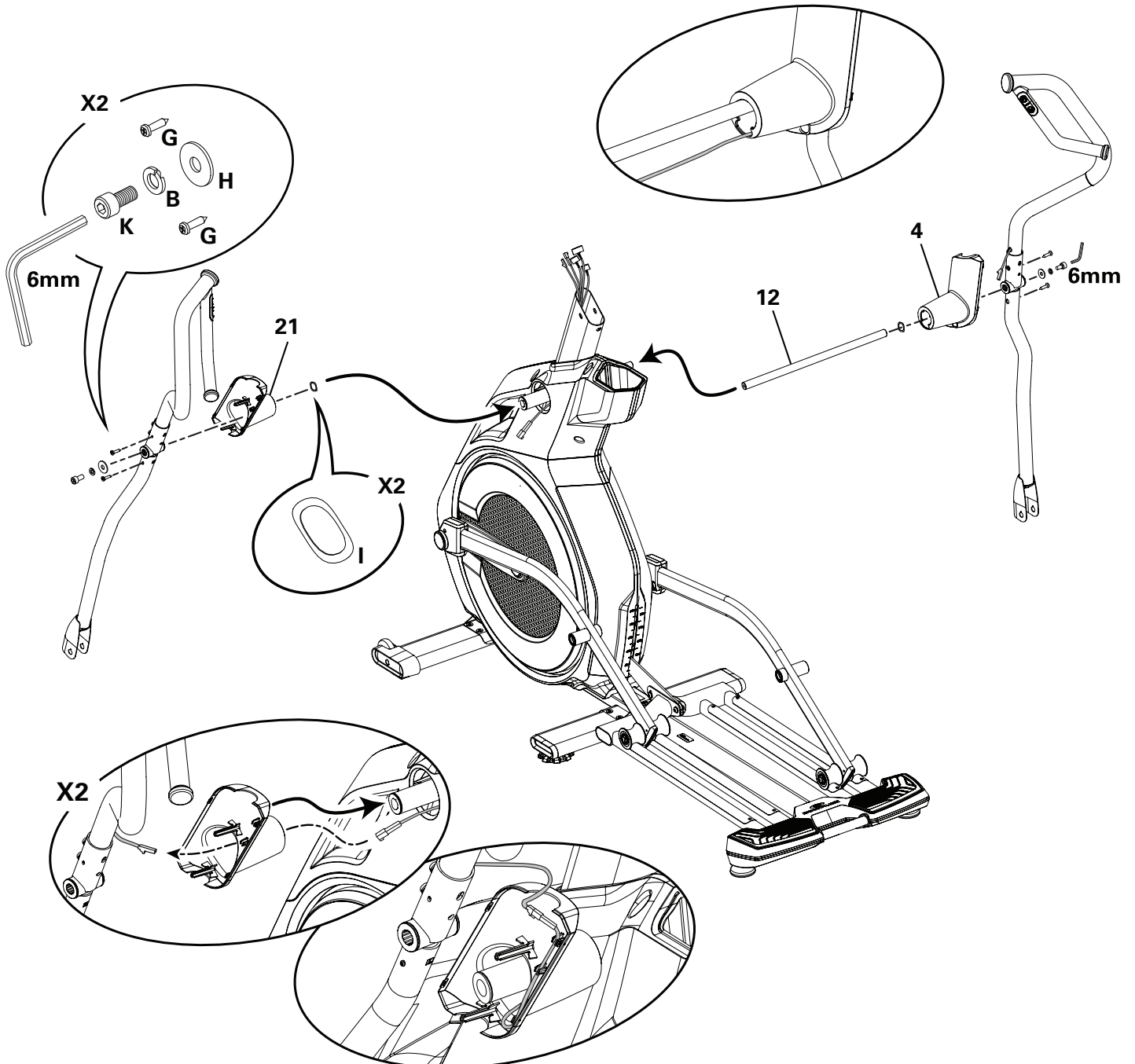

8. Attach Pedals to Frame Assembly

! In order to avoid possible serious injury, when inserting the end of the Pedal into the Lower Handlebar Arm be careful to avoid fingers or hands being caught or pinched. Be sure to stay out of the path of the Handlebars.

Note: Be sure the key on the Pivot Pin is fully set into the notch on the Lower Handlebar Arm. Slightly rotate the Pivot Pin to assist with a proper set.

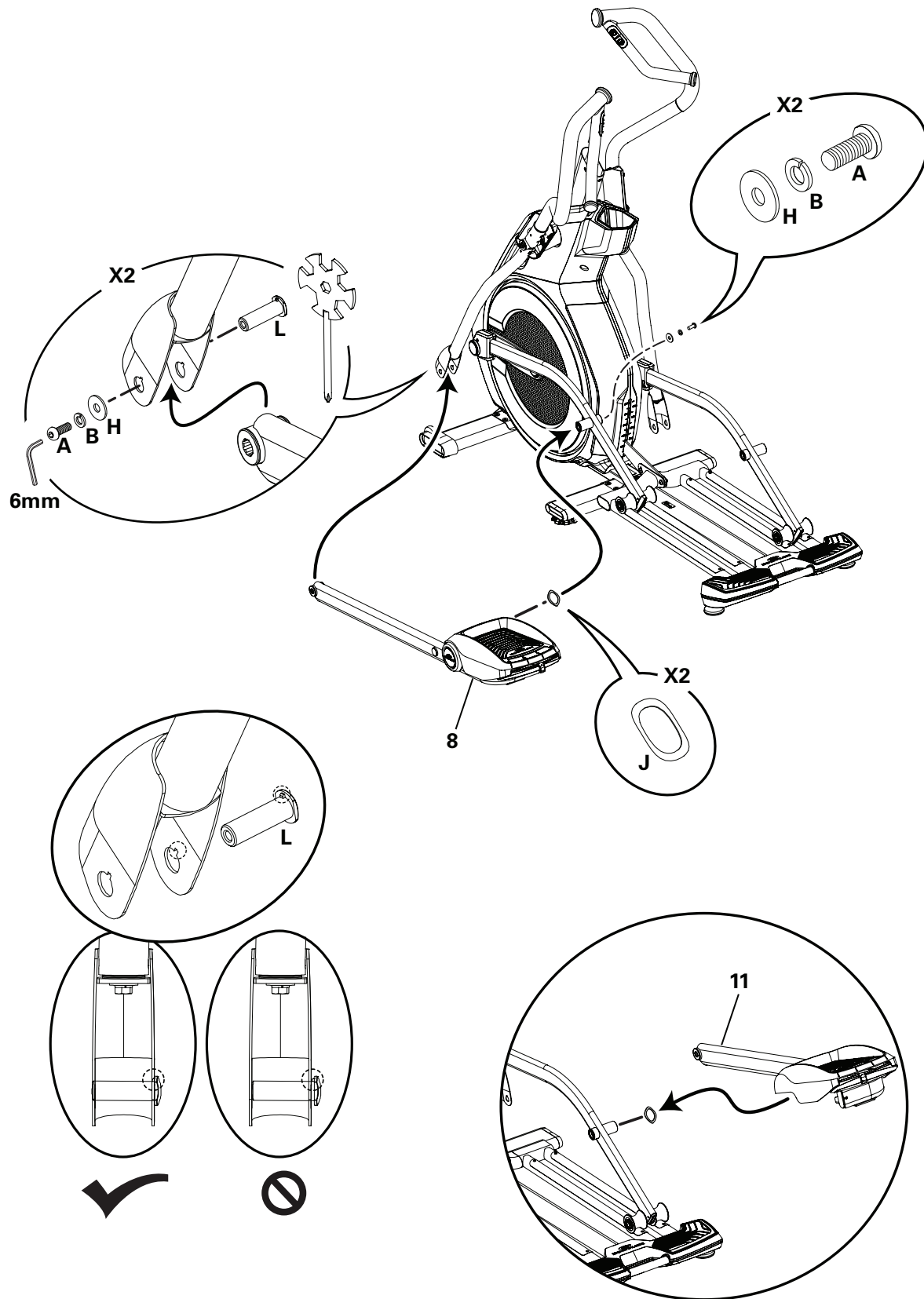

9. Snap the Exterior Pivot Covers to Frame Assembly

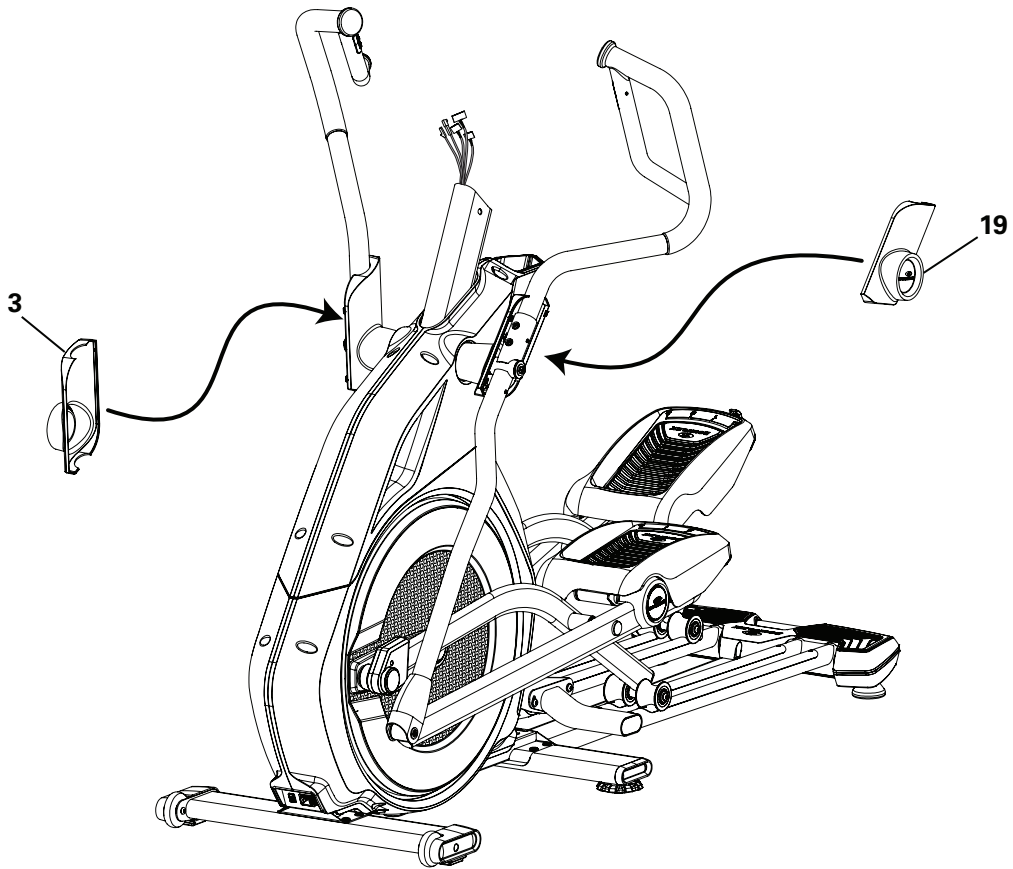

10. Place the Console Mast Collar, and Remove the Hardware from the Console

Note: Do not crimp the Cables.

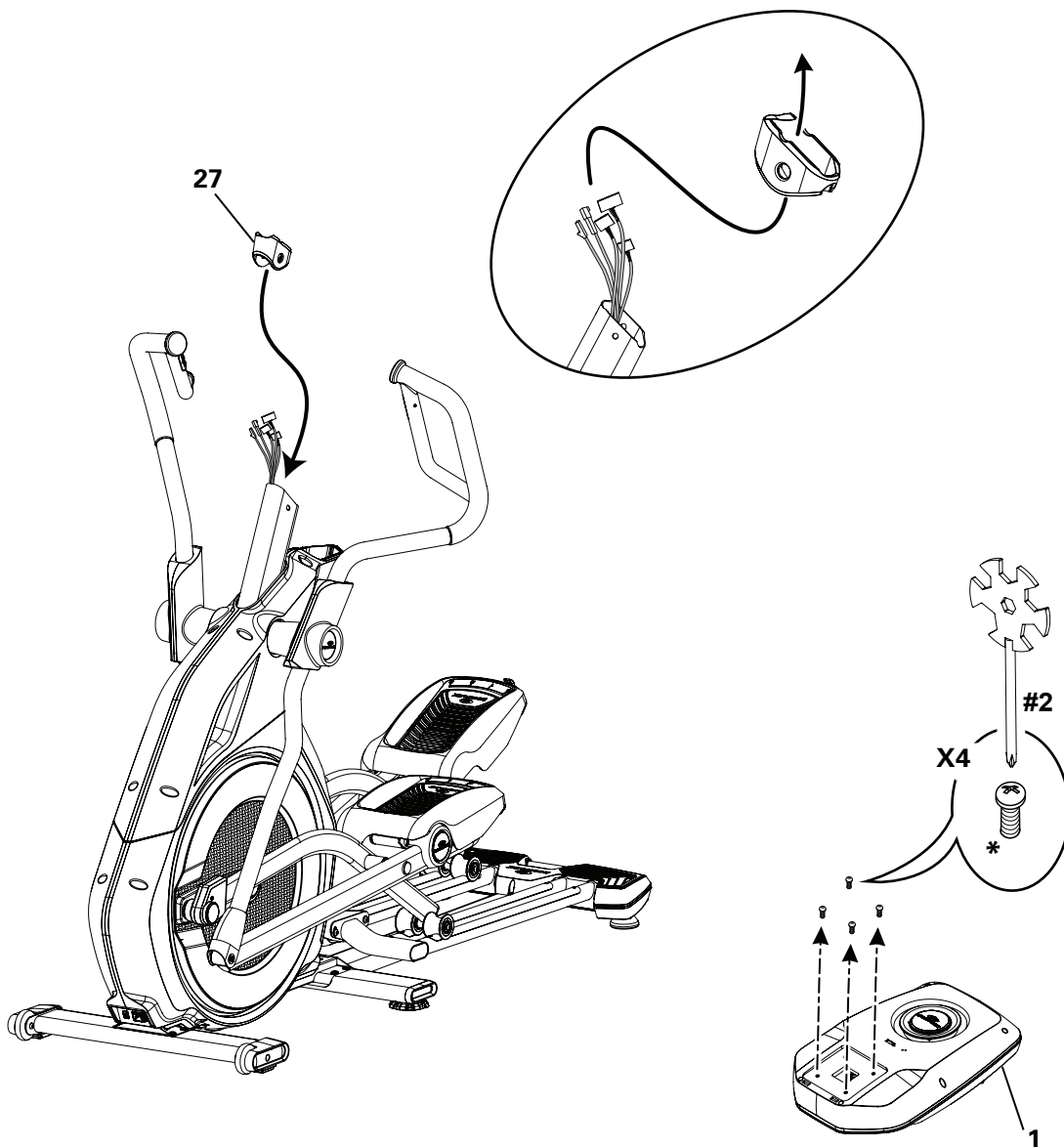

11. Route Cables through Static Handlebar and Attach to Console

Note: Do not crimp the Cables. Connect the Heart Rate Cables from the Console and the Static Handlebar.

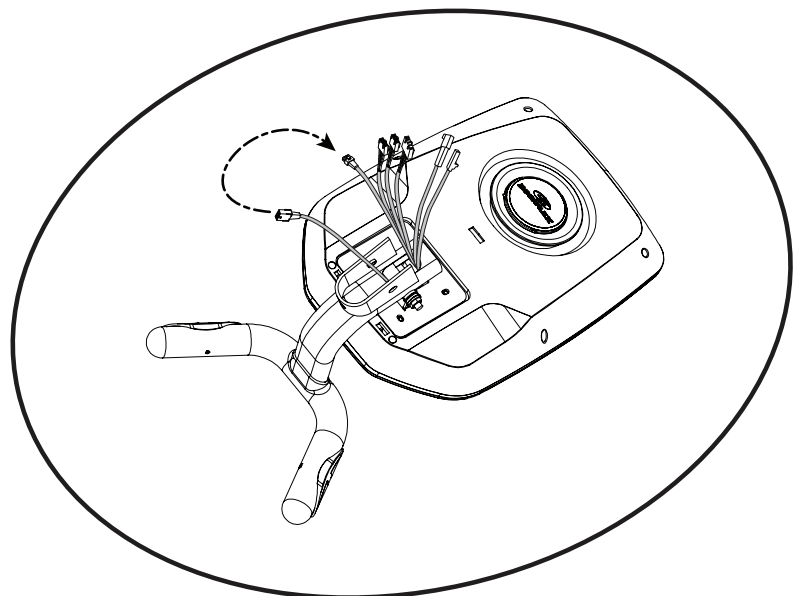
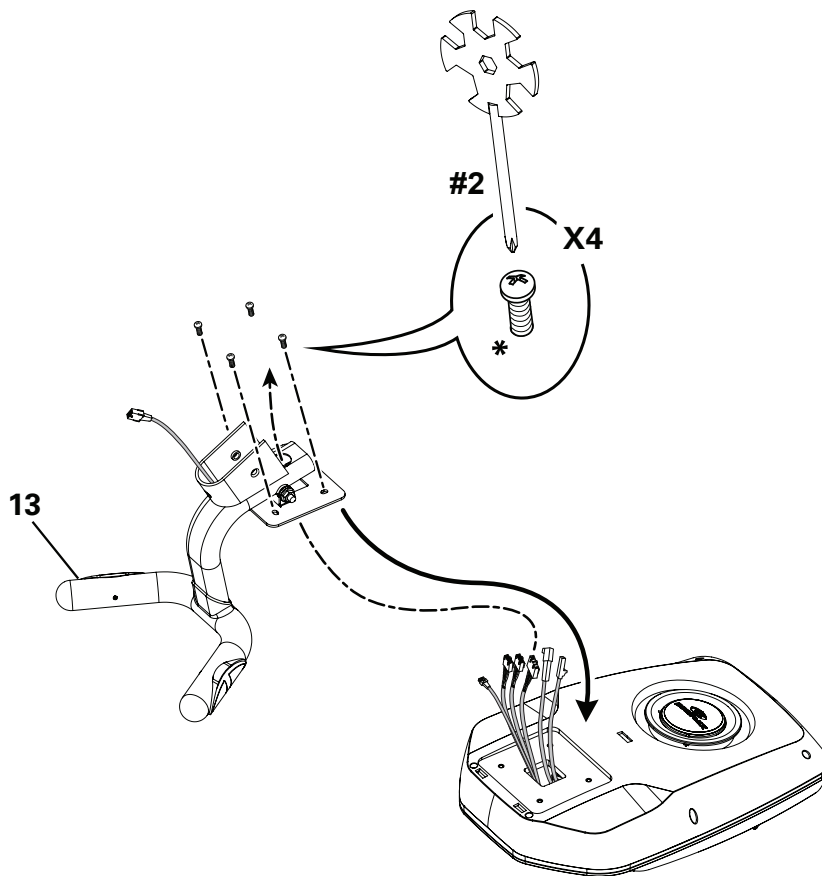

12. Connect the Cables and Attach the Console Mast Collar and Console / Static Handlebar Assembly

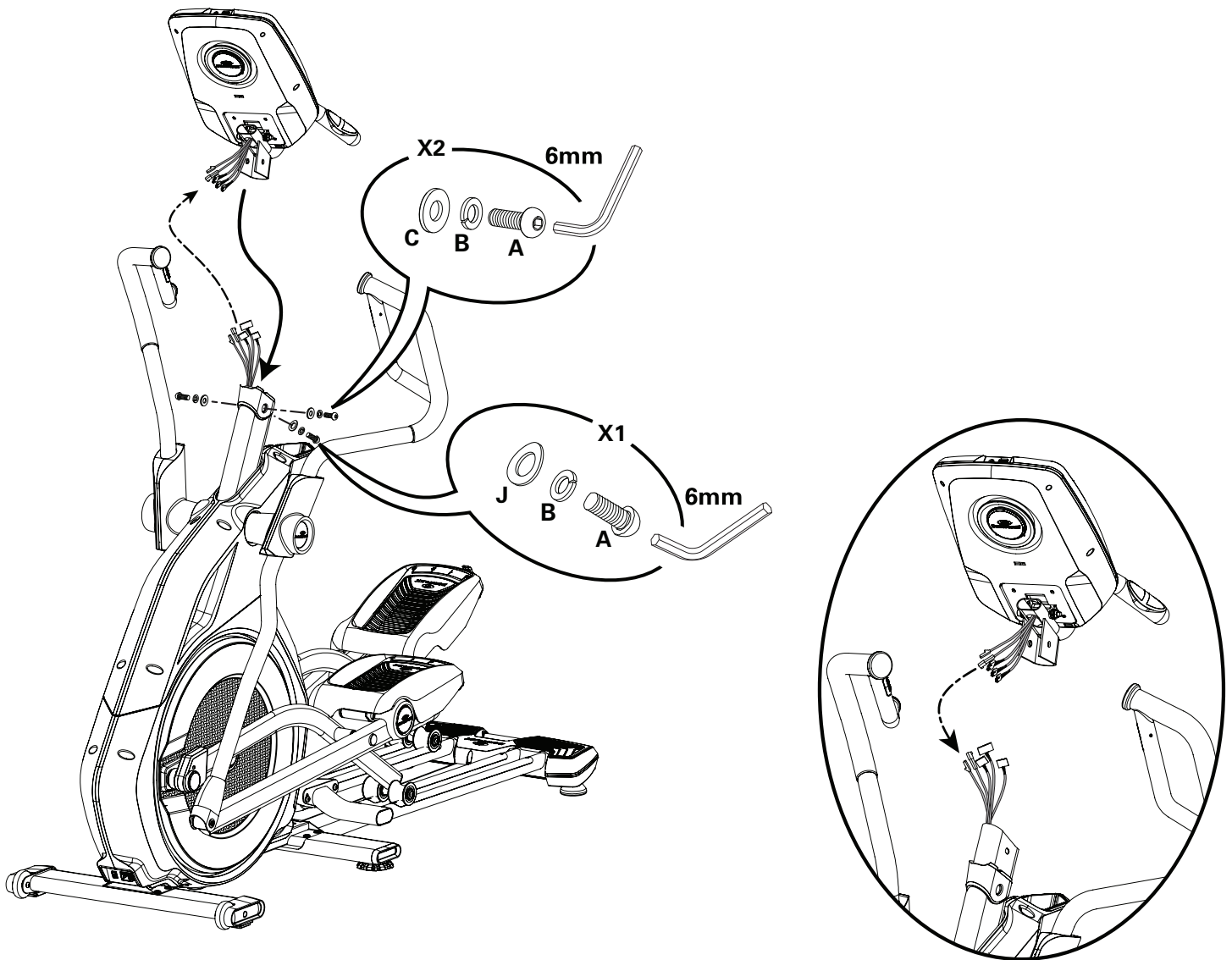

13. Set the Console Angle and Attach the Console Shroud to Frame Assembly

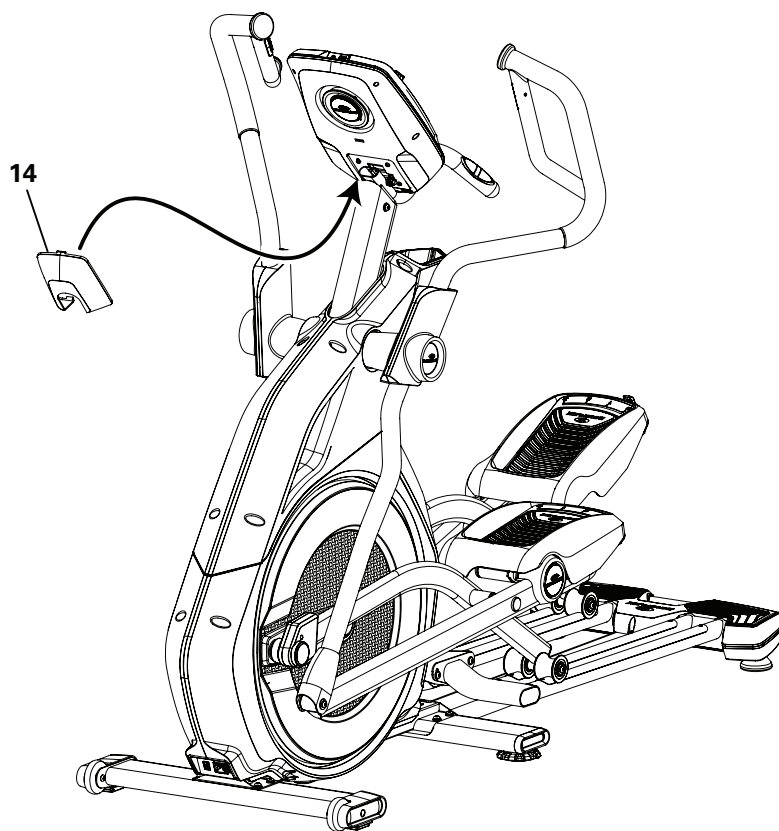
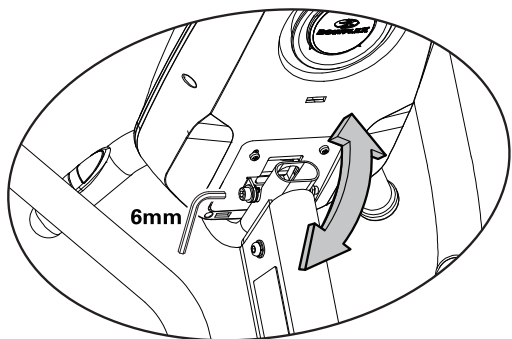

14. Connect Power Cord to Frame Assembly

Note: This fitness machine is designed to plug directly into a properly wired and grounded three prong 120V outlet. If you connect the machine to an outlet with GFI (ground fault interrupt) or AFCI (arc fault circuit interrupt), machine operation can cause the circuit to trip.

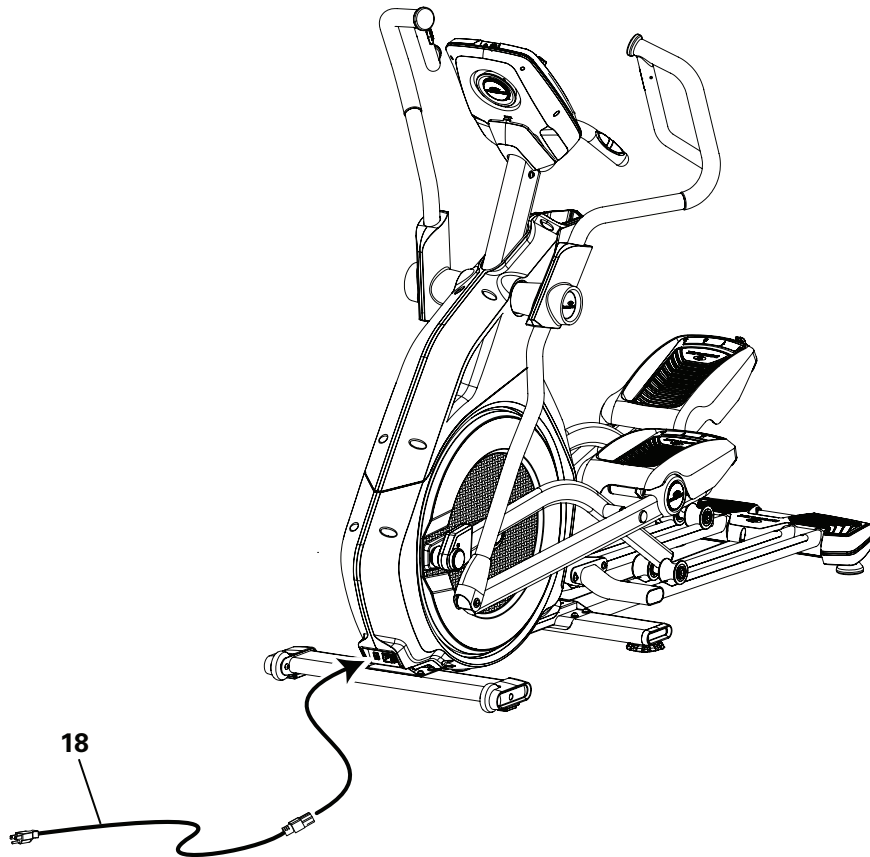

15. Final Inspection

Inspect your machine to ensure that all fasteners are tight and components are properly assembled. Inspect Pedals to confirm that the Pedal Suspension option is set to the same for both Pedals.

Note: Remove any protective covers from the face of the Console. Remove the plastic scratch guard strips from Rails. Apply silicone lubricant to a cloth and wipe the Rails to eliminate roller noise.



! Silicone lubricant is not intended for human consumption. Keep out of reach of children. Store in a safe place.

Be sure to record the serial number in the field provided at the front of this manual.

! Do not use until the machine has been fully assembled and inspected for correct performance in accordance with the Owner's Manual.

Adjustments

Moving Your Machine

The fitness machine weighs approximately 263 lbs (119 kg) when fully assembled and requires caution when being moved. Use the Transport Handle found under the rear of the machine to move it. To get access to the Transport Handle, turn the Levelers until you have sufficient clearance between the machine and floor.

Your machine can be rolled on the transport wheels to a new location. Lower your machine slowly into its new location without injury to your head or fingers.

⚠ Do not use the handlebars, Console Mast, or the Console to lift or move the machine. Injury to you or damage to the machine can occur.

The machine may be moved by one or more persons depending on their physical abilities and capacities. Make sure that you and others are all physically fit and able to move the machine safely.

Place the machine on a clean, hard, level surface, free from unwanted material or other objects that may hamper your ability to move freely. A rubber mat should be used below the machine to prevent the release of static electricity and protect your flooring.

To prevent unsupervised operation of the machine always turn the power switch to Off and disconnect the power cord from the wall outlet and machine power input. Place the power cord in a secure location.

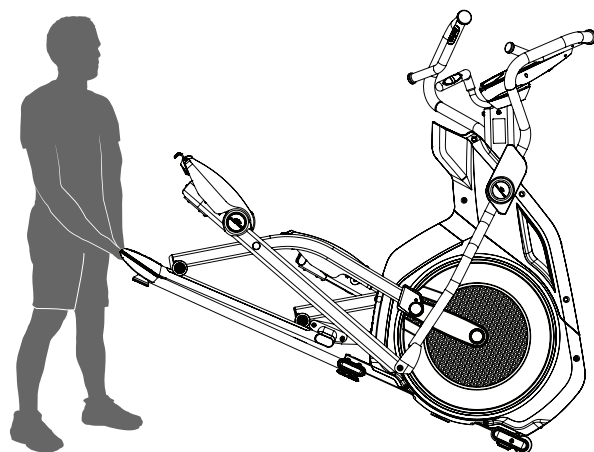

Leveling the Machine

The machine needs to be leveled if your workout area is uneven or if the Rail Assembly is slightly off the floor. To adjust:

1. Place the machine in your workout area.
2. Safely stand on the back of the Rail Assembly for approximately 20 seconds.
3. Step off the machine.
4. Loosen the locking nuts and adjust the levelers until they all contact the floor.

⚠ Do not adjust the levelers to such a height that they detach or unscrew from the machine. Injury to you or damage to the machine can occur.

5. Adjust until the machine is level. Tighten the locking nuts.

Make sure the machine is level and stable before you exercise.

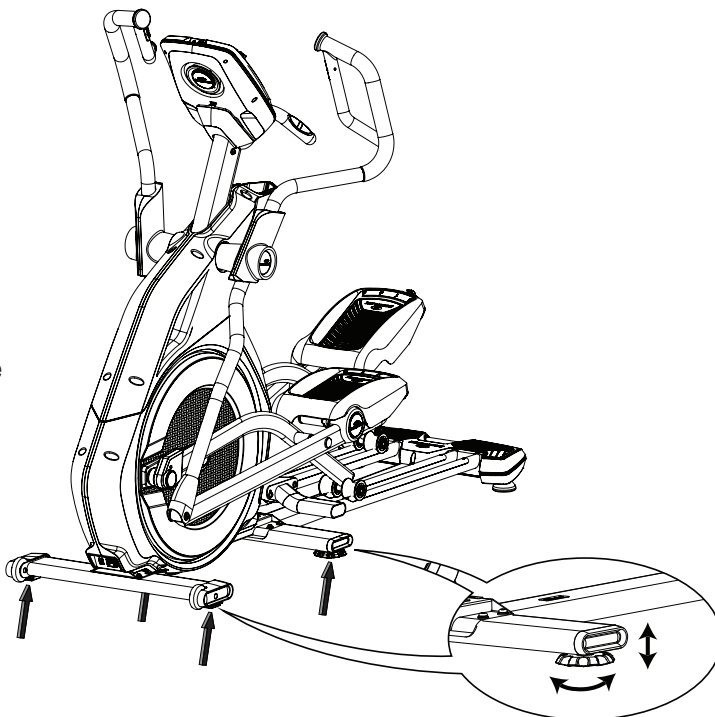

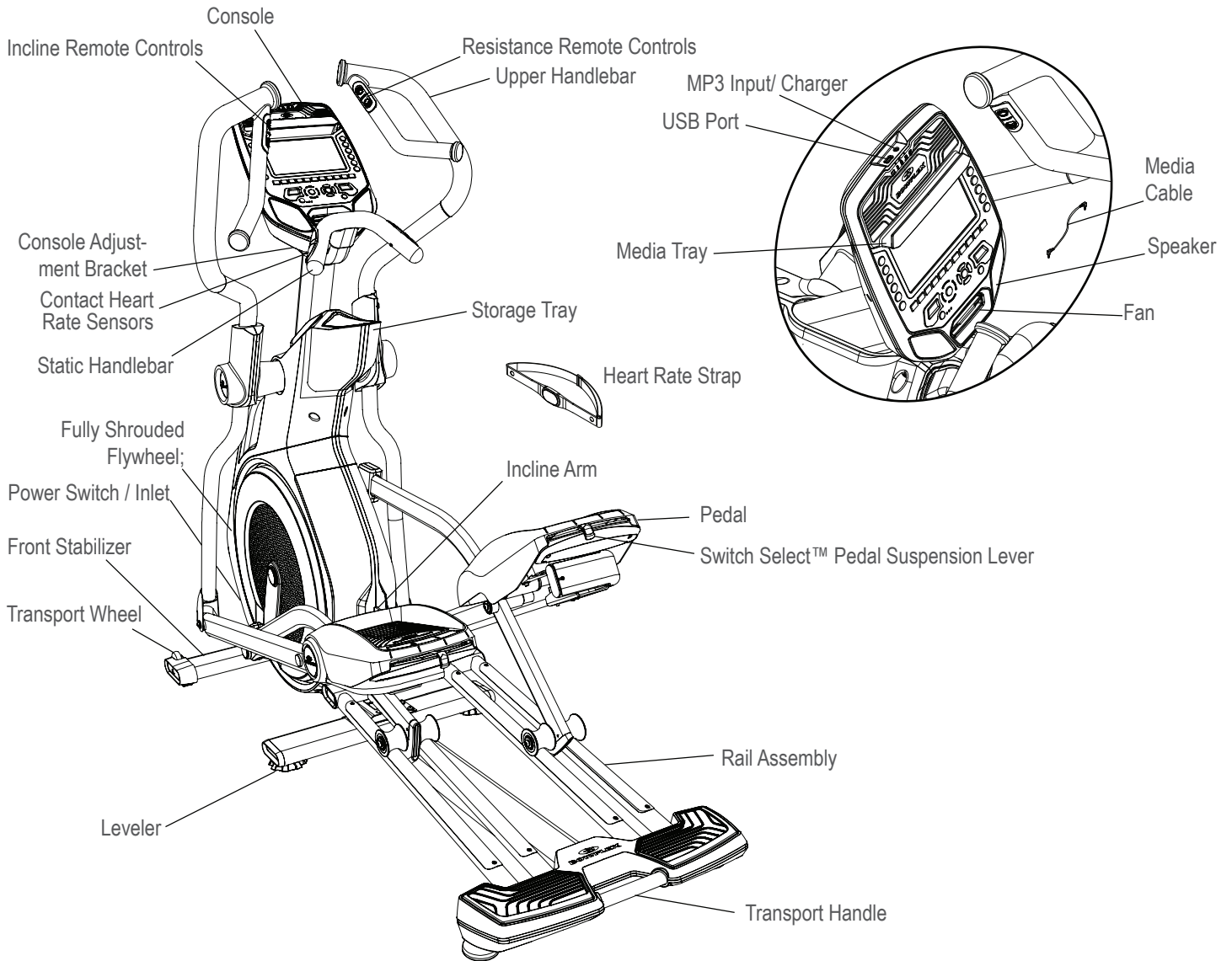

⚠ WARNING

Use the values calculated or measured by the machine's computer for reference purposes only. The heart rate displayed is an approximation and should be used for reference only. Over exercising may result in serious injury or death. If you feel faint stop exercising immediately.

Console

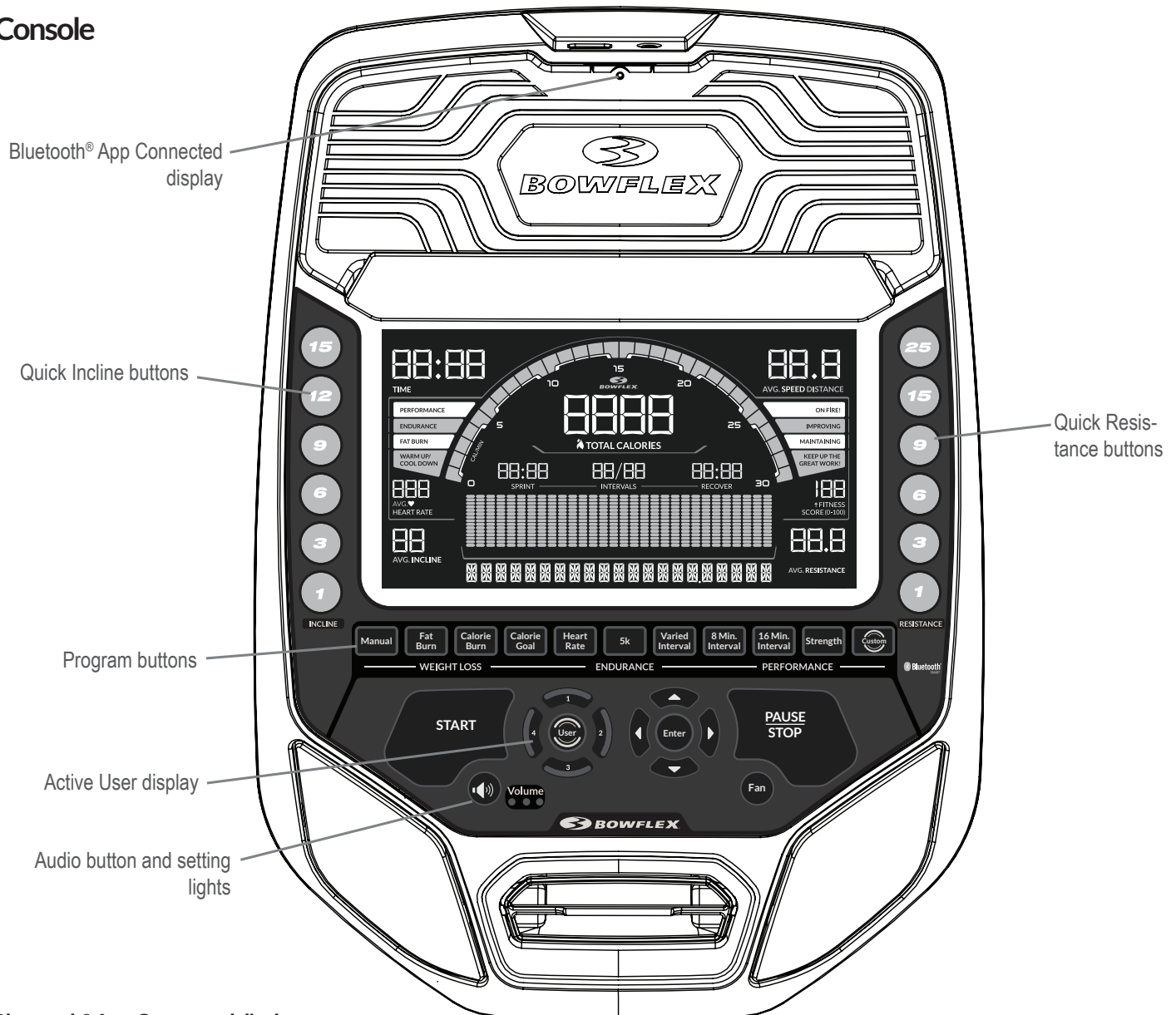

Bluetooth® App Connected display

Display shows when the machine is paired with the App.

Quick Incline buttons

Quickly shifts the incline of the Rail Assembly.

Active User display

The Active User display shows the selected user profile. A user profile is always selected. From a power up, the last User will be the default User.

Note: For more accurate calorie count, be sure to edit your User Profile.

User button

Push to select the desired User Profile, push and hold for 3 seconds to edit the selected User Profile.

Increase (▲)/Decrease (▼) buttons

The Increase / Decrease buttons change a value, or move through options. A button will light up to indicate it is an available option.

Enter button

Confirms information or a selection.

Left (◀)/Right (▶) buttons

Push to shift the currently active segment. A button will light up to indicate it is an available option.

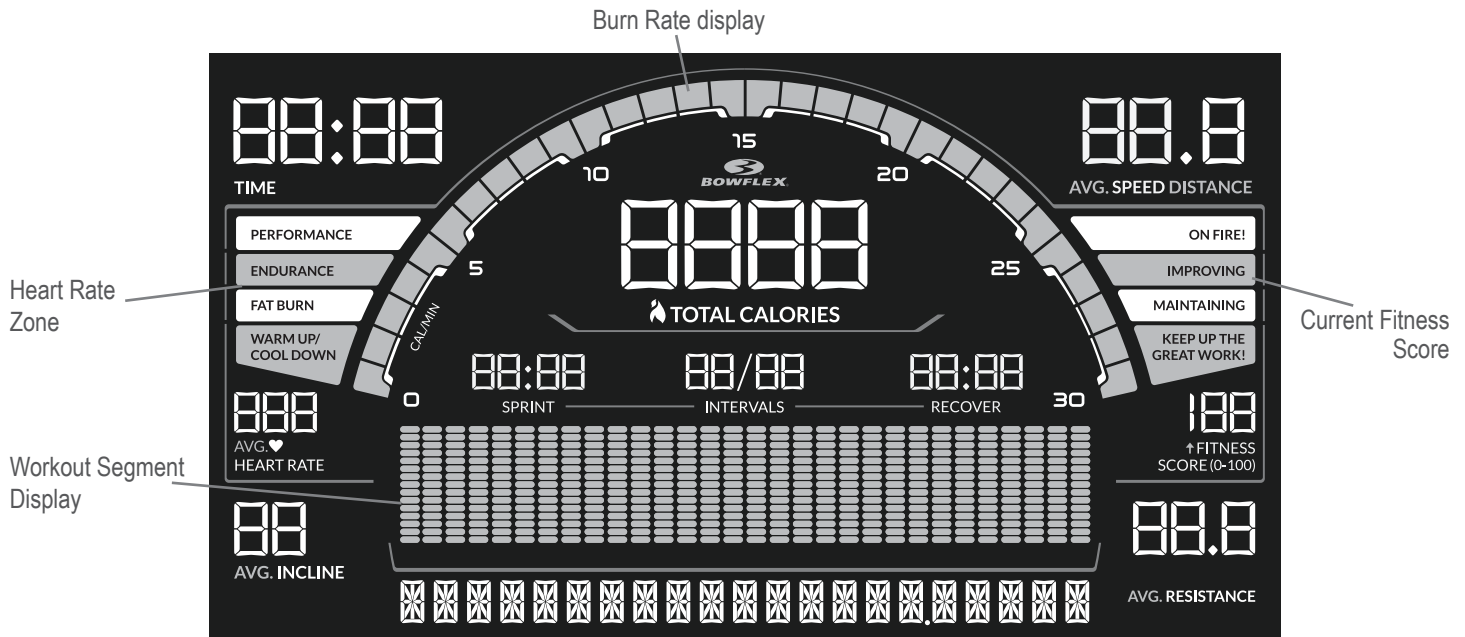

Quick Resistance buttons

Quickly shifts the resistance level for the machine to the desired setting.

Program buttons

Push to select one of the workout Programs. The illuminated light around the button shows the currently selected program. A Workout Program is always selected.

START button

Push to start the currently selected workout Program, or resume a paused workout.

STOP/PAUSE button

Push to pause a workout, exit the User Profile or Machine Settings mode, or end a paused workout.

Volume button and indicator lights

The Volume button sets the sound level of the Console, and the indicator lights show the current setting; low (1 LED), medium (2 LEDs), high (3 LEDs), or off (no LEDs).

Fan button

Controls 4-speed fan (off, low, medium, high).

Console Display

Time display

Counts in minutes and seconds the total time of your workout (e.g. 15:42 minutes). The maximum time for a workout is 59:99.

Burn Rate display

The Burn Rate display shows the rate of calories burned for a minute at the current workout levels.

Distance display

The Distance display shows your workout distance in miles or kilometers based on the user setting. Miles is the default setting.

Speed display

The Speed display shows your current speed in miles (MI) or kilometers (KM) per hour to one decimal (e.g. 3.4 MI). MI is the default setting.

Heart Rate Zone display

During a workout, the Heart Rate Zone displays the current Heart Rate Zone based on the age of the selected user.

Warm-Up/Cool Down: 1-59% of maximum heart rate, Fat Burn: 60-69%, Endurance: 70-79%, Performance: 80% and higher.

Heart Rate display

The Heart Rate display shows your heart beats per minute. The heart icon will flash when acquiring the rate. With a stable reading, the icon will be shown as solid.



The heart rate displayed is an approximation and should be used for reference only.

Total Calories display

The Total Calories display counts your total calories. The maximum value for calories during a workout is 9999.

Sprint display

During an Interval workout, the Sprint display shows the remaining time of the Sprint segment of the current Interval. Each Interval has a Sprint and a Recover segment. Sprint is the high Intensity segment of an Interval workout.

Intervals display

During an Interval workout, the Intervals display show the currently active Interval and the total number of Intervals for the workout. Each Interval has a Sprint and a Recover workout segment.

Recover display

The reduced workout segment of an Interval workout, counting down until the next Sprint segment.

Fitness Score Zone display

The display shows the current Fitness Score Zone for the selected User. At the end of a workout, if the Fitness Score has increased, an upward arrow icon will be displayed to show the increase in the score.

Note: This display is blank during the workout.

Fitness Score Display

The Fitness Score Display shows the current Fitness Score of the selected User Profile.

Incline display

The Incline display shows the current incline setting for the Rail Assembly.

Workout Segment display

The Workout Segment display shows the course profile of the workout program. A course profile has 30 columns with 15 segments. The segments show changes of resistance over the workout. The more intense the resistance setting, the higher the number of segments. The flashing column shows your location in the workout.

Resistance display

The Resistance display shows the current resistance level in the workout.

Remote Incline and Resistance Controls

The Remote Incline and Resistance Controls are located on the Upper Handlebar Arms. The incline and resistance can be controlled from these controls. The buttons on the left Upper Handlebar includes an Incline Increase button (▲) and an Incline Decrease (▼) button. The controls on the right Upper Handlebar includes a Resistance Increase button (▲) and a Resistance Decrease (▼) button.



Do not push these buttons when grabbing onto the Upper Handlebar Arms.

Switch Select™ Pedal Suspension Technology

The pedals are equipped with the Switch Select™ Pedal Suspension Technology which adjusts the angle and impact resistance of the pedals. Adjustment of the pedals may adapt the same workout to affect different muscle groups. The heel areas of the pedals have a 10 degree range of vertical motion. The adjustment lever can set the firmness of the action according to the weight of the user.

Bluetooth® Connectivity with the “Bowflex Results Series™” Fitness App

This fitness machine is equipped with Bluetooth® connectivity and can wirelessly sync with the “Bowflex Results Series™” Fitness App on supported devices. The Software App syncs with your fitness machine to track total calories burned, time, distance, and more. Records and stores every workout for quick reference. Plus, it automatically syncs your workout data to Bowflex Connect™, MyFitnessPal®, and Under Armour® Connected Fitness to make hitting your daily calorie goal easier than ever! Track your results and share with friends and family.

1. Download the free Software App, named the “Bowflex Results Series™” Fitness App. The software app is available on iTunes® and Google Play™.

Note: For a complete list of supported devices, review the software app on iTunes® or Google Play™.

2. Follow the instructions on the Software App to sync your device to your exercise machine.

To upload your workout file to the Bowflex Connect™ website, and then MyFitnessPal® and Under Armour® Connected Fitness:

1. Select the Options tab in the upper left corner of the Software App, and click on “Settings”.
2. Select the “Bowflex Connect” option. Sign in to your account or create a new account. To create a new account, click on the “Create New Account” and follow the instructions.
3. To sync your workouts, click on the “Bowflex Connect” option, and then the “OK” button.

Note: The Bowflex Connect™ website will automatically sync your workouts after the initial syncing.

4. To sync your workout data from your Bowflex Connect™ account with MyFitnessPal® or Under Armour® Connected Fitness, click on the desired program and login with your information.

Note: The Bowflex Connect™ website will automatically sync your workouts after the initial syncing.

USB Charging

If a USB Device is attached to the USB Port, the Port will attempt to charge the Device. The power supplied from the USB Port may not be enough to operate the Device and charge it at the same time.

Remote Heart Rate Monitor

Monitoring your Heart Rate is one of the best procedures to control the intensity of your exercise. The Console reads the telemetry HR signals from the Heart Rate Chest Strap Transmitter that operates in the 4.5kHz - 5.5kHz range.

Note: The heart rate chest strap must be an uncoded heart rate strap from Polar Electro or an uncoded POLAR® compatible model. (Coded POLAR® heart rate straps such as POLAR® OwnCode® chest straps will not work with this equipment.).

! If you have a pacemaker or other implanted electronic device, consult your doctor before using a wireless chest strap or other telemetric heart rate monitor.

Chest Strap

Using the provided heart rate transmitter chest strap lets you monitor your heart rate at any time during your workout.

! Consult a physician before you start an exercise program. Stop exercising if you feel pain or tightness in your chest, become short of breath, or feel faint. Contact your doctor before you use the machine again. The heart rate displayed is an approximation and should be used for reference only.

To put on your chest strap:

1. Secure the strap around your chest just below the chest muscles.
2. Lift the transmitter off your chest and moisten the two Grooved Electrode Areas on the back.
3. Check that the wet electrode areas are firmly against your skin.

The transmitter will send your heart rate to the machine's receiver and display your estimated Beats Per Minute (BPM).

Always remove the transmitter before you clean the chest strap. Clean the chest strap regularly with mild soap and water, and thoroughly dry it. Residual sweat and moisture may keep the transmitter active and drain the battery in the transmitter. Dry and wipe clean the transmitter after each use.

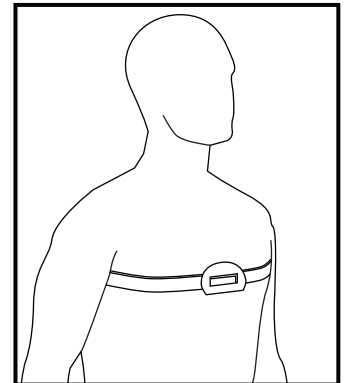

Note: Do not use abrasives or chemicals such as steel wool or alcohol when you clean the chest strap, as they can damage the electrodes permanently.

If the Console does not display a heart rate value, the transmitter may be at fault. Check that the textured contact areas on the chest strap are making contact with your skin. You may need to lightly wet the contact areas. Check that the curve of the transmitter is oriented upward. If no signal appears or you need further assistance, contact Customer Care.

! Before discarding a chest strap, remove the battery. Dispose of in accordance with local regulations and/or at approved recycling centers.

Contact Heart Rate Sensors

Contact Heart Rate (CHR) sensors send your heart rate signals to the Console. The CHR sensors are the stainless steel parts of the Handlebars. To use, put your hands comfortably around the sensors. Be sure that your hands touch both the top and the bottom of the sensors. Hold firm, but not too tight or loose. Both hands must make contact with the sensors for the Console to detect a pulse. After the Console detects four stable pulse signals, your initial pulse rate will be shown.

Once the Console has your initial heart rate, do not move or shift your hands for 10 to 15 seconds. The Console will now validate the heart rate. Many factors influence the ability of the sensors to detect your heart rate signal:

- Movement of the upper body muscles (including arms) produces an electrical signal (muscle artifact) that can interfere with pulse detection. Slight hand movement while in contact with the sensors can also produce interference.
- Calluses and hand lotion may act as an insulating layer to reduce the signal strength.
- Some Electrocardiogram (EKG) signals generated by individuals are not strong enough to be detected by the sensors.
- The proximity of other electronic machines can generate interference.

If your heart rate signal ever seems erratic after validation, wipe off your hands and the sensors and try again.



The heart rate displayed is an approximation and should be used for reference only.

Before discarding a chest strap, remove the battery. Dispose of in accordance with local regulations and/or at approved recycling centers.

Heart Rate Calculations

Your maximum heart rate usually decreases from 220 Beats Per Minute (BPM) in childhood to approximately 160 BPM by age 60. This fall in heart rate is usually linear, decreasing by approximately one BPM for each year. There is no indication that training influences the decrease in maximum heart rate. Individuals of the same age could have different maximum heart rates. It is more accurate to find this value by getting a stress test than by using an age related formula.

Your at rest heart rate is influenced by endurance training. The typical adult has an at rest heart rate of approximately 72 BPM, where as highly trained runners may have readings of 40 BPM or lower.

The Heart Rate table is an estimate of what Heart Rate Zone (HRZ) is effective to burn fat and improve your cardiovascular system. Physical conditions vary, therefore your individual HRZ could be several beats higher or lower than what is shown.

The most efficient procedure to burn fat during exercise is to start at a slow pace and gradually increase your intensity until your heart rate reaches between 60 – 85% of your maximum heart rate. Continue at that pace, keeping your heart rate in that target zone for over 20 minutes. The longer you maintain your target heart rate, the more fat your body will burn.

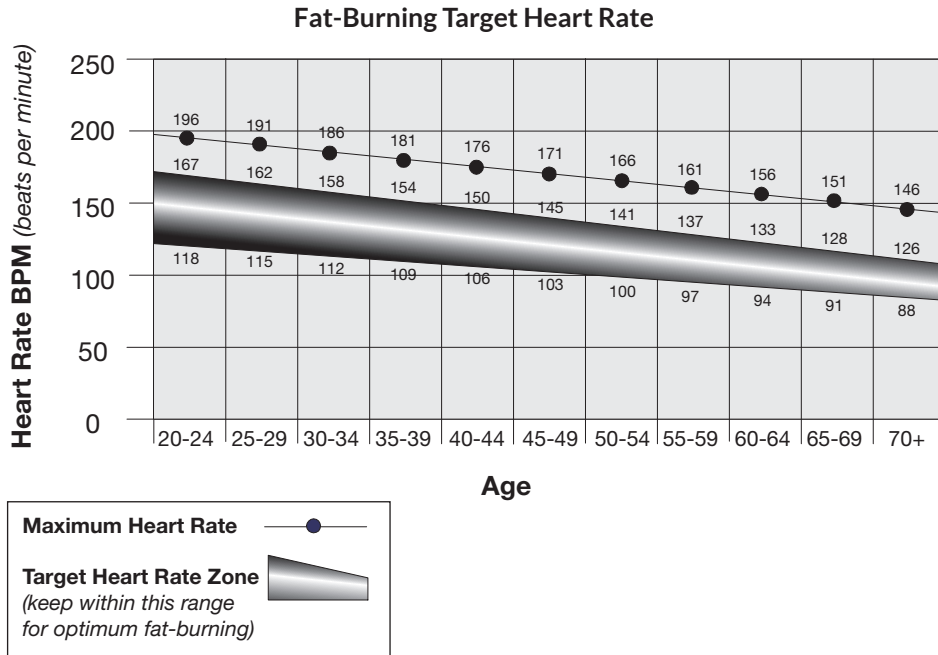

The graph is a brief guideline, describing the generally suggested target heart rates based on age. As noted above, your optimal target rate may be higher or lower. Consult your physician for your individual target heart rate zone.

Note: As with all exercises and fitness regimens, always use your best judgment when you increase your exercise time or intensity.

Fitness Basics

Frequency

To maintain good health, lose weight and improve your cardiovascular endurance, try and use the Bowflex® fitness machine a minimum of 3 times per week, 30 minutes each day.

If you are new to exercise (or returning to a regular exercise program), and you are unable to comfortably complete 30 minutes of continuous exercise at one time, just do 5 – 10 minutes, and gradually increase your workout time until you can reach 30 minutes total.

If your schedule is busy, and you are unable to fit 30 minutes of continuous exercise into your day, try accumulating 30 minutes by doing multiple shorter workouts on the same day. For example, 15 minutes in the morning and 15 minutes in the evening.

For best results, combine your Bowflex® fitness machine workouts with a strength training program using a Bowflex® home gym or Bowflex® Select-Tech® dumbbells, and follow the Bowflex™ Body Weight Loss Guide that is included in this manual.

Consistency

Busy work schedules, family obligations and daily chores can make it difficult to fit regular exercise into your life. Try these tips to increase your chances of success:

Schedule your workouts the same way you schedule meetings or appointments. Select specific days and times each week, and try not to change your workout times.

Make a commitment to a family member, friend or spouse, and encourage each other to stay on track each week. Leave messages with friendly reminders to be consistent, and keep each other accountable.

Make your workouts more interesting by alternating between steady state (single-speed) workouts and interval training (varied speed) workouts. The Bowflex® fitness machine is even more fun when you add this kind of variety.

Apparel

It is important to wear appropriate, safe and comfortable footwear and clothing when using the Bowflex® fitness machine, including:

- Rubber-soled athletic walking or running shoes.
- Exercise clothing that allows you to move freely, and keep comfortably cool.
- Athletic support that provides stability and comfort.

 **Do not wear loose clothing or jewelry. This machine contains moving parts. Do not put fingers, feet, or other objects into moving parts of the exercise equipment.**

Always wear rubber soled athletic shoes when you use this machine. Do not use the machine with bare feet or only wearing socks.

Warm-Up*

Before you use your Bowflex® fitness machine, consider doing these dynamic warm-up stretches, which will help prepare your body for the workout:

* Source: Blahnik, Jay. *Full-Body Flexibility, 2nd Edition*. Champaign, IL: Human Kinetics, 2010. HumanKinetics.com

Dynamic Knee Hug

Stand with the feet together. Bring one knee forward and up toward the chest. Place the hands around the shin and pull the knee into the chest. Release the stretch by putting the foot on the floor. Each repetition of the sequence should take 1 to 3 seconds. Repeat as a continuous, controlled, fluid sequence 10 or 20 times. Repeat the stretch with the other leg.

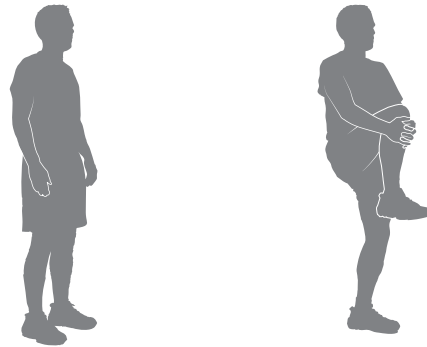

Dynamic Knee Bend

Stand with the feet together. Raise the heel of one foot toward the gluteals. Release the stretch by putting the foot on the floor. Each repetition of the sequence should take 1 to 3 seconds. Repeat as a continuous, controlled, fluid sequence 10 or 20 times. Repeat the stretch with the other leg.

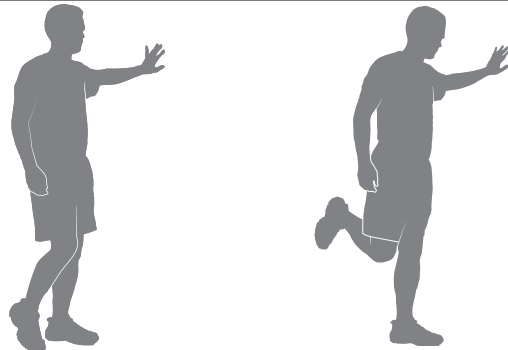

Dynamic Knee Kick

Stand tall and hold one leg up with the hands at hip height, keeping the knee bent. Hold onto a wall for balance with one hand, if necessary. Straighten the knee as far as comfortably possible. Release the stretch by bending the knee. Each repetition of the sequence should take 1 to 3 seconds. Repeat as a continuous, controlled, fluid sequence 10 or 20 times. Repeat the stretch with the other leg.

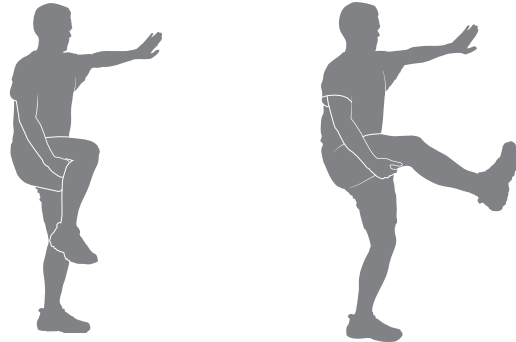

Dynamic Twist

Stand with the feet shoulder-width apart. Bend the elbows; hold the arms out to the sides. Twist the upper body to one side and then the other side as far as comfortably possible. Each repetition of the sequence should take 1 to 3 seconds. Repeat as a continuous, controlled, fluid sequence 10 or 20 times.

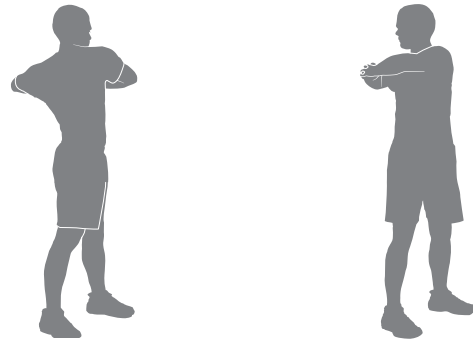

Dynamic Bent Knee Heel Press

Stand with one foot forward and one foot back, hip-width apart and feet facing forward. Bend both knees putting weight on the back heel. Release the stretch by returning to the start position. Each repetition of the sequence should take 1 to 3 seconds. Repeat as a continuous, controlled, fluid sequence 10 or 20 times. Repeat the stretch with the other leg. Touch a wall or hold onto something for balance, if necessary.

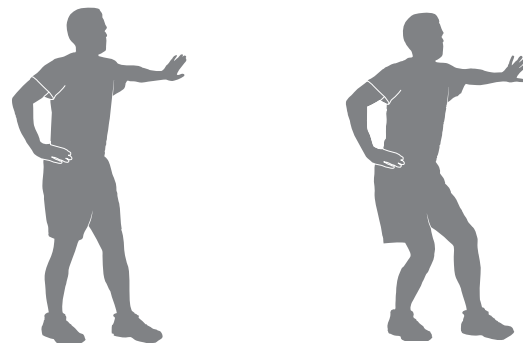

Dynamic Side Reach

Stand with the feet apart, the knees slightly bent and the arms at the sides of the body. Reach with one hand above the head and lean over to the opposite side. Release the stretch by returning to the start position. Then reach with the other hand to the opposite side. Use the other arm to support the body weight on the thigh, if necessary. Each repetition of the sequence should take 1 to 3 seconds. Repeat as a continuous, controlled, fluid sequence 10 or 20 times.

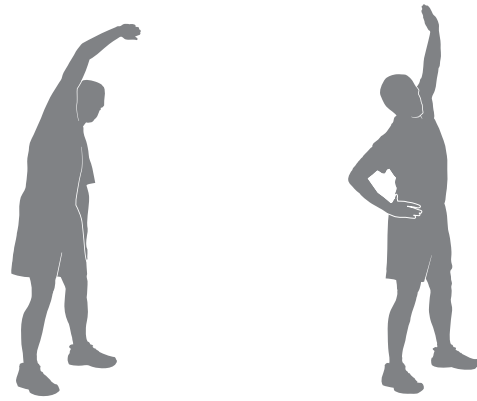

Workouts

Follow these guidelines to ease yourself into a weekly exercise regimen. Use your judgment and/or the advice of your physician or health care professional to find the intensity and level of your workouts.

⚠ Consult a physician before you start an exercise program. Stop exercising if you feel pain or tightness in your chest, become short of breath, or feel faint. Contact your doctor before you use the machine again. Use the values calculated or measured by the machine's computer for reference purposes only.

Steady State and Interval Training are 2 types of workouts you can do on your Bowflex® fitness machine:

Steady State workouts

A Steady State workout involves slowly increasing your workout speed to a challenging, but comfortable speed you can hold for most of your workout. For example, holding a 3.0 MPH pace for the entire workout, except during the warm-up and cool-down. Steady State workouts help you build exercise confidence, stamina and endurance, and are essential to a well-rounded cardiovascular training program.

Interval Training workouts

An Interval Training workout involves adjusting your speed faster and slower for specific lengths of time to raise and lower your breathing rate, heart rate and calorie burn. Here is a sample Interval Training workout:

- 7 minutes at a slow, easy, comfortable speed.
- 1 minute at a more challenging speed that is approximately 50% faster.
- 7 minutes at a slow, easy, comfortable speed.
- 1 minute at a more challenging speed that is approximately 2x faster.
- 7 minutes at a slow, easy, comfortable speed.
- 1 minute at a more challenging speed that is approximately 50% faster.
- 6 minutes at a slow, easy, comfortable speed.

Interval Training workouts provide variety, maximize calorie burn and improve fitness.

The Bowflex® fitness machine is designed to cushion your joints and muscles, and both Steady State and Interval Training workouts should feel more comfortable than walking or running outside on a hard surface or a treadmill.

Workout Schedule

Here is a beginner, intermediate and advanced sample workout schedule. Use the workout schedule that reflects your current fitness level. With each of these sample workout schedules, do not move on to the next week until the current week feels easier and comfortable.

Beginner	Week 1	Week 2	Week 3	Week 4	Week 5
Workout 1	Steady State	Steady State	Steady State	Interval Training	Interval Training
Workout 2	Steady State	Steady State	Interval Training	Steady State	Steady State
Workout 3	Steady State	Steady State	Steady State	Interval Training	Interval Training

Intermediate	Week 1	Week 2	Week 3	Week 4	Week 5
Workout 1	Steady State	Steady State	Interval Training	Steady State	Interval Training
Workout 2	Steady State	Interval Training	Steady State	Interval Training	Steady State
Workout 3	Steady State	Steady State	Interval Training	Steady State	Interval Training

Advanced	Week 1	Week 2	Week 3	Week 4	Week 5
Workout 1	Steady State	Interval Training	Interval Training	Interval Training	Interval Training
Workout 2	Interval Training	Steady State	Steady State	Steady State	Interval Training
Workout 3	Steady State	Interval Training	Interval Training	Interval Training	Interval Training

Cool-Down *

When you are done using your Bowflex® fitness machine, consider doing these relaxing stretches, which will help your body recover from the work-out and make you more flexible:

Lying Leg Raise

Lie on the floor face up with the legs slightly bent. Lift one leg up toward the ceiling, keeping the knee straight. Place the hands (or a strap) around the thigh and move the leg closer to the head. Hold the stretch for 10 to 30 seconds. Repeat the stretch on the other leg. Keep the head on the floor and do not round the spine.

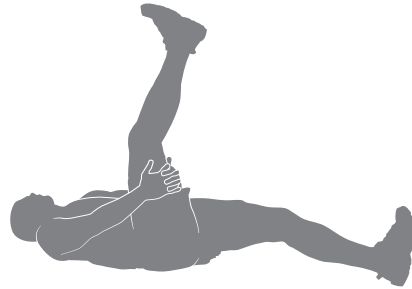

Side Lying Knee Bend

Lie on the floor on one side of the body and rest the head on the lower arm. Bend the top knee and hold the ankle with the same-side hand, then pull the heel toward the gluteals. Hold the stretch for 10 to 30 seconds. Lie on the other side and repeat the stretch with the other leg. Remember to hold the knees close together.

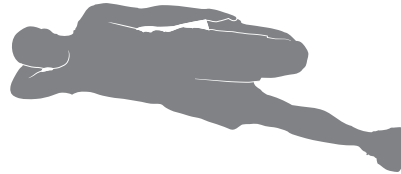

Lying Figure Four

Lie on the floor face up with the legs bent. Place one foot across the thigh of the opposite leg in the figure four position. Reach for the leg on the floor and pull it toward the chest. Hold the stretch for 10 to 30 seconds. Repeat the stretch with the other leg. Keep the head on the floor.

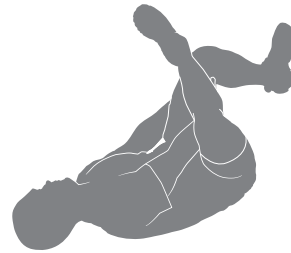

Seated Twist

Sit on the floor and extend the legs straight out in front of the body with the knees slightly bent. Place one hand on the floor behind the body and the other hand across the thigh. Twist the upper body as far as comfortably possible to one side. Hold the stretch for 10 to 30 seconds. Repeat the stretch on the other side.

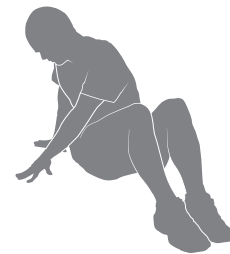

Seated Figure Four

Sit on the floor and extend one leg straight out in front of the body. Place the foot of the other leg across the thigh in the figure four position. Move the chest toward the legs, pivoting at the hip. Hold the stretch for 10 to 30 seconds. Repeat on the other leg. Use the arms to support the back.



* Source: Blahnik, Jay. *Full-Body Flexibility, 2nd Edition*. Champaign, IL: Human Kinetics, 2010. HumanKinetics.com

Dynamic Heel Drop

Place the ball of one foot on the edge of a step or staircase. Place the other foot slightly in front. Lower the heel of the back foot as far as comfortably possible, keeping the knee straight. Release the stretch by lifting the heel as high as comfortably possible. Each repetition of the sequence should take 1 to 3 seconds. Repeat as a continuous, controlled, fluid sequence 10 or 20 times. Repeat the stretch with the other leg



Operations

What to Wear

Wear rubber-soled athletic shoes. You will need the appropriate clothes for exercise that allow you to move freely.

How Often Should You Exercise

⚠ Consult a physician before you start an exercise program. Stop exercising if you feel pain or tightness in your chest, become short of breath, or feel faint. Contact your doctor before you use the machine again. Use the values calculated or measured by the machine's computer for reference purposes only. The heart rate displayed on the console is an approximation and should be used for reference only.

- 3 times a week for 30 minutes each day.
- Schedule workouts in advance and try to follow the schedule.
- Consider doing some warm-up stretches, which will help prepare your body, before your workouts.

Adjusting the Pedals

The Pedals are equipped with the Switch Select™ Pedal Suspension Technology which adjusts the angle and impact resistance of the Pedals. Adjustment of the Pedals may adapt the same workout to affect different muscle groups. The adjustment lever can set the angle and firmness of the action according to the weight of the user: 0 is the lowest cushion setting (flat); 1 for under 150 lbs. (68 kg); 2 for 150-225 lbs. (68-102 kg); 3 for over 225 lbs. (102 kg).

Note: It is recommended to adjust both Pedals to the same setting.

⚠ Do not adjust the Pedals when on the machine.

To adjust the Pedal:

1. Tilt the back of the Pedal up.
2. Lift the adjustment lever out of the notch for the current setting and move it to the desired setting. Be sure the lever is engaged in the notch at the new setting.

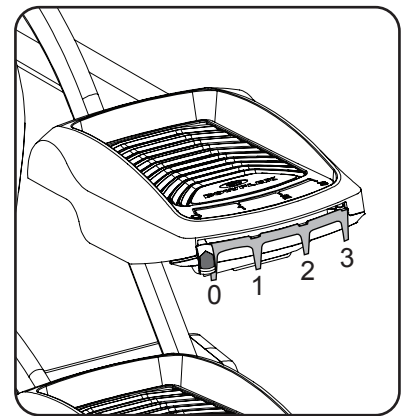

Mounting and Dismounting the Machine

⚠ Care should be used when mounting or dismounting the machine.

Be aware that the Pedals and the Upper Handlebars are connected and when either of these parts move the other does as well. In order to avoid possible serious injury, only grasp the Static Handlebars to steady yourself.

To mount the fitness machine:

1. Move the Pedals until the one nearest you is in the lowest position.
2. Grasp the Static Handlebars under the Console.
3. Steadying yourself with the Static Handlebars, step up onto the lowest Pedal and place your other foot onto the opposite Pedal.

To dismount the fitness machine:

1. Move the Pedal you want to dismount from to the highest position, and bring the machine to a complete stop.



This machine is not equipped with a free-wheel. Pedal speed should be reduced in a controlled manner.

2. Grasp the Static Handlebars under the Console to steady yourself.
3. With your weight on the lowest foot, swing the upper foot off the machine and down onto the floor.
4. Step off of the machine and release your grip from the Static Handlebars.

Power Up / Idle Mode

The Console will enter Power Up mode when initially plugged into a power source and the Power Switch is turned to On.

Shut Off (Sleep Mode)

If the Console does not receive any input for five minutes, it will automatically shut off unless in Demonstration mode.

Push any button to start (wake up) the Console. If your machine is in Demonstration mode, push and hold down for 3 seconds the ENTER and PAUSE/STOP buttons.



To prevent unsupervised operation of the machine always turn the power switch to Off and disconnect the power cord from the wall outlet and machine power input. Place the power cord in a secure location.

Initial Setup / Adjust Date and Time

During the first power-up, the Console will request the date and time for workout tracking. To adjust these settings after the Initial Setup, push and hold the USER and PAUSE/STOP buttons from the Power-Up Mode screen.

1. The Console display shows the SET DATE prompt with the default date setting. The month value will be the currently active values (flashing). Push the Increase (▲) or Decrease (▼) buttons to adjust the currently active value (flashing). Push the Left (◀) or Right (▶) buttons to change which segment is the currently active value (month / day / year).
2. Push the Right button until the next prompt is displayed.
3. The Console display shows the SET TIME prompt with the default time setting. The hour value will be the currently active values (flashing). Push the Increase/Decrease buttons to adjust the currently active value (flashing). Push the Left/Right buttons to change which segment is the currently active value (hour / minute / AM or PM).
4. Push ENTER to set.

The Console goes to the Power-Up Mode screen.

User Profiles

The Console is equipped with 4 User Profiles. Each User Profile has values and options specific to it:

- Age
- Display Units
- Weight
- Screen Brightness
- Erase Workouts

Select a User Profile

Every workout is saved to the User Profile and can be reviewed with the online health tracker at www.bowflexconnect.com. Be sure to select the proper User Profile before starting a workout. The last User that completed a workout will be the default User.

User Profiles are assigned the default values until they are customized by editing. Be sure to edit the User Profile for more accurate calorie and heart rate information.

Edit User Profile

1. From the Power-Up Mode screen, push the User button to select one of the User Profiles.
2. Push and hold down for 3 seconds the User button to edit the User Profile.
3. The Console display shows the Age prompt and the current value.

Push the Increase or Decrease buttons to change the displayed Age value, and push the Enter button to accept the displayed value.

Note: To exit the User Profile options, push the PAUSE/STOP button and the console will go back to the Power-Up Mode screen.

4. To edit the other User data (Display Units, Weight, and Screen Brightness) use the Increase/Decrease buttons to adjust, and push Enter to set each option.

Note: To return to the previous prompt push the Left, or Back, arrow button.

5. The Console display shows the Erase Workouts prompt and the current value ("NO"). To erase all workouts for the selected User, push the Increase (▲) or Decrease (▼) button to change the value to "YES", and push Enter. The Console will now confirm if the User wants to erase the workouts. Use the Increase (▲) or Decrease (▼) button to change the value to "YES", and push Enter. The workouts for this User have been erased.
6. The Console display shows the confirmation screen for two seconds, and then will go to the Power-Up Mode screen

Workout Programs

Each Workout Program has 30 columns allowing for a variety of resistance based workouts.

As each column is done, the Console hides it so only the remaining columns are visible. The user can also manually adjust the incline and resistance values at any time during a workout.

 **During a Profile Program workout, the Console will make an audible beep when the next segment of the workout occurs. Be prepared for changes in Resistance with each segment change.**

If the Sound has been muted, the Console will display the "AUDIO OFF" prompt for a few seconds.

Manual

(Open-ended workout, 1 minute each column)

Note: maximum time is 99:59.

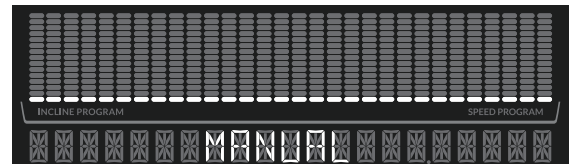

Fat Burn

(30 minutes, 1 minute each column)

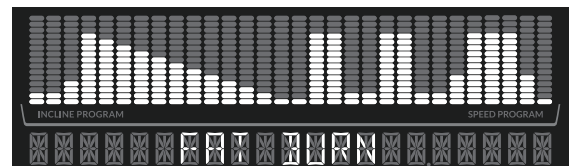

Calorie Burn

(30 minutes, 1 minute each column)

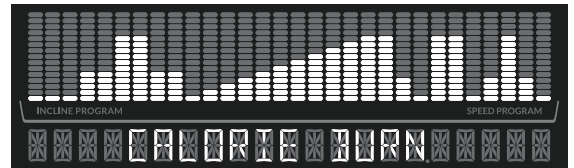

Calorie Goal

(300 calories, 1 minute each column)

Before a workout, push the Increase (▲) or Decrease (▼) buttons to adjust the Goal by 50 calorie increments.

Note: 50 calories is the minimum, 9950 calories is the maximum.

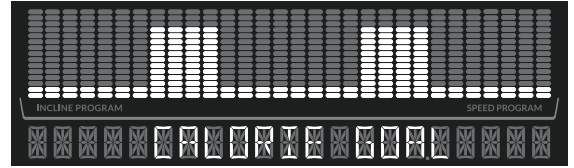

Target Heart Rate (HR)

(30 minutes plus the initial time to raise heart rate into the Endurance heart rate zone)

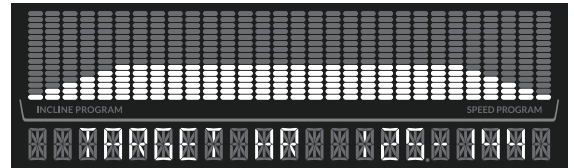

5k Distance

(3.1 miles/ 5 kilometers, 0.1 miles/ 0.17 kilometers per column)

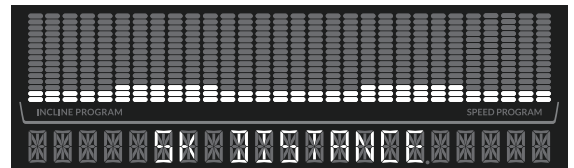

Interval Workout Programs

During an Interval Workout, the workout will switch between an increased intensity, "Sprint" period, to a slower paced, 'catch your breath' time period ("Recover"). This shift will be repeated for the total number of intervals. The Console will count down the time remaining of the active part of the Interval. The Console will also show the current Interval and how many Intervals need to be completed ("01/08" is the first Interval of a total of eight Intervals).

⚠ The "Sprint" period of an Interval Workout is a suggested workout level increase, and should only be followed if your physical fitness level allows.

Varied Interval

(8 intervals, Sprint 30 seconds and Recover 90 seconds for each interval)

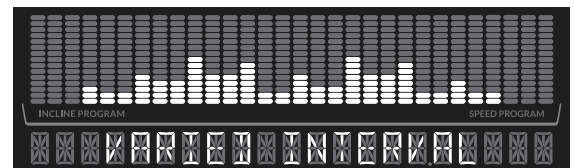

8 Minute Interval

(4 intervals, Sprint 30 seconds and Recover 90 seconds for each interval)

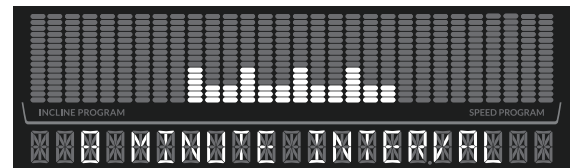

16 Minute Interval

(8 intervals, Sprint 30 seconds and Recover 90 seconds for each interval)

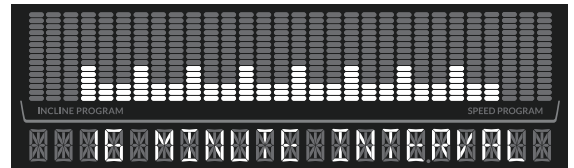

Strength

(30 minutes, 1 minute per column)

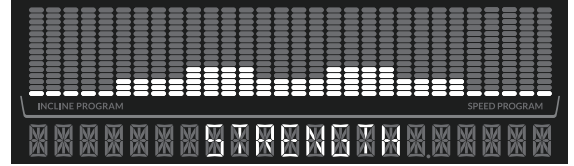

Custom

(Open-ended workout, 1 minute each column or saved workout)

The Custom workout program allows a user to “design as you go”, adjusting the currently active incline segment of each column. When the workout ends, the workout will be assigned to the Custom program.

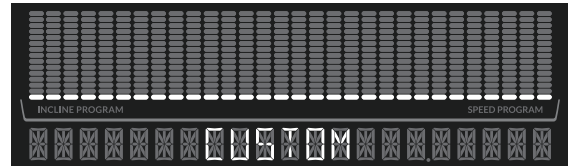

In addition to the “design as you go” option, a completed workout can be saved as the Custom program. All modifications to the workout segments are saved, allowing the same workout to be repeated by selecting the Custom workout.

Note: Once a completed workout is saved as a custom workout, it may be desired to reset the program. To reset the Custom program, push and hold for 3 seconds the Custom button. The Console will display RESET CUSTOM YES. Push Enter to reset, or PAUSE/STOP to exit reset option.

Starting a Workout

To begin a workout:

1. Review the currently selected User Profile. Push the USER button to change the active User Profile.
2. Mount the machine.
3. Push the button for the desired Program Workout. The Console will show the selected workout.
4. Push the START button.

Your workout will begin after the three second, audible beep countdown.

Note: Be sure to read the “Getting Started” section of your manual.

! During a Profile Program workout, the Console will make an audible beep when the next segment of the workout occurs. Be prepared for changes in Resistance with each segment change.

If during a workout the User pushes one of the Program buttons, the Console will ask if they would like to switch workouts. If the User confirms the switch by pressing the ENTER button, the current workout will be ended. The new workout program will be displayed, and will begin when the START button is pushed.

Changing Incline Levels

Push the Incline Level Increase(▲) or Decrease(▼) buttons to change the incline angle of the rail assembly at any time in a workout program. To rapidly change the incline level, push the desired Incline Level Quick Button. The Console will adjust to the selected incline level of the quick button.

! Be sure the area below the machine is clear before lowering. Fully lower the Incline Assembly after each workout.

Exercise on this machine requires coordination and balance. Be sure to anticipate that changes in resistance levels and incline angle of rail assembly can occur during workouts, and be attentive in order to avoid loss of balance and possible injury.

Be sure that the workout space you are utilizing has adequate height clearance, taking into consideration the height of the user and the maximum height of the fully inclined Rail Assembly.

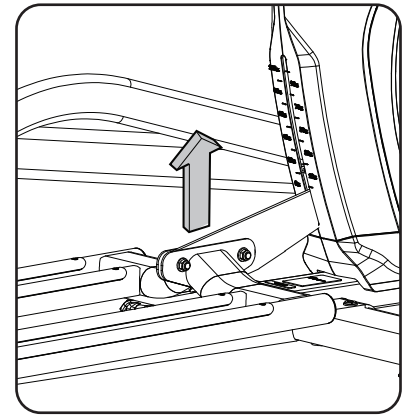

Changing Resistance Levels

Push the Resistance Level Increase(▲) or Decrease(▼) buttons to change the resistance level at any time in a workout program. To rapidly change the resistance level, push the desired Resistance Level Quick Button. The Console will adjust to the selected resistance level of the quick button.

Pausing or Stopping a Workout

1. Stop pedaling and push the PAUSE/STOP button to pause the workout.

Note: If a paused workout is not restarted in 5 minutes, the machine will end the workout and display the workout results.

2. To restart your workout, push the START button or begin pedaling. To end your workout, push PAUSE/STOP again. The Console will display your workout results.
3. The Console will ask if you would like to save the workout as the Custom workout program. Use the Increase or Decrease buttons to modify the option, and push ENTER. After 5 seconds the Console will perform the currently selected option.

! To prevent unsupervised operation of the machine always turn the power switch to Off and disconnect the power cord from the wall outlet and machine power input. Place the power cord in a secure location.

Workout Complete / Results

When the goal of a workout is achieved the Console will display, "Workout Complete," for two seconds. The Console will display the workout results.

Note: If a workout is completed with a USB Flash Drive already inserted, the Console will not export the new Workout Results until the Console exits the Results mode and displays the Power-Up Mode screen. If the Console does not receive any further input after 5 minutes, the Console will shut off.

Customize the Goal for the Calorie Goal Program

The workout goal for the Calorie Goal program can be adjusted. Once changed, the new value will be the default for future Calorie Goal workouts.

1. Push the Calorie Goal button.
2. Push the Increase or Decrease buttons to adjust the displayed calorie goal value.

The default Calorie Goal value is 300 calories and is adjusted in 50 calorie increments. 50 calories is the minimum value for a workout, 9950 calories the maximum value.

3. Push START to set the value and begin a Calorie Goal Program workout.

Target Heart Rate (HR) Program

The Target Heart Rate Program adjusts the incline to get and keep the User in the Endurance heart rate zone. When the heart rate reaches the zone, the 30 minute workout begins.

Note: The console must be able to read the heart rate information from the Heart Rate Monitor for the program to work correctly.

1. Push the Target HR button.
2. The Console shows the TARGET HR values for the selected user. Push OK.

 **Consult a physician before you start an exercise program. Stop exercising if you feel pain or tightness in your chest, become short of breath, or feel faint. Contact your doctor before you use the machine again. Use the values calculated or measured by the machine's computer for reference purposes only. The heart rate displayed on the console is an approximation and should be used for reference only.**

The Target Heart Rate program uses the age of the user profile to set the Endurance heart rate zone values. Review the user profile to be sure the age value is correct.

Note: Be sure to allow time for your heart rate to reach the desired heart rate zone when setting the goal. The Console will display the heart rate value based on the current User settings.

Fitness Score Display

The Fitness Score is based on an estimate of the User's VO2 Max and calorie burn over their last five workouts. VO2 Max estimates are calculated using performance data (time, distance and average heart rate or an estimate of average heart rate if that data is unavailable). VO2 Max is the maximal oxygen consumption of the aerobic physical fitness of the individual, and is a determinant of the endurance capacity of the User during prolonged exercise. (V = Volume, O2 = Oxygen, and Max = maximum rate).

For every workout completed that is longer than 10 minutes or a mile (1.6 km) in distance, the Console will apply those workout values toward your Fitness Score. This value is displayed on the Fitness Score Display area of the Console.

Note: Using a Heart Rate Chest Strap provides the most accurate information to calculate the Fitness Score. A Fitness Score is provided when a minimum of 10 minutes or 1 mile (1.6 km) of distance is done during a workout. If no heart rate is supplied, an approximation based on the User Profile will be used to calculate the score.

The Fitness Score may change only slightly for a User that performs the same length of workout at a similar intensity level. However, if that same User were to increase intensity over the same length of a workout, their score would increase. Since the score is based on VO2 Max (estimated), even a small score increase shows a significant shift in the User's fitness level.

Note: A User's score may drop slightly if fatigue is present. With the proper combination of exercise and rest, a User's Fitness Score will rise in a similar way to their VO2 Max. This will also be reflected in their ability to perform longer or faster workouts. Fitness Scores should only be compared to your previous scores and not to other User Profiles.

User Fitness Level Based on Fitness Score

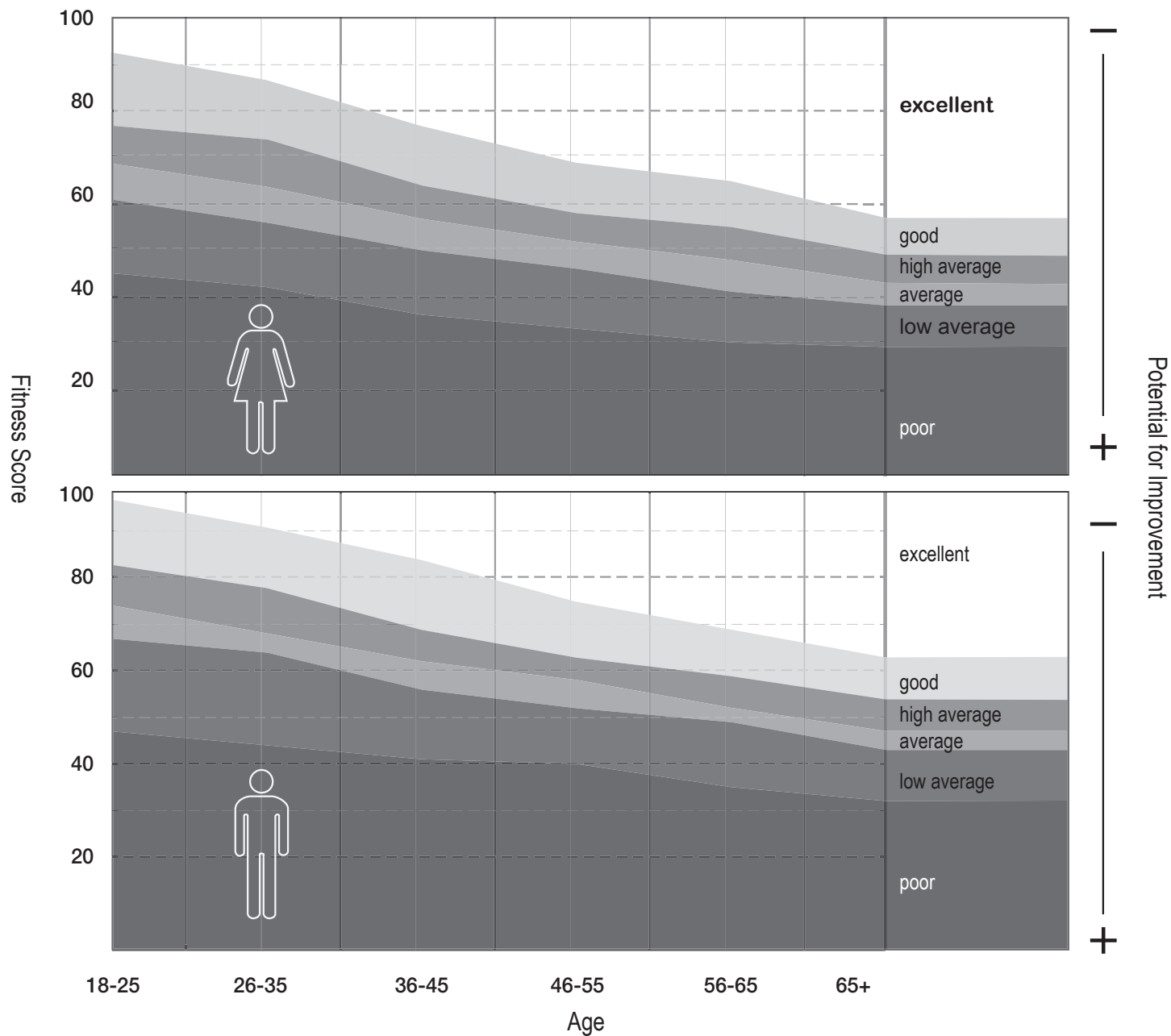

Celebrations

When a Celebration is earned the Console will make an audible sound, display the name of the achievement, and animate the lights in a certain sequence.

- For every 100 calories burned
- Farthest Workout
- Longest (timed) Workout
- Maximized Calories per minute (Cal/Min) rate display

To review achieved Celebrations, export and upload the workout to your account at bowflexconnect.com. Celebrations will be provided with the workout results.

Machine Settings Mode

The Machine Settings Mode lets you view the total run hours for the machine and the current versions of the main systems.

1. Hold down the PAUSE/STOP button and Down button together for 3 seconds while in the Power-Up Mode to access the Machine Settings Mode.

Note: Push PAUSE/STOP to exit the Machine Settings Mode and return to the Power-Up Mode screen.

2. The Console displays the TOTAL HOURS for the machine.
3. Push the Right button to go to the next option.
4. The Console display shows the current Console Firmware Version.
5. Push the Right button to go to the next option.
6. The Console display shows the current Motor Control Board Firmware Version.
7. Push the Right button to go to the next option.
8. The Console display shows the current BLE Version.
9. Push the Right button to go to the next option.
10. The Console displays the DISCONNECT BLE NO prompt.

Note: If you want to disconnect the Bluetooth® transmitter, push the Increase/Decrease buttons to select the “DISCONNECT BLE YES” option, and push Enter. The Console will exit the Machine Settings Mode and return to the Power-Up Mode screen.

11. Push the Right button to go to the next option.
12. The Console displays the VIEW ERROR MSG NO option. This option is for Service Technicians use only.
13. Push the Right button to go to the next option.
14. The Console displays the RESET CONSOLE NO prompt.

Note: If you want to reset the Console to factory settings, push the Increase/Decrease buttons to select the “RESET CONSOLE YES” option, and push Enter. Turn the machine off when the Console displays the “POWER CYCLE NOW” prompt.

15. Push the Right button to exit the Machine Settings Mode and return to the Power-Up Mode screen.

Read all maintenance instructions fully before you start any repair work. In some conditions, an assistant is required to do the necessary tasks.

⚠ Equipment must be regularly examined for damage and repairs. The owner is responsible to make sure that regular maintenance is done. Worn or damaged components must be repaired or replaced immediately. Only manufacturer supplied components can be used to maintain and repair the equipment.

If at any time the Warning labels become loose, unreadable or dislodged, contact Nautilus Customer Service for re-placement labels.

⚠ DANGER To reduce the risk of electrical shock or unsupervised usage of the equipment, always unplug the power cord from the wall outlet and/or the machine and wait 5 minutes before cleaning, maintaining or repairing the machine. Place the power cord in a secure location.

Daily: Before each use, examine the exercise machine for loose, broken, damaged, or worn parts. Do not use if found in this condition. Repair or replace all parts at the first sign of wear or damage. After each workout, use a damp cloth to wipe your machine and Console free of moisture.

Note: Avoid excessive moisture on the Console.

Weekly: Check for smooth roller operation. Wipe the machine to remove dust, dirt, or grime. Clean the rails and surface of the rollers with a damp cloth.
Apply silicone lubricant to a dry cloth and wipe the rails to eliminate roller noise.

⚠ Silicone lubricant is not intended for human consumption. Keep out of reach of children. Store in a safe place.

Note: Do not use petroleum based products.

Monthly or after 20 hours: Make sure all bolts and screws are tight. Tighten if necessary.

NOTICE: If necessary, only use a mild dish soap with a soft cloth to clean the Console. Do not clean with a petroleum based solvent, automotive cleaner, or any product that contains ammonia. Do not clean the Console in direct sunlight or at high temperatures. Be sure to keep the Console free of moisture.

Replace Batteries in Chest Strap

The heart rate (HR) chest strap uses a CR2032 battery.

⚠ Do not perform this procedure outdoors or in moist or wet locations.

1. Using a coin, loosen the slotted cover on the battery bay. Remove the cover and battery.
2. When replacing the battery, insert it in the battery bay with the + symbol facing up.

Note: The chest strap uses CR2032 size batteries.

3. Reinstall the cover on the strap.
4. Discard the old battery. Dispose of in accordance with local regulations and/or at approved recycling centers.
5. Inspect your chest strap to ensure function.

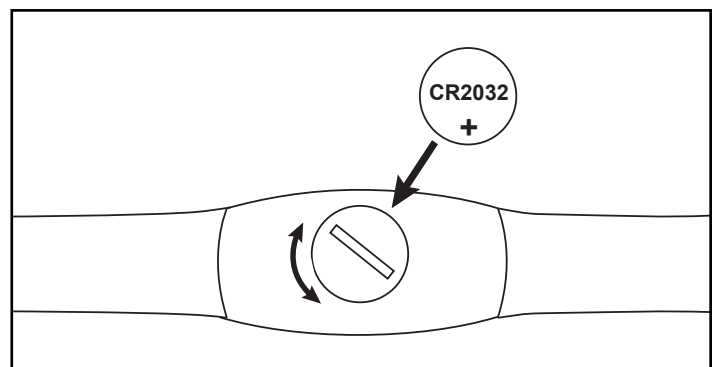

⚠ Do not use until the equipment has been fully assembled and inspected for correct performance in accordance with the Owner's Manual.

Maintenance Parts

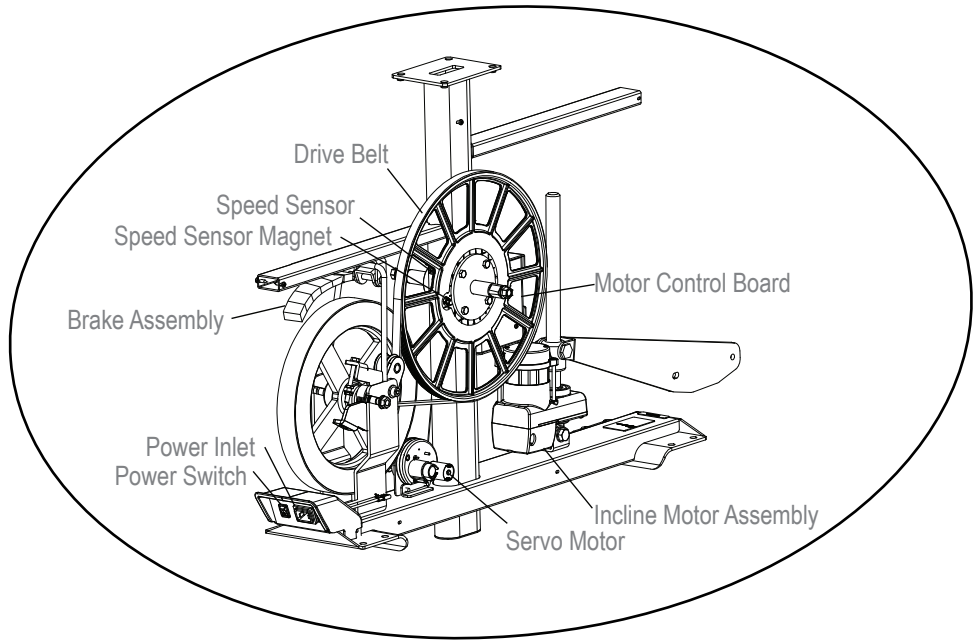
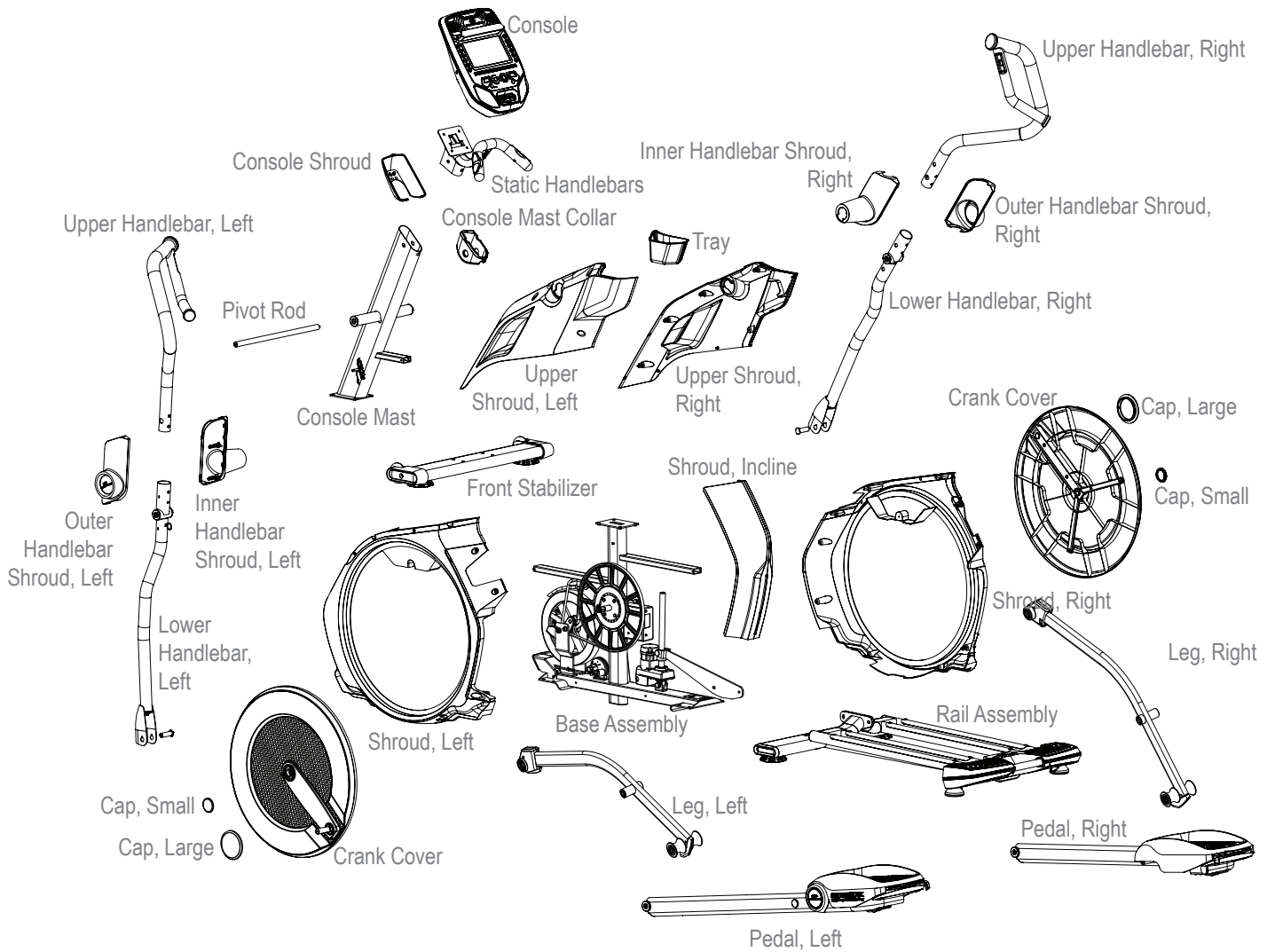

Condition/Problem	Things to Check	Solution
No display/partial display/unit will not turn on	Check electrical (wall) outlet	Make sure unit is plugged into a functioning wall outlet.
	Check connection at front of unit	Connection should be secure and undamaged. Replace adapter or connection at unit if either are damaged.
	Check data cable integrity	All wires in cable should be intact. If any are visibly crimped or cut, replace cable.
	Check data cable connections/orientation	Be sure cable is connected securely and oriented properly. Small latch on connector should line up and snap into place.
	Check console display for damage	Check for visual sign that console display is cracked or otherwise damaged. Replace Console if damaged.
	Console Display	If Console only has partial display and all connections are fine, replace the Console.
		If the above steps do not resolve the problem, contact Customer Care for further assistance.
Unit operates but Contact HR not displayed	HR cable connection at Console	Be sure cable is connected securely to Console.
	HR cable box connection	Be sure cables from handlebars and cable to Console are secure and undamaged.
	Sensor grip	Be sure hands are centered on HR sensors. Hands must be kept still with relatively equal pressure applied to each side.
	Dry or calloused hands	Sensors may have difficulty with dried out or calloused hands. A conductive electrode cream (heart rate cream) can help make better conduct. These are available on the web or at medical or some larger fitness stores.
	Static Handlebar	If tests reveal no other issues, Static Handlebar should be replaced.
Unit operates but Telemetric HR not displayed	Chest Strap (optional)	Strap should be "POLAR®" compatible and uncoded. Make sure strap is directly against skin and contact area is wet.
	Check User Profile	Select the Edit User Profile option for the User Profile. Go to the WIRELESS HR setting and make sure that the current value is set to ON.
	Interference	Try moving unit away from sources of interference (TV, Microwave, etc).
	Replace Chest Strap	If interference is eliminated and HR does not function, replace strap.
	Replace Console	If HR still does not function, replace Console.
Unit operates but Telemetric HR displayed incorrectly	Interference	Make sure that the HR receiver is not blocked by a personal electronic device in the left side of the media tray.
No speed/RPM reading, Console displays "Please Stride" error code	Check data cable integrity	All wires in cable should be intact. If any are cut or crimped, replace cable.
	Check data cable connections/orientation	Be sure cable is connected securely and oriented properly. Small latch on connector should line up and snap into place.
	Check magnet position (requires shroud removal)	Magnet should be in place on pulley.
	Check Speed Sensor (requires shroud removal)	Speed sensor should be aligned with magnet and connected to data cable. Realign sensor if necessary. Replace if there is any damage to the sensor or the connecting wire.

Condition/Problem	Things to Check	Solution
Resistance does not change (machine turns on and operates)	Check Console	Check for visual sign that Console is damaged. Replace Console if damaged.
	Check data cable integrity	All wires in cable should be intact. If any are visibly crimped or cut, replace cable.
	Check data cable connections/orientation	Be sure cable is connected securely and oriented properly. Reseat all connections. Small latch on connector should line up and snap into place.
	Resistance handlebar connection	Be sure cable from right Upper Handlebar and cables to Console are secure and undamaged.
	Check Servo Motor (requires shroud removal)	If magnets move, adjust until they are within the proper range. Replace Servo Motor if not functioning properly.
	MCB (requires shroud removal)	Replace MCB.
		If the above steps do not resolve the problem, contact Customer Care for further assistance.
Incline does not adjust (machine turns on and operates)	Check Console	Check for visual sign that Console is damaged. Replace Console if damaged.
	Incline handlebar connection	Be sure cable from left Upper Handlebar and cables to Console are secure and undamaged.
	Lower and Upper I/O Cables (requires shroud removal)	All wires in the cables should be intact. If any are cut or crimped, replace cable.
	Incline Adjuster Assembly (requires shroud removal)	Be sure Incline Adjuster Assembly is attached to Incline Motor drive screw.
Console shuts off (enters sleep mode) while in use	Check electrical (wall) outlet	Make sure unit is plugged into a functioning wall outlet.
	Check connection at front of unit	Connection should be secure and undamaged. Replace adapter or connection at unit if either are damaged.
	Check data cable integrity	All wires in the cable should be intact. If any are cut or crimped, replace cable.
	Check data cable connections/orientation	Be sure cable is connected securely and oriented properly. Small latch on connector should line up and snap into place.
	Reset machine	Unplug unit from electrical outlet for 3 minutes. Reconnect to outlet.
	Check magnet position (requires shroud removal)	Magnet should be in place on pulley.
	Check Speed Sensor (requires shroud removal)	Speed sensor should be aligned with magnet and connected to data cable. Realign sensor if necessary. Replace if there is any damage to the sensor or the connecting wire.
Fan will not turn on or will not turn off	Check data cable integrity	All wires in cable should be intact. If any are cut or crimped, replace cable.
	Check data cable connections/orientation	Be sure cable is connected securely and oriented properly. Small latch on connector should line up and snap into place.
	Reset machine	Unplug unit from electrical outlet for 3 minutes. Reconnect to outlet.
Fan will not turn on, but Console operates	Check for blockage of fan	Unplug unit from electrical outlet for 5 minutes. Remove material from fan. If necessary, detach the Console to help with removal. Replace the Console if unable to remove blockage.

Condition/Problem	Things to Check	Solution
Unit rocks/does not sit level	Check leveler adjustment	Adjust levelers until machine is level.
	Check surface under unit	Adjustment may not be able to compensate for extremely uneven surfaces. Move machine to level area.
Foot pedals loose/unit difficult to operate	Hardware	Tightly secure all hardware on the Pedal Arms and Handlebar Arms.
Drive train click/tick noise once per full crank revolution	Check crank/pulley assembly	Disconnect left and right foot assemblies and rotate crank. If sound persists, replace crank/pulley assembly. If sound does not come from rotating crank, check foot assemblies and upper/lower handlebars.
	Check foot assemblies, leg assemblies, handlebar assemblies	Manually move foot, leg, and handlebar assemblies to isolate sound. Replace part making sound.
	Check for loose hardware	Tightly secure all hardware on the Stabilizers and the base of the Console Mast.
Knocking sound during machine operation	Check hardware at junction between Lower Handlebar Arm and Pedal	Make sure that the alignment tab on the Pivot Sleeve goes into the slot in the hole. Be sure the Pivot Sleeve extends through the opposite hole in the joint cover.
Squeaking noise that appears a few minutes into a workout and normally will get progressively worse as the workout continues	Bolt that connects the swing arms to the axle running through the console mast	Loosen pivot rod bolt slightly until noise goes away. White lithium grease can also be applied for a temporary fix. Contact Customer Care for assistance.
	Roller squeaking on rail	Apply silicone lubricant to a dry cloth and wipe the rails to eliminate roller noise.
Console continuously displays a different program every 15 seconds	Console is in demonstration mode	Push and hold down the ENTER and PAUSE/ENTER buttons for 3 seconds.
Workout results will not sync with Bluetooth® enabled device	Current console mode	Machine must be in Idle Mode to sync. Push the PAUSE/STOP button until the Power-Up Mode screen is displayed.
	Total time of workout	A workout must be longer than 1 minute to be saved and posted by the Console.
	Fitness machine	Unplug unit from electrical outlet for 5 minutes. Reconnect to outlet.
	Bluetooth® enabled device	Consult your device to be sure that the Bluetooth® wireless feature has been enabled on it.
	Fitness App	Review Specifications of Fitness App and confirm your device is compatible. Contact appsupport@nautilus.com for further assistance.
Workout results not posting to Bowflex Connect™	Fitness App on Bluetooth® enabled device	Workout results transfer from the machine to the App, and then post to the Bowflex Connect™ website. Review account and password for the Bowflex Connect™ website. Contact appsupport@nautilus.com for further assistance.
		Contact appsupport@nautilus.com for further assistance.
Workout results not posting from Bowflex Connect™ to MyFitnessPal® account	Sync accounts	From the Menu icon on the Bowflex Connect™ website, select the Sync to MyFitnessPal®.
	Sync fails	Review account and password for MyFitnessPal®.
		Contact appsupport@nautilus.com for further assistance.

Bowflex™ Body Weight Loss Guide

Introduction and Overview

Welcome to the Bowflex™ Body Weight Loss Guide. This guide is designed to be used with your Bowflex® equipment and will help you:

- Lose weight and get lean
- Improve your health and wellness
- Increase your energy and vitality

⚠ Consult a physician before you start an exercise program or a new health and diet plan. Stop exercising if you feel pain or tightness in your chest, become short of breath, or feel faint. Contact your doctor before you use the machine again. Use the values calculated or measured by the machine's computer for reference purposes only. The heart rate displayed on the console is an approximation and should be used for reference only.

By focusing on the main three elements of the Bowflex™ Body Weight Loss Guide- quality, balance, and consistency- you'll be able to reach and maintain your weight loss and fitness goals for the next six weeks and beyond.

- **Quality** – The emphasis of this plan is on eating more whole foods and getting the most nutrients from your calories as possible. Making the majority of your diet from foods that have a single ingredient (for example fruits, vegetables, fish, lean protein, eggs, beans, nuts, and whole grains) provides the vitamins, minerals, fiber, protein, and healthy fats your body needs.
- **Balance** – Each of the meals and snacks in this guide have a source of fiber or smart carbohydrate, protein, and healthy fat to keep your energy levels consistent throughout the day to fuel your workouts. By having this balance you'll feel fuller longer, which is critical to weight loss success.
- **Consistency** – Getting about the same number of calories each day is important for your metabolism and your mindset. If you overdo it one day, don't try to make up for it the next day by not eating or cutting your calories drastically. Get right back on track by following this guide!

Results & Expectations

Results will vary depending on your age, starting weight, and exercise level but on average you may lose 1-3 lbs per week and experience increased energy levels.

5 Tips for Long-Term Success

1. **Keep a food log** including hunger levels and water intake. Free online food logs and mobile apps are available at www.myfitnesspal.com and www.loseit.com
2. **Weight and/or take measurements weekly** – no more and no less. Weighing weekly rather than daily or every other day is best. You'll track your progress and keep yourself in check without getting discouraged if the scale doesn't move for a few days. And remember, weight is just a number and it's influenced by muscle gain as well as fat loss. Feeling how your clothes fit can often be a better indicator of progress as your body adapts to exercise and nutrition changes.
3. **Measure portions** – To avoid portion creep, use measuring cups and spoons for grains (rice, pasta, cereal), beans, nuts, oils, and dairy. Use the Portion Sizes Guide for other foods.
4. **Plan ahead** – Make a meal plan for the week or log your food a day in advance. Planning sets you up for success, especially for social events and eating out.
5. **Practice your desired long-term habits** – It's easy to justify poor eating choices when you're only focused on the short term. Focus on the long term satisfaction of a slimmer, healthier you rather than the temporary gratification you'll get from splurging.

How to Use this Guide

- **Eat breakfast within 90 minutes of waking up and balance your meals and snacks throughout the day**
 - Don't go longer than 5-6 hours without eating
 - If you're not used to eating breakfast, start out small with a piece of fruit and have something else 1-2 hours later. Your body adapts to not eating breakfast, but as soon as you start eating early in the day and cutting back on dinner portions you'll notice your hunger will increase. This is a good sign your metabolism is working!
- **Mix and match meal options**
 - Select 1 option from the appropriate meal plan (male or female) for breakfast, lunch, and dinner, paying close attention to portion sizes
 - Select 1-2 snack options per day
 - You have the option to substitute one snack for one treat under 150 calories
 - Use the meal plan, sample options, and grocery list to create your own meals for more variety

- You can swap out any type of protein, vegetables or smart carbs for the suggested meal options. For example:
 - Turkey for tuna
 - Any fish or seafood for chicken
 - Cooked vegetables instead of salad
- **Eat your calories**
 - Cut out high calorie beverages like soda, juices, coffee drinks, and alcohol
 - Stick with water, unsweetened tea, and coffee. Aim for a minimum of 64oz (1.9 liters) of water per day to stay well hydrated
- **If you're still hungry after or in between meals:**
 - Have a glass of water and wait 15-20 minutes. Many times we mistake thirst (or even boredom!) for hunger. Wait out the initial urge to eat and sometimes it will pass.
 - If you're still hungry after waiting 15-20 minutes have a snack or mini-meal with fruit, vegetables, and protein.

If your goal is muscle gain or strength:

- Use the same meal plan but increase portion sizes in the same ratios to increase the total number of calories you eat every day. For example, increase portion sizes of protein and smart carbs at meals by 50%. Adding a snack is another option to meet your body's increased calorie needs in order to gain muscle and strength.
- Focus on post-workout nutrition by having one of your snacks within 30 minutes after you complete your workout. Make sure to have a combination of carbohydrates such as fruit with protein (yogurt, milk, or protein powder) to promote muscle growth and recovery. Chocolate milk is also a great option.

Meal Plan Overview

The female meal plan provides about 1400 calories, and the male plan provides about 1600 calories, of high quality nutrition to not only help you lose weight and feel great but get the most out of your calories. The vitamins, minerals, and antioxidants from eating mostly whole foods help support optimal health. These calorie levels will result in healthy weight loss for the majority of people. Keep in mind that everyone's metabolism is very different depending on age, height, weight, activity level, and genetics. Pay close attention to your weight, hunger levels, and energy and adjust your calories if needed.

Follow these guidelines if you're over 55:

- If you're over 55, you need fewer calories because your metabolism slows as you age. Stick with three meals with one optional snack per day.

Follow these guidelines if you're under 25:

- If you're under 25 you may need more calories. Add another snack if you feel low on energy or are extremely hungry.

Breakfast

Breakfast includes a smart carb, fruit, and a source of protein, which will also have fat. With a balance of carbohydrates and fiber from the smart carb and fruit combined with protein and fat, you'll energize your day and help control hunger levels throughout the day.

Snacks

Each snack is a balance of carbohydrates and protein to keep your blood sugar more consistent, which means you won't experience hunger and energy level spikes and drops.

This happens when you have a high carb-only snack like chips, candy, soda, crackers, or pretzels.

Lunch and Dinner

Lunch combines filling fiber from vegetables and smart carbs with a lean, or low-fat, protein. The healthy fat can come either from the protein added during cooking (nuts on a salad) or as a dressing or sauce (such as oil and vinegar salad dressing).

Here's an overview of what an ideal day looks like:
(See Portion Size Guide for proper serving sizes)

Breakfast

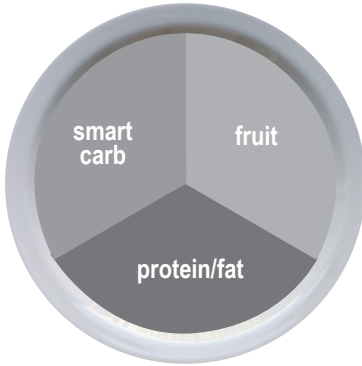

Snack #1

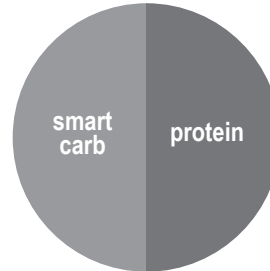

Lunch

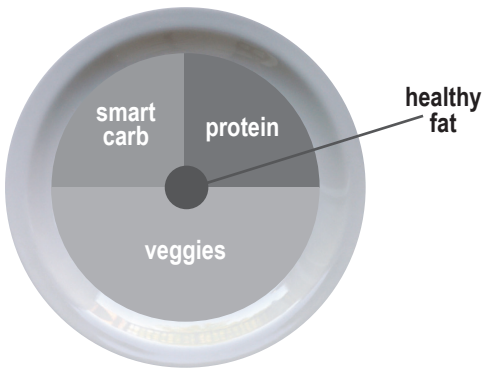

Snack #2

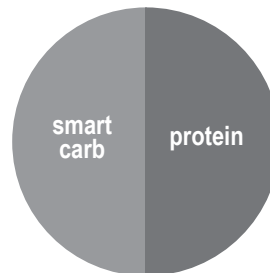

Dinner

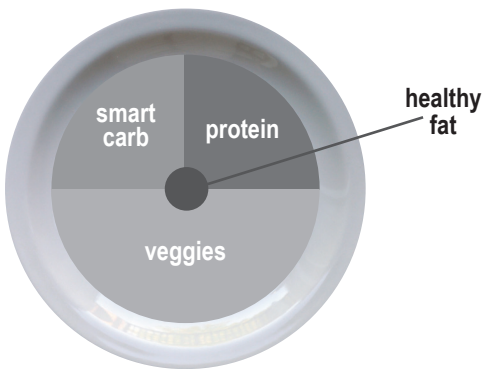

Breakfast Options	Fruit	Smart Carb	Protein/Fat
Fruit and Nut Oatmeal Cook plain oats in water. Top with fruit, nuts, milk, cinnamon, and honey.	Berries or banana	Plain oats (Regular or quick-cook)	Nuts and milk
Egg Muffin Cook egg/s. Toast bread and top with 1 slice of cheese, 1 slice of ham, and tomato.	Tomato	English muffin or sandwich thin	Egg, ham, and cheese
Yogurt Power Parfait Top yogurt with fruit. Sprinkle with 1 serving of nuts, 2-3 tbsp wheat germ, or ground flaxseed, 1 tbsp oats, and cinnamon.	Chopped fruit of your choice	Oats, wheat germ, and ground flaxseed	Plain non-fat Greek yogurt and nuts
On the Go PB & Apple Sandwich Toast bread. Spread on peanut butter, thin slices of ½ an apple, and 1 teaspoon of honey.	Sliced apple	Sandwich thin, bread, or bagel thin	Peanut butter

Lunch & Dinner Options	Lean Protein	Smart Carb	Veggies
Pork Loin, Sweet Potato & Green Beans	Grilled or baked pork loin	Baked Sweet Potato	Green Beans
Chicken Stir Fry Flavor with 2 tablespoon teriyaki sauce	Chicken breast or boneless skinless thigh	Brown or wild rice	Mixed stir fry vegetables (fresh or frozen)
Steak Tacos with Side Salad (3 for males, 2 for females) Top with salsa, cilantro, and sprinkle of shredded cheese	Flank or sirloin steak	Corn tortillas	Salad
Whole Wheat Pasta with Shrimp or Cannellini Beans & Marinara Sauce	Shrimp (frozen or fresh) or cannellini beans	Whole wheat pasta	Steamed broccoli
Bunless Burgers with Oven Fries, Corn, & Salad Grill burgers. Bake sliced potatoes on sprayed cookie sheet for 25-30 minutes @ 425°F.	93% lean ground beef or turkey	Oven baked fries	Corn on the cob + side salad
Tuna & Avocado Wrap with Vegetable Soup Use 3oz of tuna (1 can). Top with lettuce, tomato, avocado, and mustard.	Tuna	High-fiber wrap	Vegetable soup (homemade or low-sodium canned)

Snack Options	
Smart Carb	Protein
1 medium apple	10-15 almonds
Baby carrots	2 tbsp hummus
1 serving of crackers*	1 string cheese
Energy or protein bar with <200 calories*	

*See www.Bowflex.com/Resources for brand recommendations

Optional Treats

You have the choice of replacing Snack #2 with a 100-150 calorie treat. You can have an optional treat every day but for optimal health it is recommended to limit small splurges to 3-4 times per week. Use the approach that works best for you. Here are a few examples:

- ½ cup lowfat ice cream
- 1 small bag of baked potato chips
- 4oz of wine or 12oz light beer
- 3 cups of air-popped or light popcorn

Sample 3 Day Plan

Based on each of the meal options listed above, a typical 3 day plan could look like this:

	Day 1	Day 2	Day 3
Breakfast	Egg muffin	Power yogurt parfait	Fruit + nut oatmeal
Snack 1	Apple with almonds	Nut Thins® + string cheese	Baby carrots and hummus
Lunch	Tuna & avocado wrap with soup	Leftovers from dinner- day 1	Leftovers from dinner- day 2
Optional Snack 2 or Treat	½ cup ice cream bar	Energy bar	100 calorie bag of light popcorn
Dinner	Shrimp pasta	Chicken stir fry	Bunless burgers

Portion Size Guide

Each of the items listed are for one serving

MALE	FEMALE
PROTEIN	
2 eggs 5oz chicken, fish, lean meat, or tofu 2/3 cup beans or lentils* 1 cup greek yogurt* 1.5oz cheese*	1 egg 3oz chicken, fish, or lean meat 1/2 cup beans or lentils* 1/2 cup greek yogurt* 1.5oz cheese*
HEALTHY FAT	
2 Tblspn peanut or nut butter* 2 tspn olive, flax, or walnut oil 1/4 cup of nuts 1/3 medium avocado	1 tblspn peanut or nut butter* 1 tspn olive, flax or walnut oil 1/8 cup or 2 tablespoons of nuts (approx. 15 almonds) 1/4 medium avocado
SMART CARB	
1 cup cooked grains (1/2 cup raw): oats, brown rice, quinoa, pasta 1 medium sweet or regular potato 2 corn tortillas 1 slice of bread (or 2 light slices equaling 120 calories or less) 1 english muffin, sandwich thin, or high-fiber wrap	1/2 cup cooked (1/4 cup raw) grains 1/2 medium sweet potato or regular potato 2 corn tortillas 1 slice of bread (or 2 light slices equaling 120 calories or less) 1 english muffin, sandwich thin, or high-fiber wrap
FRUIT	
1 medium apple, orange, or pear 1 small banana (length of your hand) 1 cup berries or chopped fruit 1/4 cup dried fruit (fresh or frozen is optimal)	
Vegetables* You can have unlimited vegetables except for peas and corn; stick with 1/2 cup serving	
2 cups spinach or lettuce = 2 cupped hands 1 cup raw vegetables 1/2 cup cooked vegetables 6oz low sodium vegetable juice	
OPTIONAL TREATS	
1/2 cup lowfat ice cream 1 small bag of baked potato chips 1oz dark chocolate 4oz of wine or 12oz light beer 3 cups air-popped or light popcorn	

* some foods are a combination of protein and carbs or protein and fat



1 cup = baseball



1/2 cup = lightbulb



1 oz or 2 tbsp = golf ball

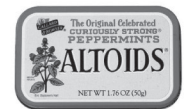

1/4 cup nuts = Altoids tin



3 oz chicken or meat = deck of cards



1 medium potato = computer mouse



1 medium piece of fruit = tennis ball



1 - 1/2 oz cheese = 3 dice

Grocery List

BREAD & GRAINS			
100% whole wheat bread Sprouted grain breads Light or whole wheat english muffins Sandwich or bagel thins Corn or low-carb whole wheat tortillas High-fiber wraps Plain oats: 1 minute or old fashioned Whole grains: brown rice, bulgar, barley, quinoa, couscous	Tips: Look for 100% whole wheat as the first ingredient. Look for 4g of fiber per slice or 5g per 2 slices of light or diet bread. Aim for bread with less than 100 calories per slice.		
DAIRY & DAIRY ALTERNATIVES	CRACKERS, SNACKS & ENERGY BARS		
Plain non-fat greek yogurt Kefir (yogurt like drink) Organic low-fat milk Enriched almond or soy milk Cheese: feta, parmesan, mozzarella, light havarti, provolone, swiss, string cheese, or single serving packages	<table border="1"> <tr> <td> Any unsalted nuts or seeds Air-popped or light popcorn Edamame in the pod </td> <td> Energy bars Crackers Hummus </td> </tr> </table>	Any unsalted nuts or seeds Air-popped or light popcorn Edamame in the pod	Energy bars Crackers Hummus
Any unsalted nuts or seeds Air-popped or light popcorn Edamame in the pod	Energy bars Crackers Hummus		
	Tips: Limit crackers, pretzels, and chips to 2-3 servings per week. Always pair with protein such as hummus, cheese, or nuts. Look for energy bars with less than 200 calories and 20g of sugar and at least 3g of protein and 3g of fiber. Look for crackers with less than 130 calories and 4g or less of fat per serving.		
MEAT, FISH, POULTRY & PROTEIN	FATS & OILS		
Wild game Salmon, halibut, tuna, tilapia, shrimp, catfish, scallops, or crab Pork loin, pork chops, or pork roast Chicken or turkey breast or thighs (no skin) Eggs and 100% egg whites Lean beef: sirloin, chuck, round, tenderloin, 93% lean (organic and grass fed is best) Canned salmon or tuna (in water) Nitrate-free, reduced sodium ham, turkey, chicken, or roast beef lunch-meat Any type of bean, dry or canned low-sodium varieties Tofu and tempeh	Avocado Olive, grapeseed, walnut, sesame, or flaxseed oil Butter/spreads: look for products free of trans fats and partially hydrogenated oils on the ingredient list.		
	Tips: Light olive oil refers to the flavor, not the calorie content. Always measure oil and butter. Even if a fat is considered healthy, it's still very high in calories and portions need to be controlled.		
	DRESSINGS, CONDIMENTS & SAUCES		
Tips: Look for "Choice" or "Select" cuts of meat rather than "Prime". Prime cuts are fattier. Limit intake of highly processed meat and imitation meat products like sausage, bacon, pepperoni, and hot dogs to once a week or less.	Vinegars: rice, wine, balsamic All fresh or dried herbs and spices Mustard Salsa and chili sauce Marinara sauce with no high-fructose corn syrup Lemon and lime juice Bottled minced garlic and ginger Low-sodium soy sauce		
FROZEN FOODS	Tips: Look for products free of MSG, added colors, and high fructose corn syrup. Look for sauces under 50 calories per serving. Avoid cream based sauces and dressings like ranch, bleu cheese, and alfredo.		
All vegetables without sauce All fruit Grains and grain medleys			

All fruits and vegetables, fresh and frozen, are great choices. Since every meal has one or both, your shopping cart should reflect this.

Keep It Going

Tips for continued weight loss and maintaining changes

- **Keep weighing yourself weekly**, even after you've reached your goal weight
- **Continue keeping a food log.** If you have your meal plan well-established, log your food every other week to keep yourself on track. Don't feel like you have to do it every day.
- **Prepare for plateaus.** The scale might not budge for a few weeks or even months after some initial weight loss. This is normal and to be expected. It's the body's natural process for adjusting to your new lower weight. Stay focused on your long-term goal, celebrate your successes and changes, and mix up your workouts to help overcome the plateau.
- **Calorie adjustments for maintaining weight loss.** Once you've reached your goal weight, you can increase your calories 100-200 per day as long as your activity level stays the same
- **Treat yourself.** Have a non-food reward for each goal you hit such as a massage, a new outfit, or an outing with friends and family
- **Use the resources below** to find new recipes, get expert advice, and support to stay motivated

Resources

Downloadable Resources from Bowflex™ Website (www.Bowflex.com/Resources)

- Grocery Shopping List for Fridge (Blank Form)
- 7 Day Meal Planning Form
- Additional Dinner Options
- Pre and Post Workout Fueling Guide

Questions & Support

- Ask questions, post suggestions, and connect with our online Bowflex™ Dietitian on the Bowflex Facebook page

Recipes

- www.wholeliving.com
- www.eatingwell.com
- www.whfoods.org
- www.livebetteramerica.org

Online food logs

- www.myfitnesspal.com
- www.loseit.com

Who Is Covered

This warranty is valid only to the original purchaser and is not transferable or applicable to any other person(s).

What Is Covered

Nautilus, Inc. warrants that this product is free from defects in materials and workmanship, when used for the purpose intended, under normal conditions, and provided it receives proper care and maintenance as described in the Product's Assembly and Owner's manual. This warranty is good only for authentic, original, legitimate machines manufactured by Nautilus, Inc. and sold through an authorized agent and used in the United States or Canada.

Terms

- Frame 15 years
- Mechanical parts 5 years
- Electronics 5 years
- Labor 2 years

(Labor support does not include the installation of replacement parts involved in the initial product assembly and preventative maintenance services. All repairs covered under the labor portion of the warranty must be preauthorized by Nautilus.)

How Nautilus Will Support the Warranty

Throughout the terms of the warranty coverage, Nautilus, Inc. will repair any machine that proves to be defective in materials or workmanship. Nautilus reserves the right to replace the product in the event a repair is not possible. When Nautilus determines replacement is the correct remedy, Nautilus may apply a limited credit reimbursement toward another Nautilus, Inc. brand Product, at our discretion. This reimbursement may be prorated based on length of ownership. Nautilus, Inc. provides repair service within major metropolitan areas. Nautilus, Inc. reserves the right to charge the consumer for travel outside these areas. Nautilus, Inc. is not responsible for dealer labor or maintenance charges beyond the applicable warranty period(s) stated herein. Nautilus, Inc. reserves the right to substitute material, parts or products of equal or better quality if identical materials or products are not available at the time of service under this warranty. Any replacement of the product under the terms of the Warranty in no way extends the original Warranty period. Any limited credit reimbursement may be prorated based on length of ownership. THESE REMEDIES ARE THE EXCLUSIVE AND SOLE REMEDIES FOR ANY BREACH OF WARRANTY.

What You Must Do

- Retain appropriate and acceptable Proof of Purchase.
- Operate, maintain, and inspect the Product as specified in the Product Documentation (Assembly, Owner's Manuals, etc.).
- Product must be used exclusively for the purpose intended.
- Notify Nautilus within 30 days after detecting an issue with the Product.
- Install replacement parts or components in accordance with any Nautilus instructions.
- Perform diagnostic procedures with a trained Nautilus, Inc representative if requested.

What Is Not Covered

- Damage due to abuse, tampering or modification of the Product, failure to properly follow assembly instructions, maintenance instructions, or safety warnings as stated in the Product Documentation (Assembly, Owner's Manuals, etc), damage due to improper storage or the effect of environmental conditions such as moisture or weather, misuse, mishandling, accident, natural disasters, power surges.
- A machine placed or used in a commercial or institutional setting. This includes gyms, corporations, work places, clubs, fitness centers and any public or private entity that has a machine for use by its members, customers, employees or affiliates.
- Damage caused by exceeding maximum user weights as defined in the Product's Owner's manual or warning label.
- Damage due to normal usage and wear and tear.
- This warranty does not extend to any territories or countries outside the United States and Canada.

How to Obtain Service

For Products purchased directly from Nautilus, Inc. contact the Nautilus office listed on the Contacts page of the products Owner's manual. You may be required to return the defective component to a specified address for repair or inspection, at your expense. Standard ground shipping of any warranty replacement parts will be paid by Nautilus, Inc. For products purchased from a retailer, you may be asked to contact your retailer for warranty support.

Exclusions

The preceding warranties are the sole and exclusive express warranties made by Nautilus, Inc. They supersede any prior, contrary or additional representations, whether oral or written. No agent, representative, dealer, person or employee has the authority to alter or increase the obligations or limitations of this warranty. Any implied warranties, including the WARRANTY OF MERCHANTABILITY and any WARRANTY OF FITNESS FOR A PARTICULAR PURPOSE, are limited in duration to the term of the applicable express warranty provided above, whichever is longer. Some states do not allow limitations on how long an implied warranty lasts, so the above limitation may not apply to you.

Limitation of Remedies

EXCEPT AS OTHERWISE REQUIRED BY APPLICABLE LAW, THE PURCHASER'S EXCLUSIVE REMEDY IS LIMITED TO REPAIR OR REPLACEMENT OF ANY COMPONENT DEEMED BY NAUTILUS, INC. TO BE DEFECTIVE UNDER THE TERMS AND CONDITIONS STATED HEREIN. IN NO EVENT WILL NAUTILUS, INC. BE LIABLE FOR ANY SPECIAL, CONSEQUENTIAL, INCIDENTAL, INDIRECT OR ECONOMIC DAMAGES, REGARDLESS OF THE THEORY OF LIABILITY (INCLUDING, WITHOUT LIMITATION, PRODUCT LIABILITY, NEGLIGENCE OR OTHER TORT) OR FOR ANY LOST REVENUE, PROFIT, DATA, PRIVACY OR FOR ANY PUNITIVE DAMAGES ARISING OUT OF OR RELATED TO THE USE OF THE FITNESS MACHINE EVEN IF NAUTILUS, INC. HAS BEEN ADVISED OF THE POSSIBILITY OF SUCH DAMAGES. THIS EXCLUSION AND LIMITATION SHALL APPLY EVEN IF ANY REMEDY FAILS OF ITS ESSENTIAL PURPOSE. SOME STATES DO NOT ALLOW THE EXCLUSION OR LIMITATION OF CONSEQUENTIAL OR INCIDENTAL TYPE DAMAGES SO THE ABOVE LIMITATION MAY NOT APPLY TO YOU.

State Laws

This warranty gives you specific legal rights. You may also have other rights, which vary from state to state.

Expirations

If the warranty has expired, Nautilus, Inc. may assist with replacements or repairs to parts and labor, but there will be a charge for these services. Contact a Nautilus office for information on post-warranty parts and services. Nautilus does not guarantee availability of spare parts after expiration of warranty period.

International Purchases

If you purchased your machine outside of the United States consult your local distributor or dealer for warranty coverage.

