

Special Edition Includes:

Dr. Ellington Darden's
Six Week Fast Fat Loss –
Body Leanness Program



BOWFLEX

CONQUEST



The Bowflex Conquest™ Home Gym Owner's Manual and Fitness Guide

Written By: Tom Purvis RPT, RTS
Registered Physical Therapist
and founder of the
Resistance Training
Specialist Program



Table of Contents

Safety Precautions	3	Arm Exercises:	
Get To Know Your Bowflex Conquest™		Triceps Pushdown	30
Safety Warning labels	4	Single-Arm Pushdown	30
Get To Know Your Bowflex Conquest™		French Press	31
Home Gym	6	Lying Triceps Extension	31
How to Use Your Bowflex Conquest™		Cross Triceps Extension	32
Home Gym	7	Lying 45° Triceps Extension	32
Attaching Cables	11	Seated Triceps Extension	33
Define Your Goals	12	Standing Biceps Curl	33
Warm Up / Cool down	15	Seated Biceps Curl	34
Aerobic Rowing	15	Lying Biceps Curl	34
Chest Exercises:		Seated Wrist Extension	35
Bench Press	16	Standing Wrist Curl	35
Chest Fly	16	Reverse Curl	36
Decline Bench Press	17	Seated Wrist Curl	36
Incline Bench Press	17	Standing Wrist Extension	37
Decline Chest Fly	18	“Rope” Pushdowns	37
Incline Chest Fly	18	Abdominal Exercises:	
Resisted Punch	19	Reverse Crunch	38
Lying Cable Crossover	19	Resisted Reverse Crunch	38
Shoulder Exercises:		Seated (Resisted) Abdominal Crunch	39
Rear Deltoid Rows	20	Seated (Resisted) Oblique Abdominal Crunch	39
Lateral Shoulder Raise	20	Trunk Rotation	40
Seated Shoulder Press	21	Leg Exercises:	
Front Shoulder Raise	21	Squat	40
Shoulder Extension	22	Leg Extension	41
Shoulder Shrug	22	Lying Leg Extension	41
Shoulder Rotator Cuff—Internal	23	Ankle Eversion	42
Shoulder Rotator Cuff—External	23	Ankle Inversion	42
Seated Lateral Shoulder Raise	24	Standing Hip Extension (Knee Flexed)	43
Scapular Retraction	24	Standing Hip Extension (Knee Stabilized)	43
Back Exercises:		Standing Hip Abduction	44
Lying Lat Pulldowns	25	Seated Hip Adduction	44
Low Back Extension	25	Seated Hip Abduction	45
Pulldowns	26	Standing Leg Kickback	45
Narrow Pulldowns with Hand Grips	26	Muscle Chart	46
Lying Lat Fly	27	The Bowflex® Body Leanness Program	
Lying Narrow Lat Pulldowns	27	By Ellington Darden, Ph.D.	48
Seated Lat Rows	28	Bowflex Conquest™ Warranty	68
Stiff-Arm Pulldown	28	Bowflex Conquest™ Warranty Card	69
Bent Over Row	28		

Important Safety Precautions

IMPORTANT SAFETY INSTRUCTIONS

The following definition applies to the word “**Warning**” found throughout this manual:



Used to call attention to POTENTIAL hazards that could result in personal injury or loss of life.

PRIOR TO USING THIS EQUIPMENT, OBSERVE THE FOLLOWING WARNINGS.



- Read and understand the Owners Manual prior to using this machine.
- Read and understand all Warning Labels on this machine.
- Keep Children away from this machine. Children must be supervised closely if they are near the equipment or are present during the operation of this equipment.
- Consult a physician prior to commencing an exercise program. If, at any time, you feel faint or dizzy, or experience pain, stop and consult your physician.
- Inspect this machine for loose parts or signs of wear. Pay special attention to Cables and Belts and their connections. Do not use if found in this condition; contact Nautilus Customer Service.
- This machine is designed for a User’s Weight Limit of 300 pounds (136 kg). Do not use if you are over this weight.
- This machine contains moving parts. Use Caution. Do not wear loose clothing or jewelry.
- Set up and operate this machine on a solid level surface.
- This machine is for Consumer use only.
- Do not use additional means to increase the resistance (lifting load) of this machine.
- Be sure that the Selector Hook is correctly attached to the Rod End.
- Select a workout area that provides a minimum clearance behind the rod box of 0.5 ft (15 cm) and a total width of 6.5 ft (2.0 m). Allow a minimum of 3.0 ft (0.9 m) free space in front of the machine. Keep third parties out of this area when the machine is in use.
- Operate the machine in the manner described in this manual. It can be hazardous to over-exert yourself during exercise.
- Make sure that all positional adjustment devices are securely engaged.

Get To Know Your Bowflex Conquest™ Home Gym Warning Labels

The following safety warnings are located on the Bowflex Conquest™ home gym. Please read all safety precautions and warning information prior to using your product. Be sure to replace any warning label if damaged, illegible, or missing. If you need replacement labels, please call a Nautilus Representative at 1-800-NAUTILUS (1-800-628-8458) for assistance.



BOWFLEX
CONQUEST

Get To Know Your Bowflex Conquest™ Home Gym Warning Labels

The following safety warnings are located in site specific areas on the unit. Please review and understand the safety warning labels and their locations on the unit prior to use.

If you do not have, or cannot find, or need to replace a warning label please call 1-800-NAUTILUS (1-800-628-8458) to obtain a new label.

Label 1: Please make sure all users read, understand, and follow the warning labels on the home gym. See Figure 1 for general use safety label.

Location: The warning label in Figure 1 is located on the back of the lat tower.

Label 2: "Caution: At all times stay out of the paths of moving rods."

Location: Left and right side of rod box.

Label 3: "Warning: Do not hang from bar."

Location: Front of lat tower.

Label 4: "Caution: Before each use of this equipment, check all fasteners, snap hooks, cables and pulley functions. Tighten and fasten as needed. Check pulleys and cable for wear and function."

Location: Back of the lat tower below Label 1.

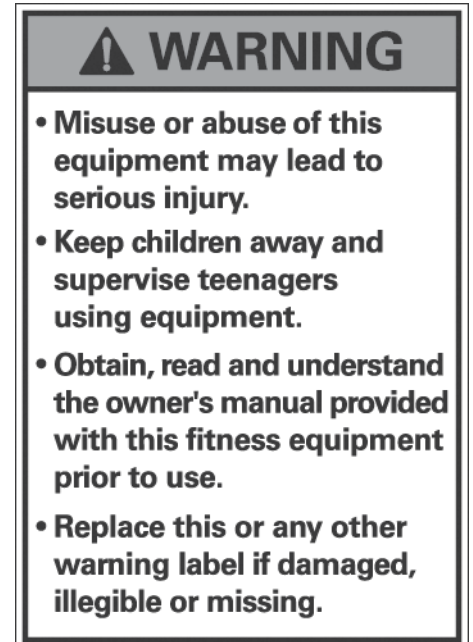
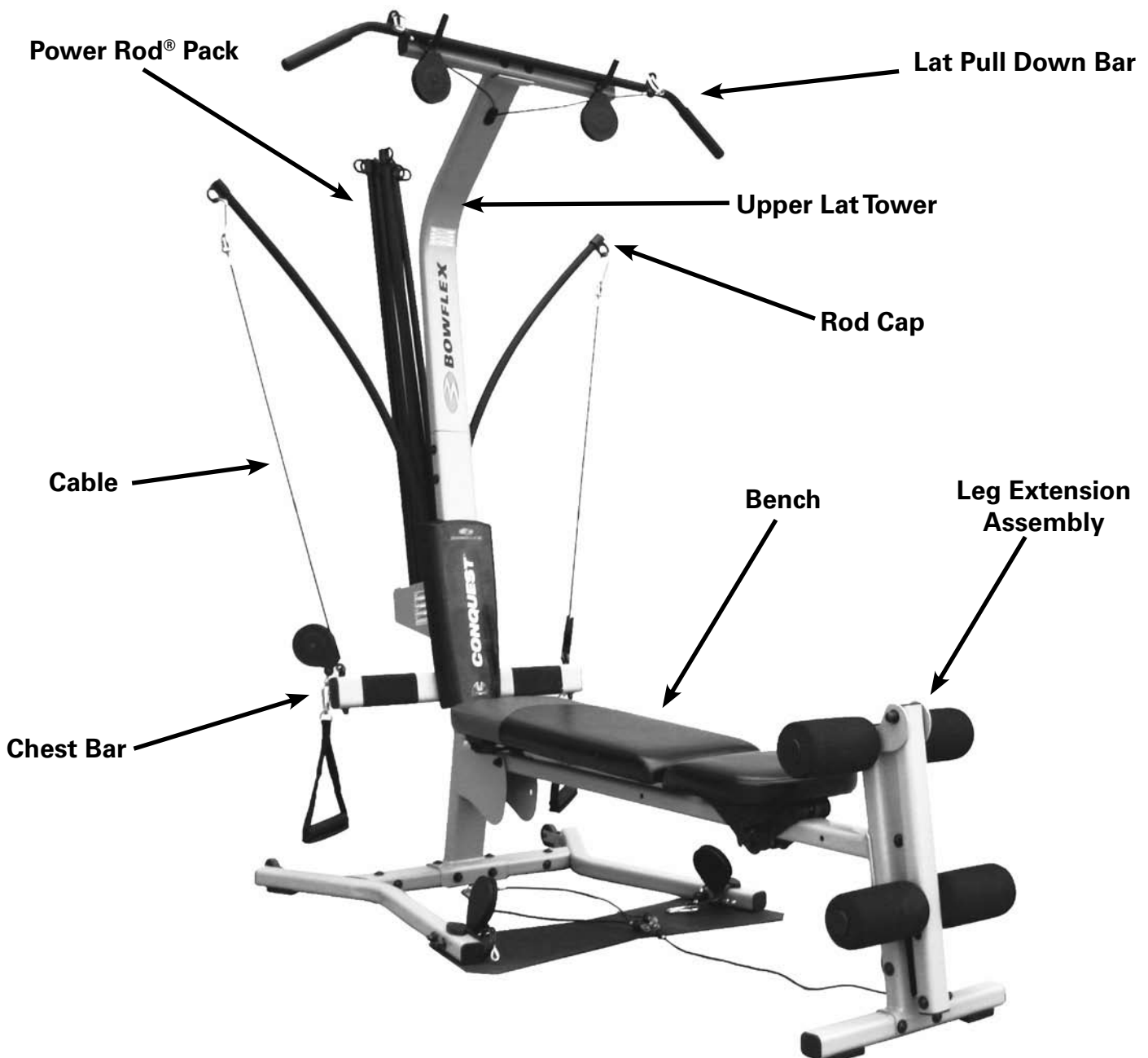

Figure 1

Get To Know Your Bowflex Conquest™ Home Gym

Please take your time to read through the entire manual and follow it carefully before attempting to use your Bowflex Conquest™ home gym. Also locate and read all warning labels that are posted on the machine. It's important to understand how to properly perform each exercise before you do so using Power Rod® Resistance.



How To Use Your Bowflex Conquest™ Home Gym

Power Rod® Resistance

Power Rod® resistance rods are made from a special composite material. Your rods are sheathed with a protective black rubber coating. Each rod is marked with its weight rating on the “Rod Cap”.



Adjusting And Understanding The Resistance

The Bowflex Conquest™ home gym comes with 210 pounds (95 kg) of resistance [one pair of 5 lb. (2.25 kg) rods, two pair of 10 lb. (4.5 kg) one pair of 30 lb. (13.5 kg) rods, and one pair of 50 lb. (22.5 kg) rods].

Hooking the Power Rod® Unit to the Cables

You may use one rod or several rods in combination, to create your desired resistance level.

To hook multiple rods up to one cable, bend the closest rod toward the cable and place the cable hook through that rod cap. You can then hook up the next closest rod through the same cable hook.

Hooking up the closest rod first prevents rods from crossing over the top of one another.



Safety

When connecting the Power Rod® caps to the cable hooks and disconnecting them, do not stand so that you are looking directly over the top of the rods. Stand off to the side, so that if a rod is accidentally released, you will not be struck by it.

When You Are Not Using Your Bowflex Conquest™ Home Gym

Disconnect the cables from the Power Rod® unit

when you are not using your Bowflex Conquest™ home gym. Use the rod binding strap included with your machine to bind all the rods together at the top. You can also place your cables and grips through the strap to keep them out of the way. Leaving the rods and cables under tension could cause injury if a rod were inadvertently released.



How To Use Your Bowflex Conquest™ Home Gym

The Workout Bench

Your BowflexConquest™ home gym has a number of seat and bench positions: flat bench forward, flat bench back, 45° incline and free-sliding seat extension.

To adjust the seat, pull out the Seat Rail Knob, then slide the seat to one of the three locking holes on the Seat Rail. Release the Seat Rail Knob to secure when finished.

Removing the Bench:

The Bench easily attaches and releases from the Seat. To attach the Bench, insert the half hinge on the end of the Bench into the half hinge on the seat. To remove the Bench, lift up on the long portion and pull away from seat.

Flat Bench:

The Flat bench position is used for most exercises. You may lock the bench into a Back (closest to Power Rod® unit) or Forward (furthest from Power Rod® unit) position to accommodate height/reach needs.

45° Incline Bench:

Start with a flat bench, following the above instructions to release and move the seat and bench. Lift the bench while sliding the seat toward the Power Rod® unit until the bench back is resting against the Lat Tower.

Free-Sliding Seat:

Remove the Bench, pull out the Seat Rail Knob, give it half a turn and release to place the Seat in a “free sliding” position for Aerobic Rowing.

Storing Your Bowflex Conquest™ Home Gym

Folding your BowflexConquest™ home gym for storage is easy.

- 1) Lock the Seat and Bench into the flat position.
- 2) Remove all Power Rod® resistance and then bind the Power Rod® unit with the rod binding strap.
- 3) Remove the Seat Rail Knob from the seat rail.
- 4) Tilt the bench toward the Power Rod® unit.
- 5) Secure the bench by inserting the Seat Rail Knob into the hole in the side of the Seat Rail Bracket.

Bowflex Conquest™ Home Gym

Inspect your machine for any worn or loose components prior to use. Tighten or replace any worn or loose components prior to use. Pay close attention to cables, or belts and their connections.

Clean the bench with a non-abrasive household cleaner after each use. This will keep it looking new. Do not use automotive cleaner, which can make the bench too “slick.”

Review all warning notices. The safety and integrity designed into a machine can only be maintained when the equipment is regularly examined for damage and repaired. It is the sole responsibility of the owner to ensure that regular maintenance is performed. Worn or damaged components shall be replaced immediately or the equipment removed from service until the repair is made. Only manufacturer supplied components shall be used to maintain/repair the equipment.

If you have any questions regarding your Bowflex Conquest™ home gym, please call our Customer Service Department at 1-800-NAUTILUS (1-800-628-8458) or by mail at:

16400 SE Nautilus Drive Vancouver, Washington, USA 98683

Maintenance and Care of Your

How To Use Your Bowflex Conquest™ Home Gym

Accessories and Equipment

Hand Grips: The Hand Grips fit snugly around your hand, ankle, or wrist. Attach the pulley cable clips to the D-Rings on the Hand Grips to attach them to the cables.

Standard Grip: Grasp the grip and cuff together to form a grip without inserting your hand through the cuff portion. Most of the exercises you perform utilize this grip. The Standard Grip also is used for Hammer Grip exercises, when you need to hold the Hand Grip vertically for greater wrist support.



Hand Cuff Grip: Slip your hand through the cuff portion of the grip so that the foam pad rests on the back of your hand. Then grasp the remainder of the grip that is sitting in your palm. This method of gripping is great for exercises like front shoulder raises or any exercise where your palm is facing down.



Ankle Cuff Grip: The cuff opening can be made larger to accommodate the ankle. Place your hand in the cuff and slide it away from the grip. Insert your foot or ankle and tighten by sliding the grip back toward the cuff.



Lat Cross Bar: The Lat Cross Bar enhances exercises that work back, shoulders and triceps muscles.

Warning:

- Before using the Lat Cross Bar, make sure that all fasteners are in place and tightened.
- Make sure that the Lat Tower cables are securely fastened to the regular Bowflex® cables and the Bent Lat Bar, Squat Bar or Hand Grips.
- Always use the Bent Lat Bar holders to support the Bent Lat Bar, or remove the bar when not in use.
- Do not hang from or attempt to perform “chin ups” from the Lat Cross Bar.
- Never pull on the Bent Lat Bar unless there is resistance attached to it.

Leg Extension: Designed to add more effectiveness exercises that target your legs, thighs, calves, etc.

Caution:

- Before using the Leg Extension, make sure that all fasteners are in place and tightened.
- Make sure that the Extension's cables are securely fastened to the regular cables.

How To Use Your Bowflex Conquest™ Home Gym

Using Your Leg Press Belt

Leg Press Belt: The Leg Press Belt is used for the Leg Press exercise.

- With the Bowflex® seat adjusted to the “free sliding” position (spring lock seat pin unlocked), the hand grips removed, and the desired amount of resistance hooked up, sit on the seat and position the leg press belt around your hips.
- Slide forward to the pulleys and place your feet through the right and left openings under the rod cables.
- Attach the rod cables to the D-rings on the Leg Press Belt so that the belt is taut.
- Place hands on vertical main frame and push yourself back while placing feet, one at a time, onto the pulley frame.
- Grasp belt near where it’s attached to the cables and begin to press back.

Attaching The Cables

Attaching The Squat Cables

- Extend the Squat Bar Cables up to the Chest Bar Pulleys and attach the ends using the Snap Hooks.
- Use Snap Hooks to attach the Squat Bar Straps to the opposite end of the Cables.
- Use Snap Hooks to attach the Squat Bar Straps to the Squat Bar.

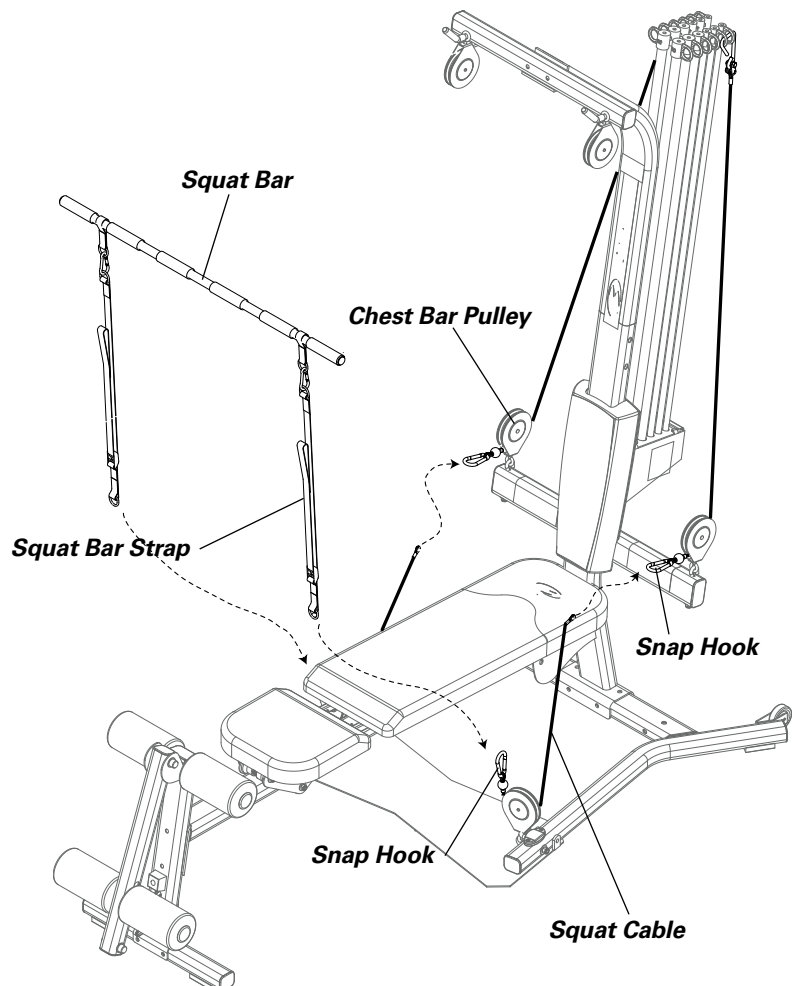

Attaching The Cables

Attaching The Lat Pull Down Cables

- Extend the Lat Pull Down Cables down to the Chest Bar Pulleys and attach the ends using the Snap Hooks.
- Use Snap Hooks to attach the Lat Pull Down Bar to the opposite end of the Cables.

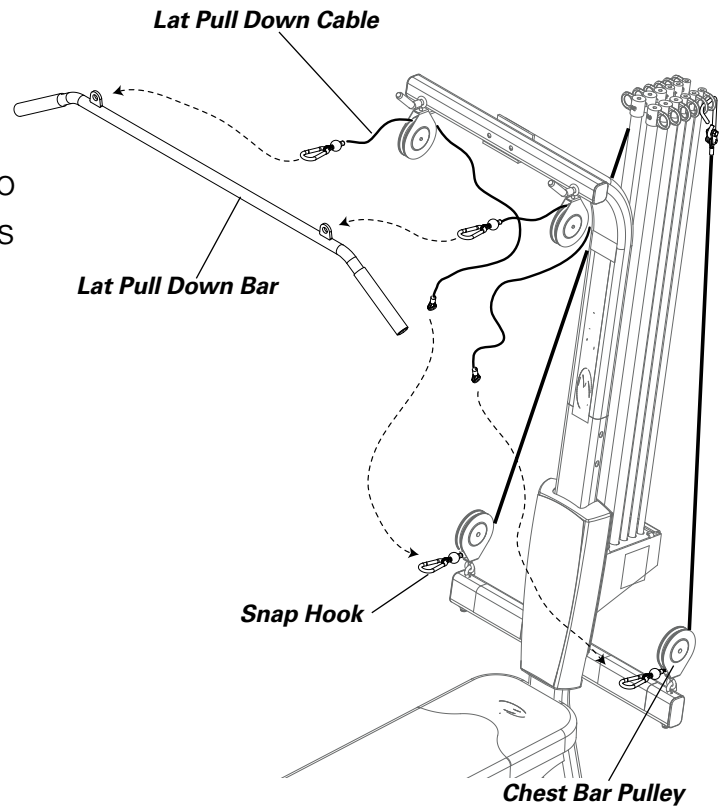

Attaching The Leg Extension Cables

- Extend the Leg Extension Cables up to the Chest Bar Pulleys and attach the ends using the Snap Hooks.

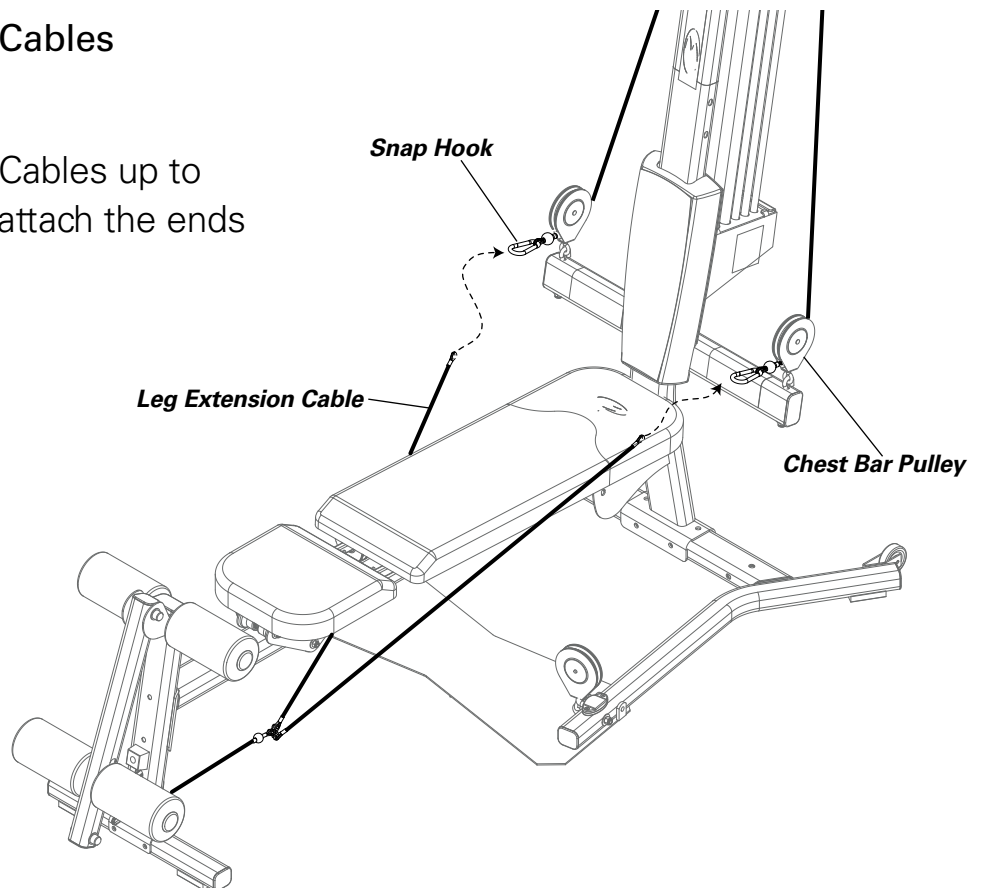

Define Your Goals

Your body will do what you train it to do. That's why it's important to define your goals and focus them. Here are some fitness components that will help you define your goals and choose your fitness program.

Muscle Strength is the maximum force that you can exert against resistance at one time. Your muscle strength comes into play when you pick up a heavy bag of groceries or lift a small child. It is developed when a localized muscle is worked both positively (concentric) and negatively (eccentric) at a resistance—great enough so you can perform only five to eight repetitions of the exercise before the muscle fails. Each set of repetitions is followed by a rest interval that typically runs three times longer than the set. Later, between exercise sessions, the muscle overcompensates for the stress and usually increases in both strength and size.

Muscle Endurance is the ability to perform repeated contractions. It comes into play when you cross-country ski or work on your feet all day. Endurance training addresses the slow twitch, endurance muscle fibers, which depend on oxygen for energy. To develop muscle endurance, use low resistance and high repetitions about 15-20 repetitions in each set, three sets to each exercise, working the muscle only to fatigue.

Muscle Power is the combination of strength and speed of the muscular contraction. This is often misinterpreted as a) being directly associated with certain skill or sport and/or b) meaning that you must move fast. Load is actually a more important factor than speed when attempting to improve power. When training to achieve muscular power, pick a resistance that fatigues you in the 3-5 repetition range. When performing these reps, it is more important to think of contracting the muscles faster rather than attempting to move faster. Performing sport simulation exercises usually results in a deterioration of the motor pattern or skill. The biomechanically sound method of improving power in your sport is to train for power using the correct joint movements, as described in this manual. Then practice the skill associated with your sport, learning to apply this newly achieved power.

Body Composition is the ratio of fat weight (fat) to lean weight (muscles, bones and tissue). As you age, the ratio shifts. The fat weight increases and the lean weight decreases. Training for muscle strength will generally increase muscle size and aerobic conditioning will help burn extra calories. Performing these two forms of exercise, either at different times or together, will create the greatest changes in body fat weight.

Balanced Strength and alignment are the result of equal strength developed in all parts of the body. It comes into play in your standing and sitting posture, and in your ability to perform just about any activity safely and effectively. An over-development of the back will round the shoulders; weak or stretched abdominals can cause lower back pain. You want a balance of muscle strength in front and back. In addition, you need a balance of strength between your middle, lower, and upper body.

Flexibility is the ability of a muscle or group of muscles to move the joint through a full range of motion. Flexibility comes into play when you execute an overhand serve or stretch for the top shelf in the kitchen. It is a cooperative movement of opposite muscle groups. When a muscle contracts, its opposite muscle group must relax for the action to occur. Increased flexibility means an increased range of motion, made possibly by this simultaneous contracting and relaxing. Good flexibility is important in protecting the body from injury and can be achieved through the balanced strength training programs that are included in this manual.

Cardiovascular Endurance is the ability of the heart and lungs to supply oxygen and nutrients to exercising muscles over an extended period of time. It comes into play when you jog a mile or ride a bike. It is a critical component of overall fitness and health.

Define Your Goals

Design Your Own Program

You may want to design your own personal program specifically geared to your goals and lifestyle. Designing a program is easy, as long as you follow the guidelines below.

Understand fitness and its components: Improperly designed programs can be dangerous. Take some time to review this manual as well as other fitness guides.

Know your current fitness level: Before you start any fitness program you should consult a physician who will help you determine your current abilities.

Identify your goals: Goals are critical to choosing and designing an exercise program that fits and enhances your lifestyle, but so is strategy. It's important not to rush the process and try to accomplish too much too soon. That will lead to setbacks and discouragement. Instead, set a series of smaller achievable goals.

Select complementary exercises: Be sure to pair exercises that address compound joint movements and single joint movements. In addition, select exercises that address complementary muscle groups.

Put first things first: During each session, first work muscle groups that need the most training.

Remember your cardiovascular component: Any fitness program must contain a cardiovascular fitness component to be complete. So complement your resistance training with aerobic exercise such as walking, running, or bicycling.

Training variables: When designing your own program there are several variables that, when mixed properly, will equal the right fitness formula for you. In order to find out the best formula, you must experiment with several combinations of variables.

The variables are as follows:

- **Training Frequency:** The number of times you train per week. We recommend daily activity but not daily training of the same muscle group.
- **Training Intensity:** The amount of resistance used during your repetition.
- **Training Volume:** The number of repetitions and sets performed.
- **Rest Intervals:** The time you rest between sets and the time you rest between workouts.

Once you've established a base of fitness, follow these basic principles:

- **Isolate Muscle Groups:** Focus work on specific muscle groups.
- **Progressive Loading:** The gradual systematic increase of repetitions, resistance and exercise period.

Define Your Goals

Working Out

A workout begins in your mind's eye. With concentration and visualization you can approach your workout with a positive, constructive attitude.

A good pre-workout mental routine is to sit and relax, so that you can focus on what you are about to do and think about achieving your end goal.

Warming Up

We recommend that you warm up by doing light stretching and performing light exercises on the Bowflex Conquest™ home gym.

Cooling Down

An essential part of the exercise routine is the cool down. Gradually reduce the level of exercise intensity so that blood does not accumulate in one muscle group, but continues to circulate at a decreasing rate. Remember to gradually move yourself into a relaxed state.

Breathing

The most important part of breathing during exercise is, quite simply, that you do it. Breathing in or out during the actual performance is not dependent upon the direction of air flow relative to exertion. It is, in fact, a mechanical process that changes the position of your spine as your rib cage moves. Here are some tips for breathing:

- 1) Be cautious when you are concentrating or exerting effort. This is when you will probably hold your breath. **DO NOT** hold your breath. Do not exaggerate breathing. Depth of inhalation and exhalation should be natural for the situation.
- 2) Allow breathing to occur, naturally, don't force it.

Warm Up / Cool Down

Aerobic Rowing – Warm Up or Cool Down

Muscles worked:

Pectoralis Major; Anterior Deltoids

Bench Position:

Removed, Free Sliding Seat

Accessory:

Leg Press Belt

Pulleys:

Chest Bar



START

- Remove the Bench and place the Seat in Free Sliding position.
- Attach resistance and sit facing the Power Rod® unit.
- Brace your feet against the Chest Bar.



ACTION

- Initiate movement by extending your knees while simultaneously bending your arms and pinching your shoulder blades together.
- Control the return to the Start position by slowly bending your legs.

Success Tips

- Maintain good spinal alignment. Keep chest lifted.
- Bend from the hip during movement, not from the waist.
- You may hold onto the Leg Press Belt to improve stability.

Chest Exercises

Bench Press — Shoulder Horizontal Adduction (and elbow extension)

Muscles worked:
Pectoralis Major; Deltoids; Triceps

Bench Position:
45° incline

Accessory:
Hand Grips

Pulleys:
Chest Bar



Success Tips

- Maintain a 90° angle between upper arms and torso throughout motion.
- Keep chest muscles tightened. Limit and control your range of motion.
- Keep knees bent, feet on floor, head back against bench.
- Keep elbows in front of shoulders.
- Keep shoulder blades pinched together and maintain good spinal alignment.

- START**
- Grasp Hand Grips in both hands.
 - Slowly bend your elbows until hands are at chest level. Rotate upper arms away from torso, elbows out, palms forward.
 - Line up arms with cables keeping your wrists straight.
 - Raise chest, pinch shoulder blades together, and maintain a slight, comfortable arch in your lower back.

- ACTION**
- Press your hands forward, straightening your arms while moving your hands together. Do not lock elbows.
 - Return to Start position, keeping your wrists at shoulder width and in line with the cables.

Chest Fly — Shoulder Horizontal Adduction (elbow stabilized)

Muscles worked:
Pectoralis Major; Anterior Deltoid

Bench Position:
45° incline

Accessory:
Hand Grips

Pulleys:
Chest Bar

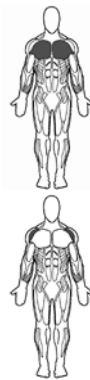

Success Tips

- Maintain a 60-90° angle between upper arms and torso during exercise.
- Keep chest muscles tightened. Limit and control your range of motion.
- Keep knees bent, feet on floor, head back against bench.
- To improve your pectoralis involvement, keep your shoulder blades pinched together throughout upward and downward movements.

- START**
- Grasp Hand Grips in both hands.
 - Open your arms into a wide, elbow bent position. Keeping elbows and forearms below chest level, palms forward.
 - Raise chest, pinch shoulder blades together, and maintain a slight, comfortable arch in your lower back.

- ACTION**
- Slowly press your arms forward and upward, straightening arms and moving your hands together.
 - Rotate your wrists and forearms upward.
 - Slowly return to Start position.

Chest Exercises

Decline Bench Press – Shoulder Horizontal Adduction (and elbow extension)

Muscles worked:
Pectoralis Major; Deltoids; Triceps

Bench Position:
45° incline

Accessory:
Hand Grips

Pulleys:
Chest Bar



Success Tips

- Maintain a 90° angle between your upper arms and torso at the start of the motion, and slightly less than 90° at the finish.
- Keep knees bent, feet on floor, head back against bench.
- Do not let your elbows travel behind your shoulders.
- Keep shoulder blades pinched together and maintain good spinal alignment.

START

- Grasp Hand Grips in both hands.
- Cables travel beneath arms, forearms aligned with cables.
- Bend your elbows back, keeping upper arms at a 90° angle from your torso. Elbows should be 10° (5-6" or 13-15 cm) lower than the standard Bench Press position.
- Raise chest, pinch shoulder blades together, and maintain a comfortable arch in lower back.

ACTION

- Slowly press your hands forward, straightening your arms while moving your hands to the center and downward, at least 10° below your shoulders. Do not lock your elbows.
- Slowly return to the starting position, keeping your wrists steady and your movements slow and controlled.

Incline Bench Press – Shoulder Horizontal Adduction (and elbow extension)

Muscles worked:
Pectoralis Major; Deltoids; Triceps

Bench Position:
45° incline

Accessory:
Hand Grips

Pulleys:
Chest Bar

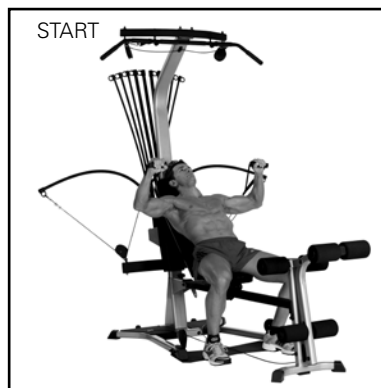
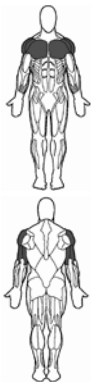

Success Tips

- Maintain a 90° angle between your upper arms and torso at the start of the motion, and slightly less than 90° at the finish.
- Keep knees bent, feet on floor, head back against bench.
- Do not let your elbows travel behind your shoulders.
- Keep shoulder blades pinched together and maintain good spinal alignment.

START

- Grasp Hand Grips in both hands.
- Cables travel above forearms. Keep your forearms in line with the cables at all times.
- Bend your elbows back, keeping upper arms at a 90° angle from torso. Forearms 10-15° (6-8" or 13-20 cm) higher than Bench Press position.
- Raise chest, pinch shoulder blades together, and maintain a slight arch in your lower back.

ACTION

- Slowly press your hands forward, straightening your arms and moving hands to the center and downward, at least 10° above your shoulders.
- Slowly return to the starting position, keeping your wrists steady and your movements slow and controlled.

Chest Exercises

Decline Chest Fly – Shoulder Horizontal Adduction (elbow stabilized)

Muscles worked:
Pectoralis Major; Anterior Deltoid

Bench Position:
45° incline

Accessory:
Hand Grips

Pulleys:
Chest Bar

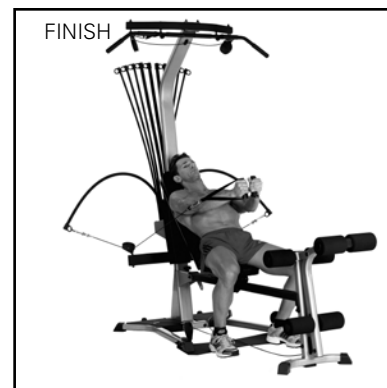

Success Tips

- Maintain a 60-90° angle between upper arms and torso during exercise.
- Keep chest muscles tightened. Limit and control your range of motion.
- Keep knees bent, feet on floor, head back against bench.
- To improve your pectoralis involvement, keep your shoulder blades pinched together throughout upward and downward movements.

START

- Grasp Hand Grips in both hands.
- Open your arms into a wide, elbow bent position, press your forearms downward. At full extension, hands should be level with your hips.
- Raise chest, pinch shoulder blades together, and maintain a slight, comfortable arch in your lower back.

ACTION

- Press your arms forward and upward, straightening arms and moving your hands together.
- Rotate your wrists and forearms upward.
- Return to Start position, slowly returning your arms in front of you, just below chest level.

Incline Chest Fly – Shoulder Horizontal Adduction (elbow stabilized)

Muscles worked:
Pectoralis Major; Anterior Deltoid

Bench Position:
45° incline

Accessory:
Hand Grips

Pulleys:
Chest Bar

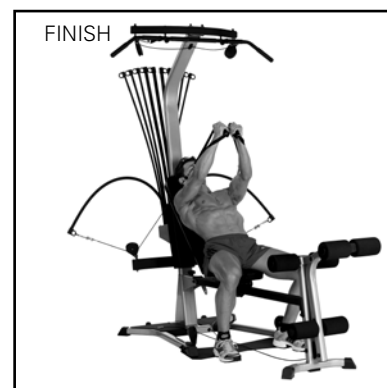

Success Tips

- Maintain a 60-90° angle between upper arms and torso during exercise.
- Keep chest muscles tightened. Limit and control your range of motion.
- Keep knees bent, feet on floor, head back against bench.
- To improve your pectoralis involvement, keep your shoulder blades pinched together throughout upward and downward movements.

START

- Grasp Hand Grips in both hands.
- Open your arms into a wide, elbow bent position. Press your forearms upward. At full extension, your elbows should be level with your ears.
- Raise chest, pinch shoulder blades together, and maintain a slight, comfortable arch in your lower back.

ACTION

- Press your arms forward and upward, straightening arms and moving your hands together.
- Rotate your wrists and forearms upward.
- Return to Start position, slowly returning your arms in front of you, just below chest level.

Chest Exercises

Resisted Punch – Shoulder Flexion, Elbow Extension, Scapular Protraction

Muscles worked:
Anterior Deltoid; Triceps

Bench Position:
Flat Bench Back

Accessory:
Hand Grips

Pulleys:
Chest Bar



START

- Sit on the bench facing away from the Power Rod® unit.
- Reach behind your body and grasp one Hand Grip with an overhand grip, as shown above.
- Bend your elbows until your hands are level with your waist.



ACTION

- Using moderate speed, rotate your trunk and press your arm (s) forward to full extension, allowing shoulder blade to move forward at the end of the punch.
- Slowly return to the Start position. Do not relax the tension in your arm.
- You may vary this exercise by using bilateral movement with both arms or punching upward or downward.

Success Tips

- Maintain an upright, erect posture as your trunk rotates with the punch.
- Keep knees bent and feet on floor.
- Maintain good spinal alignment.

Lying Cable Crossover – Shoulder Extension/Adduction (elbow stabilized)

Muscles worked:
Pectoralis Major

Bench Position:
Flat Bench Back

Accessory:
Hand Grips

Pulleys:
Chest Bar

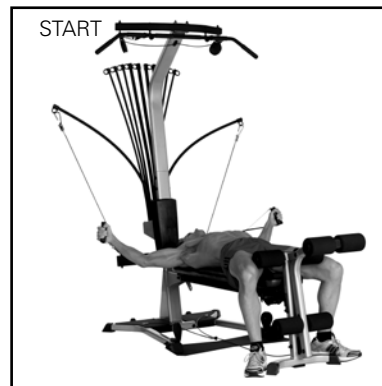

START

- Lie flat on your back, head toward the Power Rod® unit. Position yourself far enough down the Bench to grasp the Hand Grips over your head with arms straight.
- Grasp the Hand Grips, palms facing up.
- Tighten your abdominals to stabilize your spine. Maintain a slight, comfortable arch in your lower back.



ACTION

- Keeping your arms straight, move your hands in an arc upward and across your torso toward the opposite thigh.
- Control the return to the Start position by slowly moving your arms back overhead, releasing the shoulder blades and keeping arms straight.

Success Tips

- Keep chest lifted throughout exercise.
- Keep knees bent, feet on floor, head back against bench.

Shoulder Exercises

Rear Deltoid Rows – Shoulder Horizontal Abduction (and elbow flexion)

Muscles worked:

Rear and Middle Deltoids; Posterior Rotator Cuff; Upper Latissimus; Teres Major; Trapezius; Rhomboids

Bench Position:

Flat Bench Back

Accessory:

Hand Grips

Pulleys:

Chest Bar

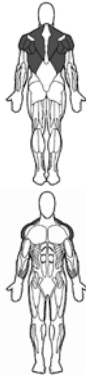

START

- Sit on the bench facing Power Rod® unit.
- Grasp the Hand Grips. Keep palms down and arms straight.
- Sit up straight. Bend slightly from hips until arms are in front of body at a 90° angle from torso.
- Lift your chest and keep your shoulder blades together.
- Keep forearms in line with cables.



ACTION

- Allowing your arms to bend slowly, move your elbows outwards and backwards, keeping a 70-90° angle between your upper arms and torso.
- Move until your elbows are slightly behind your shoulders, then slowly reverse back to the Start position.
- Keep your shoulder blades tightened throughout motion.

Success Tips

- Maintain a 90° angle between your upper arms and torso during motion.
- Keep knees bent and feet on floor.
- To work one arm at a time, place non-working hand on bench to stabilize.
- Keep shoulder blades pinched together and maintain good spinal alignment.

Standing Lateral Shoulder Raise – Shoulder Extension (elbow stabilized)

Muscles worked:

Middle Deltoids; Upper Trapezius

Bench Position:

Removed

Accessory:

Hand Grips

Pulleys:

Chest Bar

Leg Extension:

Removed



START

- Remove the bench and stand on the platform, straddling the seat rail and facing the Power Rod® unit.
- Grasp the Hand Grips, palms facing each other.
- Align your spine and bend forward slightly at the hips (15-20°).
- Let arms hang in line with cables.
- Elevate shoulders slightly toward back of head, keeping spine



ACTION

- Slowly raise your arms out to your sides, at a 90° angle from your body.
- Keep your forearms facing outward throughout the movement.
- Slowly return to the Start position without relaxing muscle tension.

Success Tips

- Do not swing your arms upward or move your trunk during the motion.
- Keep your feet on floor.

Shoulder Exercises

Seated Shoulder Press — Shoulder Adduction (and elbow extension)

Muscles worked:
Front Deltoids; Upper Trapezius; Triceps

Bench Position:
Flat Bench Back

Accessory:
Hand Grips

Pulleys:
Chest Bar



START

- Sit on the bench facing away from the Power Rod® unit.
- Keep your chest up, abs tight and maintain a slight arch in lower back.
- Grasp Hand Grips, palms facing out.
- Raise the Hand Grips to shoulder level, keeping your palms facing forward.



ACTION

- Straighten your arms slowly over your head, focusing on moving your elbows up and inward toward your ears.
- Slowly return to the Start position, keeping tension in your front shoulder muscles.

Success Tips

- Keep knees bent and feet on floor.
- Do not increase the arch in your lower back as you raise your arms, but keep your spine steady and tight.
- Keep abdominals tight and maintain good spinal alignment.

Front Shoulder Raise — Shoulder Flexion (elbow stabilized)

Muscles worked:
Front and Middle Deltoids

Bench Position:
Flat Bench Back

Accessory:
Hand Grips

Pulleys:
Chest Bar



START

- Sit on the bench, facing away from the Power Rod® unit.
- Keep your chest up, abs tight and maintain a slight arch in lower back.
- Grasp the Hand Grips, palms facing back, arms straight at your sides.



ACTION

- Keeping your arms straight, move them forward, leading with your forearms, until arms are extended in front of you at shoulder height.
- Arms may be moved alternately or together.
- Slowly return to the Start position next to the torso.

Success Tips

- Keep abdominals tight and maintain good spinal alignment.
- Keep knees bent and feet on floor.
- Do not increase the arch in your lower back as you raise your arms, but keep your spine steady and tight.

Shoulder Exercises

Shoulder Extension – (elbows stabilized)

Muscles worked:
Latissimus Dorsi; Teres Major; Rear Deltoid;
Middle Trapezius; Rhomboids; Triceps

Bench Position:
Flat Bench Back

Accessory:
Hand Grips

Pulleys:
Chest Bar



START



FINISH

Success Tips

- Keep knees bent and feet flat on floor.
- Keep your lats tightened throughout the motion.
- Keep abdominals tight and maintain good spinal alignment.
- Release your shoulder blades at the end of each rep and initiate new rep by retracting your shoulder blades.

START

- Sit on the bench facing Power Rod® unit.
- Grasp the Hand Grips, palms facing down, arms straight and at approximately a 45° angle from torso.
- Tighten your trunk muscles to stabilize your spine while maintaining a slight arch in the lower back.

ACTION

- Initiate movement by pinching shoulder blades together.
- Continue movement by moving your hands in an arc downward, along your sides, until hands are level with hips.
- With controlled movement, slowly return to the Start position.

Shoulder Shrug – Scapular Elevation

Muscles worked:
Upper Trapezius

Bench Position:
Removed

Accessory:
Hand Grips

Pulleys:
Chest Bar



START



FINISH

Success Tips

- Keep abdominals tight and maintain good spinal alignment.
- Do not bend your neck or slouch during this exercise.
- Raise shoulders evenly.
- For variation, try this exercise bent forward slightly from the hips.

START

- Stand on the platform, facing the Power Rod® unit.
- Reach down and grasp the Hand Grips, palms facing each other.
- Let your arms hang at your sides.

ACTION

- Slowly raise your shoulders towards the back of your head, keeping your neck and head still.
- Slowly reverse back to the Start position, keeping your upper trapezius muscles tight throughout the motion.

Shoulder Exercises

Shoulder Rotator Cuff – Internal Rotation

Muscles worked:
Subscapularis

Bench Position:
Flat Bench Forward

Accessory:
Hand Grips

Pulleys:
Chest Bar



START



FINISH

Success Tips

- Keep knees bent and feet flat on floor. Lean head back against the bench.
- Keep your spine aligned and a slight arch in your lower back.
- Maintain a 90° angle between forearms and torso throughout exercise.
- Do not rotate the spine to get additional range of motion.

START

- Sit on the Bench, one side toward the Power Rod® unit.
- Grasp the Hand Grip nearest you and draw your upper arm into your torso, keeping your forearm at a 90° angle from torso.
- Give yourself enough distance to eliminate slack in the cable.
- Use a light resistance.

ACTION

- Rotate your forearm toward your abdomen, keeping your elbow at your side throughout motion.
- Slowly return to the Start position, maintaining controlled motion.

Shoulder Rotator Cuff – External Rotation

Muscles worked:
Infraspinatus; Teres Minor

Bench Position:
Flat Bench Forward

Accessory:
Hand Grips

Pulleys:
Chest Bar



START



FINISH

Success Tips

- Keep knees bent and feet flat on floor. Lean head back against the bench.
- Keep your spine aligned and a slight arch in your lower back.
- Maintain a 90° angle between forearms and torso throughout exercise.
- Do not rotate the spine to get additional range of motion.

START

- Sit on the Bench, one side toward the Power Rod® unit.
- Using the arm farthest from the Power Rod® unit, grasp the Hand Grip nearest you and draw that upper arm into your torso, keeping your forearm at a 90° angle from torso.
- Allow forearm to rest against your abdomen, elbow at your side to remove cable tension
- Use a light resistance.

ACTION

- Rotate your forearm away from your abdomen, keeping your elbow at your side throughout motion.
- Slowly return to the Start position, maintaining controlled motion.

Shoulder Exercises

Seated Lateral Shoulder Raise — Shoulder Flexion (elbows stabilized)

Muscles worked:
Supraspinatus; Middle Deltoids; Trapezius

Bench Position:
Flat Bench Forward

Accessory:
Hand Grips

Pulleys:
Chest Bar



START

- Sit on the bench facing Power Rod® unit.
- Spread the cuff from the Hand Grips and slide them over your forearms, near the elbow.
- Keep your chest lifted, maintaining a slight arch in your lower back.



ACTION

- Raise your arms directly out to your sides, nearly shoulder level.
- At the top of the movement, you may need to rotate your hands slowly to prevent the cuff from sliding off.
- With controlled movement, slowly return to the Start position.

Success Tips

- Keep knees bent and feet flat on floor.
- Keep abdominals tight and maintain good spinal alignment.
- Do not increase swing arms upward or move trunk during movement.

Scapular Retraction

Muscles worked:
Middle Trapezius; Rhomboids

Bench Position:
Flat Bench Back

Accessory:
Hand Grips

Pulleys:
Chest Bar



START

- Sit on the Bench facing the Power Rod® unit.
- Grasp the Hand Grips, palms facing each other.



ACTION

- Keeping your arms straight, slowly pinch your shoulder blades together.
- When shoulder blades are fully retracted, slowly return to the Start position.

Success Tips

- Do not lose spinal alignment—keep your chest lifted.
- Keep knees bent and feet flat on floor.
- Keep your spine aligned and a slight arch in your lower back.
- Do not use your arm muscles for this movement.

Back Exercises

Lying Lat Pulldowns

Muscles worked:
Latissimus Dorsi; Teres Major;
Rear Deltoids

Bench Position:
Flat Bench Forward

Accessory:
Hand Grips

Pulleys:
Chest Bar



START

- Lie on your back on the bench, head near the Power Rod® unit.
- Slip your arms through the Hand Grips, slide the cuffs past your elbows and tighten them enough to stabilize.
- With your palms facing inward, slide your body down the bench far enough that your arms are fully extended—your posterior may hang off the end of the bench.



FINISH

- Initiate the movement by pulling your shoulder blades downward. Slowly start bending your elbows, pulling them down toward your hips and then inward into your trunk.
- Slowly return to the Start position, allowing your arms and shoulder blades to move back without relaxing the tension in your shoulders.

Success Tips

- Keep knees bent and feet flat on floor. Lean head back against the bench.
- Keep your spine aligned, abs tight and a slight arch in your lower back.
- Keep your lats tightened throughout this exercise.
- Release your shoulder blades at the top of each rep. Initiate each new rep by depressing your shoulder blades.

Low Back Extension — Seated (with hip extension)

Muscles worked:
Lower Trapezius

Bench Position:
Flat Bench Back

Accessory:
Hand Grips

Pulleys:
Chest Bar



START

- Sit on the bench, facing Power Rod® unit.
- Grasp the Hand Grips and slide them over your forearms, tightening near your elbows.
- Brace your heels on the platform, knees bent comfortably, arms crossed in front of chest. Pull the Hand Grips into your chest.
- Pinch shoulder blades together and lean forward from the hips only.



FINISH

- Keeping your chest lifted, move your entire torso backwards by pivoting at the hips.
- Slowly return to the Start position without slouching or changing spinal alignment.

Success Tips

- Keep knees bent and feet flat on floor. Lean head back against the bench.
- Keep your spine aligned, abs tight and a slight arch in your lower back.
- Keep your lats tightened throughout this exercise.
- Release your shoulder blades at the top of each rep. Initiate each new rep by depressing your shoulder blades.

Back Exercises

Pulldowns – Shoulder Adduction (with elbow flexion)

Muscles worked:
Latissimus Dorsi; Teres Major;
Rear Deltoids; Biceps

Bench Position:
Flat Bench Forward

Accessory:
Bent Lat Bar

Pulleys:
Lat Tower

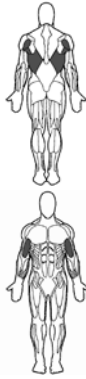

Success Tips

- Keep knees bent and feet flat on floor.
- To determine the appropriate grip width for you, hold your arms straight out to your sides at shoulder height. Bend your elbows approximately 90°. Hands should be no wider apart than your elbows (beginners may narrow their grip to increase comfort).
- Keep your spine aligned, abs tight and a slight arch in your lower back.

- START**
- Grasp the Bent Lat Bar using the wide grip determined by following the directions in the Success Tips, then sit on the bench, facing the Power Rod® unit.
 - Position your thighs directly under the Lat Tower pulleys. Sit upright.
 - Keep your arms extended and straight.

- ACTION**
- Initiate movement by pulling shoulder blades together while simultaneously drawing elbows down and inward.
 - Bent Lat Bar may not touch your chest. At the end of the motion, arms should be near your sides, shoulder blades fully depressed.
 - Keep forearms facing upward.
 - Slowly return to Start position.

Narrow Pulldowns with Hand Grips – Shoulder Extension (with elbow flexion)

Muscles worked:
Latissimus Dorsi; Teres Major;
Rear Deltoids; Biceps

Bench Position:
Flat Bench Forward

Accessory:
Hand Grips

Pulleys:
Lat Tower

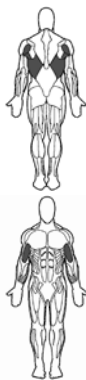

Success Tips

- Keep your chest lifted, abs tight, and a very slight arch in your lower back.
- Keep knees bent and feet flat on floor.
- Keep the lats tightened throughout the entire motion.

- START**
- Attach a Hand Grip to each cable on the Lat Tower Pulleys.
 - Straddle the bench facing the Power Rod® unit, grasp a Hand Grip in each hand, palms facing each other and sit down on the bench.
 - Position your thighs directly under the Lat Tower pulleys. Sit upright.

- ACTION**
- Keep hands at shoulder width, arms straight. Initiate movement by pulling your shoulder blades down and together while simultaneously bending your elbows, drawing them down and inward towards your sides.
 - At the end of the motion, arms should be near your sides, shoulder blades depressed, forearms facing upward.
 - Slowly return to Start position.

Back Exercises

Lying Lat Fly – Shoulder Adduction

Muscles worked:
Latissimus Dorsi; Teres Major;
Rear Deltoids; Biceps

Bench Position:
Flat Bench Back

Accessory:
Shoulder Cuff

Pulleys:
Chest Bar

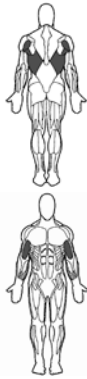

START

- Lie on your back, head toward Power Rod® unit, knees at the edge of bench.
- Grasp the Hand Grips, then straighten your arms out to your sides, hands slightly above your head, palms facing away from pulleys.
- Tighten your abs to stabilize your spine while maintaining a slight arch in your lower back.



ACTION

- Initiate the movement by pulling your shoulder blades downwards. Pull your arms in an arc into your sides, keeping them as straight as possible and using slow, controlled movement.
- Slowly return to the Start position, allowing your arms and shoulder blades to move back upward and outward toward the Power Rod® unit.

Success Tips

- Keep knees bent and feet flat on floor.
- Keep your lats tightened throughout entire motion.
- Keep your spine aligned, abs tight and a slight arch in your lower back.
- Release your shoulder blades at the end of each rep. Initiate each new rep by depressing your shoulder blades.

Lying Narrow Lat Pulldowns

Muscles worked:
Latissimus Dorsi; Teres Major;
Rear Deltoids; Biceps

Bench Position:
Flat Bench Forward

Accessory:
Bent Lat Bar

Pulleys:
Lat Tower

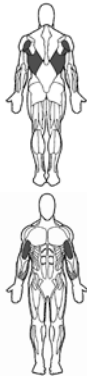

START

- Lie on your back on the bench, head near the Power Rod® unit.
- Slip your arms through the Hand Grips, slide the cuffs past your elbows and tighten them enough to stabilize.
- With your palms facing inward, slide your body down the bench far enough that your arms are fully extended—your posterior may hang off the end of the bench.



ACTION

- Initiate the movement by pulling your shoulder blades downward. Slowly start bending your elbows, pulling them down toward your hips and then inward into your torso.
- Slowly return to the Start position, allowing your arms and shoulder blades to move back without relaxing the tension in your shoulders.

Success Tips

- Keep knees bent and feet flat on floor. Lean head back against the bench.
- Keep your spine aligned, abs tight and a slight arch in your lower back.
- Keep your lats tightened throughout this exercise.
- Release your shoulder blades at the top of each rep. Initiate each new rep by depressing your shoulder blades

Back Exercises

Seated Lat Rows – Shoulder Extension (and elbow flexion)

Muscles worked:
Latissimus Dorsi; Teres Major;
Rear Deltoids; Biceps

Bench Position:
Flat Bench Back

Accessory:
Hand Grips

Pulleys:
Chest Bar

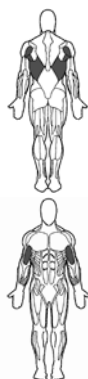

- START**
- Sit on the bench facing Power Rod® unit, with your posterior near the back (leg extension) end of the bench.
 - Grasp the Hand Grips, palms facing each other.
 - Place your heels on the edge of the Standing Platform and bend your knees comfortably.



- ACTION**
- Initiate the movement by pinching your shoulder blades together.
 - Pull your upper arms downward and backward, brushing past the sides of the body while keeping your forearms pointing in the direction of the cable.
 - Slowly return to the Start position.

Success Tips

- Keep knees bent and feet flat on floor.
- Do not bend your torso forward.
- Keep your chest lifted and maintain spinal alignment.
- Release your shoulder blades at the end of each rep. Initiate each new rep by pinching your shoulder blades

Stiff-Arm Pulldown – Shoulder Extension (elbow stabilized)

Muscles worked:
Latissimus Dorsi; Teres Major; Rear
Deltoids; Lower Trapezius; Biceps

Bench Position:
Removed

Accessory:
Bent Lat Bar

Pulleys:
Lat Tower

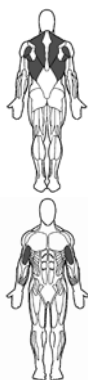

- START**
- Straddle the Seat Rail facing the Power Rod® unit.
 - Grasp the Bent Lat Bar with your palms facing down.
 - Step back slightly, making sure that there is enough movement in the cable to complete your full range of motion with this exercise.
 - Bend slightly from hips, lift chest and tighten your abs to stabilize spine.



- ACTION**
- Initiate the movement by lowering your shoulder blades, bringing them down and together.
 - Keep your arms straight, moving your hands downward in an arc and slowly in toward your thighs.
 - Slowly return to the Start position without relaxing muscle tension.

Success Tips

- Keep your lats tightened throughout the entire motion.
- Keep your chest lifted and maintain spinal alignment, keeping a very slight arch in your lower back.
- Release your shoulder blades at the end of each rep. Initiate each new rep by depressing your shoulder blades.
- Keep your elbows nearly straight (do not lock elbows) throughout exercise.

Back Exercises

Bent Over Row

Muscles worked:
Latissimus Dorsi; Teres Major;
Rear Deltoids; Biceps

Bench Position:
Removed

Accessory:

Squat Bar Attachment

Pulleys:
Squat Pulley Frame

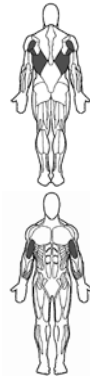

START

- Stand on platform. Reach down and grasp the Squat attachment with palms facing backward.
- Let your arms hang extending in the direction of the pulleys
- Keep back flat and knees bent

ACTION

- Begin your motion by moving elbows back as you bring the hand grips to a point below your chest line.
- Slowly reverse the motion, keeping knees bent and back flat

Success Tips

- Keep knees bent and feet flat on floor.
- Do not bend your torso forward.
- Keep your chest lifted and maintain spinal alignment.
- Release your shoulder blades at the end of each rep. Initiate each new rep by pinching your shoulder blades

Arm Exercises

Triceps Pushdown – Elbow Extension

Muscles worked:
Triceps

Bench Position:
Removed

Accessory:
Bent Lat Bar

Pulleys:
Lat Tower

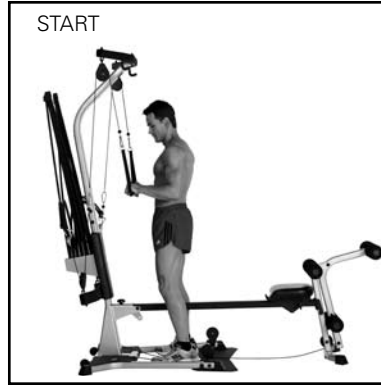

Success Tips

- Keep your upper arms motionless and your wrists straight.
- Keep your chest lifted, abs tight and maintain a slight arch in lower back.
- Tighten the triceps throughout the exercise, using controlled motion.

START

- Straddle the Seat Rail, facing the Power Rod® unit.
- Grasp the Bent Lat Bar, palms facing down.
- Stand approximately 2-3 feet or .6-.9 m from Lat Tower (adjust for comfort).
- Bring hands in front of you, keeping the Lat Bar approximately at rib level.
- Bend over slightly from hips, shoulders directly over hands.

ACTION

- Keeping your upper arms stationary, elbows next to trunk, slowly push your arms downward in a gentle arc until hands are near tops of your thighs.
- Keeping your triceps tightened, slowly reverse the arcing motion and bring the Bent Lat Bar back to the Start position.

Single Arm Pushdown – Elbow Extension

Muscles worked:
Triceps

Bench Position:
Removed

Accessory:
Hand Grips

Pulleys:
Lat Tower



Success Tips

- Keep your upper arms motionless and your wrists straight.
- Keep your chest lifted, abs tight and maintain a slight arch in lower back.
- Tighten the triceps throughout the exercise, using controlled motion.

START

- Straddle the Seat Rail facing the Power Rod® unit, and grasp one Hand Grip, palm facing up.
- Stand approximately 1-2 feet or .3-.6 m from Lat Tower (adjust for comfort).
- Bring your arm in front of you, keeping the Hand Grip at chest level.
- Bend over slightly from hips, so that your shoulder is directly over your hand.

ACTION

- Keeping your upper arm stationary, elbow next to trunk, slowly push your arm downward in a gentle arc until your hand is near top of the thigh.
- Keeping your triceps tightened, slowly reverse the arcing motion, bringing the Hand Grip back to the Start position.

Arm Exercises

French Press — Elbow Extension overhead

Muscles worked:

Triceps

Bench Position:

Flat Bench Back

Accessory:

Hand Grips

Pulleys:

Chest Bar



START

- Sit on the bench facing away from the Power Rod® unit, keeping knees bent and feet flat on floor.
- Reach behind and grasp one or both of the Hand Grips, palms facing inward.
- Draw arms up until elbows are pointing forward, hands behind head.

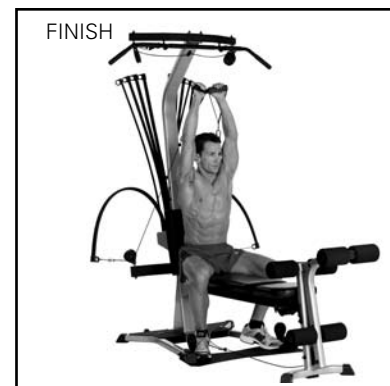

ACTION

- Keeping your upper arms stationary, straighten your elbows, bringing your hands overhead, palms facing out.
- Stop your motion before your elbows are completely straight, and then reverse your motion, slowly returning to the Start position without relaxing muscle tension.

Success Tips

- Keep your upper arms motionless and your wrists straight.
- Keep your chest lifted and maintain spinal alignment, keeping a very slight arch in your lower back.
- Tighten the triceps throughout the exercise, using controlled motion.

Lying Triceps Extension — Elbow Extension

Muscles worked:

Triceps

Bench Position:

Flat Bench Back

Accessory:

Hand Grips

Pulleys:

Chest Bar



START

- Lie on the bench, head toward the Power Rod® unit, knees bent and feet flat on the floor.
- Reach overhead and grasp the Hand Grips, palms facing upward.
- Keep your hands up, near your shoulders, spreading your back and shoulders into the bench.
- Raise your chest and pinch your shoulder blades together.



ACTION

- Keeping your arms stationary, slowly straighten your elbows, bringing your hands in an arcing motion until they are approximately 1 foot or .3 m above your thighs.
- Slowly reverse the arcing motion bringing your hands back to the Start position.

Success Tips

- Keep your chest lifted and maintain a very slight arch in your lower back.
- Keep knees bent and feet flat on floor.
- Keep your upper arms motionless and your wrists straight.
- Tighten the triceps throughout the exercise, using controlled motion throughout the exercise.

Arm Exercises

Cross Triceps Extension

Muscles worked:
Triceps

Bench Position:
45° incline

Accessory:
Hand Grips

Pulleys:
Chest Bar



Success Tips

- Keep your upper arm motionless and your wrists straight.
- Keep your chest lifted, pinch your shoulder blades together and maintain a slight arch in lower back.
- Tighten the triceps throughout the exercise, using controlled motion.

START

- Sit facing away from the Power Rod® unit.
- Reach one hand over the opposite shoulder (right hand over left and vice versa) and grasp a Hand Grip. Bend your elbow until your hand is above your chest, palm facing the floor.
- With your free hand, stabilize the active hand at the elbow.

ACTION

- Keeping your upper arm stationary, straighten your elbow, slowly extending your arm outward, using an arcing motion and stopping approximately 90° from your chest.
- Keeping your triceps tightened, slowly reverse the arcing motion and bring your arm back to the Start position.

Lying 45° Triceps Extension – Elbow Extension

Muscles worked:
Triceps

Bench Position:
Flat Bench Back

Accessory:
Hand Grips

Pulleys:
Chest Bar



Success Tips

- Keep your upper arms motionless and your wrists straight throughout the entire exercise.
- Keep your chest lifted, spine aligned, and a slight arch in your lower back.
- Tighten the triceps throughout the exercise, using controlled motion.

START

- Lie flat on the Bench, head toward the Power Rod® unit. Keep your knees bent and your feet flat on the floor.
- Reach overhead and grasp the Hand Grips, palms facing up.
- Keep your elbows bent, bringing your upper arms to the front, at approximately a 45° angle from the front of your torso.

ACTION

- Keeping your upper arms stationary and next to your torso, straighten your arms in an arcing motion inward and down toward your legs.
- Fully straighten your arms and then, with a controlled motion, slowly bring your arms back to the Start position without moving your upper arms.

Arm Exercises

Seated Triceps Extension – Elbow Extension

Muscles worked:
Triceps

Bench Position:
Flat Bench Back

Accessory:
Hand Grips

Pulleys:
Chest Bar



START

- Sit facing away from the Power Rod® unit.
- Using an overhand grip, reach behind you and grasp the Hand Grips, bending your elbows until your hands are near the top of your head, palms facing up.
- Keep your arms in line with the cables.



ACTION

- Keeping your upper arms stationary, slowly straighten your elbows moving your arms in an arcing motion upward, over your head until they are approximately 90° from your torso.
- Stop the motion before your elbows are completely straight, and then reverse your motion, slowly returning to the Start position without relaxing muscle tension.

Success Tips

- Keep knees bent, feet flat on the floor.
- Lay your head back against the bench.
- Keep your chest lifted, shoulders pinched together, and a very slight arch in your lower back.
- Keep your upper arms and shoulders motionless and your wrists straight.
- Tighten the triceps throughout the exercise, using controlled motion

Standing Biceps Curl – Elbow Flexion (in supination)

Muscles worked:
Biceps

Bench Position:
Removed

Accessory:
Hand Grips

Pulleys:
Chest Bar



START

- Straddle the Seat Rail, facing the Power Rod® unit.
- Reach down and grasp the Hand Grips, palms facing forward.
- Straighten, keeping your arms by your sides, elbows loose.



ACTION

- Keeping your upper arms stationary and your elbows at your sides, slowly curl the Hand Grips forward, then upward and in towards your shoulders.
- Slowly reverse the arcing motion bringing your hands back to the Start position.

Success Tips

- Keep your chest lifted, abs tight and a very slight arch in your lower back.
- Keep your elbows at your sides and your wrists straight.

Arm Exercises

Seated Biceps Curl – Flexion (in supination)

Muscles worked:
Biceps

Bench Position:
Flat Bench Back

Accessory:
Hand Grips

Pulleys:
Chest Bar



START



FINISH

Success Tips

- Keep your upper body motionless and your wrists straight.
- Keep your chest lifted, trunk muscles tight and maintain a slight arch in lower back.
- Keep your spine aligned throughout movement

START

- Sit on the bench, facing the Power Rod® unit. Keep one foot flat on the floor, and bend the other leg, bringing your foot up onto the bench, knee slightly turned outward.
- With the arm on the same side as your lifted leg, reach forward and grasp a Hand Grip, keeping your elbow bent. Allow your upper arm (not elbow) to rest on the elevated knee.

ACTION

- Slowly curl your forearm up toward your shoulder, keeping the upper arm completely still.
- Keeping your biceps tightened, slowly reverse the curling motion and bring your arm back to the Start position.

Lying Biceps Curl – Elbow Flexion (in supination)

Muscles worked:
Biceps; Brachialis; Brachioradialis

Bench Position:
Flat Bench Forward

Accessory:
Hand Grips

Pulleys:
Chest Bar



START



FINISH

Success Tips

- Keep your upper arms motionless and your wrists straight throughout the entire exercise.
- Keep your chest lifted, spine straight, and a slight arch in your lower back.

START

- Sit on the bench, facing the Power Rod® unit. Keep your knees bent and feet flat on the floor.
- Grasp the Hand Grips, keeping your arms straight and palms up.
- Lie back completely with your head supported by the bench.

ACTION

- Curl the Hand Grip forward and up, toward your shoulder, making sure to keep your upper arm completely motionless and your elbows at your sides.
- Slowly bring your arm back to the Start position, maintaining the same arc of motion.

Arm Exercises

Seated Wrist Extension

Muscles worked:
Forearms

Bench Position:
Flat Bench Back

Accessory:
Hand Grips

Pulleys:
Chest Bar



START

- Sit facing the Power Rod® unit with your knees bent, feet together and flat on the bench. Sit far back enough on the bench to maintain physical and cable tension throughout exercise.
- Grasp the Hand Grips, palm facing down, and rest your mid-forearms on your lower thighs, keeping your elbows flared slightly to the side.



ACTION

- Slowly curl the back of your fists backward towards your forearms.
- Stop when wrists are 90° from forearms or when you experience discomfort.
- Slowly return to the Start position.

Success Tips

- Move slowly and keep tension in the back of the forearms at all times.
- Keep your chest lifted, trunk muscles tightened, and a very slight arch in your lower back.
- You may perform this exercise one arm at a time to make it easier to focus and isolate the back of your forearms, or with both arms simultaneously to save time

Standing Wrist Curl

Muscles worked:
Biceps; Forearms

Bench Position:
Removed

Accessory:
Hand Grips

Pulleys:
Chest Bar



START

- Straddle the Seat Rail, facing the Power Rod® unit.
- Reach down and grasp the Hand Grips, palms facing forward.
- Straighten, keeping your upper arms and elbows by your sides, elbows loose.
- Bend your elbows 90°, palms up, and maintain that position throughout the entire exercise.

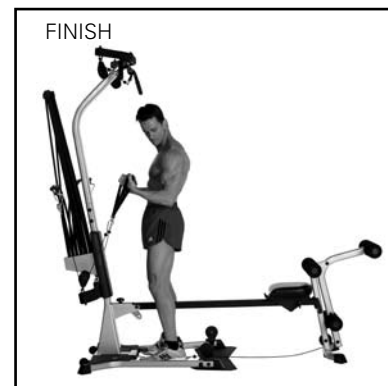

ACTION

- With your upper arms stationary and your elbows at your sides, slowly curl your fists toward the front of your forearms.
- Keeping your forearms still, slowly let your fists return to the Start position.

Success Tips

- Keep your chest lifted, trunk muscles tight and a very slight arch in your lower back.
- Move slowly, keeping tension in the front of your forearms at all times.
- Do not increase or decrease the bend in your elbow during this exercise—keep all motion in the wrist.
- Do not rock your body back and forth during wrist motion.

Arm Exercises

Reverse Curl – Elbow Flexion (in pronation)

Muscles worked:
Brachialis; Brachioradialis; Biceps

Bench Position:
Removed

Accessory:
Hand Grips

Pulleys:
Chest Bar



- START**
- Straddle the Seat Rail, facing the Power Rod® unit.
 - Reach down and grasp the Hand Grips, palms facing backward.
 - Straighten, keeping your upper arms and elbows by your sides, elbows loose.



- ACTION**
- Keeping your palms facing down, use your forearms to slowly bend your elbows, curling the Hand Grips forward, then upward and in towards your shoulders.
 - Keep your elbows at your sides and your upper arms completely still.
 - Slowly reverse the curling motion and bring your arms back to Start position.

Success Tips

- Keep your upper body motionless, elbows at your sides and your wrists straight.
- Keep your trunk muscles tight and maintain a slight arch in lower back.

Seated Wrist Curl – Wrist Flexion

Muscles worked:
Forearms

Bench Position:
Flat Bench Back

Accessory:
Hand Grips

Pulleys:
Chest Bar



- START**
- Sit facing the Power Rod® unit with your knees bent, feet together and flat on the bench. Sit far back enough on the bench to maintain physical and cable tension throughout exercise.
 - Grasp the Hand Grips, palm facing up, and rest your mid-forearms on your lower thighs, allowing the wrists to bend downward.



- ACTION**
- Slowly curl your fists towards the front of your forearms.
 - Return to the Start position slowly, without relaxing the muscle tension in your wrists.

Success Tips

- Move slowly, keeping tension in the front of the forearms at all times.
- Keep your chest lifted, trunk muscles tightened, and a slight arch in your lower back.
- You can perform this exercise one arm at a time to make it easier to focus and isolate the front of your forearms, or you can perform it with both arms simultaneously to save time.

Arm Exercises

Standing Wrist Extension

Muscles worked:
Forearms; Brachialis

Bench Position:
Removed

Accessory:
Hand Grips

Pulleys:
Chest Bar



Success Tips

- Move slowly and keep tension in the wrists at all times.
- Keep your chest lifted, trunk muscles tightened, and a very slight arch in your lower back.
- Do not increase or decrease the bend in your elbow—perform the entire motion at your wrist.
- Do not rock your body during this exercise.

START

- Straddle the Seat Rail, facing the Power Rod® unit.
- Reach down and grasp the Hand Grips, palms facing backward.
- Straighten, keeping your upper arms and elbows by your sides.
- Bend your elbows 90°, and hold that position for the duration of this exercise.

ACTION

- Slowly curl the back of your fists backward towards your forearms.
- Stop when wrists are 90° from forearms or when you experience discomfort.
- Keeping your forearms still, slowly return to the Start position.

“Rope” Pushdown — Elbow Extension

Muscles worked:
Triceps

Bench Position:
Removed

Accessory:
Hand Grips

Pulleys:
Lat Tower

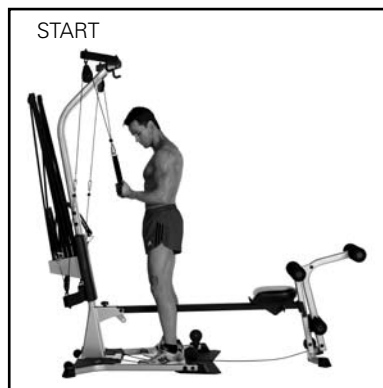

Success Tips

- Keep your upper arms motionless and your wrists straight.
- Keep your chest lifted, abs tight and maintain a slight arch in lower back.
- Tighten the triceps throughout the exercise, using controlled motion.
- Keep your chest lifted, trunk muscles tightened, and a very slight arch in your lower back.

START

- Straddle the Seat Rail, facing the Power Rod® unit.
- With each hand, grasp the opposite Hand Grip (right to left, etc.), palms facing down.
- Stand approximately 2-3 feet or .6-.9 m from Lat Tower (adjust for comfort).
- Cross the cables, palms facing each other, as if grabbing a rope.
- Keep your elbows bent, upper arms at your sides.

ACTION

- Keeping your upper arms stationary, elbows next to trunk, slowly straighten your arms downward, in a gentle arc, until hands are near tops of your thighs, hands and elbows straightened and directly in line with shoulders.
- Keeping your triceps tightened, slowly reverse the arcing motion and bring the Hand Grips back to the Start position.

Abdominal Exercises

Reverse Crunch – Spinal Flexion

Muscles worked:
Rectus Abdominus

Bench Position:
Flat Bench Back

Accessory:
None

Pulleys:
None



START



FINISH

Success Tips

- Keep your upper body, knees and hips stationary. Relax your neck.
- Tighten your abs before you move.
- Allow exhalation up and inhalation down without exaggerating breathing.
- Contract as far into the movement as possible. Lower under control. Keep abs tight during entire motion.

START

- Lie on the bench, head toward the Power Rod® unit, grasp bench for support.
- Bend your hips and knees until your legs are in a “seated” position as shown above—knees and hips at 90° angles.
- If maintaining this position is difficult, adjust to one you can maintain for the duration of this exercise. As you strengthen, this position will become easier.

ACTION

- Tighten your abs, and then slowly curly your hips toward your rib cage. Move as far as you can without using your legs to get momentum.
- Do not curl up onto your shoulder blades.
- Slowly reverse the motion, returning to the Start position without relaxing.

Resisted Reverse Crunch – Spinal Flexion

Muscles worked:
Rectus Abdominus; Obliques

Bench Position:
Flat Bench Forward

Accessory:
Ankle Cuffs

Pulleys:
Chest Bar



START



FINISH

Success Tips

- Allow exhalation up and inhalation down without exaggerating breathing.
- Do not ‘kick’ into the motion, but allow body to slowly initiate movement.
- Tighten your abs throughout the entire exercise, relaxing only at the end of each set. Keep hips and knees motionless.
- Move slowly to eliminate momentum.

START

- Face the Power Rod® unit, and attach an Ankle Cuff to each ankle.
- Lie back on the bench, head away from the Power Rod® unit.
- Bend your hips and knees at 90° angles, as shown.
- Reach behind your head and grasp the Seat.
- Relax your neck.

ACTION

- Tighten your abs and slowly curl your hips toward your rib cage. Move as far as you can without using your legs or curling onto your shoulder blades.
- Slowly reverse the motion, returning to the Start position without relaxing your abs.

Abdominal Exercises

Seated (Resisted) Abdominal Crunch – Spinal Flexion

Muscles worked:
Rectus Abdominus; Obliques

Bench Position:
45° incline

Accessory:
Hand Grips

Pulleys:
Chest Bar



START

- Grasp the Hand Grips in both hands, drawing them over your shoulders. Rest the back of your fists on your chest or shoulders, palms facing up.
- Lower back can start out flat or in a normal arch, knees and hips are bent and feet should be flat on the floor.



ACTION

- Tighten your abs and curl only your torso, slowly moving your ribs toward your hips. Move as far as you can without moving your hips or neck.
- Do not allow your lower back to lose contact with the bench during this entire exercise.
- Slowly reverse the motion, returning to the Start position without relaxing your abs.

Success Tips

- Do not lift your head or chin—your head should follow the rib motion rather than lead it. Maintain normal neck posture.
- Tighten your abs throughout the entire exercise, relaxing only at the end of each set.
- Move slowly to eliminate momentum.
- Allow exhalation up and inhalation down without exaggerating breathing.

Seated (Resisted) Oblique Abdominal Crunch – Spinal Flexion/Rotation

Muscles worked:
Rectus Abdominus; Obliques

Bench Position:
45° incline

Accessory:
Hand Grips

Pulleys:
Chest Bar



START

- Cross one arm over the opposite shoulder, grasp a Hand Grip, and rest the hand on your shoulder or chest, palm facing down.
- Lower back can start out flat or in a normal arch, knees and hips are bent and feet should be flat on the floor.



ACTION

- Tighten your abs on the side with the active arm, focusing on the side of your ribs to the front of your pelvis on that side.
- Slowly move diagonally, rotating torso away from the side holding the Hand Grip, ribs turned toward the front of your pelvis.
- Crunch as deeply as you can, keeping lower back on bench.
- Slowly reverse to the Start position without resting.

Success Tips

- Do not lift your head or chin—your head should follow the rib motion rather than lead it. Maintain normal neck posture.
- Tighten your abs throughout the entire exercise, relaxing only at the end of each set.
- Move slowly to eliminate momentum.
- Allow exhalation up and inhalation down without exaggerating breathing.

Abdominal Exercises

Trunk Rotation

Muscles worked:
Rectus Abdominus; Obliques;
Serratus Anterior

Bench Position:
Flat Bench Back

Accessory:
None

Pulleys:



Success Tips

- Keep chest lifted, shoulders pinched, abs tight and slight arch in lower back.
- This exercise must be performed correctly—failure to do so could result in injury. Use only low weight Rods.
- Keep all motion in your torso.
- Move only as far as your muscles will take you—do not use momentum to increase your range of motion

START

- Sit sideways on the bench, one side toward the Power Rod® unit. Grasp Hand Grip closest to you with both hands.
- Raise both arms up near shoulder level, hands extended over the leg closest to the Power Rod® unit.
- Keep your elbows slightly bent.

ACTION

- Tighten your entire abdominal area and slowly rotate your rib cage and arms away from the Power Rod® unit 30-40°, as if you were rotating with a rod through the middle of your spine.
- Slowly reverse the motion, returning to the Start position without relaxing muscle tension.

Leg Exercises

Squat — Knee Extension, Hip Extension, Ankle Plantarflexion

Muscles worked:
Although the squat is often considered a total body exercise, the glutes, adductors, hamstrings and quads are primary movers and the spinal erectors are key to stabilization.

Bench Position:
Removed.

Accessory:
Squat Bar – w/squat straps

Pulley Position:
Low Pulley



START

- Remove back support and place seat in free sliding position.
- Sit on seat facing Power Rod® unit and position bar across the shoulders (not on the neck). Maintain a grip on each side of the bar.
- Flatten your back, keep your chest up and position your feet in line with the cable/pulley.
- Place your feet wider than hip width and point your toes outward slightly. Direct the thighs to the same outward angle as the feet.

ACTION

- While keeping your back straight, tighten your abs and move to a standing position.
- Keep the pressure through the middle of the arches/feet.
- Using control, slowly squat down by sticking the hips out as the knees start to bend. Keep the chest up and back flat as the hips continue to move backward.
- Lower to approximately 90 degrees at the knees

Leg Exercises

Leg Extension

Muscles worked:
Quadriceps

Bench Position:
Leg Extension Seat

Accessory:
None

Pulleys:
Leg Extension

Leg Extension:
Engaged

Success Tips

- Use slow, controlled motion—do not “kick” into the extension.
- Do not let your knees rotate outward during the exercise. Keep kneecaps pointing up and straight forward.



START

- Sit on the Leg Extension Seat with your knees near the pivot point and the lower roller pads in front of your shins (see Start image above).
- Adjust your thighs to hip-width, pointing your knee caps forward.
- Grasp the sides of the seat to stabilize yourself.
- Sit up straight, chest lifted, abs tight and a slight arch in your lower back.



ACTION

- Tighten your quads and slowly straighten your legs, moving your feet forward then upward until your legs are completely straight and your kneecaps point upward to the ceiling.
- Slowly reverse the motion, returning to the Start position without relaxing your quads.

Lying Leg Extension

Muscles worked:
Quadriceps

Bench Position:
Flat Bench Forward

Accessory:
Ankle Cuff

Pulleys:
Chest Bar

Success Tips

- Keep your chest lifted, spine aligned, abs tight and a very slight arch in your lower back.
- Keep your upper thigh motionless throughout this exercise.



START

- Sit on bench, facing the Power Rod® unit. Secure Ankle Cuff around one ankle (don't cross cables).
- Lie back on the bench, head supported. Bend the active leg approximately 90° (tall users will need to modify this position).
- Clasp your hands around the active thigh behind the knee, and brace the inactive leg on the bench or the floor.



ACTION

- Slowly straighten your leg, moving only your knee and lower leg. Do not lock your knee.
- Slowly return to the Start position without relaxing your quadriceps.

Leg Exercises

Ankle Eversion

Muscles worked:
Peroneals

Bench Position:
Flat Bench Forward

Accessory:
Ankle Cuff

Pulleys:
Chest Bar Pulleys



START

- Sit on the Bench, with one side to the Power Rod® unit.
- Attach an Ankle Cuff around the ball of the outside foot (furthest from pulley).
- Straighten the attached leg and sit up straight.
- Allow the foot to rotate toward the Power Rod® unit, keeping tension in the cables.



ACTION

- Slowly rotate your foot outward, away from Power Rod® unit.
- Then, maintaining tension, slowly return to the Start position.

Success Tips

- Movement should occur only at the ankle—keep the rest of your body motionless.
- Keep abs tight and do not lift your hips or excessively arch your back.
- You should feel tension in the outside of your calf throughout the entire motion

Ankle Inversion

Muscles worked:
Tibialis Anterior and Posterior

Bench Position:
Flat Bench Forward

Accessory:
Ankle Cuff

Pulleys:
Chest Bar Pulleys



START

- Sit on the Bench, with one side to the Power Rod® unit.
- Attach an Ankle Cuff around the ball of the inside foot (closest to pulley).
- Straighten the attached leg and sit up straight.
- Allow the foot to rotate toward the Power Rod® unit, keeping tension in the cables.



ACTION

- Slowly rotate your foot outward, away from Power Rod® unit.
- Then, maintaining tension, slowly return to the Start position.

Success Tips

- Movement should occur only at the ankle—keep the rest of your body motionless.
- Keep abs tight and do not lift your hips or excessively arch your back.
- You should feel tension in the inside of your calf throughout the entire motion

Leg Exercises

Standing Hip Extension – (knee flexed)

Muscles worked:
Gluteus Maximus

Bench Position:
Removed

Accessory:
Ankle Cuff

Pulleys:
Chest Bar



Success Tips

- Keep your chest lifted, spine aligned, abs tight and a very slight arch in your lower back.
- Do not bend from waist or lower back.

START

- Stand to one side of the Seat Rail, facing the Power Rod® unit.
- Secure the Ankle Cuff around the ankle furthest from the rail. Bend this leg approximately 90°.
- Bend forward 30-40° from your hips (not your waist) and very slightly bend the knee of your supporting leg.

ACTION

- Initiate the movement by tightening your glutes and slowly pivoting your leg from your hip. Move your entire leg backward, to a straight position.
- Slowly move your leg as far as you can, without allowing any movement at the waist or lower back.
- Slowly return to Start position.

Standing Hip Extension – (knee stabilized)

Muscles worked:
Gluteus Maximus; Biceps Femoris;
Semimembranosus; Semitendinosus

Bench Position:
Removed

Accessory:
Ankle Cuff

Pulleys:
Chest Bar



Success Tips

- Keep your chest lifted, spine aligned, abs tight and a very slight arch in your lower back.
- Do not bend from waist or lower back.
- Keep your knee stabilized in the 90° angle position.

START

- Stand to one side of the Seat Rail, facing the Power Rod® unit.
- Secure the Ankle Cuff around the ankle furthest from the rail.
- Bend forward 30-40° from your hips (not your waist) and very slightly bend the knee of your supporting leg.

ACTION

- Initiate the movement by tightening your glutes and slowly pivoting your leg from your hip. Move your entire leg backward and then lift it slightly behind you.
- Slowly move your leg as far as you can, without allowing any movement at the waist, knee or lower back.
- Slowly return to Start position.

Leg Exercises

Standing Hip Abduction

Muscles worked:
Gluteus Maximus

Bench Position:
Removed

Accessory:
Ankle Cuff

Pulleys:
Chest Bar



Success Tips

- Keep your chest lifted, spine aligned, abs tight and a slight arch in your lower back.
- Do not bend from waist or lower back.
- Keep your abs tight throughout movement.
- Keep working leg straight or only very slightly bent.
- Use only a small range of motion.

START

- Stand to one side of the Seat Rail, one side next to Power Rod® unit.
- Secure Ankle Cuff around the ankle furthest from the Power Rod® unit. Keep leg straightened, but knee loose.
- Adjust your position so that there is some tension in the cables at the start of this exercise.
- You may use your hand on the Lower Lat Tower or Chest Bar to stabilize movement.

ACTION

- Slowly move the attached leg outward, away from the Power Rod® unit, at a 30-45° angle, keeping your hips and spine motionless.
- Slowly return to the Start position without relaxing tension in your leg.
- Keep your hips level during movement.

Seated Hip Adduction

Muscles worked:
Adductor Longus; Gluteus Medius

Bench Position:
Flat Bench Back

Accessory:
Ankle Cuff

Pulleys:
Chest Bar



Success Tips

- Do not cross the attached leg in front of the stabilized leg.
- Keep abs tight and do not lift your hips or excessively arch your back.
- Keep your spine straight and your hips level—do not raise your hips during motion.
- Use only a small range of motion.

START

- Sit sideways on the bench and attach an Ankle Cuff to the ankle closest to the Power Rod® unit.
- Sit far enough from the Power Rod® unit that there is tension in the cable at the start of the exercise.
- Lift leg with cuff in front of you, at a 45° angle from your trunk (toward Power Rod® unit)—do not lock your knee.
- You may hold onto the bench for added stability.

ACTION

- Slowly allow the attached leg to move inward, toward the center as you face forward, keeping your hips and spine perfectly still.
- Keeping the leg still, slowly move it back into the Start position.

Leg Exercises

Seated Hip Abduction

Muscles worked:
Piriformis; Gluteus Maximus

Bench Position:
Flat Bench Forward

Accessory:
Ankle Cuff

Pulleys:
Chest Bar



START

- Sit sideways on the bench and attach an Ankle Cuff to the ankle farthest from the Power Rod® unit.
- Sit far enough from the Power Rod® unit that there is tension in the cable at the start of the exercise.
- Lift leg with cuff in front of you, at a 45° angle from your trunk (toward Power Rod® unit)—do not lock your knee.
- You may hold onto the bench for added stability.



ACTION

- Slowly allow the attached leg to move outward, away from the Power Rod® unit, keeping your hips and spine perfectly still.
- Keeping the leg still, slowly move it back into the Start position.

Success Tips

- Keep your spine straight and your hips level—do not raise your hips during motion.
- Use only a small range of motion.
- Keep your hips motionless throughout this exercise.

Standing Leg Kickback — Hip and Knee Extension

Muscles worked:
Gluteus Maximus

Bench Position:
Removed

Accessory:
Ankle Cuff

Pulleys:
Chest Bar



START

- Stand to one side of the Seat Rail, facing the Power Rod® unit.
- Secure the Ankle Cuff around the ankle furthest from the rail. Bend this leg approximately 90°.
- Bend forward 30-40° from your hips (not your waist) and very slightly bend the knee of your supporting leg.



ACTION

- Extend the active leg backwards, straightening the knee.
- Slowly move your leg as far as you can, without allowing any movement at the waist, knee or lower back.
- Slowly return to the Start position.

Success Tips

- Keep your chest lifted, spine aligned, abs tight and a very slight arch in your lower back.
- Do not bend from waist or lower back.

Muscle Chart

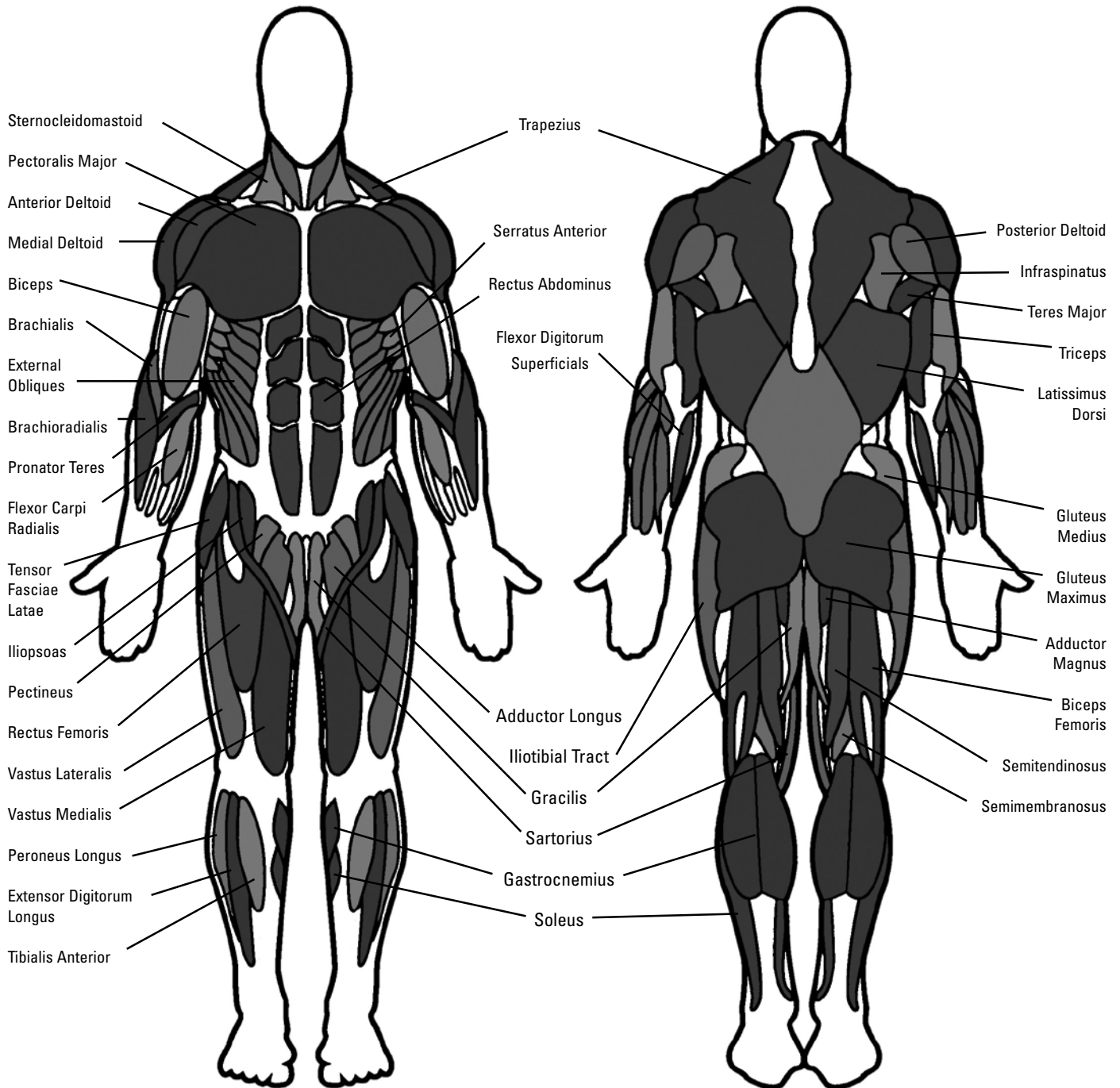

The Bowflex® Body Leanness Program

By Ellington Darden, Ph.D.

The following program was created by Dr. Ellington Darden. It contains a rigorous fitness and dietary program. Please consult your physician before beginning any fitness or dietary program.

Some of the names of the exercises listed in this program have been changed in order to match the names of the exercises in this manual. The exercises themselves have not been changed, in order to preserve the integrity of Dr. Darden's Study.

**FAST FAT LOSS
NOW!**



Introduction

The Bowflex® Body Leanness Program

This program is scientifically designed for maximal fat loss over six weeks. It is important that you practice every aspect of the plan to achieve optimum results.

The program separates into three two-week stages. During each stage you will exercise, control the number and quality of calories you consume, and drink plenty of ice-cold water.

Before starting the exercise routine you must be familiar with your Bowflex Conquest™ home gym. You should experiment with finding the proper amount of resistance to use on each exercise. You should be able to perform 8 repetitions, but not more than 12 repetitions, for each exercise. It is essential that you learn how to perform each movement before trying a complete circuit, because part of the effectiveness of the training depends on minimal rest between each exercise.



WARNING

CONSULT YOUR PHYSICIAN BEFORE STARTING THIS PROGRAM. Show this plan and your Bowflex Conquest™ home gym Owner's Manual to your physician. Only he or she can determine whether this course is appropriate for your particular age and condition. If while using the Bowflex Conquest™ home gym, you have any pain or tightness in your chest, an irregular heart beat, shortness of breath, feel faint, light-headed or dizzy or have any pain or discomfort, STOP and consult your physician immediately.

Certain people who should not try this program--including children and teenagers; pregnant women; women who are breast feeding; diabetics; individuals with certain types of heart, liver, or kidney disease; and those suffering from certain types of arthritis. This is not an all-inclusive list. You may have a condition that would make this program unsafe for you. Play it safe and consult a healthcare professional before starting the program.

A Personal Guarantee From Dr. Ellington Darden

Dear Bowflex® Enthusiast,

I'm excited, really excited! I'm elated because I've developed an exercising and eating program that produces fat loss faster than any plan I've ever tested.

The men involved in my research, for example, had an average fat loss of 27.95 pounds (12.68 kg) per man. Women on the same program averaged a reduction of 16.96 pounds (7.69 kg). Best of all, these dramatic results were achieved—not in six months—but in only six weeks!

That's right. Similar results can be accomplished by you in six short weeks, which include just 18 workouts (3 per week) on the Bowflex® machine.

Bowflex® home gym was a significant part of the results. The exercises performed on it allowed the participants to build muscle, which accelerated their metabolisms, and produced faster and greater fat losses.

The plan worked so well that it became known as The Bowflex® Body Leanness Program.

Leanness means to strip away the fat from under the skin as well as at deeper levels. Leanness also implies a pleasing shape and tone to the skeletal muscles.

You might say leanness is the opposite of fatness because the people involved in my research certainly got rid of their excessive fatness in record time.

All the guidelines that were applied have been organized in the booklet you are now holding in your hands. It's the next best thing to actually going through one of my research projects. In fact, it's probably better since nothing is experimental. All of the fine points have been tried, tested and proven effective.

If you are overfat, and if you are interested in doing this program, there are several things that you need to understand about my experience. Since 1965, I've trained more than 10,000 overfat individuals. After many years of pushing, coaxing, and listening to these trainees, certain traits became evident to me:

- People are not lazy by choice. They are forced into it by the confusion that surrounds the abundance of fitness information that is available. If these individuals are given simple decisive instructions, they will train very intensely.
- People, if they are provided with specific menus, will drastically alter their eating habits.
- Most of these people, however, will do neither of these challenging things for more than a week—unless they quickly see and feel changes in their body.

The Bowflex® Body Leanness Program emerged from these findings. For you to get the best-possible results, you must be willing to exercise very intensely on the Bowflex® machine and adhere to a strict eating plan.

In return, you'll get simple exercise instructions, specific menus to use, and my guarantee that if you follow the program exactly as directed, you'll observe the pounds and inches disappear on almost a weekly basis.

Now it's your turn to get excited, and get started!

Sincerely,



Dr. Ellington Darden

Measurements

If you would like to measure your personal before-and-after results, there are several steps you need to take. It is important that you accurately perform each task, then at the end of the six-week program, repeat the process in the same manner.

Body Weight:

Remove clothing and shoes and record your weight to the nearest quarter pound or hundred grams. Be sure to use the same scale when weighing yourself at the end of the six-week program. For the most accurate recordings, weigh yourself nude in the morning.

Since the program is divided into three two-week segments, you may want to weigh yourself at the end of each two-week period. Understand, however that weight loss is not the best way to determine your success. Fat loss is the key component. To determine the amount of fat you've lost, you'll need to follow the instructions in the next section.

Enter your starting weight on the RESULTS SUMMARY SHEET provided.

Circumference of Body Parts:

For an even better idea of the changes that will occur to your body in the next six weeks, it is necessary to measure the circumference of certain body parts. This will tell you where the fat is shrinking and what areas are toning up.

Use a plastic tape to measure the following:

- 1) **Upper arms** — hanging and relaxed, midway between the shoulder and elbow.
- 2) **2" (5 cm) above navel** — belly relaxed.
- 3) **At navel** — belly relaxed.
- 4) **2" (5 cm) below navel** — belly relaxed.
- 5) **Hips** — feet together at maximum protrusion of buttocks.
- 6) **Thighs** — high, just below the buttocks crease with legs apart and weight distributed equally on both feet.

Record each measurement on your Results Summary Sheet.

Women Measure:

Suprailium, triceps, and thigh.

Men Measure:

Chest, abdomen, and thigh.

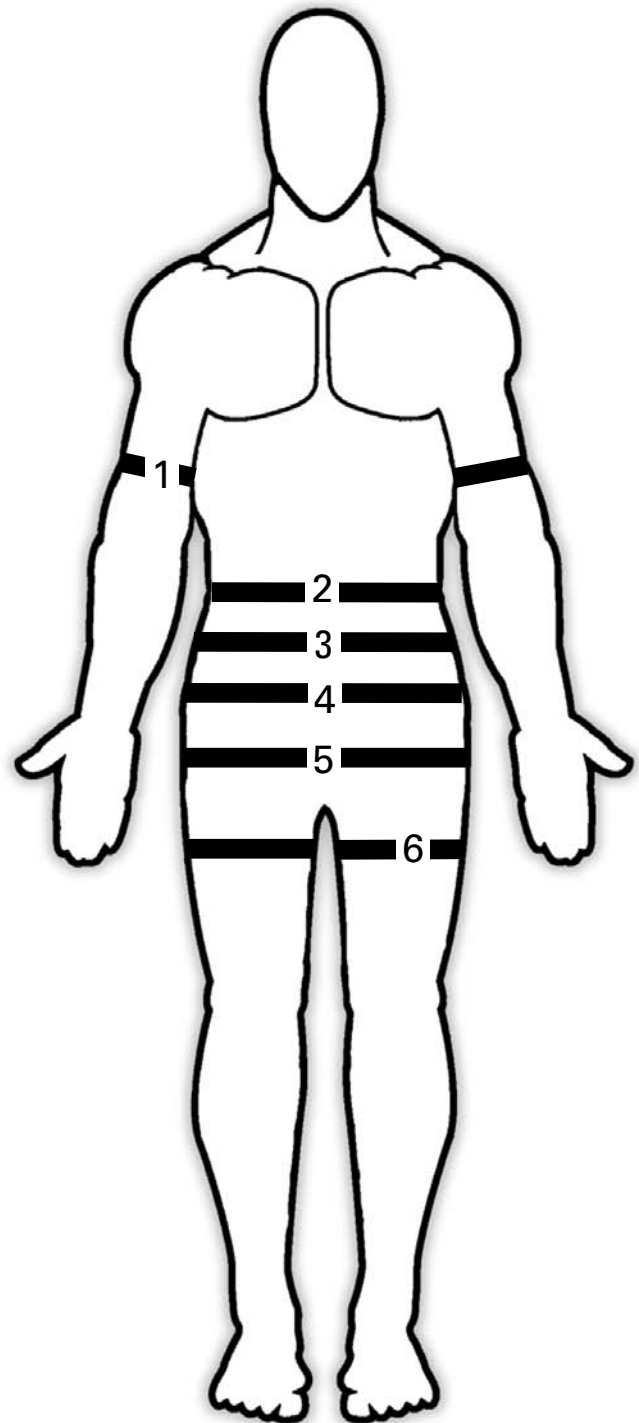

Measurements

Skinfold Measurements

To accurately track your progress through this six-week program, it is necessary to take skinfold measurements. By measuring yourself in this way, you will be able to determine your lean-body mass and your body-fat percentage. The goal of this program is to increase your lean-body mass and decrease your body-fat percentage.

Please read this section carefully. Proper measuring techniques are essential to track your success. It is best to have someone measure you. Measuring yourself can lead to inaccurate results.

Women Measure: Suprailium, Triceps, and Thigh



Suprailium

Stand relaxed. Pick up a diagonal skinfold just above the crest of the hip bone on the right side of the waist.



Triceps

Stand with right elbow flexed 90 degrees and locate the center of the back of the upper arm midway between the shoulder and the elbow. Relax arm at your side. Pick up skinfold as pictured.



Thigh

Stand relaxed with most of the weight on your left leg. Pick up a skinfold in the vertical plane on the front side of the right thigh, midway between the hip and knee joints.

Men Measure: Chest, Abdomen and Thigh

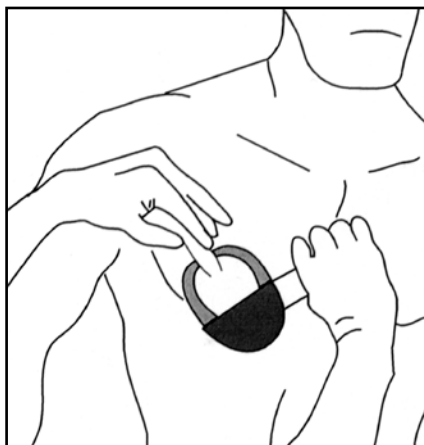

Chest

Stand relaxed. Pick up a diagonal skinfold over the right pectoralis muscle, midway between the armpit and the nipple.



Abdomen

Stand relaxed. Pick up a vertical skinfold on the right side of the navel.

Measurements

Using Calipers When Measuring Skinfolts

The procedure for measuring skinfold thickness is to grasp firmly with the thumb and forefinger a fold of skin and surface fat and pull it away from the underlying muscle. Take the caliper in your other hand and open the jaws. Clamp the jaws over the pinched skin and fat. The jaws exert constant tension at the point of contact with the skin. The thickness of the double layer of skin and fat can then be read directly from the caliper, which is marked in millimeters.

Women

Suprailium _____

Triceps _____

Thigh _____

Total _____

Men

Chest _____

Abdomen _____

Thigh _____

Total _____

Use these figures on the following chart to determine your body-fat percentage and enter the number on the line below.

Starting body-fat percentage _____

Optional Picture Taking

Pictures can be the most exciting evaluation you can do. The numbers and the tape measurements are great, but actually seeing differences from comparison photographs of yourself is quite satisfying.

Taking full-length photographs is not difficult, but to see the maximum difference between before and after, you should follow these guidelines.

- 1) Keep everything the same. Wear the same outfit, a snug solid color is best, and have the person taking the picture stand in the same place, with the same setting behind you.
- 2) Make sure you stand against an uncluttered, light background.
- 3) Have the person taking the photograph move away from you until he can see your entire body in the viewfinder.
- 4) Stand relaxed for three pictures, front, right side, and back. Do not try to suck in your stomach.
- 5) Interlace your fingers and place them on top of your head, so the contours of your torso will be plainly visible. Keep your feet 8" (20 cm) apart in all three pictures.
- 6) When you get the film developed tell the processors to make your after photos the same size as your previous ones. This way, your height in both sets of photos is equal and more valid comparisons can be made.

Determining Your Body Fat

To Use The Nomogram:

- 1) Locate the sum of your three skinfolds in the right column and mark it.
- 2) Locate your age in years on the far left column and mark it.
- 3) Connect the two marks with a straightedge. Where the straightedge intersects the line in the middle column appropriate to you, you will find your body-fat percentage.

Baun, W.D, Baun, M.R., and Raven, P.B. A nomogram for the estimate of percent body fat from generalized equations. Research Quarterly for Exercise and Conquest® , 52:380-384, 1981.

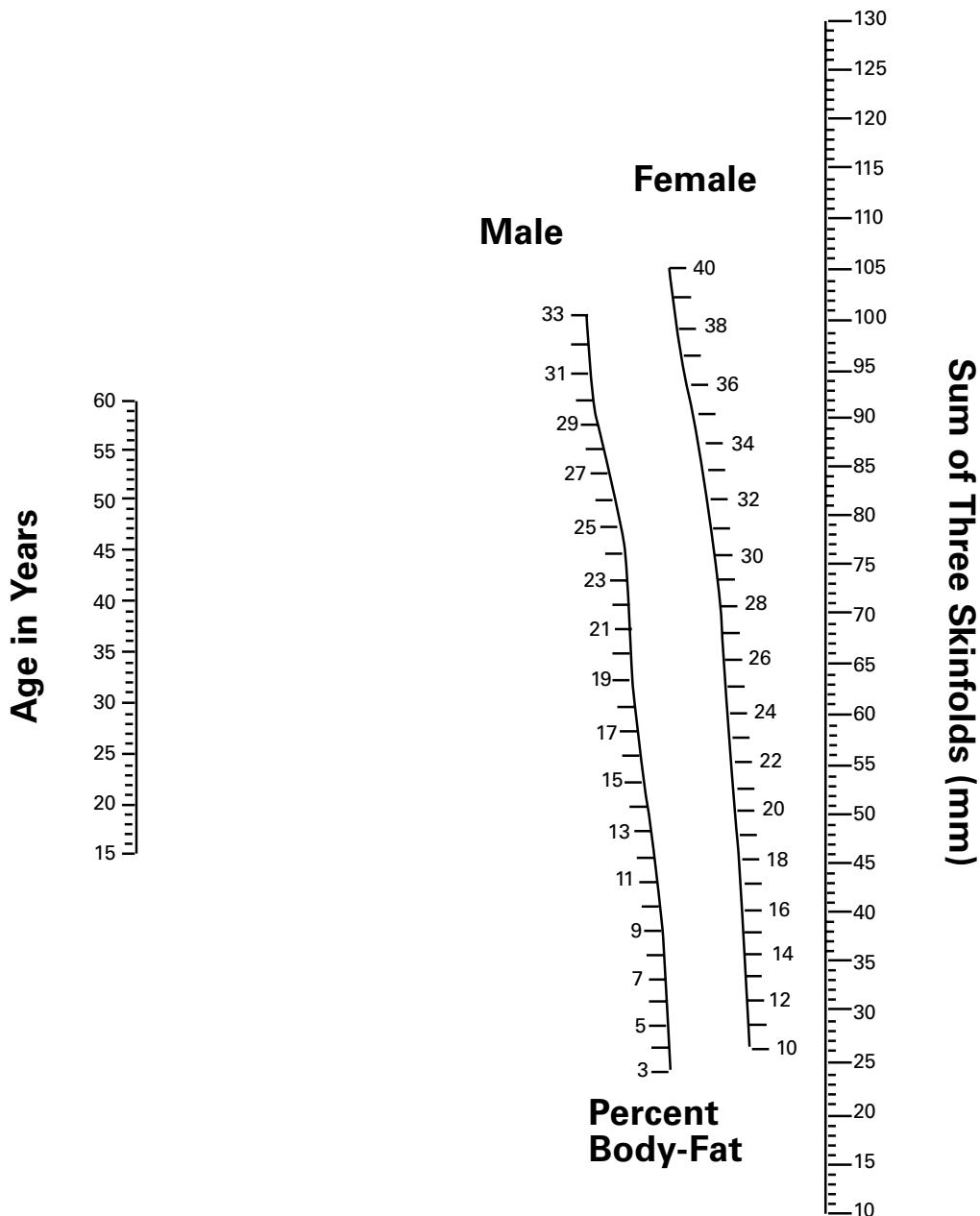

Calculating Lean Body Mass

Now that you know your body-fat percentage, you can calculate your lean-body percentage. This will eventually show you how many pounds of muscle were added to your body, after completing the program.

For Example:

Before the program, Joe weighs 200 pounds (90.7 kg) and measures 30% fat, which amounts to 60 pounds (27.2 kg). Thus, his lean-body mass is 70%, or 140 pounds (63.5 kg).

After the program, Joe weighs 180 pounds (81.6 kg) and is 20% fat, which equals 36 pounds (16.3 kg). His lean-body mass is 80%, or 144 pounds (65.3 kg).

Simple calculations allow us to find the amount of fat Joe lost, and the amount of muscle Joe gained. Before fat weight (60 pounds), minus after fat weight (36 pounds) equals 24 pounds (10.8 kg) of fat lost. After lean-mass weight (144 pounds) minus before lean-mass weight (140 pounds) equals 4 pounds (1.8 kg) of muscle gained.

Enter Your Information Here: *(Pounds or Kilograms)*

Before

Body Weight		Fat Percentage		Body Fat Weight
<input style="width: 100px; height: 25px;" type="text"/>	X	<input style="width: 100px; height: 25px;" type="text"/>	=	<input style="width: 100px; height: 25px;" type="text"/>
Body Weight		Weight of Body Fat		Lean-Body Weight
<input style="width: 100px; height: 25px;" type="text"/>	-	<input style="width: 100px; height: 25px;" type="text"/>	=	<input style="width: 100px; height: 25px;" type="text"/>

Use the Same Factors to Calculate After Six Weeks.

After

Body Weight		Fat Percentage		Body Fat Weight
<input style="width: 100px; height: 25px;" type="text"/>	X	<input style="width: 100px; height: 25px;" type="text"/>	=	<input style="width: 100px; height: 25px;" type="text"/>
Body Weight		Weight of Body Fat		Lean-Body Weight
<input style="width: 100px; height: 25px;" type="text"/>	-	<input style="width: 100px; height: 25px;" type="text"/>	=	<input style="width: 100px; height: 25px;" type="text"/>

Final Results

Before Body Fat Weight		After Body Fat Weight		Total Fat Lost
<input style="width: 100px; height: 25px;" type="text"/>	-	<input style="width: 100px; height: 25px;" type="text"/>	=	<input style="width: 100px; height: 25px;" type="text"/>
After Lean-Mass Weight		Before Lean-Mass Weight		Total Lean-Mass Gained
<input style="width: 100px; height: 25px;" type="text"/>	-	<input style="width: 100px; height: 25px;" type="text"/>	=	<input style="width: 100px; height: 25px;" type="text"/>

Your Results Summary Sheet

Name _____ Age _____

Height _____ Weight Loss _____

Weight Before _____ Muscle Gain _____

Weight After _____ Fat Loss _____

Please follow the instructions in the "Measurements" section for measuring circumferences.

Measurements	Before	After	Difference
Right Arm	_____	_____	_____
Left Arm	_____	_____	_____
2" (5 cm) Above Navel	_____	_____	_____
Navel	_____	_____	_____
2" (5 cm) Below Navel	_____	_____	_____
Hips	_____	_____	_____
Right Thigh	_____	_____	_____
Left Thigh	_____	_____	_____
		Total	_____
Percent Body Fat	_____	_____	_____

If you wish to send in your results to the Bowflex Division, please send to: Bowflex® Results, 16400 SE Nautilus Drive, Vancouver, Washington, USA 98683. Or you may fax this sheet to Bowflex Results at 1-360-694-7755. Please include your name, address, and phone number. Submissions may be selected for use in promotional marketing materials.

The Workouts

GUIDELINES Week 1&2

All exercises should be practiced with one set of 8 to 12 repetitions. The style of performance is very important. The movement for each repetition should be 4 seconds in the positive phase and 4 seconds in the negative. Keep the motion slow and smooth. When 12 repetitions are accomplished, increase the resistance by approximately 5 percent. Keep the time between exercises to a minimum, no longer than **60** seconds. No workout should take more than 30 minutes to complete. Perform each workout three days a week.

Exercise	Sets	Reps
Leg Extension	1	8-12
Bench Press	1	8-12
Lying Biceps Curl	1	8-12
Seated Shoulder Press	1	8-12
Seated Abdominal Crunch	1	8-12

GUIDELINES Week 3&4

All exercises should be practiced with one set of 8 to 12 repetitions. The style of performance is very important. The movement for each repetition should be 4 seconds in the positive phase and 4 seconds in the negative. Keep the motion slow and smooth. When 12 repetitions are accomplished, increase the resistance by approximately 5 percent. Keep the time between exercises to a minimum, no longer than **45** seconds. No workout should take more than 30 minutes to complete. Perform each workout three days a week.

Exercise	Sets	Reps
Leg Extension	1	8-12
Bench Press	1	8-12
Lying Biceps Curl	1	8-12
Seated Shoulder Press	1	8-12
Rear Deltoid Rows*	1	8-12
Seated Triceps Extension	1	8-12
Seated Abdominal Crunch	1	8-12

GUIDELINES Week 5&6

All exercises should be practiced with one set of 8 to 12 repetitions. The style of performance is very important. The movement for each repetition should be 4 seconds in the positive phase and 4 seconds in the negative. Keep the motion slow and smooth. When 12 repetitions are accomplished, increase the resistance by approximately 5 percent. Keep the time between exercises to a minimum, no longer than **30** seconds. No workout should take more than 30 minutes to complete. Perform each workout three days a week.

Exercise	Sets	Reps
Leg Extension	1	8-12
Leg Press	1	8-12
Bench Press	1	8-12
Lying Biceps Curl	1	8-12
Lying Shoulder Pullover	1	8-12
Reverse Fly	1	8-12
Rear Deltoid Rows*	1	8-12
Seated Triceps Extension	1	8-12
Seated Abdominal Crunch	1	8-12

* The Upright Row exercise was used in Dr. Darden's original study. Although many people have used this exercise for years, recent information in the Physical Therapy field has caused the authors of this manual to caution against performing this exercise because of the unnatural twisting movement created in the shoulder joint. We suggest you substitute Rear Deltoid Rows for the upright Row exercise.

Eating Guidelines

You will be following a reduced-calorie nutrition program, which is divided into three two-week segments. The program is a proven method for achieving maximal fat loss over a six-week period. It consists of a carbohydrate-rich, descending-calorie eating plan, and a superhydration routine.

Follow a Carbohydrate-Rich, Descending-Calorie Eating Plan:

Approximately 60 percent of the daily calories should be from carbohydrates. The other 40 percent will be equally divided between proteins and fats. The 60:20:20 ratio of carbohydrates, proteins, and fats is ideal for maximum fat loss.

Keep Menus Simple and Food Substitutions to a Minimum:

Research has established that successful dieters prefer the same foods each day for breakfast and lunch. They like variety, however, for dinner. Detailed menus and food choices are included later in this manual.

If you must vary from the menu items, try to stay within the 60:20:20 ratio of carbohydrates, proteins and fats.

For Example			
Daily Amount Calories	Carbohydrate 60%	Protein 20%	Fat 20%
2000	1200	400	400
1900	1140	380	380
1800	1080	360	360
1700	1020	340	340
1600	960	320	320
1500	900	300	300
1400	840	280	280
1300	780	260	260
1200	720	240	240
1100	660	220	220
1000	600	200	200

Avoid Too Much Stress:

Too much stress of any kind can cause the body to actually preserve fat stores. You should relax more. An after-dinner walk at a leisurely pace is helpful. Extra sleep is suggested, since sleep facilitates fat loss and muscle recovery. Furthermore, to keep the body well rested, ***no other exercises or activities are allowed during the six-week program.*** This is a scientifically proven program that works. More is not better. Any additional exercise other than the amount recommended can and will harm your fat loss.

Superhydrate Your System

Drinking plenty of water is essential to the success of this program. Drinking the recommended amount of water can seem like a challenge at first. Stick with it. Carry a large sport bottle or similar item with you throughout the day. After several weeks, you will find that you actually thirst for more and more water, and the amounts recommended are easily reached.

Superhydration aids fat loss in a number of ways. First, the kidneys are unable to function without adequate water. When they do not work to capacity some of their load is dumped onto the liver.

This diverts the liver from its primary function, which is to metabolize stored fat into usable energy. Because it's performing the chores of the water-depleted kidneys, the liver metabolizes less fat.

Second, overeating can be averted through water intake, as water can keep the stomach feeling full and satisfied between meals.

Third, ice-cold water requires calories to warm it to core body temperature. In fact, ***1 US gallon of ice cold water (3.8 l) generates 123 calories of heat energy.***

You'll be drinking from 1 to 1 5/8 US gallons (3.8 - 6.2 liters) of water each day on the following superhydration schedule:

Week 1 = drink four 32-oz. bottles (3.8 liters) of ice-cold water per day.

Week 2 = drink four and a half 32-oz. bottles (4.3 liters) of ice-cold water per day.

Week 3 = drink five 32-oz. bottles (4.6 liters) of ice-cold water per day.

Week 4 = drink five and a half 32-oz. bottles (5.2 liters) of ice-cold water per day.

Week 5 = drink six 32-oz. bottles (5.7 liters) of ice-cold water per day.

Week 6 = drink six and a half 32-oz. bottles (6.2 liters) of ice-cold water per day.

Don't be surprised if you have to make more than a dozen trips to the restroom, especially during the first week of the program. Remember, your body is an adaptive system, and it will soon accommodate the increased water consumption.

Note: Although it is doubtful that you could ever drink too much water, a few ailments can be negatively affected by large amounts of fluid. For example, anyone with a kidney disorder, or anyone who takes diuretics, should consult a physician before going on the recommended water-drinking schedule. If you have any doubts about the recommendations, play it safe and check with your doctor.

The Eating Plan

The menus in the Bowflex® eating plan are designed for maximum fat-loss effectiveness and nutritional value. For best results, follow them exactly.

Every attempt has been made to utilize current popular brand names and accurate calorie counts, which are listed in the menus. But as you probably realize the products are sometimes changed or discontinued. If a listed item is not available in your area, you'll need to substitute a similar product. Become an informed label reader at your supermarket. Ask questions about any products you don't understand. Supermarket managers are usually helpful. If they don't have an answer to your question, they will get it for you.

Each day you will choose a limited selection of foods for breakfast and lunch. Most people can consume the same basic breakfast and the same basic lunch for months with little modification. Ample variety during your evening meal, however, will make daily eating interesting and enjoyable. Additionally, the eating plan includes a mid-afternoon and late-night snack to keep your energy high and your hunger low.

Begin Week 1 on Monday and continue through Sunday. Week 2 is a repeat of Week 1. Calories for each food are noted in parentheses. A shopping list follows.

The eating plan for the next six weeks descends:

Week 1 & 2:

Men 1500 calories per day.

Women 1200 calories per day.

Week 3 & 4:

Men 1400 calories per day.

Women 1100 calories per day.

Week 5 & 6:

Men 1300 calories per day.

Women 1000 calories per day.

You'll always have a 300 calorie breakfast, a 300 calorie lunch, and a 300 calorie dinner (women), or 500 calorie dinner (men). With each two-week descend, only your snack calories will change: from 400 to 300 to 200 calories per day (men), or 300 to 200 to 100 calories per day (women). For each of your five daily meals, you'll have at least three choices.

Everything has been simplified so even the most kitchen-inept man or woman can succeed. Very little cooking is required. All you have to do is read the menus, select your food choices, and follow the directions. It's as simple as that.

If you find that you wish to vary from the outline menu items try to stay with in the 60:20:20 ratio of carbohydrates, proteins, and fats.

The Eating Plan - US Measurements

Breakfast = 300 calories

Choice of bagel, cereal or shake.

Bagel

1 plain bagel, Sarah Lee® (frozen) (210)
3/4 oz. light cream cheese (45)
1/2 C. orange juice, fresh or frozen (55)
Any beverage without calories, caffeine, or sodium, such as decaffeinated coffee or tea.

Cereal

1.5 oz. (42 grams) serving equals approximately 165 calories.
Choice of one: Kellogg's® Low Fat Granola (without raisins), General Mills® Honey Nut Clusters, General Mills® Basic 4
1/2 C. skim milk (45)
3/4 C. orange juice (82)
Noncaloric beverage

Shake (choice of one shake)

Place ingredients in blender. Blend until smooth.

Banana-Orange Shake

1 large banana (8 3/4 inches long) (100)
1/2 C. orange juice (55)
1/2 C. skim milk (45)
2 T. wheat germ (66)
1 t. safflower oil (42)
2 ice cubes (optional)

or Chocolate or Vanilla Shake

1 packet Carnation® Instant Breakfast, Champion UltraMet®, or another diet shake powder that contains the appropriate calories (100)
1 C. skim milk (90)
1/2 large banana (8 3/4 inches long) (50)
1 t. safflower oil (42)
1 t. Carnation® Malted Milk powder (20)
2 ice cubes (optional)

Lunch = 300 calories.

Choice of sandwich, soup or salad.

Sandwich

2 slices whole wheat bread (140)
2 t. Promise Ultra® Vegetable Oil Spread (24)
2 oz. white meat (about 8 thin slices), chicken or turkey (80)
1 oz. fat-free cheese (1 1/2 slices) (50)
(Opt.: Add to bread 1 t. Dijon mustard (0)
Noncaloric beverage
Soup (choice of one soup)

• Healthy Choice® Hearty Chicken, 15-oz. can (260), or
• Campbell's® Healthy Request Hearty Vegetable Beef, 16-oz. can (260)
1/2 slice whole-wheat bread (35)
Noncaloric beverage

Chef Salad

2 C. lettuce, chopped (20)
2 oz. white meat, chicken or turkey (80)
2 oz. fat-free cheese (100)
4 slices tomato, chopped (28)
1 T. Italian, fat-free dressing (6)
1 slice whole wheat bread (70)
Noncaloric beverage

Mid-Afternoon Snack

Men—200 calories for Weeks 1&2;
150 calories for Weeks 3&4;
100 calories for Weeks 5&6.
Women—150 calories for Weeks 1&2;
100 calories for Weeks 3&4;
50 calories for Weeks 5&6.

Choose calories from:

1 large banana (8 3/4 inches long) (100)
1 apple (3-inch diameter) (100)
1/2 cantaloupe (5-inch diameter) (94)
5 dried prunes (100)
1 oz. (2 small 1/2 oz. boxes) raisins (82)
1 C. light, nonfat, flavored yogurt (100)

Dinner

Men—500 calories, **Women**—300 calories

Choice of tuna salad dinner, steak dinner or frozen microwave dinner.

Tuna Salad Dinner

In a large bowl, mix the following:
1 6-oz. can chunk light tuna in water (180)
1 T. Hellmann's® Light, Reduced-Calorie Mayonnaise (50)
2 T. sweet pickle relish (40)
1/4 C. whole kernel corn, canned, no salt added (30)
Noncaloric beverage

Men add:

1/2 C. sliced white potatoes, canned (45)
2 slices whole wheat bread (140)

Steak Dinner

3 oz. lean sirloin, broiled (176)
1/2 C. sweet peas, canned, no salt added (60)

1/2 C. beets, canned (35)
1/2 C. skim milk (45)
Noncaloric beverage

Men add:

2 slices whole wheat bread (140)
1 t. Promise Ultra® Vegetable Oil Spread (12)
1/2 C. skim milk (45)

Frozen Microwave Dinner

Choice of one meal:

• Glazed Chicken Dinner, Lean Cuisine® (230)
2/3 C. skim milk (60)
Noncaloric beverage
• Lasagna with Meat Sauce, Lean Cuisine® (240)
1/2 C. skim milk (45)
Noncaloric beverage
• Macaroni and Cheese, Weight Watchers® (260)
1/2 C. skim milk (45)
Noncaloric beverage
• Broccoli & Cheddar Cheese Sauce over Baked Potato, Lean Cuisine® Lunch Express (250)
1/2 C. skim milk (45)
Noncaloric beverage
• Grilled Turkey Breast, Healthy Choice® (260)
1/2 C. skim milk (45)
Noncaloric beverage

Men add:

2 slices whole wheat bread (140)
2 t. Promise Ultra® Vegetable Oil Spread (24)
1/2 C. skim milk (45)

Late-Night Snack

Men—200 calories for 1&2; 150 calories for Weeks 3&4; 100 calories for Weeks 5&6.

Women—150 calories for Weeks 1&2; 100 calories for Weeks 3&4; 50 calories for Weeks 5&6.

Choose calories from afternoon snack selections plus the following:

1/2 C. low-fat frozen yogurt (100)
2 C. light, microwave popcorn (100)

The Eating Plan - Metric Measurements*

Breakfast = 300 calories

Choice of bagel, cereal or shake.

Bagel

1 plain bagel, Sarah Lee® (frozen) (210)
21 g light cream cheese (45)
120 ml orange juice, fresh or frozen (55)
Any beverage without calories, caffeine, or sodium, such as decaffeinated coffee or tea.

Cereal

42 gram serving equals approximately 165 calories.
Choice of one: Kellogg's® Low Fat Granola (without raisins), General Mills® Honey Nut Clusters, General Mills® Basic 4
120 ml skim milk (45)
177 ml orange juice (82)
Noncaloric beverage

Shake (choice of one shake)

Place ingredients in blender. Blend until smooth.

Banana-Orange Shake

1 large banana (22 cm long) (100)
120 ml orange juice (55)
120 ml skim milk (45)
15 ml wheat germ (66)
5 ml safflower oil (42)
2 ice cubes (optional)

or Chocolate or Vanilla Shake

1 packet Carnation® Instant Breakfast, Champion UltraMet®, or another diet shake powder that contains the appropriate calories (100)
240 ml skim milk (90)
1/2 large banana (22 cm long) (50)
5 ml safflower oil (42)
5 ml Carnation® Malted Milk powder (20)
2 ice cubes (optional)

Lunch = 300 calories.

Choice of sandwich, soup or salad.

Sandwich

2 slices whole wheat bread (140)
10 ml Promise Ultra® Vegetable Oil Spread (24)
57 g white meat (about 8 thin slices), chicken or turkey (80)
28 g fat-free cheese (1 1/2 slices) (50)
(Opt.: Add to bread 5 ml Dijon mustard (0))
Noncaloric beverage

Soup (choice of one soup)

• Healthy Choice® Hearty Chicken, 420 g can (260), or
• Campbell's® Healthy Request Hearty Vegetable Beef, 450 g can (260)
1/2 slice whole-wheat bread (35)
Noncaloric beverage

Chef Salad

480 ml lettuce, chopped (20)
57 g white meat, chicken or turkey (80)
57 g fat-free cheese (100)
4 slices tomato, chopped (28)
15 ml Italian, fat-free dressing (6)
1 slice whole wheat bread (70)
Noncaloric beverage

Mid-Afternoon Snack

Men—200 calories for Weeks 1&2;

150 calories for Weeks 3&4;

100 calories for Weeks 5&6.

Women—150 calories for Weeks 1&2;

100 calories for Weeks 3&4;

50 calories for Weeks 5&6.

Choose calories from:

1 large banana (22 cm long) (100)
1 apple (7.6 cm diameter) (100)
1/2 cantaloupe (12.7 cm diameter) (94)
5 dried prunes (100)
28 g (2 small 14 g. boxes) raisins (82)
240 ml light, nonfat, flavored yogurt (100)

Dinner

Men—500 calories, **Women**—300 calories

Choice of tuna salad dinner, steak dinner or frozen microwave dinner.

Tuna Salad Dinner

In a large bowl, mix the following:
1 can (170 g) chunk light tuna in water (180)
15 ml Hellmann's® Light, Reduced-Calorie Mayonnaise (50)
30 ml sweet pickle relish (40)
60 ml whole kernel corn, canned, no salt added (30)
Noncaloric beverage

Men add:

120 ml sliced white potatoes, canned (45)
2 slices whole wheat bread (140)

Steak Dinner

85 g lean sirloin, broiled (176)
120 ml sweet peas, canned, no salt added (60)
120 ml beets, canned (35)
120 ml skim milk (45)
Noncaloric beverage
Men add:
2 slices whole wheat bread (140)
5 ml Promise Ultra® Vegetable Oil Spread (12)
120 ml skim milk (45)

Frozen Microwave Dinner

Choose one meal:

• Glazed Chicken Dinner, Lean Cuisine® (230)
160 ml skim milk (60)
Noncaloric beverage
• Lasagna with Meat Sauce, Lean Cuisine® (240)
120 ml skim milk (45)
Noncaloric beverage
• Macaroni and Cheese, Weight Watchers® (260)
120 ml skim milk (45)
Noncaloric beverage
• Broccoli & Cheddar Cheese Sauce over Baked Potato, Lean Cuisine® Lunch Express (250)
120 ml skim milk (45)
Noncaloric beverage
• Grilled Turkey Breast, Healthy Choice® (260)
120 ml skim milk (45)
Noncaloric beverage

Men add:

2 slices whole-wheat bread (140)
10 ml Promise Ultra® Vegetable Oil Spread (24)
120 ml skim milk (45)

Late-Night Snack

Men—200 calories for 1&2; 150 calories for Weeks 3&4; 100 calories for Weeks 5&6.

Women—150 calories for Weeks 1&2; 100 calories for Weeks 3&4; 50 calories for Weeks 5&6.

Choose calories from afternoon snack selections plus the following:

120 ml low-fat frozen yogurt (100)
240 ml light, microwave popcorn (100)

* Nutritionally equivalent products with similar calorie counts may be substituted if recommended products cannot be found.

Shopping List

Quantities needed for listed items will depend on your specific selections. Review your choices and adjust the shopping list accordingly. It may be helpful for you to photocopy this list each week before doing your shopping.

Staples

Orange juice, skim milk, whole-wheat bread, Promise Ultra® Vegetable Oil Spread, Italian fat-free dressing, Dijon mustard, safflower oil, noncaloric beverages (tea, decaffeinated coffee, diet soft drinks, water).

Grains

Bagels, Sarah Lee® (frozen)

Cereals – 1.5 oz. (42 g) serving equals approximately 165 calories; Kellogg's® Low-Fat Granola (without raisins), General Mills® Honey Nut Clusters, General Mills® Basic 4.

Wheat germ, malted milk powder, popcorn (microwave light).

Fruits

Bananas, large (8 3/4 inches [22 cm] long), apples (3-inch [7.6 cm] diameter), cantaloupes (5-inch [12.7 cm] diameter), dried prunes, raisins.

Vegetables

Lettuce, tomatoes, whole kernel corn (canned no salt added), sweet peas, (canned no salt added), sliced white potatoes (canned), cut beets (canned).

Dairy

Yogurt (light nonfat), cream cheese (light), cheese (fat-free), low-fat frozen yogurt, Carnation® Instant Breakfast packets, Champion UltraMet® Packets.

Meat, Poultry, Fish and Entrees

Chicken (thin sliced), turkey (thin sliced), tuna (canned in water), sirloin steak (lean).

Canned soup:

Healthy Choice® Hearty Chicken, Campbell's® Healthy Request Hearty Vegetable Beef.

Frozen microwave dinners or entrees:

Lean Cuisine® Glazed Chicken Dinner, Lean Cuisine® Lasagna with Meat Sauce, Lean Cuisine® Lunch Express Broccoli & Cheddar Cheese over Potato, Weight Watchers® Macaroni and Cheese, Healthy Choice® Grilled Turkey Breast.

Q & A

Q. I often get headaches when I eat only 1000 calories a day. What should I do?

A. Your headaches may be caused by going longer than three hours between meals or snacks. Try spacing your meals and snacks where there are fewer hours between them.

Some people who are used to drinking regular coffee with caffeine notice headaches when they stop consuming coffee for several days. If this is the case with you, you might want to ease off the coffee more gradually.

Q. I don't like red meat. I notice that the Lean Cuisine® Lasagna with Meat Sauce contains beef. What can I substitute for it?

A. Lean Cuisine® has many other frozen dinners that you may substitute for Lasagna with Meat Sauce. Try to find one that contains the same calories, with approximately 15 to 20 percent of the calories coming from fat. Some of the Lean Cuisine® dinners actually have too little fat for my nutritional requirements.

Q. May I have dinner for lunch and lunch for dinner?

A. Yes.

Q. I tend to get a headache when I drink cold water. Can I drink water without it being chilled?

A. Yes, but you won't get the thermogenic effect from warming the cold water to core body temperature. Try a more gradual drinking of the cold water. You may have been consuming it too quickly.

Q. Is it possible to drink too much water?

A. Certainly. To do so, however, you'd probably have to drink four or five times as much per day as I'm recommending. There are a few ailments that can be negatively affected by large amounts of fluid. If you feel you have a problem, check with your doctor before starting the program.

Q. Is bottled water better than tap water?

A. Research shows that bottled water is not always higher quality water than tap water. The decision to drink bottled water or not is usually one of taste. If you dislike the taste of your tap water, then drink

your favorite bottled water. But first you might want to try a twist of lemon or lime added to the water from your tap. Some people say it makes a significant difference in the taste.

Q. I'm a middle-aged woman who gets black and blue marks on my legs when I diet. Am I doing anything wrong?

A. I doubt you are doing anything wrong. Such black and blue marks are usually the result of an increased level of estrogen circulating in your body, which weakens the walls of the capillaries and causes them to break under the slightest pressure. When this happens, blood escapes and a bruise occurs. Estrogen is broken down in the liver, and so is fat. When you are dieting, your liver breaks down the fat, leaving a lot more estrogen in the bloodstream.

It may be helpful to supplement your diet with a little extra vitamin C each day to help toughen the walls of the capillaries.

Q. I'm a 40-year-old woman with a teenage son and daughter. My husband and I both want to lose 10 pounds (4.5 kg) and the children would also like to lose some weight. Can I put the whole family on the program?

A. It would be great if you could, but you cannot. The number of calories per day is the problem. Teenagers require significantly more calories each day than 1500, which is the highest level. Check with a registered dietician (RD) for appropriate recommendations.

Your teenage son and daughter, however, could follow the Bowflex® exercise routines.

Q. I'm afraid that I might get large, unfeminine muscles from some of the Bowflex® exercises you recommend in this course. What can I do to prevent this from happening?

A. You are worrying about large muscles unnecessarily. Building large muscles requires two conditions. First, the individual must have long muscles and short tendons. Second, an abundance of testosterone must be present in the blood stream. Women almost never have either of these conditions.

Q & A

Under no circumstances could 99.99 percent of American women develop excessively large muscles. Progressive resistance exercise such as Bowflex® home gym will make your muscles larger—but not excessively large—and larger muscles will make your body firmer and more shapely.

Q. Why is it so important I perform the Bowflex® exercises with a 4-second count on the lifting and lowering?

A. Because a slow, smooth 4-second lifting followed by a 4-second lowering involves more muscle fibers more thoroughly than faster speeds of movement. The more completely each involved muscle fiber works simply means you'll get better muscle-building results.

Q. I'm confused about how to breathe during each Bowflex® exercise?

A. Let's say your goal is to do 10 repetitions on a specific Bowflex® exercise that is performed in the recommended 4-second lifting and 4-second lowering style. Here are the proper breathing guidelines to follow:

- Breathe normally during the first five repetitions.
- Take shorter, more shallow breaths during the sixth, seventh, and eighth repetitions.
- Emphasize exhalation more than inhalation, especially during the ninth and tenth repetitions. Focus on good form and slow movement.
- Do not hold your breath on any repetition. Practice relaxing your face and neck. Do not grit your teeth. Keep your eyes open and remain alert.

Q. I'm not as disciplined and patient as I'd like to be. How can I better stay on track with the program?

A. One suggestion is to team up with a partner. Most people are more motivated and make -better progress if they go through the program with a friend. In selecting a training partner, here are several things to keep in mind:

- Your partner should be similar to you in age and condition.
- Your partner should be serious about getting into shape and making a commitment. That commitment means you'll be exercising together one hour, three times per week. Each of your joint training sessions should take approximately 50 minutes: 25 minutes for your workout

and 25 minutes supervising your partner's workout.

- Your partner should be someone with whom you'll share a spirit of cooperation, not competition.
- Your partner should not be your spouse, brother, sister, or other family member. You do not want normal interpersonal problems to interfere with the training.

Q. Why won't you allow me to do aerobic dancing on my off-days to speed up the loss of body fat?

A. Because doing so doesn't speed up fat loss. Aerobic dancing—and other activities such as running, swimming, cycling, stair-stepping, and racquetball—do not contribute significantly to the fat-loss process. In fact, when added to proper strength training they can actually retard the reduction of fat.

Fat loss is retarded in two ways. Too much repetitive activity prevents maximum muscle building by using up your recover ability. A well-rested recover ability is necessary for muscle growth. Too much activity—especially if you are on a reduced-calorie diet—causes you to get the blahs and quickly lose your enthusiasm. If this happens, you're sure to break your diet.

The primary purpose of this program is to lose fat in the most effective and most efficient manner. Fat loss is prioritized and maximized by building muscle at the same time. The muscle-building process is optimized by a well-rested recovery ability, which necessitates keeping your strenuous and moderately strenuous activities to a bare minimum.

Once you get your body fat to a low level, you can add other activities—and I encourage you to do so—to your weekly fitness schedule. For now, follow the plan exactly as directed.

Q. What happens after six weeks? How do I continue the program if I need to lose more weight?

A. You should repeat the program for as long as it takes you to reach your goal. For example, it took Barry Ozer three six-week sessions—18 weeks—to lose all of his excessive fat, which amounted to 75 pounds (34 kg). There are, however, a few guidelines and modifications to apply.

Repeat the eating plan exactly as before: Men, go back to 1500 calories a day for two weeks. Women, go back to 1200 calories a day for two weeks. Then, descend your calories in the same manner.

Q & A

Keep your superhydration schedule at the highest level. In other words, sip 1 5/8 gallons (6.2 l) of ice-cold water each day.

Continue your Bowflex® exercise routine at the highest level. Perform the same 10 exercises three times per week. Try to get as strong as you can in each exercise, while always focusing on the 4-second count in both lifting and lowering.

Q. I'm pleased that I lost the fat I wanted to lose. What do I do to maintain my new body weight?

A. Once you've lost your excessive fat, your next task is to maintain that status. Here are the adjustments you need to make to your current practices.

Adhere to a carbohydrate-rich, moderate-calorie eating plan.

Instead of eating from 1000 to 1500 calories a day, you'll be consuming from 1600 to 2400 calories per day. Maybe you can eat even more after your new body weight has stabilized. Trial-and-error experimentation is a must. Women should start with 1600 calories, and men with 2000 calories per day. Note what happens after a week. If your body weight keeps going down, raise the calories by 100 or 200, depending on how much weight you lost during the last week. Soon, you should reach a level where your body weight stabilizes. That level is your daily calorie requirement. Naturally, you'll be able to consume other foods than those listed in the Bowflex® eating plan. By then, however, you should know the value of being a smart shopper and a wise eater. Read labels. Compare nutritional information. Be conscious of the ideal 60:20:20 ratio for carbohydrates, proteins, and fats.

Eat smaller meals more frequently.

You've been limiting your five meals per day to 300 calories if you're a woman, or 500 calories if you're a man. You may now up the calories by 100. What happens if during a single meal you eat more than 400 calories if you're a woman, or 600 calories if you're a man? Don't panic. Simply understand that you will sometimes backslide. Learn to anticipate these urges and take corrective action.

Drink at least 1 gallon (3.8 liter) of cold water each day.

You should realize by now the benefits of consuming plenty of water each day. Make your water bottle a

permanent part of your lifestyle.

Train on Bowflex® home gym at least twice a week.

There are two primary differences between maintenance and strength-building routines. First, for maintenance, you do not have to increase the resistance each week or so. If you can do 100 pounds for 12 repetitions on the leg extension, then keep it on 100 pounds and do not go up to 105 pounds. You can maintain the 100-pound level much easier than you can increase it. Second, you do not need to train three times a week. You can maintain your strength at twice a week.

Add variety to your Bowflex® routines.

Now is the time to introduce more variety to your routines by adding some new exercises while removing some old ones. Below are two sample routines.

Maintenance Routine 1

1. Seated Hip Abduction
2. Seated Hip Adduction
3. Seated Straight Leg Calf Raise
4. Chest Fly
5. Incline Bench Press
6. Shoulder Pullover
7. Shoulder Shrug
8. Standing Biceps Curl
9. Seated Wrist Curl
10. Seated Wrist Extension

Maintenance Routine 2

1. Leg Curl
2. Leg Extension
3. Standing Lateral Shoulder Raise
4. Seated Shoulder Press
5. Rear Deltoid Row
6. Decline Press
7. Reverse Curl
8. Seated Triceps Extension
9. Low Back Extension
10. Abdominal Crunch

Look in your Bowflex Conquest™ Home Gym Owner's Manual for descriptions of the new exercises.

Be consistent with your Bowflex® exercising, healthy eating, and superhydrating — and your accomplishments may well exceed your goals.

Exercise Log

Please feel free to make copies of this chart to continue your exercise log.

EXERCISE		DATE	DATE	DATE	DATE	DATE	DATE
Bench Press	Sets	2					
	Reps	10, 9					
	Resistance	120, 130					
	Sets						
	Reps						
	Resistance						
	Sets						
	Reps						
	Resistance						
	Sets						
	Reps						
	Resistance						
	Sets						
	Reps						
	Resistance						
	Sets						
	Reps						
	Resistance						
	Sets						
	Reps						
	Resistance						
	Sets						
	Reps						
	Resistance						
	Sets						
	Reps						
	Resistance						
	Sets						
	Reps						
	Resistance						

Limited Warranty

(Keep For Your Records)

We want you to know that the Bowflex Conquest® home gym is a superior product. Your satisfaction is guaranteed.

If, for any reason, you are not 100% satisfied with your Bowflex Conquest® home gym, please follow the instructions below to return your merchandise and receive a refund of the purchase price, less shipping and handling.

1. Call a Bowflex® Representative at 1-800-605-3369 for a Return Authorization Number. Return Authorization will be granted if:
 - a. You purchased your Bowflex Conquest® home gym directly from Nautilus, Inc., and
 - b. You are calling within 6 weeks of the delivery date of your merchandise.
2. All returned merchandise must be properly packaged in the original boxes and in good condition. Returns should be shipped to:
Nautilus, Inc. World Headquarters
16400 SE Nautilus Drive
Vancouver, WA 98683.

NOTE: You are responsible for return shipping and for any damage or loss to merchandise that occurs during return shipment. We highly recommend that you insure your shipment.

3. Please mark all boxes clearly with:

- Return Authorization Number
- Your Name
- Your Address
- Your Phone Number

Boxes without this information clearly marked on the outside may be refused.

4. Please make copies of your original invoice and put one in each box of merchandise. Nautilus, Inc. must receive your shipment within two weeks from the date the Bowflex® Representative issued you your Return Authorization Number.

Refunds may be denied or delayed if these instructions are not completely followed.

This Bowflex® Satisfaction Guarantee applies only to merchandise purchased by consumers directly from Nautilus, Inc. This guarantee does not apply to sales made by dealers or distributors.

What Is Covered

Nautilus, Inc. warrants to the original purchaser of this Bowflex® product that the equipment is free from defects in materials or workmanship, with the exceptions stated below. This warranty is not transferable or applicable to any person other than the original purchaser. Tampering with the unit will void the warranty.

Warranty

- 5 years on machine
- No-Time-Limit Warranty on Power Rod® resistance rods

Warranty terms may differ outside the USA.

To make this warranty effective, you must completely fill out the BowflexConquest® home gym Warranty Registration Card within 30 days of the purchase of your Bowflex Conquest® home gym, and return it to the address on the Warranty Registration Card.

Warranties Do Not Cover

- Damage due to use by persons who weigh more than 300 lbs (136kg).
- Damage due to normal wear and tear.
- Damage due to abuse, accident, failure to follow instructions or warnings, misuse, mishandling, accident or Acts of God (such as floods or power surges).
- Use in any institutional or commercial settings such as health clubs, schools, or recreation centers.
- Consequential or incidental damage.

Some states do not allow the exclusion or limitation of incidental or consequential damages, so the above limitation or exclusion may not apply to you.

What We Will Repair

During your Warranty Coverage Period, Nautilus, Inc. will repair any Bowflex® equipment that proves to be defective in materials or workmanship. In the event repair is not possible, Nautilus, Inc., at its option, will either replace your equipment or refund your purchase price, less shipping and handling.

Nautilus, Inc. reserves the right to substitute material of equal or better quality if identical materials are not available at the time of service under this Warranty. The replacement of the product under the terms of the Warranty in no way extends the Warranty period.

How to Obtain Service

To obtain service for a Bowflex® Fitness Product, contact an authorized Bowflex® Fitness Retailer. You may also contact a Nautilus representative at 800-628-8458 to help you locate a dealer in your area.

How State Law Applies

This warranty gives you specific legal rights. You may also have other rights which vary from state to state.

Bowflex Conquest™ Home Gym Warranty Registration Card

IMPORTANT! MAIL WITHIN 30 DAYS OF PURCHASE

PLEASE PRINT CLEARLY – THANK YOU

Mr. 2. Mrs. 3. Ms. 4. Miss Customer ID from Invoice

Name:

Address: Apt. #:

City: State: Zip:

Phone number: () - EXT.

E-Mail address:

Is this your primary address? Yes No

Place of purchase:

Date of purchase:
M M D D

Purchaser date of birth:
M M D D Y Y

Gender: Male Female

Marital status: Married Single

Including yourself, total number of people living in your household: (Examples: 01, 02, 03 ...)

Would you like to receive additional information on healthy lifestyle products? Yes No

Which best describes your family income: (US dollar figures)

Under \$15,000 \$25,000 – \$34,999 \$50,000 – \$74,999 \$100,000 – \$149,999

\$15,000 – \$24,999 \$35,000 – \$49,999 \$75,000 – \$99,999 Over \$150,000

What other types of exercise equipment do you own?

Did you receive this item as a gift? Yes No

Name of original purchaser:

Original purchaser customer ID number:

Thanks for filling out this questionnaire. Your answers are important to us. Please check here if you would prefer not to obtain information on new and interesting opportunities from other exciting companies.

What Is Covered

Nautilus, Inc. warrants to the original purchaser of this Bowflex® product that the equipment is free from defects in materials or workmanship, with the exceptions stated below. This warranty is not transferable or applicable to any person other than the original purchaser. Tampering with the unit will void the warranty.

Warranty Period

- 5 years on machine
- No-Time-Limit Warranty on Power Rod® resistance rods

Warranty terms may differ outside the USA.

Warranties Do Not Cover

- Damage due to use by persons who weigh more than 300 pounds (136 kg).

- Damage due to normal wear and tear.
- Damage due to abuse, accident, failure to follow instructions or warnings, misuse, mishandling, accident or Acts of God (such as floods or power surges).
- Use in any commercial or institutional settings such as health clubs, schools or recreation centers.
- Consequential or incidental damage. Some states do not allow the exclusion or limitation of incidental or consequential damages, so the above limitation or exclusion may not apply to you.

What We Will Do

During your Warranty Coverage Period, Nautilus, Inc. will repair any Bowflex® equipment that proves to be defective in materials or workmanship. In the event repair is not possible, Nautilus, Inc., at its

option, will either replace your equipment or refund your purchase price, less shipping and handling.

How To Obtain Service

To obtain service for a Bowflex® Fitness Product, contact an authorized Bowflex® Fitness Retailer. You may also contact a Nautilus representative at 800-628-8458 to help you locate a dealer in your area.

How State Law Applies

This warranty gives you specific legal rights. You may also have other rights which vary from state to state.



Please fold over and tape before mailing



Please fold over and tape before mailing

**Place
Stamp
Here**

**Bowflex Conquest™ Home Gym
Nautilus, Inc. World Headquarters
16400 SE Nautilus Drive
Vancouver, Washington, USA 98683**

Important Contact Numbers

If you need assistance, please have both the serial number of your machine and the date of purchase available when you contact the appropriate Nautilus office listed below.

OFFICES IN THE UNITED STATES:

E-mail: customerservice@nautilus.com

- **TECHNICAL/CUSTOMER SERVICE**
Nautilus, Inc.
World Headquarters
16400 SE Nautilus Drive
Vancouver, Washington, USA 98683
Phone: 800-NAUTILUS (800-628-8458)
Email: customerservice@nautilus.com
Fax: 877-686-6466
- **CORPORATE HEADQUARTERS**
Nautilus, Inc.
World Headquarters
16400 SE Nautilus Drive
Vancouver, Washington, USA 98683
Phone: 800-NAUTILUS (800-628-8458)

INTERNATIONAL OFFICES:

For technical assistance and a list of distributors in your area, please call or fax one of the following numbers.

- **INTERNATIONAL CUSTOMER SERVICE**
Nautilus International S.A.
Rue Jean Prouvé 6
1762 Givisiez / Switzerland
Tel: + 41-26-460-77-77
Fax: + 41-26-460-77-70
Email: technics@nautilus.com

BUSINESS OFFICES:

- **SWITZERLAND OFFICE**
Nautilus Switzerland S.A.
Tel: + 41-26-460-77-66
Fax: + 41-26-460-77-60
- **GERMANY and AUSTRIA OFFICE**
Nautilus GmbH
Tel: +49-2203-2020-0
Fax: +49-2203-2020-4545
- **ITALY OFFICE**
Nautilus Italy s.r.l.
Tel: +39-051-664-6201
Fax: +39-051-664-7461
- **UNITED KINGDOM OFFICE**
Nautilus UK Ltd.
Tel: +44-1908-267-345
Fax: +44-1908-267-346
- **CHINA OFFICE**
Nautilus Representative Office
Tel: +86-21-523-707-00
Fax: +86-21-523-707-09

