

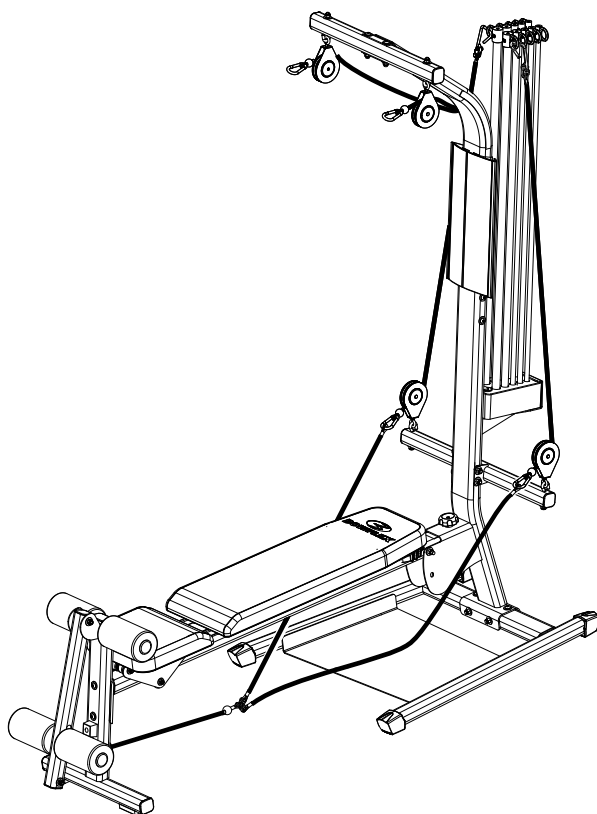

Classic Home Gym



Owner's Manual



English

Table of Contents

Specifications	2	Decline Bench Press.....	21
Important Safety Instructions	3	Incline Bench Press.....	21
Safety Warning Labels.....	4	Seated Shoulder Press.....	22
Features and Use	6	Front Shoulder Raise.....	22
How Often Should You Exercise.....	6	Scapular Retraction.....	23
What to Wear.....	6	Crossover Seated Rear Deltoid Rows.....	23
Stretching.....	6	Seated Low Back Extension.....	24
Power Rod® Resistance.....	8	Narrow Pulldowns.....	24
Connecting Rods to the Cables.....	8	Stiff Arm Pulldowns.....	25
Safety.....	8	Seated Lat Rows.....	25
When You Are Not Using Your Home Gym	8	Reverse Grip Pulldown.....	26
The Workout Bench.....	9	Standing Wrist Curl.....	26
Maintenance and Care of Your Gym.....	9	Triceps Pushdown.....	27
Storing Your Home Gym.....	10	Lying Triceps Extension.....	27
Accessories and Equipment.....	11	Standing Biceps Curl.....	28
Workouts	12	Trunk Rotation.....	28
Define Your Goals.....	12	Seated (Resisted) Abdominal Crunch.....	29
Design Your Program.....	13	Leg Press.....	29
Twenty Minute Better Body Workout.....	14	Leg Extension.....	30
Advanced General Conditioning.....	14	Seated Calf Raise.....	30
Twenty Minute Upper/Lower Body.....	15	Seated Hip Adduction.....	31
Body Building.....	16	Seated Hip Abduction.....	31
Circuit Training - Anaerobic/ Cardiovascular.....	17	Standing Leg Kickback.....	32
True Aerobic Circuit Training.....	18	Welcome to Fitness	33
Strength Training.....	19	Fast Fat Loss Now	47
Exercises	20	100% Satisfaction Guarantee	66
Bench Press.....	20	Contacts	67

Specifications

Physical Dimensions

Length (not in use).....	26" (65cm)	Weight (Box #2).....	126 lbs. (57kg)
Length (maximum in use).....	98" (248cm)	Dimensions (Box #1).....	50"l x 9"w x 7"h (127cm x 23cm x 18cm)
Width (not in use and in use).....	30" (76cm) 72" (183cm)	Dimensions (Box #2).....	57"l x 28"w x 8"h (145cm x 71cm x 20cm)
Height.....	82" (207cm)	Capacities	
Weight.....	123 lbs. (56kg)	Maximum Weight Capacity.....	300 lbs. (136kg)
Weight (Box #1).....	15 lbs. (7kg)		

Patent Information: This product may be covered by US and Foreign Patents and Patents Pending. See Product for more information.

Important Safety Instructions



This icon means a potentially hazardous situation which, if not avoided, could result in death or serious injury.

Before using this equipment, obey the following warnings:



Read and understand the complete Owner's Manual. Keep Owner's Manual for future reference.

Read and understand all warnings on this machine. If at any time the Warning stickers become loose, unreadable or dislodged, contact Nautilus Customer Service for replacement stickers.

- Keep children away from this machine. Monitor them closely when near the machine. Parts that move and appear dangerous to adults can appear safe to children.
- Consult a physician before you start an exercise program. Stop exercising if you feel pain or tightness in your chest, become short of breath, or feel faint. Contact your doctor before you use the machine again.
- Before each use, examine this machine for loose parts or signs of wear. Monitor all cables, pulleys and their connections. Contact Nautilus® Customer Service for repair information.
- Maximum user weight limit: 300 lb. (136 kg). Do not use if you are over this weight.
- This machine is for home use only.
- Do not wear loose clothing or jewelry. This machine contains moving parts.
- Always wear rubber soled athletic shoes when you use this machine. Do not use the machine with bare feet or only wearing socks.
- Set up and operate this machine on a solid, level, horizontal surface.
- Do not operate this machine outdoors or in moist or wet locations.
- Keep at least 36" (0.9m) on each side of the machine clear. This is the recommended safe distance for access and passage around and emergency dismounts from the machine. Keep third parties out of this space when machine is in use.
- Do not over exert yourself during exercise. Operate the machine in the manner described in this manual.
- Do not use Dumbbells or other weight equipment to incrementally increase the weight resistance. Use only the weight resistance that came with your gym.
- Correctly engage the Selector Hook to the Rod End.
- Correctly adjust and safely engage all Positional Adjustment Devices. Make sure that the Adjustment Devices do not hit the user.
- Keep clear of Power Rod® movement path during operation. Keep any bystanders clear of machine and Power Rod® movement path during operation.

Important Safety Instructions

Safety Warning Labels and Serial Number

Locate and read all safety warnings before operation. Replace any warning label if it is damaged, illegible, or missing. For replacement labels, call a Nautilus® Representative. Refer to the Contacts page at the back of this manual.

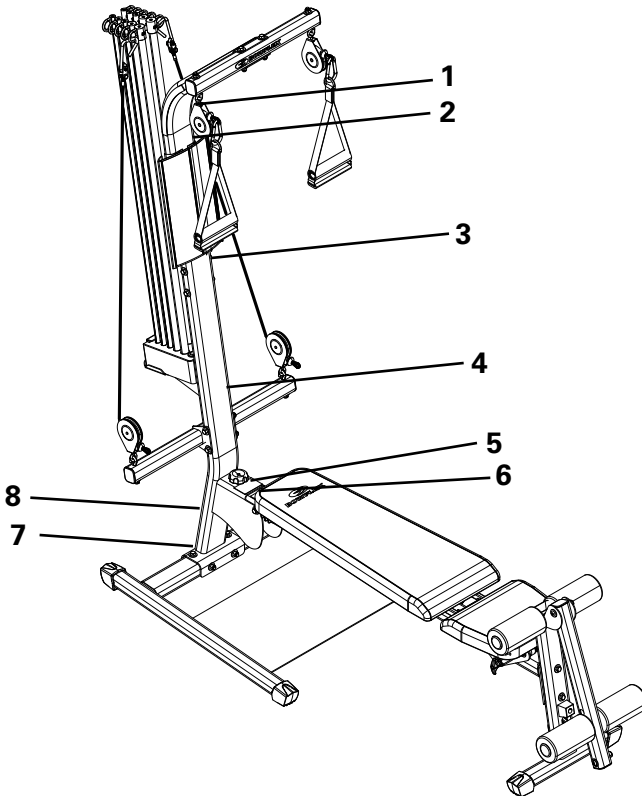

Type	Description
1*	CAUTION Before each use check all snap hooks, cables and pulleys for wear and proper function. Tighten all fasteners as necessary.
	MISE EN GARDE Avant chaque utilisation, vérifiez le fonctionnement de tous les mousquetons, câbles et poulies. Serrez bien toutes les fixations au besoin.
	VORSICHT Überprüfen Sie alle Karabinerhaken, Kabel und Rollen vor jeder Benutzung auf Abnutzungserscheinungen und Fehlfunktionen. Ziehen Sie alle Befestigungselemente ordnungsgemäß an.
	PRECAUCIÓN Antes de cada uso, revise todos los cierres a presión, cables y poleas para asegurarse de que no estén desgastados y que funcionan correctamente. Apriete todos los sujetadores según sea necesario.

Important Safety Instructions

	Type	Description
2*	WARNING	The Maximum User Weight for this machine is 300 pounds (136 KG). This machine is for Home use only.
	WARNUNG	Das Maximale Belastungsgewicht für diese Maschine beträgt 136 kg. Dieses Gerät ist nur für die Nutzung im Heimbereich freigegeben.
	AVERTISSEMENT	Le poids maximum de l'utilisateur pour cette machine est de 136 kg (300 livres). Cet équipement est destiné à un usage privé uniquement.
	ADVERTENCIA	El peso máximo para el usuario de esta Máquina es de 136 kg (300 libras). Este equipamiento sólo se puede utilizar en el hogar.
3*	WARNING	<ul style="list-style-type: none"> • Misuse or abuse of this equipment may lead to serious injury. • Keep children away and supervise teenagers using equipment. • Obtain, read and understand the owner's manual provided with this fitness equipment prior to use. • Replace this or any other warning label if damaged, illegible or missing.
4*	CAUTION	At all times, stay out of the paths of moving rods.
	MISE EN GARDE	Restez toujours à l'écart des tiges mobiles.
	VORSICHT	Halten Sie stets Abstand zu beweglichen Stangen.
	PRECAUCIÓN	En todo momento, manténgase alejado del trayecto de las barras móviles.
5	NOTICE	Knob must be fully engaged.
		Le bouton doit être complètement enfoncé.
		Der Knopf muss vollständig eingerastet sein.
		La perilla debe estar completamente insertada.
6	CAUTION	Pictograph - Do not place hand here.
7*	Serial Number	Record serial number on Contacts page at end of this manual.
8*	NOTICE	Engineered in the USA, Made in China
* decal is located on back of Lat Tower.		

Features and Use



Consult a physician before you start an exercise program. Stop exercising if you feel pain or tightness in your chest, become short of breath, or feel faint. Contact your doctor before you use the machine again.

How Often Should You Exercise

- 3 times a week for 20 minutes each day.
- Schedule workouts in advance. Try to work out even when you do not want to.

What to Wear

Wear rubber-soled athletic shoes. You will need the appropriate clothes for exercise that allow you to move freely.

Stretching

Stretch before starting your exercise session.

- Achilles Tendon and Calf - With both hands against a wall, place one foot behind you. Lean in toward the wall while keeping the rear leg straight and your heel on the ground. Repeat for the other leg.
- Quadriceps - Put your left hand on a wall or table for balance. Reach you right hand behind your back and grasp your right ankle, pull it gently toward your buttocks until you feel tension along the front of your thigh. Repeat on the other side.
- Hamstring - Stand on one leg and prop the other leg parallel to the ground on a stable cabinet or table top. Slide both hands toward the propped-up ankle as far as is comfortable. Repeat on other side.

Features and Use

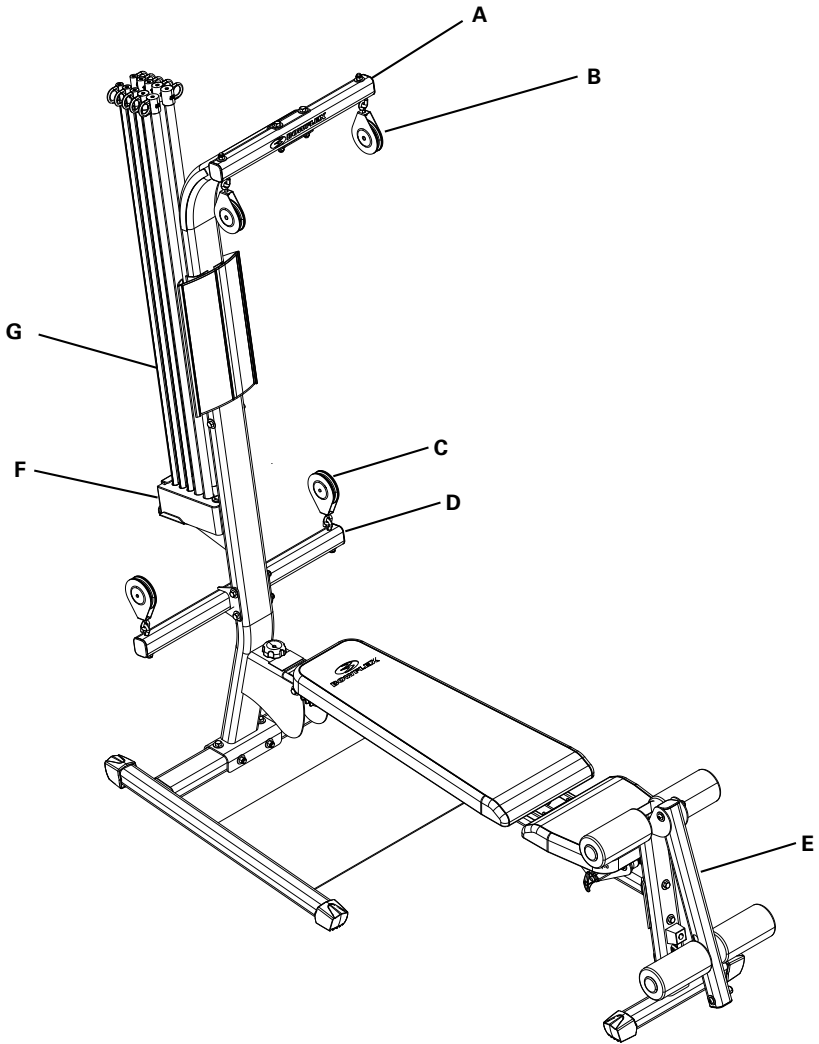

A	Top Cross Bar	E	Leg Attachment
B	Top Cross Bar Pulley	F	Rod Box
C	Chest Bar Pulley	G	Power Rod® Unit
D	Chest Bar with Pulleys		

Features and Use

Power Rod® Resistance

Power Rod® units are made from a special composite material. The rods are sheathed with a protective black rubber coating. Each rod is marked with its weight rating on the "Rod Cap".

The Bowflex® Classic home gym comes with 210 lbs. (95kg) of resistance [one pair of 5 lb. (2.25kg) rods, two pair of 10 lb. (4.5kg) rods, one pair of 30 lb. (13.5kg) rods, and one pair of 50 lb. (22.5kg) rods].

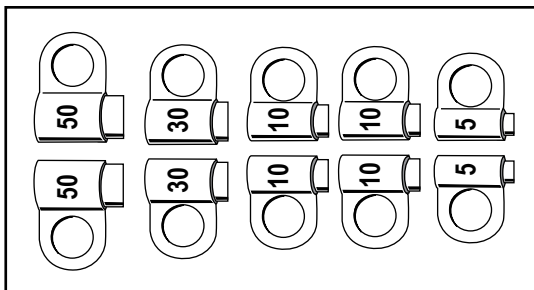

Connecting the Power Rod® Unit to the Cables

You may use one rod or several rods in combination, to create your desired resistance level.

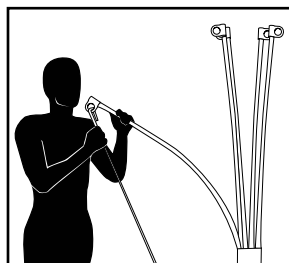
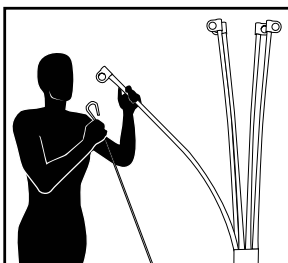

To hook multiple rods up to one cable, bend the closest rod toward the cable and place the cable hook through that rod cap. You can then hook up the next closest rod through the same cable hook.

Hooking up the closest rod first prevents rods from crossing over the top of one another.

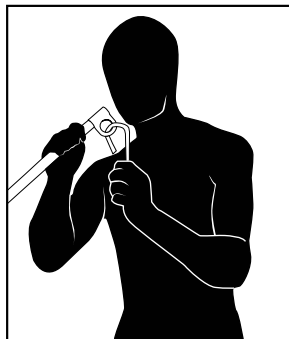

Safety



When you attach the Power Rod® units do not stand directly looking above the top of the rods. Stay off to the side while you attach the rods.

When You Are Not Using Your Home Gym

Disconnect the cables from the Power Rod® unit when you are not using your home gym. Use the rod binding strap included with your machine to bind all the rods together at the top. You can also place your cables and grips through the strap to keep them out of the way. Leaving the rods and cables under tension could cause injury if a rod were inadvertently released.



Keep the cables and Power Rod® units bound with the rod binding strap when not in operation.

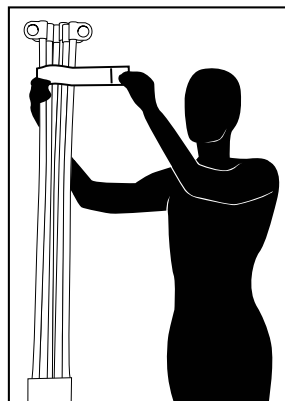

Features and Use

The Workout Bench

Your Bowflex® home gym has a number of seat and bench positions: Flat bench forward, Flat bench back, 45° incline and Free Sliding Seat Extension. To adjust the seat, pull out the Seat Slider Knob, then slide the seat to one of the three locking holes on the Seat Rail. Release the 45 Incline to secure the seat. Make sure seat is locked prior to use.

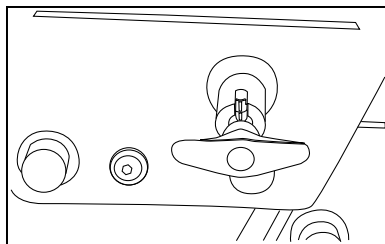

Do not make any adjustments to the seat while sitting on it. Do not stand on the seat.

Removing the Bench

The Bench easily attaches and releases from the Seat. To attach the Bench, insert the half hinge on the end of the Bench into the half hinge on the seat. To remove the Bench, lift up on the long portion of the seat and pull it away from seat rail.

Flat Bench

The Flat bench position is used for most of the exercises. You may lock the bench into a Back (closest to Power Rod® unit) or Forward (furthest from Power Rod® unit) position to accommodate height / reach needs.

45° Incline Bench

Start with a flat bench, following the above instructions to release and move the seat and bench. Lift the bench while you slide the seat toward the Power Rod® unit until the bench back rests against the Lat Tower.

Free-Sliding Seat

Remove the Bench, pull out the Seat Slider Knob, twist it a half turn and release it to put the Seat in a “free sliding” position for Calf Raise or Leg Press exercises.

Maintenance and Care of Your Bowflex® Home Gym

Inspect your machine for any worn or loose components prior to use. Tighten or replace any worn or loose components prior to use. Pay close attention to cables, or belts and their connections. Inspect all warning notices for legibility.



The safety and integrity designed into a machine can only be maintained when the equipment is regularly examined for damage and repaired. It is the sole responsibility of the owner to ensure that regular maintenance is performed. Worn or damaged components should be replaced immediately or the equipment removed from service until the repair is made. Only manufacturer supplied components should be used to maintain/repair the equipment.

Clean the bench with a non-abrasive household cleaner after each use. Do not use automotive cleaner, which can make the bench too “slick”.

Features and Use

Storing Your Home Gym

1. Lock the Seat and Bench into the flat position.
2. Remove all Power Rod® resistance and then bind the Power Rod® unit with the rod binding strap.
3. Remove the Seat Rail Securing Device from the seat rail.
4. Tilt the bench toward the Power Rod® unit.
5. Secure the bench by inserting the Seat Rail Securing Device into the hole in the side of the Seat Rail Bracket. Be sure to support the Seat Rail with one hand when performing this operation.



Failure to attach the Seat Rail Securing Device into the seat rail can cause injury.

Do not stand on the base below the Seat Rail when you lift or lower it. This can cause injury.

Always use two hands to lift and lower the Seat Rail. Bend at the knees when you lift or lower the Seat Rail. Failure to use correct lifting procedure can cause injury.

Do not try to exercise when the seat rail is in the folded position.

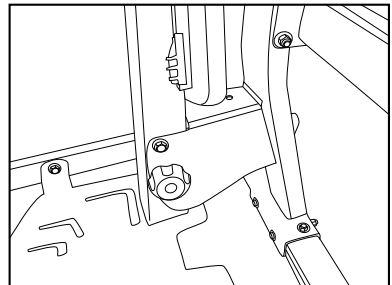
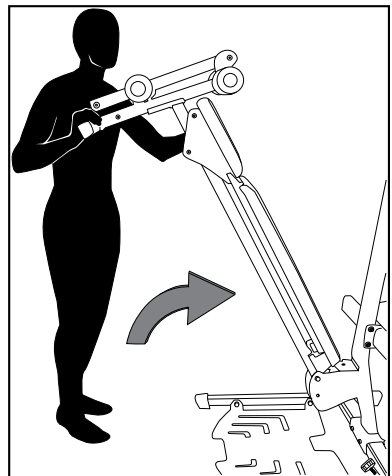
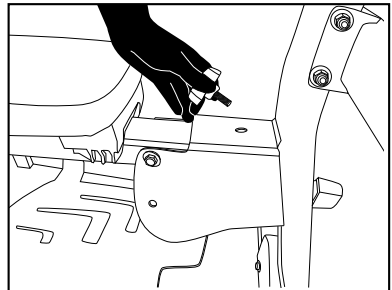
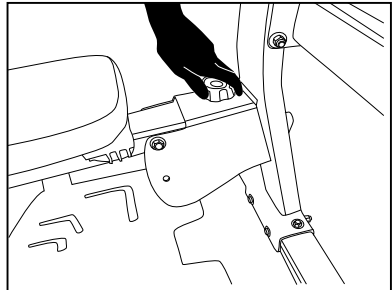

If you have any questions regarding your Bowflex® home gym, please call the Nautilus® Customer Service Department at 1-800-NAUTILUS (1-800-628-8458).

Features and Use

Accessories and Equipment



Always inspect for wear prior to use.

Handgrips

After fitting the handgrips firmly to your hand, ankle, or wrist, attach the pulley cable clips to the D-rings on the handgrips to attach them to the cables.

Standard Grip: Grasp the grip and cuff together to form a grip without inserting your hand through the cuff portion. Most of the exercises you perform utilize this grip. The Standard Grip also is used for Hammer Grip exercises, when you need to hold the handgrip vertically for greater wrist support.

Hand Cuff Grip: Slip your hand through the cuff portion of the grip so that the foam pad rests on the back of your hand. Then grasp the remainder of the grip that is sitting in your palm. This method of gripping is great for exercises like front shoulder raises or any exercise where your palm is facing down.

Foot Grip: Slip your foot through the cuff of the handle and slide the foam grip against the top of your foot.

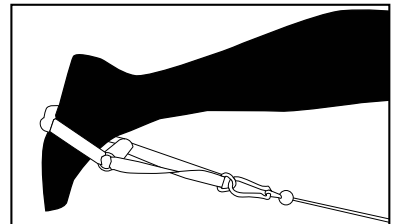
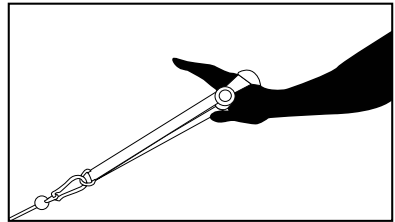
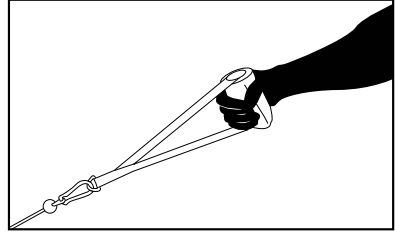

Leg Press Belt

Wear the Leg Press Belt around your lower arch of spine and attach the D-rings to cable clips. Belt must remain in slight tension to not fall from arch during exercise.

Additional Accessories

For additional accessories for your home gym, contact Nautilus at 1-800-NAUTILUS (1-800-628-8458) or www.bowflex.com.

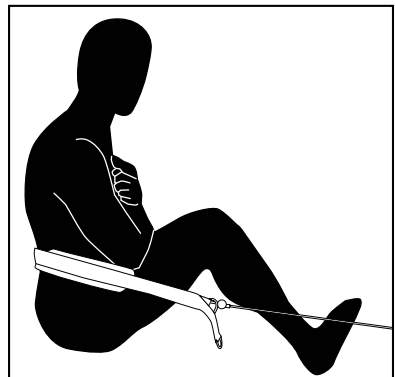

Workouts

Define Your Goals

It is important to define your goals before you begin your workout routine. The following fitness guidelines will help you define your goals and choose your fitness program. Consult a physician when setting up your workout goals.

Muscle Strength is the maximum force that you can exert against resistance at one time. Your muscle strength comes into play when you pick up a heavy bag of groceries or lift a small child. It is developed when a localized muscle is worked both positively (concentric) and negatively (eccentric) at a resistance—great enough so you can perform only five to eight repetitions of the exercise before the muscle fails. Each set of repetitions is followed by a rest interval that typically runs three times longer than the set. Later, between exercise sessions, the muscle overcompensates for the stress and usually increases in both strength and size.

Muscle Endurance is the ability to perform repeated contractions. It comes into play when you cross-country ski or work on your feet all day. Endurance training addresses the slow twitch, endurance muscle fibers, which depend on oxygen for energy. To develop muscle endurance, use low resistance and high repetitions about 15-20 repetitions in each set, three sets to each exercise, working the muscle only to fatigue.

Muscle Power is the combination of strength and speed of the muscular contraction. This is often misinterpreted as; a) being directly associated with certain skill or sport and/or; b) meaning that you must move fast. Load is actually a more important factor than speed when attempting to improve power. When training to achieve muscular power, pick a resistance that fatigues you in the 3-5 repetition range. When performing these reps, it is more important to think of contracting the muscles faster rather than attempting to move faster. Performing sport simulation exercises usually results in a deterioration of the motor pattern or skill. The biomechanically sound method of improving power in your sport is to train for power using the correct joint movements, as described in this manual. Then practice the skill associated with your sport, learning to apply this newly achieved power.

Body Composition is the ratio of fat weight (fat) to lean weight (muscles, bones and tissue). As you age, the ratio shifts. The fat weight increases and the lean weight decreases. Training for muscle strength will generally increase muscle size and aerobic conditioning will help burn extra calories. Performing these two forms of exercise, either at different times or together, will create the greatest changes in body fat weight. Balanced Strength and alignment are the result of equal strength developed in all parts of the body. It comes into play in your standing and sitting posture, and in your ability to perform just about any activity safely and effectively. An over-development of the back will round the shoulders; weak or stretched abdominals can cause lower back pain. You want a balance of muscle strength in front and back. In addition, you need a balance of strength between your middle, lower, and upper body.

Flexibility is the ability of a muscle or group of muscles to move the joint through a full range of motion. Flexibility comes into play when you execute an overhand serve or stretch for the top shelf in the kitchen. It is a cooperative movement of opposite muscle groups. When a muscle contracts, its opposite muscle group must relax for the action to occur. Increased flexibility means an increased range of motion, made possible by this simultaneous contracting and relaxing. Good flexibility is important in protecting the body from injury and can be achieved through the balanced strength training programs that are included in this manual.

Cardiovascular Endurance is the ability of the heart and lungs to supply oxygen and nutrients to exercising muscles over an extended period of time. It comes into play when you jog a mile or ride a bike. It is a critical component of overall fitness and health.

Workouts

Design Your Own Program

You may want to design your own personal program specifically geared to your goals and lifestyle. Designing a program is easy by following the guidelines below.

Understand fitness and its components

Improperly designed programs can be dangerous. Take some time to review this manual as well as other fitness guides.

Know your current fitness level

Before you start any fitness program you should consult a physician who will help you determine your current abilities.

Identify your goals

Goals are critical to choosing and designing an exercise program that fits and enhances your lifestyle, but so is strategy. It's important not to rush the process and try to accomplish too much too soon. That will lead to setbacks and discouragement. Instead, set a series of smaller achievable goals.

Select complementary exercises

Be sure to pair exercises that address compound joint movements and single joint movements. In addition, select exercises that address complementary muscle groups.

Put first things first

During each session, first work muscle groups that need the most training.

Remember your cardiovascular component Any fitness program must contain a cardiovascular fitness component to be complete. So complement your resistance training with aerobic exercise such as walking, running, or bicycling.

Training variables

When designing your own program there are several variables that, when mixed properly, will equal the right fitness formula for you. In order to find out the best formula, you must experiment with several combinations of variables.

The variables are as follows

- **Training Frequency:** The number of times you train per week. We recommend daily activity but not daily training of the same muscle group.
- **Training Intensity:** The amount of resistance used during your repetition.

- **Training Volume:** The number of repetitions and sets performed.
- **Rest Intervals:** The time you rest between sets and the time you rest between workouts.

Once you've established a base of fitness, follow these basic principles

- **Isolate Muscle Groups:** Focus work on specific muscle groups.
- **Progressive Loading:** The gradual systematic increase of repetitions, resistance and exercise period.

Working Out

A good pre-workout mental routine is to sit and relax, so that you can focus on what you are about to do and think about achieving your end goal.

Warming Up

We recommend that you warm up by doing light stretching and performing light exercises on the Bowflex® home gym.

Cooling Down

An essential part of the exercise routine is the cool down. Gradually reduce the level of exercise intensity so that blood does not accumulate in one muscle group, but continues to circulate at a decreasing rate. Remember to gradually move yourself into a relaxed state.

Breathing

Breathing in or out during the actual performance is not dependent upon the direction of air flow relative to exertion. It is, in fact, a mechanical process that changes the position of your spine as your rib cage moves. Here are some tips for breathing:

1. Be cautious when you are concentrating or exerting effort. This is when you will probably hold your breath. Do not hold your breath. Do not exaggerate breathing. Depth of inhalation and exhalation should be natural for the situation.
2. Allow breathing to occur naturally, do not force it.

Workouts

20 Minute Better Body Workout

Frequency: 3 days per week (M-W-F)

Time: 20 minutes

Start by performing one set of each exercise. Warm up with a light resistance that you can perform easily for 5–10 reps without fatigue. Focus on practicing and learning your technique before increasing the resistance. Then move to a more challenging resistance that you can perform no less than 10 reps and no more than 15 reps. As you become stronger, you can advance to two sets for each exercise. Complete all sets of each exercise before moving on to the next one. Rest 30 to 45 seconds between sets. Move slowly on each rep. Use a pace that would allow you to stop the movement instantly at any point in the rep. Count three seconds up and three seconds down and work to fatigue during each set.

Body Part	Exercise	Sets	Reps
Chest	Bench Press	1-2	10-15
Back	Seated Lat Rows	1-2	10-15
Shoulders	Crossover Rear Delt Rows	1-2	10-15
Arms	Standing Biceps Curl	1-2	10-15
	Triceps Pushdown	1-2	10-15
Legs	Seated Calf Raise	1-2	10-15
	Leg Press	1-2	10-15
Trunk	Seated Low Back Extension	1-2	10-15
	Seated Resisted Abdominal Crunch	1-2	10-15

Advanced General Conditioning

Frequency: 3 days per week (M-W-F)

Time: 20 minutes

When you are proficient in performing the exercise techniques of the above workout and are no longer realizing results, or have become just plain bored, it is time to change your program. You can increase your training with this "split system" routine that works opposing muscle groups on different days. To do this, you will increase your resistance when you can perform 12 reps perfectly, and you will increase your volume by performing more sets and more exercises. Move slowly on each rep. Use a pace that would allow you to stop the movement instantly at any point in the rep. Count three seconds up and three seconds down and work to fatigue during each set.

Days 1 & 3

Body Part	Exercise	Sets	Reps
Chest	Bench Press	1-3	10-12
Shoulders	Seated Shoulder Press	1-3	10-12
Arms	Triceps Pushdown	1-3	10-12
	Standing Biceps Curl	1-3	10-12
Legs	Leg Extension	1-3	10-12
	Seated Calf Raise	1-3	10-12

Workouts

Days 2 & 4

Body Part	Exercise	Sets	Reps
Back	Seated Lat Rows	1-3	10-12
	Narrow Pulldowns	1-3	10-12
Shoulders	Crossover Rear Delt Row	1-3	10-12
Arms	Standing Biceps Curl	1-3	10-12
	Triceps Pushdown	1-3	10-12
Trunk	Seated Low Back Extension	1-3	10-12
	Seated Resisted Abdominal Crunch	1-3	10-12

20 Minute Upper/Lower Body

Frequency: 4 days per week (M-T-Th-F)

Time: 20 minutes

This program provides a quick and effective workout that combines muscle conditioning with some cardiovascular benefits. Perform this routine when you are limited in time or just want a variation to your normal routine. Perform this program training 2 days, resting 1 to 2. Perform all exercises to near failure, stopping at the point that your technique starts to deteriorate. Rest only 20-30 seconds between sets. As you get stronger, increase the number of sets you perform. Move slowly on each rep. Use a pace that would allow you to stop the movement instantly at any point in the rep. Count three seconds up and three seconds down.

Days 1 & 3

Body Part	Exercise	Sets	Reps
Chest	Bench Press	1-3	12-15
Back	Seated Lat Rows	1-3	12-15
Shoulders	Crossover Rear Delt Rows	1-3	12-15
Arms	Standing Biceps Curl	1-3	12-15
	Lying Triceps Extension	1-3	12-15

Days 2 & 4

Body Part	Exercise	Sets	Reps
Legs	Leg Extension	1-3	12-15
	Leg Press	1-3	12-15
	Standing Leg Kick Back	1-3	12-15
	Seated Hip Abduction	1-3	12-15
Trunk	Seated Low Back Extension	1-3	10-12
	Seated Abdominal Crunch	1-3	10-12

Workouts

Body Building

Frequency: 3 days on, 1 day off (Day 6)

Time: 45-60 minutes

Body building requires focused concentration and dedication to training, as well as proper eating habits. Work each muscle group to fatigue before moving on to the next exercise. Do not neglect any muscle group. If needed, include an aerobic activity to increase your caloric expenditure and help to reduce your body fat levels to achieve a defined muscular look. Rest 30-60 seconds between each set and exercise. Focus on proper form. Tighten the muscle before you move, squeeze the muscle as you move, cramp the muscle at the point of full contraction, and resist the movement as you lower the weight. Move slowly on each rep. Use a pace that would allow you to stop the movement instantly at any point in the rep. Count three seconds up and three seconds down and work to fatigue during each set.

Days 1 & 3

Body Part	Exercise	Sets	Reps
Chest	Bench Press	2-4	8-12
	Incline Bench Press	2-4	8-12
Shoulders	Seated Shoulder Press	2-4	8-12
	Crossover Rear Delt Row	2-4	8-12
	Front Shoulder Raise	2-4	8-12
	Scapular Retraction	2-4	8-12

Days 2 & 4

Body Part	Exercise	Sets	Reps
Back	Seated Lat Row	2-4	8-12
	Narrow Pulldowns	2-4	8-12
Arms	Standing Biceps Curl	2-4	8-12
	Standing Wrist Curl	2-4	8-12
	Triceps Pushdown	2-4	8-12
	Lying Triceps Extension	2-4	8-12

Days 5 & 7

Body Part	Exercise	Sets	Reps
Legs	Leg Press	2-4	8-12
	Leg Extension	2-4	8-12
	Standing Leg Kick Back	2-4	8-12
	Seated Hip Abduction	2-4	8-12
Trunk	Seated Low Back Extension	2-4	8-12
	Seated Resisted Abdominal Crunch	2-4	8-12
	Trunk Rotation	2-4	8-12

Workouts

Circuit Training - Anaerobic/Cardiovascular

Frequency: 3 days on, 1 day off (Day 6)

Time: 20-45 minutes

Circuit training is a great way to achieve the benefits of strength training and cardiovascular training in one quick, challenging routine. The idea is to move quickly from exercise to exercise, taking only as much rest between sets as it takes to set up the next exercise (less than 20 seconds). One circuit equals one set of each exercise. Initially, start with completing one round of Circuit 1. Then add an additional round of the same circuit. Once you reach three rounds of Circuit 1, add one round of Circuit 2. Add additional rounds of Circuit 2 as your fitness level increases. Repeat the process with Circuit 3. Do not let your heart rate exceed 220, minus your resting heart rate. Perform each rep of each exercise slowly. Count three seconds up and three seconds down.

Days 1 & 3

Body Part	Exercise	Reps
Chest	Bench Press	8-12
Legs	Leg Press	8-12
Back	Seated Lat Row	8-12
Legs	Seated Calf Raise	8-12
Trunk	Seated Resisted Abdominal Crunch	8-12

Days 2 & 4

Body Part	Exercise	Reps
Shoulders	Seated Shoulder Press	8-12
Legs	Leg Extension	8-12
Back	Narrow Pulldowns	8-12
Trunk	Seated Low Back Extension	8-12
Arms	Standing Biceps Curl	8-12

Days 5 & 7

Body Part	Exercise	Reps
Shoulders	Crossover Rear Delt Rows	8-12
Arms	Triceps Pushdown	8-12
Legs	Seated Calf Raise	8-12
Trunk	Trunk Rotation	8-12

Workouts

True Aerobic Circuit Training

Frequency: 2-3 times per week

Time: 20-60 minutes

Circuit training is a great way to achieve the benefits of strength training and cardiovascular training in one quick, challenging routine. By returning to an aerobic exercise between each set you are increasing your aerobic capacity, endurance and burning fat as energy. The idea is to move quickly from exercise to exercise, taking only as much rest between sets as it takes to set up the next exercise (less than 20 seconds). One circuit equals one set of each exercise. Initially, start with completing one round of Circuit 1. Then add an additional round of the same circuit. Once you reach three rounds of Circuit 1, add one round of Circuit 2. Add additional rounds of Circuit 2 as your fitness level increases. Do not let your heart rate exceed 220 minus your resting heart rate. Perform each rep of each exercise slowly and with perfect technique. Count three seconds up and three seconds down.

Any type of aerobic exercise can be used for this routine. Some examples are: jumping jacks, jogging in place, or stair climbing.

Circuit 1

Body Part	Exercise	Reps
Chest	Bench Press	8-12
Aerobic Exercise	30-60 Seconds	
Legs	Leg Press	8-12
Aerobic Exercise	30-60 Seconds	
Back	Seated Lat Rows	8-12
Aerobic Exercise	30-60 Seconds	
Legs	Seated Calf Raise	8-12
Aerobic Exercise	30-60 Seconds	
Trunk	Seated Resisted Abdominal Crunch	8-12
Aerobic Exercise	30-60 Seconds	

Circuit 2

Body Part	Exercise	Reps
Shoulders	Seated Shoulder Press	8-12
Aerobic Exercise	30-60 Seconds	
Legs	Leg Extension	8-12
Aerobic Exercise	30-60 Seconds	
Back	Narrow Pulldowns	8-12
Aerobic Exercise	30-60 Seconds	
Trunk	Seated Low Back Extension	8-12
Aerobic Exercise	30-60 Seconds	
Arms	Standing Biceps Curl	8-12

Workouts

Strength Training

Frequency: 3 days per week (M-W-F)

Time: 45-60 minutes

This program is designed to emphasize overall strength development. This is an advanced routine to be used only after you have progressed from the advanced general conditioning routine and only after you have perfected your exercise techniques. Work each set to near exhaustion. If you can perform more than 5 to 8 reps, you should increase your resistance 5 lbs and decrease your reps to 5. Rest 60–120 seconds between each set and exercise. Focus on proper form. Tighten the muscle before you move, squeeze the muscle as you move, cramp the muscle at the point of full contraction, and resist the movement as you lower the weight. Move slowly on each rep. Use a pace that would allow you to stop the movement instantly at any point in the rep. Count two seconds up and four seconds down and work to fatigue during each set.

Day 1

Body Part	Exercise	Sets	Reps
Chest	Bench Press	2-4	5-8
	Decline Bench Press	2-4	5-8
Shoulders	Seated Shoulder Press	2-4	5-8
	Crossover Seated Rear Deltoid Row	2-4	5-8
	Front Shoulder Raise	2-4	5-8

Day 2

Body Part	Exercise	Sets	Reps
Back	Seated Lat Row	2-4	5-8
	Narrow Pulldowns	2-4	5-8
Arms	Standing Biceps Curl	2-4	5-8
	Standing Wrist Curl	2-4	5-8
	Triceps Pushdown	2-4	5-8
	Lying Triceps Extension	2-4	5-8

Day 3

Body Part	Exercise	Sets	Reps
Legs	Leg Press	2-4	5-8
	Leg Extension	2-4	5-8
	Standing Leg Kickback	2-4	5-8
	Seated Calf Raise	2-4	5-8
Trunk	Seated Low Back Extension	2-4	5-8
	Seated Resisted Abdominal Crunch	2-4	5-8

Exercises



Keep your body weight centered on the machine, seat or base frame platform while exercising.

When using the machine for standing leg exercises, always hold the Lat Tower of the machine for stability.

All exercises in this manual are based on the calibrated resistance and capacity levels of this machine. Only exercises included in this manual or in written materials authorized and supplied by Bowflex® are recommended for operation with this machine.

Chest Exercises

Bench Press - Shoulder Horizontal Adduction (and elbow extension)

Muscles Worked

Pectoralis Major, Deltoids, Triceps

Machine Set-Up

- Adjust the bench to a 45° incline.
- Chest Bar pulleys
- Handgrips
- Attach the clips to the Power Rod® resistance rods.

Success Tips

- Maintain a 90° angle between your upper arms and your torso throughout the motion.
- Keep your chest muscles tight.
- Limit and control your range of motion.
- Keep your knees bent, feet flat on the floor, head back against the bench.
- Keep your shoulder blades pinched together and maintain good spinal alignment.

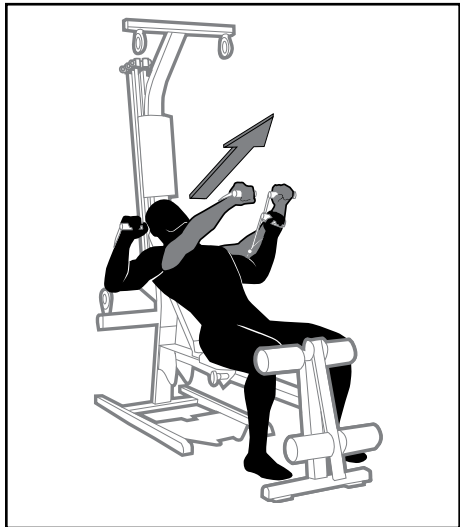

Exercises

Chest Exercises

Decline Bench Press - Shoulder Horizontal Adduction (and elbow extension)

Muscles Worked

Pectoralis Major, Deltoids, Triceps

Machine Set-Up

- Adjust the bench to a 45° incline.
- Chest Bar pulleys
- Handgrips
- Attach the clips to the Power Rod® resistance rods.

Success Tips

- Maintain a 90° angle between your upper arms and torso at the start of the motion, and slightly less than 90° at the finish.
- Keep your knees bent, feet flat on the floor, head back against the bench.
- Do not let your elbows travel behind your shoulders.
- Keep your shoulder blades pinched together and maintain good spinal alignment.

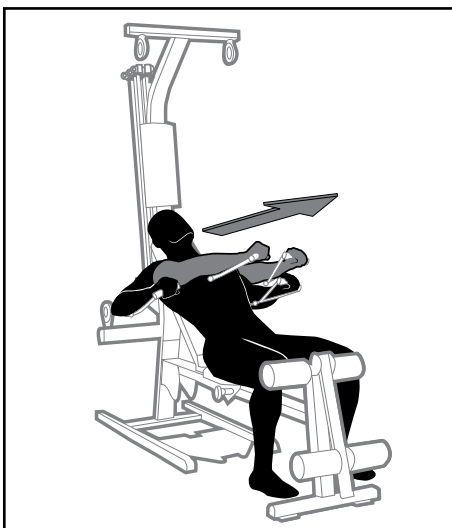

Incline Bench Press - Shoulder Horizontal Adduction (and elbow extension)

Muscles Worked

Pectoralis Major, Deltoids, Triceps

Machine Set-Up

- Adjust the bench to a 45° incline.
- Chest Bar pulleys
- Handgrips
- Attach the clips to the Power Rod® resistance rods.

Success Tips

- Maintain a 90° angle between your upper arms and torso at the start of the motion, and slightly less than 90° at the finish.
- Keep your knees bent, feet flat on the floor, head back against the bench.
- Do not let your elbows travel behind your shoulders.
- Keep your shoulder blades pinched together and maintain good spinal alignment.

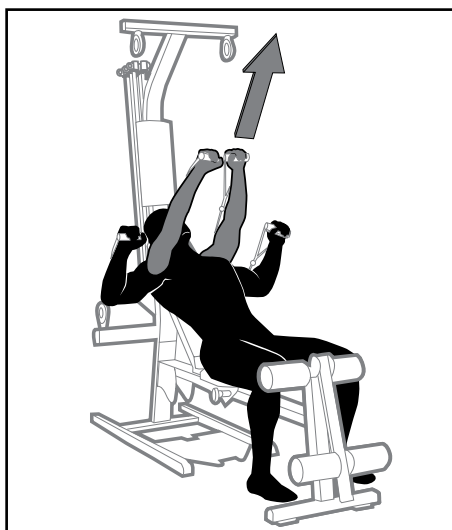

Exercises

Shoulder Exercises

Seated Shoulder Press - Shoulder Adduction (and elbow extension)

Muscles Worked

Front Deltoids, Upper Trapezius, Triceps

Machine Set-Up

- Adjust to Flat Bench Back position
- Chest Bar pulleys
- Handgrips
- Attach the clips to the Power Rod® resistance rods

Success Tips

- Keep your knees bent and your feet flat on the floor.
- Do not increase the arch in your lower back as you raise your arms, but keep your spine steady and tight.
- Keep your abdominals tight and maintain good spinal alignment.
- Keep tension in your front shoulder muscles when you return to the starting position.

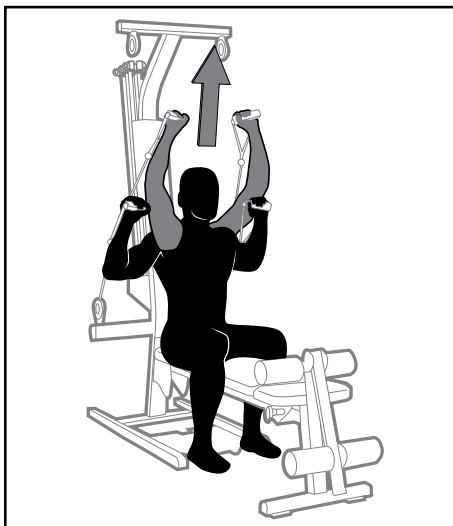

Front Shoulder Raise - Shoulder Flexion (elbow stabilized)

Muscles Worked

Front and Middle Deltoids

Machine Set-Up

- Adjust to Flat Bench Back position.
- Chest Bar pulleys
- Handgrips
- Attach the clips to the Power Rod® resistance rods.

Success Tips

- Keep your abdominals tight and maintain good spinal alignment with a slight arch in your lower back.
- Keep your knees bent and your feet flat on the floor.
- Do not increase the arch in your lower back as you raise your arms, but keep your spine steady and tight.
- Your arms may be moved alternately or together.

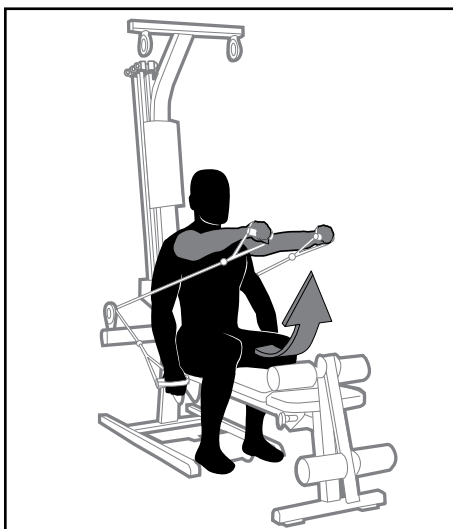

Exercises

Shoulder Exercises

Scapular Retraction

Muscles Worked

Middle Trapezius, Rhomboids

Machine Set-Up

- Adjust to Flat Bench Back position.
- Chest Bar pulleys
- Handgrips
- Attach the clips to the Power Rod® resistance rods.

Success Tips

- Do not lose your spinal alignment.
- Keep your chest lifted.
- Keep your knees bent and your feet flat on the floor.
- Keep your spine aligned and a slight arch in your lower back.
- Do not use your arm muscles for this movement.

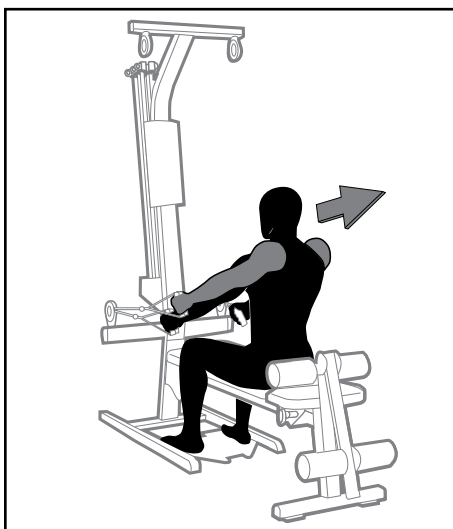

Crossover Seated Rear Deltoid Rows

Muscles Worked

Rear and Middle Deltoids, Posterior, Rotator Cuff, Upper Latissimus, Teres Major, Trapezius, Rhomboids

Machine Set-Up

- Adjust to Flat Bench Back position.
- Chest Bar pulleys
- Handgrips
- Attach the clips to the Power Rod® resistance rods.

Success Tips

- Maintain a 90° angle between your upper arms and torso throughout the motion.
- Keep your knees bent and your feet flat on the floor.
- To work one arm at a time place the non-working hand on the bench to stabilize.
- Keep your shoulder blades pinched together and maintain good spinal alignment.

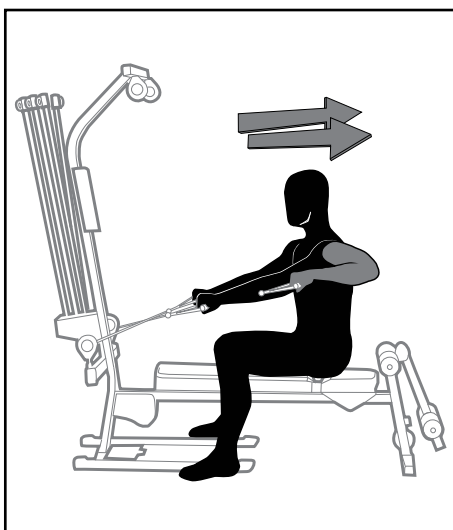

Exercises

Back Exercises

Seated Low Back Extension

Muscles Worked

Lower Trapezius

Machine Set-Up

- Adjust to Flat Bench Back position.
- Chest Bar pulleys
- Handgrips
- Attach the clips to the Power Rod® resistance rods.

Success Tips

- Keep your knees bent and your feet flat on the floor.
- Pivot at torso only.
- Keep your chest lifted and maintain spinal alignment.
- Keep arms crossed with hand grips looped onto forearm.
- Release your shoulder blades at the top of each rep.
- Initiate each new rep by depressing your shoulder blades.

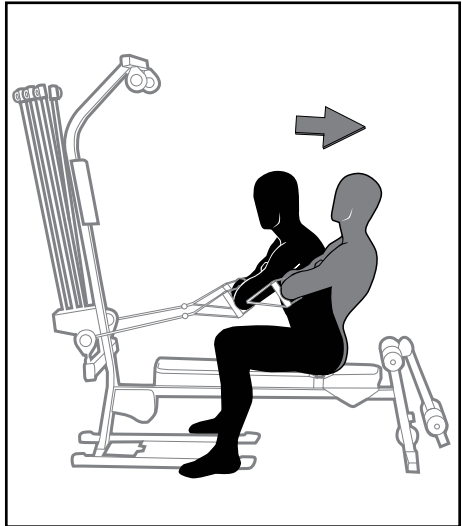

Narrow Pulldowns

Muscles Worked

Latissimus Dorsi, Teres Major, Rear Deltoids, Biceps

Machine Set-Up

- Adjust to Flat Bench Forward position.
- Top Cross Bar pulleys
- Handgrips
- Attach the clips to the Power Rod® resistance rods.

Success Tips

- Keep your knees bent and your feet flat on the floor.
- Keep your spine aligned, abs tight and a slight arch in your lower back.
- Keep your lats tightened throughout the exercise.
- Release your shoulder blades at the top of each rep.
- Initiate each new rep by depressing your shoulder blades.



Exercises

Back Exercises

Stiff Arm Pulldowns

Muscles Worked

Latissimus Dorsi, Teres Major, Rear Deltoids, Biceps

Machine Set-Up

- Adjust to Flat Bench Forward position.
- Top Cross Bar pulleys
- Handgrips
- Attach the clips to the Power Rod® resistance rods.

Success Tips

- Keep your knees slightly bent and your feet flat on the floor.
- Keep your spine aligned, abs tight and a slight arch in your lower back.

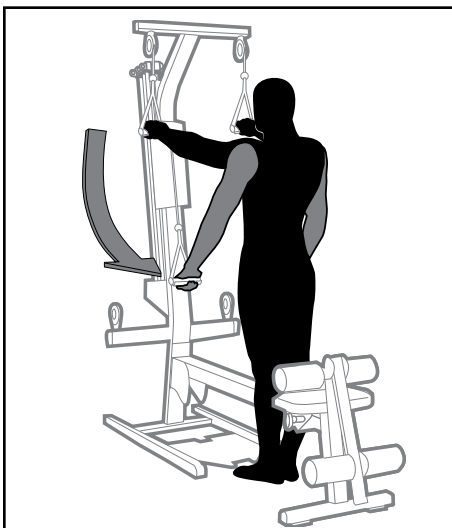

Seated Lat Rows - Shoulder Extension (and elbow flexion)

Muscles Worked

Latissimus Dorsi, Teres Major, Rear Deltoids, Biceps

Machine Set-Up

- Adjust to Flat Bench Back position.
- Chest Bar pulleys
- Handgrips
- Attach the clips to the Power Rod® resistance rods.

Success Tips

- Keep your knees bent and your feet flat on the floor.
- Do not bend your torso forward.
- Keep your chest lifted and maintain spinal alignment.
- Release your shoulder blades at the top of each rep.
- Initiate each new rep by depressing your shoulder blades.

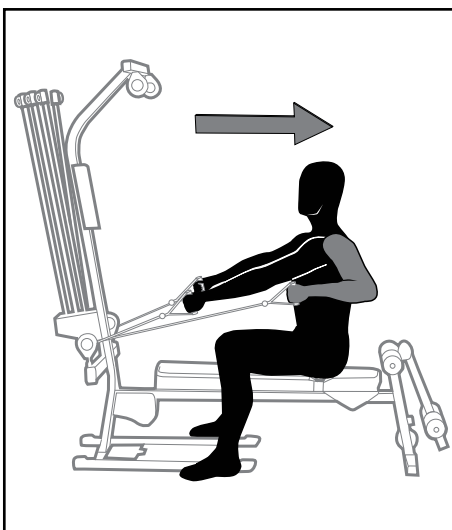

Exercises

Back Exercises

Reverse Grip Pulldown

Muscles Worked

Lower Trapezius

Machine Set-Up

- Adjust to Flat Bench Back position.
- Chest Bar pulleys
- Handgrips
- Attach the clips to the Power Rod® resistance rods.

Success Tips

- Keep your knees bent and your feet flat on the floor.
- Keep your spine aligned, abs tight and a slight arch in your lower back.
- Keep your lats tightened through this exercise.
- Release your shoulder blades at the top of each rep.
- Initiate each new rep by depressing your shoulder blades.

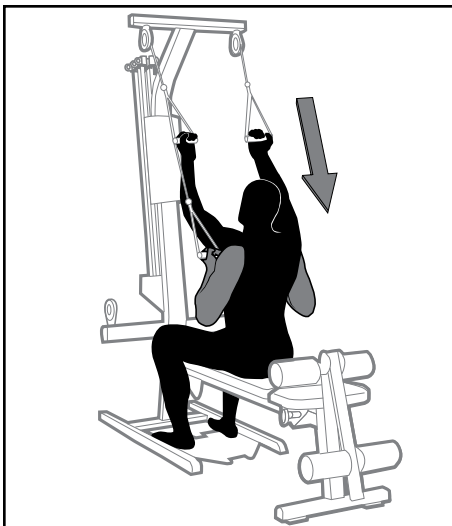

Arm Exercises

Standing Wrist Curl

Muscles Worked

Biceps, Forearms

Machine Set-Up

- Remove the bench
- Chest Bar pulleys
- Handgrips
- Attach the clips to the Power Rod® resistance rods

Success Tips

- Keep your chest lifted, trunk muscles tight and a very slight arch in your lower back.
- Move slowly, keeping tension in the front of your forearms at all times.
- Keep your knees slightly bent and your feet flat on the floor.
- Do not increase or decrease the bend in your elbow during this exercise. Keep all motion in the wrist.
- Do not rock your body back and forth during the wrist motion.

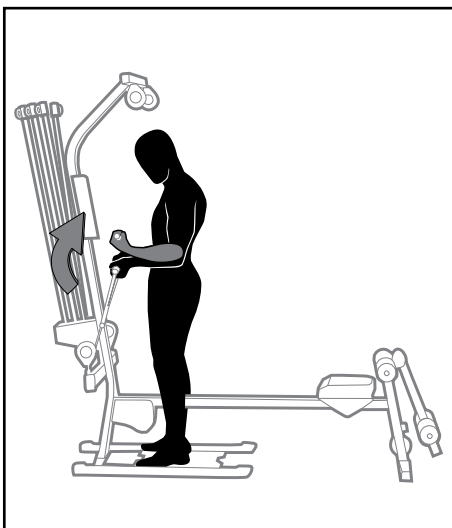

Exercises

Arm Exercises

Triceps Pushdown - Elbow Extension

Muscles Worked

Triceps

Machine Set-Up

- Remove the bench.
- Top Cross Bar pulleys
- Handgrips
- Attach the clips to the Power Rod® resistance rods.

Success Tips

- Keep your upper arms motionless and your wrists straight.
- Keep your chest lifted, abs tight and maintain a slight arch in your lower back.
- Keep your knees slightly bent and your feet flat on the floor.
- Use a controlled motion and tighten your triceps throughout the exercise.

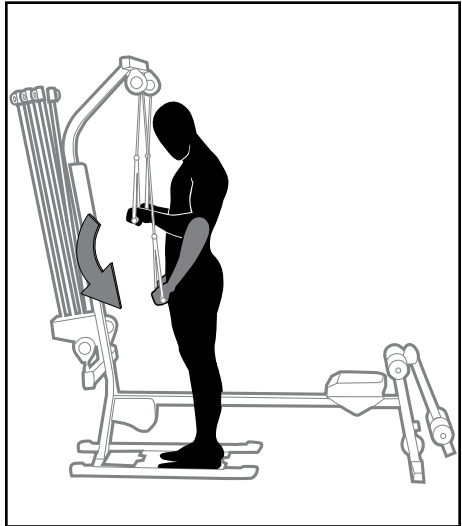

Lying Triceps Extension - Elbow Extension

Muscles Worked

Triceps

Machine Set-Up

- Adjust to Flat Bench Back position.
- Chest Bar pulleys
- Handgrips
- Attach the clips to the Power Rod® resistance rods.

Success Tips

- Keep your knees bent and your feet flat on the floor.
- Lay your head back against the bench.
- Keep your chest lifted, shoulders pinched together and a very slight arch in your lower back.
- Keep your upper arms and shoulders motionless and your wrists straight.
- Use a controlled motion and tighten your triceps throughout the exercise.

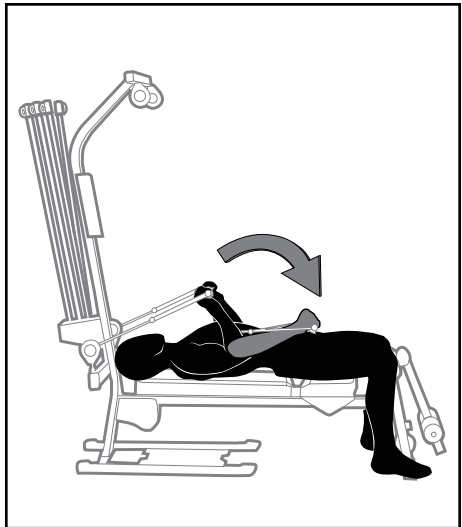

Exercises

Arm Exercises

Standing Biceps Curl - Elbow Flexion (in supination)

Muscles Worked

Biceps

Machine Set-Up

- Remove the bench.
- Chest Bar pulleys
- Handgrips
- Attach the clips to the Power Rod® resistance rods.

Success Tips

- Keep your chest lifted, abs tight and a very slight arch in your lower back.
- Keep your knees slightly bent and your feet flat on the floor.
- Keep your elbows at your sides and your wrists straight.

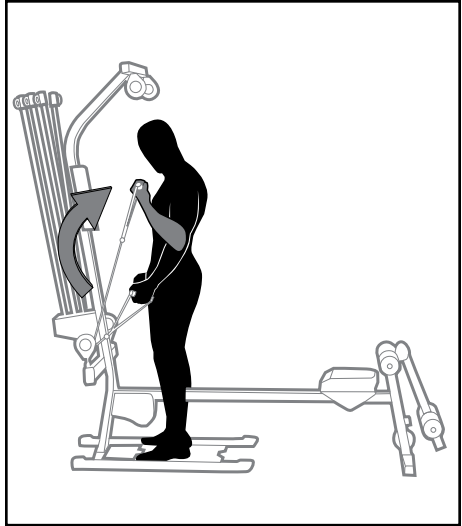

Abdominal Exercises

Trunk Rotation

Muscles Worked

Rectus Abdominus, Obliques, Serratus Anterior

Machine Set-Up

- Adjust to Flat Bench Back position.
- Chest Bar pulleys
- Handgrips
- Attach the clips to the Power Rod® resistance rods.

Success Tips

- Keep your chest lifted, shoulders pinched, abs tight and a slight arch in your lower back.
- Use only low weight Rods.
- Keep all motion in your torso.
- Move only as far as your muscles let you. Do not use momentum to increase your range of motion.

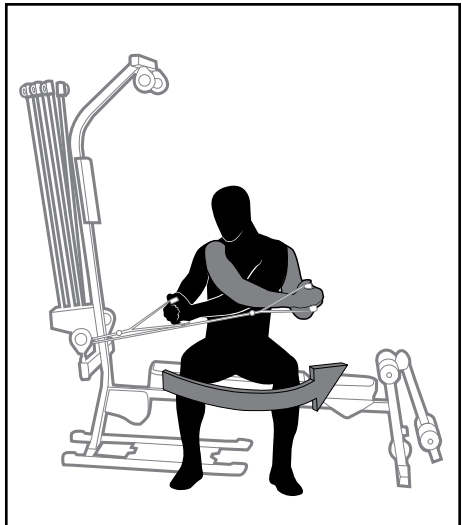

Failure to perform this exercise correctly could result in injury. Use only low resistance rods.

Exercises

Abdominal Exercises

Seated (Resisted) Abdominal Crunch - Spinal Flexion

Muscles Worked

Rectus Abdominus, Obliques

Machine Set-Up

- Adjust the bench to a 45° incline.
- Chest Bar pulleys
- Handgrips
- Attach the clips to the Power Rod® resistance rods.

Success Tips

- Do not lift your head or chin. Your head should follow the rib motion rather than lead it.
- Maintain normal neck posture.
- Tighten your abs throughout the entire exercise and relax only at the end of each set.
- Move slowly to eliminate momentum.
- Exhale during the upward movement and inhale during the downward movement.

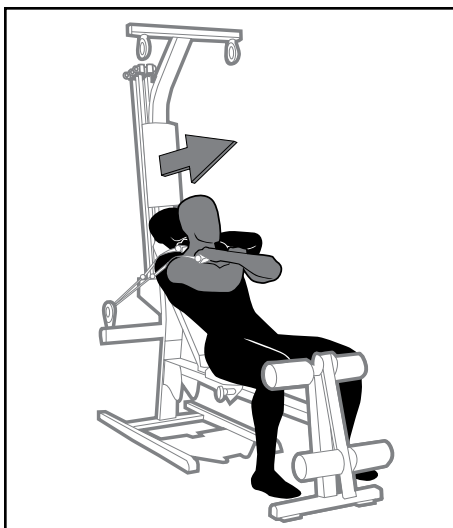

Leg Exercises

Leg Press

Muscles Worked

Gluteus Maximus

Machine Set-Up

- Remove the bench and seat rail knob
- Chest Bar pulleys
- Leg Press Belt
- Attach the clips to the Power Rod® resistance rods

Success Tips

- Keep your chest lifted, spine aligned, abs tight and a very slight arch in your lower back.
- Bend from hip during movement, not from waist.

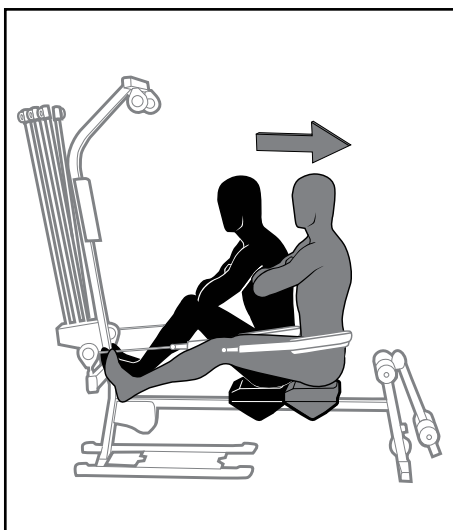

Exercises

Leg Exercises

Leg Extension

Muscles Worked

Quadriceps

Machine Set-Up

- Adjust to Flat Bench Back position.
- Leg Extension pulleys
- Attach the clips to the Power Rod® resistance rods.

Success Tips

- Use slow, controlled motion. Do not kick into the extension.
- Do not let your knees rotate outward during the exercise. Keep your kneecaps pointing up and straight forward.

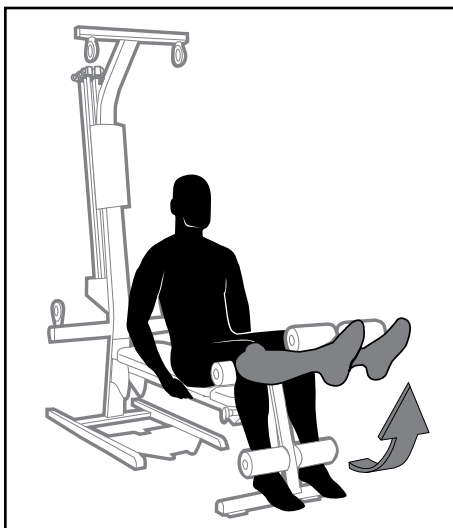

Seated Calf Raise

Muscles Worked

Gastrocnemius, Soleus

Machine Set-Up

- Remove bench and seat rail knob.
- Chest Bar pulleys
- Leg Press Belt
- Attach the clips to the Power Rod® resistance rods.

Success Tips

- Keep your chest lifted, spine aligned, abs tight and a very slight arch in your lower back.
- Do not bend from hip or waist during movement.
- Push with end of foot to fully extend leg.

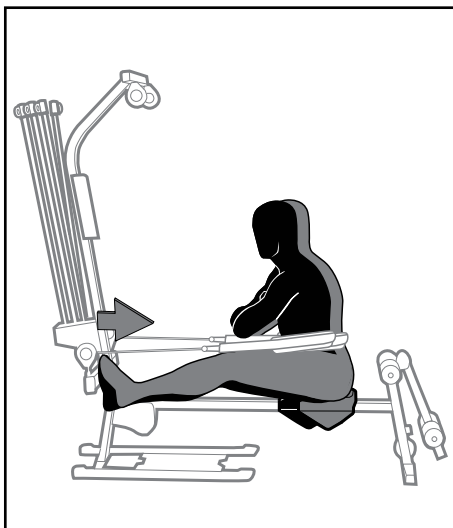

Exercises

Leg Exercises

Seated Hip Adduction

Muscles Worked

Adductor Longus, Gluteus Medius

Machine Set-Up

- Adjust to Flat Bench Back position
- Chest Bar pulleys
- Handgrips
- Attach the clips to the Power Rod® resistance rods

Success Tips

- Do not cross the attached leg in front of the stabilized leg.
- Keep your abs tight and do not lift your hips or excessively arch your back.
- Keep your spine straight and your hips level. Do not raise your hips during the motion.
- Use only a small range of motion.

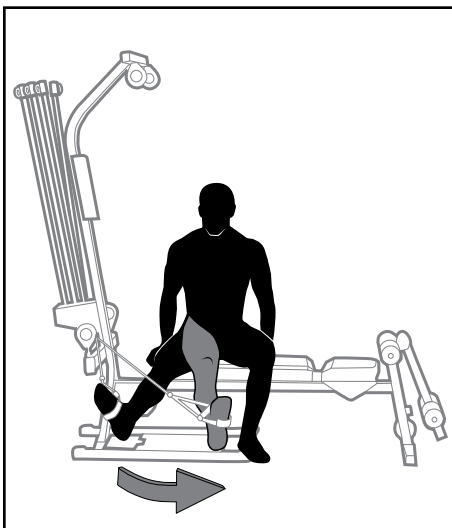

Seated Hip Abduction

Muscles Worked

Piriformis, Gluteus Maximus

Machine Set-Up

- Adjust to Flat Bench Back position.
- Chest Bar pulleys
- Handgrips
- Attach the clips to the Power Rod® resistance rods.

Success Tips

- Keep your spine straight and your hips level. Do not raise your hips during the motion.
- Use only a small range of motion.
- Keep your hips motionless throughout this exercise.

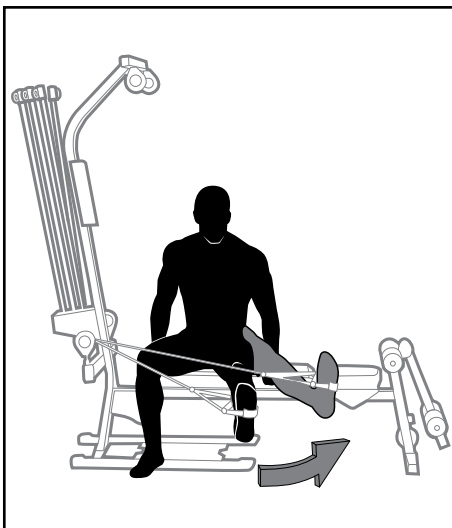

Exercises

Leg Exercises

Standing Leg Kickback - Hip and Knee Extension

Muscles Worked

Gluteus Maximus

Machine Set-Up

- Adjust to Flat Bench Back position.
- Chest Bar pulleys
- Handgrips
- Attach the clips to the Power Rod® resistance rods.

Success Tips

- Keep your chest lifted, spine aligned, abs tight and a very slight arch in your lower back.
- Do not bend from your waist or lower back.
- Hold on to Lat Tower for stability.
- Keep stabilizer foot on foot plate.

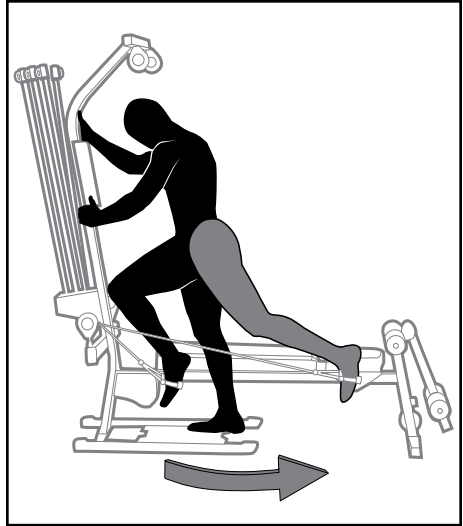



WELCOME TO FITNESS



BY JAY BLAHNIK



WELCOME TO FITNESS

The Nautilus Institute™ is a research-based initiative of Nautilus, Inc. that provides the motivation and education to help more people embrace lifelong health and fitness patterns. The suggestions and recommendations in this guide represent the fundamental beliefs of the Nautilus Institute, and we hope you are able to begin or improve upon a lifetime of high-quality fitness and health. *Start Smart. Stay Smart. Do it For Life!™*



Jay Blahnik, an advisory board member at the Nautilus Institute™, is recognized as one of the premier fitness instructors, trainers and educators in the world today. He has taught sold-out exercise classes and seminars in over 30 countries across the globe, and is known for his results-oriented, simplified training approach. Jay was chosen as one of the Top 5 Instructors in the world by Shape magazine, and Men's Health listed him as having one of the Top 10 workouts of all time. He was also selected as the International Instructor of the Year by IDEA and Can Fit Pro, the two largest associations of fitness professionals in the world. He has appeared in over 25 award-winning videos and developed some of the most successful health club exercise programs in history. He has been the fitness expert in hundreds of magazines, newspapers and on television, and consults for some of the biggest exercise, sports and fitness companies in the world. Jay is also one of the fitness experts for MSNBC.com, and his recent book entitled, *Full Body Flexibility*, has been a critically acclaimed best-seller.



EXERCISE AND HEALTH

It is not a secret that lack of exercise is increasingly becoming a major health issue. Obesity is on the rise, and being overweight can contribute to an increased risk in heart attack, diabetes, high blood pressure and other life threatening illnesses.

Most people do not get enough activity during the day to make up for the time they spend at their desks, driving their cars or sitting in front of their televisions. We have learned that exercising is not simply something we must do to look good and have a great body.

Exercise is a requirement for health, and overall wellness, not to mention it can help you feel great!

The good news is that we are seeing more and more research that indicates we don't have to work out intensely to see the benefits. Sure, it is great if you can work out for thirty to forty minutes at a time, five days a week. But it is not essential. Shorter bouts of exercise can have a great effect (especially if you are just starting out), and a little bit of exercise at a time is much better than none at all.

And what is really exciting is that research indicates that whether you are young or old, people who work out at light to moderate intensities may have an easier time sticking to their exercise programs than those people who work out harder and more often.

So, you do not need to be an athlete or a fitness "die-hard" to benefit from exercise... you just need to get started, work out at levels that are comfortable and enjoyable to you, and stick with it!

YOUR NEW HOME FITNESS PROGRAM

There are many great reasons why home exercise equipment has increased in popularity over the years, but topping the list is convenience. For any fitness program to be successful, it must be something you will stick to on a regular basis. With home exercise equipment, you can roll out of bed, put on a pair of sweats and start working out while the coffee is brewing. No getting in the car and having to drive to the health club. No standing in line waiting for the equipment to become available.



And there is the comfort and safety factor. Who wants to walk or run outside when it is dark or is raining? Or try to ride a bike in the middle of heavy traffic? With your home exercise equipment, you can exercise in the comfort and security of your home.

Privacy and cleanliness are also important. Now you can exercise without feeling rushed or that anyone is looking at you (which is great if you are embarrassed about carrying around a few extra pounds). No more sharing sweaty equipment or wondering if you will catch athlete's foot in the health club shower.

The biggest advantage, however, may simply be the time factor. With work schedules ever-changing and busy family obligations, having a home gym offers you the benefit of being able to work out when it is most convenient. No classes to plan your schedule around, or peak times to avoid. This is especially convenient if you have children at home.

It couldn't be easier!



STEPS TO **GETTING STARTED**

Now that you have made the commitment to start exercising at home, here are some suggestions that may help you stay motivated.

The First Step Is the Most Difficult

Any new habit is difficult to establish at first, but it can be done. Be patient, and plan to start slow and easy. Less is more when you are first starting out ... don't overdo it!

Get a Physical Exam

If you have been inactive for several years or you're new to an exercise program, be sure to consult with your doctor before beginning any exercise program. Especially if you are over 30, have health problems or have a history of heart disease in your family.

Plan for Your Home Fitness Center

Set aside an area or a room in your house or apartment that is exclusively for fitness, and make sure that it is as comfortable as possible, so you'll enjoy using it. If you like listening to music, watching television or looking outside while exercising, make sure these things are accessible. Remember, if you don't enjoy the space you are exercising in, you won't be motivated to continue your program.

Find an exercise buddy

Research has shown that starting an exercise program with someone can increase your chances of sticking to it. If you have a buddy that is also starting a program, you can encourage, motivate and challenge each other.

Make fitness a part of your schedule

Include it in your daily planner just as you would any other appointment. Plan ahead for the week so that you can be sure to fit it in. Even if you are pressed for time one day, a little exercise is better than none at all. Do what you can to fit it in, even if you have less time than you hoped for.

Use Positive Affirmations

Affirmations will help you program your subconscious to accept new beliefs. Saying to yourself a couple of times a day, "I am living a healthier lifestyle by exercising several times per week at home," can help you stay on track.

Set Goals

Setting goals can be helpful in keeping you motivated, but remember to keep them realistic. Short-term and long-term goals can make this easier. How many days do you want to exercise this week? How many workouts would you like to have done by the end of the year?

COMPONENTS OF FITNESS

Over the past 25 years, many people have focused on walking, running, cycling, swimming and other types of aerobic activity as their only means of exercise. However, we have learned that two other components of fitness are just as important. These other two components are muscle strength and flexibility. So in addition to having a strong heart and lungs, we also need to be able to pick up a full bag of groceries and tie our shoes without having to sit down. When developing your home fitness program, it is only appropriate that you develop all three components in order to achieve balanced overall fitness. Let's take a look at all three components:



Cardiovascular Fitness

Training the heart and lungs to be stronger and deliver more oxygen throughout your body with less effort.

It can help reduce the risk of heart disease, and help you manage your weight. It is the cornerstone of fitness, and can be achieved in many ways such as walking or running on the treadmill or outdoors, climbing stairs, cycling, using a StairMaster® stepper, or swimming in the pool or ocean.

For many years, it was suggested that moderate level cardiovascular activity (activities that make you sweat and breathe and a moderate pace) should be done three to four days a week for 15–45 minutes at a time. It is now recommended that you attempt to do some cardiovascular activity EVERY day, if possible.

The good news is that the cardiovascular activity does not need to be moderately intensive everyday, nor does it need to be sustained for 15–45 minutes at a time.

So while it is ideal to challenge your heart and lungs by doing something like a strong power walk every other day for 15–45 minutes, it is more important to make sure you do at least a little bit of cardiovascular activity every day, even if you don't do it for very long or very intensely.

For example, you might try using a Schwinn® Fitness exercise bicycle for a scheduled, moderate level workout for 20–30 minutes on Monday, Wednesday, Friday and Sunday (see the intensity monitoring section for further details on how hard to work out). On the other days, you might try going for a leisurely stroll 10 minutes in the morning and in the evening (or whenever you can fit it in).

Whatever you do, just make sure you get your body moving, and your heart and lungs pumping for some period of time every day.



Muscular strength

Training your muscles to remain strong using resistance such as dumbbells, elastic tubing or your body weight.

In the past decade, we have learned that building or maintaining muscular strength is extremely important for a balanced fitness program. And it is especially important as we get older.

We have learned through a variety of studies that those individuals who just train aerobically (without strength training) do maintain their cardiovascular endurance over the years, but they generally lose lean muscle mass as they get older. However, those individuals who combine strength training and cardiovascular training can maintain their lean body mass as they get older.

What this means is that if you just do cardiovascular activity, your body will naturally lose muscle mass as you get older, and that means that you will actually get “fatter” as you age, unless you incorporate strength training. We have also learned that consistent strength training helps maintain bone and muscle mass. For women, strength training (along with cardiovascular training) may also protect against post-menopausal bone loss and osteoporosis in their later years.

Strength training is not complicated. It is recommended that you do 8–12 repetitions of 8–10 major muscle groups at least two days a week. However, you don’t have to do all these exercises at once. You can break them up into shorter workouts throughout the day. For example, you can do just upper body exercises in the morning, and your lower body exercises in the evening. Or, you can alternate strength exercises with cardiovascular exercise (often known as circuit training) by switching back and forth every couple of minutes.

The best part is you don’t need complicated equipment or fancy machines. You can do everything you need to do with a simple pair of dumbbells, or you can try Bowflex® SelectTech® dumbbells, which provide you a wide variety of weight options in a revolutionary all-in-one dumbbell. You can use elastic tubing, or simply do body weight exercises such as push-ups or lunges.

Flexibility

Being able to bend, reach, twist and turn with comfort and ease as we perform daily tasks, play or exercise.

It is perhaps the most ignored component of fitness, but certainly the easiest one to incorporate into our daily lives because it can be done anywhere and almost at any time.



To maintain your flexibility, you simply need to stretch. This could be as simple as reaching for your toes, or reaching overhead when you wake up in the morning. Or maybe you enjoy it so much that you would be interested in trying the Nautilus® yoga workout video. You can even incorporate stretching into your strength training workouts by stretching the muscles you have used immediately after you have completed your exercise set.

Like cardiovascular training, it is recommended that you stretch every day. However, you do not need to create a formalized program. You can simply make sure that you stretch your major muscle groups throughout the day. Make sure you include your thighs, calves, hamstrings, back, chest, neck and shoulders.

Do what feels good, but also remember to mix it up. Don't just do traditional "reach and hold" stretches. Also, try gently moving through a range of motion that is comfortable to you. For example, you don't have to stretch your neck simply by pulling on your head with your hand. You can also just rotate the neck slowly around and look side to side.



NUTRITION

Every good health and fitness program will also include a good nutrition component. Good nutrition is likely the most important factor in maintaining ideal body weight and managing weight loss. There are a variety of schools of thought regarding which nutrition program, diet or eating plan is best. While we do not promote or endorse any particular one, here are some things to consider that will help you get on the road to a healthy diet:

Understand Caloric Balance

How many calories you intake, and how many calories you burn off will determine whether you will gain or lose weight day to day. It is impossible to achieve weight loss without some sort of “caloric deficit” that can be obtained through cutting calories, or burning off more than you take in. The wisest approach is to do a little of both—cutting calories and exercising. It is the only proven long-term weight management program that is successful. You should ensure that you are consuming at least 1,200 calories per day total. A total weight loss of no more than two pounds per week is recommended for long-term weight management.

Eat a Variety of Foods

Regardless of your eating plan, you should be sure to include a variety of foods in your diet, maximizing your intake of fruits and vegetables whenever possible. Colorful meals and snacks that are divided amongst the four food groups will ensure that you obtain the nutrients needed for your body to function at optimal levels. Any diet that focuses on just one food group source or processed foods can be unhealthy in the long run, and should be avoided. Don't focus too much on any particular meal or snack, but rather on your overall intake of a variety of different foods during any given day.

Drink Water

Our bodies are made up of over 70 percent water, and most of us don't drink enough. Carry water with you everywhere you go, and drink as often as you can. This helps the body function at optimum levels, and can significantly help with weight management.

Eat More Often and Be Mindful of Your Portions

Research has shown that it can be helpful to eat smaller meals more often versus three larger meals a day. Many portions we eat are much larger than necessary, and can be laden with calories. So, try eating healthy snacks more often and reducing the amount of large meals you eat. Sharing your snacks or food with others (or breaking your portions in half) can help you better manage your caloric intake.

MONITORING YOUR INTENSITY

When you are doing cardiovascular workouts, it is important that you work at the appropriate intensities when you are first starting out. It is also important that you work out at a variety of intensities after you have built a fitness base. Research in recent years has indicated that one of the best ways to monitor your cardiovascular intensity is to pay close attention to how you are feeling when you work out. Most individuals can do a very good job of choosing the correct intensities if they simply categorize how they feel into one of four intensity “zones.”



These zones could be described the following ways:

Zone Description

Zone	Description
1	Easy Warm up Cool down
2	Challenging, but comfortable Steady endurance pace
3	Challenging and slightly uncomfortable Race pace Borderline out of breath
4	Breathless Not maximum, but winded Can't keep the pace for very long

When you are first starting out, you should exclusively work in the Zone 1 and Zone 2 intensities. After a few weeks, you can occasionally incorporate Zone 3 and Zone 4 intensities for short periods of time. Remember, when you begin to incorporate Zone 3 and Zone 4 intensities, you will find that you will likely have to drop down to Zone 1 intensities shortly thereafter as brief recovery periods.

For variety, you can spend a little bit of time in each of the four Zones during one workout, and then spend your time in just one Zone during the next workout. Prenatal woman should always remain at Zone 1 and Zone 2 intensities, and anyone unaware of their current medical condition should also avoid Zone 3 and Zone 4 without prior clearance from their doctor.



These Zones can be translated into target heart rate numbers if your home fitness product has a grip or telemetric heart rate counter. Research has shown the best way to do this is not to establish heart rate numbers based upon age, but rather based upon how you feel.

The following chart will allow you to log your heart rate numbers based upon how you feel when working out. Simply log the heart rate numbers you find when you feel you are working at each of the specific intensities.

Zone	Description	Your Heart Rate	Approximate Percentage of Maximum Heart Rate
1	Easy Warm up Cool down	Insert the heart rate you get when you are in Zone 1	50% – 65%
2	Challenging, but comfortable Steady endurance pace	Insert the heart rate you get when you are in Zone 2	65% – 75%
3	Challenging and slightly uncomfortable Race pace Borderline out of breath	Insert the heart rate you get when you are in Zone 3	75% – 85%
4	Breathless Not maximum, but winded Can't keep the pace for very long	Insert the heart rate you get when you are in Zone 4	85% – 95%

As you get in better shape, the heart rate number you obtain for each zone will get higher and higher, which means your heart is able to handle higher intensities. Or you may find that your numbers don't change, but you are able to stay in Zone 3 and Zone 4 longer than you used to.

Don't get too attached to any specific number or target heart rate. If you train properly, you will notice numbers that used to be difficult have now become easier. You will also notice that if you are sick or over-tired, you may find that numbers that usually feel fairly easy are one day much harder, and it is a good sign to take a break.

If you notice that numbers that are usually very challenging are one day fairly easy, then it is a good time to push yourself.

Listening to your body and using your heart rate numbers (when available) will enable you to keep track of your intensity and see your progress as you train.

BEATING THE DROPOUT ODDS

The Surgeon General's Report on Physical Activity and Health summarizes a few main points:

1. Regular physical activity offers substantial improvements in health and well-being for a majority of Americans.
2. If you exercise regularly, you'll reduce your risk of heart attack, cancer, diabetes, high blood pressure, osteoporosis and even the common cold.
3. Regular exercise, regardless of the intensity, can help you control stress, sleep problems and depression.



The benefits of exercise and activity are **AMAZING!** And yet, only 22 percent of Americans engage in exercise for 20 minutes a day. And even among individuals who begin exercise programs, the dropout rate is about 50 percent.

So, how do you beat these odds? The answer appears to be in how you start and maintain your exercise program as well as how you create an exercise habit. Why are you starting an exercise program? For most individuals, it is to lose weight and look better, which are great reasons. However, since changes in your body shape and size can be gradual, and won't happen overnight, it is important to focus on other benefits so that you will remain motivated.

Thrive on the energy that exercise gives you. Watch your health risks scores go down. Pay attention to how much easier everyday activity is. Notice how much better you are sleeping. These kinds of additional benefits will continue to keep you motivated if you make them just as important to you as weight loss.

Additionally, try not to view exercise as punishment. Look at it as an investment in your health. If you don't feel motivated to work out one day, think of something that is appealing to you that is active, and change your workout. Try not to let your workout become routine or mundane, and always remember that some exercise is better than none at all. So, if you feel you are not motivated to continue, stop your workout early, or skip a day. It just might be the thing you need to get you excited about your next workout.

Possibly the most important thing is to keep progressing your exercise program slowly. Big increases in time or intensity can set you up for injury, and cause you to drop out. Unless you are a world-class athlete, there is no reason to work out at world-class levels. Remember to give yourself some days off and get proper rest. Finally, try to anticipate lapses. If you are traveling, or your schedule is becoming busier, and you are fearful you may get off track, try planning ahead. For example, book a hotel that has a workout facility or change up your workout so that you keep your interest high and your boredom low. The bottom line is you must be creative and innovative to keep up your fitness program. With some imagination and planning, it is easy to do.

Exercise is one of life's joys. It energizes you, helps you look and feel better and puts you on the road to better health. Your home fitness equipment and gym is worth its weight in gold. Congratulations on making the choice to get started!



SUGGESTED READING



The Complete Home Fitness Handbook

by Edmund Burke

Human Kinetics



Full Body Flexibility

by Jay Blahnik

Human Kinetics

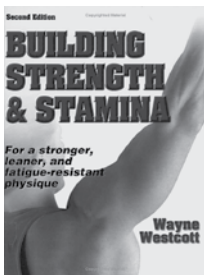

Building Strength and Stamina

by Wayne Westcott, PhD

Human Kinetics

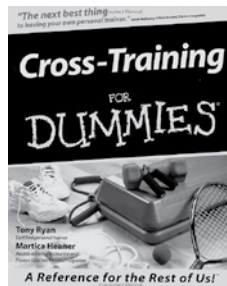

Cross-Training for Dummies

by Tony Ryan and Martica Heaner

For Dummies



FAST FAT LOSS NOW!

THE BOWFLEX® BODY LEANNESS PROGRAM



BY **DR. ELLINGTON DARDEN**



THE **BOWFLEX®** BODY LEANNESS PROGRAM

This program is scientifically designed for maximal fat loss over a period of six weeks. It is important that you practice every aspect of the plan to achieve optimum results.

The program separates into three two-week stages. During each stage you will exercise, control the number and quality of calories you consume, and drink plenty of ice-cold water.

Before starting the exercise routine you must be familiar with your Bowflex® home gym. You should experiment with finding the proper amount of resistance to use on each exercise. You should be able to perform 8 repetitions, but not more than 12 repetitions, for each exercise. It is essential that you learn how to perform each movement before trying a complete circuit, because part of the effectiveness of the training depends on minimal rest between each exercise.



WARNING!

Before beginning this program consult your physician or healthcare professional. Show this plan and your Bowflex® Owner's Manual to your physician or healthcare professional. Only he or she can determine if this course is appropriate for your particular age and condition. If you experience any light-headedness, dizziness, or shortness of breath while exercising, stop the movement and consult a physician.

Make sure you read your Bowflex® Owner's Manual BEFORE attempting a workout.

There are a few people who should not try this program: Children and teenagers; pregnant women; women who are breast feeding; diabetics; individuals with certain types of heart, liver, or kidney disease; and those suffering from certain types of arthritis. This should not be taken as an all inclusive list. Some people should follow the course only with their physician's specific guidance. Play it safe and consult a healthcare professional.

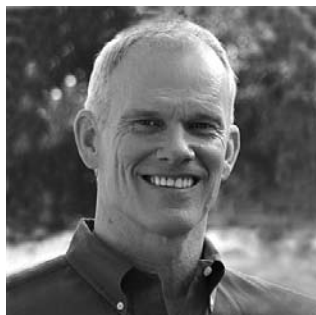

A GUARANTEE FROM DR. ELLINGTON DARDEN

Dear Bowflex® Enthusiast,

I'm excited, really excited! I'm elated because I've researched and developed an exercise and eating program that produces fat loss faster than any plan I've ever tested.

For example, the men involved in my research project had an average fat loss of 27.95 pounds (12.68 kg) per man. Women on the same program averaged a reduction of 16.96 pounds (7.69 kg). **Best of all, these dramatic results were achieved – not in six months – but in only six weeks!**

That's right – just six short weeks. You can accomplish similar results in six weeks when you follow my fitness and nutrition program.

Bowflex® home gyms were a significant part of my research results.

The exercises in my program, performed on a Bowflex® machine – 18 workouts (3 per week) – allowed the participants to build muscle, which accelerated their metabolisms, and produced faster and greater fat losses. The plan worked so well that it became known as The Bowflex® Body Leanness Program.

Obtaining leanness means to strip away the fat from under the skin as well as at deeper levels. Leanness also implies a pleasing shape and tone to the skeletal muscles. You might say leanness is the opposite of fatness. The people involved in my research certainly got rid of their excessive fatness in record time.

All the guidelines that were applied to my research, including simple exercise instructions and specific menus to use, have been organized in the booklet you are now holding in your hands. It's the next best thing to actually going through one of my research projects. In fact, it's probably better since nothing is experimental. All of the fine points have been tried, tested and proven effective.

If you are overfat, and if you are interested in doing this program, there are several things you need to understand about my experience. Since 1965, I've trained more than 10,000 overfat individuals.

After many years of pushing, coaxing, and listening to these trainees, certain traits became evident to me:

- People are not lazy by choice. They are forced into it by the confusion that surrounds the abundance of fitness information that is available. If these individuals are given simple decisive instructions, they will train very intensely.
- People, if they are provided with specific menus, will drastically alter their eating habits.
- Most of these people, however, will do neither of these challenging things for more than a week – unless they quickly see and feel changes in their body.

The Bowflex® Body Leanness Program emerged from these findings.

If you want to get the best-possible results from this program, you must be willing to exercise very intensely on the Bowflex® machine and adhere to a strict eating plan. In return, you'll get my guarantee that if you follow the program exactly as directed, you'll observe the pounds and inches disappear on almost a weekly basis.

Now it's your turn to get excited, and get started!

Sincerely,

Dr. Ellington Darden

MEASUREMENTS

If you would like to measure your personal before-and-after results, there are several steps you need to take. It is important that you accurately perform each task, then at the end of the six-week program, repeat the process in the same manner.

Body Weight

Remove clothing and shoes and record your weight to the nearest quarter pound or hundred grams. Be sure to use the same scale when weighing yourself at the end of the six-week program. For the most accurate recordings, weigh yourself nude in the morning.

Since the program is divided into three two-week segments, you may want to weigh yourself at the end of each two-week period. Understand, however, that weight loss is not the best way to determine your success. Fat loss is the key component. To determine the amount of fat you've lost, you'll need to follow the instructions in the next section. Enter your starting weight on the Results Summary Sheet (page 7).

Circumference of Body Parts

For an even better idea of the changes that will occur to your body in the next six weeks, it is necessary to measure the circumference of certain body parts. This will tell you where the fat is shrinking and what areas are toning up. Use a plastic tape to measure the following:

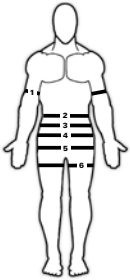

- 1) Upper arms – hanging and relaxed, midway between the shoulder and elbow.
- 2) 2" (5 cm) above navel – belly relaxed.
- 3) At navel – belly relaxed.
- 4) 2" (5 cm) below navel – belly relaxed.
- 5) Hips – feet together at maximum protrusion of buttocks.
- 6) Thighs – high, just below the buttocks crease with legs apart and weight distributed equally on both feet.

Record each measurement on your Results Summary Sheet (page7).

Optional Picture Taking

Pictures can be the most exciting evaluation you can do. The numbers and the tape measurements are great, but actually seeing differences from comparison photographs of yourself is quite satisfying.

Taking full-length photographs is not difficult, but to see the maximum difference between before and after, you should follow these guidelines.

- 1) Keep everything the same. Wear the same outfit, a snug solid color is best, and have the person taking the picture stand in the same place, with the same setting behind you.
- 2) Make sure you stand against an uncluttered, light background.
- 3) Have person taking the photograph move away from you until he can see your entire body in the viewfinder.
- 4) Stand relaxed for three pictures, front, right side, and back. Do not try to suck in your stomach.
- 5) Interlace your fingers and place them on top of your head, so the contours of your torso will be plainly visible. Keep your feet 8" (20 cm) apart in all three pictures.
- 6) When you get the film developed tell the processors to make your after photos the same size as your previous ones. This way, your height in both sets of photos is equal and more valid comparisons can be made.





To accurately track your progress through this six-week program, it is necessary to take skinfold measurements. By measuring yourself in this way, you will be able to determine your lean-body mass and your body-fat percentage. The goal of this program is to increase your lean-body mass and decrease your body-fat percentage.

Please read this section carefully. Proper measuring techniques are essential to track your success. It is best to have someone measure you. Measuring yourself can lead to inaccurate results.

Women measure: Suprailium, triceps and thigh. Men measure: Chest, abdomen and thigh.



Suprailium

Stand relaxed. Pick up a diagonal skinfold just above the crest of the hip bone on the right side of the waist.



Triceps

Stand with right elbow flexed 90 degrees and locate the center of the back of the upper arm midway between the shoulder and the elbow. Relax arm at your side. Pick up skinfold as pictured.

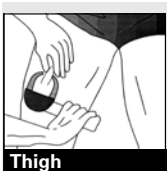

Thigh

Stand relaxed with most of the weight on your left leg. Pick up a skinfold in the vertical plane on the front side of the right thigh, midway between the hip and knee joints.



Chest

Stand relaxed. Pick up a diagonal skinfold over the right pectoralis muscle, midway between the armpit and the nipple.



Abdomen

Stand relaxed. Pick up a vertical skinfold on the right side of the navel.

Using calipers when measuring skinfolds

The procedure for measuring skinfold thickness is to grasp firmly with the thumb and forefinger a fold of skin and surface fat and pull it away from the underlying muscle. Take the caliper in your other hand and open the jaws. Clamp the jaws over the pinched skin and fat. The jaws exert constant tension at the point of contact with the skin. The thickness of the double layer of skin and fat can then be read directly from the caliper, which is marked in millimeters.

Women

Suprailium _____
 Triceps _____
 Thigh _____
 TOTAL _____

Men

Chest _____
 Abdomen _____
 Thigh _____
 TOTAL _____

Use these figures on the following chart to determine your body-fat percentage and enter the number on the line below.

Starting body-fat percentage: _____

DETERMINING YOUR BODY FAT

To Use The Nomogram:

- 1) Locate the sum of your three skinfolds in the right column and mark it.
- 2) Locate your age in years on the far left column and mark it.
- 3) Connect the two marks with a straightedge. Where the straightedge intersects the line in the middle column appropriate to you, you will find your body-fat percentage.

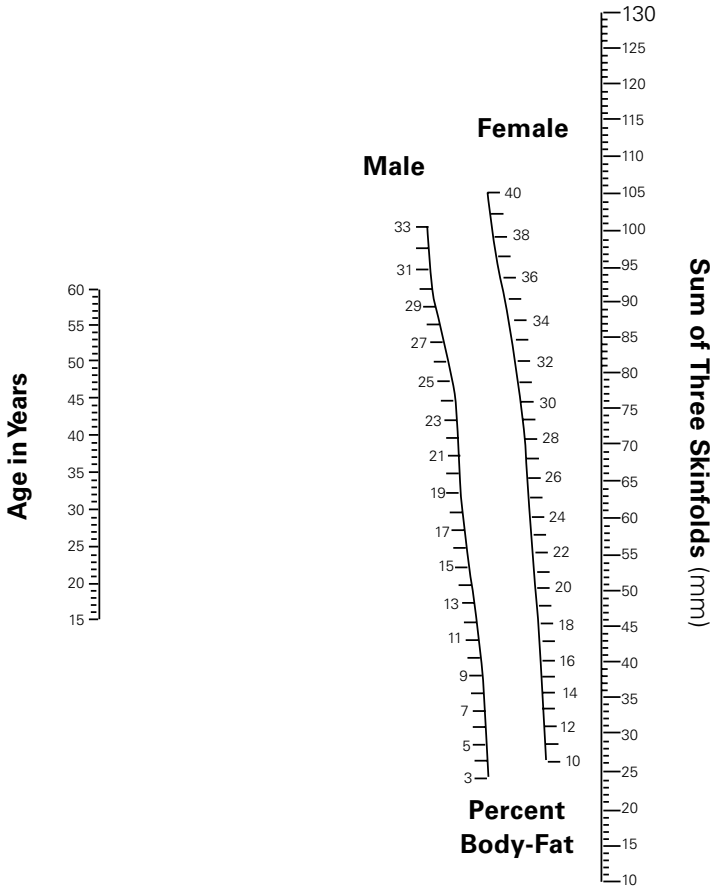

Baun, W.D., Baun, M.R., and Raven, P.B. A nomogram for the estimate of percent body fat from generalized equations. Research Quarterly for Exercise and Sport, 52:380-384, 1981.

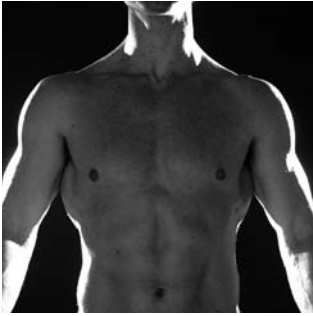

CALCULATING LEAN BODY MASS

Now that you know your body-fat percentage, you can calculate your lean-body percentage. This will eventually show you how many pounds of muscle were added to your body, after completing the program.

For Example:

Before the program, Joe weighs 200 pounds (90.7 kg) and measures 30% fat, which amounts to 60 pounds (27.2 kg). Thus, his lean-body mass is 70%, or 140 pounds (63.5 kg).

After the program, Joe weighs 180 pounds (81.6 kg) and is 20% fat, which equals 36 pounds (16.3 kg). His lean-body mass is 80%, or 144 pounds (65.3 kg).

Simple calculations allow us to find the amount of fat Joe lost, and the amount of muscle Joe gained. Before fat weight (60 pounds), minus after fat weight (36 pounds) equals 24 pounds (10.8 kg) of fat lost. After lean-mass weight (144 pounds) minus before lean-mass weight (140 pounds) equals 4 pounds (1.8 kg) of muscle gained.

Enter Your Information Here: (Pounds or Kilograms)

Body Weight		Before		Body Fat Weight
	X	Fat Percentage	=	
Body Weight		Weight of Body Fat		Lean-Body Weight
	-		=	

Use the Same Factors to Calculate After Six Weeks.

Body Weight		After		Body Fat Weight
	X	Fat Percentage	=	
Body Weight		Weight of Body Fat		Lean-Body Weight
	-		=	

Before Body Fat Weight		Final Results		Total Fat Loss
	X	After Body Fat Weight	=	
After Lean-Mass Weight		Before Lean-Mass Weight		Total Lean-Mass Gained
	-		=	

YOUR RESULTS SUMMARY SHEET

Name _____ Age _____
 Height _____ Weight Loss _____
 Weight Before _____ Muscle Gain _____
 Weight After _____ Fat Loss _____



Please follow the instructions in the "Measurements" section (page 3) for measuring circumferences.

	<i>Before</i>	<i>After</i>	<i>Difference</i>
Right Arm:			
Left Arm:			
2" (5 cm) Above Navel:			
Navel:			
2" (5 cm) Below Navel:			
Hips:			
Right Thigh:			
Left Thigh:			
	Total:		
Percent Body Fat:			

If you wish to send in your results to Nautilus, Inc., please send to: Bowflex® Results, Nautilus, Inc. World Headquarters, 16400 S.E. Nautilus Drive, Vancouver, WA 98683.

Or you may fax this sheet to Bowflex® Results at 1-360-694-7755. Please include your name, address, and phone number. Submissions may be selected for use in promotional marketing materials.

THE WORKOUTS

GUIDELINES Week 1 & 2

All exercises should be practiced with one set of 8 to 12 repetitions. The style of performance is very important. The movement for each repetition should be 4 seconds in the positive phase and 4 seconds in the negative. Keep the motion slow and smooth. When 12 repetitions are accomplished, increase the resistance by approximately 5 percent. Keep the time between exercises to a minimum, no longer than 60 seconds. No workout should take more than 30 minutes to complete. Perform each workout three days a week.

Week 1 & 2 Exercise	Sets	Reps
Leg Curl	1	8-12
Leg Extension	1	8-12
Bench Press	1	8-12
Lying Biceps Curl	1	8-12
Seated Shoulder Press	1	8-12
Seated Abdominal Crunch	1	8-12

GUIDELINES Week 3 & 4

All exercises should be practiced with one set of 8 to 12 repetitions. The style of performance is very important. The movement for each repetition should be 4 seconds in the positive phase and 4 seconds in the negative. Keep the motion slow and smooth. When 12 repetitions are accomplished, increase the resistance by approximately 5 percent. Keep the time between exercises to a minimum, no longer than 45 seconds. No workout should take more than 30 minutes to complete. Perform each workout three days a week.

Week 3 & 4 Exercise	Sets	Reps
Leg Curl	1	8-12
Leg Extension	1	8-12
Bench Press	1	8-12
Lying Biceps Curl	1	8-12
Seated Shoulder Press	1	8-12
Rear Deltoid Rows*	1	8-12
Seated Triceps Extension	1	8-12
Seated Abdominal Crunch	1	8-12

GUIDELINES Week 5 & 6

All exercises should be practiced with one set of 8 to 12 repetitions. The style of performance is very important. The movement for each repetition should be 4 seconds in the positive phase and 4 seconds in the negative. Keep the motion slow and smooth. When 12 repetitions are accomplished, increase the resistance by approximately 5 percent. Keep the time between exercises to a minimum, no longer than 30 seconds. No workout should take more than 30 minutes to complete. Perform each workout three days a week.

Week 5 & 6 Exercise	Sets	Reps
Leg Curl	1	8-12
Leg Extension	1	8-12
Leg Press	1	8-12
Bench Press	1	8-12
Lying Biceps Curl	1	8-12
Lying Shoulder Pullover	1	8-12
Reverse Fly	1	8-12
Rear Deltoid Rows*	1	8-12
Seated Triceps Extension	1	8-12
Seated Abdominal Crunch	1	8-12

* The Upright Row exercise was used in Dr. Darden's original study. Although many people have used this exercise for years, recent information in the Physical Therapy field has caused the authors of this manual to caution against performing this exercise because of the unnatural twisting movement created in the shoulder joint. We suggest you substitute Rear Deltoid Rows for the Upright Row exercise.

EATING GUIDELINES



You will be following a reduced-calorie nutrition program, which is divided into three two-week segments. The program is a proven method for achieving maximal fat loss over a six-week period. It consists of a carbohydrate-rich, descending-calorie eating plan and a superhydration routine.

Follow a Carbohydrate-Rich, Descending-Calorie Eating Plan

Approximately 60 percent of the daily calories should be from carbohydrates. The other 40 percent will be equally divided between proteins and fats. The 60:20:20 ratio of carbohydrates, proteins, and fats is ideal for maximum fat loss.

Keep Menus Simple and Food Substitutions to a Minimum Research has established that successful dieters prefer the same foods each day for breakfast and lunch. They like variety, however, for dinner. Detailed menus and food choices are included later in this manual. If you must vary from the menu items, try to stay within the 60:20:20 ratio of carbohydrates, proteins and fats.

Avoid Too Much Stress Too much stress of any kind can cause the body to actually preserve fat stores. You should relax more. An after-dinner walk at a leisurely pace is helpful. Extra sleep is suggested, since sleep facilitates fat loss and muscle recovery. Furthermore, to keep the body well rested, no other exercises or activities are allowed during the six-week program. This is a scientifically proven program that works. More is not better. Any additional exercise other than the amount recommended can and will harm your fat loss.

Superhydrate your system Drinking plenty of water is essential to the success of this program. Drinking the recommended amount of water can seem like a challenge at first. Stick with it. Carry a large sports bottle or similar item with you throughout the day. After several weeks, you will find that you actually thirst for more and more water, and the amounts recommended are easily reached.

Superhydration aids fat loss in a number of ways. First, the kidneys are unable to function without adequate water. When they do not work to capacity some of their load is dumped onto the liver. This diverts the liver from its primary function, which is to metabolize stored fat into usable energy. Because it's performing the chores of the water-depleted kidneys, the liver metabolizes less fat. Second, overeating can be averted through water intake, as water can keep the stomach feeling full and satisfied between meals. Third, ice-cold water requires calories to warm it to core body temperature. In fact, 1 US gallon of ice cold water (3.8 l) generates 123 calories of heat energy.

You'll be drinking from 1 to 1 5/8 US gallons (3.8 - 6.2 l) of water each day on the following superhydration schedule:

Week 1: drink four 32-oz. bottles (3.8 l) of ice-cold water per day.

Week 2: drink four-and-a-half 32-oz. bottles (4.3 l) of ice-cold water per day.

Week 3: drink five 32-oz. bottles (4.6 l) of ice-cold water per day.

Week 4: drink five-and-a-half 32-oz. bottles (5.2 l) of ice-cold water per day.

Week 5: drink six 32-oz. bottles (5.7 l) of ice-cold water per day.

Week 6: drink six-and-a-half 32-oz. bottles (6.2 l) of ice-cold water per day.

Don't be surprised if you have to make more than a dozen trips to the restroom, especially during the first week of the program. Remember, your body is an adaptive system, and it will soon accommodate the increased water consumption.

Note: Although it is doubtful that you could ever drink too much water, a few ailments can be negatively affected by large amounts of fluid. For example, anyone with a kidney disorder, or anyone who takes diuretics, should consult a physician before going on the recommended water-drinking schedule. If you have any doubts about the recommendations, play it safe and check with your doctor.



THE EATING PLAN

The menus in the Bowflex® eating plan are designed for maximum fat-loss effectiveness and nutritional value.

For best results, follow them exactly.

Every attempt has been made to utilize current popular brand names and accurate calorie counts, which are listed in the menus. But as you probably realize the products are sometimes changed or discontinued. If a listed item is not available in your area, you'll need to substitute a similar product. Become an informed label reader

at your supermarket. Ask questions about any products you don't understand. Supermarket managers are usually helpful. If they don't have an answer to your question, they will get it for you.

Each day you will choose a limited selection of foods for breakfast and lunch. Most people can consume the same basic breakfast and the same basic lunch for months with little modification. Ample variety during your evening meal, however, will make daily eating interesting and enjoyable. Additionally, the eating plan includes a mid-afternoon and late-night snack to keep your energy high and your hunger low.

Begin Week 1 on Monday and continue through Sunday. Week 2 is a repeat of Week 1. Calories for each food are noted in parentheses. A shopping list follows. The eating plan for the next six weeks descends:

Weeks 1 & 2: Men 1500 calories per day. Women 1200 calories per day.

Weeks 3 & 4: Men 1400 calories per day. Women 1100 calories per day.

Weeks 5 & 6: Men 1300 calories per day. Women 1000 calories per day.

You'll always have a 300 calorie breakfast, a 300 calorie lunch, and a 300 calorie dinner (women), or 500 calorie dinner (men). With each two-week descend, only your snack calories will change: from 400 to 300 to 200 calories per day (men), or 300 to 200 to 100 calories per day (women). For each of your five daily meals, you'll have at least three choices. Everything has been simplified so even the most kitchen-inept person can succeed. Very little cooking is required. All you have to do is read the menus, select your food choices, and follow the directions. It's as simple as that. If you find that you wish to vary from the outline menu items try to stay with in the 60:20:20 ratio of carbohydrates, proteins, and fats.

Daily Calories	Carbohydrates 60%	Protein 20%	Fat 20%
2000	1200	400	400
1900	1140	380	380
1800	1080	360	360
1700	1020	340	340
1600	960	320	320
1500	900	300	300
1400	840	280	280
1300	780	260	260
1200	720	240	240
1100	660	220	220
1000	600	200	200

THE EATING PLAN

Quantities needed for listed items will depend on your specific selections. Review your choices and adjust the shopping list accordingly. It may be helpful for you to photocopy this list each week before doing your shopping.



Staples	Grains	Fruits	Vegetables
Orange juice Skim milk Whole-wheat bread Promise Ultra® Vegetable Oil Spread Italian fat-free dressing Dijon mustard Safflower oil Noncaloric beverages (tea, decaffeinated coffee, diet soft drinks, water)	Bagels: Sarah Lee® (frozen) Cereals: 1.5oz. (42g) serving equals approx. 165 calories; Kellogg's® Low-Fat Granola (w/o raisins), General Mills® Honey Nut Clusters, General Mills® Basic 4 Wheat germ Malted milk powder Popcorn (microwave light)	Bananas, large (8 3/4 inches [22 cm] long) Apples (3-inch [7.6 cm] diameter) Cantaloupes (5-inch [12.7 cm] diameter) Dried prunes Raisins	Lettuce Tomatoes Whole kernel corn (canned no salt added) Sweet peas (canned no salt added) Sliced white potatoes (canned) Cut beets (canned)
Dairy	Meat, Poultry & Fish	Canned Soup	Frozen Microwave Dinners
Yogurt (light nonfat) Cream cheese (light) Cheese (fat-free) Low-fat frozen yogurt Carnation® Instant Breakfast packets Champion UltraMet® Packets	Chicken (thin sliced) Turkey (thin sliced) Tuna (canned in water) Sirloin steak (lean)	Healthy Choice® Hearty Chicken Campbell's® Healthy Request Hearty Vegetable Beef	Lean Cuisine® Glazed Chicken Dinner Lean Cuisine® Lasagna with Meat Sauce Lean Cuisine® Lunch Express Broccoli & Cheddar Cheese over Potato Weight Watchers® Macaroni and Cheese Healthy Choice® Grilled Turkey Breast

THE EATING PLAN (US MEASUREMENTS*)

Breakfast = 300 calories

Choice of bagel, cereal or shake.

Bagel

- 1 plain bagel (frozen) (210)
- 3/4 oz. light cream cheese (45)
- 1/2 C. orange juice, fresh or frozen (55)
- Any beverage without calories, caffeine, or sodium, such as decaffeinated coffee or tea.

Cereal

- 1.5 oz. (42 grams) serving equals approximately 165 calories.
- Choice of one: Kellogg's® Low Fat Granola (without raisins), General Mills® Honey Nut Clusters, General Mills® Basic 4
- 1/2 C. skim milk (45)
- 3/4 C. orange juice (82)

Noncaloric beverage

Shake (choice of one shake)

Place ingredients in blender.

Blend until smooth.

Banana-Orange Shake

1 large banana (8 3/4 inches long) (100)

1/2 C. orange juice (55)

1/2 C. skim milk (45)

2 T. wheat germ (66)

1 t. safflower oil (42)

2 ice cubes (optional)

or Chocolate or Vanilla Shake

1 packet Carnation® Instant

Breakfast, Champion UltraMet®,

or another diet shake powder that

contains the appropriate calories

(100)

1 C. skim milk (90)

1/2 large banana (8 3/4 inches

long) (50)

1 t. safflower oil (42)

1 t. Carnation® Malted Milk powder

(20)

2 ice cubes (optional)

Lunch = 300 calories.

Choice of sandwich, soup or salad.

Sandwich

- 2 slices whole wheat bread (140)
- 2 t. Promise Ultra® Vegetable Oil Spread (24)
- 2 oz. white meat (about 8 thin slices), chicken or turkey (80)
- 1 oz. fat-free cheese (1 1/2 slices) (50)
- (Opt.: Add to bread 1 t. Dijon mustard (0))

Noncaloric beverage

Soup (choice of one soup)

- Healthy Choice® Hearty Chicken, 15-oz. can (260), or
- Campbell's® Healthy Request Hearty Vegetable Beef, 16-oz. can (260)

1/2 slice whole-wheat bread (35)

Noncaloric beverage

Chef Salad

2 C. lettuce, chopped (20)

2 oz. white meat, chicken or turkey (80)

2 oz. fat-free cheese (100)

4 slices tomato, chopped (28)

1 T. Italian, fat-free dressing (6)

1 slice whole wheat bread (70)

Noncaloric beverage

Mid-Afternoon Snack

Men—200 calories for Weeks 1&2;

150 calories for Weeks 3&4;

100 calories for Weeks 5&6.

Women—150 calories for Weeks 1&2;

100 calories for Weeks 3&4;

50 calories for Weeks 5&6

Choose calories from:

1 large banana (8 3/4 inches long) (100)

1 apple (3-inch diameter) (100)

1/2 cantaloupe (5-inch diameter) (94)

5 dried prunes (100)

1 oz. (2 small 1/2 oz. boxes) raisins (82)

1 C. light, nonfat, flavored yogurt

(100)

Dinner

Men: 500 calories, Women: 300 calories

Choice of tuna salad dinner, steak dinner or frozen microwave dinner.

Tuna Salad Dinner

In a large bowl, mix the following:

1 6-oz. can chunk light tuna in water (180)

1 T. Hellmann's® Light, Reduced-Calorie Mayonnaise (50)

2 T. sweet pickle relish (40)

1/4 C. whole kernel corn, canned, no salt added (30)

Noncaloric beverage

Men add:

1/2 C. sliced white potatoes, canned (45)

2 slices whole wheat bread (140)

Steak Dinner

3 oz. lean sirloin, broiled (176)

1/2 C. sweet peas, canned, no salt added (60)

1/2 C. beets, canned (35)

1/2 C. skim milk (45)

Noncaloric beverage

Men add:

2 slices whole wheat bread (140)

1 t. Promise Ultra® Veg Oil Spread (12)

1/2 C. skim milk (45)

Frozen Microwave Dinner

Choice of one meal:

• Glazed Chicken Dinner,

Lean Cuisine® (230)

2/3 C. skim milk (60)

Noncaloric beverage

• Lasagna with Meat Sauce,

Lean Cuisine® (240)

1/2 C. skim milk (45)

Noncaloric beverage

• Macaroni and Cheese,

Weight Watchers® (260)

1/2 C. skim milk (45)

Noncaloric beverage

• Broccoli & Cheddar Cheese Sauce

over Baked Potato, Lean Cuisine®

Lunch Express (250)

1/2 C. skim milk (45)

Noncaloric beverage

• Grilled Turkey Breast,

Healthy Choice® (260)

1/2 C. skim milk (45)

Noncaloric beverage

Men add:

2 slices whole wheat bread (140)

2 t. Promise Ultra® Veg Oil Spread (24)

1/2 C. skim milk (45)

Late-Night Snack

Men—200 calories for 1&2; 150 calories for Weeks 3&4; 100 calories for Weeks 5&6. Women—150 calories for Weeks 1&2; 100 calories for Weeks 3&4; 50 calories for Weeks 5&6.

Choose calories from afternoon snack

selections plus the following:

1/2 C. low-fat frozen yogurt (100)

2 C. light, microwave popcorn (100)

* Nutritionally equivalent products with similar calorie counts may be substituted if recommended products cannot be found.

THE EATING PLAN (METRIC MEASUREMENTS*)

Breakfast = 300 calories

Choice of bagel, cereal or shake.

Bagel

- 1 plain bagel (frozen) (210)
- 21 g light cream cheese (45)
- 120 ml orange juice, fresh or frozen (55)
- Any beverage without calories, caffeine, or sodium, such as decaffeinated coffee or tea.

Cereal

- 42 gram serving equals approximately 165 calories.
- Choice of one: Kellogg's® Low Fat Granola (without raisins), General Mills® Honey Nut Clusters, General Mills® Basic 4
- 120 ml skim milk (45)
- 177 ml orange juice (82)
- Noncaloric beverage

Shake (choice of one shake)

- Place ingredients in blender.
- Blend until smooth.
- Banana-Orange Shake
 - 1 large banana (22 cm long) (100)
 - 120 ml orange juice (55)
 - 120 ml skim milk (45)
 - 15 ml wheat germ (66)
 - 5 ml safflower oil (42)
 - 2 ice cubes (optional)

- or Chocolate or Vanilla Shake
 - 1 packet Carnation® Instant Breakfast, Champion UltraMet®, or another diet shake powder that contains the appropriate calories (100)
 - 240 ml skim milk (90)
 - 1/2 large banana (22 cm long) (50)
 - 5 ml safflower oil (42)
 - 5 ml Carnation® Malted Milk powder (20)
 - 2 ice cubes (optional)

Lunch = 300 calories.

Choice of sandwich, soup or salad.

Sandwich

- 2 slices whole wheat bread (140)
- 10 ml Promise Ultra® Vegetable Oil Spread (24)
- 57 g white meat (about 8 thin slices), chicken or turkey (80)
- 28 g fat-free cheese (1 1/2 slices) (50)
- (Opt.: Add to bread 5 ml Dijon mustard (0))
- Noncaloric beverage
- Soup (choice of one soup)

- Healthy Choice® Hearty Chicken, 420 g can (260), or
- Campbell's® Healthy Request Hearty Vegetable Beef, 450 g can (260)
- 1/2 slice whole-wheat bread (35)
- Noncaloric beverage
- Chef Salad
 - 480 ml lettuce, chopped (20)
 - 57 g white meat, chicken or turkey (80)
 - 57 g fat-free cheese (100)
 - 4 slices tomato, chopped (28)
 - 15 ml Italian, fat-free dressing (6)
 - 1 slice whole wheat bread (70)
 - Noncaloric beverage

Mid-Afternoon Snack

- Men—200 calories for Weeks 1&2; 150 calories for Weeks 3&4; 100 calories for Weeks 5&6.
- Women—150 calories for Weeks 1&2; 100 calories for Weeks 3&4; 50 calories for Weeks 5&6.
- Choose calories from:
 - 1 large banana (22 cm long) (100)
 - 1 apple (7.6 cm diameter) (100)
 - 1/2 cantaloupe (12.7 cm diameter) (94)
 - 5 dried prunes (100)
 - 28 g (2 small 14 g. boxes) raisins (82)
 - 240 ml light, nonfat, flavored yogurt (100)

Dinner

Men—500 calories, Women—300 calories

Choice of tuna salad dinner, steak dinner or frozen microwave dinner.

Tuna Salad Dinner

- In a large bowl, mix the following:
 - 1 can (170 g) chunk light tuna in water (180)
 - 15 ml Hellmann's® Light, Reduced-Calorie Mayonnaise (50)
 - 30 ml sweet pickle relish (40)
 - 60 ml whole kernel corn, canned, no salt added (30)
 - Noncaloric beverage
- Men add:
 - 120 ml sliced white potatoes, canned (45)
 - 2 slices whole wheat bread (140)
- Steak Dinner
 - 85 g lean sirloin, broiled (176)
 - 120 ml sweet peas, canned, no salt added (60)

- 120 ml beets, canned (35)
- 120 ml skim milk (45)
- Noncaloric beverage
- Men add:
 - 2 slices whole wheat bread (140)
 - 5 ml Promise Ultra® Veg Oil Spread (12)
 - 120 ml skim milk (45)
- Frozen Microwave Dinner
- Choose one meal:

- Glazed Chicken Dinner, Lean Cuisine® (230)
 - 160 ml skim milk (60)
 - Noncaloric beverage
- Lasagna with Meat Sauce, Lean Cuisine® (240)
 - 120 ml skim milk (45)
 - Noncaloric beverage
- Macaroni and Cheese, Weight Watchers® (260)
 - 120 ml skim milk (45)
 - Noncaloric beverage
- Broccoli & Cheddar Cheese Sauce over Baked Potato, Lean Cuisine® Lunch Express (250)
 - 120 ml skim milk (45)
 - Noncaloric beverage
- Grilled Turkey Breast, Healthy Choice® (260)
 - 120 ml skim milk (45)
 - Noncaloric beverage

Men add:

- 2 slices whole-wheat bread (140)
- 10 ml Promise Ultra® Veg Oil Spread (24)
- 120 ml skim milk (45)

Late-Night Snack

Men—200 calories for 1&2; 150 calories for Weeks 3&4; 100 calories for Weeks 5&6. Women—150 calories for Weeks 1&2; 100 calories for Weeks 3&4; 50 calories for Weeks 5&6.

Choose calories from afternoon snack selections plus the following:

- 120 ml low-fat frozen yogurt (100)
- 240 ml light, microwave popcorn (100)

* Nutritionally equivalent products with similar calorie counts may be substituted if recommended products cannot be found.



Q&A

Q. I often get headaches when I eat only 1000 calories a day. What should I do?

A. Your headaches may be caused by going longer than three hours between meals or snacks. Try spacing your meals and snacks where there are fewer hours between them.

Some people who are used to drinking regular coffee with caffeine notice headaches when they stop consuming coffee for several days. If this is the case with you, you might want to ease off the coffee more gradually.

Q. I don't like red meat. I notice that the Lean Cuisine® Lasagna with Meat Sauce contains beef. What can I substitute for it?

A. Lean Cuisine® has many other frozen dinners that you may substitute for Lasagna with Meat Sauce. Try to find one that contains the same calories, with approximately 15 to 20 percent of the calories coming from fat. Some of the Lean Cuisine® dinners actually have too little fat for my nutritional requirements.

Q. May I have dinner for lunch and lunch for dinner?

A. Yes.

Q. I tend to get a headache when I drink cold water. Can I drink water without it being chilled?

A. Yes, but you won't get the 123 calories or more thermogenic effect from warming the cold water to core body temperature. Try a more gradual drinking of the cold water. You may have been consuming it too quickly.

Q. Is it possible to drink too much water?

A. Certainly. To do so, however, you'd probably have to drink four or five times as much per day as I'm recommending. There are a few ailments that can be negatively affected by large amounts of fluid. If you feel you have a problem, check with your doctor before starting the program.

Q. Is bottled water better than tap water?

A. Research shows that bottled water is not always higher quality water than tap water. The decision to drink bottled water or not is usually one of taste. If you dislike the taste of your tap water, then drink your favorite bottled water. But first you might want to try a twist of lemon or lime added to the water from your tap. Some people say it makes a significant difference in the taste.

Q. I'm a middle-aged woman who gets black and blue marks on my legs when I diet. Am I doing anything wrong?

A. I doubt you are doing anything wrong. Such black and blue marks are usually the result of an increased level of estrogen circulating in your body, which weakens the walls of the capillaries and causes them to break under the slightest pressure. When this happens, blood escapes and a bruise occurs. Estrogen is broken down in the liver, and so is fat. When you are dieting, your liver breaks down the fat, leaving a lot more estrogen in the bloodstream.

It may be helpful to supplement your diet with a little extra vitamin C each day to help toughen the walls of the capillaries.

Q. I'm a 40 year-old woman with a teenage son and daughter. My husband and I both want to lose 10 pounds (4.5 kg) and the children would also like to lose some weight. Can I put the whole family on the program?

Q&A

A. It would be great if you could, but you cannot. The number of calories per day is the problem. Teenagers require significantly more calories each day than 1500, which is the highest level. Check with a registered dietician (RD) for appropriate recommendations. Your teenage son and daughter, however, could follow the Bowflex® exercise routines.

Q. I'm afraid that I might get large, unfeminine muscles from some of the Bowflex® exercises you recommend in this course. What can I do to prevent this from happening?

A. You are worrying about large muscles unnecessarily. Building large muscles requires two conditions. First, the individual must have long muscles and short tendons. Second, an abundance of testosterone must be present in the blood stream. Women almost never have either of these conditions.

Under no circumstances could 99.99 percent of American women develop excessively large muscles. Progressive resistance exercise such as using a Bowflex® home gym will make your muscles larger – but not excessively large – and larger muscles will make your body firmer and more shapely.

Q. Why is it so important I perform the Bowflex® exercises with a 4-second count on the lifting and lowering?

A. Because a slow, smooth 4-second lifting followed by a 4-second lowering involves more muscle fibers more thoroughly than faster speeds of movement. The more completely each involved muscle fiber works simply means you'll get better muscle-building results.

Q. I'm confused about how to breathe during each Bowflex® exercise?

A. Let's say your goal is to do 10 repetitions on a specific Bowflex® exercise that is performed in the recommended 4-second lifting and 4-second lowering style. Here are the proper breathing guidelines to follow:



- Breathe normally during the first five repetitions.
- Take shorter, more shallow breaths during the sixth, seventh, and eighth repetitions.
- Emphasize exhalation more than inhalation, especially during the ninth and tenth repetitions. Focus on good form and slow movement.
- Do not hold your breath on any repetition. Practice relaxing your face and neck. Do not grit your teeth. Keep your eyes open and remain alert.

Q. I'm not as disciplined and patient as I'd like to be. How can I better stay on track with the program?

A. One suggestion is to team up with a partner. Most people are more motivated and make better progress if they go through the program with a friend. In selecting a training partner, here are several things to keep in mind:

- Your partner should be similar to you in age and condition.
- Your partner should be serious about getting into shape and making a commitment. That commitment means you'll be exercising together one hour, three times per week. Each of your joint training sessions should take approximately 50 minutes: 25 minutes for your workout and 25 minutes supervising your partner's workout.
- Your partner should be someone with whom you'll share a spirit of cooperation, not competition.



Q&A

- Your partner should not be your spouse, brother, sister, or other family member. You do not want normal interpersonal problems to interfere with the training.

Q. Why won't you allow me to do aerobic dancing on my off-days to speed up the loss of body fat?

A. Because doing so doesn't speed up fat loss. Aerobic dancing – and other activities such as running, swimming, cycling, stair-stepping, and racquetball – do not contribute significantly to the fat-loss process. In fact, when added to proper strength training they can actually retard the reduction of fat.

Fat loss is retarded in two ways. Too much repetitive activity prevents maximum muscle building by using up your recover ability. A well-rested recover ability is necessary for muscle growth. Too much activity, especially if you are on a reduced-calorie diet, causes you to get the blahs and quickly lose your enthusiasm. If this happens, you're sure to break your diet.

The primary purpose of this program is to lose fat in the most effective and most efficient manner. Fat loss is prioritized and maximized by building muscle at the same time. The muscle-building process is optimized by a well-rested recovery ability, which necessitates keeping your strenuous and moderately strenuous activities to a bare minimum.

Once you get your body fat to a low level, you can add other activities – and I encourage you to do so – to your weekly fitness schedule. For now, follow the plan exactly as directed.

Q. What happens after six weeks? How do I continue the program if I need to lose more weight?

A. You should repeat the program for as long as it takes you to reach your goal. For example, it took Barry Ozer three six-week sessions (18 weeks) to lose all of his excessive fat, which amounted to 75 pounds (34 kg). There are, however, a few guidelines and modifications to apply.

Repeat the eating plan exactly as before: Men, go back to 1500 calories a day for two weeks. Women, go back to 1200 calories a day for two weeks. Then, descend your calories in the same manner.

Keep your superhydration schedule at the highest level. In other words, sip 1 5/8 gallons (6.2 l) of ice-cold water each day.

Continue your Bowflex® exercise routine at the highest level. Perform the same 10 exercises three times per week. Try to get as strong as you can in each exercise, while always focusing on the 4-second count in both lifting and lowering.

Q. I'm pleased that I lost the fat I wanted to lose. What do I do to maintain my new body weight?

A. Once you've lost your excessive fat, your next task is to maintain that status. Here are the adjustments you need to make to your current practices:

Adhere to a carbohydrate-rich, moderate-calorie eating plan

Instead of eating from 1000 to 1500 calories a day, you'll be consuming from 1600 to 2400 calories per day. Maybe you can eat even more after your new body weight has stabilized. Trial-and-error experimentation is a must. Women should start with 1600 calories, and men with 2000 calories per day. Note what happens after a week. If your body weight keeps going down, raise the calories by 100 or 200, depending on how much weight you lost during the last week. Soon, you should reach a level where your body weight stabilizes. That level is your daily calorie requirement. Naturally, you'll be able to consume other foods than those listed in the Bowflex® eating plan. By then, however, you should know the value of being a smart shopper

Q&A

and a wise eater. Read labels. Compare nutritional information. Be conscious of the ideal 60:20:20 ratio for carbohydrates, proteins, and fats.

Eat smaller meals more frequently.

You've been limiting your five meals per day to 300 calories if you're a woman, or 500 calories if you're a man. You may now up the calories by 100. What happens if during a single meal you eat more than 400 calories if you're a woman, or 600 calories if you're a man? Don't panic. Simply understand that you will sometimes backslide. Learn to anticipate these urges and take corrective action.

Drink at least 1 gallon (3.8 l) of cold water each day

You should realize by now the benefits of consuming plenty of water each day. Make your water bottle a permanent part of your lifestyle

Train on your Bowflex® home gym at least twice a week

There are two primary differences between maintenance and strength-building routines. First, for maintenance, you do not have to increase the resistance each week or so. If you can do 100 pounds for 12 repetitions on the leg extension, then keep it on 100 pounds and do not go up to 105 pounds. You can maintain the 100-pound level much easier than you can increase it. Second, you do not need to train three times a week. You can maintain your strength at twice a week.

Add variety to your Bowflex® routines

Now is the time to introduce more variety to your routines by adding some new exercises while removing some old ones. Following are two sample routines:



Maintenance Routine 1

1. Seated Hip Abduction
2. Seated Hip Adduction
3. Seated Straight Leg Calf Raise
4. Chest Fly
5. Incline Bench Press
6. Shoulder Pullover
7. Shoulder Shrug
8. Standing Biceps Curl
9. Seated Wrist Curl
10. Seated Wrist Extension

Maintenance Routine 2

1. Leg Curl
2. Leg Extension
3. Standing Lateral Shoulder Raise
4. Seated Shoulder Press
5. Rear Deltoid Row
6. Decline Press
7. Reverse Curl
8. Seated Triceps Extension
9. Low Back Extension
10. Abdominal Crunch

Look in your Bowflex® Owner's Manual for descriptions of the new exercises.

Be consistent with your Bowflex® home gym exercising, healthy eating, and superhydrating – and your accomplishments may well exceed your goals.

WORKOUT LOG

EXERCISE		DATE:	DATE:	DATE:	DATE:	DATE:	DATE:
<i>Bench Press</i>	Sets	<i>2</i>					
	Reps	<i>10, 9</i>					
	Resistance	<i>120, 150</i>					
	Sets						
	Reps						
	Resistance						
	Sets						
	Reps						
	Resistance						
	Sets						
	Reps						
	Resistance						
	Sets						
	Reps						
	Resistance						
	Sets						
	Reps						
	Resistance						
	Sets						
	Reps						
	Resistance						
	Sets						
	Reps						
	Resistance						
	Sets						
	Reps						
	Resistance						

100% Satisfaction Guarantee

We want you to know that your Power Rod® Home Gym machine is a superior product. Your satisfaction is guaranteed. If, for any reason, you are not 100% satisfied with your Power Rod® Home Gym machine, please follow the instructions below to return your merchandise and receive a refund of the purchase price, less shipping and handling.

This Power Rod® Home Gym Satisfaction Guarantee applies only to merchandise purchased by consumers directly from Nautilus, Inc. This guarantee does not apply to sales made by dealers or distributors.

1. Call a Power Rod® Home Gym Representative at 1-800-NAUTILUS (1-800-628-8458) for a Return Authorization Number (RMA). An RMA will be granted if:
 - a. The Bowflex® Power Rod® Home Gym exercise machine was purchased directly from Nautilus, Inc.
 - b. The request to return the product is within 6 weeks of the delivery date of your merchandise.
2. If an RMA is granted, the following instructions will prevent delays in the processing of your refund.
 - a. The merchandise must be returned to the address given to you at the time of the Return Authorization Call.
 - b. All returned merchandise must be properly packaged in good condition, preferably in the original boxes.
 - c. The exterior of the boxes should be marked clearly with:
 - Return Authorization Number
 - Your Name
 - Your Address
 - Your Phone Number
 - d. Additionally, a piece of paper with your name, address and phone number or copies of your original invoice should be placed in each box of merchandise.
 - e. Your RMA number is time sensitive. Your shipment must be post marked within two weeks from the date the Power Rod® Home Gym Representative issued the Return Authorization Number.

NOTE: You are responsible for return shipping and for any damage or loss to merchandise that occur during return shipment. Nautilus recommends that you obtain tracking numbers and insure your shipment.

Unauthorized Returns

Nautilus, Inc. defines an unauthorized return as any merchandise returned to our facilities without a valid and current Return Merchandise Authorization (RMA) number issued by Nautilus. Failure to properly mark packages with a valid RMA number, or allowing an RMA number to expire, will cause Nautilus, Inc. to consider a return unauthorized. Any merchandise returned without a RMA number will not be subject to a refund or credit and Nautilus will discard the product. The customer assumes all shipping and handling charges for any unauthorized return.

Contacts

UNITED STATES

TECHNICAL/CUSTOMER SERVICE

Tel: (800) NAUTILUS, (800-628-8458)

Fax: (877) 686-6466

E-mail: Bowflex@nautilus.com

CORPORATE HEADQUARTERS

Nautilus, Inc.

World Headquarters

16400 SE Nautilus Drive

Vancouver, Washington, USA 98683

Phone: (800) NAUTILUS (800) 628-8458

INTERNATIONAL

INTERNATIONAL CUSTOMER SERVICE

Nautilus International S.A.

Rue Jean Prouvé

1762 Givisiez / Switzerland

Tel: + 41 26 460 77 77

Fax: + 41 26 460 77 70

E-mail: technics@nautilus.com

GERMANY and AUSTRIA

Nautilus International GmbH

Albin-Köbis-Str. 4

51147 Köln

Tel: + 49 02203 2020 0

Fax: + 49 02203 2020 45 45

ITALY

Nautilus Italy S.r.l., Via della Mercanzia, 103

40050 Funo di Argelato - Bologna

Tel: + 39 051 664 6201

Fax: + 39 051 664 7461

SWITZERLAND

Nautilus Switzerland SA

Rue Jean-Prouvé 6

CH-1762 Givisiez

Tel: + 41 26 460 77 66

Fax: + 41 26 460 77 60

UNITED KINGDOM

Nautilus UK Ltd

4 Vincent Avenue

Crownhill, Milton Keynes, Bucks,

MK8 0AB

Tel: + 44 1908 267 345

Fax: + 44 1908 267 345

CHINA

Nautilus (Shanghai) Fitness Co., Ltd.

7A No.728, Yan'an Road (West)

200050 Shanghai, China

Tel: + 86 21 523 707 00

Fax: + 86 21 523 707 09

Serial Number
Date of Purchase



Printed in China

©2008. Nautilus, Inc. All rights reserved. Nautilus, the Nautilus Logo, Universal, the Universal Logo, Bowflex, StairMaster, Power Rod and Nautilus Institute are either registered trademarks or trademarks in the USA of Nautilus, Inc. Schwinn is a registered trademark. All other trademarks are owned by their respective companies. Nautilus, Inc., World Headquarters, 16400 SE Nautilus Drive, Vancouver, WA 98683 1-800-NAUTILUS www.nautilus.com

Nautilus® Bowflex® Schwinn® Fitness StairMaster® Universal® Nautilus Institute®