

# USER'S GUIDE

## BOXLIGHT CP-11t



## INFORMATION TO THE USER

NOTE : This equipment has been tested and found to comply with the limits for a Class A digital device, pursuant to Part 15 of FCC Rules. These limits are designed to provide reasonable protection against harmful interference when the equipment is operated in a commercial environment. This equipment generates, uses and can radiate radio frequency energy, and if not installed and used in accordance with the instruction manual, may cause harmful interference to radio communications. Operation of this equipment in a residential area is likely to cause harmful interference in which case the user will be required to correct the interference at his own expense.

## TO THE OWNER

As the owner of a new Boxlight CP-11t, you are probably eager to try out your new projector. Before you do, we suggest that you spend a little time reading this manual to familiarize yourself with the operating procedures so that you will receive maximum satisfaction from the many features included in your new projector. This owner's manual will acquaint you with your projector's features. Reading it will help us too. You can often correct operating problems yourself. If your projector fails to work properly, see "TROUBLESHOOTING" section on pages 35 ~ 36 and try the solution marked for each problem.

## SAFETY PRECAUTIONS

### WARNING:

**TO REDUCE THE RISK OF FIRE OR ELECTRIC SHOCK, DO NOT EXPOSE THIS APPLIANCE TO RAIN OR MOISTURE.**

This Boxlight CP-11t has a grounding-type AC line plug. This is a safety feature to be sure that the plug will fit into the power outlet. Do not try to defeat this safety feature.

This projector produces intense light from the projection lens. Do not stare directly into the lens as possible eye damage could result. Be especially careful that children do not stare directly into the beam.

The Remote Control Unit, supplied to this projector, emits the laser beam as the Laser Pointer function from the Laser Light Window while pressing the LASER button (for 1 minute). Do not look into the Laser Light Window or shine the laser beam on yourself or other people. Eye damage may result.

This projector should be set in the way indicated. If not, it may result in fire hazard.

If the projector will not be used for an extended time, unplug the projector from the power outlet.

**READ AND KEEP THIS OWNER'S MANUAL FOR LATER USE.**



**CAUTION**  
**RISK OF ELECTRIC SHOCK**  
**DO NOT OPEN**



**CAUTION : TO REDUCE THE RISK OF ELECTRIC SHOCK, DO NOT REMOVE COVER (OR BACK). NO USER-SERVICEABLE PARTS INSIDE EXCEPT LAMP REPLACEMENT. REFER SERVICING TO QUALIFIED SERVICE PERSONNEL.**



THIS SYMBOL INDICATES THAT DANGEROUS VOLTAGE CONSTITUTING A RISK OF ELECTRIC SHOCK IS PRESENT WITHIN THIS UNIT.



THIS SYMBOL INDICATES THAT THERE ARE IMPORTANT OPERATING AND MAINTENANCE INSTRUCTIONS IN THE OWNER'S MANUAL WITH THIS UNIT.

# IMPORTANT SAFETY INSTRUCTIONS

All the safety and operating instructions should be read before the product is operated.

Read all of the instructions given here and retain them for later use. Unplug this projector from AC power supply before cleaning. Do not use liquid or aerosol cleaners. Use a damp cloth for cleaning.

Do not use attachments not recommended by the manufacturer as they may cause hazards.

Do not place this projector on an unstable cart, stand, or table. The projector may fall, causing serious injury to a child or adult, and serious damage to the projector. Use only with a cart or stand recommended by the manufacturer, or sold with the projector. Wall or shelf mounting should follow the manufacturer's instructions, and should use a mounting kit approved by the manufacturers.

Do not expose this unit to rain or use near water... for example, in a wet basement, near a swimming pool, etc...

Slots and openings in the back and bottom of the cabinet are provided for ventilation, to insure reliable operation of the equipment and to protect it from overheating.

The openings should never be covered with cloth or other materials, and the bottom opening should not be blocked by placing the projector on a bed, sofa, rug, or other similar surface. This projector should never be placed near or over a radiator or heat register.

This projector should not be placed in a built-in installation such as a book case unless proper ventilation is provided.

This projector should be operated only from the type of power source indicated on the marking label. If you are not sure of the type of power supplied, consult your authorized dealer or local power company.

Do not overload wall outlets and extension cords as this can result in fire or electric shock. Do not allow anything to rest on the power cord. Do not locate this projector where the cord may be damaged by persons walking on it.

Never push objects of any kind into this projector through cabinet slots as they may touch dangerous voltage points or short out parts that could result in a fire or electric shock. Never spill liquid of any kind on the projector.

Do not attempt to service this projector yourself as opening or removing covers may expose you to dangerous voltage or other hazards. Refer all servicing to qualified service personnel.

Unplug this projector from wall outlet and refer servicing to qualified service personnel under the following conditions:

- When the power cord or plug is damaged or frayed.
- If liquid has been spilled into the projector.
- If the projector has been exposed to rain or water.

- If the projector does not operate normally by following the operating instructions. Adjust only those controls that are covered by the operating instructions as improper adjustment of other controls may result in damage and will often require extensive work by a qualified technician to restore the projector to normal operation.
- If the projector has been dropped or the cabinet has been damaged.
- When the projector exhibits a distinct change in performance-this indicates a need for service.

When replacement parts are required, be sure the service technician has used replacement parts specified by the manufacturer that have the same characteristics as the original part. Unauthorized substitutions may result in fire, electric shock, or injury to persons.

Upon completion of any service or repairs to this projector, ask the service technician to perform routine safety checks to determine that the projector is in safe operating condition.

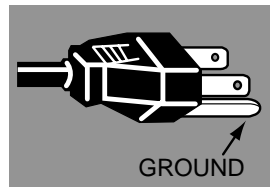

This projector is equipped with a grounding type AC line plug. Should you be unable to insert the plug into the outlet, contact your electrician. Do not defeat the safety purpose of this grounding type plug.

Follow all warnings and instructions marked on the projectors.

For added protection to the projector during a lightning storm, or when it is left unattended and unused for long periods of time, unplug it from the wall outlet. This will prevent damage due to lightning and power line surges.



An appliance and cart combination should be moved with care. Quick stops, excessive force, and uneven surfaces may cause the appliance and cart combination to overturn.

If the projector is to be built into a compartment or similarly enclosed, the minimum distances must be maintained. Do not cover the ventilation slot on the projector. Heat build-up can reduce the service life of your projector, and can also be dangerous.

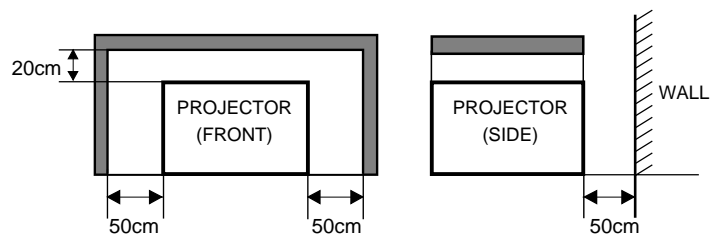

# TABLE OF CONTENTS

|                                       |           |                                      |           |
|---------------------------------------|-----------|--------------------------------------|-----------|
| <b>FEATURES AND DESIGN</b>            | <b>5</b>  | <b>COMPUTER MODE</b>                 | <b>22</b> |
| <b>PREPARATION</b>                    | <b>6</b>  | SELECTING COMPUTER MODE              | 22        |
| NAME OF EACH PART OF THE PROJECTOR    | 6         | SELECTING COMPUTER SYSTEM            | 22        |
| SETTING-UP THE PROJECTOR              | 7         | AUTOMATIC MULTISCANNING SYSTEM       | 22        |
| POSITIONING THE PROJECTOR             | 7         | COMPATIBLE COMPUTER SPECIFICATIONS   | 23        |
| ADJUSTABLE FEET                       | 7         | PC ADJUSTMENT                        | 24        |
| CONNECTING THE AC POWER CORD          | 8         | PICTURE IMAGE ADJUSTMENT             | 26        |
| VENTILATION                           | 8         | ADJUST PICTURE IMAGE MANUALLY        | 26        |
| MOVING THE PROJECTOR                  | 9         | NORMAL FUNCTION                      | 26        |
|                                       |           | AUTO IMAGE FUNCTION                  | 27        |
|                                       |           | PICTURE POSITION ADJUSTMENT          | 27        |
|                                       |           | PICTURE SCREEN ADJUSTMENT            | 28        |
| <b>CONNECTING THE PROJECTOR</b>       | <b>10</b> | <b>VIDEO MODE</b>                    | <b>29</b> |
| TERMINALS OF THE PROJECTOR            | 10        | SELECTING VIDEO MODE                 | 29        |
| CONNECTING TO THE VIDEO EQUIPMENT     | 11        | SELECTING COLOR SYSTEM               | 29        |
| CONNECTING TO THE COMPUTER            | 12        | PICTURE SCREEN ADJUSTMENT            | 29        |
|                                       |           | PICTURE IMAGE ADJUSTMENT             | 30        |
|                                       |           | ADJUSTING THE PICTURE IMAGE MANUALLY | 30        |
|                                       |           | NORMAL FUNCTION                      | 30        |
| <b>BEFORE OPERATION</b>               | <b>14</b> | <b>SETTING</b>                       | <b>31</b> |
| OPERATION OF THE REMOTE CONTROL       | 14        | SETTING MENU                         | 31        |
| LASER POINTER FUNCTION                | 14        | SETTING LANGUAGE                     | 31        |
| REMOTE CONTROL BATTERIES INSTALLATION | 15        |                                      |           |
| TOP CONTROLS AND INDICATORS           | 16        | <b>APPENDIX</b>                      | <b>32</b> |
| OPERATING ON-SCREEN MENU              | 17        | OPERATING WIRELESS MOUSE             | 32        |
| HOW TO OPERATE THE ON-SCREEN MENU     | 17        | MAINTENANCE                          | 33        |
| FLOW OF ON-SCREEN MENU                | 17        | TEMPERATURE WARNING INDICATOR        | 33        |
| MENU BAR                              | 18        | AIR FILTER CARE AND CLEANING         | 33        |
|                                       |           | CLEANING THE PROJECTION LENS         | 33        |
|                                       |           | LAMP REPLACEMENT                     | 34        |
|                                       |           | LAMP REPLACEMENT MONITOR TIMER       | 34        |
|                                       |           | TROUBLESHOOTING                      | 35        |
|                                       |           | TECHNICAL SPECIFICATIONS             | 37        |
| <b>BASIC OPERATION</b>                | <b>19</b> |                                      |           |
| TURNING ON / OFF THE PROJECTOR        | 19        |                                      |           |
| ADJUSTING THE IMAGE                   | 20        |                                      |           |
| ZOOM ADJUSTMENT                       | 20        |                                      |           |
| FOCUS ADJUSTMENT                      | 20        |                                      |           |
| KEYSTONE ADJUSTMENT                   | 20        |                                      |           |
| NO SHOW FUNCTION                      | 21        |                                      |           |
| PICTURE FREEZE FUNCTION               | 21        |                                      |           |
| SOUND ADJUSTMENT                      | 21        |                                      |           |
| SOUND VOLUME ADJUSTMENT               | 21        |                                      |           |
| SOUND MUTE ADJUSTMENT                 | 21        |                                      |           |

## TRADEMARKS

- Apple, Macintosh, and PowerBook are trademarks or registered trademarks of Apple Computer, Inc.
- IBM and PS/2 are trademarks or registered trademarks of International Business Machines, Inc.
- Windows and PowerPoint are registered trademarks of Microsoft Corporation.
- Each name of corporations or products in the owner's manual is a trademark or a registered trademark of its respective corporation.

# FEATURES AND DESIGN

---

This Multimedia Projector is designed with the most advanced technology for portability, durability, and ease of use. The projector utilizes built-in multimedia features, a palette of 16.77 million colors, and matrix liquid crystal display (LCD) technology.

## ◆ **Compatibility**

---

This projector is compatible with many different types of personal computers and video devices, including;

- IBM-compatible computers, including laptops, up to 1024 x 768 resolution.
- Apple Macintosh and PowerBook computers up to 1024 x 768 resolution.
- Various video equipment using any of the world wide video standards, including NTSC, NTSC4.43, SECAM, PAL, PAL-M and PAL-N.

## ◆ **Image Resolution**

---

Picture Image of the computer is projected in the resolution of 800 x 600 and it is provided just as appearing on your computer's monitor. Screen resolutions between 800 x 600 and 1024 x 768 are compressed to 800 x 600, and this projector cannot display screen resolutions above 1024 x 768. If your computer's screen resolution is higher than 1024 x 768, reset it to a lower resolution before you connect the projector.

## ◆ **Portability**

---

This projector is quite compact in size and weight. Having a sophisticated shape like an attaché case with a retractable carrying handle, the projector will help you make powerful presentations wherever you go.

## ◆ **Automatic Multiscanning System**

---

This projector automatically tunes to most personal computers currently distributed by simply connecting. It is free from complicated adjustments to project picture images from most Personal Computers.

## ◆ **Multilanguage Menu Display**

---

Operation menu is displayed in; English, Deutsch, Français, Italiano, Español, or Japanese.

## ◆ **Laser Pointer Function**

---

The Remote Control Unit of this projector includes the Laser Pointer function providing convenience for your presentations.

## ◆ **Other Features**

---

This projector has Motor Zoom/Focus, No Show, Picture Freeze, Keystone, Mute functions, and the Air Pad Remote Control.

## ◆ **Accessories**

---

This projector comes with the parts listed below. Check to make sure all are included. If any parts are missing, contact Boxlight immediately.

- Owner's Manual.
- AC Power Cord.
- Wireless Remote Control Unit.
- Batteries for Remote Control Unit.
- VGA Cable.
- Control Cable for PS/2 Port.
- Lens Cover.
- Dust Cover

# PREPARATION

## NAME OF EACH PART OF THE PROJECTOR

### FRONT OF THE CABINET

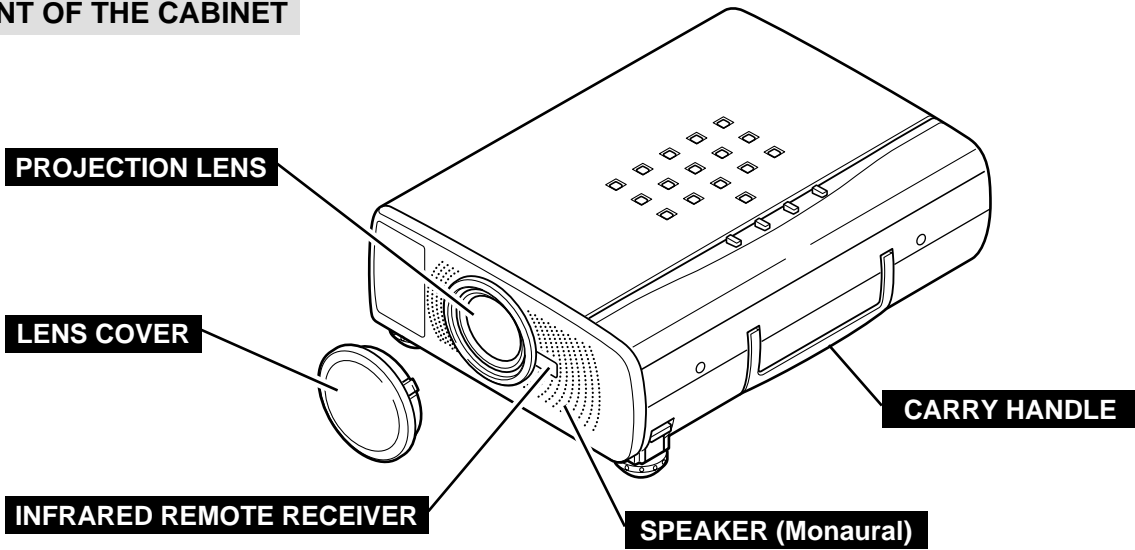

### BACK OF THE CABINET

#### EXHAUST VENT



#### HOT AIR EXHAUSTED !

Air blown from the exhaust vent is hot. When using or installing the projector, following attention should be taken.

- Do not put a flammable object near this vent.
- Keep heat-sensitive objects away from the exhaust vent.
- Do not touch this area especially screws and metallic parts. This area will become hot while the projector is used.

#### POWER CORD CONNECTOR

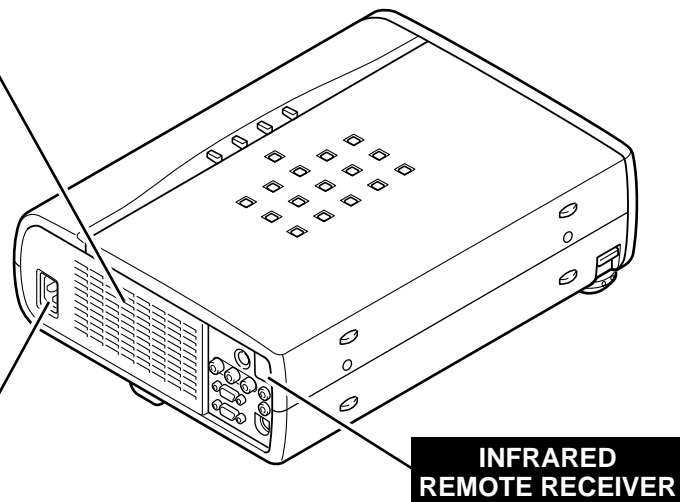

### BOTTOM OF THE CABINET

#### AIR INTAKE VENTS

These Air Intake Vents should not be blocked.

#### LAMP COVER

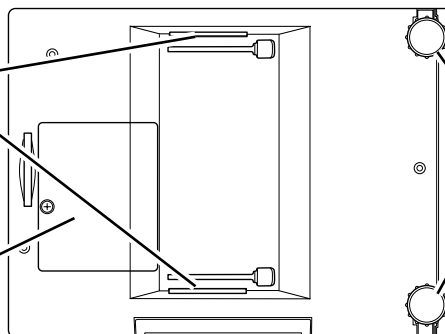

#### ADJUSTABLE FEET AND FEET LOCK LATCHES

# SETTING-UP THE PROJECTOR

## POSITIONING THE PROJECTOR

- This projector is designed to project on a flat projection surface.
- The projector can be focused from 4.6'(1.4m) ~ 35.4'(10.8m).
- Refer to the figure below to adjust the screen size.

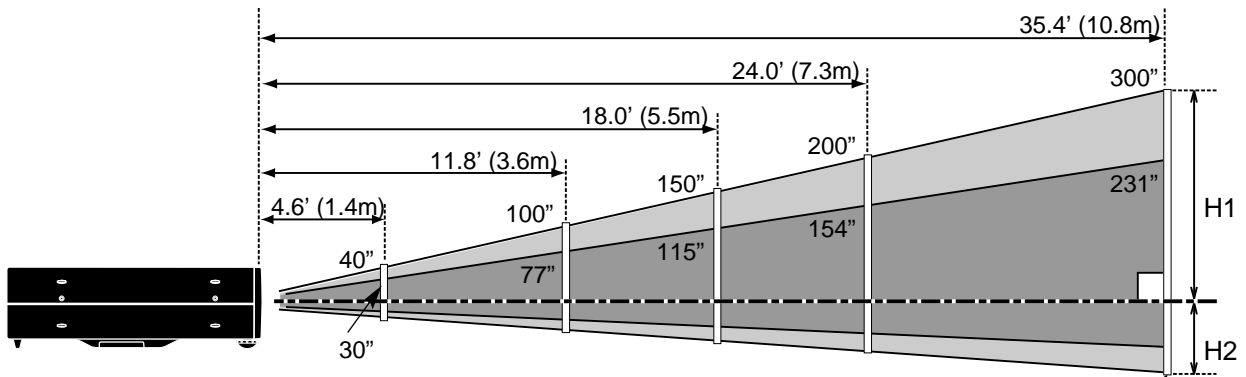

| Screen Size (W x H) mm | 30"          | 60"          | 100"          | 150"          | 200"           | 300"           |
|------------------------|--------------|--------------|---------------|---------------|----------------|----------------|
| Height (H1)            | 17.1"(435mm) | 34.3"(870mm) | 57.1"(1451mm) | 85.7"(2177mm) | 114.3"(2903mm) | 171.4"(4354mm) |
| Height (H2)            | 0.9"(22mm)   | 1.7"(44mm)   | 2.9"(73mm)    | 4.3"(109mm)   | 5.7"(145mm)    | 8.6"(218mm)    |

## ROOM LIGHT

The brightness in the room has a great influence on the picture quality. It is recommended to limit ambient lighting in order to provide the best image.

## ADJUSTABLE FEET

Picture tilt and projection angle can be adjusted by rotating the ADJUSTABLE FEET. Projection angle can be adjusted to 10 degrees.

- 1** Lift the front of the projector and pull the FEET LOCK LATCHES on both sides of the projector.
- 2** Release the FEET LOCK LATCHES to lock the ADJUSTABLE FEET and rotate the ADJUSTABLE FEET to fine tune the position and the tilt.
- 3** To shorten the ADJUSTABLE FEET, lift the front of the projector and pull and undo the FEET LOCK LATCHES.

The position and the keystone distortion of the image can also be adjusted using the Menu Operation. (Refer to P 20, 28 and 29.)

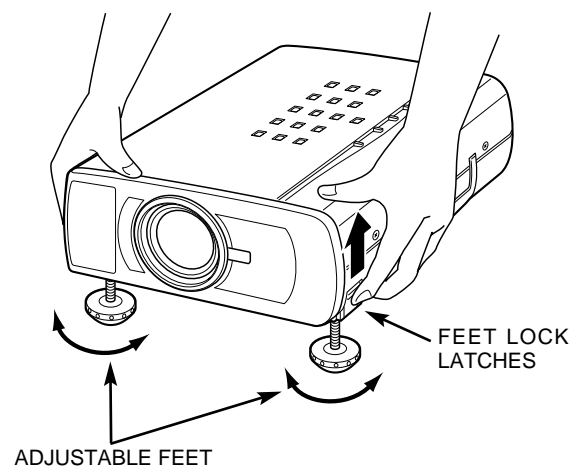

## CONNECTING THE AC POWER CORD

This projector uses nominal input voltages of 100-120 V AC or 200-240 V AC. The projector automatically selects the correct input voltage. It is designed to work with single-phase power systems having a grounded neutral conductor. To reduce the risk of electrical shock, do not plug into any other type of power system. Consult your authorized dealer or service station if you are not sure of the type of power supply being in use. Connect the projector with the peripheral equipment before turning the projector on. (Refer to pages 10 ~ 13 for connection.)



### CAUTION

For safety, unplug the AC Power Cord when the appliance is not in use. When this projector is connected to the outlet with the AC Power Cord, the appliance is in Stand-by Mode and consumes some electric power.

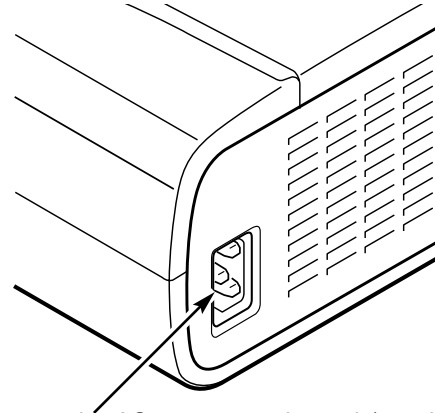

Connect the AC power supply cord (supplied) to the projector.

The socket-outlet must be near this equipment and must be easily accessible.

Projector side (Female)

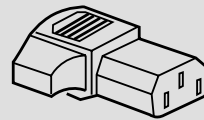

AC outlet side (Male)

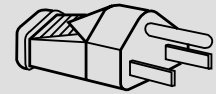

## VENTILATION

This projector is equipped with cooling fans for protection from overheating. Pay attention to the following to ensure proper ventilation and avoid a possible risk of fire and malfunction.

- Do not cover the vent slot.
- Keep the rear grill at least 3'(1m) away from any object.
- Keep sides clear of any obstructions. Obstructions may block cooling air.

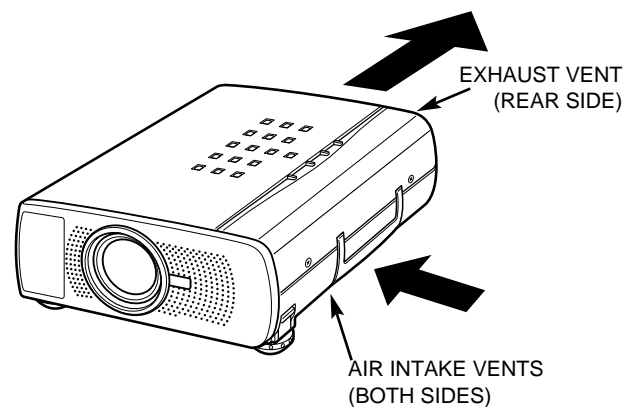



## MOVING THE PROJECTOR

Use the Carry Handle when moving the Projector.  
When moving the projector, replace the lens cover and retract feet to prevent damage to the lens and cabinet.

When this projector is not in use for an extended period, replace the lens cover, retract the Adjustable Feet and apply the dust cover supplied with this projector.

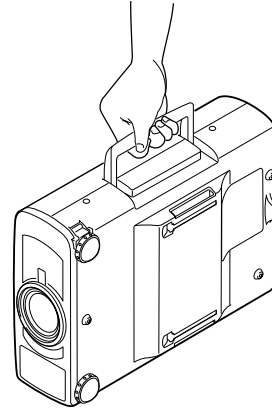

### CAUTION WHEN CARRYING OR TRANSPORTING THE PROJECTOR

- Do not drop or bump the projector, otherwise damages or malfunctions may result.
- When transporting the projector, use a carrying case recommended by Boxlight.
- Do not transport the projector by using a courier or transport service in an unsuitable transport case. This may cause damage to the projector. To transport the projector through a courier or transport service, use a case recommended by Boxlight.
- For carrying or transportation cases, contact a Boxlight at 1-800-762-5757 or 360-779-7901.

# CONNECTING THE PROJECTOR

## TERMINALS OF THE PROJECTOR

### S-VIDEO INPUT JACK

Connect the S-VIDEO output from the video equipment to this terminal.  
(Refer to P11.)

### AUDIO INPUT JACKS

Connect the audio outputs from the video equipment to these terminals.  
(Refer to P11.)

- When the audio output is monaural, connect it to the Left jack.

### COMPUTER INPUT TERMINAL

Connect the computer output to this terminal.  
(Refer to P12, 13.)

### MONITOR OUTPUT TERMINAL

This terminal outputs the signal from the COMPUTER IN terminal. Connect an external monitor to this terminal.  
(Refer to P12, 13.)

### VIDEO INPUT JACK

Connect the video output from the video equipment to this terminal.  
(Refer to P11.)

### COMPUTER AUDIO INPUT JACK

Connect the audio output from the computer to this terminal.  
(Refer to P12, 13.)

### AUDIO OUTPUT JACK (STEREO)

Connect the audio amplifier to this terminal.  
(Refer to P11, 12, 13.)

### CONTROL PORT CONNECTOR

When controlling the computer with the Remote Control of this projector, connect the mouse port of your personal computer to this terminal.  
(Refer to P12, 13.)

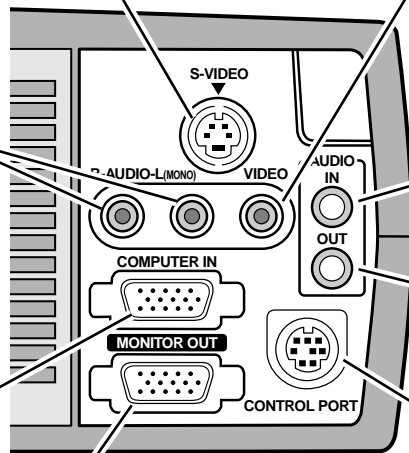

### COMPUTER INPUT / MONITOR OUTPUT TERMINAL

#### Terminal : HDB15-PIN

Connect the display output terminal of the computer to COMPUTER INPUT terminal of this projector with the VGA Cable (supplied). And connect the monitor to MONITOR OUTPUT with the monitor cable (not supplied). When connecting the Macintosh computer, the MAC Adapter (not supplied) is required.

#### Pin Configuration

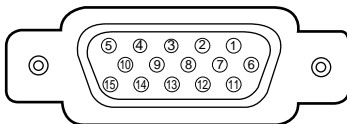

|   |                      |    |                     |
|---|----------------------|----|---------------------|
| 1 | Red Input            | 9  | Non Connect         |
| 2 | Green Input          | 10 | Ground (Vert.sync.) |
| 3 | Blue Input           | 11 | Sense 0             |
| 4 | Sense 2              | 12 | Sense 1             |
| 5 | Ground (Horiz.sync.) | 13 | Horiz. sync.        |
| 6 | Ground (Red)         | 14 | Vert. sync.         |
| 7 | Ground (Green)       | 15 | Reserved            |
| 8 | Ground (Blue)        |    |                     |

### CONTROL PORT CONNECTOR

#### Terminal : DIN 8-PIN

Connect control port (PS/2, Serial or ADB port) on your computer to this terminal with the Control Cable (the Control Cable for PS/2 port is supplied).

#### Pin Configuration

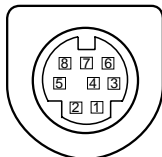

|   | PS/2 | Serial | ADB  |
|---|------|--------|------|
| 1 | ---- | R X D  | ---- |
| 2 | CLK  | ----   | ADB  |
| 3 | DATA | ----   | ---- |
| 4 | GND  | GND    | GND  |
| 5 | ---- | RTS    | ---- |
| 6 | ---- | T X D  | ---- |
| 7 | GND  | GND    | ---- |
| 8 | ---- | GND    | GND  |

# CONNECTING TO THE VIDEO EQUIPMENT



**Used cables for connection**

- VIDEO CABLE \*
- S-VIDEO CABLE \*
- AUDIO CABLE (stereo) \*

\* These cables are not supplied with this projector.

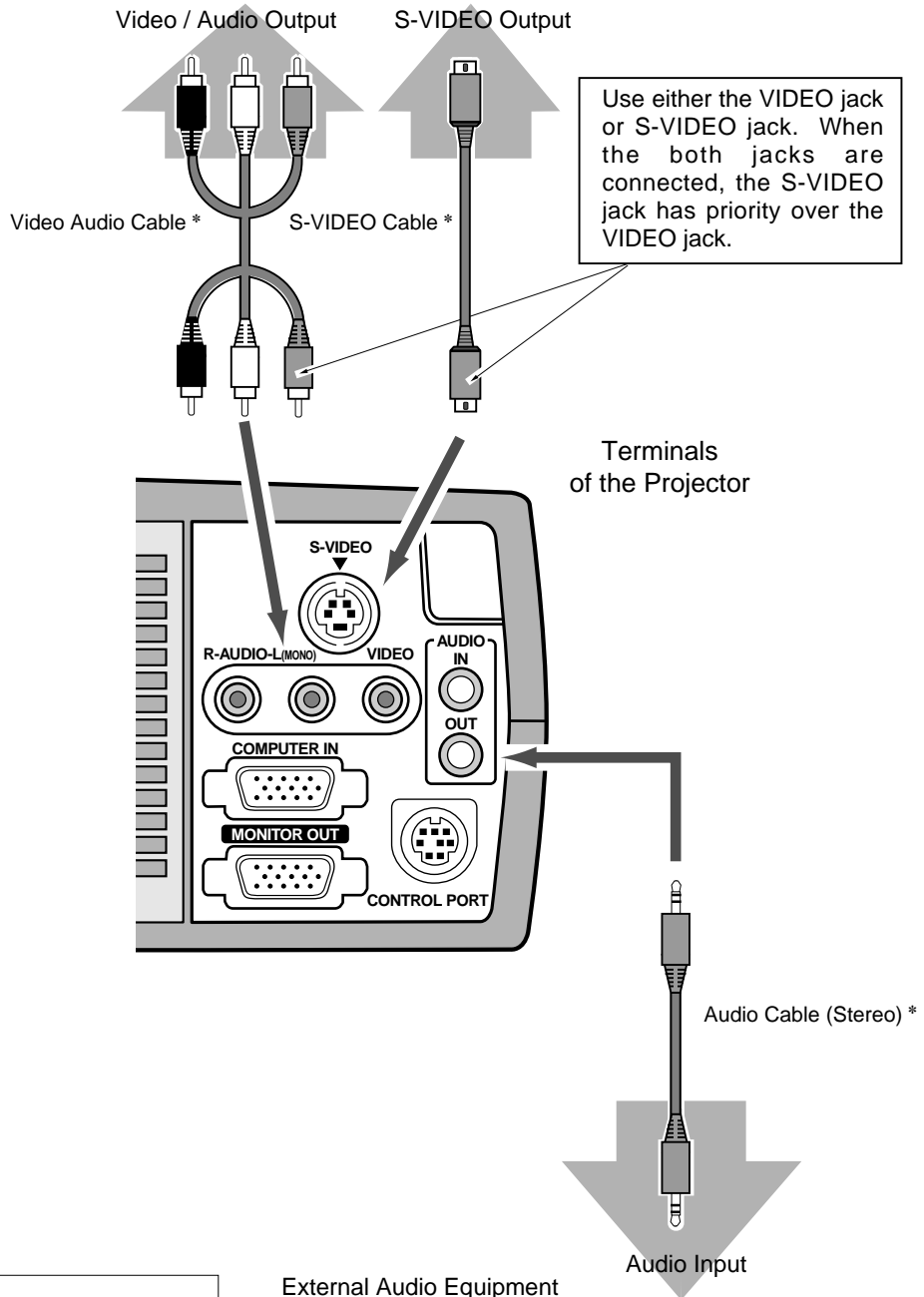

**NOTE :**  
 When connecting the cable, the power cords of both the projector and the external equipment should be disconnected from AC outlet. Turn the projector and peripheral equipment on before the computer is switched on.

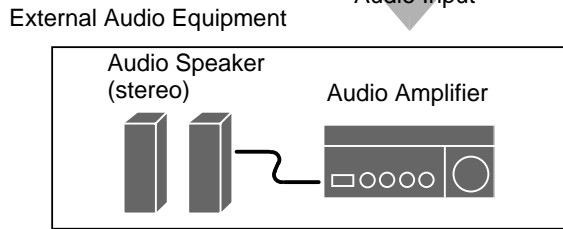

## CONNECTING TO THE COMPUTER

To connect to the computer, refer to the figure below.

### Used cables for connection

- VGA CABLE
- CONTROL CABLE FOR PS/2 PORT
- CONTROL CABLE FOR SERIAL PORT, or ADB PORT \*
- MAC ADAPTER \*
- MONITOR CABLE \*
- PC AUDIO CABLE (stereo) \*

\* These cables are not supplied with this projector.

IBM-compatible computers or Macintosh computers (VGA / SVGA / XGA)

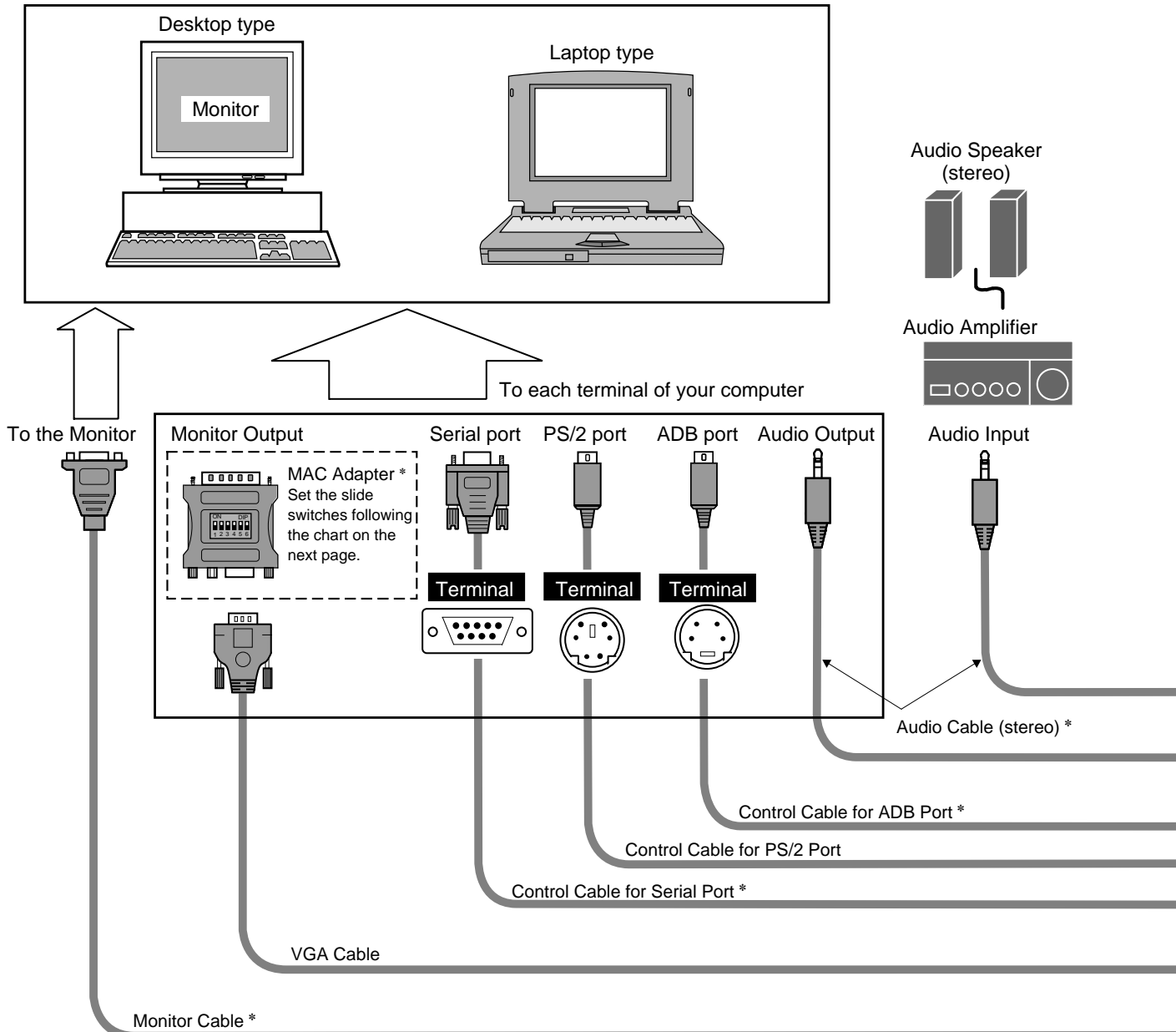

#### NOTE :

When connecting the cable, the power cords of both the projector and the external equipment should be disconnected from AC outlet. Turn the projector and peripheral equipment on before the computer is switched on.

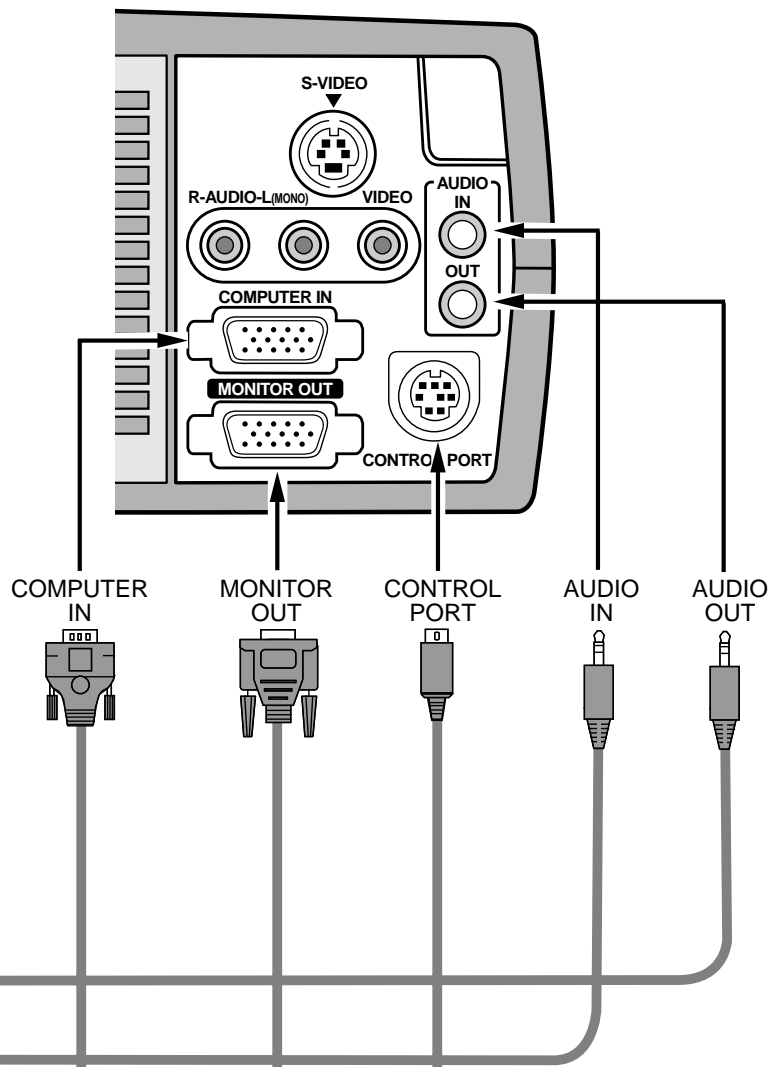

Use one of these Control Cables corresponding with the terminal of your computer.

### ◆ MAC ADAPTER (Not supplied)

Set the switches as shown in the table below depending on the RESOLUTION MODE that you want to use before your turn on the projector and computer.

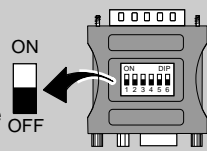

|                       | 1   | 2  | 3   | 4   | 5   | 6   |
|-----------------------|-----|----|-----|-----|-----|-----|
| 13" MODE (640 x 480)  | ON  | ON | OFF | OFF | OFF | OFF |
| 16" MODE (832 x 624)  | OFF | ON | OFF | ON  | OFF | OFF |
| 19" MODE (1024 x 768) | OFF | ON | ON  | OFF | OFF | OFF |

# BEFORE OPERATION

## OPERATION OF THE REMOTE CONTROL

### Left Side

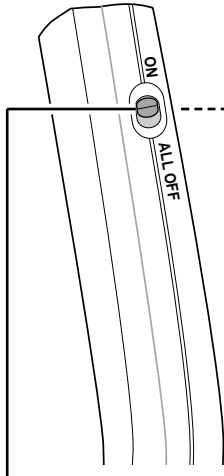

#### ALL-OFF SWITCH

When using the Remote Control Unit, turn this switch to "ON" and turn it "ALL OFF" when it is not used.

#### COMPUTER BUTTON

Used to select COMPUTER output source. (P22)

#### MENU BUTTON

Used to select MENU operation. (P17, 18)

#### SELECT BUTTON

Used to execute the item selected or to expand the image in DIGITAL ZOOM mode. (P28)  
It is also used as a PC mouse in Wireless Mouse Operation. (P32)

#### LASER BUTTON

Used to operate the laser pointer function. The laser beam is emitted while pressing this button within 1 minute. When using the laser pointer for more than 1 minute, release the button and press it again.

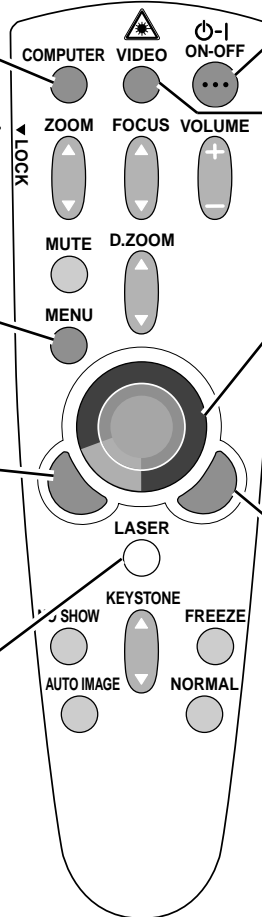

#### POWER ON-OFF BUTTON

Used to turn the projector on or off. (P19)

#### VIDEO BUTTON

Used to select VIDEO source. (P29)

#### POINT BUTTON

Used to move the pointer on the MENU, to adjust the item, or to pan the image in DIGITAL ZOOM mode. (P28)  
It is also used as a PC mouse in Wireless Mouse Operation. (P32)  
\* When pressing the center of this button, it works as the SELECT button.

#### RIGHT CLICK BUTTON

Used to compress the image in DIGITAL ZOOM mode. (P28)  
It is also used as a PC mouse in Wireless Mouse Operation. (P32)

## Laser Pointer Function

This remote control emits a laser beam as the Laser Pointer from the Laser Light Window. When the LASER button is pressed, the laser light goes on. And when the button is pressed more than 1 minute or the button is released, light goes off. Laser light is emitted with the RED light which tells the laser beam being emitted.

The laser emitted is a class II laser; therefore, do not look into the Laser Light Window or shine the laser beam on yourself or other people. The three marks bellow are the caution labels for the laser beam.

**CAUTION :** Use of controls or adjustments or performance of procedures other than those specified herein may result in hazardous radiation exposure.

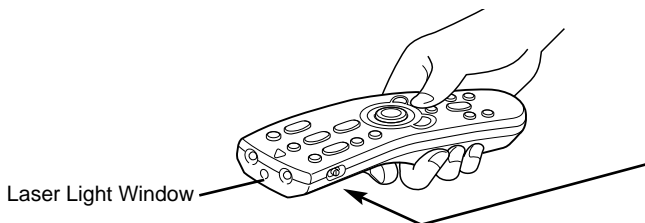

These caution labels are put on the remote control.

|   |  |
|---|--|
| <p><b>CAUTION</b></p> <p>LASER RADIATION-<br/>DO NOT STARE INTO BEAM</p> <p>MAX OUTPUT : 1mW<br/>WAVE LENGTH : 650±20nm<br/>CLASS II LASER PRODUCT</p> <p>This product is complied with 21 CFR<br/>part 1040.10</p> | <p>LASER RADIATION<br/>DO NOT STARE INTO BEAM<br/>CLASS 2 LASER PRODUCT<br/>LASER-STRAHLUNG<br/>NICHT IN DEN STRAHL BLICKEN<br/>LASER KLASSE 2<br/>レーザ放射 クラス2 レーザ製品<br/>ビームをのぞき込まないこと<br/>EC0025-1, Am1 1987<br/>MAX OUTPUT (最大出力) : 1mW<br/>WAVE LENGTH (波長) : 650±20nm</p> |
|---|--|



AVOID EXPOSURE-LASER  
RADIATION IS EMITTED  
FROM THIS APERTURE  
レーザー光の出口  
ビームをのぞき込まないこと

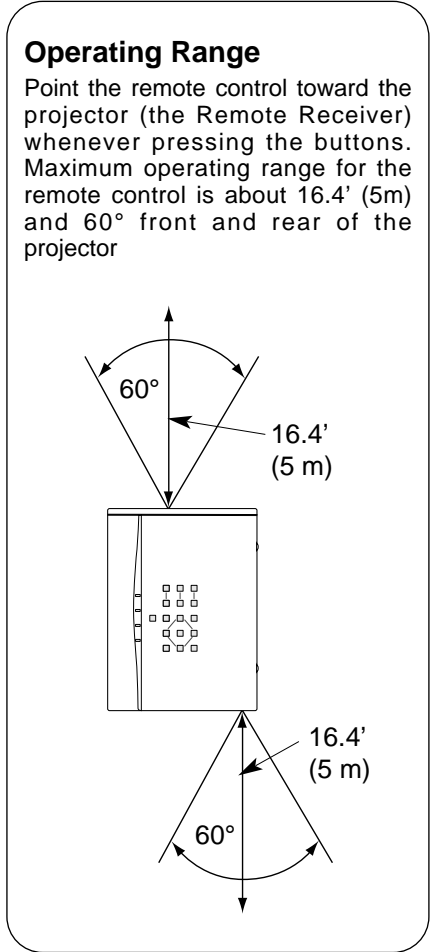
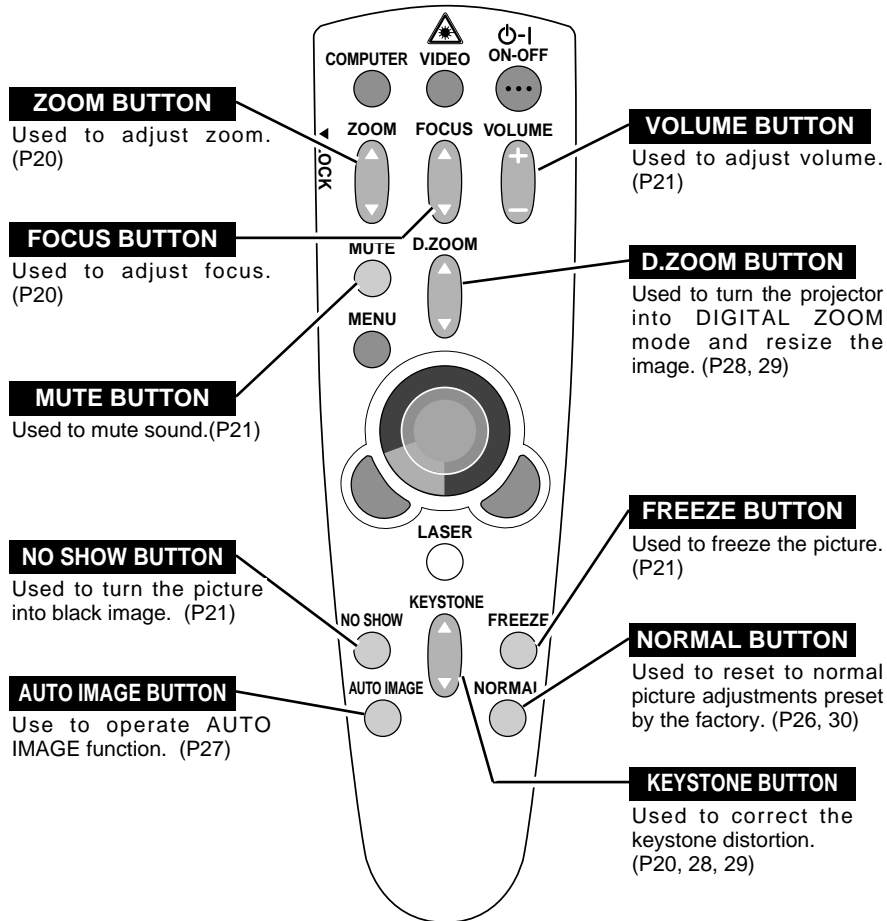

**Remote Control Batteries Installation**

**1** Remove the battery compartment lid.

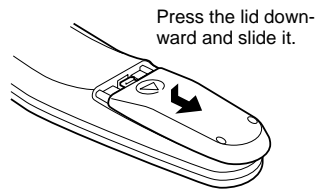

**2** Slide the batteries into the compartment.

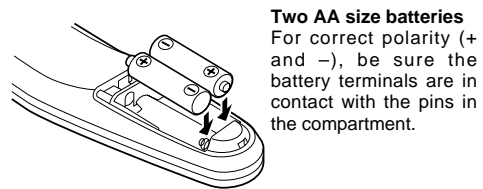

**3** Replace the compartment lid.

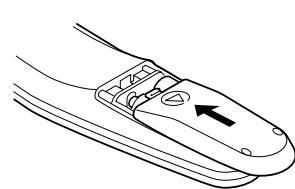

To insure safe operation, please observe the following precautions :

- Use (2) AA type alkaline batteries.
- Replace two batteries at the same time.
- Do not use a new battery with a used battery.
- Avoid contact with water or liquid.
- Do not expose the Remote Control Unit to moisture, or heat.
- Do not drop the remote control unit.
- If batteries have leaked on the remote control, carefully wipe the case clean and load new batteries.

# TOP CONTROLS AND INDICATORS

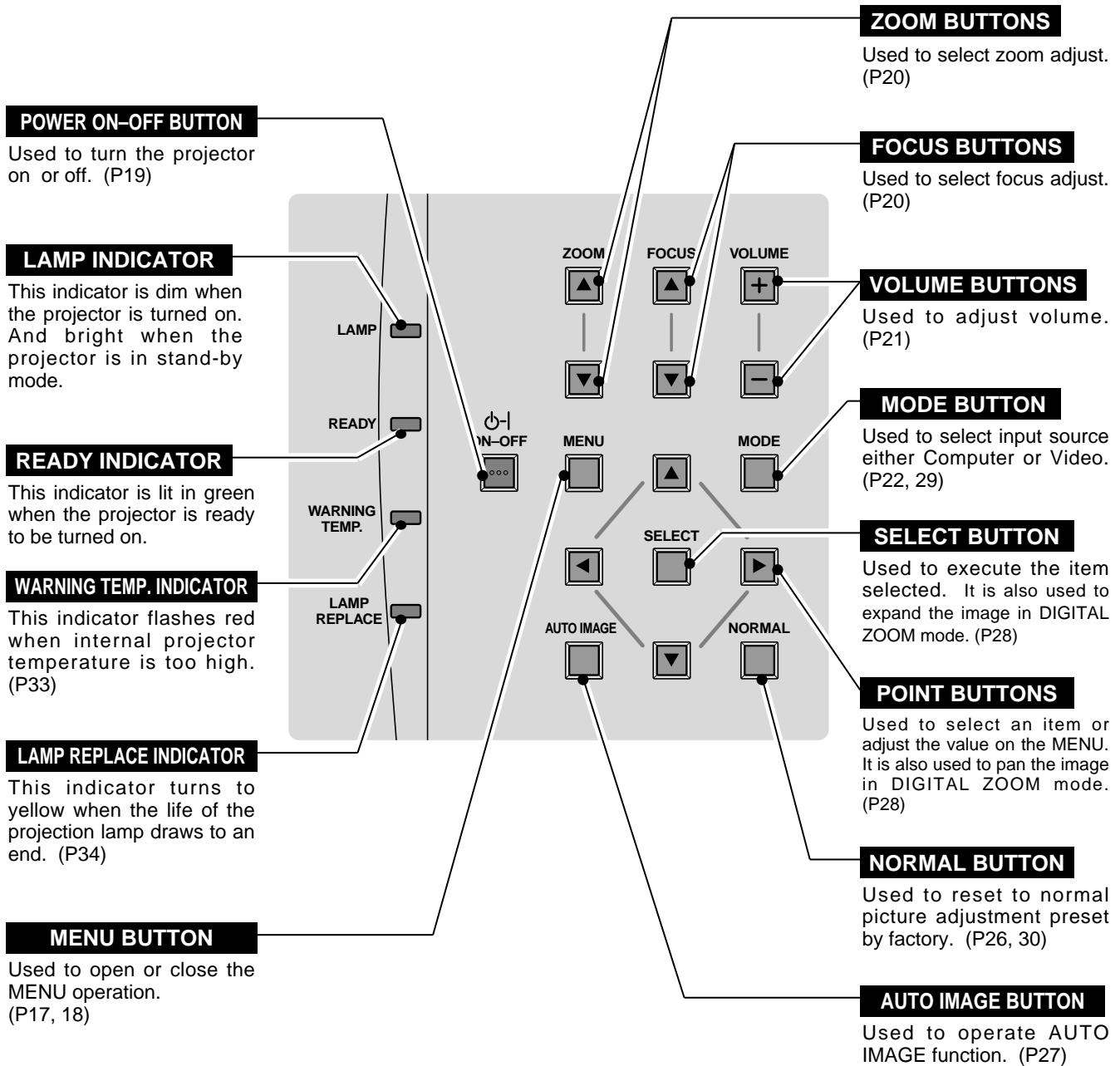



# OPERATING ON-SCREEN MENU

## HOW TO OPERATE ON-SCREEN MENU

You can control and adjust this projector through the ON-SCREEN MENU. Refer to the following pages to operate each adjustment on the ON-SCREEN MENU.

### 1 MOVING THE POINTER

Move the pointer (see the NOTE below) by pressing POINT button(s) on the TOP CONTROL or the REMOTE CONTROL.

### 2 SELECT THE ITEM

Select the item by pressing SELECT button.

NOTE : Pointer is the icon on the ON-SCREEN Menu to select the item. See the figures on the section "FLOW OF ON-SCREEN MENU" below.

### WIRELESS REMOTE CONTROL

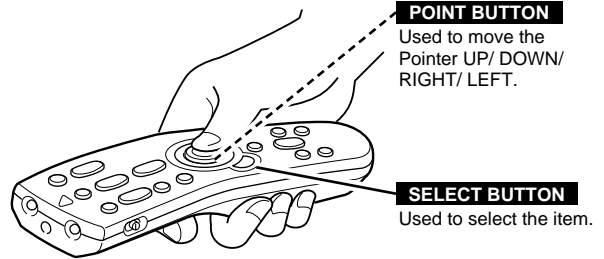

### TOP CONTROL

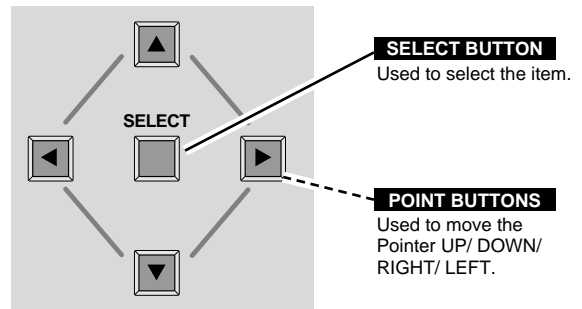

## FLOW OF ON-SCREEN MENU

### Display ON-SCREEN MENU

1 Press MENU button to display the ON-SCREEN MENU (MENU BAR). The red frame is the POINTER.

### Select the Item

2 Move the POINTER (red frame) to the ITEM ICON that you want to select by pressing POINT RIGHT / LEFT buttons.

3 Select the ITEM by pressing SELECT button. The dialog box of the ITEM appears.

### Control and adjust through ON-SCREEN MENU

4 Move the POINTER downward by pressing POINT DOWN button. (The shape of the POINTER becomes an arrow.)

5 Move the POINTER to the ITEM that you want to adjust and adjust the ITEM by pressing SELECT button. Refer to the following pages for details of respective adjustments.

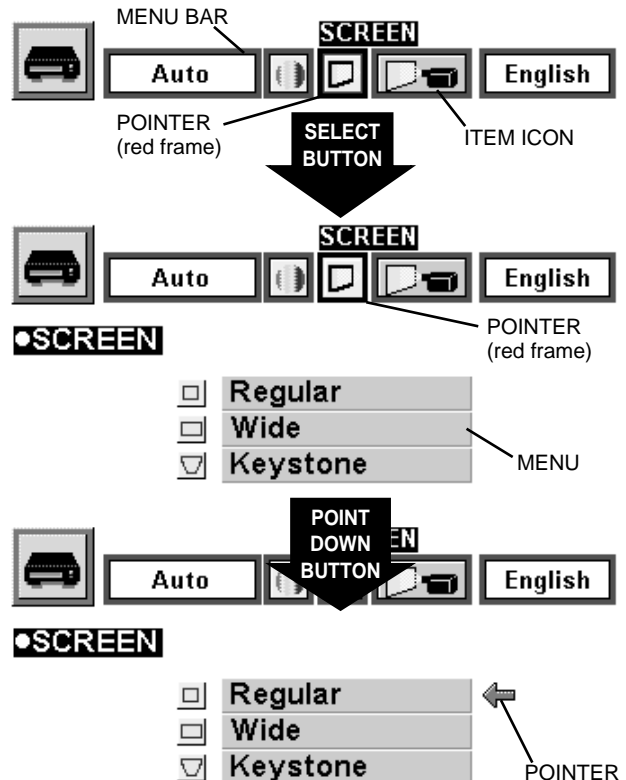

**MENU BAR**

**MENU BAR IN COMPUTER MODE**

Press MENU BUTTON while in Computer mode.

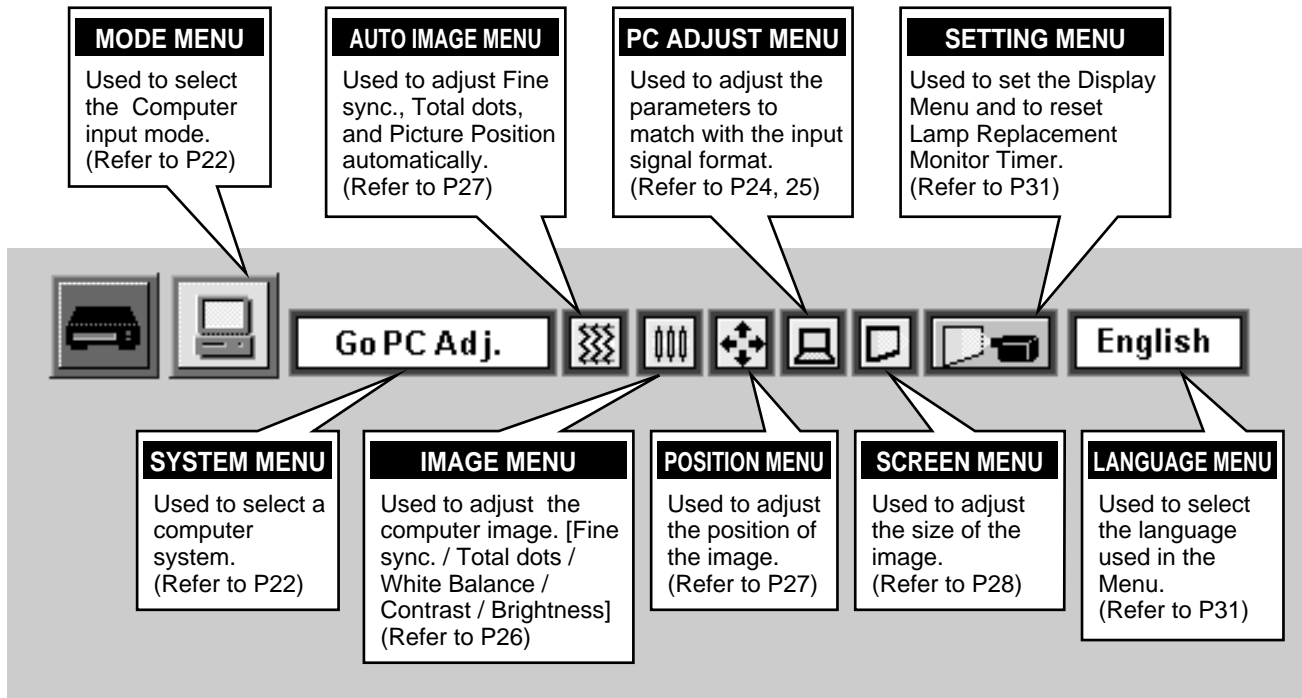

**MENU BAR IN VIDEO MODE**

Press MENU BUTTON while in Video mode.

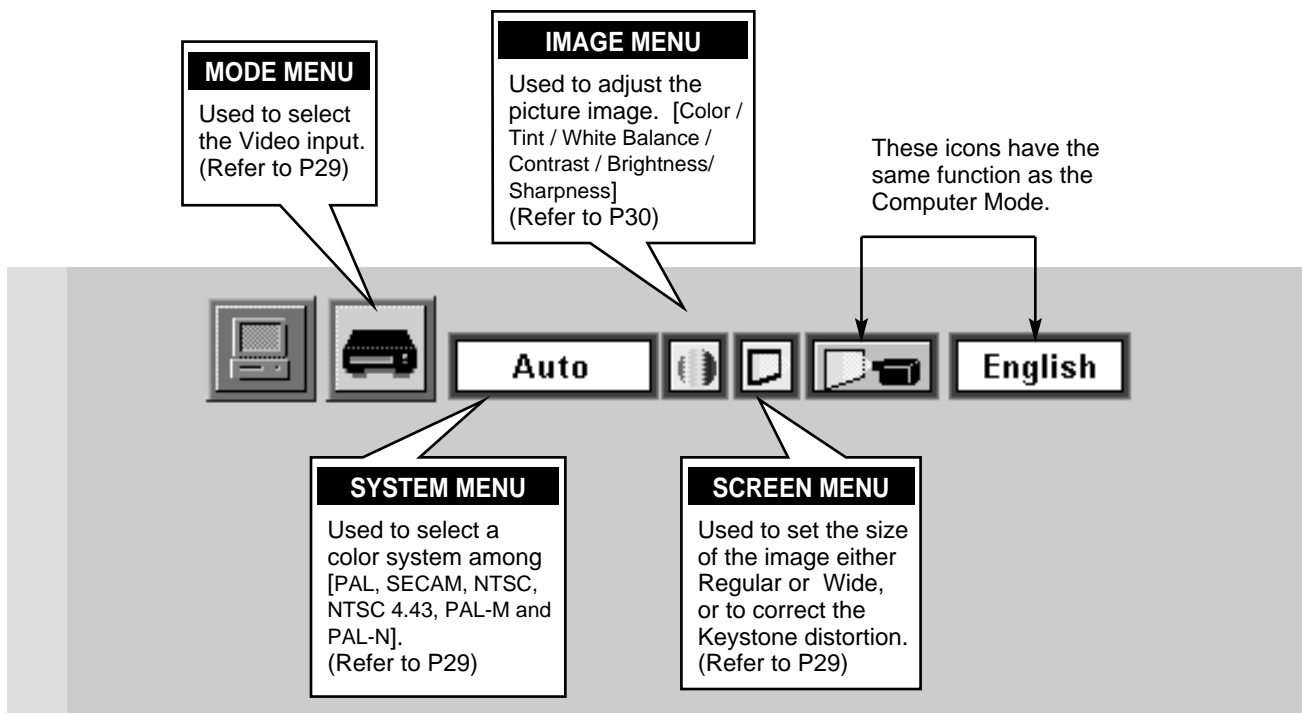

## TURNING ON / OFF THE PROJECTOR

### TURNING ON THE PROJECTOR

- 1 Complete the peripheral connections (with Computer, VCR, etc.) before turning on the projector. (Refer to "CONNECTING TO THE PROJECTOR" on Pages 10~13 for connecting that equipment.)
- 2 Connect the projector's AC power cord into a wall outlet. The LAMP indicator lights RED, and the READY indicator lights GREEN.
- 3 Press the power ON-OFF button on the Remote Control Unit or on the Top Control to ON. The LAMP POWER indicator dims, and the Cooling Fans start to operate. The Preparation Display appears on the screen and the count-down starts. The signal from the source appears after 30 seconds.

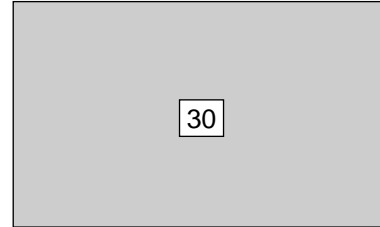

The Preparation Display disappears after 30 seconds.

### TURNING OFF THE PROJECTOR

- 1 Press the power ON-OFF button on the Remote Control Unit or on the Top Control, and the message "Power off?" appears on the screen.
- 2 Press the power ON-OFF button again to turn off the projector. The LAMP indicator lights bright and the READY indicator turns off. The Cooling Fans operate for 90 seconds after the projector is turned off. (During this "Cooling Down" period, this appliance cannot be turned on.)
- 3 When cooling the projector has finished, the READY indicator turns to green again and you can turn the projector on. After cooling down completely, disconnect the AC power cord.

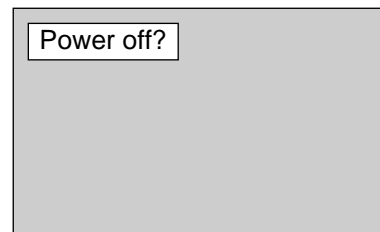

The message disappears after 4 seconds.



TO MAINTAIN THE LIFE OF THE LAMP, ONCE YOU TURN IT ON, WAIT AT LEAST 5 MINUTES BEFORE TURNING IT OFF.

When the TEMPERATURE WARNING indicator flashes red, the projector is automatically turned off. Wait at least 5 minutes before turning the projector on again.

If the TEMPERATURE WARNING indicator continues to flash, follow procedures below:

1. Disconnect the AC power cord from the AC outlet.
2. Check the air filters for dust accumulation.
3. Clean the Air Filter. (See "AIR FILTER CARE AND CLEANING" section on page 33.)
4. Press the power ON-OFF button to ON.

If the TEMPERATURE WARNING indicator still continues to flash, call Boxlight at 1-800-762-5757 or 360-779-7901.

**NOTE: The Cooling Fan may work for cooling while the projector is turned off. When the Cooling Fan is working, TEMPERATURE WARNING INDICATOR flashes red.**

## ADJUSTING THE IMAGE

### ZOOM ADJUSTMENT

- 1 Press the ZOOM ▲/▼ button(s) on the Top Control or on the Remote Control Unit to turn on the ZOOM mode.
- 2 Press the ZOOM ▲ button to make the image larger, and press the ZOOM ▼ button to make the image smaller.

In the Computer mode, the image can be expanded, compressed, and panned with the Digital Zoom function. Refer to page 28 for the Digital Zoom operation.

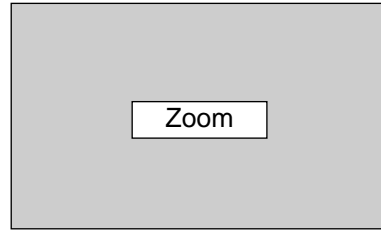

The message disappears after 4 seconds.

### FOCUS ADJUSTMENT

- 1 Press the FOCUS ▲/▼ button(s) on the Top Control or on the Remote Control Unit to turn on the FOCUS mode.
- 2 Adjust the focus of the image by pressing the FOCUS ▲/▼ button.

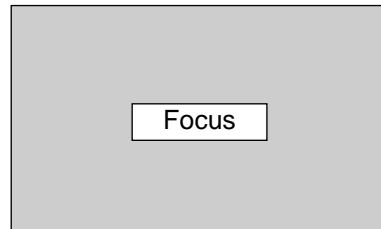

The message disappears after 4 seconds.

### KEYSTONE ADJUSTMENT

If the picture has keystone distortion, correct image with KEYSTONE adjustment.

- 1 Press the KEYSTONE ▲/▼ button on the Remote Control Unit or select the Keystone on the SCREEN menu. (Refer to page 28, 29.) The message "Keystone" is displayed.
- 2 Correct the Keystone distortion by pressing the KEYSTONE ▲/▼ button or the POINT UP/DOWN button(s). Press the KEYSTONE ▲ button or the POINT UP button to reduce the upper part of the image, and press the KEYSTONE ▼ button or the POINT DOWN button to reduce the lower part.

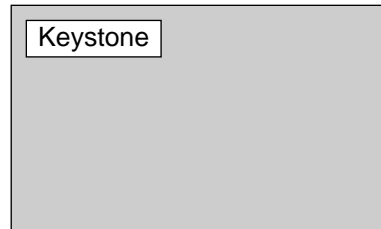

The message disappears after 4 seconds.

Reduce the upper width with the KEY STONE ▲ button or the POINT UP button.

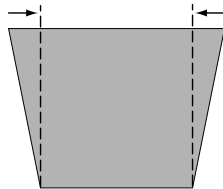

Reduce the lower width with the KEY STONE ▼ button or the POINT DOWN button.

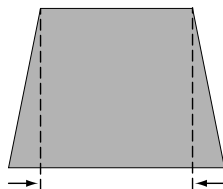

**NO SHOW FUNCTION**

Press the NO SHOW button on the Remote Control Unit to black out the image. This function is cancelled when the NO SHOW button is pressed again or any other function button is pressed.

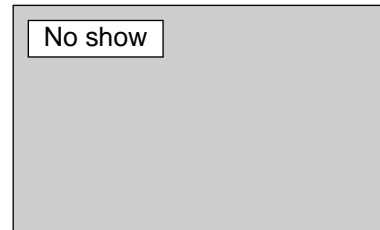

The message disappears after 4 seconds.

**PICTURE FREEZE FUNCTION**

Press the FREEZE button on the Remote Control Unit to freeze the picture on-screen. This function is cancelled when the FREEZE button is pressed again or any other function button is pressed.

**SOUND ADJUSTMENT**

**SOUND VOLUME ADJUSTMENT**

Press the VOLUME (+/-) button(s) on the Top Control or on the Remote Control Unit to adjust the volume. The Volume dialog box appears on the screen for a few seconds. The VOLUME (+) button increases the volume, and the VOLUME (-) button decreases the volume.

**SOUND MUTE ADJUSTMENT**

Press the MUTE button on the Remote Control Unit to mute the sound. To restore the sound to its previous level, press the MUTE button again or press the VOLUME (+/-) button(s).

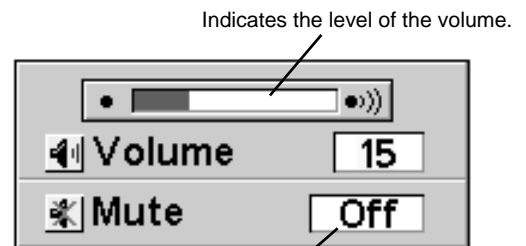

The display disappears after 4 seconds.

# COMPUTER MODE

## SELECTING COMPUTER MODE

### DIRECT OPERATION

Select COMPUTER mode by pressing the MODE button on the Top Control or the COMPUTER button on the Remote Control Unit.

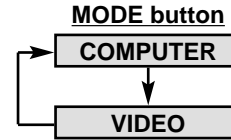

### MENU OPERATION

Press the MENU button and the ON-SCREEN MENU will appear. Press the POINT LEFT/RIGHT buttons to select Computer  and press the SELECT button.



### CURRENT MODE DISPLAY

When selecting the Computer Mode, the Current Mode display appears. It shows the information of the computer of the mode selected.

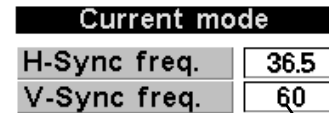

Providing the information of the computer detected by the projector.

## SELECTING COMPUTER SYSTEM

### AUTOMATIC MULTISCANNING SYSTEM

This projector automatically tunes to most different types of computer based on VGA, SVGA or XGA (refer to "COMPATIBLE COMPUTER SPECIFICATION" on page 23). When selecting Computer, this projector automatically tunes to the incoming signal and projects the proper image without any special setting. (Setting of the Computer System may be required when connecting some computers.)

Note : The projector may provides the messages below.

**Go to PC adj.** The projector cannot discriminate or detect the input signal from the computer. Adjust and set the computer system manually. (Refer to page 24.)

**No signal** There is no signal input from the computer. Make sure the connection of the computer and the projector is set correctly. (Refer to TROUBLESHOOTING on page 35.)

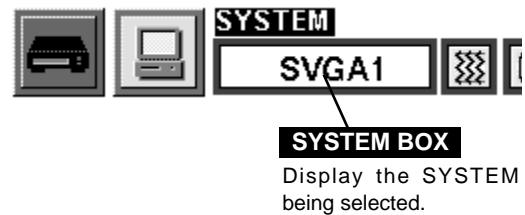

**SYSTEM BOX**  
Display the SYSTEM being selected.

### SELECT COMPUTER MODE MANUALLY

To set the Computer system manually, select the mode on the ON-SCREEN MENU.

- 1 Press the MENU button and the ON-SCREEN MENU will appear. Press the POINT LEFT/RIGHT buttons to select SYSTEM and press the SELECT button. Another dialog box COMPUTER SYSTEM Menu will appear.
- 2 Press the POINT DOWN button and a red-arrow icon will appear. Move the arrow to the system that you want to set, and then press SELECT button.

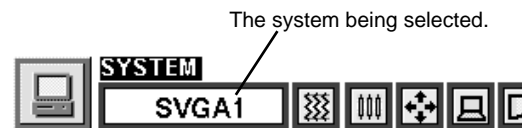

The system being selected.

### SYSTEM

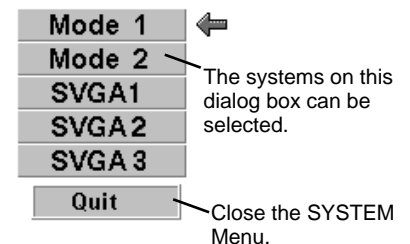

The systems on this dialog box can be selected.

Close the SYSTEM Menu.

**COMPATIBLE COMPUTER SPECIFICATIONS**

Basically this projector can accept the signal from all computers with the V, H-Frequency mentioned below and less than 135 MHz of Dot Clock.

| ON-SCREEN DISPLAY | RESOLUTION               | H-Freq. (kHz) | V-Freq. (Hz) | ON-SCREEN DISPLAY | RESOLUTION                | H-Freq. (kHz) | V-Freq. (Hz) |
|-------------------|--------------------------|---------------|--------------|-------------------|---------------------------|---------------|--------------|
| VGA 1             | 640 x 480                | 31.47         | 59.88        | SVGA 10           | 800 x 600                 | 47.90         | 71.92        |
| VGA 2             | 720 x 400                | 31.47         | 70.09        | SVGA 11           | 800 x 600                 | 32.70         | 51.09        |
| VGA 3             | 640 x 400                | 31.47         | 70.09        | SVGA 12           | 800 x 600                 | 38.00         | 60.51        |
| VGA 4             | 640 x 480                | 37.86         | 74.38        | MAC1 6            | 832 x 624                 | 49.72         | 74.55        |
| VGA 5             | 640 x 480                | 37.86         | 72.81        | XGA 1             | 1024 x 768                | 48.36         | 60.00        |
| VGA 6             | 640 x 480                | 37.50         | 75.00        | XGA 2             | 1024 x 768                | 68.677        | 84.997       |
| MAC LC13          | 640 x 480                | 34.97         | 66.60        | XGA 3             | 1024 x 768                | 60.023        | 75.03        |
| MAC 13            | 640 x 480                | 35.00         | 66.67        | XGA 4             | 1024 x 768                | 56.476        | 70.07        |
| RGB               | 640 x 480<br>(Interlace) | 15.734        | 30           | XGA 5             | 1024 x 768                | 60.31         | 74.92        |
| RGB               | 768 x 576<br>(Interlace) | 15.625        | 25           | XGA 6             | 1024 x 768                | 48.50         | 60.02        |
| SVGA 1            | 800 x 600                | 35.156        | 56.25        | XGA 7             | 1024 x 768                | 44.00         | 54.58        |
| SVGA 2            | 800 x 600                | 37.88         | 60.32        | XGA 8             | 1024 x 768                | 63.48         | 79.35        |
| SVGA 3            | 800 x 600                | 46.875        | 75.00        | XGA 9             | 1024 x 768<br>(Interlace) | 36.00         | 43.59        |
| SVGA 4            | 800 x 600                | 53.674        | 85.06        | XGA 10            | 1024 x 768                | 62.04         | 77.07        |
| SVGA 5            | 800 x 600                | 48.08         | 72.19        | XGA 11            | 1024 x 768                | 61.00         | 75.70        |
| SVGA 6            | 800 x 600                | 37.90         | 61.03        | XGA 12            | 1024 x 768<br>(Interlace) | 35.522        | 43.48        |
| SVGA 7            | 800 x 600                | 34.50         | 55.38        | XGA 13            | 1024 x 768                | 46.90         | 58.20        |
| SVGA 8            | 800 x 600                | 38.00         | 60.51        | XGA 14            | 1024 x 768                | 47.00         | 58.30        |
| SVGA 9            | 800 x 600                | 38.60         | 60.31        | MAC 19            | 1024 x 768                | 60.24         | 75.08        |

NOTE : Specifications are subject to change without notice.

# PC ADJUSTMENT

This Projector can automatically tune to the display signals from most personal computers currently distributed. However, some computers employ the special signal formats which are different from the standard ones and may not be tuned by Multiscanning of this projector. If this happens, the projector cannot reproduce a proper image and the image is recognized as a flickering picture, a non-synchronized picture, a non-centered picture or a skewed picture.

This projector has PC ADJUSTMENT function, to enable you to precisely adjust several parameters to match with those exceptional signal formats and the projector has five independent memory areas to memorize those parameters manually adjusted. This enables you to recall the setting for a specific computer whenever you use it.

- 1 Press the MENU button and the ON-SCREEN MENU will appear. Press the POINT RIGHT/LEFT buttons to select PC ADJUST  and press the SELECT button. Another dialog box "Where to reserve" Menu will appear.
- 2 In this dialog box, you can store the parameter into the area from "Mode 1" to "Mode 5." When memorizing the new computer parameter, select the Mode with the message "Free" by pressing the POINT UP/DOWN buttons and the SELECT button. To change the parameters of the Mode previously set, select the Mode with "Stored."
- 3 When the Mode is selected, Parameter adjustment dialog box appears. Move the arrow to the item that you want to change by pressing the POINT UP/DOWN buttons, and adjust each item to match with your computer. To change the value, press either the POINT RIGHT button or the POINT LEFT button. Refer to the next page for adjusting each item.
- 4 Move the arrow to "Stored" and press the SELECT button. The parameter is memorized in the selected Mode.
- 5 To activate the Mode manually adjusted in this PC ADJUSTMENT Menu, select the Mode at the SYSTEM SELECT Menu. (Refer to page 22.)

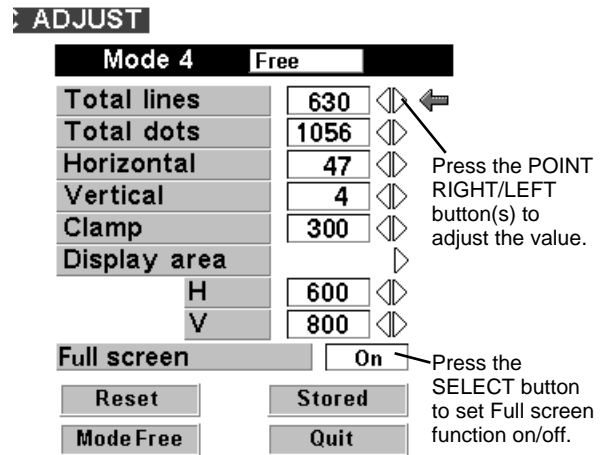
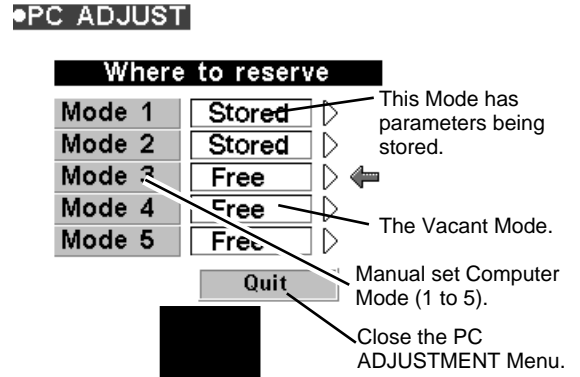



### Total lines

The number of the total vertical lines. Adjust the number to match the image of your personal computer.

### Total dots

The number of the total dots in one horizontal period. Adjust the number to match the image of your personal computer.

### Horizontal / Vertical

Adjustment of the horizontal or vertical picture position. When the image is not centered on the screen, adjust each of those items.

### Clamp

Adjustment of the clamp level. When the image has a dark bar(s), try this adjustment.

### Display area

Adjustment of the area displayed with this projector. Select the resolution at the Display area dialog box, or adjust the number at the column of "H" or "V" to match the resolution of the image.

### Full Screen

Set "On" to resize the image with 4 x 3 aspect ratio to fit the screen.

Each of the keys operates as follow.

- Reset** ..... Recalls the parameter data that was previously adjusted.
- Mode free** ..... Clears the parameter data previously set.
- Stored** ..... Stores the parameters in the memory.
- Quit** ..... Closes the PC ADJUST Menu.

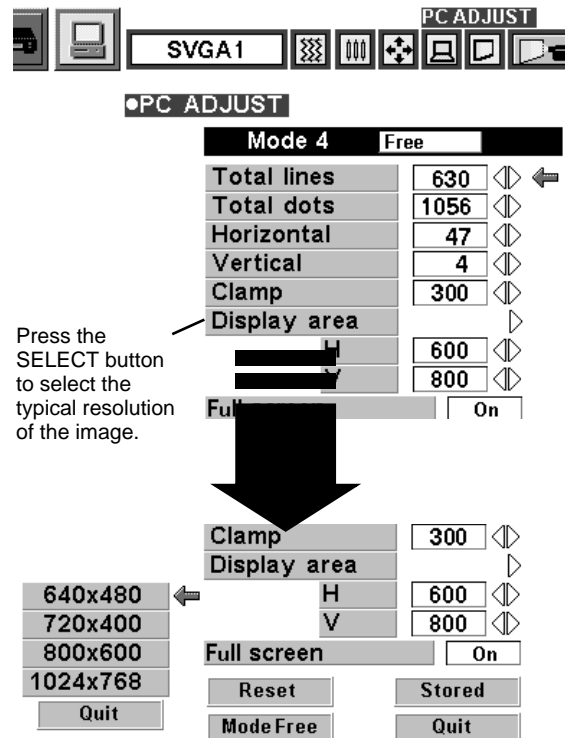

## ADJUST PICTURE IMAGE MANUALLY

- 1 Press the MENU button and the ON-SCREEN MENU will appear. Press the POINT LEFT/RIGHT buttons to select IMAGE  and press the SELECT button. Another dialog box PICTURE IMAGE ADJUSTMENT Menu will appear.
- 2 Press the POINT DOWN button and a red-arrow icon will appear. Move the arrow to the item that you want to change by pressing the POINT UP/DOWN buttons. To change the value, press either the POINT RIGHT button or the POINT LEFT button.

### Fine sync.

Adjust the picture as necessary to eliminate flicker from the display. (From 0 to 255.)

### Total dots

The number of the total dots in one horizontal period. Adjust the number to match your PC image.

### White balance (Red / Green / Blue)

Move the arrow to the color that you want to adjust. Press POINT LEFT button to lighten the color and press POINT RIGHT button to deepen the color. (From 0 to 63.)

### Contrast

Press POINT LEFT button to decrease contrast, and press POINT RIGHT button to increase contrast. (From 0 to 63.)

### Brightness

Press POINT LEFT button to adjust the image darker, and press POINT RIGHT button to adjust brighter. (From 0 to 63.)

Each of the keys operates as follow.

- Reset** .... Recalls the data previously adjusted.
- Stored** .... Stores the adjusted data in the memory.
- Quit** .... Closes the PICTURE IMAGE ADJUSTMENT Menu.

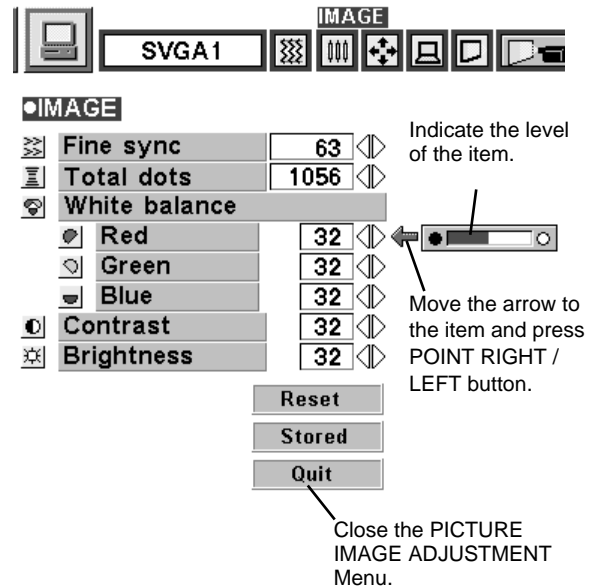

## NORMAL FUNCTION

The normal picture level is preset on this projector at the factory and can be restored anytime you press the NORMAL button (located on the Top Control or on the Remote Control Unit). The "Normal" display will be displayed on the screen for a few seconds.

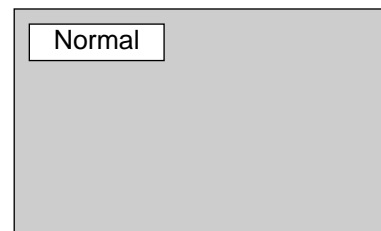

## AUTO IMAGE FUNCTION

The Auto Image function is provided to automatically adjust Fine sync., Total dots, and Picture Position for most computers.

- 1 Press the MENU button and the ON-SCREEN MENU will appear. Press the POINT LEFT/RIGHT buttons to select AUTO IMAGE  and press the SELECT button. Another dialog box AUTO IMAGE Menu will appear.
- 2 Move the arrow to an item that you want to adjust by pressing the POINT UP/DOWN button. Change the setting On or Off by pressing the SELECT button.

### Fine sync.

Adjust the picture as necessary to eliminate flicker from the display. This item can be adjusted manually. (Refer to page 26.)

### Total dots

The number of the total dots in one horizontal period. This item can be adjusted manually. (Refer to page 26.)

### Position

Adjustment of the position of the image. This item can be adjusted manually. (Refer to page 27.)

- 3 Move the arrow to "Go!" and press the SELECT button to start the Auto Image function. This adjustment can be executed by pressing AUTO IMAGE button on the Top Control and the Remote Control Unit.

**Stored** .... Stores the On/Off setting of each item.

**Go!** .... Starts the Auto Image Adjustment.

**Quit** .... Closes the AUTO IMAGE ADJUSTMENT Menu.

NOTE : The Fine sync., Total dots, and Picture Position of some computers may not be fully adjusted with the Auto Image Function. In that case, manual adjustment is required to make fine image. (Refer to page 26 to adjust "Fine sync." or "Total dots" and page 27 to adjust Picture Position.)

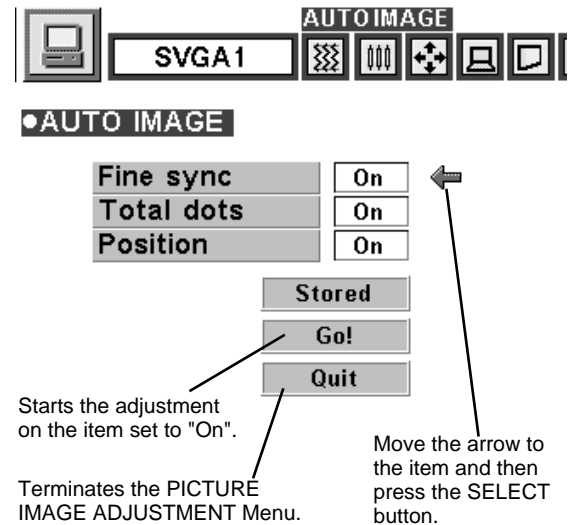

## PICTURE POSITION ADJUSTMENT

The position of the image can be adjusted vertically and horizontally through PICTURE POSITION ADJUSTMENT.

- 1 Press the MENU button and the ON-SCREEN MENU will appear. Press the POINT LEFT/RIGHT buttons to select POSITION  and press the SELECT button. The PICTURE POSITION dialog box will appear.
- 2 Move the image by pressing the POINT UP / DOWN / RIGHT / LEFT buttons.

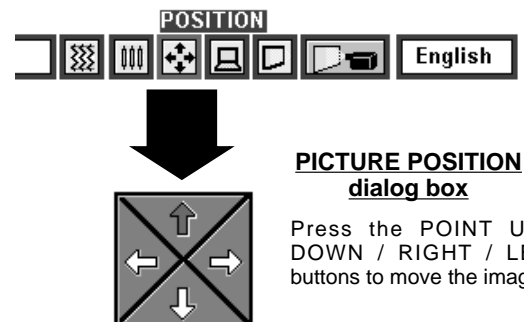

## PICTURE SCREEN ADJUSTMENT

This projector has a picture screen resize function, which enables you to display the desirable image size.

- 1 Press the MENU button and the ON-SCREEN MENU will appear. Press the POINT LEFT/RIGHT buttons to select SCREEN  and press the SELECT button. Another dialog box PICTURE SCREEN Menu will appear.
- 2 Press the POINT DOWN button and a red-arrow icon will appear. Move the arrow to the function that you want to select and then press SELECT button.

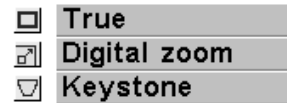

Move the arrow to the function and press the SELECT button.

### True

To make the image into its original size select True in the dialog box. When the original image size is larger than the screen size (800 x 600), this projector enters Digital Zoom mode automatically.

### Keystone

When the image is distorted vertically, select Keystone in the dialog box. The ON-SCREEN menu and SCREEN ADJUST menu disappears and the message "Keystone" is displayed. Correct the Keystone distortion by pressing the KEYSTONE ▲/▼ button or the POINT UP/DOWN button(s). Refer to KEYSTONE ADJUSTMENT on page 20.

### Digital Zoom

To adjust the image size or pan the image, select Digital zoom in the dialog box. The ON-SCREEN menu and SCREEN ADJUST menu disappears and the message "D. Zoom" is displayed.

This projector is also enters Digital Zoom mode by pressing the D.ZOOM ▲/▼ button on the Remote Control Unit. Refer to the following for operation.

### Expand function

To expand the image size, press the D.ZOOM ▲ button or the SELECT button. The image is magnified by degrees.

### Compress function

To compress the image size, press the D.ZOOM ▼ button or the RIGHT CLICK button. The size of image is reduced by degrees.

### Panning function

To pan the image, press the POINT UP/DOWN/LEFT/RIGHT buttons. Panning function can work only when the image is larger than the screen size.

To cancel Digital Zoom mode, press any button except D.ZOOM ▲/▼, SELECT, RIGHT CLICK, POINT or LASER button. To adjust the image to 800 x 600, press NORMAL button.

- This projector cannot display any resolution higher than 1024 X 768. If your computer's screen resolution is higher than 1024 X 768, reset the resolution to the lower before connecting the projector.
- The image data in other than SVGA (800 x 600) is modified to fit the screen size in the initial mode.
- The normal "Panning Operation" may not function properly if the computer system prepared with the "PC Adjust" is used.

# VIDEO MODE

## SELECTING VIDEO MODE

### DIRECT OPERATION

Select VIDEO mode by pressing the MODE button on the Top Control or the VIDEO button on the Remote Control Unit.

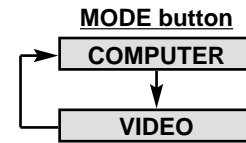

### MENU OPERATION

Press the MENU button and the ON-SCREEN MENU will appear. Press the POINT LEFT/RIGHT buttons to select Video  and press the SELECT button.



## SELECTING COLOR SYSTEM

- 1 Press the MENU button and the ON-SCREEN MENU will appear. Press the POINT LEFT/RIGHT buttons to select SYSTEM and press the SELECT button. Another dialog box VIDEO SYSTEM Menu will appear.
- 2 Press the POINT DOWN button and a red-arrow icon will appear. Move the arrow to "Auto", and then press the SELECT button.

#### Auto

The projector automatically detects the incoming Video system, and adjusts itself to optimize its performance. When the Video System is PAL-M or PAL-N, select the system manually.

#### PAL / SECAM / NTSC / NTSC4.43 / PAL-M / PAL-N

If the projector cannot reproduce the proper video image, it is necessary to select a specific broadcast signal format among PAL, SECAM, NTSC, NTSC 4.43, PAL-M, or PAL-N.

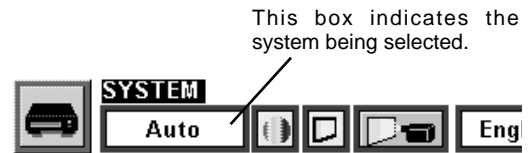

#### SYSTEM

- Auto
- PAL
- SECAM
- NTSC
- NTSC4.43
- PAL-M
- PAL-N

Move the arrow to the Mode and press the SELECT button.

## PICTURE SCREEN ADJUSTMENT

This projector has a picture screen resize function, which enables you to display the desirable image size.

- 1 Press the MENU button and the ON-SCREEN MENU will appear. Press the POINT LEFT/RIGHT buttons to select SCREEN  and press the SELECT button. Another dialog box PICTURE SCREEN ADJUSTMENT DISPLAY will appear.
- 2 Press the POINT DOWN button and a red-arrow icon will appear. Move the arrow to the screen size that you want to set, and then press the SELECT button.

#### Regular

Normal Video Image size with 4 x 3 aspect ratio.

#### Wide

Resizes the image for wide screen size with 16 x 9 aspect ratio.

#### Keystone

When the image is distorted vertically, select Keystone in the dialog box. Correct the Keystone distortion by pressing KEYSTONE ▲/▼ button or POINT UP/DOWN button(s). Refer to KEYSTONE ADJUSTMENT on page 20.



#### SCREEN

- Regular
- Wide
- Keystone

Move the pointer to the function and press the SELECT button.

# PICTURE IMAGE ADJUSTMENT

## ADJUSTING THE PICTURE IMAGE

- 1 Press the MENU button and the ON-SCREEN MENU will appear. Press the POINT LEFT/RIGHT buttons to select IMAGE  and press the SELECT button. Another dialog box PICTURE IMAGE ADJUSTMENT Menu will appear.
- 2 Press the POINT DOWN button and a red-arrow icon will appear. Move the arrow to the item that you want to adjust by pressing the POINT UP/DOWN buttons. To change the value, press either the POINT RIGHT button or the POINT LEFT button.

### Color

Press POINT LEFT button to lighten the image, and press POINT RIGHT button to deepen the image. (From 0 to 63.)

### Tint

Press POINT LEFT button to increase purple, and press POINT RIGHT button to increase green. (From 0 to 63.)

### White balance (Red / Green / Blue)

Move the arrow to the color that you want to adjust. Press POINT LEFT button to lighten the color, and press POINT RIGHT button to deepen the color. (From 0 to 63.)

### Contrast

Press POINT LEFT button to decrease contrast, and press POINT RIGHT button to increase contrast. (From 0 to 63.)

### Brightness

Press POINT LEFT button to darken the image, and press POINT RIGHT button to brighten the image. (From 0 to 63.)

### Sharpness

Press POINT LEFT button to soften the image, and press POINT RIGHT button to sharpen the image. (From 0 to 63.)

Each of the keys operates as follow.

#### Reset

.... Recalls the data previously adjusted.

#### Stored

.... Stores the data in the memory.

#### Quit

.... Closes the PICTURE IMAGE ADJUSTMENT Menu.

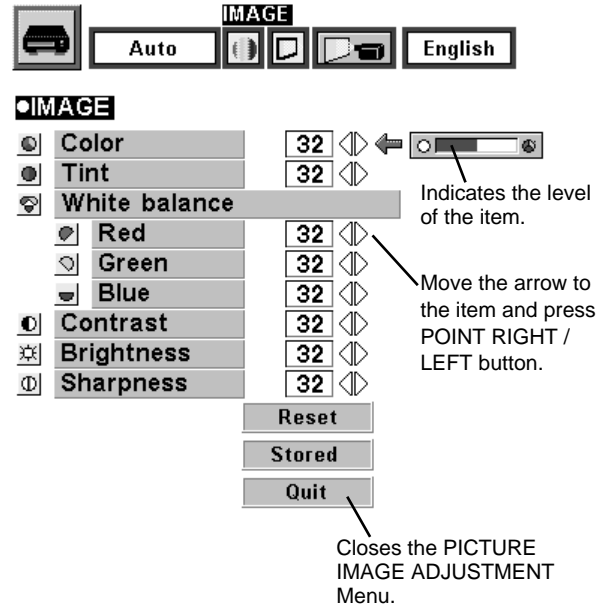

## NORMAL FUNCTION

The normal picture level is preset on this projector at the factory and can be restored anytime you press the NORMAL button (located on the Top Control or on the Remote Control Unit). The "Normal" display will be displayed on the screen for a few seconds.

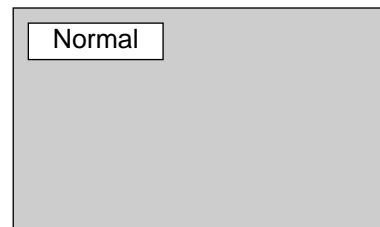

## SETTING MENU

- 1 Press the MENU button and the ON-SCREEN MENU will appear. Press the POINT LEFT/RIGHT buttons to select SETTING  and press the SELECT button. Another dialog box SETTING Menu will appear.
- 2 Press the POINT DOWN button and a red-arrow icon will appear. Move the arrow to the item that you want to set, and then press the SELECT button to set it "On" or "Off".

**Blue back** When this function is in the "On" position, this projector will produce a blue image instead of the video noise on the screen when the input source is unplugged or turned off.

**Display** When this function is in the "On" position, the On-Screen Displays always appear when adjustments are made. (The following displays disappear by switching this function "Off.")

- Preparation Display  
(The Number-counting-down Display)
- Mode Display
- Volume/Mute Display
- Zoom Display
- Focus Display
- Normal Display
- No show Display
- Keystone Display
- D.Zoom Display

**Ceiling** When this function is in the "On" position, the top / bottom and the left / right reversed picture is provided to project the image from a ceiling mounted projector.

**Rear** When this function is in the "On" position, the left / right reversed picture is provided to project the image to a rear projection screen.

**Split wipe** Turn this function "On" in the SETTING menu. The picture will change into next one by sliding black image side ways like drawing the black curtains when the input source is changed.

**Lamp age** The Lamp age function is designed to reset the lamp replacement monitor timer. When replacing the lamp, reset the lamp replacement monitor timer by using this function. (Refer to page 34.)



Set the Pointer to the item, and then press the SELECT button.

### Ceiling function

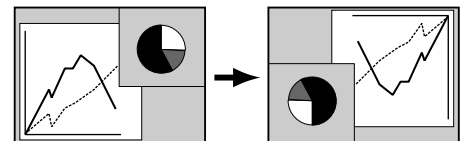

### Rear function

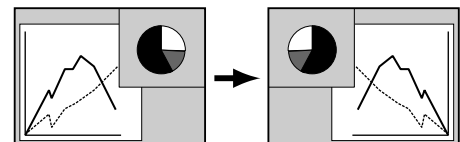

## SELECTING LANGUAGE

The language used in the ON-SCREEN MENU is selectable from among English, German, French, Italian, Spanish and Japanese.

- 1 Press the MENU button and the ON-SCREEN MENU will appear. Press POINT LEFT/RIGHT buttons to select LANGUAGE  and press the SELECT button. Another dialog box LANGUAGE Menu will appear.
- 2 Press the POINT DOWN button and a red-arrow icon will appear. Move the arrow to the language that you want to set, and then press the SELECT button.



Move the Pointer to the language that you want to set, and then press the SELECT button.

## OPERATING WIRELESS MOUSE

The Wireless Remote Control Unit is not only able to operate the projector but also usable as a wireless mouse for most Personal Computers. The POINT buttons and the two CLICK buttons are used for the wireless mouse operation.

The wireless mouse is available only when PC mouse pointer is displayed on the screen. When the menu or the indicator of the projector is displayed on the screen instead of the PC mouse pointer, the wireless mouse cannot be used.

### INSTALLATION

To use the Wireless Remote Control Unit as the Wireless Mouse for a Personal Computer, installation of the mouse driver (not supplied) is required. Make sure that the mouse driver is properly installed in your computer. And make sure that the mouse port of the computer connected to Control Port is activated.

- 1 Connect the mouse port of your computer to the Control Port of the projector with the Control Cable. (Refer to page 10 to 13 for connection.)
- 2 Turn the projector on first, and then turn on your computer. When the computer is switched on first, the Wireless Mouse may not work properly.

Note : When the computer has no mouse port, connect the Serial Port of the computer to Control Port of the projector with the Control Cable for Serial Port.

### OPERATING WIRELESS MOUSE

When controlling the pointer of the computer, operate the Wireless Mouse with POINT button, SELECT button, and RIGHT CLICK button on the Wireless Remote Control Unit.

#### POINT button

Used to move the pointer. The pointer is moved corresponding with the direction you are pressing.

#### SELECT (LEFT CLICK) button

This button has the same function as the left button in a PC mouse.

#### RIGHT CLICK button

This button has the same function as the right button in a PC mouse. Pressing this button does not affect any operation when in Menu mode.

POINT button (Move the pointer)

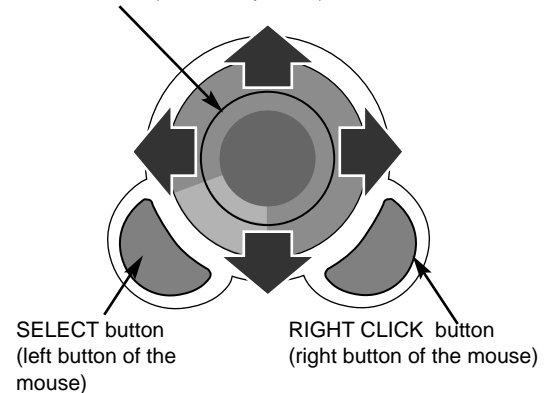



## MAINTENANCE

### TEMPERATURE WARNING INDICATOR

The TEMPERATURE WARNING Indicator flashes red when the internal temperature of the projector exceeds the normal temperature. The Indicator stops flashing when the temperature of the projector become normal. When the TEMPERATURE WARNING Indicator continues to flash, check the item listed below.

- 1 The Ventilation slots of the projector may be blocked. In such an event, reposition the appliance so that the ventilation slots are not obstructed.
- 2 Air filters are clogged with dust particles. Clean the air filters by following AIR FILTER CARE AND CLEANING below.
- 3 If the TEMPERATURE WARNING Indicator remains on after performing the above checks, the Cooling Fans or the Internal Circuits may be malfunctioning. In that case, call Boxlight.

### AIR FILTER CARE AND CLEANING

The Removable Air Filters prevent dust from accumulating on the surface of the Projection Lens and the Projection Mirror. Should the Air Filters become clogged with dust particles, it will reduce the Cooling Fans' effectiveness and may result in internal heat build up and adversely affect the life of the projector.

Clean the Air Filters following the steps below:

- 1 Turn the power off, and disconnect the AC power cord from the AC outlet.
- 2 Turn the projector upside down and remove the Air Filters by pulling the latches upward.
- 3 Clean the Air Filters with brush or wash out the dust and particles.
- 4 Replace the Air Filter. Make sure that the Air Filters are fully inserted.



#### **CAUTION**

Do not operate the projector with the Air Filter removed. Dust may become stuck on the LCD Panel and the Mirror degrading picture quality.

Do not put small parts into the Air Intake Vents. It may result in malfunction of the projector.

The Air Filter is small part. Ensure that children don't eat or swallow it.

AIR FILTERS

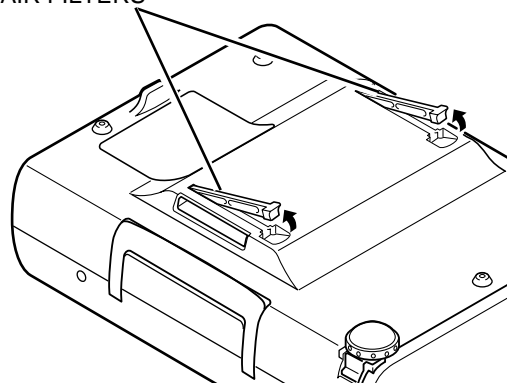

#### **RECOMMENDATION**

**We recommend avoiding dusty/smoky environment for operating the projector. Using in these environment may cause poor image quality.**

When using under dusty or smoky conditions, dust may accumulate on the liquid crystal panel and lens inside it, and may resultantly be projected onto the screen together with the picture.

When the above symptoms are noticed contact Boxlight at 1-800-762-5757 or 360-779-7901 for cleaning.

### CLEANING THE PROJECTION LENS

Follow these steps to clean the projection lens:

- 1 Apply a non-abrasive camera lens cleaner to a soft, dry cleaning cloth. Avoid using an excessive amount of cleaner. Abrasive cleaners, solvents or other harsh chemicals might scratch the lens.
- 2 Lightly wipe the cleaning cloth over the lens.
- 3 When the projector is not in use, replace the lens cover.

## LAMP REPLACEMENT INDICATOR

When the life of the Lamp of this projector draws to an end, the LAMP REPLACEMENT indicator lights yellow. When the image becomes dark or the color of the image becomes unnatural, replacement of the Lamp is required.

## LAMP REPLACEMENT



### CAUTION

- For continued safety, replace with a lamp assembly of the same type.
- Allow the projector to cool for at least 45 minutes before you open the lamp cover. The inside of the projector can become very hot.
- Do not drop the lamp assembly or touch the glass bulb! The glass can shatter and may cause injury.

Follow these steps to replace the lamp assembly.

- 1** Turn off the projector and disconnect the AC plug. Allow the projector to cool for at least 45 minutes.
- 2** Remove a screw with a screwdriver and remove the Lamp Cover.
- 3** Remove 2 screws with a screwdriver and pull out the Lamp Assembly by grasping the handle.
- 4** Replace the Lamp Assembly with new one and tighten 2 screws. Make sure that the Lamp Assembly is set properly. And replace the Lamp Cover and tighten a screw.
- 5** Connect the AC Power Cord to the projector and turn the projector on.
- 6** Reset the Lamp Replacement Monitor Timer (refer to the section "Lamp Replacement Monitor Timer" below).

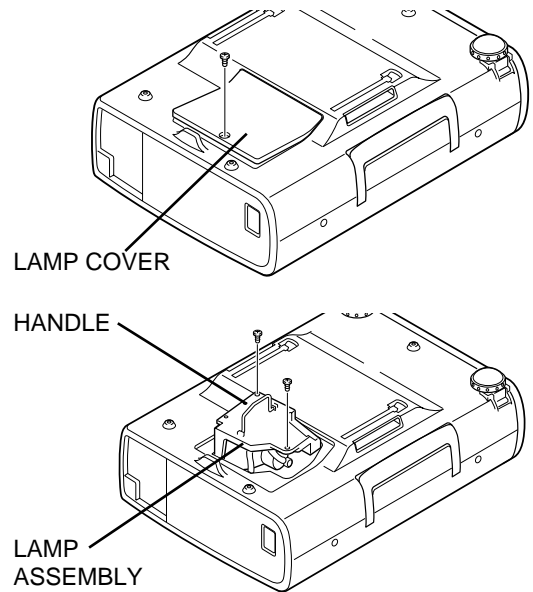

**NOTE :** Do not reset the LAMP REPLACEMENT MONITOR TIMER, when the lamp is not replaced.

### ORDER REPLACEMENT LAMP

Replacement Lamp can be ordered through Boxlight at 1-800-762-5757 or 360-779-7901.

- Model No. of your projector : BOXLIGHT CP-11t
- Replacement Lamp Type No. : POA-LMP21J (BOXLIGHT Lamp No. : CP10T-930)  
(Service Parts No. 610 280 6939)

## LAMP REPLACEMENT MONITOR TIMER

Be sure to reset the Lamp Replacement Monitor Timer when the Lamp Assembly is replaced. When the Lamp Replacement Monitor Timer is reset, the LAMP REPLACEMENT indicator stops lighting.

- 1** Turn the projector on, and press the MENU button and the ON-SCREEN MENU will appear. Press the POINT LEFT/RIGHT buttons to select SETTING  and press the SELECT button (refer to the page 31). Another dialog box SETTING MENU will appear.
- 2** Press the POINT DOWN button and a red-arrow icon will appear. Move the arrow to Lamp age, and then press the SELECT button. The message "Lamp replace monitor Reset?" is displayed.
- 3** Select [Yes] to reset the Timer.

Do not reset the Lamp Replacement Monitor Timer, except after the lamp is replaced.

## TROUBLESHOOTING

Before calling your dealer or service station for assistance, check the matters below once again.

1. Make sure you have connected the projector to your equipment as described in the section "CONNECTING THE PROJECTOR" on pages 10 ~ 13.
2. Check cable connection. Verify that all computer, video and power cord are properly connected.
3. Verify that all power is switched on.
4. If the projector still does not produce the image, re-start the computer.
5. If the image still does not appear, unplug the projector from the computer and check the computer monitor's display. The problem may be with your graphics controller rather than with the projector. (When you reconnect the projector, remember to turn the computer and monitor off before you power up the projector. Power the equipment back on in order of : Projector and computer.)
6. If the problem still exists, check the following chart.

| Problem:  | Try these Solution   |
|---|--|
| <b>No power.</b>  | <ul style="list-style-type: none"> <li>● Plug the projector into the AC outlet.</li> <li>● Be sure READY Indicator light is On.</li> <li>● Wait 90 seconds after the projector is turned OFF before turning the projector back on.</li> </ul> <p>NOTE : After pressing the power ON-OFF switch to OFF, make sure the projector works as follows:</p> <ol style="list-style-type: none"> <li>1. The LAMP indicator will light and the READY indicator will turn off.</li> <li>2. After 90 seconds, the READY indicator will light green again and the projector may be turned on by pressing the power ON-OFF button.</li> </ol> <ul style="list-style-type: none"> <li>● Check the TEMPERATURE WARNING indicator. If the indicator flashes red, the projector cannot be turned on.<br/>(See "TURNING ON/OFF THE PROJECTOR" section on page 19.)</li> <li>● Check the Projection Lamp. (Refer to page 34.)</li> </ul> |
| <b>Image is out of focus.</b>                           | <ul style="list-style-type: none"> <li>● Adjust the focus</li> <li>● Make sure the projection screen is at least 4.6' (1.4m) from the projector.</li> <li>● Check the projection lens to see if it needs cleaning.</li> </ul> <p>NOTE : Moving the projector from a cool temperature location to a warm temperature location may result in moisture condensation on the lens. In such an event, leave the projector OFF and wait until condensation disappears.</p>  |
| <b>Picture is Left/Right reversed.</b>                  | <ul style="list-style-type: none"> <li>● Check Ceiling / Rear feature. (See "SETTING" section on page 31.)</li> </ul>  |
| <b>Picture is Top/Bottom reversed.</b>                  | <ul style="list-style-type: none"> <li>● Check Ceiling feature. (See "SETTING" section on page 31.)</li> </ul>   |
| <b>Some displays are not seen during the Operation.</b> | <ul style="list-style-type: none"> <li>● Check Display feature.(See "SETTING" section on page 31.)</li> </ul>  |
| <b>No image.</b>  | <ul style="list-style-type: none"> <li>● Check the connection between the computer or video equipment and the projector.</li> <li>● When turning the projector on, it takes about 30 seconds to display the image.</li> <li>● Check the system that you select is corresponding with the computer or the video equipment.</li> <li>● Make sure the temperature is not out of the Operating Temperature (5°C ~ 35°C).</li> </ul>  |
| <b>No sound.</b>  | <ul style="list-style-type: none"> <li>● Check audio cable connection from audio input source.</li> <li>● Adjust the audio source.</li> <li>● Press VOLUME (+) button.</li> <li>● Press MUTE button.</li> </ul>  |

| <b>Problem:</b>                               | <b>Try these Solution</b>  |
|---|--|
| <b>Remote Control Unit does not work.</b>     | <ul style="list-style-type: none"><li>● Check the batteries.</li><li>● Check the ALL-OFF switch on the Remote Control Unit is set to "ON."</li><li>● Make sure nothing is between the Remote Receiver and the Remote Control Unit.</li><li>● Make sure you are not too far from the projector when using the Remote Control Unit. Maximum operating range is 16.4' (5m).</li></ul> |
| <b>Wireless Mouse function does not work.</b> | <ul style="list-style-type: none"><li>● Check the cable connection between the projector and the computer.</li><li>● Check the mouse setting on your computer.</li><li>● Turn the projector on before you turn on the computer.</li></ul>  |

**WARNING :**

**High voltages are used to operate this projector. Do not attempt to open the cabinet.**

Boxlight Service is easily obtained. If after following instructions above, you find that service is necessary, contact Boxlight for assistance at 1-800-762-5757 or 360-779-7901.

Give the model number and explain the difficulty. We will advise you how to obtain service.

Please have the following information available.

- Serial No. of projector.
- Resolution of the computer.
- Refresh rate of computer.

# TECHNICAL SPECIFICATIONS

|   |  |
|---|--|
| <b>Projector Type</b>                   | Multi-media Projector  |
| <b>Dimensions (W x H x D)</b>           | 9.41" x 3.54" x 12.72" (239mm x 90mm x 323mm) (not including Adjustable Feet)  |
| <b>Net Weight</b>                       | 8.6 lbs (3.9 kg)   |
| <b>LCD Panel System</b>                 | 0.9" TFT Active Matrix type, 3 panels  |
| <b>Panel Resolution</b>                 | 800 x 600 dots   |
| <b>Number of Pixels</b>                 | 1,440,000 (800 x 600 x 3 panels)   |
| <b>Color System</b>                     | PAL, SECAM, NTSC, NTSC4.43, PAL-M and PAL-N  |
| <b>Scanning Frequency</b>               | H-sync. 15 ~ 80 KHz, V-sync. 50 ~ 100 Hz   |
| <b>Projection Image size (Diagonal)</b> | Adjustable from 30" to 300"  |
| <b>Horizontal Resolution</b>            | 750 TV lines   |
| <b>Projection Lens</b>                  | F 1.7 ~ 2.0 lens with f 33.2mm ~ 43.1mm Motor zoom and focus   |
| <b>Throw Distance</b>                   | 4.6' ~ 35.4' (1.4 m ~ 10.8 m)  |
| <b>Projection Lamp</b>                  | 150 W  |
| <b>AV Input Jacks</b>                   | RCA Type x 1 (Video, Audio R and L) and DIN 4 pin (S-Video) x 1  |
| <b>Computer Input Jacks</b>             | (VGA) HDB 15 Terminal x 1  |
| <b>Control Port Jack</b>                | DIN 8 pin x 1  |
| <b>Monitor Output Jack</b>              | (VGA) HDB 15 Terminal x 1  |
| <b>Computer Audio Input Jack</b>        | Mini Jack (stereo)   |
| <b>Audio Output Jack</b>                | Mini Jack (stereo)   |
| <b>Internal Audio Amp</b>               | 1W RMS (Monaural)  |
| <b>Built-in Speaker</b>                 | 1 speaker, 1.57" x 1.18" (40mm x 30mm)   |
| <b>Feet Adjustment</b>                  | 0° to 10°  |
| <b>Voltage</b>                          | AC 100 ~ 120 V / 200 - 240 V, 50 / 60 Hz   |
| <b>Power Consumption</b>                | 2.5 A / 1.4 A (Max. Ampere)  |
| <b>Operating Temperature</b>            | 41 °F ~ 95 °F (5 °C ~ 35 °C)   |
| <b>Storage Temperature</b>              | 14 °F ~ 140 °F (-10 °C ~ 60 °C)  |
| <b>Remote Control Transmitter</b>       | Power Source : AA Type x 2<br>Operating Range : 16.4' (5m) / ±30°<br>Dimensions : 2.2" x 1.3" x 7.6" (55mm x 34mm x 192mm)<br>Net Weight : 0.35 lbs (160 g) (including batteries)<br>Laser Pointer : Class II Laser (Max. Output : 1mW / Wave length : 650±20nm) |
| <b>Accessories</b>                      | Owner's Manual<br>AC Power Cord<br>Remote Control Transmitter and Batteries<br>VGA Cable<br>Control Cable for PS/2 port<br>Dust Cover<br>Lens Cover  |

- The specifications are subject to change without notice.



This symbol on the nameplate means the product is Listed by Underwriters Laboratories Inc. It is designed and manufactured to meet rigid U.L. safety standards against risk of fire, casualty and electrical hazards.

## LIMITED WARRANTY

BOXLIGHT CORPORATION ("BOXLIGHT") warrants that each Boxlight CP-11t ("the Product") sold hereunder will conform to and function in accordance with the written specifications of BOXLIGHT. Said limited warranty shall apply only to the first person or entity that purchases the Product for personal or business use and not for the purpose of distribution resale. Said warranty shall continue for a period of two (2) years from the date of such purchase. BOXLIGHT does not warrant that the Product will meet the specific requirements of the first person or entity that purchases the Product for personal or business use. Lamp is warranted for 120 days.

BOXLIGHT CORPORATION's liability for the breach of the foregoing limited warranty is limited to the repair or replacement of the Product or refund of the purchase price of the Product, at BOXLIGHT's sole option. To exercise the Purchaser's rights under the foregoing warranty, the Product must be returned at the Purchaser's sole cost and expense, to BOXLIGHT or any authorized service center provided, however, that the Product must be accompanied by a written letter explaining the problem and which includes (i) proof of purchase; (ii) the dealer's name; (iii) the model and serial number of the Product. A return authorization number, issued by the BOXLIGHT customer service department, must also be clearly displayed on the outside of the shipping carton containing the Product.

## WARRANTY LIMITATION AND EXCLUSION

BOXLIGHT CORPORATION shall have no further obligation under the foregoing limited warranty if the Product has been damaged due to abuse, misuse, neglect, accident, unusual physical or electrical stress, unauthorized modification, tampering, alterations, or service other than by BOXLIGHT or its authorized agents, causes other than from ordinary use or failure to properly use the Product in the application for which said Product is intended.

## DISCLAIMER OR UNSTATED WARRANTIES

The warranty printed above is the only warranty applicable to this purchase.

All other warranties express or implied, including, but not limited to, the implied warranties or merchantability and fitness for a particular purpose are disclaimed. There are no warranties that extend beyond the face of hereof and the foregoing warranty shall not be extended, altered or varied except by written instrument signed by BOXLIGHT CORPORATION.

## LIMITATION OR LIABILITY

It is understood and agreed that BOXLIGHT's liability whether in contract, in tort, under any warranty, in negligence or otherwise shall not exceed the return of the amount of the purchase price paid by purchaser and under no circumstances shall BOXLIGHT be liable for special, indirect or consequential damages. The price stated for the Product is a consideration in limiting BOXLIGHT's liability. No action regardless of form, arising out of the agreement to purchase the product, may be brought by purchaser more than one year after the cause of action has accrued.



Boxlight  
19332 Powder Hill Place  
Poulsbo, WA 98370-7407 USA  
[www.boxlight.com](http://www.boxlight.com)  
USA and Canada 800-762-5757  
International 360-779-7901