

*Allen-Bradley*

## Enhanced and Ethernet PLC-5 Programmable Controllers

1785-L11B, -L20B, -L30B, -L40B,  
-L40L, -L60B, -L60L, -L80B, -L20E,  
-L40E, -L80E, -L26B, -L46B, -L86B

User Manual

**Rockwell  
Automation**

## Important User Information

Solid state equipment has operational characteristics differing from those of electromechanical equipment. *Safety Guidelines for the Application, Installation and Maintenance of Solid State Controls* (Publication SGI-1.1 available from your local Rockwell Automation sales office or online at <http://www.ab.com/manuals/gi>) describes some important differences between solid state equipment and hard-wired electromechanical devices. Because of this difference, and also because of the wide variety of uses for solid state equipment, all persons responsible for applying this equipment must satisfy themselves that each intended application of this equipment is acceptable.

In no event will Rockwell Automation, Inc. be responsible or liable for indirect or consequential damages resulting from the use or application of this equipment.

The examples and diagrams in this manual are included solely for illustrative purposes. Because of the many variables and requirements associated with any particular installation, Rockwell Automation, Inc. cannot assume responsibility or liability for actual use based on the examples and diagrams.

No patent liability is assumed by Rockwell Automation, Inc. with respect to use of information, circuits, equipment, or software described in this manual.

Reproduction of the contents of this manual, in whole or in part, without written permission of Rockwell Automation, Inc. is prohibited.

Throughout this manual, when necessary we use notes to make you aware of safety considerations.

---

**WARNING**

Identifies information about practices or circumstances that can cause an explosion in a hazardous environment, which may lead to personal injury or death, property damage, or economic loss.

---

---

**IMPORTANT**

Identifies information that is critical for successful application and understanding of the product.

---

---

**ATTENTION**

Identifies information about practices or circumstances that can lead to personal injury or death, property damage, or economic loss. Attentions help you:

- identify a hazard
  - avoid a hazard
  - recognize the consequence
- 

---

**SHOCK HAZARD**

Labels may be located on or inside the equipment (e.g., drive or motor) to alert people that dangerous voltage may be present.

---

---

**BURN HAZARD**

Labels may be located on or inside the equipment (e.g., drive or motor) to alert people that surfaces may be dangerous temperatures.

---

## Summary of Changes

### Changes to this Manual

This user manual contains new and updated information.

The black revision bars, as shown on the left, indicate the changes. For specific locations of the new information, refer to the table below.

### Find the New Information

<b>This New and Updated Information</b>	<b>Is on Page</b>
Domain Name Service	11-15
User Provided Web Pages	11-16
Multihop Messaging over Ethernet	11-29
TCP/IP Communications	11-32
Additional Ethernet Diagnostics	11-35
Memory Card Diagnostics	B-12
Troubleshooting and Diagnostics	F-2

### Additional Ethernet PLC-5 Controller Enhancement

Ethernet PLC-5 controllers support use of the 1785-RC Relay Cartridge. The relay cartridge serves as an interface from the controller to a user-supplied external device such as an Allen-Bradley 700P relay. When the controller is in run mode, it monitors online ladder program edits and I/O forcing activity. When either of these is detected, the controller opens the relay on the relay cartridge for one second.

## Notes

<b>Preface</b>	Purpose of This Manual . . . . .	P-1
	Related PLC-5 Documentation . . . . .	P-1
	Terms Used in This Manual . . . . .	P-2
	Manual Overview . . . . .	P-3
	 <b>Chapter 1</b>	
<b>Understanding Your Programmable Controller</b>	Using This Chapter . . . . .	1-1
	Lay Out the System . . . . .	1-1
	Identifying Controller Components . . . . .	1-2
	PLC-5/11, -5/20, and -5/26 Controller Front Panels . . . . .	1-3
	PLC-5/40, -5/46, -5/60, -5/80, and -5/86 Controller Front Panel . . . . .	1-5
	PLC-5/20E Controller Front Panel . . . . .	1-6
	PLC-5/40E and -5/80E Controller Front Panels . . . . .	1-7
	PLC-5/40L and -5/60L Controller Front Panels . . . . .	1-8
	Programming Features . . . . .	1-10
	Using a Controller Channel as a Remote I/O Scanner . . . . .	1-11
	Using a Controller Channel as a Remote I/O Adapter . . . . .	1-12
	Using a PLC-5/40L, -5/60L Programmable Controller as an Extended-Local I/O Scanner . . . . .	1-14
	 <b>Chapter 2</b>	
<b>Selecting and Placing I/O</b>	Using This Chapter . . . . .	2-1
	Selecting I/O Modules . . . . .	2-1
	Guidelines for Selecting I/O Modules . . . . .	2-2
	Selecting I/O Module Density . . . . .	2-2
	Placing I/O Modules in a Chassis . . . . .	2-3
	 <b>Chapter 3</b>	
<b>Placing System Hardware</b>	Using This Chapter . . . . .	3-1
	Determining the Proper Environment . . . . .	3-1
	Protecting Your Controller . . . . .	3-3
	Preventing Electrostatic Discharge . . . . .	3-3
	Laying Out Your Cable Raceway . . . . .	3-4
	Categorize Conductors . . . . .	3-4
	Route Conductors . . . . .	3-4
	Laying Out Your Backpanel Spacing . . . . .	3-5
	Chassis Dimensions (Series B) . . . . .	3-5
	I/O Chassis and External Power Supply Dimensions . . . . .	3-6
	Grounding Your System . . . . .	3-6

---

	<b>Chapter 4</b>	
<b>Addressing I/O and Controller Memory</b>	Using This Chapter .....	4-1
	I/O Addressing Concept.....	4-1
	Choosing an Addressing Mode .....	4-3
	Addressing Block-Transfer Modules.....	4-7
	Addressing Summary.....	4-7
	Assigning Racks .....	4-8
	Understanding PLC-5 Controller Memory.....	4-10
	Understanding Data Storage (Data-Table Files) .....	4-11
	Addressing File Types .....	4-13
	Understanding Program-File Storage .....	4-15
	Addressing .....	4-16
	Specifying I/O Image Addresses .....	4-16
	Specifying Logical Addresses .....	4-17
	Specifying Indirect Addresses.....	4-18
	Specifying Indexed Addresses.....	4-20
	Specifying Symbolic Addresses.....	4-21
	Optimizing Instruction Execution Time and Controller Memory.....	4-22
Effectively Using I/O Memory.....	4-24	
	<b>Chapter 5</b>	
<b>Communicating with Controller-Resident I/O</b>	Using This Chapter .....	5-1
	Introduction to PLC-5 Controller Scanning.....	5-1
	Program Scanning .....	5-2
	Transferring Data to Controller-Resident I/O.....	5-3
	Transferring Discrete Data to Controller-Resident I/O .....	5-3
	Transferring Immediate I/O Requests.....	5-3
	Transferring Block-Transfer Data to Controller-Resident I/O ..	5-4
	Configuring the System for Controller-Resident I/O .....	5-4
	<b>Chapter 6</b>	
<b>Communicating with Remote I/O</b>	Using This Chapter .....	6-1
	Selecting Devices That You Can Connect .....	6-2
	Introduction to Remote I/O.....	6-3
	Designing a Remote I/O Link .....	6-4
	Configuring a Controller Channel as a Scanner .....	6-6
	Define an I/O Status File .....	6-7
	Specify Channel Configuration Information .....	6-7
	Specify the Scan List .....	6-9
	Communicating to a Remote I/O Node Adapter .....	6-11
	Troubleshooting Remote I/O Communication Difficulties...	6-12
	Transferring Block Data .....	6-13
Block-Transfers of Remote I/O Data .....	6-15	
Block-Transfer Sequence with Status Bits .....	6-17	

	Block-Transfer Programming Considerations . . . . .	6-19	
	General Considerations . . . . .	6-19	
	For Controller-Resident Local Racks . . . . .	6-20	
	Monitoring Remote I/O Scanner Channels . . . . .	6-21	
	Monitoring transmission retries . . . . .	6-21	
	Addressing the I/O Status File . . . . .	6-24	
	 <b>Chapter 7</b>		
<b>Communicating with a PLC-5 Adapter Channel</b>	Using This Chapter . . . . .	7-1	
	Configuring Communication to a PLC-5 Adapter Channel . . . . .	7-2	
	Specify an Adapter Channel's Communication Rate, Address, and Rack Size . . . . .	7-3	
	Specify the Discrete Transfer Configuration Files . . . . .	7-5	
	Programming Discrete Transfers in Adapter Mode . . . . .	7-10	
	Programming Block-Transfers of Data to an Adapter Channel . . . . .	7-10	
	Configure Block-Transfer Requests . . . . .	7-11	
	Examples of Block-Transfer Ladder Logic Effects of Programming Block-Transfers to an Adapter-Mode Controller Channel on Discrete Data Transfer . . . . .	7-15	
	Monitoring the Status of the Adapter Channel . . . . .	7-17	
	Monitoring the Status of the Supervisory Controller . . . . .	7-18	
	Monitoring Remote I/O Adapter Channels . . . . .	7-19	
		 <b>Chapter 8</b>	
	<b>Communicating with Extended-Local I/O</b>	Using This Chapter . . . . .	8-1
Selecting Devices That You Can Connect . . . . .		8-1	
Cabling . . . . .		8-2	
Addressing and Placing I/O . . . . .		8-2	
Transferring Data . . . . .		8-4	
Discrete Data Transfer . . . . .		8-5	
Transferring Block Data . . . . .		8-6	
Calculating Block-Transfer Completion Time . . . . .		8-7	
Considerations for Extended-local Racks . . . . .		8-8	
Configuring the Controller as an Extended-Local I/O Scanner . . . . .		8-9	
Monitoring Extended-Local I/O Status . . . . .		8-12	
	 <b>Chapter 9</b>		
<b>Communicating with Devices on a DH+ Link</b>	Using This Chapter . . . . .	9-1	
	Selecting Devices That You Can Connect . . . . .	9-1	
	Link Design . . . . .	9-2	
	Configuring the Channel for DH+ Communication . . . . .	9-3	
	Using the Global Status Flag File . . . . .	9-5	
	Monitoring DH+ Communication Channels . . . . .	9-7	
	Monitoring Data Sent with Acknowledgment . . . . .	9-8	
Monitoring Data Sent without Acknowledgment . . . . .	9-10		

Monitoring General Status ..... 9-11

Estimating DH+ Link Performance ..... 9-12

    Nodes ..... 9-13

    Size and Number of Messages ..... 9-13

    Message Destination ..... 9-14

    Internal Processing Time ..... 9-15

    Average DH+ Link Response Time Test Results ..... 9-16

Application Guidelines ..... 9-17

**Chapter 10**

**Communicating with Devices on a Serial Link**

Using This Chapter ..... 10-1

Choosing Between RS-232C, RS-422A, and RS-423 ..... 10-1

Configuring the Controller

Serial Port ..... 10-2

Using Channel 0 ..... 10-2

    User Mode ..... 10-2

    System Mode ..... 10-2

    Master Station to Remote Station Communication Methods .. 10-4

    Polling Inactive Priority Stations ..... 10-5

    Changing Modes ..... 10-5

Cabling ..... 10-5

Configuring Channel 0 ..... 10-6

    Configure Channel 0 for DF1 Point-to-Point ..... 10-6

    Configure Channel 0 as a Slave Station ..... 10-9

    Configure Channel 0 as a Master Station ..... 10-12

    Configure Channel 0 for User Mode (ASCII Protocol) ..... 10-18

    Configure Channel 0 for a Communication Mode Change... 10-21

Monitoring Channel 0 Status ..... 10-22

    Using the System Mode Status Display ..... 10-22

    Using the User Mode (ASCII) Status Display ..... 10-24

**Chapter 11**

**Communicating with Devices on an Ethernet Network**

Using This Chapter ..... 11-1

Media and Cabling ..... 11-1

Assigning Your IP Address ..... 11-2

Network Addressing ..... 11-2

Configuring Channel 2 for Ethernet Communication ..... 11-2

    Manually Configuring Channel 2 ..... 11-2

    Using BOOTP to Enter Configuration Information ..... 11-5

    Editing the BOOTPTAB Configuration File ..... 11-7

Using Advanced Ethernet Functions ..... 11-9

    Using Broadcast Addressing ..... 11-9

    Using Subnet Masks and Gateways ..... 11-11

    Manually Configuring Channel 2 for Controllers on Subnets. 11-12



	Using BOOTP to Configure Channel 2 for Controllers on Subnets .....	11-13
	Using Domain Name Service .....	11-15
	Using the Embedded Web Server .....	11-16
	Generating User Provided Web Pages .....	11-22
	Importing User Page Files to the PLC-5 Controller .....	11-26
	Using Multihop Messaging .....	11-29
	Multihop Examples .....	11-30
	Comparing Multihop and Non-Multihop Messages Over Ethernet .....	11-32
	Communicating with ControlLogix Devices .....	11-32
	TCP/IP .....	11-32
	Interpreting Error Codes .....	11-33
	Interpreting Ethernet Status Data .....	11-34
	Monitoring general Ethernet status .....	11-35
	Monitoring Ethernet commands .....	11-36
	Monitoring Ethernet replies .....	11-36
	Ethernet PLC-5 Performance Considerations .....	11-37
	Performance: Host to Ethernet PLC-5 Controller .....	11-37
	Performance: Ethernet PLC-5 Controller to Ethernet PLC-5 Controller .....	11-38
	 <b>Chapter 12</b>	
<b>Protecting Your Programs</b>	Using This Chapter .....	12-1
	About Passwords and Privileges .....	12-2
	Defining Privilege Classes .....	12-3
	Assigning a Privilege Class to a Channel or Offline File .....	12-4
	Assigning a Privilege Class to a Node .....	12-4
	Assigning Read/Write Privileges to a Program File .....	12-5
	Assigning Read/Write Privileges to a Data File .....	12-5
	 <b>Chapter 13</b>	
<b>Programming Considerations</b>	Using This Chapter .....	13-1
	Forcing .....	13-1
	Forcing Inputs and Outputs .....	13-1
	Forcing SFC Transitions .....	13-2
	Extended Forcing .....	13-2
	Increased Program Scan Time .....	13-4
	I/O Force Privileges .....	13-4
	Using Protected Controllers .....	13-5
	Using Selectable Timed Interrupts (STIs) and Controller Input Interrupts (PIIs) .....	13-5
	Setting Up and Using Extended Forcing .....	13-5
	Step 1 - Select Which Group of Data You Want to Force ....	13-6

	Step 2 - Use the Programming Software to Enter or Edit the Data You Want to Force in the Extended Force Configuration Table.....	13-7
	Step 3 - Use the Programming Software to Enter Force Values for the Specified Data Table Files .....	13-8
	Step 4 - Enable or Disable the Forces .....	13-8
	Using Extended Forcing with Time-Critical Applications.....	13-8
	Using Special Programming Routines.....	13-10
	Priority Scheduling for Interrupts and MCPs.....	13-11
	Program Execution States .....	13-12
	Influencing Priority Scheduling.....	13-14
	Defining and Programming Interrupt Routines.....	13-15
	<b>Chapter 14</b>	
<b>Preparing Power-Up Routines</b>	Using This Chapter .....	14-1
	Setting Power-Up Protection.....	14-1
	Allowing or Inhibiting Startup.....	14-2
	Defining a Controller Power-Up Procedure.....	14-2
	<b>Chapter 15</b>	
<b>Preparing Fault Routines</b>	Using This Chapter .....	15-1
	Understanding the Fault Routine Concept.....	15-1
	Responses to a Major Fault .....	15-1
	Understanding Controller-Detected Major Faults .....	15-2
	Fault in a Controller-Resident or Extended-Local I/O Rack ..	15-3
	Fault in a Remote I/O Chassis .....	15-3
	Defining a Fault Routine .....	15-4
	Defining a Watchdog Timer .....	15-5
	Avoiding Multiple Watchdog Faults.....	15-6
	Programming a Fault Routine .....	15-6
	Setting an Alarm.....	15-7
	Clearing a Major Fault .....	15-7
	Changing the Fault Routine from Ladder Logic .....	15-9
	Using Ladder Logic to Recover from a Fault.....	15-10
	Block-Transfers in Fault Routines .....	15-11
	Testing a Fault Routine .....	15-11
	Monitoring Faults.....	15-11
	Monitoring Major/Minor Faults and Fault Codes.....	15-12
	Interpreting Major Faults .....	15-12
	Interpreting Minor Faults .....	15-12
	Monitoring Status Bits.....	15-13

	<b>Chapter 16</b>	
<b>Using Main Control Programs</b>	Using This Chapter .....	16-1
	Selecting Main Control Programs .....	16-1
	Understanding How the Controller Interprets MCPs.....	16-2
	Configuring MCPs .....	16-3
	Monitoring MCPs .....	16-5
	<b>Chapter 17</b>	
<b>Using Selectable Timed Interrupts</b>	Using This Chapter .....	17-1
	Using a Selectable Timed Interrupt.....	17-1
	Writing STI Ladder Logic .....	17-1
	STI Application Example .....	17-2
	Block-Transfers in Selectable Timed Interrupts (STIs) .....	17-2
	Defining a Selectable Timed Interrupt .....	17-3
	Monitoring Selectable Timed Interrupts.....	17-4
	<b>Chapter 18</b>	
<b>Using Processor Input Interrupts</b>	Using This Chapter .....	18-1
	Using a Processor Input Interrupt.....	18-1
	Writing PII Ladder Logic .....	18-2
	PII Application Examples.....	18-2
	Block-Transfers in Processor Input Interrupts (PIIs) .....	18-3
	Design Considerations.....	18-4
	Defining a Controller Input Interrupt.....	18-5
	Monitoring Controller Input Interrupts .....	18-6
	<b>Appendix A</b>	
<b>System Specifications</b>	Controller Specifications .....	A-1
	Memory and Channel Specifications.....	A-2
	Memory Backup Devices.....	A-4
	EEPROM Compatibility.....	A-5
	<b>Appendix B</b>	
<b>Processor Status File</b>	.....	B-1
	S:0 - S:2.....	B-1
	S:3-10 .....	B-3
	S:11 .....	B-4
	S:12 .....	B-5
	S:13-S:24 .....	B-9
	S:26-S:35 .....	B-10
	S:36-S:78 .....	B-11
	S:79-S:127 .....	B-12

	<b>Appendix C</b>	
<b>Maximizing System Performance</b>	Using This Chapter .....	C-1
	Program Scan .....	C-1
	Effects of False Logic versus True Logic on Logic Scan Time..	C-2
	Effects of Different Input States on Logic Scan Time .....	C-2
	Effects of Different Instructions on Logic Scan Time .....	C-3
	Effects of Using Interrupts on Logic Scan Time .....	C-3
	Effects of Housekeeping Time .....	C-4
	Editing While in Remote Run Mode .....	C-4
	Putting Block-Transfer Modules in Controller-Resident Chassis	C-5
	Using Global Status Flag Files .....	C-5
	Calculating Throughput.....	C-5
	Input and Output Modules Delay .....	C-6
	I/O Backplane Transfer.....	C-6
	Remote I/O Scan Time.....	C-6
	Communication Rate.....	C-7
	Number of Rack Entries .....	C-7
	Block-Transfers .....	C-8
	Calculating Worst-Case Remote I/O Scan Time .....	C-9
	Optimizing Remote I/O Scan Time.....	C-9
	Controller Time .....	C-11
Example Calculation .....	C-12	
Performance Effects of Online Operations .....	C-12	
Effect of Inserting Ladder Rungs at the 56K-word Limit .....	C-13	
Using Program Control Instructions.....	C-14	
Using JMP/LBL Instructions .....	C-14	
Using FOR/NXT Instructions.....	C-14	
	<b>Appendix D</b>	
<b>Instruction Set Quick Reference</b>	Using This Chapter .....	D-1
	Relay Instructions .....	D-2
	Timer Instructions.....	D-3
	Counter Instructions .....	D-4
	Compare Instructions .....	D-5
	Compute Instructions .....	D-7
	Logical Instructions.....	D-14
	Conversion Instructions .....	D-15
	Bit Modify and Move Instructions .....	D-16
	File Instructions.....	D-17
	Diagnostic Instructions .....	D-19
	Shift Register Instructions.....	D-20
	Sequencer Instructions .....	D-21
	Program Control Instructions.....	D-22
	Process Control, Message Instructions.....	D-25
	Block Transfer Instructions.....	D-25

	ASCII Instructions .....	D-27
	Bit and Word Instructions.....	D-30
	File, Program Control, and ASCII Instructions.....	D-32
	<b>Appendix E</b>	
<b>Switch Setting Reference</b>	Using This Chapter .....	E-1
	Controller Switches .....	E-2
	Switch 1 .....	E-2
	Switch 2 .....	E-3
	I/O Chassis Backplane .....	E-4
	PLC-5 Controller in the I/O Chassis.....	E-4
	1771-ASB Remote I/O Adapter or 1771-ALX	
	Extended-Local I/O Adapter .....	E-5
	I/O Chassis Configuration Plug.....	E-6
	Remote I/O Adapter Module .....	E-7
	(1771-ASB Series C and D) without Complementary I/O .....	E-7
	(1771-ASB Series C and D) I/O Rack Number -	
	without Complementary I/O .....	E-8
	Extended-Local I/O Adapter Module .....	E-9
	(1771-ALX) Switch SW1.....	E-9
	(1771-ALX) Configuration Plug.....	E-10
	<b>Appendix F</b>	
<b>Troubleshooting</b>	Using This Chapter .....	F-1
	PLC-5 Controller .....	F-2
	General Problems .....	F-2
	Controller Communication Channel Troubleshooting .....	F-4
	Extended-Local I/O Troubleshooting.....	F-5
	Ethernet Status Indicator .....	F-5
	Ethernet Transmit LED .....	F-6
	Remote I/O System.....	F-6
	Troubleshooting Guide for the 1771-ASB Series C and D	
	Adapter Module.....	F-6
	Troubleshooting Guide for the 1771-ASB Series C and D	
	Adapter Module (continued).....	F-8
	Extended-Local I/O System .....	F-9
	Troubleshooting Guide for the 1771-ALX Adapter Module ...	F-9
	Unexpected Operation when Entering Run Mode.....	F-9
	Instructions with Unique Prescan Operations.....	F-10
	Suggested Action .....	F-11

	<b>Appendix G</b>	
<b>Cable Reference</b>	Using This Chapter .....	G-1
	Channel 0 Pin Assignments.....	G-1
	Serial Cable Pin Assignments.....	G-2
	Connecting Diagrams.....	G-3
	Programming Cable Specifications .....	G-5
	Ethernet Cable Connections .....	G-9
<b>Index</b>		

## Using This Manual

### Purpose of This Manual

The purpose of this manual is to help you design, operate and maintain an Enhanced and Ethernet PLC-5 programmable controller system. Use this manual to:

- determine the features of the controllers and how you use them
- design your PLC-5 system
- operate and maintain your PLC-5 system

### Related PLC-5 Documentation

The following documents contain additional information related to the procedures described in this document..

Publication Title	Publication Number
Industrial Automation Wiring and Grounding Guidelines	1770-4.1
PLC-5 Programmable Controller Instruction Set Reference	1785-6.1
Configuring Complementary I/O for PLC-5 Controllers	1785-6.8.3
Data Highway Cable Installation Manual	1770-6.2.2
SCADA System Selection Guide,	AG-SG001
PLC-5 Protected Controllers Product Data	1785-2.28
PLC-5 Protected Controller Supplement	1785-6.5.13
1771 Remote I/O Adapter Module User Manual	1771-UM001
ControlNet PLC-5 Programmable Controllers User Manual	1785-UM022

To get this documentation, you can either:

- view or download an electronic version from the internet at [www.rockwellautomation.com/literature](http://www.rockwellautomation.com/literature)
- contact your local distributor or Rockwell Automation representative to place an order

## Terms Used in This Manual

Become familiar with the following terms and definitions which are used throughout this manual.

Term	Definition
Block-transfer data	data transferred, in blocks of data up to 64 words, to/from a block-transfer I/O module (for example, an analog module)
Discrete-transfer data	data (words) transferred to/from a discrete I/O module
Enhanced PLC-5 controllers	<p>references PLC-5/11, -5/20, -5/26, -5/30, -5/40, -5/46, -5/40L, -5/46L, -5/60, -5/60L, -5/80, and -5/86 controllers</p> <p>PLC-5/26, -5/46, and -5/86 controllers are protected controllers. See the PLC-5 Protected Controllers Supplement, publication 1785-6.5.13</p> <p>This term also refers to the PLC-5/V30B, -5/V40B, -5/V40L, and -5/V80B controllers when applicable. See the PLC-5/VME VMEbus Programmable Controllers User Manual, publication 1785-6.5.9, for more information</p>
Ethernet	a local area network with a baseband communication rate of 10M bps designed for the high-speed exchange of information between computers and related devices
Ethernet PLC-5 controllers	references PLC-5/20E, -5/40E, and -5/80E controllers
Extended-local I/O	I/O connected to a controller across a parallel link to achieve higher throughput, thus limiting its distance from the controller
Extended local I/O link	a parallel link for carrying I/O data between a PLC-5/40L or -5/60L controller and extended-local I/O adapters
PLC-5 controller	used to generically reference Enhanced PLC-5 and Ethernet PLC-5 controllers <b>in this manual only</b>
Controller-resident local I/O chassis	the I/O chassis in which the PLC-5 controller is installed
Remote I/O link	a serial communication link between a PLC-5 controller port in scanner mode and an adapter as well as I/O modules that are located remotely from the PLC-5 controller
Remote I/O chassis	the hardware enclosure that contains an adapter and I/O modules that are located remotely on a serial communication link to a PLC-5 controller in scanner mode



## Manual Overview

This manual has three main sections:

- Design
- Operate
- Maintain

Section:	For information about:	See	Title:
Design	An overview of the PLC-5 controllers' capabilities and keyswitch	Chapter 1	Understanding Your Controller
	Guidelines for selecting and placing I/O modules	Chapter 2	Selecting and Placing I/O
	The proper environment for your PLC-5 system	Chapter 3	Placing System Hardware
	Choosing addressing mode, assigning rack numbers, and understanding PLC-5 memory	Chapter 4	Addressing I/O and Controller Memory
Operate	Configuring the controller for controller-resident I/O, transferring data, and monitoring status	Chapter 5	Communicating with Controller-Resident I/O
	Configuring a system for remote I/O communication, designing a remote I/O link, transferring data, and monitoring status	Chapter 6	Communicating with Remote I/O
	Configuring a PLC-5 adapter channel, transferring data, and monitoring status	Chapter 7	Communicating with a PLC-5 Adapter Channel
	<b>For PLC-5/40L, -5/46L, and -5/60L Controllers only:</b> Configuring an extended-local I/O system, transferring data, and monitoring status	Chapter 8	Communicating with Extended-Local I/O
	Configuring a system for Data Highway Plus™ and monitoring channel status	Chapter 9	Communicating with Devices on a DH+ Link
	Configuring a system for serial communications and monitoring channel status	Chapter 10	Communicating with Devices on a Serial Link
	<b>For PLC-5/20E, -5/40E, and -5/80E Controllers only:</b> Configuring a system for Ethernet communications and monitoring channel status	Chapter 11	Communicating with Devices on an Ethernet Network
	Assigning passwords and privileges	Chapter 12	Protecting Your Programs
	PLC-5 programming feature overview	Chapter 13	Programming Considerations
	Defining power-up procedure	Chapter 14	Preparing Power-Up Routines
Maintain	Defining, programming, and monitoring fault routines	Chapter 15	Preparing Fault Routines
	Configuring and monitoring main control programs	Chapter 16	Using Main Control Programs
	Using, defining, and monitoring selectable timed interrupts	Chapter 17	Using Selectable Timed Interrupts
	Using, defining, and monitoring Controller input interrupts	Chapter 18	Using Controller Input Interrupts
	System specifications	Appendix A	System Specifications
	Listing of the controller status file words and meaning	Appendix B	Controller Status File
	General and specific performance considerations	Appendix C	Maximizing System Performance
	Guide to ladder instructions and execution times	Appendix D	Instruction Set Quick Reference
	How to set system switches	Appendix E	Switch Setting Reference
	Potential problems and recommended solutions	Appendix F	Troubleshooting
Guidelines for choosing and making cables	Appendix G	Cable Reference	

## Notes

# Understanding Your Programmable Controller

## Using This Chapter

For Information About	Go to Page
Lay Out the System	1-1
Identifying controller components	1-2
Programming features	1-10
Using a controller channel as a remote I/O scanner	1-11
Using a controller channel as a remote I/O adapter	1-12
Using a PLC-5/40L, -5/60L programmable controller as an extended-local I/O scanner	1-14

## Lay Out the System

Lay out the system by determining the network configuration and the placement of components in each location. Decide at this time whether each location will have its own controller.

Place each controller's I/O on an isolated network to maximize the performance and to more easily accommodate future network or system configuration changes. If you plan to share I/O, make sure the I/O is on a network that each controller can access.

Assume that Network A and Network B both require a controller and its I/O. Both controllers interact with time critical information.

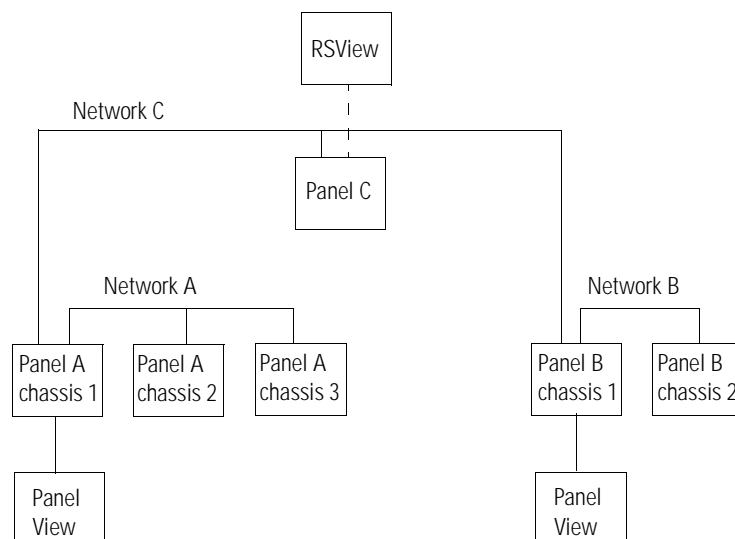

For a PLC-5 controller to control I/O modules, both the controller and the I/O modules must be directly attached to the same network.

I/O Location	Controller in Panel A, chassis 1	Controller in Panel B, chassis 1
Panel A, chassis 1	yes	yes
Panel A, chassis 2	yes	no
Panel A, chassis 3	yes	no
Panel B, chassis 1	yes	yes
Panel B, chassis 2	no	yes
Panel C, chassis 1	yes	yes

Evaluate what communications need to occur between controllers. If there is sporadic information that is not time-critical, use a message-based network such as an EtherNet/IP (the information portion) or Data Highway Plus™.

## Identifying Controller Components

To become familiar with the controller's front panels, use these figures:

For the Front Panels Of	Page
PLC-5/11, -5/20 and -5/26 controllers	1-3
PLC-5/30 controllers	1-4
PLC-5/40, -5/46, -5/60, -5/80 and -5/86 controllers	1-5
PLC-5/20E controllers	1-6
PLC-5/40E and -5/80E controllers	1-7
PLC-5/40L and -5/60L controllers	1-8

PLC-5/11, -5/20, and -5/26 Controller Front Panels

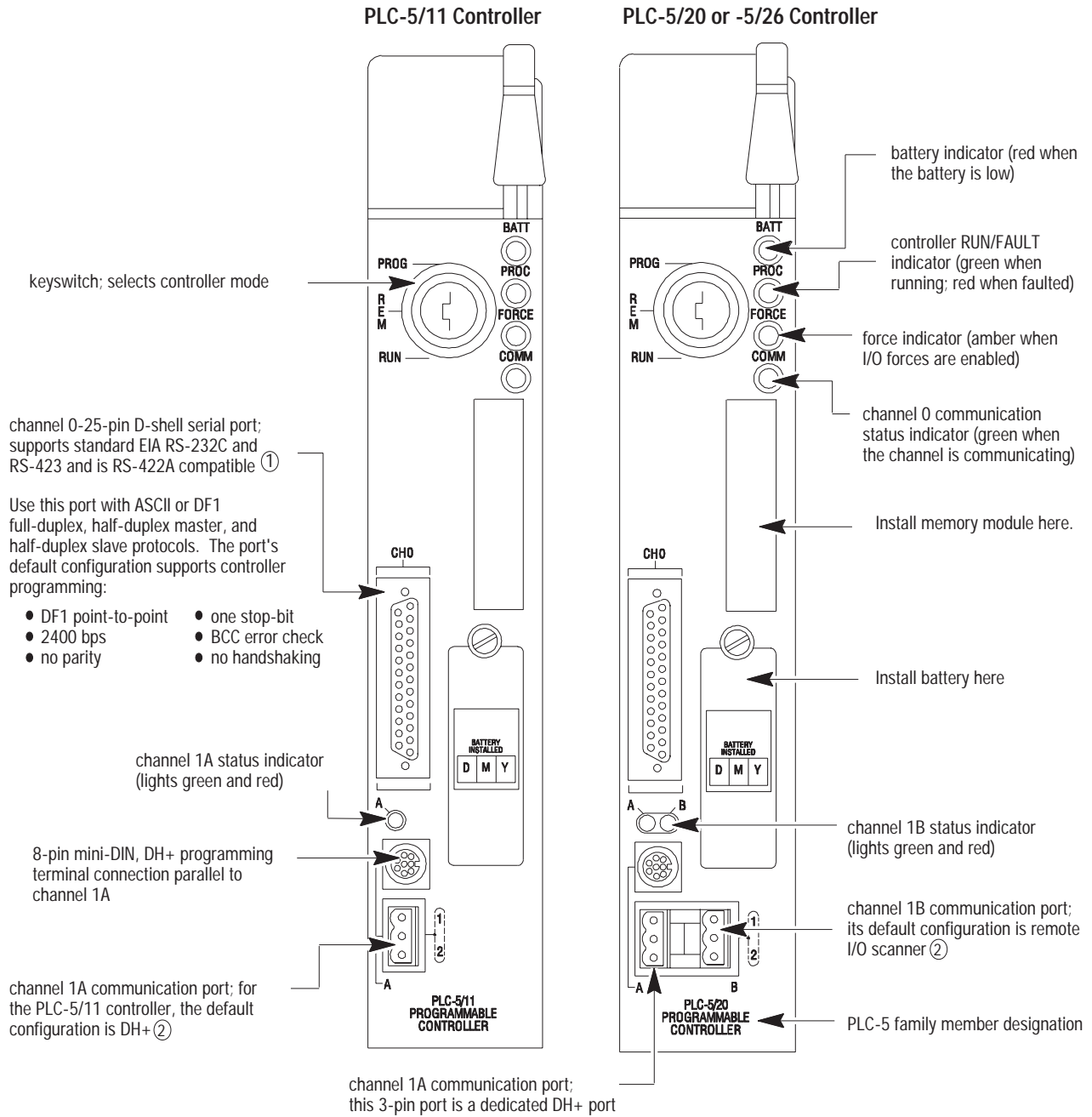

① Channel 0 is optically-coupled (provides high electrical noise immunity) and can be used with most RS-422A equipment as long as:

- termination resistors are not used
- the distance and transmission rate are reduced to comply with RS-423 requirements

② Configure these 3-pin ports for:

- remote I/O scanner
- remote I/O adapter,
- DH+ communication
- unused

PLC-5/30 Controller Front Panel

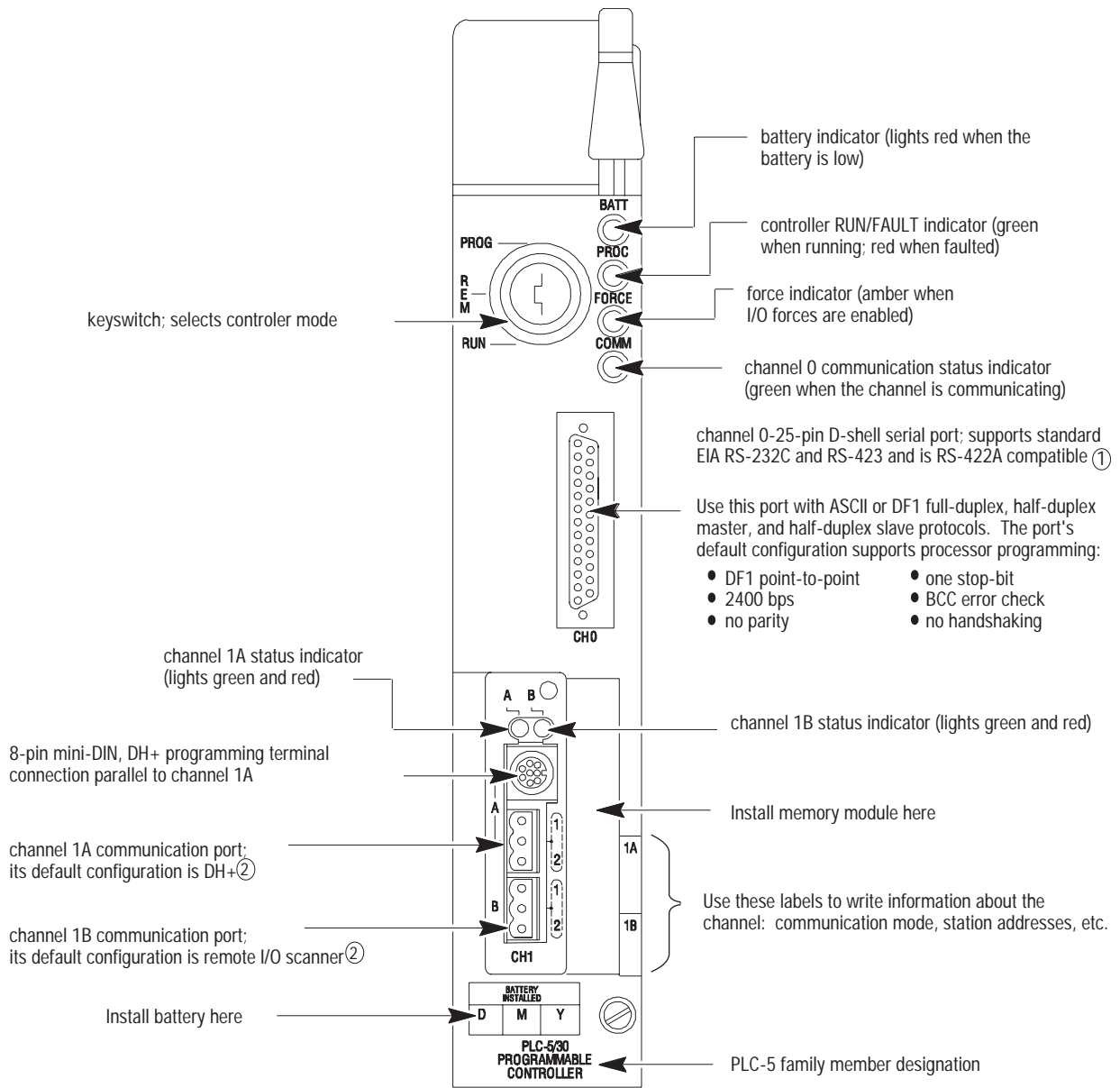

- ① Channel 0 is optically-coupled (provides high electrical noise immunity) and can be used with most RS-422 equipment as long as:
- termination resistors are not used
  - the distance and transmission rate are reduced to comply with RS-423 requirements
- ② Configure these 3-pin ports for:
- remote I/O scanner,
  - remote I/O adapter,
  - DH+ communication
  - unused

PLC-5/40, -5/46, -5/60, -5/80, and -5/86 Controller Front Panel

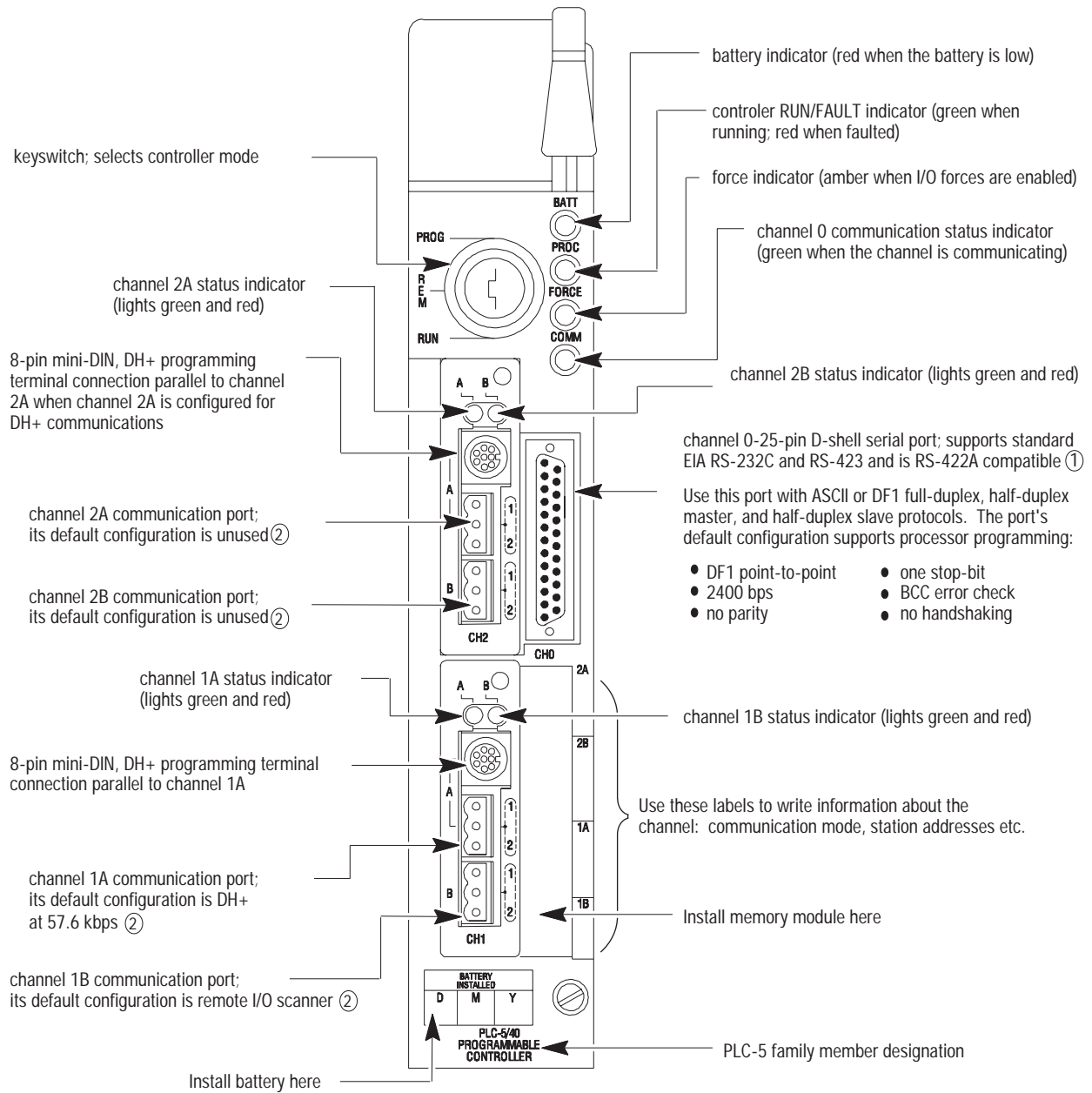

① Channel 0 is optically-coupled (provides high electrical noise immunity) and can be used with most RS-422A equipment as long as:

- termination resistors are not used
- the distance and transmission rate are reduced to comply with RS-423 requirements

② Configure these 3-pin ports for:

- remote I/O scanner,
- remote I/O adapter,
- DH+ communication
- unused

PLC-5/20E Controller Front Panel

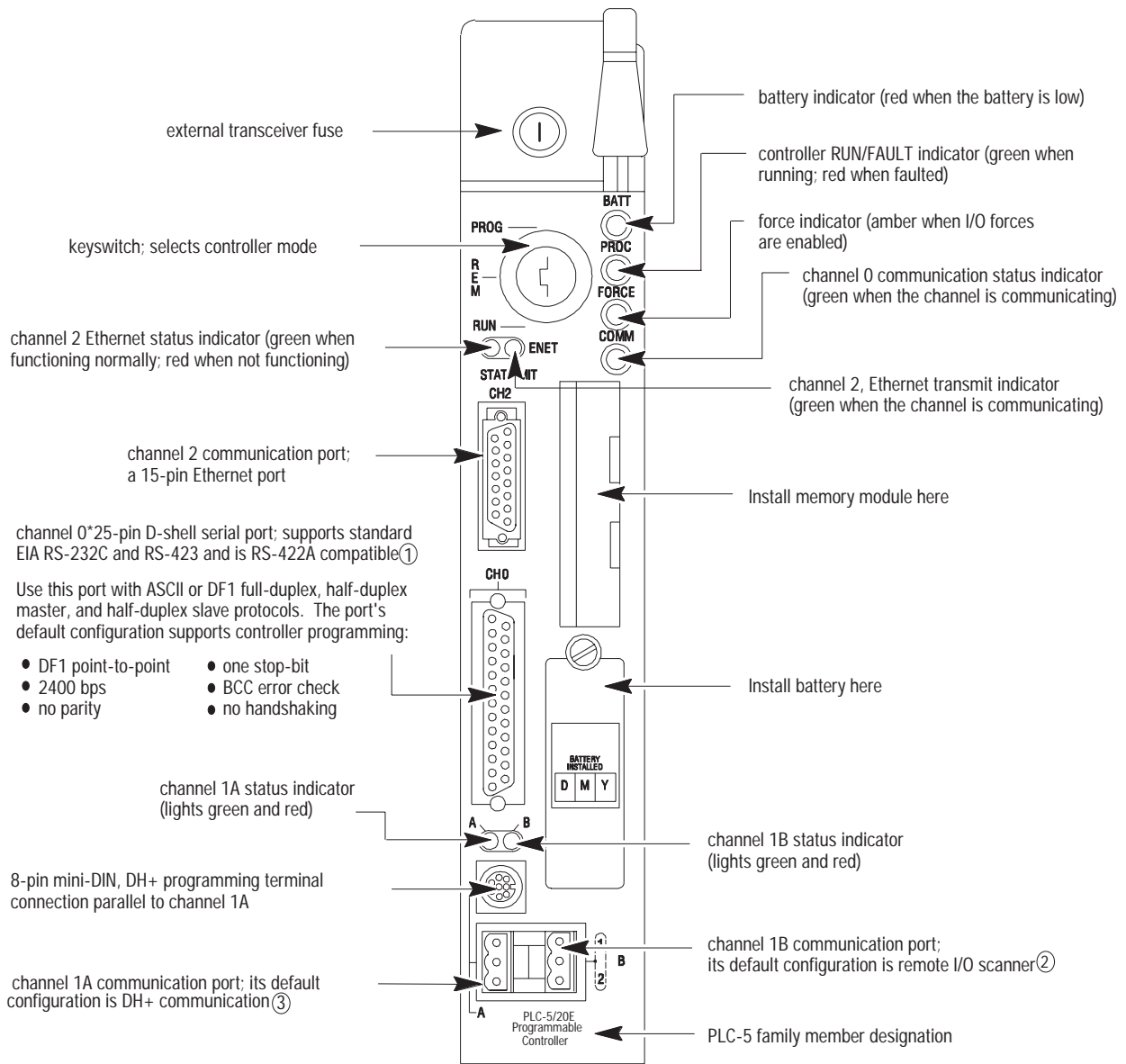

① Channel 0 is optically-coupled (provides high electrical noise immunity) and can be used with most RS-422A equipment as long as:

- termination resistors are not used
- the distance and transmission rate are reduced to comply with RS-423 requirements

② Configure these 3-pin ports for:

- remote I/O scanner
- remote I/O adapter
- DH+ communication
- unused

③ Configure this 3-pin port for:

- remote I/O adapter
- DH+ communication



PLC-5/40E and -5/80E Controller Front Panels

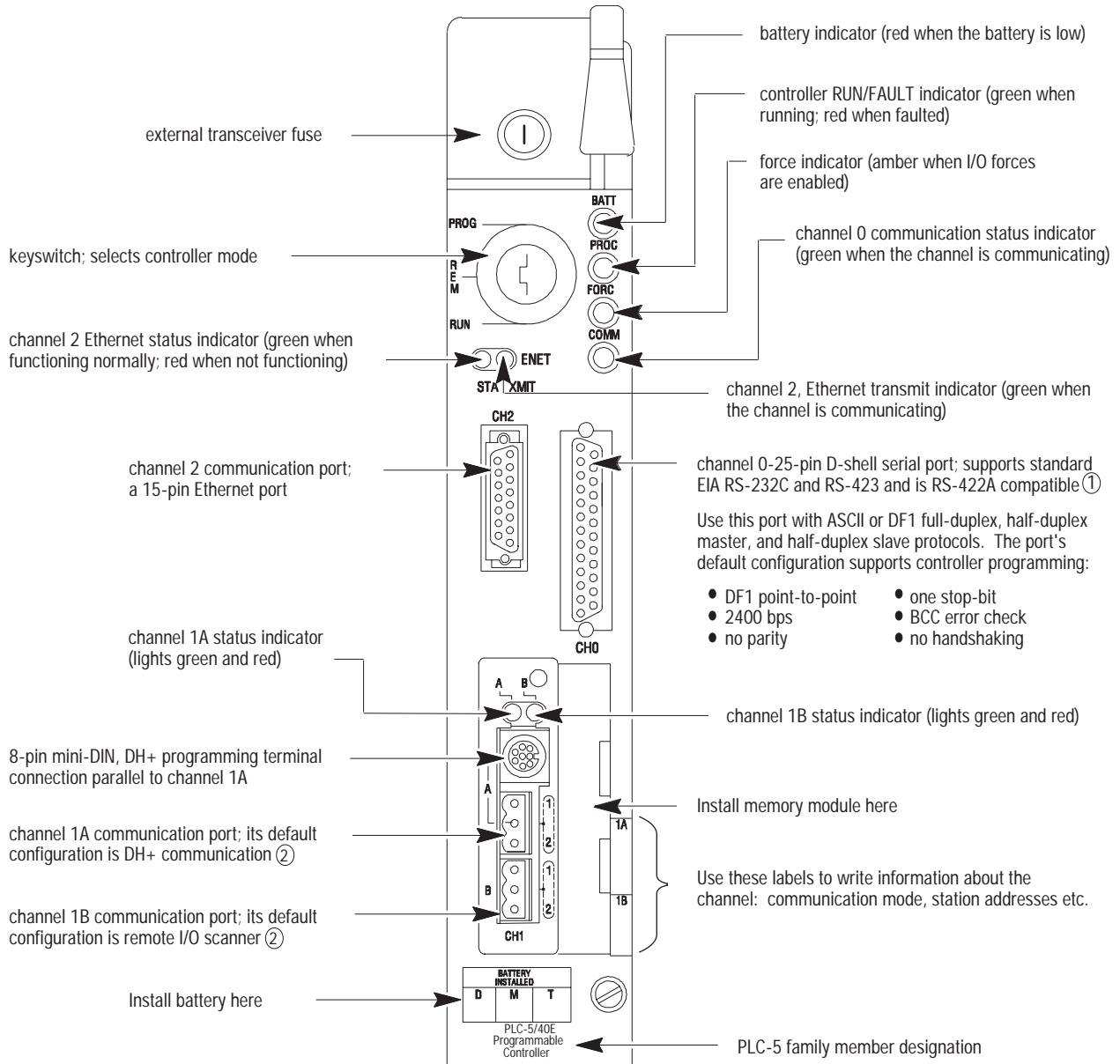

① Channel 0 is optically-coupled (provides high electrical noise immunity) and can be used with most RS-422A equipment as long as:

- termination resistors are not used
- the distance and transmission rate are reduced to comply with RS-423 requirements

② Configure these 3-pin ports for:

- remote I/O scanner
- remote I/O adapter
- DH+ communication
- unused

PLC-5/40L and -5/60L Controller Front Panels

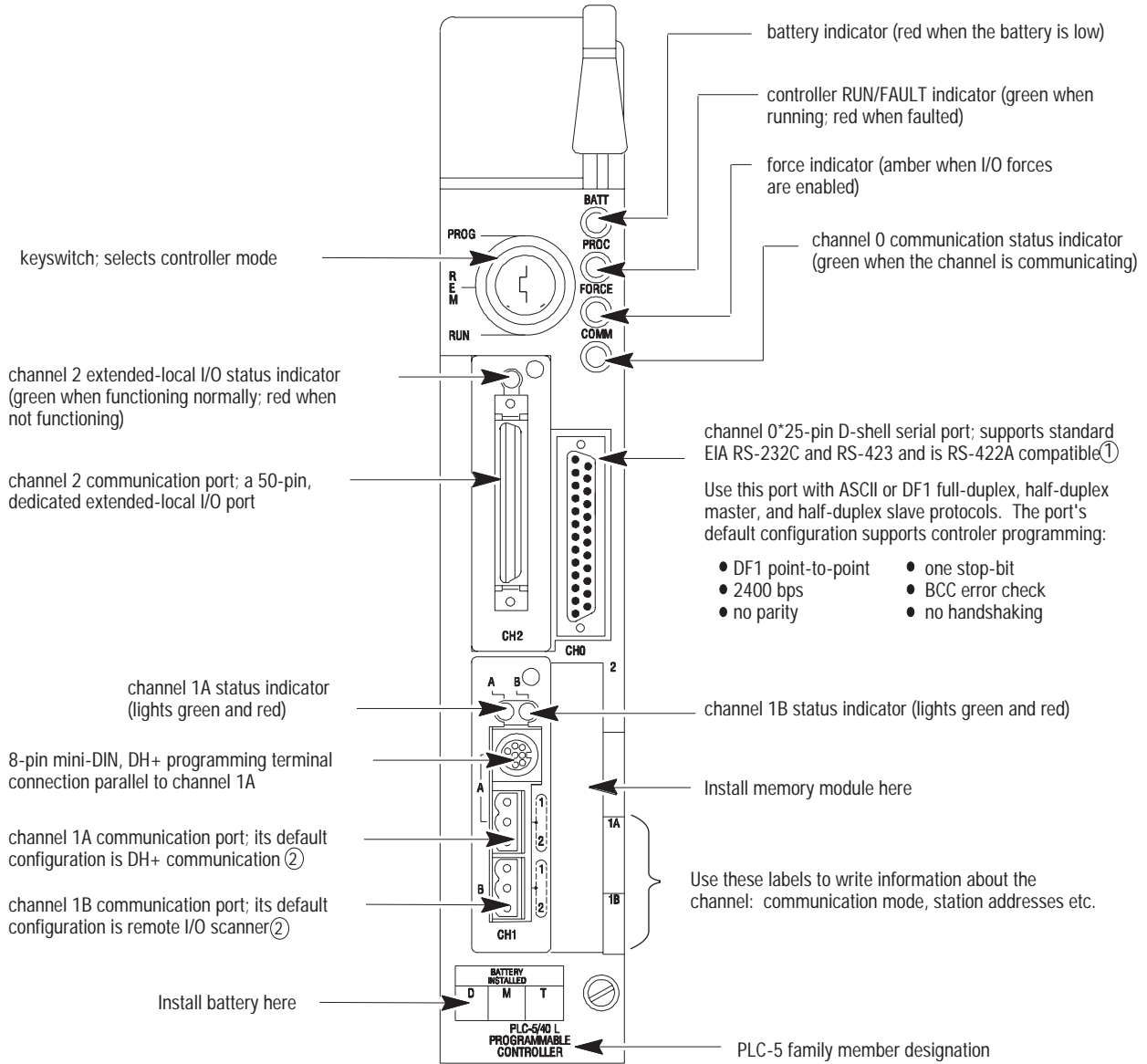

① Channel 0 is optically-coupled (provides high electrical noise immunity) and can be used with most RS-422A equipment as long as:

- termination resistors are not used
- the distance and transmission rate are reduced to comply with RS-423 requirements

② Configure these 3-pin ports for:

- remote I/O scanner,
- remote I/O adapter,
- DH+ communication
- unused

**Use the keyswitch to change the mode in which a controller is operating.**

**If You Want to**

**Turn the Keyswitch to**

- Run your program. Outputs are enabled. (Equipment being controlled by the I/O addressed in the ladder program begins operation.)
- Force I/O.
- Save your programs to a disk drive (during operation).
- Enable outputs.
- Edit data table values.

RUN

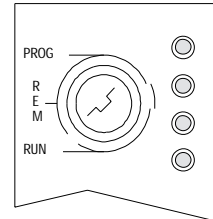

**Notes:**

- You cannot create or delete a program file, create or delete data files, edit online, or change the modes of operation through the programming software while in run mode.
- You can prevent forcing and data table changes by using RSLogix5 programming software to set user control bit S:26/6.

- Disable outputs (outputs are turned off).
- Create, modify, and delete ladder files, SFC files, or data files.
- Download to/from a memory module.
- Save/restore programs.

**Notes:**

- The controller does not scan the program.
- You cannot change the mode of operation through the programming software while in program mode.

PROG (program)

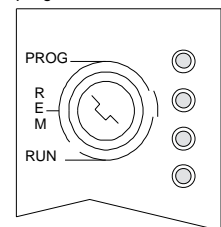

Change between remote program, remote test, and remote run modes through the programming software.

REM (remote)

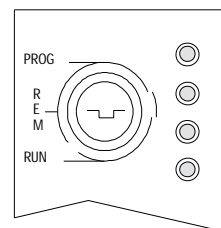

**Remote run**

- Enable outputs.
- Save/restore programs.
- Edit while operating.

**Remote program**

See the program-mode description above.

**Remote test**

- Execute ladder programs with outputs disabled.
- *Cannot* create or delete ladder programs or data files.
- Save/restore programs.
- Edit while operating.

## Programming Features

This table highlights the programming features of a PLC-5 programmable controller.

This Capability	Lets You
Ladder logic	<p>program using a language that is representative of relay logic.</p> <p>Choose this language</p> <ul style="list-style-type: none"> <li>• if you are more familiar with ladder logic than with programming languages such as BASIC Your plant personnel may be more familiar with ladder logic; consider their needs as well.</li> <li>• performing diagnostics</li> <li>• programming discrete control</li> </ul>
Subroutines	<p>store recurring sections of program logic that can be accessed from multiple program files.</p> <p>A subroutine saves memory because you program repetitive logic only once. The JSR instruction directs the controller to go to a separate subroutine file within the logic controller, scan that subroutine file once, and return to the point of departure.</p>
Sequential Function Charts (SFCs)	<p>use sequence-control language to control and display the state of a sequential process.</p> <p>Instead of using one long ladder program for your application, divide the logic into steps and transitions. A step corresponds to a control task; a transition corresponds to a condition that must occur before the programmable controller can perform the next control task. The display of these steps and transitions lets you see what state the machine process is in at a given time via a flowchart form.</p> <p>SFCs offer constructs that enable execution of multiple paths of logic, or a single selected path of logic, as well as the ability to jump forwards and backwards.</p> <p>Troubleshooting can be reduced to a small routine of logic instead of an entire ladder file.</p> <p>SFCs are best for defining the order of events in a sequential process.</p>
Structured text	<p>program using a language similar to BASIC.</p> <p>Choose structured text if you are:</p> <ul style="list-style-type: none"> <li>• more familiar with programming languages such as BASIC than with ladder logic</li> <li>• using complex mathematical algorithms</li> <li>• using program constructs that repeat or "loop"</li> <li>• creating custom data-table monitoring screens</li> </ul>
Main Control Programs (MCPs)	<p>separate sequential logic from ladder logic and structured text as a way of modularized your process and making troubleshooting easier.</p> <p>Use several main control programs (MCPs) to define one main control program for each particular machine or function of your process. MCPs accommodate independent or non-sequential activities.</p> <p>A main control program can be an SFC file numbered 1-999 or a ladder-logic file or structured-text program numbered 2-999.</p> <p>One data table is used by all MCPs (i.e., you do not have a separate data table for each MCP).</p>

## Using a Controller Channel as a Remote I/O Scanner

Configure a remote I/O channel for scanner mode to read and write I/O information between a controller and an I/O device remotely located from the controller.

A controller with a channel configured for scanner mode acts as a supervisory controller for other controllers that are in adapter mode as well as remote I/O adapter modules. The scanner-mode PLC-5 controller can:

- gather data from node adapter devices in remote I/O racks
- process I/O data from 8-, 16-, or 32-point I/O modules
- address I/O in 2-, 1-, or 1/2-slot I/O groups
- support a complementary I/O configuration
- support block-transfer in any I/O chassis

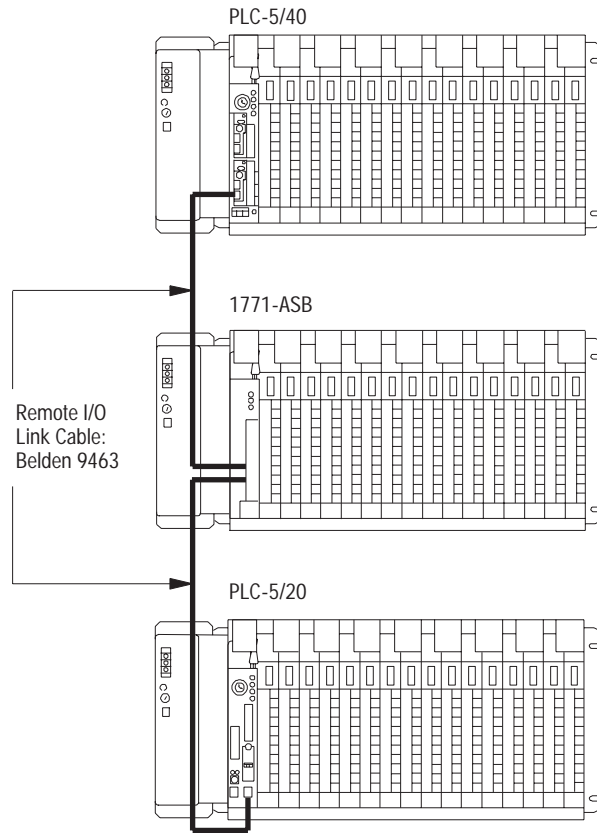

The scanner-mode PLC-5 controller:

- transfers discrete data and block-transfer data to/from modules in remote I/O racks as well as to/from controllers in adapter mode.
- scans **remote I/O buffers** asynchronously to the program scan.
- updates the **input/output image data table** from the remote I/O buffer(s) synchronously to the program scan

PLC-5 data table is updated synchronously to program scan (at housekeeping).

Remote I/O buffers are updated asynchronously to the program scan.

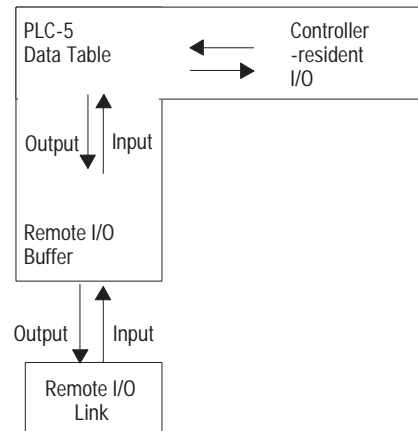

**A controller transfers I/O data and status data using:**

- discrete transfers data transfers of 8 words per rack occur automatically on the remote I/O network
- block-transfers special data transfers that require ladder logic instructions to achieve the transfer
  - allow a transfer of a maximum of 64 words of data
  - also used to communicate information between a scanner channel and an adapter-mode controller channel

**Using a Controller Channel as a Remote I/O Adapter**

Configure a controller channel for adapter mode when you need predictable, real-time exchange of data between a distributed control adapter-mode controller channel and a supervisory controller. The remote I/O adapter channel exchanges data with a supervisory controller.

In this example, a PLC-5/40 controller channel is the supervisory (scanner-mode) controller of the 1771-ASB module and the PLC-5/20 controller.

Connect the controllers via the remote I/O link.

You can monitor status between the supervisory controller and the adapter-mode PLC-5 controller channel at a consistent rate (i.e., the transmission rate of the remote I/O link is unaffected by programming terminals and other non-control-related communications).

The adapter-mode PLC-5 controller can monitor and control its controller-resident local I/O while communicating with the supervisory controller via a remote I/O link.

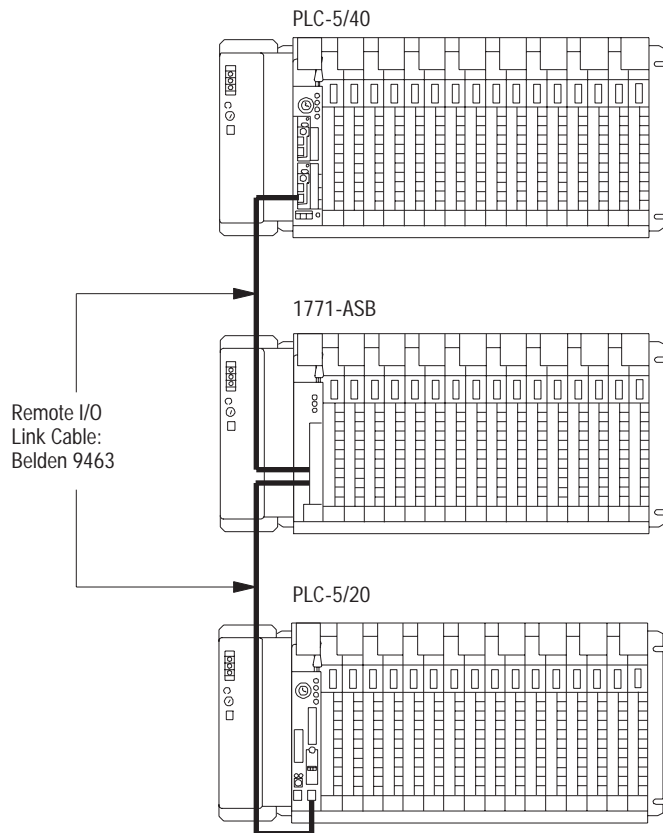

For Enhanced and Ethernet programmable controller channels in adapter mode, you do not need ladder logic in the adapter controller for block-transfer instructions. You define the block-transfers via an adapter configuration screen and by defining block-transfer files.

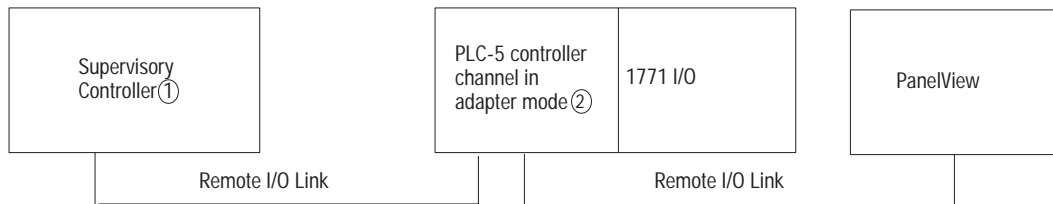

① The following programmable controllers can operate as supervisory controllers:

PLC-2/20 and PLC-2/30 controllers

PLC-3 and PLC-3/10 controllers

PLC-5/15 and PLC-5/25E controllers

All Enhanced and Ethernet PLC-5 controllers; separate channels can be configured for a remote I/O scanner and an adapter

PLC-5/V30, PLC-5/V40, PLC-5/V40L, and PLC-5/V80 controllers

PLC-5/250 controllers

② All PLC-5 family controllers, except the PLC-5/10, can operate as remote I/O adapter modules

## Using a PLC-5/40L, -5/60L Programmable Controller as an Extended-Local I/O Scanner

Use the extended-local I/O link when you need I/O updates more quickly than is possible from remote I/O link. An extended-local I/O link provides faster scan and update time than a remote I/O link. The extended-local I/O link is limited to 30.5 cable-m (100 cable-ft). If an I/O chassis is located more than 30.5m from the controller, you must use a remote I/O link.

A PLC-5/40L or -5/60L controller (channel 2) and an extended-local I/O adapter module (1771-ALX) form an extended-local I/O link.

The extended-local I/O link is a parallel link that enables a PLC-5/40L or -5/60L controller to scan a maximum of 16 extended-local I/O chassis.

Due to the cabling design, you can remove an adapter module from a chassis on the extended-local I/O link without disrupting communication to other chassis on the extended-local I/O link.

Important: The PLC-5/40L and -5/60L controllers cannot be used as extended-local I/O adapters.

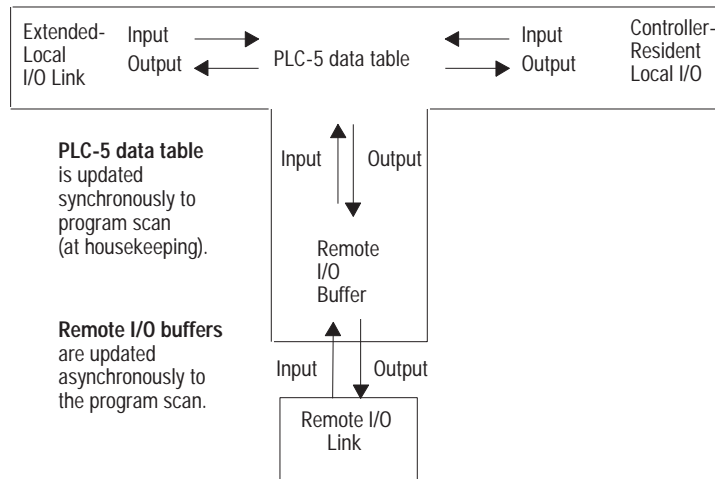
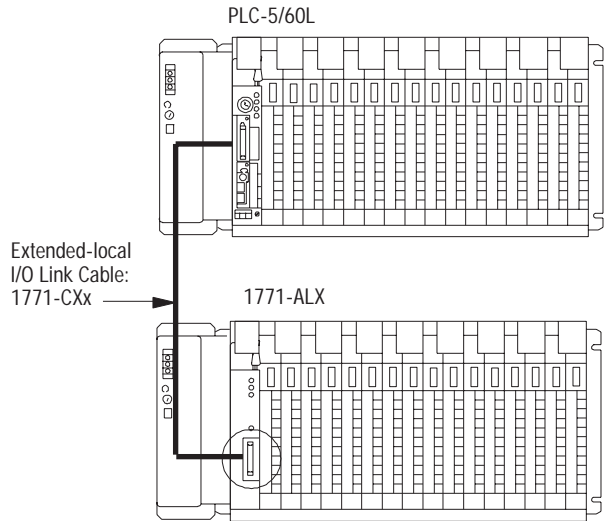



---

## Selecting and Placing I/O

### Using This Chapter

<b>For Information About</b>	<b>Go to Page</b>
Selecting I/O modules	2-1
Selecting I/O module density	2-2
Placing I/O modules in a chassis	2-3

### Selecting I/O Modules

Select I/O modules to interface your PLC-5 controller with machines or processes that you determine while analyzing your plant operation.

Use the following list and table as guidelines for selecting I/O modules and operator control interface(s).

- How much I/O is required to control your process(es)?
- Where will you concentrate I/O points for portions of an entire process when the entire process is distributed over a large physical area?
- What type of I/O is required to control your process(es)?
- What is the required voltage range for each I/O module?
- What is the backplane current required for each I/O module?
- What are the noise and distance limitations for each I/O module?
- What isolation is required for each I/O module?

### Guidelines for Selecting I/O Modules

Choose this Type of I/O Module	For these Types of Field Devices or Operations (examples)	Explanation
Discrete input module and block I/O module	Selector switches, pushbuttons, photoelectric eyes, limit switches, circuit breakers, proximity switches, level switches, motor starter contacts, relay contacts, thumbwheel switches	Input modules sense on/off or opened/closed signals. Discrete signals can be either ac or dc.
Discrete output module and block I/O module	Alarms, control relays, fans, lights, horns, valves, motor starter, or solenoids	Output module signals interface with on/off or opened/closed devices. Discrete signals can be either ac or dc.
Analog input module	Temperature transducers, pressure transducers, load cell transducers, humidity transducers, flow transducers, and potentiometers	Convert continuous analog signals into input values for the PLC controller.
Analog output module	Analog valves, actuators, chart recorders, electric motor drives, analog meters	Interpret PLC controller output to analog signals (generally through transducers) for field devices.
Specialty I/O modules	Encoders, flow meters, I/O communication, ASCII, RF type devices, weigh scales, bar-code readers, tag readers, display devices	Are generally used for specific applications such as position control, PID, and external device communication.

## Selecting I/O Module Density

The density of an I/O module is the number of controller input or output image-table bits to which it corresponds. A bidirectional module with 8 input bits and 8 output bits has a density of 8. I/O module density helps determine your I/O addressing scheme. See chapter 4 for more information about I/O addressing.

Use these guidelines for selecting I/O module density:

#### Choose this I/O Density If You

8-point I/O module	<ul style="list-style-type: none"> <li>• currently use 8-point modules</li> <li>• need integral, separately-fused outputs</li> <li>• want to minimize cost per module</li> </ul>
16-point I/O module	<ul style="list-style-type: none"> <li>• currently use 16-point modules</li> <li>• need separately-fused outputs with a special wiring arm</li> </ul>
32-point I/O module	<ul style="list-style-type: none"> <li>• currently use 32-point modules</li> <li>• want to minimize number of modules</li> <li>• want to minimize the space required for I/O chassis</li> <li>• want to minimize cost per I/O point</li> </ul>

## Placing I/O Modules in a Chassis

Place I/O modules in a chassis depending on the electrical characteristics of the module. The placement is made left to right, with the left-most position being closest in the chassis to the PLC-5 controller or the I/O adapter module. The placement order is as follows:

Module placement priority:

1. block-transfer modules (all types)
2. dc input modules
3. dc output modules
4. ac input modules
5. ac output modules

Priority: 1 1 2 2 3 3 4 4 5 5

P L C / A S B	Block Transfer	Block Transfer	dc input	dc input	dc output	dc output	ac input	ac input	ac output	ac output	empty
---------------------------------	----------------	----------------	----------	----------	-----------	-----------	----------	----------	-----------	-----------	-------

lowV

highV

Place block-transfer modules according to these guidelines:

- Place as many modules as possible for which you need fast block-transfer times in your controller-resident local I/O chassis.
- Place modules in which block-transfer timing is not as critical in remote I/O chassis.
- Ac output modules should always be the furthest I/O modules away from any block-transfer modules in the same chassis.

Place input and output modules according to these guidelines:

- left to right
- lowest voltage to highest voltage

For optimal speed using discrete I/O, use the following module-placement priority scheme:

1. controller chassis
2. extended-local I/O chassis
3. remote I/O chassis

## Notes

## Placing System Hardware

### Using This Chapter

For Information About	Go to Page
Determining the proper environment	3-1
Protecting your controller	3-3
Avoiding electrostatic damage	3-3
Laying out your cable raceway	3-4
Laying out your backpanel spacing	3-5
Grounding your system	3-6

### Determining the Proper Environment

Place the controller in an environment with conditions that fall within these guidelines:

Environmental Condition	Acceptable Range
Operating temperature	0 to 60° C (32 to 140° F)
Storage temperature	-40 to 85° C (-40 to 185° F)
Relative humidity	5 to 95% (without condensation)

Separate your programmable controller system from other equipment and plant walls to allow for convection cooling. Convection cooling draws a vertical column of air upward over the controller. This cooling air must not exceed 60° C (140° F) at any point immediately below the controller. If the air temperature exceeds 60° C, install fans that bring in filtered air or recirculate internal air inside the enclosure, or install air-conditioning/heat-exchanger units.

To allow for proper convection cooling in enclosures containing a controller-resident chassis and remote I/O chassis, follow these guidelines.

**Minimum spacing requirements for a controller-resident chassis:**

- Mount the I/O chassis horizontally.
- Allow 153 mm (6 in) above and below the chassis.
- Allow 102 mm (4 in) on the sides of each chassis.
- Allow 51 mm (2 in) vertically and horizontally between any chassis and the wiring duct or terminal strips.
- Leave any excess space at the top of the enclosure, where the temperature is the highest.

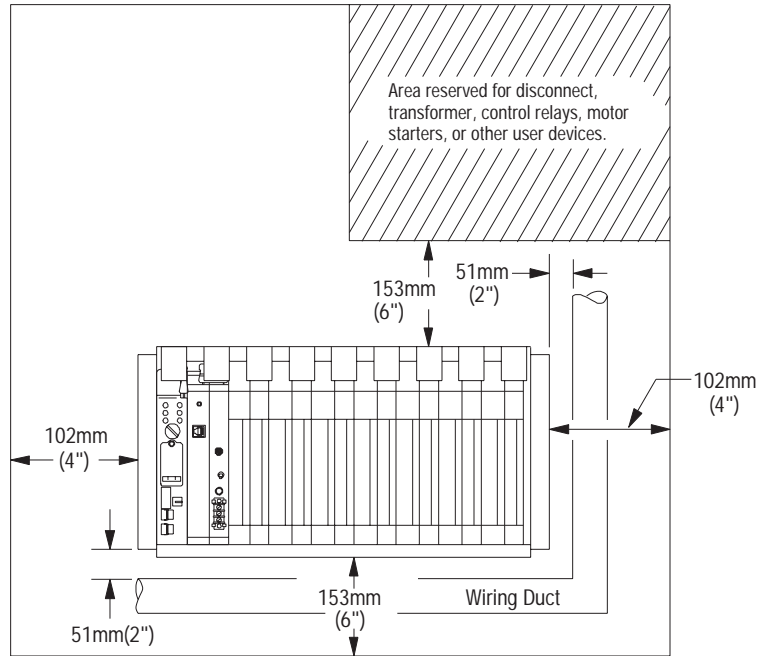

13081

**Minimum spacing requirements for a remote I/O and extended-local I/O chassis:**

- Mount the I/O chassis horizontally.
- Allow 153 mm (6 in) above and below all chassis. When you use more than one chassis in the same area, allow 152.4 mm (6 in) between each chassis.
- Allow 102 mm (4 in) on the sides of each chassis. When you use more than one chassis in the same area, allow 101.6 mm (4 in) between each chassis.
- Allow 51 mm (2 in) vertically and horizontally between any chassis and the wiring duct or terminal strips.
- Leave any excess space at the top of the enclosure, where the temperature is the highest.

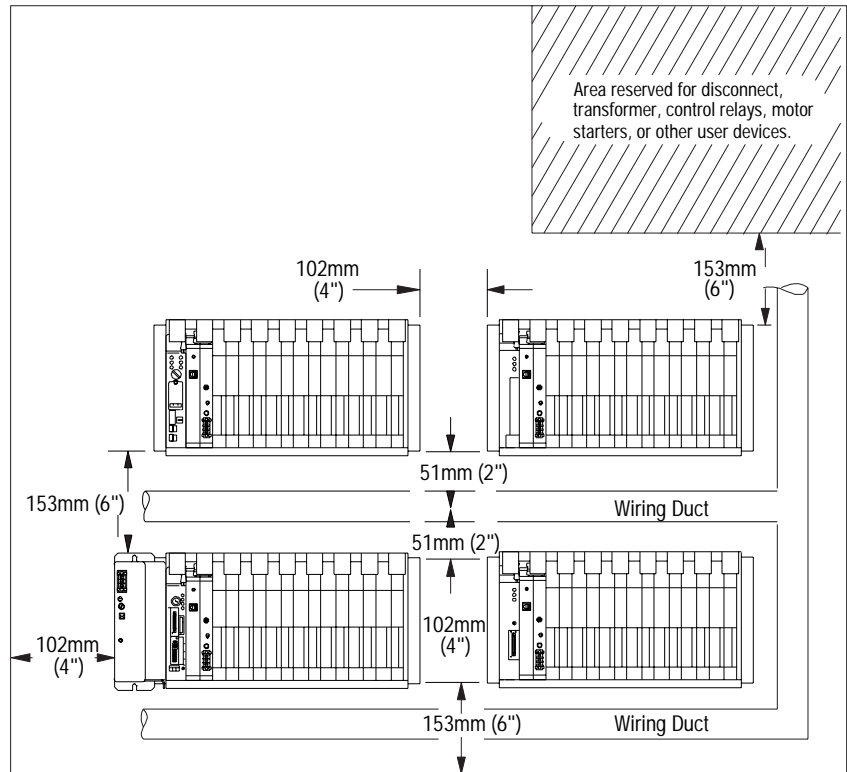

18749

## Protecting Your Controller

You provide the enclosure for your controller system. This enclosure protects your controller system from atmospheric contaminants such as oil, moisture, dust, corrosive vapors, or other harmful airborne substances. To help guard against electromagnetic interference (EMI) and radio frequency interference (RFI), we recommend a steel enclosure.

Mount the enclosure in a position where you can fully open the doors. You need easy access to controller wiring and related components so that troubleshooting is convenient.

When you choose the enclosure size, allow extra space for transformers, fusing, disconnect switch, master control relay, and terminal strips.

## Preventing Electrostatic Discharge

---

**ATTENTION**

Under some conditions, electrostatic discharge can degrade performance or damage the controller. Read and observe the following precautions to guard against electrostatic damage.ESD protection

- Wear an approved wrist strap grounding device when handling the controller.
  - Touch a grounded object to discharge yourself before handling the controller.
  - Do not touch the backplane connector or connector pins.
-

## Laying Out Your Cable Raceway

The raceway layout of a system reflects where the different types of I/O modules are placed in I/O chassis. Therefore, you should determine I/O-module placement prior to any layout and routing of wires. When planning your I/O-module placement, however, segregate the modules based on the conductor categories published for each I/O module so that you can follow these guidelines. These guidelines coincide with the guidelines for “the installation of electrical equipment to minimize electrical noise inputs to controllers from external sources” in IEEE standard 518-1982.

To plan a raceway layout, do the following:

- categorize conductor cables
- route conductor cables

### Categorize Conductors

Segregate all wires and cables into categories as described in the Industrial Automation Wiring and Grounding Guidelines, publication 1770-4.1. See the installation data for each I/O module that you are using for information about its classification.

### Route Conductors

To guard against coupling noise from one conductor to another, follow the general guidelines for routing cables described in the Industrial Automation Wiring and Grounding Guidelines, publication 1770-4.1. You should follow the safe grounding and wiring practices called out in the National Electrical Code (NEC, published by the National Fire Protection Association, in Quincy, Massachusetts), and local electrical codes.



# Laying Out Your Backpanel Spacing

Use 6.35 mm (0.25 inch) mounting bolts to attach the I/O chassis to the enclosure backpanel.

## Chassis Dimensions (Series B)

1771-A1B  
1771-A2B  
1771-A3B1  
1771-A4B

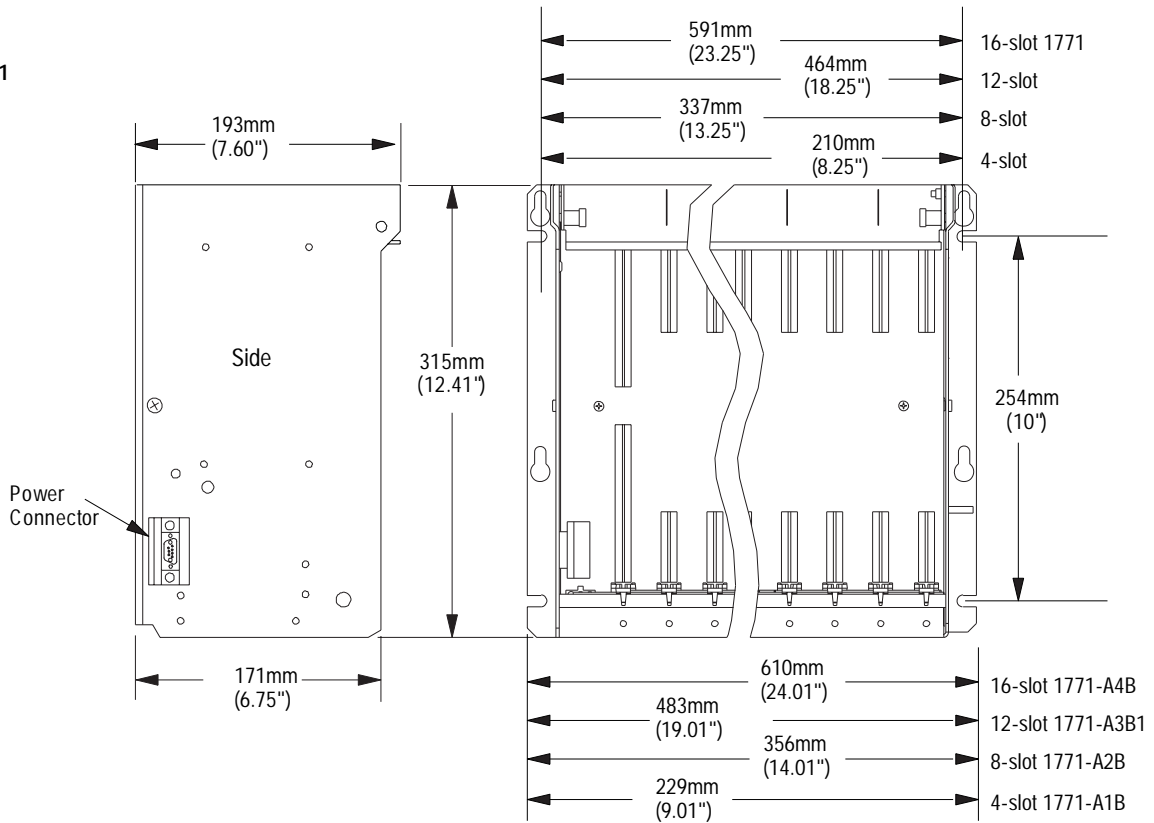

1771-A3B

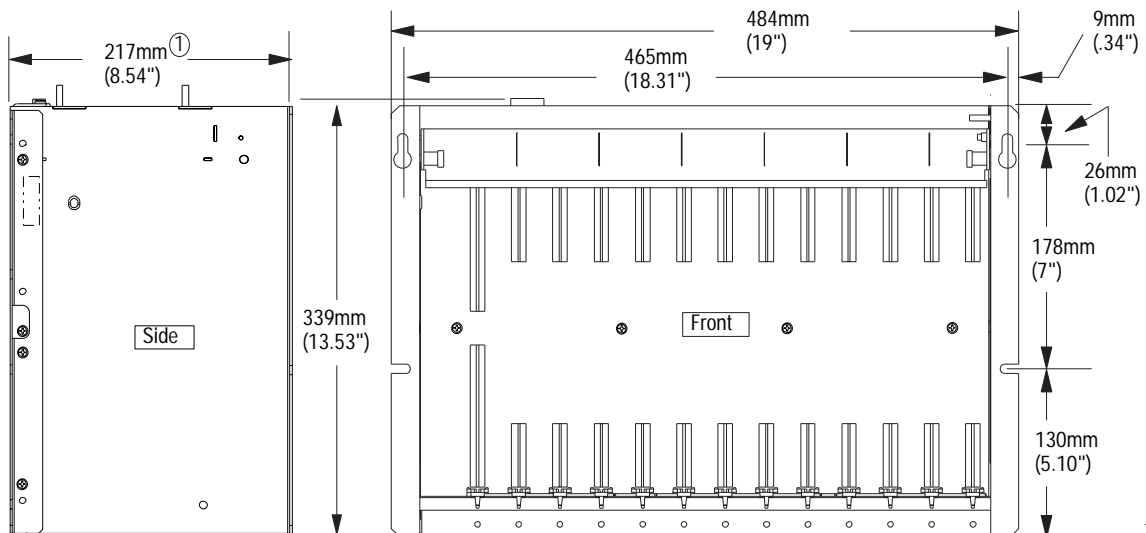

① Total maximum depth dimension per installation will be dependent upon module wiring and connectors.

12450-I

### I/O Chassis and External Power Supply Dimensions

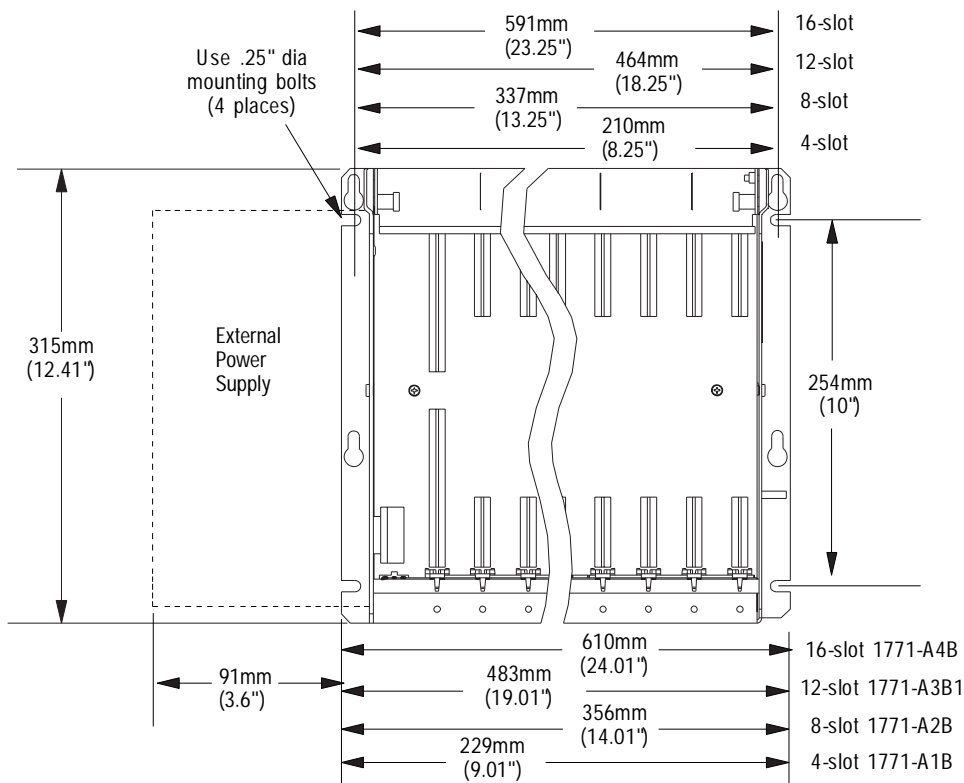

Clearance depth is 204mm (8") for 8 I/O connection points per module.

12451-1

## Grounding Your System

For more information on proper grounding guidelines, see the Industrial Automation Wiring and Grounding Guidelines, publication 1770-4.1.

### Recommended Grounding Configuration for Remote I/O Systems

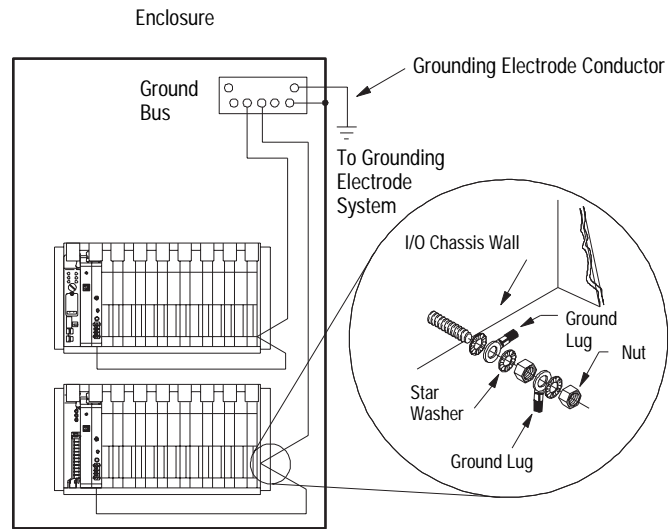

15561

### Required Grounding Configuration for Extended-Local I/O Systems

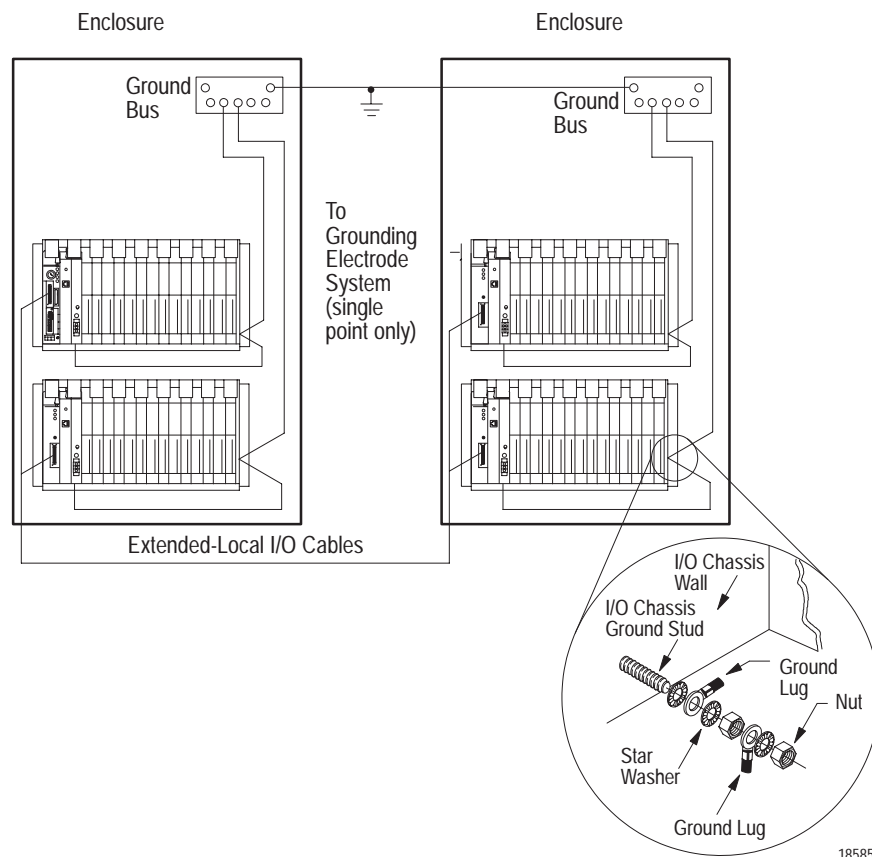

18585

## Notes

## Addressing I/O and Controller Memory

### Using This Chapter

For Information About	Go to Page
I/O addressing concept	4-1
Choosing an addressing mode	4-3
Addressing block-transfer modules	4-7
Addressing summary	4-7
Assigning racks	4-8
Understanding PLC-5 controller memory	4-10
Addressing	4-16
Effectively Using I/O Memory	4-24

### I/O Addressing Concept

Since the main purpose of a programmable controller is to control inputs and outputs of field devices like switches, valves, and thermocouples, these inputs and outputs must occupy a location in the controller memory so that they can be addressed in your control program. Each terminal on an input or output module that can be wired to a field device occupies a bit within controller memory. The part of controller memory that houses I/O addresses is the **input image table** and the **output image table**.

I/O addressing helps connect the physical location of an I/O module terminal to a bit location in the controller memory. I/O addressing is just a way to segment controller memory. The segmentation is as follows:

Classification	Term	Relation to Controller Memory
A specific terminal on an I/O module that occupies a space in controller memory	terminal or point	The density of an I/O module, i.e., 8-point, 16-point, 32-point, directly relates to the amount of memory (bits) the module occupies in controller memory. For example, a 16-point input module occupies 16 bits in the controller's input image table.
I/O terminals that when combined occupy 1 word in controller's input image table <b>and</b> 1 word in the controller's output image table.	I/O group	16 input bits = 1 <b>word</b> in controller's input image table 16 output bits = 1 <b>word</b> in the controller's output image table
Controller memory needs to be grouped so that related I/O groups can be considered a unit.	I/O rack	128 input bits and 128 output bits, or 8 input words and 8 output words, or 8 I/O groups  Each PLC-5 controller has a finite amount of racks it can support. For example, a PLC-5/30 can support 8 I/O racks. The controller always occupies at least one I/O rack for itself, rack 0 by default.

The figure below shows the relationship between an I/O terminal and its location in controller memory.

I/O Addressing as It Relates to an I/O Terminal

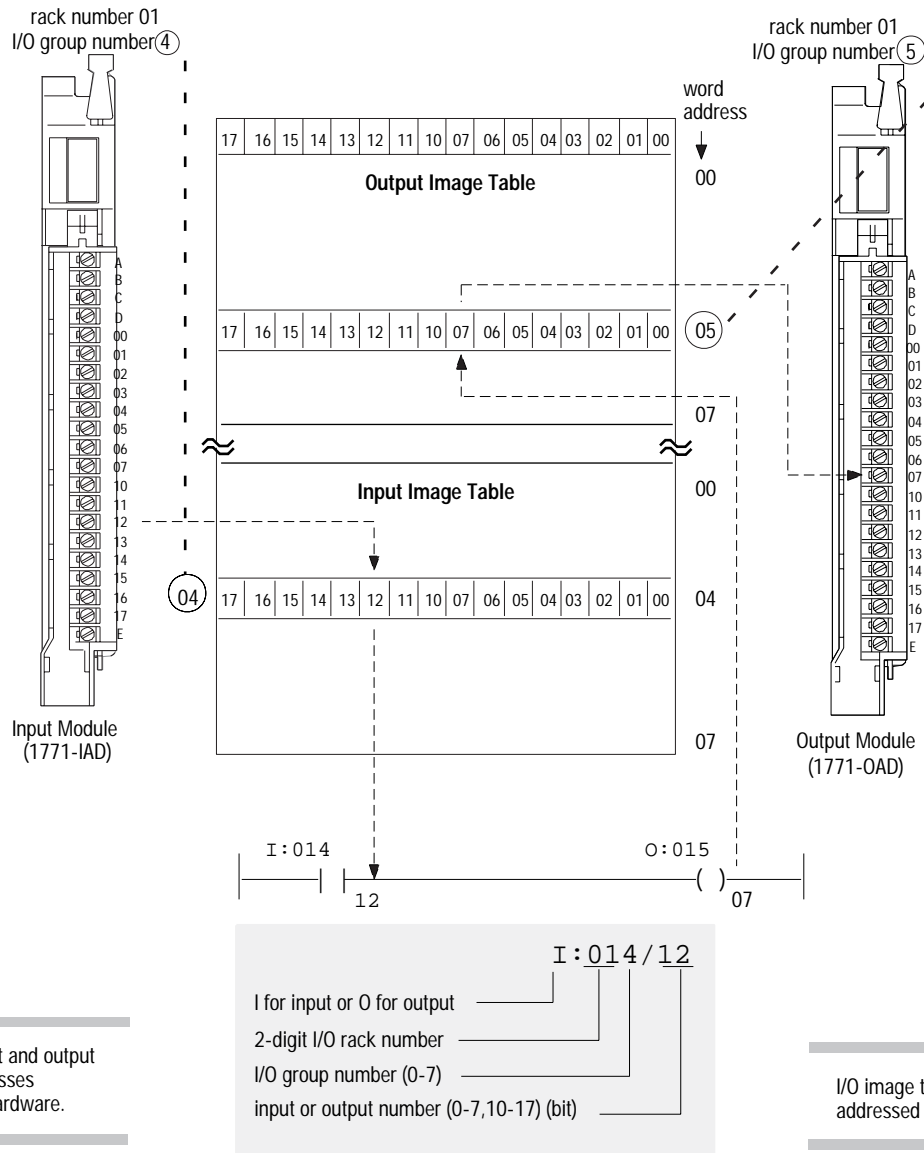

Notice how input and output image file addresses correspond to hardware.

I/O image table is addressed octally.

Now that you are familiar with how controller memory is segmented to address a specific I/O terminal, the next section explains available addressing modes. These modes let you define the relationship between an I/O chassis slot and an I/O group (16 input bits and 16 output bits).

## Choosing an Addressing Mode

For each I/O chassis in your system, you must define how many I/O chassis slots make up an I/O group (1 word each in the input image table and output image table); this choice is the chassis' addressing mode. Choose from among these available modes:

- **2-slot addressing**

2 I/O chassis slots = 1 I/O group = 1 input image word and 1 output image word = 16 input bits and 16 output bits.

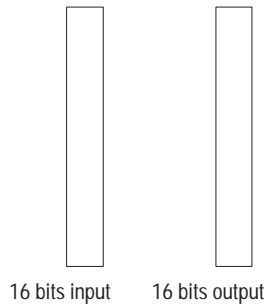

- **1-slot addressing**

1 I/O chassis slot = 1 I/O group = 1 input image word and 1 output image word = 16 input bits and 16 output bits.

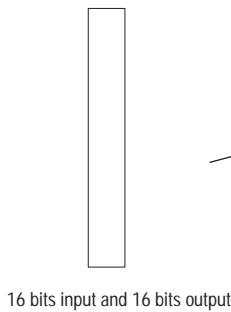

- **1/2-slot addressing**

1/2 of an I/O chassis slot = 1 I/O group = 1 input image word and 1 output image word = 16 input bits and 16 output bits.

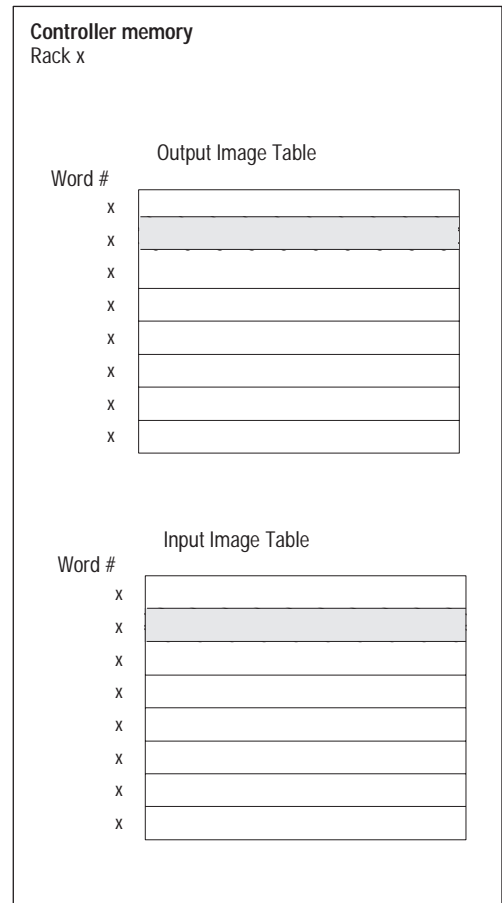
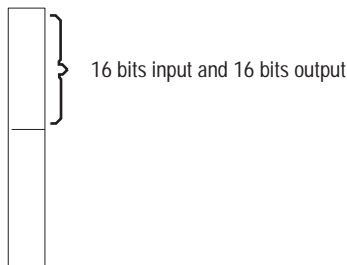

When you place your I/O modules in the I/O chassis slots, the module's density determines how quickly I/O groups form. For example, let's choose 1-slot addressing and see how 8-, 16-, and 32-point I/O modules fill controller memory.

### 18-and 16-point Example

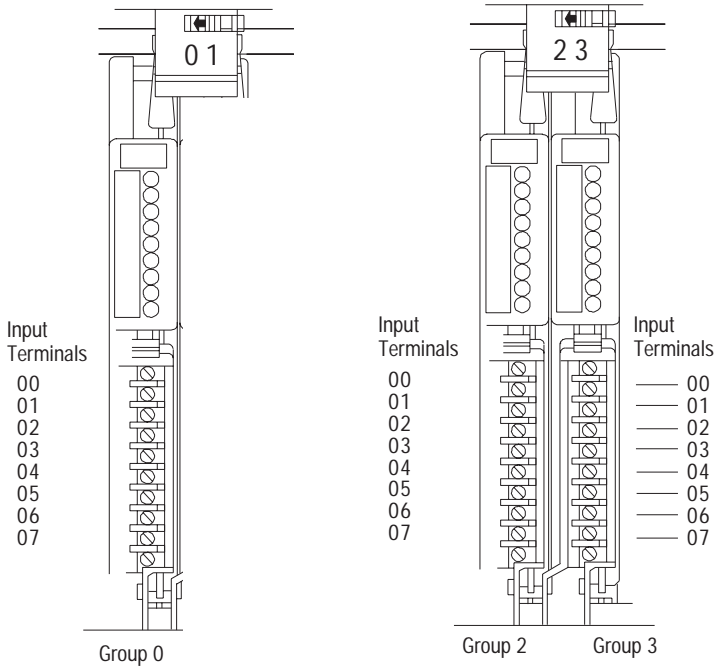

An 8-point I/O module occupies 8 bits in a word. See ①

Two 8-point input modules occupy 8 bits of each group. See ②

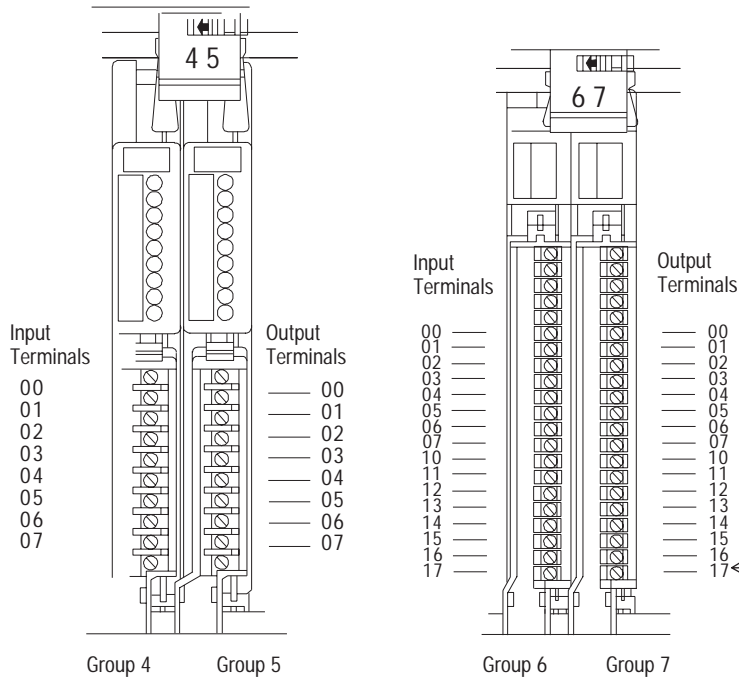

An 8-point input module in group 4 occupies the first eight bits of input word 4. The 8-point output module occupies the first 8-output bits in output word 5. See ③

16-point I/O modules occupy 16 bits, an entire word, in the image table. See ④

1-slot addressing (1 I/O chassis slot = 1 I/O group = 1 input image word and 1 output image word = 16 input bits and 16 output bits.)

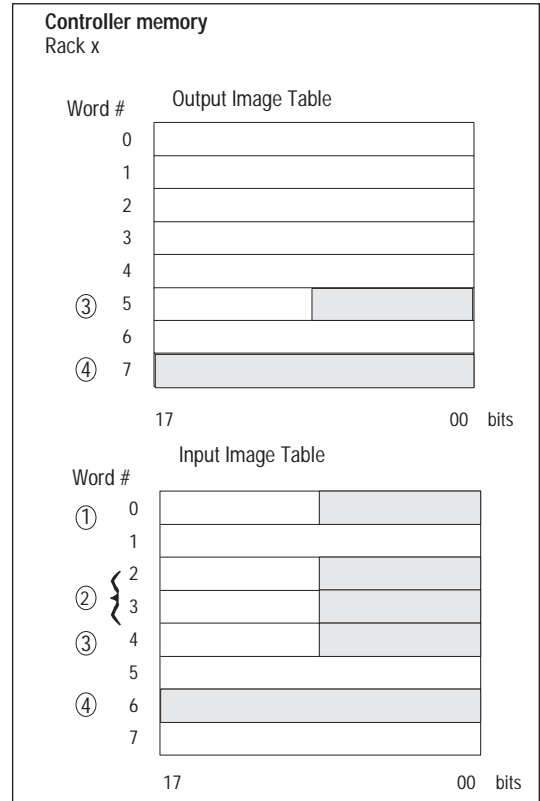

If you were to address the device attached to this output circuit in your control program, the address would be 0:xx7/17.



### 32-point Example

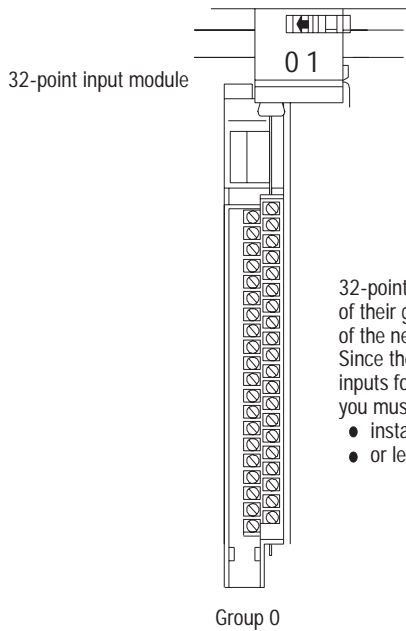

1-slot addressing (1 I/O chassis slot = 1 I/O group = 1 input image word and 1 output image word = 16 input bits and 16 output bits.)

32-point I/O modules use the entire word of their group and borrow the entire word of the next group. See ①. Since the module is in group 0 and the inputs for group 0 and group 1 are used, you must:

- install an output module in group 1
- or leave the slot empty

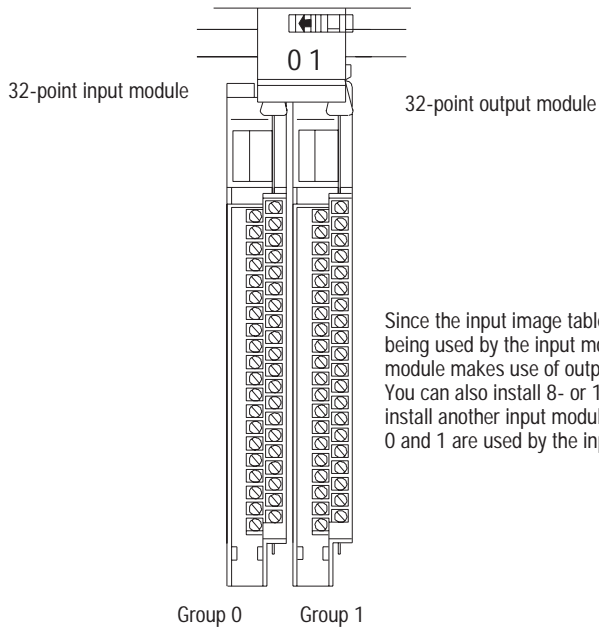
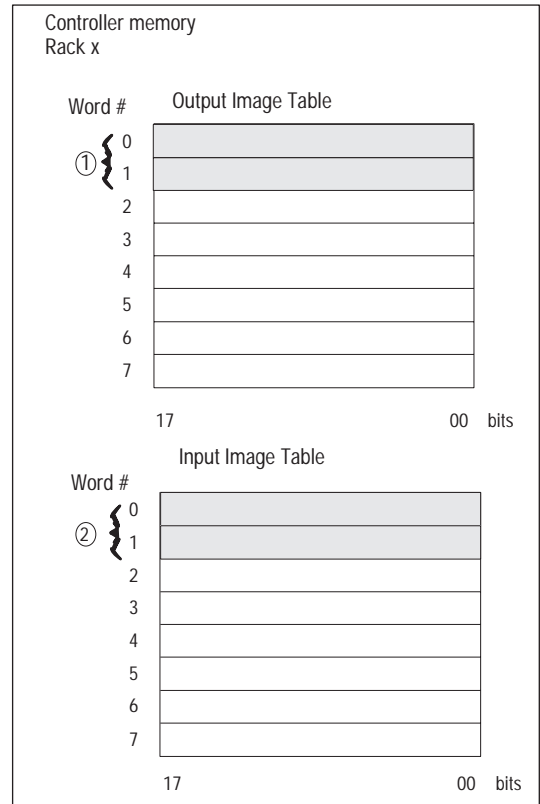

Since the input image table for group 1 is unavailable because it is being used by the input module of group 0, installing a 32-point output module makes use of output image table of group 0 and 1. See ②. You can also install 8- or 16-point output modules. But you cannot install another input module since all the input image space for groups 0 and 1 are used by the input module of group 0.

When planning your system design, consider the densities of the I/O modules you are using and choose an addressing mode that most efficiently uses controller memory.

**Example of Efficient I/O Image Table Use.**

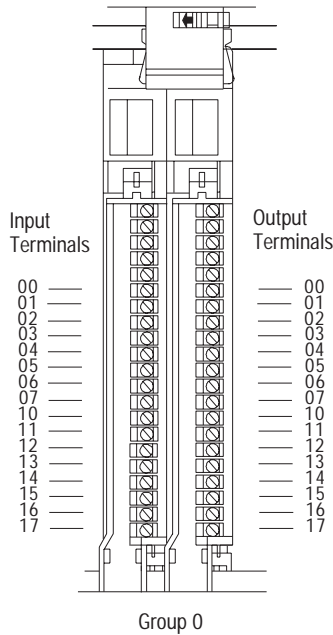

16-point I/O modules occupy 16 bits, an entire word, in the image table.  
 Installing as a pair a 16-point input module and a 16-point output module efficiently uses the image table.

2-slot addressing (2 I/O chassis slot = 1 I/O group = 1 input image word and 1 output image word = 16 input bits and 16 output bits.)

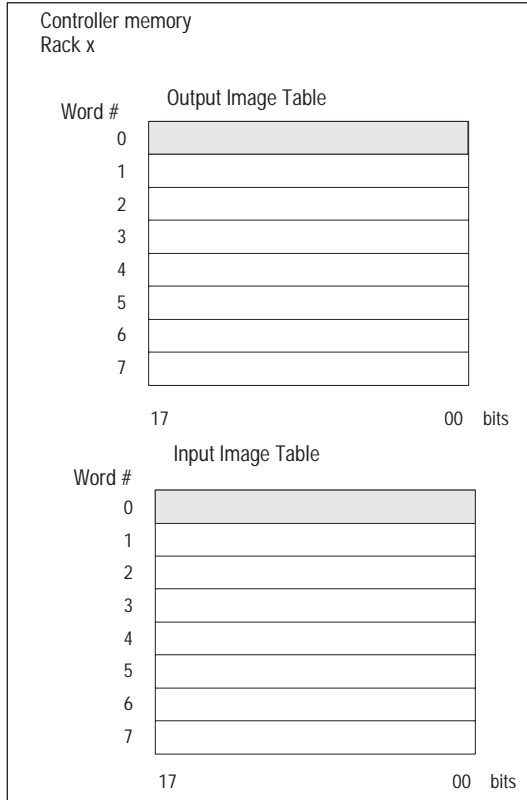

Define the addressing mode for each I/O chassis by setting the chassis backplane switch assembly. For more information, see Appendix E.

## Addressing Block-Transfer Modules

Block-transfer modules occupy 8 bits in the controller's I/O image table. Since all block-transfer modules are bidirectional, they cannot be used to complement either input or output modules.

To Address	Use
single slot modules	assigned I/O rack and group number of the slot in which the module resides and 0 for the module number  When using 1/2-slot addressing, use the assigned rack number and the <b>lowest</b> group number and 0 for the module number.
double-slot modules	assigned rack number and the <b>lowest</b> group number and 0 for the module number

## Addressing Summary

Use this table as a quick reference for addressing.

Addressing Mode	Guidelines
2-slot	<ul style="list-style-type: none"> <li>• Two I/O module slots = 1 group</li> <li>• Each physical 2-slot I/O group corresponds to one word (16 bits) in the input image table and one word (16 bits) in the output image table</li> <li>• When you use 16-point I/O modules, you must install as a pair an input module and an output module in an I/O group; if you use an input module in slot 0, you must use an output module in slot 1 (or it must be empty). This configuration gives you the maximum use of I/O.</li> <li>• You cannot use a block-transfer module and a 16-point module in the same I/O group because block-transfer modules use 8 bits in both the input and output table. Therefore, 8 bits of the 16-point module would conflict with the block-transfer module.</li> <li>• You cannot use 32-point I/O modules.</li> <li>• Assign one I/O rack number to eight I/O groups.</li> </ul>
1-slot	<ul style="list-style-type: none"> <li>• One I/O module slot = 1 group</li> <li>• Each physical slot in the chassis corresponds to one word (16 bits) in the input image table and one word (16 bits) in the output image table</li> <li>• When you use 32-point I/O modules, you must install as a pair an input module and an output module in an even/odd pair of adjacent I/O group; if you use an input module in slot 0, you must use an output module in slot 1 (or it must be empty). This configuration gives you the maximum use of I/O.</li> <li>• Use any mix of 8- and 16-point I/O modules, block-transfer or intelligent modules in a single I/O chassis. Using 8-point modules results in fewer total I/O.</li> <li>• Assign one I/O rack number to eight I/O groups.</li> </ul>
1/2-slot	<ul style="list-style-type: none"> <li>• One half of an I/O module slot = 1 group</li> <li>• Each physical slot in the chassis corresponds to two words (32 bits) in the input image table and two words (32 bits) in the output image table</li> <li>• Use any mix of 8-, 16-, and 32-point I/O or block-transfer and intelligent modules. Using 8-point and 16-point I/O modules results in fewer total I/O.</li> <li>• With the controller-resident local rack set for 1/2-slot addressing, you cannot force the input bits for the upper word of any slot that is empty or that has an 8-point or 16-point I/O module. For example, if you have an 8-point or a 16-point I/O module in the first slot of your local rack (words 0 and 1 of the I/O image table, 1/2-slot addressing), you cannot force the input bits for word 1 (1:001) on or off.</li> <li>• Assign one I/O rack number to eight I/O groups.</li> </ul>

## Assigning Racks

The number of racks in a chassis depends on the chassis size and the addressing mode:

If Using this Chassis Size	2-slot Addressing, Results In	1-slot Addressing, Results In	1/2-slot Addressing, Results In
4-slot	1/4 rack	1/2 rack	1 rack
8-slot	1/2 rack	1 rack	2 racks
12-slot	3/4 rack	1-1/2 racks	3 racks
16-slot	1 rack	2 racks	4 racks

**TIP**

When assigning rack numbers, use the following guidelines:

- One I/O rack number is eight I/O groups, regardless of the addressing mode that you select.
- You can assign from **one to four racks in your controller-resident local chassis (128 inputs and 128 outputs)** depending on the chassis size and addressing mode. You cannot split a controller-resident local I/O rack over two or more chassis or assign unused controller-resident local I/O groups to remote I/O racks.
- The default address of the controller-resident local rack is 0.
- You cannot split racks across remote I/O and extended-local I/O links. For example, if an 8-slot extended-local I/O chassis is configured as I/O groups 0-3 of I/O rack 2, an 8-slot remote I/O chassis cannot be configured as I/O groups 4-7 of I/O rack 2. For more information about addressing extended-local I/O, see chapter 8.
- When using complementary I/O addressing, treat complementary rack addresses individually when grouping racks; primary rack numbers are separate from complement rack numbers.
- If you are not using the autoconfiguration function, group together 1/4-racks and 1/2-racks of each logical rack on the configuration screen of your programming software. Do not intersperse these with other rack numbers. For example, your programming software has a screen with the following information for defining racks:

Group together 1/4 racks and 1/2 racks →

Rack Address	Starting Group	Rack Size	Range	Fault	Inhibit	Reset	Retry
1	0	1/4	010-011		I	0	0
1	2	1/4	012-013		0	0	0
1	4	1/4	014-015		0	0	0
2	0	1/4	020-021		0	0	0
2	2	1/4	022-023		0	0	0
2	4	1/2	024-027		0	0	0
3	0	1/4	030-031		0	0	0
17	0	FULL	170-177		0	0	0

**TIP****When assigning remote I/O rack numbers, use these guidelines:**

- A single remote I/O scanner channel can support up to 32 devices but only 16 rack numbers. For more information, see chapter 6.
- Limit the number of remote I/O rack numbers to those that your PLC-5 controller can support.
- The PLC-5 controller and the 1771-ASB adapter module automatically allocate the next higher rack number(s) to the remaining I/O groups of the chassis. For example, if you select 1/2-slot addressing for your controller-resident local chassis and you are using a 16-slot (1771-A4B) chassis, the controller will address racks 0, 1, 2, and 3 in this chassis.
- You can assign a remote I/O rack to a fraction of a chassis, a single I/O chassis, or multiple I/O chassis as shown below.

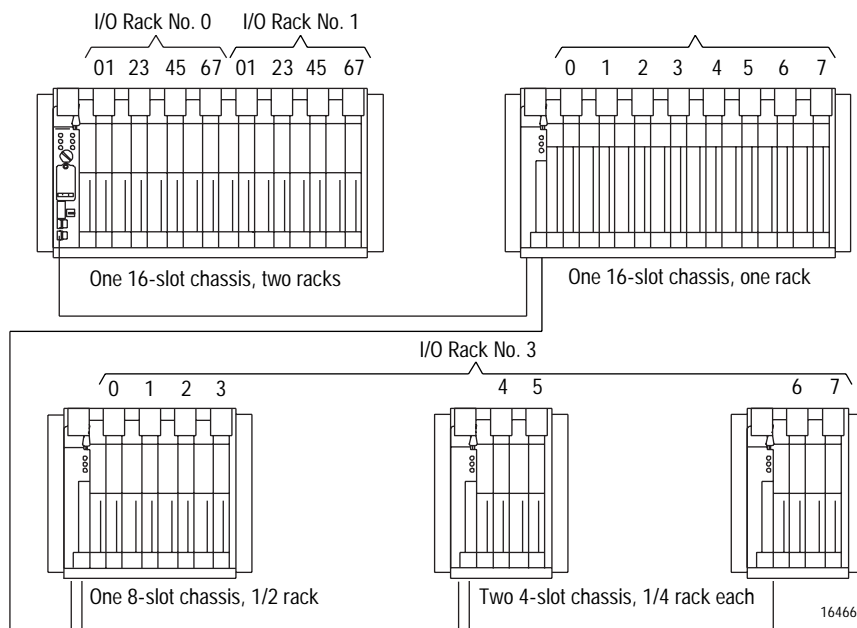

## Understanding PLC-5 Controller Memory

Controller memory is divided into two basic areas:

Storage Areas	Description
Data	All of the data the controller examines or changes is stored in files in data storage areas of memory. These storage areas store: <ul style="list-style-type: none"><li>• Data received from input modules</li><li>• Data to be sent to output modules; this data represents decisions made by the logic</li><li>• Intermediate results made by the logic</li><li>• Preloaded data such as presets and recipes</li><li>• Control instructions</li><li>• System status</li></ul>
Program Files	You create files for program logic, depending on the method you are using: ladder logic, sequential function charts, and/or structured text. These files contain the instructions to examine inputs and outputs and return results.

## Understanding Data Storage (Data-Table Files)

The controller divides data storage into:

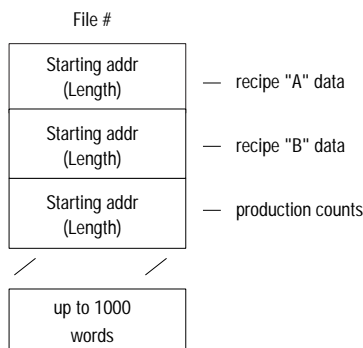
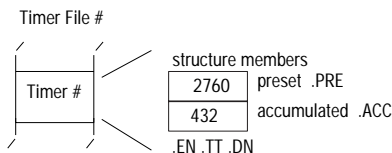
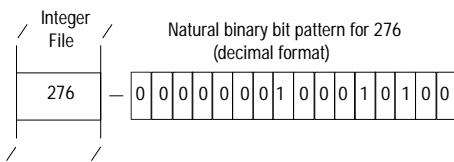
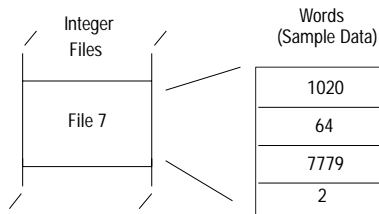
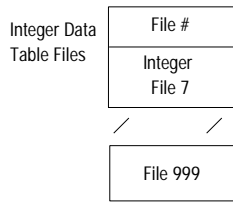

- **Types** that let you specify different formats and ranges to accommodate different types of data. For more information on the different types of data files, see on page 13.

- You can create multiple **files** of a given type. Files let you group and organize logically related data. When you need to access data, you specify the file in which the data is stored.

- Some types of files are made up of 16-bit **words**. Floating-point words are 32 bits. When you need to access this data, you specify it with a formatted address.

- Each word contains multiple **bits**. This is the smallest division of data. A bit contains a value of zero or one. When you need to access this data, you specify it with a formatted address.

- Some types of files are divided into **structures** used to control instruction elements. These structures are subdivided into **members** at the bit or word level. When you need to access this data, you specify it with a formatted address.

You can also organize data within files into **data blocks** to group and organize logically related data. When you need to access this data, you specify only the starting address within the file (and length) instead of each individual address.

When you organize data, group data by similar kind, such as:

- results of calculations
- batch recipes

Because of the structure of block-transfer instructions, you must group data such as:

- inputs from analog modules
- outputs to analog modules

**TIP**

You might also want to leave room for future expansion when grouping data. Do this by leaving gaps between:

- data blocks within a file
- groups of sequentially numbered files
- modules in an I/O chassis

---

**IMPORTANT**

If you plan to edit your program online in Run mode, you must allocate unused data table files/elements and program files because you cannot create user memory while in run mode. Each unused file, however, uses 6 words of overhead memory for each data/program file you skip. Use care when leaving gaps.

---

**TIP**

Follow these guidelines when organizing data files:

- Group large amounts of related data into files.
- Address the data files from 3-999 as needed. (See on page page 13).
- Address the words needed in each data file consecutively from 0-999 (0-1999 for some data types in series E, revision D controllers and later).
- Address the words of I/O image data according to how you configured your I/O:
  - 0-37 (octal) for PLC-5/11, -5/20, -5/20E
  - 0-77 (octal) for PLC-5/30
  - 0-177 (octal) for PLC-5/40, -5/40L, -5/40E
  - 0-277 (octal) for PLC-5/60, -5/60L, -5/80, -5/80E
- When addressing I/O image bits, address them 00-07 or 10-17 (octal).
- When organizing bit data, address the bits in each word 0-15 (decimal) for binary or integer files.

Each data table file allocates 6 words of memory when you create the file. This is in addition to any data stored in the file.



## Addressing File Types

The following two tables show the available file types and the amount of memory used by each.

**Data Table File Types and Memory Usage for PLC-5 Controllers Series E/Revision D and Later**

File Type	File-Type Identifier	File Number	Maximum Size of File 16-bit Words and Structures				Memory Used in Overhead for Each File (in 16-bit Words)	Memory Used (in 16-bit Words) per Word, Character, or Structure
			PLC-5/11, -5/20, -5/20E	PLC-5/30	PLC-5/40, -5/40E, -5/40L	PLC-5/60, -5/60L, -5/80, -5/80E		
Output image	O	0	32	64	128	192	6	1/word
Input image	I	1	32	64	128	192	6	1/word
Status	S	2	128	128	128	128	6	1/word
Bit (binary)	B	3 <sup>1</sup>	2000 words				6	1/word
Timer	T	4 <sup>1</sup>	6000 words/2000 structures				6	3/structure
Counter	C	5 <sup>1</sup>	6000 words/2000 structures				6	3/structure
Control	R	6 <sup>1</sup>	6000 words/2000 structures				6	3/structure
Integer	N	7 <sup>1</sup>	2000 words				6	1/word
Floating-point	F	8 <sup>1</sup>	4000 words/2000 structures				6	2/structure
ASCII	A	3-999	2000 words				6	1/2 per character
BCD	D	3-999	2000 words				6	1/word
Block-transfer	BT	3-999	12000 words/2000 structures				6	6/structure
Message	MG	3-999	32760 words/585 structures <sup>2</sup>				6	56/structure
PID	PD	3-999	32718 words/399 structures <sup>2</sup>				6	82/structure
SFC status	SC	3-999	6000 words/2000 structures				6	3/structure
ASCII string	ST	3-999	32760 words/780 structures <sup>2</sup>				6	42/structure
Unused	--	9-999	6				6	0

<sup>1</sup> This is the default file number and type. For this file type, you can assign any file number from 3 through 999.

<sup>2</sup> The maximum size of a data table file is 32K words. The maximum size of the entire data table is 64K words

**Data Table File Types and Memory Usage for PLC-5 Controllers Series E/Revision C and Earlier**

File Type	File-Type Identifier	File Number	Maximum Size of File 16-bit Words and Structures				Memory Used in Overhead for Each File (in 16-bit Words)	Memory Used (in 16-bit Words) per Word, Character, or Structure
			PLC-5/11, -5/20, -5/20E	PLC-5/30	PLC-5/40, -5/40E, -5/40L	PLC-5/60, -5/60L, -5/80, -5/80E		
Output image	O	0	32	64	128	192	6	1/word
Input image	I	1	32	64	128	192	6	1/word
Status	S	2	128	128	128	128	6	1/word
Bit (binary)	B	3 <sup>1</sup>	1000 words				6	1/word
Timer	T	4 <sup>1</sup>	3000 words/1000 structures				6	3/structure
Counter	C	5 <sup>1</sup>	3000 words/1000 structures				6	3/structure
Control	R	6 <sup>1</sup>	3000 words/1000 structures				6	3/structure
Integer	N	7 <sup>1</sup>	1000 words				6	1/word
Floating-point	F	8 <sup>1</sup>	2000 words/1000 structures				6	2/structure
ASCII	A	3-999	1000 words				6	1/2 per character
BCD	D	3-999	1000 words				6	1/word
Block-transfer	BT	3-999	6000 words/1000 structures				6	6/structure
Message	MG	3-999	32760 words/585 structures <sup>2</sup>				6	56/structure
PID	PD	3-999	32718 words/399 structures <sup>2</sup>				6	82/structure
SFC status	SC	3-999	3000 words/1000 structures				6	3/structure
ASCII string	ST	3-999	32760 words/780 structures <sup>2</sup>				6	42/structure
Unused	--	9-999	6				6	0

<sup>1</sup> This is the default file number and type. For this file type, you can assign any file number from 3 through 999.

<sup>2</sup> The maximum size of a data table file is 32K words. The maximum size of the entire data table is 64K words

**Valid Data Types/Values Are:****This Data Type/Value Accepts Any**

Immediate (program constant)	Value between -32768 and 32767 (Constants greater than 1024 use 2 storage words of memory; floating point constants use 3 words of memory.)
Integer	Integer data type: integer, timer, counter, status, bit, input, output, ASCII, BCD, control (e.g., N7:0, C4:0, etc.)
Float	Floating point data type (valid range is $\pm 1.175494e^{-38}$ to $\pm 3.402823e^{+38}$ ) with 7-digit precision
Block	Block-transfer data type (e.g., BT14:0) or integer data type (e.g., N7:0)
Message	Message data type (e.g., MG15:0) or integer data type (e.g., N7:0)
PID	PID data type (e.g., PD16:0) or integer data type (e.g., N7:0)
String	String data type (e.g., ST12:0)
SFC status	SFC status data type (e.g., SC17:0)

**Understanding Program-File Storage**

Create program files based on the programming method you are using. This table lists the number of words used by each type of program file:

Program File	Number of Words Used
Ladder	6/file + 1/word
SFC	6/file
Structured Text	6/file + 1/word

The more program files that you create, the longer the controller takes to perform certain tasks, e.g., going to run mode, performing online editing, saving a program. Also, certain instructions (JMP, LBL, FOR, and NXT) have longer execution times in higher program file numbers.

Series E PLC-5 controllers support 2000 program files to allow for more SFC steps in your program. SFC step/transition program files are typically shorter in length. This enhancement will effectively double your SFC step/transition size.

Each program file you create is allocated 6 words of memory. This memory is in addition to any programming within the file. If you create the maximum program file number 1999, this allocates 12,000 words of memory to the program files, which reduces the amount of controller memory left for programming.

# Addressing

Valid formats for addressing data files are:

If You Want to Access	Use this Addressing Format	And See Page
Input or output bit in the I/O image table	I/O image address	4-16
Bit, word, sub-member, data block, file, or I/O image bit	Logical address	4-17
A component within a logical address by substituting the value in another address	Indirect address	4-18
An address offset by some number of elements	Indexed address	4-20
A substitute name for an address	Symbolic address	4-21

For more information about entering addresses, see the documentation for your programming software.

## Specifying I/O Image Addresses

The I/O image address corresponds to the physical location of the I/O circuit in the I/O chassis:

a	I/O address identifier I = input device O = output device
bb	I/O Rack number PLC-5/11, -5/20, -5/20E00-03 (octal) PLC-5/3000-07 (octal) PLC-5/40, -5/40L, -5/40E00-17 (octal) PLC-5/60, -5/60L, -5/80, -5/80E00-27 (octal)
c	I/O Group number 0-7 (octal)
dd	Terminal (bit) number 00-17 (octal)

To Specify this Address	Example
-------------------------	---------

Input Image Bit

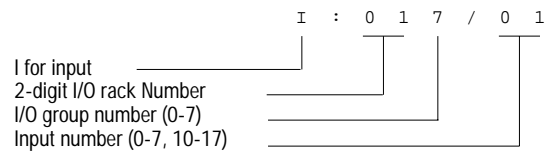

Output Image Bit

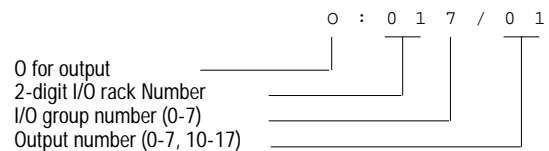

## Specifying Logical Addresses

The format of a logical address corresponds directly to the location in data storage: # X F : e . s / b

Where	Is the
#	File address. Omit for bit, word, and structure addresses (also indicates indexed addressing, see next page)
X	File type: B—binary N—integer T—timer MG—message C—counter O—output A—ASCII PD—PID F—floating point R—control ID—BCD SC—SFC status I—input S—status BT—block-transfer ST—ASCII string
F	File number: 0—output 1—input 2—status 3-999—any other type
:	colon or semicolon delimiter separates file and structure/word numbers
e	Structure/word number: 0-277 octal for input/output files up to: 0-127 decimal for the status file 0-999 for all the file types except MG, PD, and ST files
.	Period delimiter is used only with structure-member mnemonics in counter, timer and control files
s	Structure/member mnemonic is used only with timer, counter, control, BT, MG, PD, SC, and ST files
/	Bit delimiter separates bit number
b	Bit number: 00-07 or 10-17 for input/output files 00-15 for all other files 00-15,999 for binary files when using direct bit address

### To Specify the Address of a Use these Parameters

File



Word within an integer file

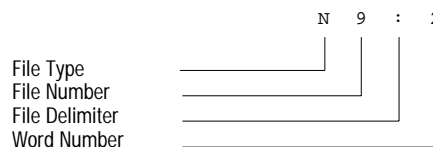

Bit within an integer file

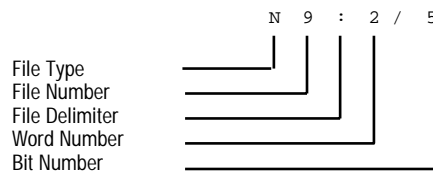

**To Specify the Address of a Use these Parameters**

Bit within a binary file

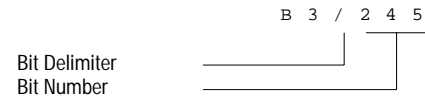

Binary files are bit stream continuous files, and therefore you can address them in two ways: by word and bit, or by bit alone.

Bit within a structure file

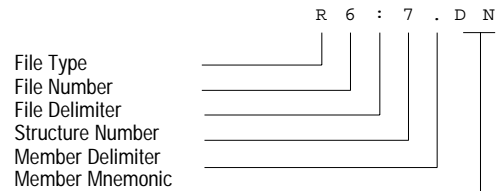

You can also use mnemonics to address members at the word or bit level. The available mnemonics depend on the type of data (timer, counter, or control) and the program instruction. For example:

Instruction Type	Word Level	Example	Bit Level	Example
Timer TON, TOF, RTO	preset .PRE accumulated.ACC	T4:1.PRE	enable.EN timing.TT done.DN	T4:0.EN

For information about the mnemonics for a specific instruction, see chapter 22 of the PLC-5 Programming Controller Instruction Set Reference, publication 1785-6.1.

**Specifying Indirect Addresses**

**ATTENTION**



When using indirect addressing, make sure that the indirect address points to a valid data file or element. During Run mode, if ladder execution encounters an invalid or out-of-range indirect address, a run-time error occurs and the controller halts.

The controller uses the value from the pointer address to form the indirect address. You can use ladder logic to change the value stored at that substitute address.

When you specify indirect addresses, follow these guidelines:

- You can indirectly address the file number, word number, or bit number.
- The substitute address must be one of the following types: N, T, C, R, B, I, O, or S. Any T, C, or R address must be a word-length sub-member address, such as T4:0.ACC.
- Enter the pointer address in brackets [ ].

Example	Variable	Explanation
N[N7:0]:0	File number	The file number is stored in integer address N7:0.
N7:[C5:7.ACC]	Structure number	The word number is the accumulated value of counter 7 in file 5.
B3:[I:017]	Bit number	The bit number is stored in input word 17.
N[N7:0]:[N9:1]	File and word number	The file number is stored in integer address N7:0 and the word number in integer address N9:1.

#### ATTENTION



If you indirectly address the input or output image table, the value you specify in the integer file that you use for the indirection (the pointer) is converted to octal when executed by the instruction.

For example, if you enter O:[N7:0] and N7:0 contains the value 10, the value at N7:0 is converted to octal and the resulting address is O:012, not O:010.

To monitor for invalid indirect addresses, condition the rung with the indirect address with a limit test of the indirect address to ensure that the address stays within the intended range. This is especially advisable if the PLC-5 controller has no control over the indirect address, such as the value is determined by values from an I/O module or a peer controller.

## Specifying Indexed Addresses

The controller starts operation at the base address plus the offset. Store the offset value in the offset word in the controller's status file. You can manipulate the offset word in your ladder logic.

The indexed address symbol is the # character. Place the # character immediately before the file-type identifier in a logical address. Enter the offset value in the status file S:24. All indexed instructions use S:24 to store an offset.

When you specify indexed addresses, follow these guidelines:

- Make sure the index value (positive or negative) does not cause the indexed address to exceed the file-type boundary.

### ATTENTION



The controller does not check indexed addresses to make sure that the addresses do not cross data-table file boundaries (e.g., N7 to F8). You could even modify the status file, which is physically the last data table file. But if the indexed address exceeds the data-table area of memory, the controller initiates a run-time error and sets a major fault.

- When an instruction uses more than two indexed addresses, the controller uses the same index value for each indexed address.
- Set the offset word to the index value you want immediately before enabling an instruction that uses an indexed address.

### ATTENTION



Instructions with a # sign in an address manipulate the offset value stored at S:24. Make sure you monitor or load the offset value you want prior to using an indexed address. Otherwise unpredictable machine operation could occur with possible damage to equipment and/or injury to personnel.

The following MVM example uses an indexed address in the source and destination addresses. If the offset value is 10 (stored in S:24), the controller manipulates the data stored at the base address plus the offset.

MVM	
MASKED MOVE	
Source	#N7:10
Mask	00110011
Destination	#N11:5

Value	Base Address	Offset Address
Source	N7:10	N7:20
Destination	N11:5	N11:15



## Specifying Symbolic Addresses

When you specify symbolic address, follow these guidelines:

- Start the name with an alphabetic character (not a number).
- The symbol must begin with a letter and can contain as many as 10 of the following characters:
  - – A-Z (upper and lower case)
  - – 0-9
  - – underscore ( \_ )
- You can substitute a symbolic address for word or bit addresses.

### IMPORTANT

Symbols are a feature of the programming software (not the controller) and are stored in a database on the hard disk of the personal computer you are using. If you use a terminal other than the one on which you defined the symbols, you will not have access to the symbol database.

Example	Logical Address	Symbolic Address
Input image (bit)	I:015/00	LS1
	I:015/03	AUTO1
	I:015/06	SW1
Output image (bit)	O:013/00	M1
	O:013/02	CL1
	O:013/04	L1
Word	F10:0	Calc_1
	F10:1	Calc_2

## Optimizing Instruction Execution Time and Controller Memory

**TIP**

For the best instruction-execution performance, store your most frequently used addresses as shown below:

- Address bit instructions between the end of the input image file and physical word 256. Bit addresses located in words greater than 256 require one extra word in the controller's memory for storage and execute 0.16ms slower than bit addresses stored in words 0-255.
- Address element instructions between the end of the input image and physical word 2048. Addresses stored in words greater than 2048 require more words in the controller's memory for storage.

	PLC-5/11, -5/20, -5/20E Physical Word #	PLC-5/30 Physical Word #	PLC-5/40, -5/40L -5/40E Physical Word #	PLC-5/60, -5/60L -5/80, -5/80E Physical Word #	File Type	Default File #
frequently used bit addresses	0-31	0-63	0-127	0-191	output image ①	0
	32-63	32-127	32-255	32-383	input image ①	1
	----- word 256 -----				binary, timer, counter, control, integer, floating point  block transfer, message, PID, SFC status, ASCII string	3-999 according to your application
frequently used element addresses	----- word 2048 -----					
					status ②	2

① The minimum size of the file is 32 words.

② The status file is always the last physical file in the data table.

The following examples illustrate these concepts:

**Bit address example**

If your data table map looks like this:

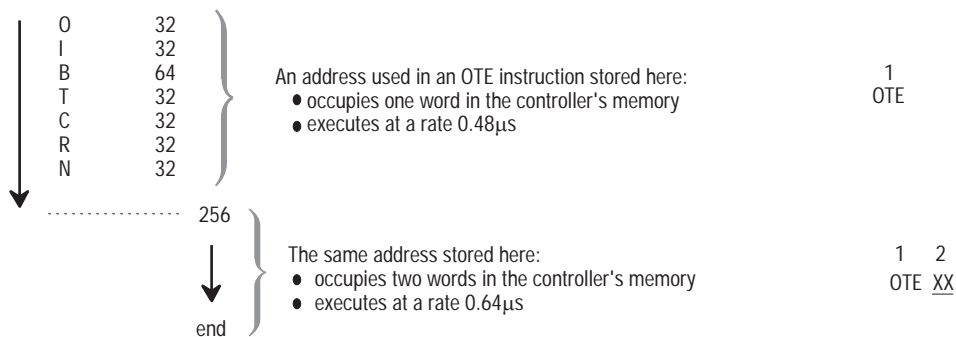

This example uses the instruction timing and memory usage tables in Appendix D. Consult these tables for information about other instructions.

**Element address example**

Your data table map looks like this:

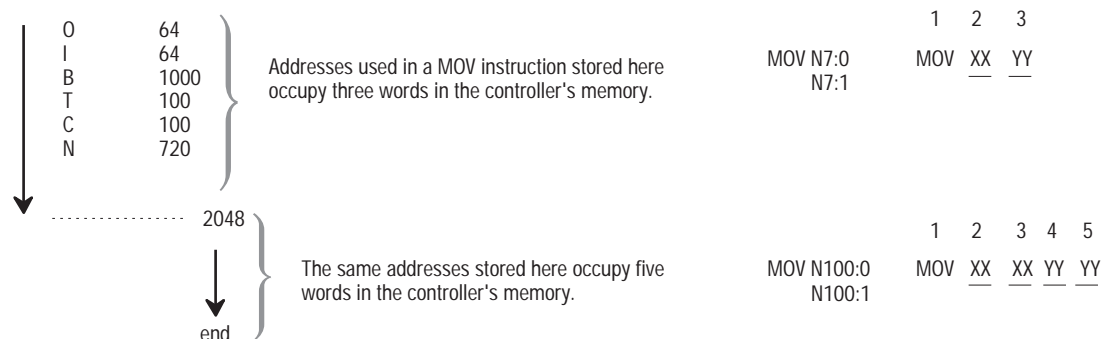

This example uses the instruction timing and memory usage tables in Appendix D. Consult these tables for information about other instructions.

## Effectively Using I/O Memory

The PLC-5 controller automatically allocates both an input and output memory location to each I/O location. I/O modules generally only use either the inputs or the outputs. To more effectively use I/O memory, you can use these methods of placing I/O modules.

Use	Application
2-slot	Install 16-point I/O modules as an input module and output module pair in an I/O group. For example, if you place an input module in slot 0, place an output module in slot 1.
1-slot	Install 32-point I/O modules as an input module and an output module pair in an I/O group. For example, if you place an input module in slot 0, place an output module in slot 1.
complementary I/O chassis	<p>You configure complementary chassis with a primary and complement chassis pair. You complement the I/O modules I/O group for I/O group between the two chassis. The I/O modules in the complementary chassis perform the opposite function of the corresponding modules in the primary chassis.</p> <p>By designating a PLC-5 scanner channel as complementary, you can complement racks 1-7. A channel configured for complementary I/O can't scan racks greater than 7. Those PLC-5 controllers that can address rack numbers greater than 7 can address these racks on another scanner channel which has not been configured as complementary. The remote I/O link device (such as a1771-ASB adapter) must also be configured for complimentary.</p> <p>For more information see the PLC-5 Reference Guide: Configuring Complementary I/O for PLC-5 Controllers, publication 1785-6.8.3.</p>

# Communicating with Controller-Resident I/O

## Using This Chapter

For Information About	Go to Page
Introduction to PLC-5 controller scanning	5-1
Program scanning	5-2
Transferring data to controller-resident I/O	5-3
Configuring the system for controller-resident I/O	5-4

This chapter explains how to configure the controller to communicate with resident I/O:

1. Set the I/O chassis switch for the addressing mode.
2. Set the rack address.

The rack address defaults to 0. If you want to change the rack address to 1, set bit S:26/2.

## Introduction to PLC-5 Controller Scanning

The basic function of a programmable-controller system is to:

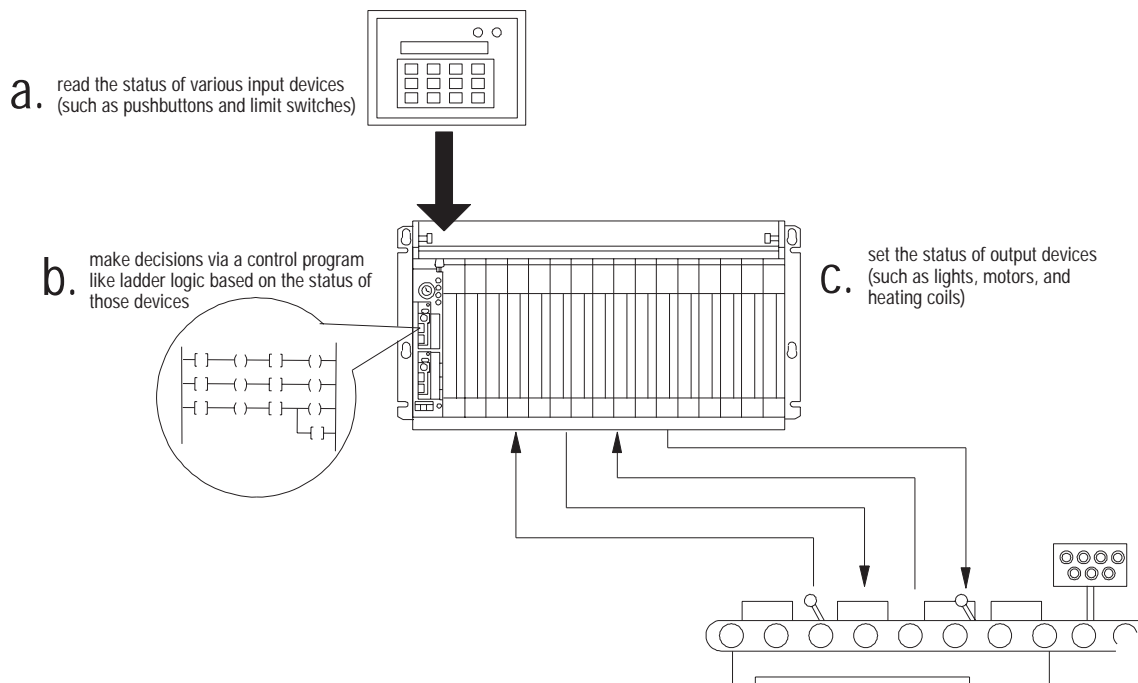

The controller performs two primary operations:

- program scanning where
  - logic is executed
  - housekeeping is performed
- I/O scanning - where input data is read and output levels are set

During **logic scan**, inputs are read from and outputs are written to the I/O image table.

During **housekeeping**, data exchange occurs between the I/O image table and the remote I/O buffer, extended local I/O, and controller-resident rack.

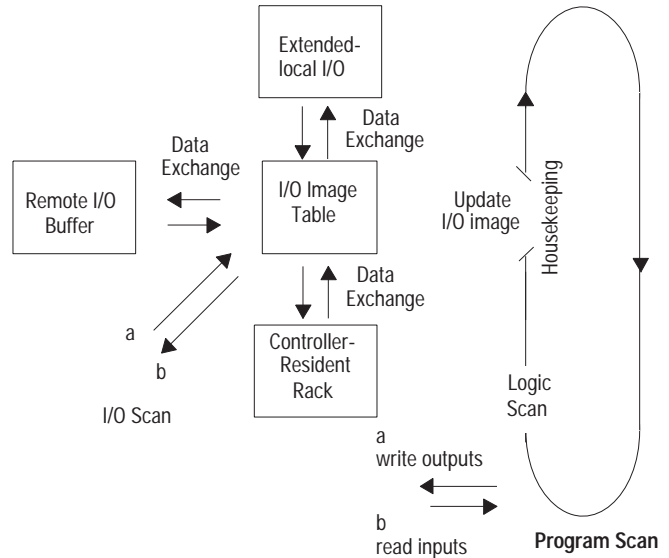

## Program Scanning

The program scan is the time it takes the controller to execute the logic program once, perform housekeeping tasks, and then start executing logic again.

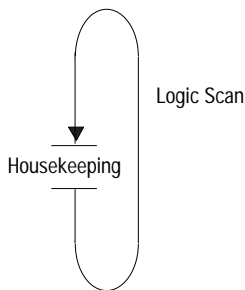

The controller continually performs a logic program scan and housekeeping. Housekeeping activities for PLC-5 controllers include:

- performing controller internal checks
- updating the input image table with:
  - controller-resident input module data
  - remote input module data as contained in the remote I/O buffer
  - extended local I/O input module data
- sending output image table data to:
  - controller-resident output modules
  - remote I/O buffer
  - extended local I/O output modules

## Transferring Data to Controller-Resident I/O

A PLC-5 controller transfers discrete and block-transfer data with controller-resident I/O.

### Transferring Discrete Data to Controller-Resident I/O

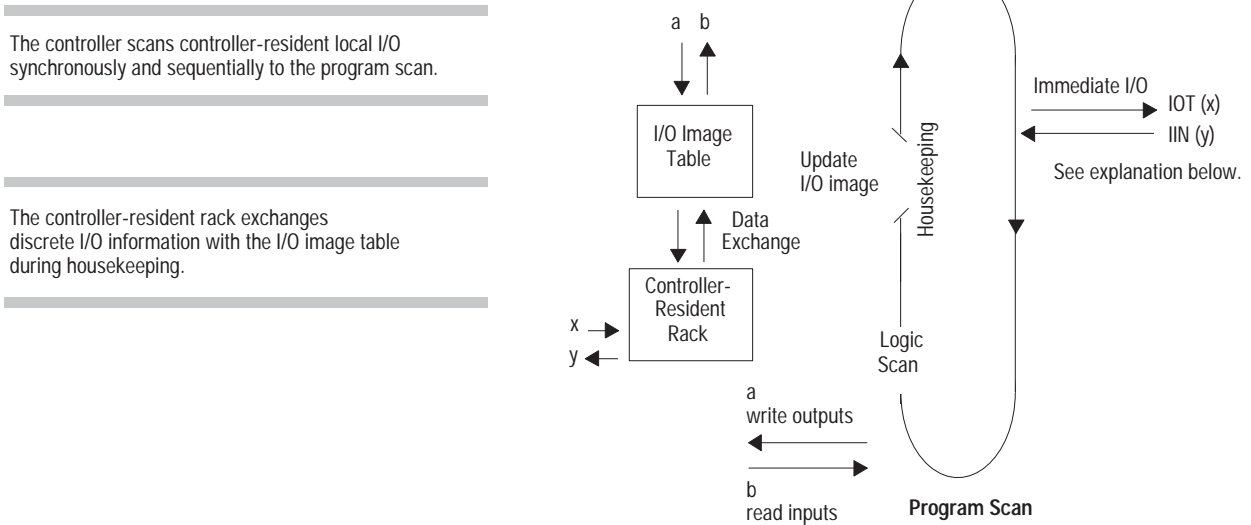

The controller scans controller-resident local I/O synchronously and sequentially to the program scan.

The controller-resident rack exchanges discrete I/O information with the I/O image table during housekeeping.

### Transferring Immediate I/O Requests

The controller responds to immediate input (IIN) and immediate output (IOT) requests during the logic scan. The logic scan is suspended at the request for immediate input/output data. The logic scan resumes after obtaining the data and fulfilling the request.

IIN data transfers directly to and IOT data transfers directly from I/O modules in controller-resident I/O and extended-local I/O chassis. With remote I/O, only the remote I/O buffer is updated. For more information, see Appendix D.

**TIP** When you place I/O modules, do not place a block-transfer module next to or in the same module group as an input module that you plan to use for immediate I/O. Place the modules in non-adjacent slots. Placing input modules for immediate I/O next to block-transfer modules can result in a -5 Block-Transfer Read error.

If your application cannot support this configuration, condition the immediate I/O instructions with the control bits of the adjacent block-transfer module. This technique helps make certain that an adjacent block-transfer module is not performing a block-transfer while an immediate I/O instruction is executing in its adjacent input module.

### Transferring Block-Transfer Data to Controller-Resident I/O

The controller performs block-transfers at the same time as it scans the program.

Block-transfers to controller-resident local I/O follow these procedures:

- Block-transfer requests are queued for the addressed controller-resident local I/O rack.
- The active buffer continuously handles all block-transfer modules whose block-transfer instructions were enabled in the program scan via the queue scan in the order the requests were queued.
- Block-transfers of I/O data can finish and the done bit can be set anytime during the program scan.

The controller runs all enabled block-transfers of I/O data to controller-resident I/O continuously as each block-transfer request enters the active buffer.

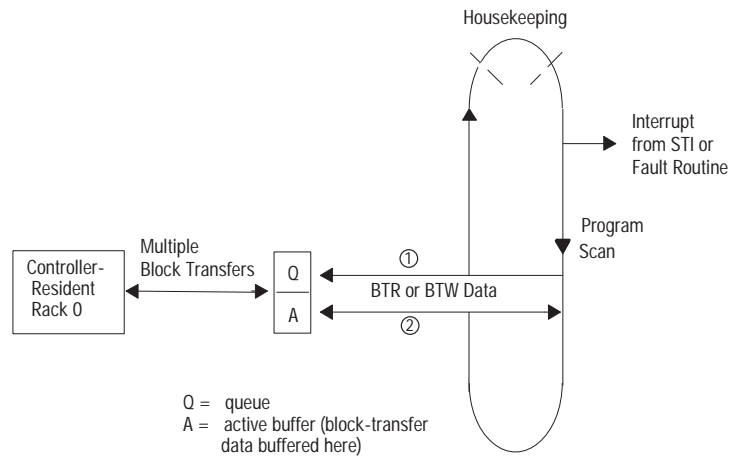

## Configuring the System for Controller-Resident I/O

To configure the system for controller-resident local I/O, you need to set the I/O chassis switch to indicate the rack-addressing mode. The addressing mode determines the number of controller-resident rack numbers used based on the number of slots in the chassis. For more information on addressing modes, see chapter 4. To set the I/O chassis switch, see Appendix E.

The controller-resident rack address defaults to rack 0. If needed, you can set it for rack 1 by setting user control bit 2 (S26:2) on the controller configuration screen in your programming software. If you select rack 1 as the controller-resident rack, rack 0 becomes unavailable for your system.



---

## Communicating with Remote I/O

### Using This Chapter

<b>For Information About</b>	<b>Go to Page</b>
Selecting devices that you can connect	6-2
Introduction to remote I/O	6-3
Designing a remote I/O link	6-4
Configuring a controller channel as a scanner	6-6
Communicating to a remote I/O node adapter	6-11
Transferring block data	6-13
Block-transfers of remote I/O data	6-15
Block-transfer sequence with status bits	6-17
Block-transfer programming considerations	6-19
Monitoring remote I/O scanner channels	6-21
Addressing the I/O status file	6-24

This chapter explains how to configure the controller to communicate with remote I/O:

- 1. Select which channel to configure as a scanner.**

- 2. Define the I/O status file.**

Use a unique, unused integer file. You must define an I/O status file if you want to autoconfigure your system.

- 3. Define a diagnostic file.**

Use a unique, unused integer file.

- 4. Define the scan list.**

## Selecting Devices That You Can Connect

The following table lists some of the devices you can use on a remote I/O link:

Category	Product	Catalog Number
Other Controllers (in adapter mode)	enhanced PLC-5 controllers	1785-LxxB
	Ethernet PLC-5 controllers	1785-LxxE
	ControlNet PLC-5 controller	1785-LxxC
	VMEbus PLC-5 controllers	1785-VxxB
	extended-local PLC-5 controllers	1785-LxxL
	classic PLC-5 controllers	1785-LTx
Other Controllers (in adapter mode)	Direct Communication Module for SLC Controllers	1747-DCM
To Remote I/O	SLC 500 Remote I/O Adapter Module	1747-ASB
	1791 Block I/O	1791 series
	Remote I/O Adapter Module	1771-ASB
	1-Slot I/O Chassis with Integral Power Supply and Adapter	1771-AM1
	2-Slot I/O Chassis with Integral Power Supply and Adapter	1771-AM2
	Direct Communication Module	1771-DCM
	FLEX I/O Adapter Module	1794-ASB
Operator Interfaces	DL40 Dataliner	2706-xxxx
	RediPANEL	2705-xxx
	PanelView Terminal	2711-xxx
Drives	Remote I/O Adapter for 1336 AC Industrial Drives	1336-RIO
	Remote I/O Adapter for 1395 AC Industrial Drives	1395-NA

## Introduction to Remote I/O

A remote I/O system lets you control I/O that is not within the controller's chassis. A PLC-5 controller channel, in scanner mode, transfers discrete and block-transfer data with remote I/O devices.

An example remote I/O system looks like this:

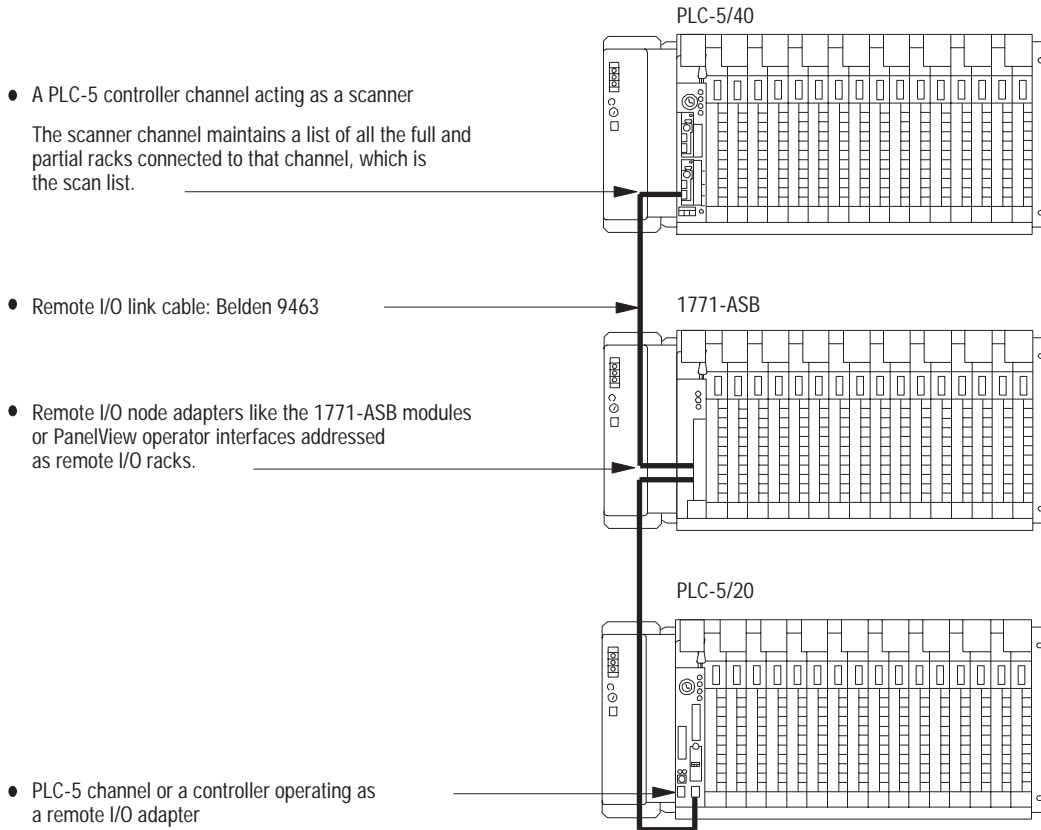

The remote I/O scanner channel keeps a list of all of the devices connected to each remote I/O link called a scan list. An example channel scan list looks like this:

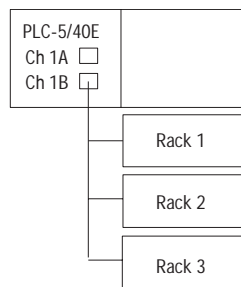

Ch 1B Scan List			
Rack Address	Starting Group	Rack Size	Range
1	0	Full	010-017
2	0	1/2	020-023
3	0	Full	030-037

In this example, channel 1B continually scans the three racks in its scan list and places the data in the remote I/O buffer in the controller. The controller updates its own buffer and the I/O image table. During housekeeping, the two buffers are updated by exchanging the input and output data with each other.

For more information on scan lists, see page 6-9.

Follow these steps for setting up a remote I/O system:

For this Step	See
1.configure the remote I/O adapter devices	the device's user manual
2.layout and connect the remote I/O link cable	<ul style="list-style-type: none"> <li>• page 6-4 for design</li> <li>• chapter 3 for cable routing information</li> <li>• your controller's installation information (For enhanced PLC-5 controllers, see publication 1785-IN062; for Ethernet PLC-5 controllers publication 1785-IN063)</li> </ul>
3.configure the scanner channel	page 6-6

## Designing a Remote I/O Link

Designing a remote I/O link requires applying:

- remote I/O link design guidelines
- cable design guidelines

### Link Design Guidelines

#### TIP

Keep these rules in mind as you design remote I/O links:

- All devices connected to a remote I/O link must communicate using the same communication rate, either 57.6, 115.2, or 230.4 kbps. Choose a rate that all devices support.
- Two or more channels of the same controller operating in scanner mode cannot scan the same partial or full rack address. Assign unique partial and full racks to each channel used in remote I/O scanner mode.
- You can split rack addresses between scanner channels; however, issues arise when performing block-data transfer. See page 6-15.
- A scan list can have a maximum of 16 rack numbers or a maximum of 32 physical devices connected to it using 82- $\Omega$  termination resistors. See page 6-9 for more information about scan lists.

## Cable Design Guidelines

**TIP**

Specify 1770-CD (Belden 9463) cable. Connect a remote I/O network using a daisy chain or trunk line/drop line configuration.

**Trunk line/drop line considerations:**

When using a trunk line/drop line configuration, use 1770-SC station connectors and follow these cable-length guidelines:

- trunk line-cable length\*depends on the communication rate of the link
- drop-cable length\*30.4 m (100 cable-ft)

For more information about designing trunk line/drop line configurations, see the Data Highway/Data Highway Plus/Data Highway II/Data Highway-485 Cable Installation Manual, publication 1770-6.2.2.

Verify that your system's design plans specify cable lengths within allowable measurements.

**IMPORTANT**

The maximum cable length for remote I/O depends on the transmission rate. Configure all devices on a remote I/O link to communicate at the same transmission rate.

For daisy chain configurations, use this table to determine the total cable length you can use.

A Remote I/O Link Using this Communication Rate	Cannot Exceed this Cable Length
57.6 kbps	3,048 m (10,000 ft)
115.2 kbps	1,524 m (5,000 ft)
230.4 kbps	762 m (2,500 ft)

**IMPORTANT**

If you select the baud rate as 230.4 kbps, and you are using the serial port or a PLC-5 coprocessor, use channel 2 for better overall system performance.

For proper operation, terminate **both** ends of a remote I/O link by using the external resistors shipped with the programmable controller. Selecting either a 150Ω or 82Ω terminator determines how many devices you can connect on a single remote I/O link.

If Your Remote I/O Link	Use this Resistor Rating	The Maximum number of Physical Devices You can Connect on the Link:	The Maximum Number of Racks You can Scan on the ILink
operates at 230.4 kbps	82Ω	32	16
operates at 57.6 kbps or 115.2 kbps <b>and</b> no devices listed in the following table are on the link			
contains any device listed in the following table	150Ω	16	16
operates at 57.6 kbps or 115.2 kbps, and you do not require the link to support more than 16 physical devices.			

**I/O Link Devices that Require 150Ω Termination Resistors**

<b>Device Type</b>	<b>Catalog Number</b>	<b>Series</b>
Scanners	1771-SN 1772-SD, -SD2 1775-SR 1775-S4A, -S4B 6008-SQH1, -SQH2	All
Adapters	1771-AS	
	1771-ASB	A
	1771-DCM	All
Miscellaneous	1771-AF	

**Configuring a Controller Channel as a Scanner**

Use this table to help you determine the controller channels you can configure as a remote I/O scanner:

<b>Controller</b>	<b>Channels that Support Remote I/O Scanner</b>
PLC-5/11	1A
PLC-5/20	PLC-5/20E 1B
PLC-5/30 PLC-5/40L PLC-5/60L	PLC-5/40E PLC-5/80E 1A, 1B
PLC-5/40 PLC-5/60 PLC-5/80	1A, 1B, 2A, 2B

To configure a controller channel as a scanner, you:

- define an I/O status file, which stores information about the racks connected to the controller, by using the controller configuration screen in your programming software
- specify the scanner's communication rate and diagnostic file and define a scan list by using the scanner mode channel configuration screen in your programming software

## Define an I/O Status File

The I/O status file stores data for the controller's I/O rack configuration tables. The I/O status from each remote I/O rack requires two words. These two words store the reset, present, inhibit, and fault bits for each rack.

To define an I/O status file, enter an unused integer file number (9-255) in the I/O status file field (S:16) of the controller configuration screen. If you do not want to use I/O rack configuration tables, enter 0. However, if you want to use the autoconfiguration option to create your scan list, you must define an I/O status file. Use the controller configuration screen in your programming software:

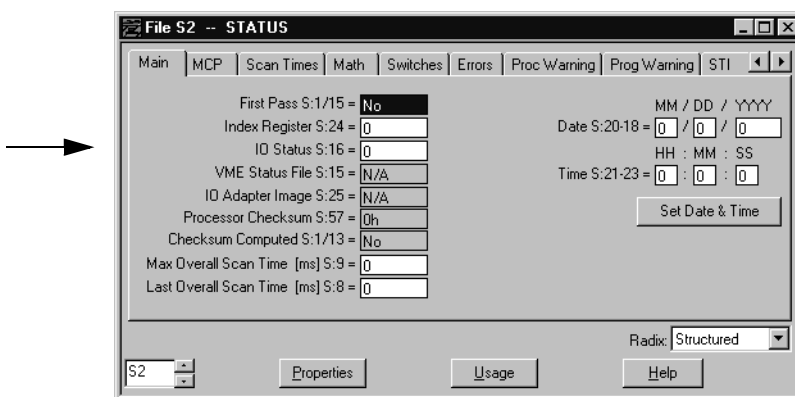

## Specify Channel Configuration Information

Use the scanner mode configuration screen in your programming software to configure a channel for scanner mode.

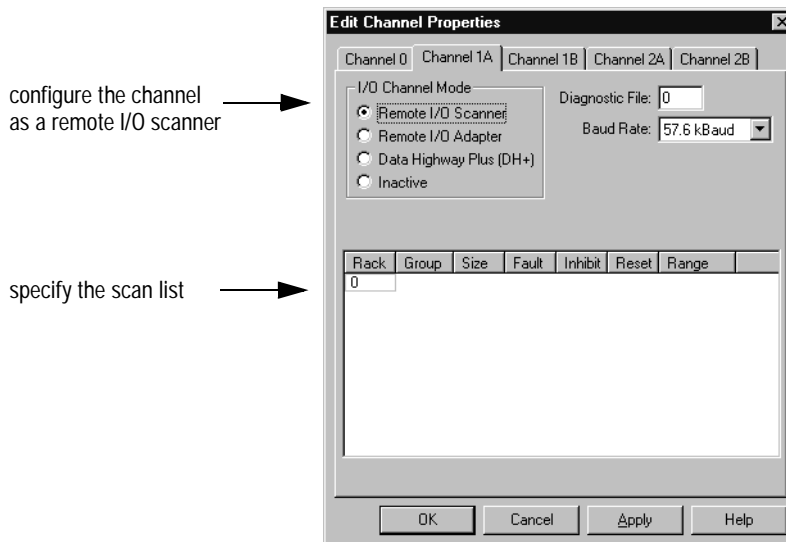

---

<div style="background-color: black; color: white; padding: 2px 5px; display: inline-block;"><b>ATTENTION</b></div> 	<p>Assign a unique diagnostic file to each channel. Do not assign a diagnostic file that is the I/O status file you assigned or any other used integer file. Unpredictable machine damage can result.</p>
--	---

---

In this Field	Define	By Doing the Following
Diagnostic file	The file containing the channel's status information: <ul style="list-style-type: none"> <li>• messages received</li> <li>• messages sent</li> <li>• messages received with error</li> <li>• unable to receive</li> <li>• sent with error</li> <li>• rack retries</li> </ul>	Cursor to the field, type an integer file number (9-999)
Baud rate	The communication rate for the remote I/O scanner mode link	Cursor to the field and select the desired rate. Available rates are: 57.6, 115.2, and 230.4 kbps.

---

<div style="background-color: black; color: white; padding: 2px 5px; display: inline-block;"><b>IMPORTANT</b></div>	<p>You must define a diagnostics file for a channel configured for anything but unused (even if you are not using the channel) if you want to get status information for that channel.</p>
---	--

---



## Specify the Scan List

A scan list is a map of the I/O devices being scanned by the scanner channel. For the channel to communicate with the I/O devices connected to it, you must create a scan list.

To	Do the Following
Create a scan list	<p>Make sure the controller is in Remote Program or Program mode.</p> <ol style="list-style-type: none"> <li>1. Make sure that you defined an I/O status file on the controller configuration screen (see page 6-7).</li> <li>2. Accept any edits made to the channel configuration.</li> <li>3. Use the autoconfiguration function</li> </ol> <p>If you have errors when you accept edits, clear the scan list and accept edits again.</p> <p>If you encounter the error message "Resource not Available," you have not defined an I/O status file. Define the I/O status file and try automatic configuration again.</p>
Insert an entry into the scan list	<p>Make sure the controller is in Remote Program, Program, or Remote Run mode.</p> <ol style="list-style-type: none"> <li>1. Position the cursor at the place on the scan list where you want to insert an entry.</li> <li>2. Insert an entry into the list and enter the appropriate values for the list.</li> </ol> <p><b>Important:</b> If incorrect information is entered for an entry, the controller will not display the new configuration when you save edits.</p>
Delete an entry for the scan list	<p>Make sure the controller is in Remote Program, Program, or Remote Run mode.</p> <ol style="list-style-type: none"> <li>1. Position the cursor at the place on the scan list where you want to delete an entry.</li> <li>2. Delete the entry from the list.</li> </ol> <p><b>Important:</b> If incorrect information is entered for an entry, the controller will not display the new configuration when you save edits.</p>

A scan list includes the following:

For this Field:	A Scan List Contains
Rack address	<p>1-3 octal (PLC-5/11, -5/20, -5/20E controllers)</p> <p>1-7 octal (PLC-5/30 controllers)</p> <p>1-17 octal (PLC-5/40, -5/40L, -5/40E controllers)</p> <p>1-27 octal (PLC-5/60, -5/60L, -5/80, -5/80E controllers)</p> <p>If complementary I/O is enabled, a C appears before the complemented rack address.</p>
Starting group	0, 2, 4, or 6
Rack size	1/2, 1/4, 3/4, or FULL
Range	<p>Automatically calculated based on rack address, starting module group and chassis size.</p> <p>An asterisk (*) after a range indicates the last valid rack entry.</p>

**TIP**

If you need multiple updates to an I/O device during an I/O scan, you can enter a logical address in the scan list more than one time. Do not assign the same partial or full rack address to more than one channel in scanner mode. Each channel must scan unique partial and/or full rack addresses.

Keep these limitations in mind when creating/modifying a scan list:

- The automatic configuration always displays the actual hardware configuration, except for racks that have their global-rack inhibit bit set. In this case, the global-rack bit overrides the automatic configuration. You must first clear the global-rack inhibit and then select autoconfigure.
- Clear global-rack inhibit bits for the channel that scans the racks that you want to resume scanning. Use the scanner mode status screen in your programming software.
- If you change a channel configuration from adapter or DH+ mode to scanner mode, use the clear list function of your programming software to clear the scan list. In any other instance where you need to clear entries from the scan list, use the delete-from-list function to delete the entries one at a time.

## Communicating to a Remote I/O Node Adapter

A scanner channel exchanges discrete data with remote I/O node adapters like 1771-ASB modules via the remote I/O buffer.

### Remote I/O Scan and Program Scan Loops.

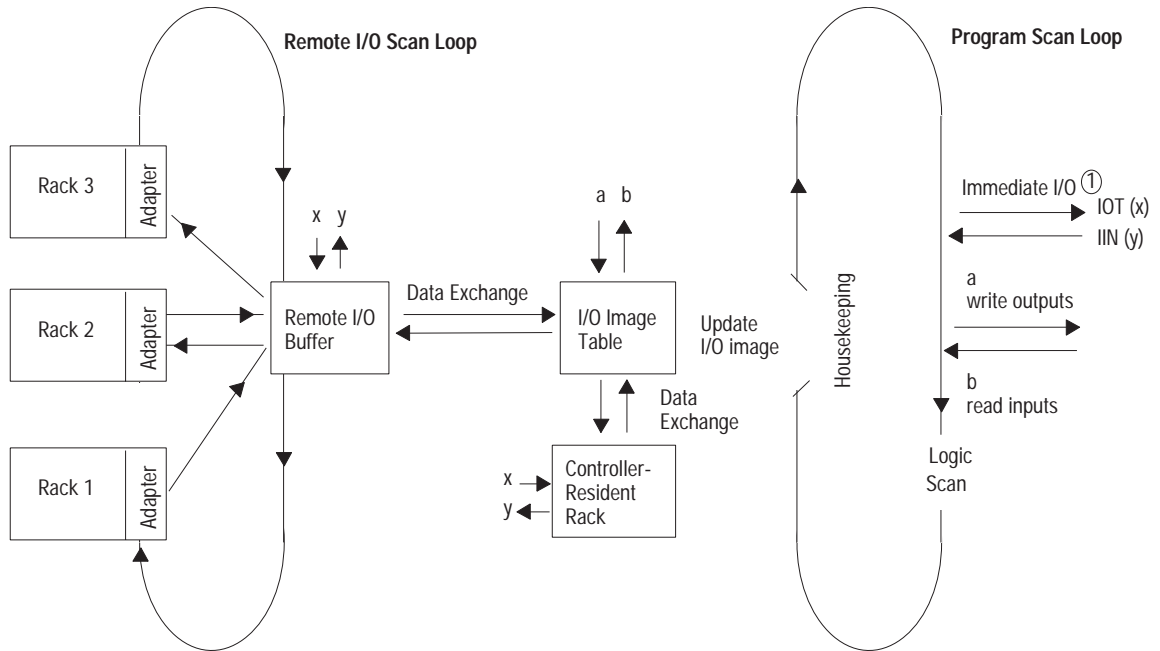

The remote I/O scan is the time it takes for the controller to communicate with all of the entries in its rack scan-list once. The remote I/O scan is independent of and asynchronous to the program scan.

During housekeeping:

- Data exchange between the I/O image table, the controller-resident rack, and the remote I/O buffer occurs.
- The remote I/O buffer is updated.

Remember that the I/O scanner is constantly updating the remote I/O buffer asynchronously to the program scan.

① In remote racks, immediate I/O data transfers update the remote I/O buffer.

### IMPORTANT

The remote I/O scan for each channel configured for scanner mode is independent and asynchronous to the remote I/O scan for any other channel

#### For the Scanner Channel to Communicate with the 1771-ASB Adapter Modules, Do the Following

1. Set the I/O chassis backplane switch for each chassis that houses an adapter module.
2. Set the switches on the adapter module itself.
3. Connect the remote I/O cable.

#### For More Information, See:

Appendix E

your controller installation instructions

## Troubleshooting Remote I/O Communication Difficulties

Follow these steps to make sure the controller can communicate with devices on remote I/O links.

- 1.** Put the controller in program mode. Go into the memory map and find two unused file numbers. The controller will use these files. Do not create the files, just record which file numbers you will use.
- 2.** Go to the controller status screen and make sure all rack inhibit bits are zeroed (0).
- 3.** Go to the controller configuration screen and assign one of the previous file numbers to be the I/O status file (see page 6-7).
- 4.** Go to the channel configuration screen for the appropriate channel and assign the remaining file number (from above) to be the channel diagnostic file (see page 6-7).
- 5.** Perform an autoconfigure and confirm that all the racks were found and listed in the I/O scan list.
- 6.** Check all I/O rack retry counters in channel status to make sure there are no communications problems.

If you follow the above steps and there are still remote I/O communications problems, it is possible that the I/O status file is corrupt. Try assigning a brand new I/O status file and repeat the steps above. Also, confirm that the I/O image tables exist for the racks you are having difficulty communicating with.

## Transferring Block Data

In addition to discrete data, the controller can also exchange block data with remote I/O. Block-transfer instructs the controller to interrupt normal I/O scanning and transfer as many as 64 words of data to/from a selected I/O module. The figure below shows how the scanner-mode controller handles a block-transfer.

### Block-Transferring Data to Controller-Resident Local, Extended-Local, and Remote I/O

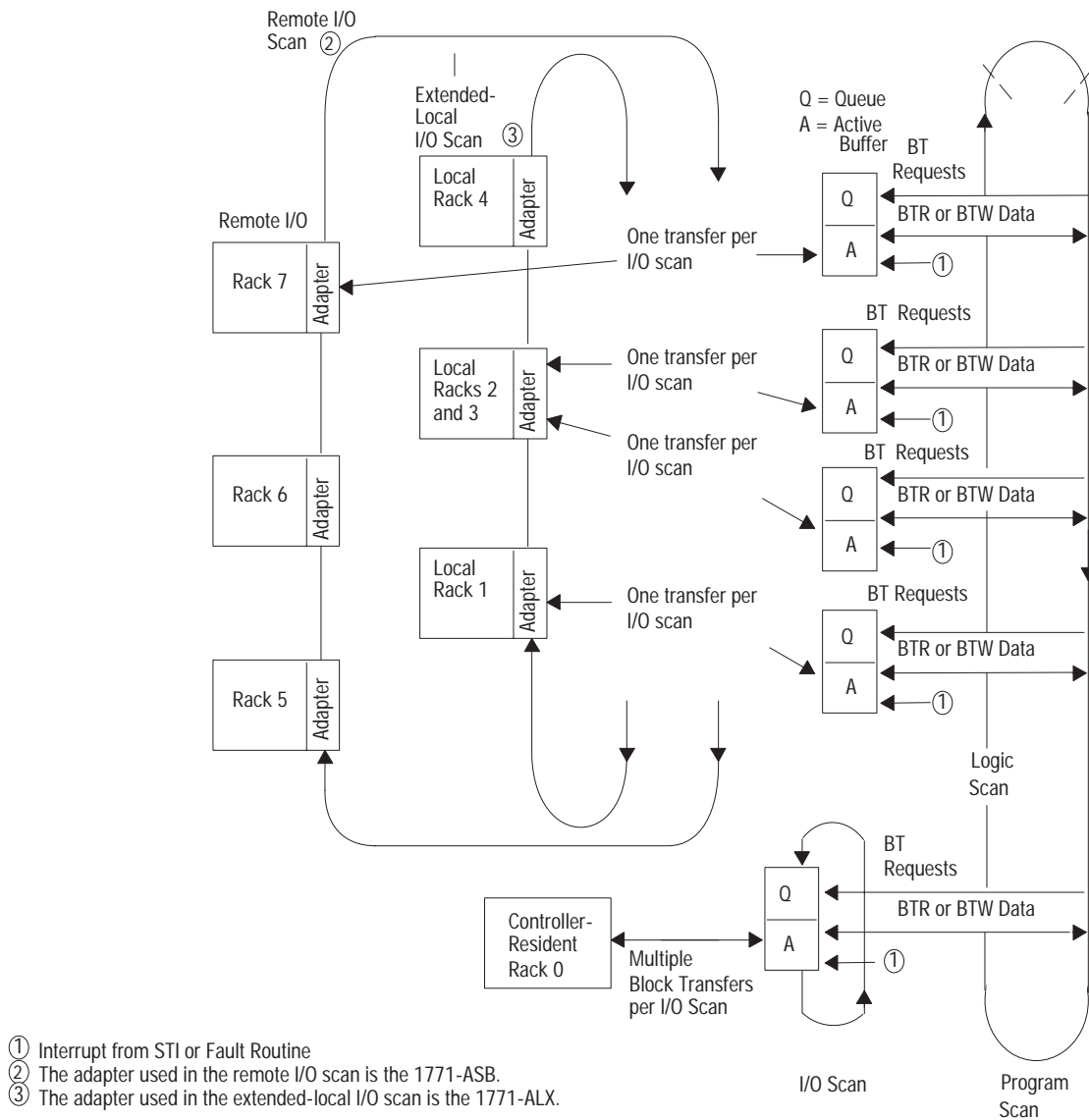

15299

As shown in the previous figure, the controller has the following storage areas for block-transfers:

Maximum Number of Active Buffers Per Remote I/O Channel	
PLC-5/60, -5/60L, -5/80, -5/80E	23
PLC-5/40, -5/40L, -5/40E	31
PLC-5/30	39
PLC-5/20, -5/20E	43
PLC-5/11	43

Placing the controller in program mode, cancels block-transfers in the active buffers and in the waiting queues.

Storage Area	Description
active buffers	store initialized block-transfer requests for a channel The adjacent table lists the maximum active buffers for each enhanced and Ethernet PLC-5 controller. The controller places a block-transfer request <b>directly</b> into the active buffer only if: a buffer is available and no block-transfers to the slot is in the queue.
waiting queues	store block-transfer requests that cannot be placed into the active buffer because: all of the channel's active buffers are being used the slot addressed by the block-transfer is currently processing a block-transfer

Once a block-transfer to a slot completes, the controller checks the queue to see if a block-transfer addressed to the slot is waiting. If one exists, the controller moves it to the active buffer.

Since a controller can request a block-transfer from every slot in a chassis concurrently, the adapter device chooses the order in which the block-transfers execute on the chassis. Block-transfer requests are processed differently in fault routines, selectable timed interrupt routines (STI), and controller input interrupt routines (PII); see chapters 16, 18, and 19 respectively for more information.

## Block-Transfer Minor Fault Bits

Minor Fault	Description
S:17/0 Block-transfer queue full to remote I/O	There is a possibility that the PLC-5 controller might temporarily be unable to initiate multiple consecutive user-programmed block-transfers. For any block-transfer which temporarily can't be processed, the PLC-5 controller sets minor fault bit S:17/0 and skips that block-transfer instruction. This condition is self-correcting, but bit S:17/0 remains set until you reset it. You can avoid this minor fault by separating block-transfer instruction rungs with other rungs.
S:17/1 through S:17/4 Queue full - channel xx	<p>The PLC-5 controller can process a maximum of 64 remote block-transfers per channel pair (1A/1B or 2A/2B). This maximum includes:</p> <ul style="list-style-type: none"> <li>block-transfers that are currently in the active buffer</li> <li>initialized block-transfers that are waiting for execution in the holding queue</li> </ul> <p>Once the 64 block-transfer maximum is reached, the following minor fault bits are set, depending on which channel pair is involved:</p> <p><b>Channel pair: Minor fault bits set:</b>            1A/1BS:17/1 and S:17/2            2A/2BS:17/3 and S:17/4</p> <p>The PLC-5 controller won't initialize any remote block-transfer instruction which exceeds the 64 maximum. The .EW, .DN, and .ER bits are reset on any block-transfer which exceeds the 64 maximum. This condition is self-correcting, but the bits remain set until you reset them.</p>
S:10/7 No more command blocks exist	<p>This minor fault bit is normally associated with an application programming problem, but this bit can also be set when using block-transfers if the maximum number of command blocks available in the PLC-5 controller is exceeded. The command blocks are used by both the local and remote block-transfers.</p> <p><b>PLC-5 type: Maximum number of command blocks:</b>            PLC-5/11, -5/20, -5/30 128            PLC-5/40 256            PLC-5/60, -5/80 384</p> <p>This condition generally occurs when a program attempts to repeatedly initialize block-transfers which have not yet completed with a .DN or .ER bit. This condition is self-correcting, but bit S:10/7 remains set until you reset it.</p>

## Block-Transfers of Remote I/O Data

Block-transfers of I/O data to remote I/O follow these guidelines:

- Block-transfer data exchange and the program scan run independently and concurrently. Once block-transfers are initiated, the controller performs them asynchronously to the program scan.
- During every remote I/O scan, the Controller performs a maximum of one block-transfer per entry in the scan list.

**IMPORTANT**

If you split remote rack addresses between scanner channels, block-transfers to lower priority scanner channels do not function properly. Scanner channels have priority according to the following order: 1A, 1B, 2A, then 2B.

For example: if you configure channels 1B and 2A as remote scanners and split rack #2 between them, block-transfers to channel 1B (the higher priority channel) will be completed, but block-transfers to the second half of rack #2 (2A, the lower priority channel) will not be completed.

Although splitting remote I/O racks across scanner channels does not affect discrete transfers, I/O status bits such as Fault and Present may not indicate the correct status.

The figure below shows the remote I/O block-transfer sequence.

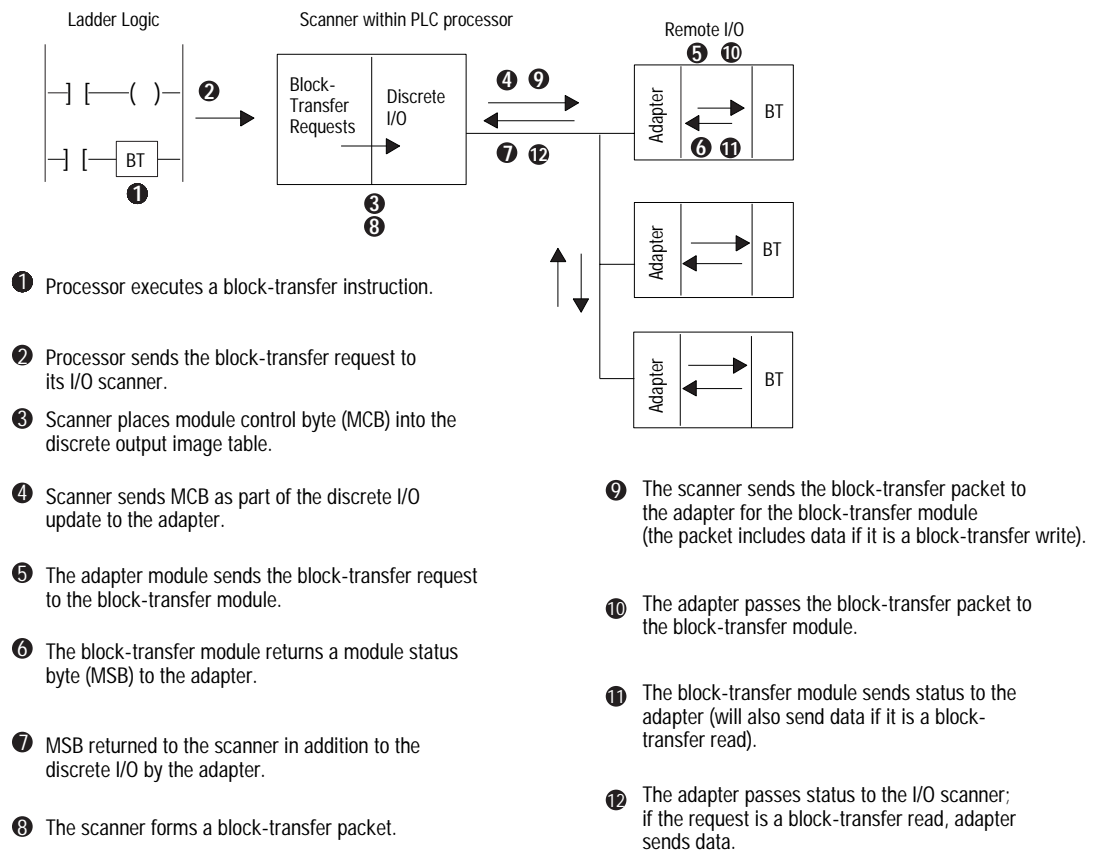



## Block-Transfer Sequence with Status Bits

The following figure describes the different states of the block-transfer status bits.

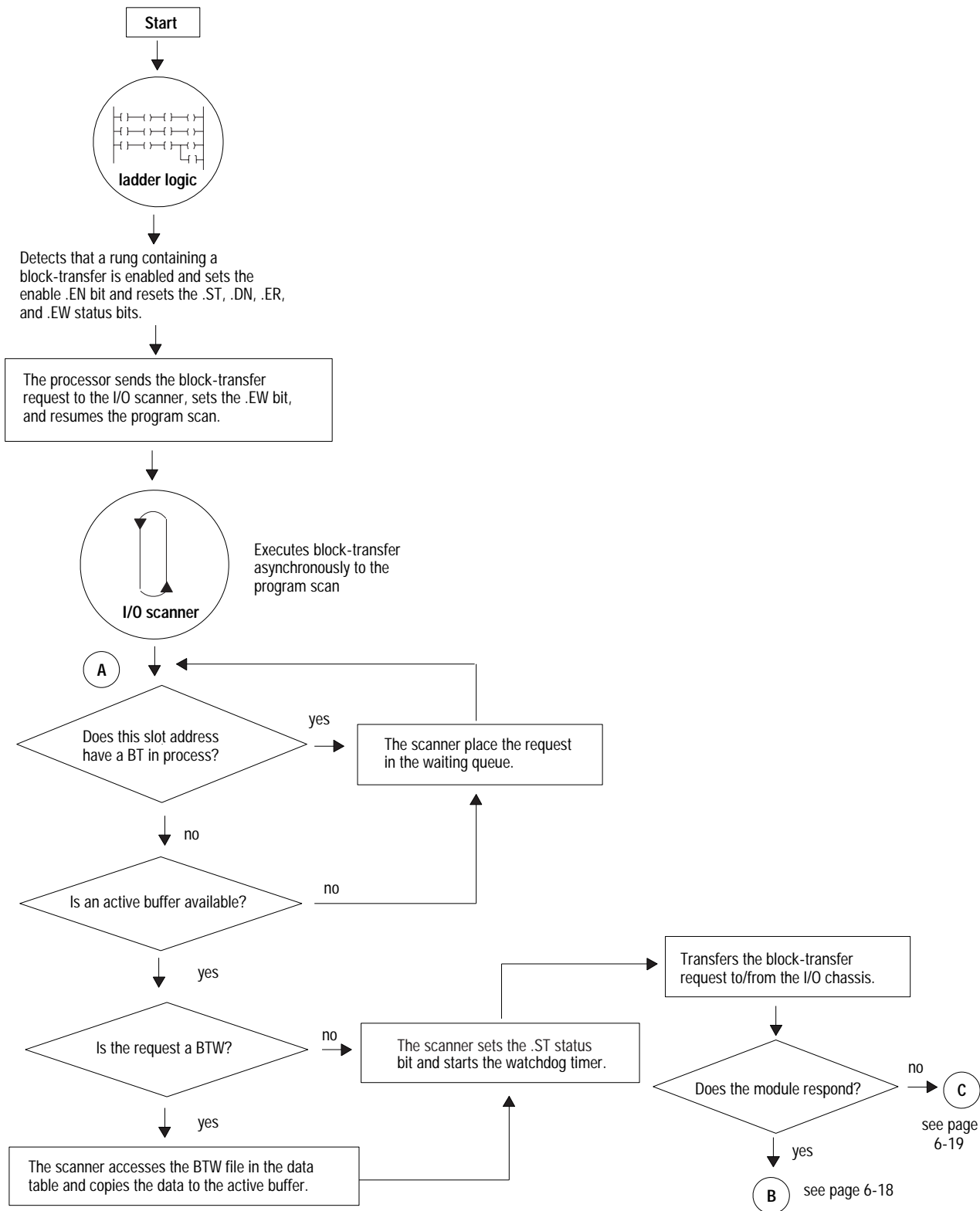

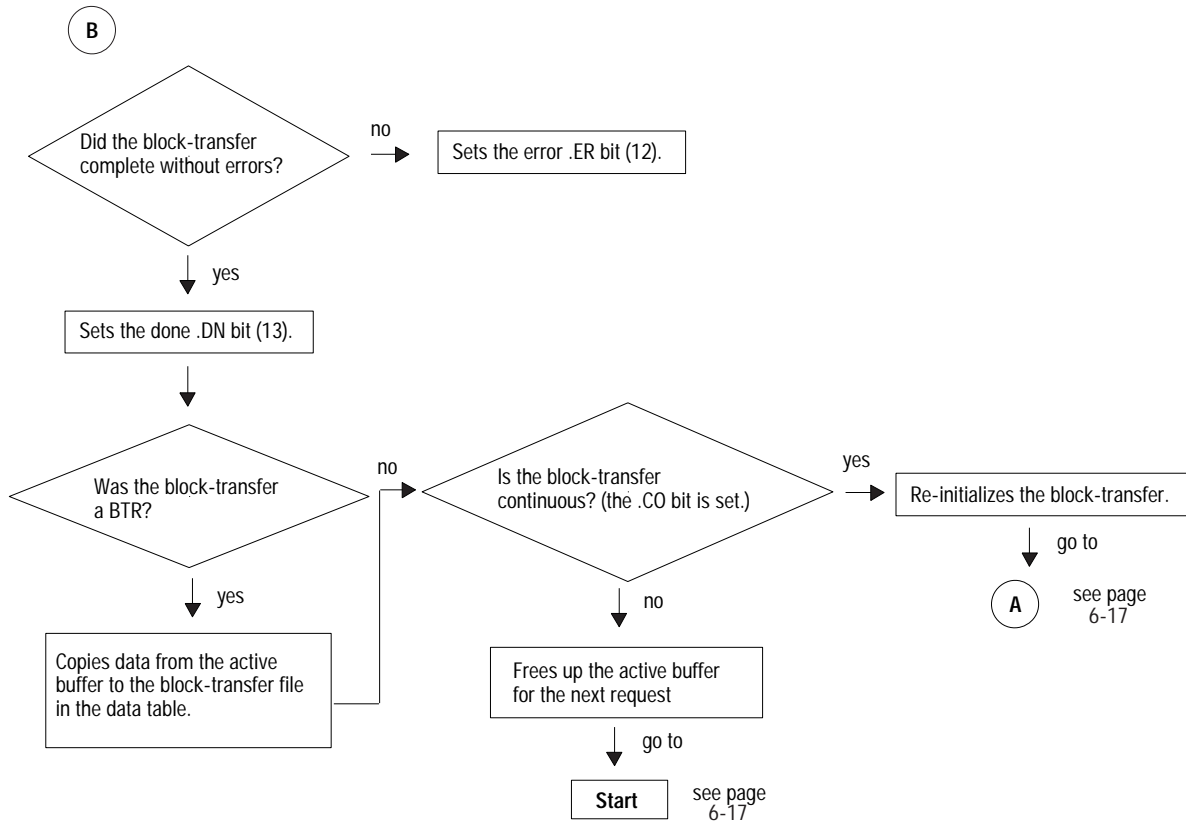

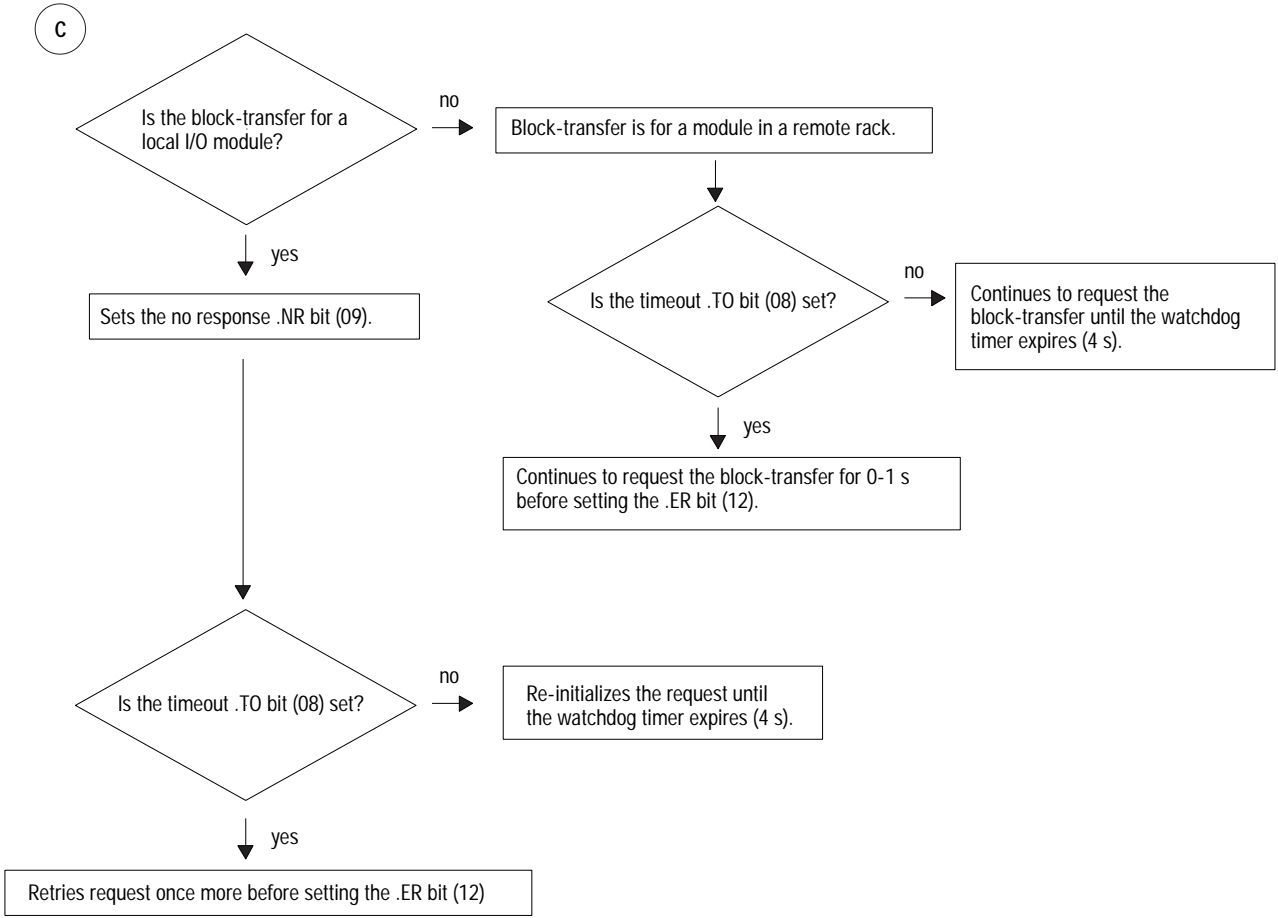

For a list of block-transfer error codes, see the PLC-5 Programming Software Instruction Set Reference, publication 1785-6.1.

## Block-Transfer Programming Considerations

Read this section for information about general programming considerations and considerations for controller-resident local racks.

### General Considerations

The following are general programming considerations when you are block-transferring I/O data.

- When performing block-transfers (controller-resident local or remote I/O) in any PLC-5 controller, clear the output image table corresponding to the block-transfer module rack location before changing to run mode. If you do not clear the output image table, then you encounter block-transfer errors because unsolicited block-transfers are being sent to the block-transfer module (i.e., if a block-transfer module is installed in rack 2, group 4, clear output word O:024 to 0; do not use the word for storing data).
- If you use remote block-transfer instructions and have the timeout bit (.TO) set to 1, then the controller disables the 4-second timer and continues to request the block-transfer for 0-1 seconds before setting the error (.ER) bit.
- A PLC-5 controller with at least one channel configured as an adapter could incur a non-recoverable fault when you switch it from run to program mode.

To avoid this possibility, program the scanner to request only two or three block-transfers from the PLC-5 adapter at one time by conditioning the block-transfer instructions with the done/error bits.

## For Controller-Resident Local Racks

The following are programming considerations when you are block-transferring data in a controller-resident local rack.

- Within the controller-resident local rack, limit the number of continuous-read block-transfers to 16 transfers of 4 words each or 8 transfers of 64 words each. If you attempt to exceed this block-transfer limit, a checksum error (error code -5) occurs.
  - Block-transfer instructions to any of the following modules residing in the controller-resident local rack result in frequent checksum errors.
    - 1771-OFE1, -OFE2, and -OFE3 modules; all versions prior to series B, revision B
    - 2803-VIM module, all versions prior to series B, revision A
    - IMC-120, all versions
  - To eliminate the checksum errors, replace your modules with the current series and revision. If replacement is not possible:
1. Go to the controller configuration screen in your programming software.
  2. With the controller in program mode, set user control bit 4 (S:26/4) to 1 (the local block-transfer compatibility bit).
  3. Change the controller mode from program to run.

- Do not program IIN or IOT instructions to a module in the same physical module group as a BT module unless you know a block-transfer is not in progress. If you must do this, then use an XIO instruction to examine the .EN bit of the block-transfer instruction to condition the IIN and IOT.

## Monitoring Remote I/O Scanner Channels

To monitor channels configured as a scanner, use the scanner mode status screen in your programming software. This screen displays the data in the diagnostic file you defined on the scanner mode configuration screen (page 6-7).

### Monitoring transmission retries

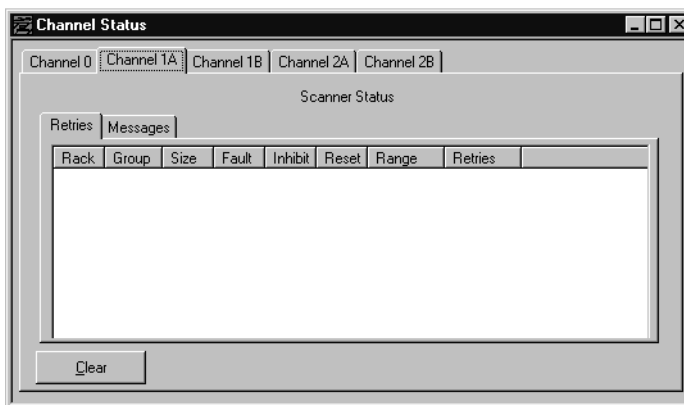

Status Field	Location	Description
Retries Tab		
Retry	word 5 etc. word 69	Displays the number of retries for the corresponding rack entry. Entry 1 etc. Entry 64

Status Field	Location	Description
Rack Address		<p>This field indicates the rack number of the remote racks being scanned by the scanner channel:</p> <ul style="list-style-type: none"> <li>can only scan rack 3 (PLC-5/11 controller)</li> <li>1-3 octal (PLC-5/20, -5/20E controller)</li> <li>1-7 octal (PLC-5/30 controllers)</li> <li>1-17 octal (PLC-5/40, -5/40L, 5/40E controllers)</li> <li>1-27 octal (PLC-5/60, -5/60L, -5/80, -5/80E controllers)</li> </ul> <p>If complementary I/O is enabled (on the scanner mode configuration screen), the complement of a rack is identified with a C to the left of the rack address column on the status screen.</p>
Starting Group		This field indicates the first I/O module group in the rack that the controller scans.
Rack Size		This field displays the portion of the I/O rack addressed by each chassis. Configurations can be 1/4, 1/2, 3/4, or FULL as long as the total sum of the rack does not exceed 8 I/O groups.
Range		This field displays the rack address and module groups being scanned for a rack in the scan list. An asterisk (*) after a range indicates that it is the last valid rack entry.
Fault		<p>An F displayed in this field indicates that the corresponding chassis is faulted. When a fault indicator appears, the system sets the associated fault bit in the global rack fault status on the controller status screen in your programming software.</p> <p>When the global rack fault bit is set, all configuration information starting at the faulted quarter is lost. When a rack faults, F is displayed. If both the fault and inhibit bits are set for a rack, no rack exists at that I/O group.</p>
Inhibit		<p>Inhibit a rack by cursoring to the <code>INHIBIT</code> field of the rack you want to inhibit and enter <code>1</code></p> <p>When a chassis is inhibited the controller stops scanning it. You can inhibit an entire rack by setting the global rack-inhibit bit for that rack on the controller status screen. All chassis within that rack are inhibited, and an I appears in the <code>INHIBIT</code> field, indicating the rack was globally inhibited.</p>
Reset		<p>Reset a rack by cursoring to the <code>RESET</code> field of the rack you want to reset and type <code>1</code></p> <p>When a chassis is reset, the controller turns off the outputs of the chassis regardless of the last-state switch setting. You can reset an entire rack by setting the global rack-reset bit on the controller status screen. All chassis within that rack are reset, and an R appears in the <code>RESET</code> field indicating the rack was globally reset.</p>
Retry		This field displays the number of times the rack was re-scanned.

## Monitoring messages



Status Field	Location	Description
Messages Tab (Messages = SDA messages + SDN messages)		
Messages sent	word 1	Displays the number of messages sent by the channel.
Messages sent with error	word 3	Displays the number of messages containing errors sent by the channel.
Messages received	word 0	Displays the number of error-free messages received by the channel.
Messages received with error	word2	Displays the number of messages containing errors received by the channel (such as bad CRC).
Messages unable to receive	word 4	Displays the number of messages received with protocol-related problems (such as a bad block-transfer status byte with both read and write bits set).

## Addressing the I/O Status File

During program execution you can address words and fault bits within the I/O status file. The following figure shows the arrangement of the words in the I/O status file for a given remote or extended local I/O rack. The example status file used for the figures in this section is integer file 15.

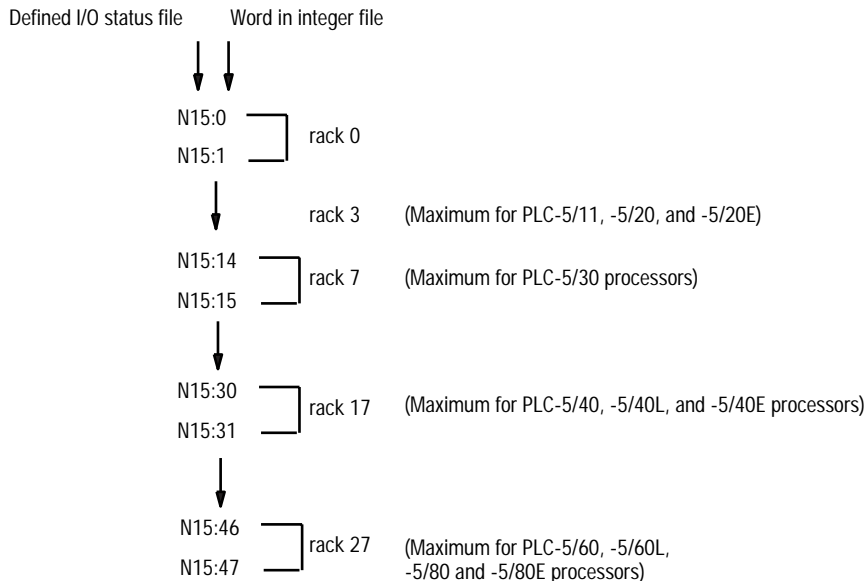

The first word for a rack contains present and fault bits, the second word contains reset and inhibit bits. The following figure shows present, fault, reset, and inhibit bit layouts for rack 7 in the I/O status file.

**IMPORTANT**

Setting inhibit bits in the I/O status file does not update inhibit bits in the controller status file.



**Bit Layout Diagrams for the First Word Allotted to a Remote I/O Rack or an Extended-Local I/O Rack**

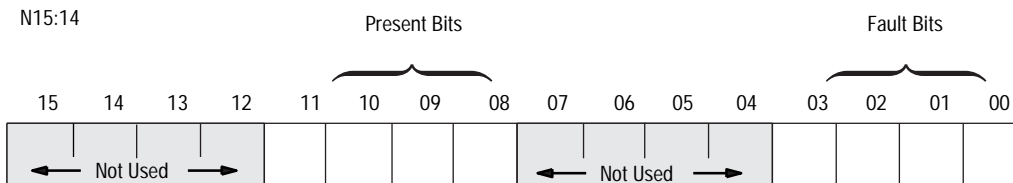

This Bit	Corresponds to
<b>Fault Bits</b>	
00	first 1/4 rack starting I/O group 0
01	second 1/4 rack starting I/O group 2
02	third 1/4 rack starting I/O group 4
03	fourth 1/4 rack starting I/O group 6
<b>Present Bits</b>	
08	first 1/4 rack starting I/O group 0
09	second 1/4 rack starting I/O group 2
10	third 1/4 rack starting I/O group 4
11	fourth 1/4 rack starting I/O group 6

**Bit Layout Diagrams for the Second Word Allotted to a Remote I/O Rack or an Extended Local I/O Rack**

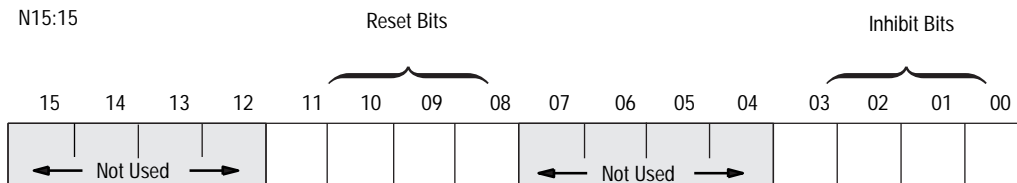

**This Bit:**                      **Corresponds to:**

**Inhibit Bits**

00	first 1/4 rack starting I/O group 0
01	second 1/4 rack starting I/O group 2
02	third 1/4 rack starting I/O group 4
03	fourth 1/4 rack starting I/O group 6

**Reset Bits**

08	first 1/4 rack starting I/O group 0
09	second 1/4 rack starting I/O group 2
10	third 1/4 rack starting I/O group 4
11	fourth 1/4 rack starting I/O group 6

**ATTENTION**



When you use a ladder program or the software to inhibit and reset an I/O rack, you must set or clear the reset and inhibit bits that correspond to each quarter rack in a given chassis. Failure to set all the appropriate bits could cause unpredictable operation due to scanning only part of the I/O chassis.

---

## Communicating with a PLC-5 Adapter Channel

### Using This Chapter

<b>For Information About:</b>	<b>Go to Page:</b>
Configuring communication to a PLC-5 adapter channel	7-2
Programming discrete transfers	7-10
Programming block-data transfers	7-10
Monitoring the status of the adapter channel	7-17
Monitoring the status of the supervisory controller	7-18
Monitoring remote I/O adapter channels	7-19

This chapter explains how to configure the controller to communicate with an adapter channel:

1. Select which channel to configure as an adapter.
2. Define a diagnostic file.
3. Use a unique, unused integer file.
4. Define the rack address, starting group and rack size.
5. The default rack address is rack 3.
6. Define the discrete transfer files (enter as decimal numbers).
7. The input source is where the supervisory controller's output discrete bits go (default is 001:024 - the decimal representation of rack 3). The output source is where the supervisory controller's input bits go (default is 000:024).
8. Create the necessary block-transfer control files (one BTR and one BTW).
9. Configure the block-transfers so the supervisory controller knows where to address block-transfers.

## Configuring Communication to a PLC-5 Adapter Channel

Because a PLC-5 controller adapter channel is more intelligent than a 1771-ASB module, data communication and configuration tasks are handled differently for adapter channels.

The supervisory controller or scanner channel and the adapter-mode controller channel automatically transfer discrete data and status between themselves via the supervisory controller's remote I/O scan.

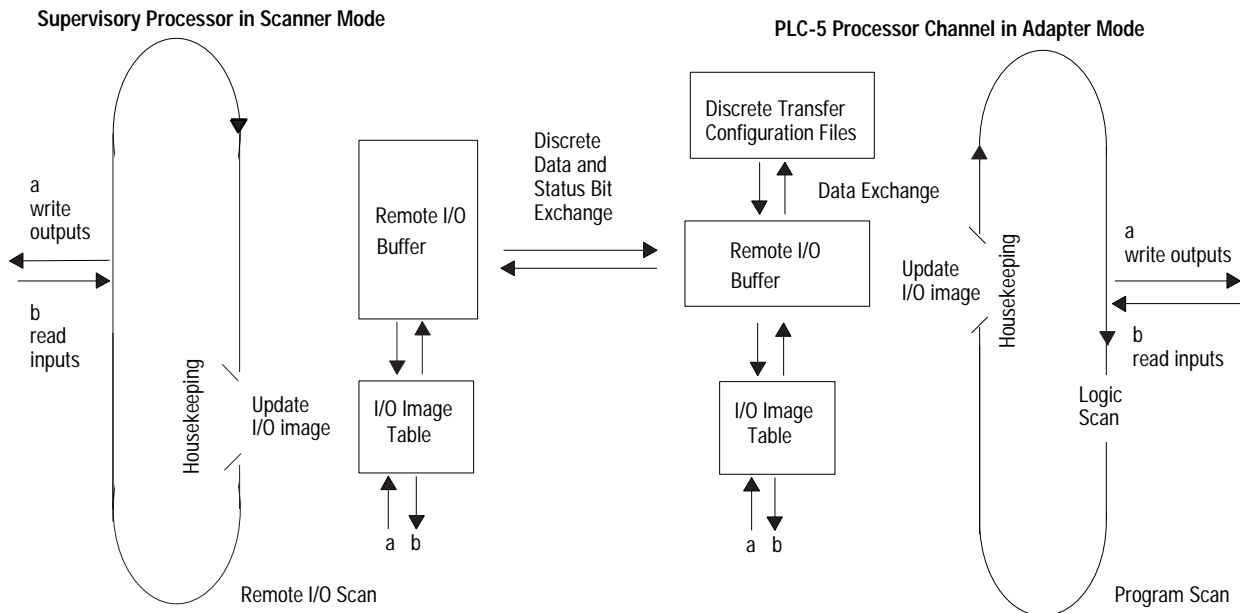

During each remote I/O scan, the supervisory processor transfers 2, 4, 6, or 8 words\* depending on whether the adapter-mode processor is configured as a 1/4, 1/2, 3/4, or full rack.

The adapter-mode processor transfers 2, 4, 6, or 8 words\* depending on whether it is configured as a 1/4, 1/2, 3/4, or full rack.

Discrete data and block-transfer status bits are transferred between a remote I/O scanner's I/O image table and an adapter channel via the adapter channel's discrete transfer configuration files, which you define on the adapter channel configuration screen.

### For the Scanner Channel to Communicate with a PLC-5 Controller Adapter Channel, Do the Following

### For More Information, See

1. Define the communication rate, its address, and rack size (number of words to transfer). page 7-3

2. Define the discrete transfer configuration files, which are the files from which the adapter controller channel gets the data sent by the supervisory controller and puts data into for the supervisory controller. page 7-5

3. If you plan to block-transfer data to the adapter channel, define the block-transfer files and configure the block-transfers. page 7-10

4. Connect the remote I/O cable. your controller installation instructions

## Specify an Adapter Channel's Communication Rate, Address, and Rack Size

Use this table to help you determine the controller channels you can configure as a remote I/O adapter:

Controller	Channels that Support Remote I/O Adapter
PLC-5/11	1A
PLC-5/20 PLC-5/20E	1B
PLC-5/30 PLC-5/40E	1A, 1B
PLC-5/40L PLC-5/80E	
PLC-5/60L	
PLC-5/40 PLC-5/80	1A, 2A, 1B, 2B
PLC-5/60	

To select a channel as an adapter, use the adapter mode configuration screen in your programming software.

configure the channel as a remote I/O adapter

specify adapter settings

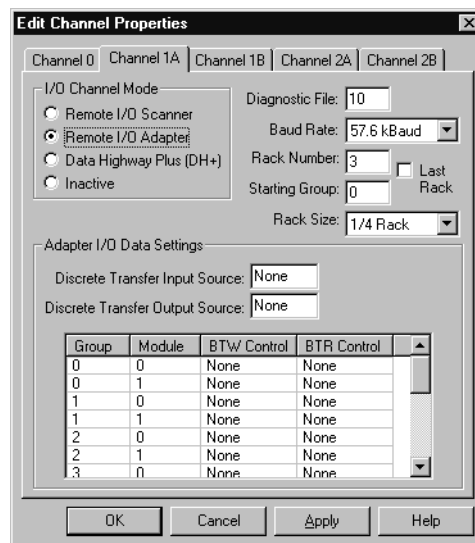

In this Field	Define	By Doing the Following
Diagnostic file	The file containing the adapter channel's status information	<p>Cursor to the field and enter an integer file number (9-999).</p> <p><b>ATTENTION:</b> Assign a unique diagnostic file to each channel. Do not assign a diagnostic file that is the I/O status file you assigned or any other used integer file. Unpredictable machine damage can result.</p> <p><b>Important:</b> You must define a diagnostics file for a channel configured for anything but unused (even if you are not using the channel) if you want to get status information for that channel.</p>
Baud rate	Communication rate for the remote I/O link	<p>Cursor to the field and select the desired rate.</p> <p>Available rates are: 57.6, 115.2, or 230.4 kbps.</p>
Rack number	The rack address of this PLC-5 controller as it appears to the scanner	<p>Cursor to the field and enter the address.</p> <p>Valid addresses are (based on the scanner this PLC-5 controller communicates with):</p> <ul style="list-style-type: none"> <li>3 octal (PLC-5/11 controllers)</li> <li>1-3 octal (PLC-5/20, -5/20E controllers)</li> <li>1-7 octal (PLC-5/30 controllers)</li> <li>1-17 octal (PLC-5/40, -5/40L, -5/40E controllers)</li> <li>1-27 octal (PLC-5/60, -5/60L, -5/80, -5/80E controllers)</li> </ul> <p>The default is rack 3.</p> <p><b>Important:</b> The valid addresses are based on the scanner, not the PLC-5 controller you are configuring. For example, if you are configuring a PLC-5/20, you could enter a rack address between 1-27 if the scanner you will be communicating with is a PLC-5/60.</p>

In this Field	Define	By Doing the Following
Last rack	Notifies the supervisory controller that this is the last chassis  This information is important when the supervisory controller is a PLC-2 controller.	Select the check box if this is the last rack.
Starting group	The starting group number of the rack	Cursor to the field and enter the number  Valid entries are: 0, 2, 4 or 6.
Rack size	The number of I/O words to exchange with the supervisory controller	Cursor to the field and select the rack size, which depends on the starting group you selected above:  If you want to communicate using:  2 words - select 1/4 (starting group 6)  4 words - select 1/2 (starting group 4)  6 words - select 3/4 (starting group 2)  8 words - select FULL (starting group 0)  For example, if you choose starting group 6, you can only transfer 2 words. If you choose starting group 4, you can transfer 4 or 2 words.

### Specify the Discrete Transfer Configuration Files

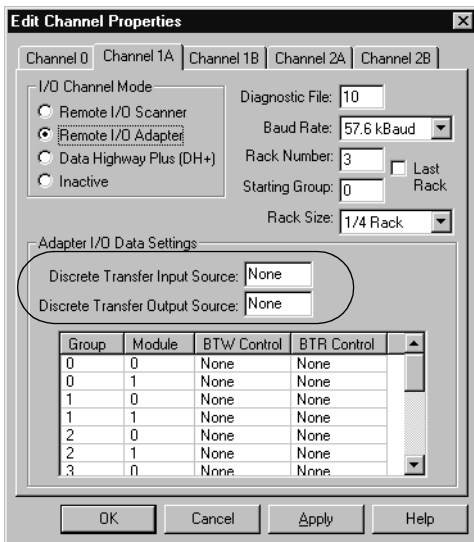

The discrete transfer configuration files (output source file and the input destination file) are the main vehicles for discrete data and block-transfer status bits exchange between a PLC-5 adapter channel and a scanner channel or a supervisory controller (see ).

The discrete transfer configuration files can be integer, BCD, or binary data file types. Be sure to create the files specified for the input source and output source **prior** to specifying them. If they do not exist at the time of configuration, you will receive an error when trying to accept edits.

Configure the discrete transfer configuration file as an integer file. Although the PLC-5 controller allows you to use the input or output areas, reserve these for real I/O on scanner channels. In doing so, you are avoiding a possible conflict if you later attempt to add a rack that uses the same I/O image space.

---

**IMPORTANT**

Do not configure the adapter channel's discrete transfer configuration input destination file to be the data table input image. You risk clearing inputs when performing an autoconfiguration for a scanner channel on the same controller.

The adapter inputs will not be updated until a change is detected in the input data being sent by the controller.

---



### Discrete Data and Block-Transfer Status

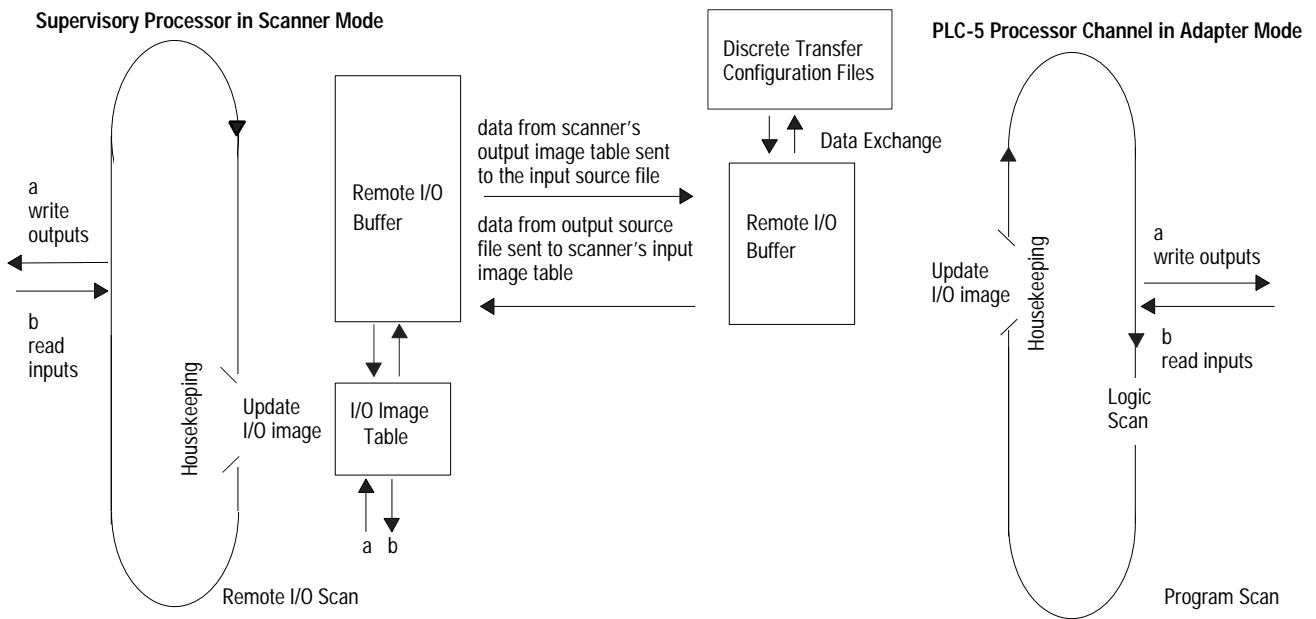

Scanner's Output Image Table

Word	17	14	13	10	07	04	03	00
Reserved for status	[Reserved]							
0	[Reserved]							
1	[Reserved]							
2	[Reserved]							
Supervisory Processor	[Reserved]							
PLC-2 0X0-0X7	[Reserved]							
PLC-3 0XX0-0XX7	Output File				[Reserved]			
PLC-5 0:X0-0:X7	[Reserved]							
5	[Reserved]							
6	[Reserved]							
7	[Reserved]							

Adapter Channel's Input Destination Integer File

Word	15	12	11	08	07	04	03	00
Reserved for status	[Reserved]							
0	[Reserved]							
1	[Reserved]							
2	[Reserved]							
3	[Reserved]							
4	Input File				[Reserved]			
5	[Reserved]							
6	[Reserved]							
7	[Reserved]							

Scanner's Input Image Table

Word	17	14	13	10	07	04	03	00
Reserved for status	[Reserved]							
0	[Reserved]							
1	[Reserved]							
2	[Reserved]							
Supervisory Processor	[Reserved]							
PLC-2 1X0-1X7	[Reserved]							
PLC-3 1XX0-1XX7	Input File				[Reserved]			
PLC-5 1:X0-1:X7	[Reserved]							
5	[Reserved]							
6	[Reserved]							
7	[Reserved]							

Adapter Channel's Output Source File Integer File

Word	15	12	11	08	07	04	03	00
Reserved for status	[Reserved]							
0	[Reserved]							
1	[Reserved]							
2	[Reserved]							
3	[Reserved]							
4	Output File				[Reserved]			
5	[Reserved]							
6	[Reserved]							
7	[Reserved]							

Two, four, six, or eight words of data can be transferred between the scanner and the adapter channel. The number of words is determined by the rack size specified on the Adapter Channel Configuration screen.

If data from the supervisory controller is intended to control outputs of the adapter-mode controller channel, write ladder logic in the adapter-mode controller to move the data from its input destination file to its output image. Use XIC and OTE instructions for bit data; use move and copy instructions for word data.

If you want the supervisory controller to read data from a data file in the adapter-mode controller, write ladder logic in the adapter-mode controller to move that data to its output source file for transfer to the supervisory controller's input image table.

To create the discrete transfer configuration files, use the adapter mode configuration screen in your programming software.

specify the discrete transfer configuration files →

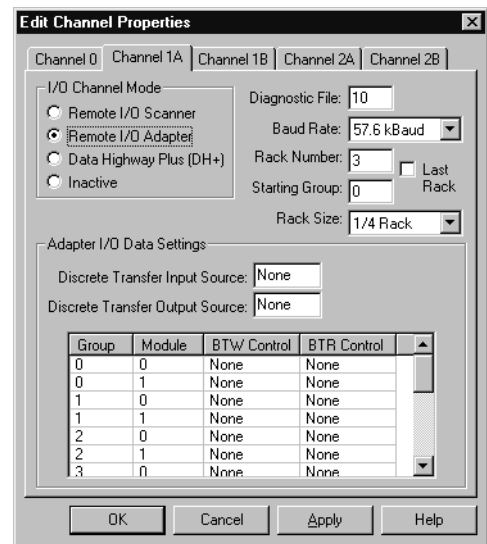

**IMPORTANT** The controller determines the number of words used by the file according to the rack size you specified.

In this Field	Define	By Doing the Following
Input destination	The location where the scanner (host device) places output words into the adapter's input file	<ol style="list-style-type: none"> <li>1. Enter the file number (decimal) of the source data.</li> <li>2. Enter the word number (decimal) of the source data. Specify an input image, output image, integer, BCD, or Hex file.</li> </ol> <p>For example: if you use file N7:0 and the rack size is FULL, the scanner places the 8 discrete words in file N7 words 0-7 (upper byte of first word is for status).</p>
Output source	The location where the adapter places discrete output words into the scanner's discrete input file	<ol style="list-style-type: none"> <li>1. Enter the file number (decimal) of the source data.</li> <li>2. Enter the word number (decimal) of the source data. Specify an input image, output image, integer, BCD, or hex file.</li> </ol> <p>For example: if you use file N7:10 and the rack size is FULL, the adapter channel places 8 discrete words in file N7 words 10-17 (upper byte of first word is for status).</p>

For more information on configuring this file, see the channel configuration documentation for your programming software.

## Programming Discrete Transfers in Adapter Mode

Typically, each output instruction in one controller should have a corresponding input instruction in the other controller. The rack number of the adapter mode controller-channel determines the addresses that you use.

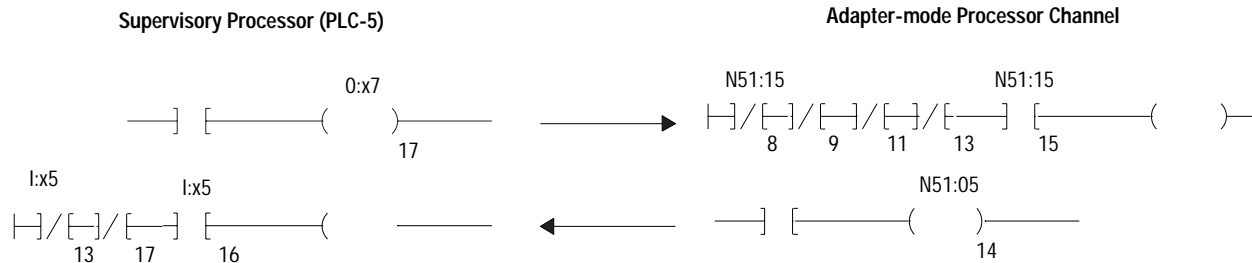

- N51 is the adapter-mode processor's discrete transfer configuration file. Input destination and output source entries determine input and output words.
- The ladder logic in the supervisory processor uses the rack number of the adapter-mode processor channel.
- Condition the ladder logic in the adapter processor with the status bits (page ).

## Programming Block-Transfers of Data to an Adapter Channel

Adapter-mode block-transfers are essentially continuous. As soon as a transfer is completed, another block-transfer occurs immediately in the adapter-mode controller; it then waits (with a buffered snap-shot of data) for the supervisory controller to perform another block-transfer request. Therefore, the data that is transferred after the request is data from the previous transfer. If the supervisory controller performs a block-transfer request from the adapter-mode controller every 500 ms, for example, the data is at least 500 ms old.

The supervisory controller contains the ladder-logic transfer instructions which controls the actual communication transmission. However, the adapter-mode controller channel controls the:

- actual number of words of data that is transferred
- data table location from which the data is transferred

### IMPORTANT

Do not use ladder-logic block-transfer instructions for the adapter-mode controller channel; you configure the block-transfers from channel configuration screens and data monitor screens.

## Configure Block-Transfer Requests

To configure block-transfers to adapter-mode controller channel, use the adapter mode configuration screen in your programming software.

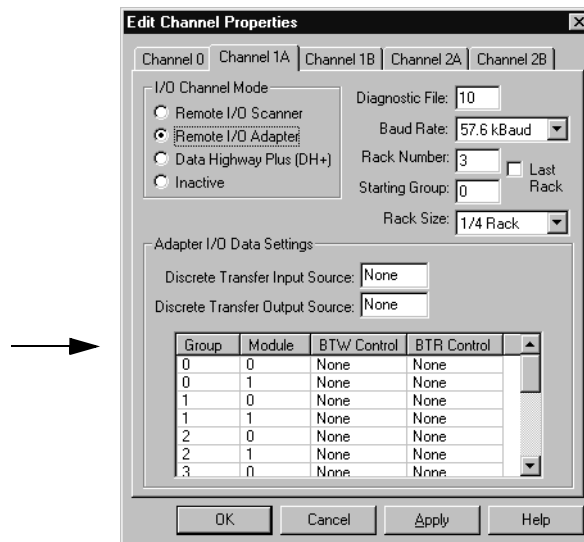

1. Define the BTW control and BTR control files you need. These control files must already exist (appear on the memory map) or the edit will result in an error. Each control word must contain a unique block-transfer control address to properly transmit block-transfers.
  - A. Enter the block-transfer file number.
  - B. Enter the element number.
  - C. Record on paper the BT files you define. This will help when configuring the BT files through the data monitor.
2. Since the adapter-mode channel controls the location from which data is transferred as well as the amount of data, load data into the block-transfer files by using data monitor screen in your programming software.
  - A. Specify a BT control file you defined.
  - B. Enter the transfer length in .RLEN
  - C. Enter the file and element numbers from which the data is to be transferred in .FILE and .ELEM respectively.

**EXAMPLE**

A block-transfer write of 10 words from file 24, element 10 with BT control file for group 0, module 0 of BT12:000 looks like:

---

**Adapter Mode Configuration screen**

Group	Module	BTW control	BTR control
0	0	BT02:000	BT00:000

**Data Monitor screen**

Address	EN	ST	DN	ER	CO	EW	NR	TO	RW	RLEN	DLEN	FILE	ELEM	R	G	M
BT12:000	0	0	0	0	0	0	0	0	0	10	0	24	10	0	0	0

Program multiple block-transfers to an adapter-mode controller channel by matching block-transfer instructions in the supervisory controller to control files in the adapter.

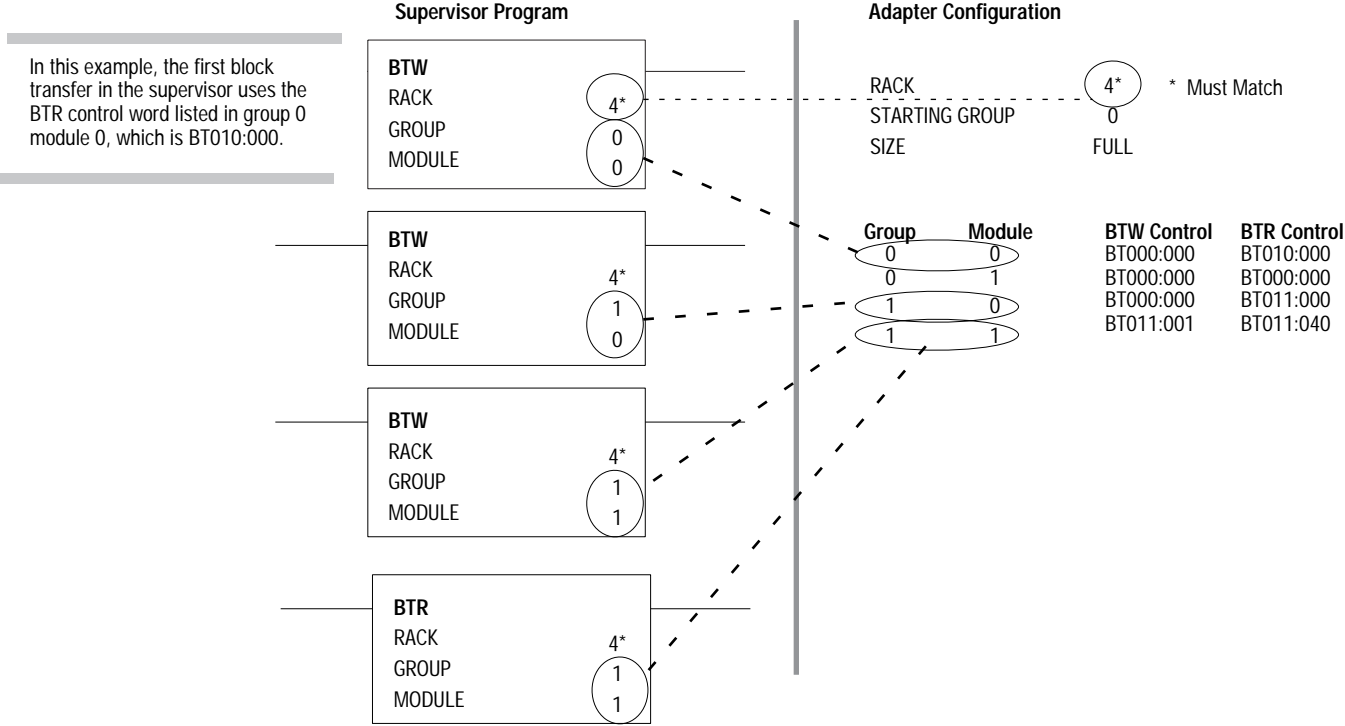

Block transfer further defined in the adapter-mode processor channel via Data Monitor

BT10:0 points to file 24 and element 10 and has a length of 64 words.

Address	EN	ST	DN	ER	CO	EW	NR	TO	RW	RLEN	DLEN	FILE	ELEM	R	G	M
BT10:0	0	0	0	0	0	0	0	0	0	64	0	24	10	0	0	0

Assuming that file 24 has been created as an integer file, the data written down from the first block-transfer will be found in N24:10 to N24:73. The second block-transfer in the supervisor writes its data to the file to which BT11:0 points, and the third block-transfer writes its data to the file to which BT11:40 points.

You can have up to 15 writes and 15 reads. Each block transfer to a particular group/module location uses the I/O addresses for that rack/group for status bits. These locations are lost to discrete transfer. Therefore, if you configure all available 15 block-transfer read/write pairs, no bits will be available for discrete transfer. See page 7-15 for more information.

**IMPORTANT** Adapter-mode block-transfer reads and block-transfer writes in the same group/module location must have the same length.

If you want to transfer controller-resident local I/O data of the adapter mode controller channel to a supervisory controller or if you want to transfer data from the supervisory controller to controller-resident local I/O of the adapter mode controller channel, you must use MOV or COP instructions within the adapter-mode controller channel to move the data in or out of the data file used in the adapter block-transfer control file.

## Examples of Block-Transfer Ladder Logic

### Example Bidirectional Repeating Block Transfer in PLC-5 Supervisory Controller

Enter the following parameters in the block-transfer instructions in the supervisory processor.

- Set the length to 0.
- Use the remote I/O rack number for which you configure the adapter-mode processor.
- Use the group and module numbers for which the adapter-mode processor is configured.
- Condition the use of BTR data with a "data valid" bit.

All address comments for contacts shown in the following examples represent the set (1) state of the bit in the PLC-5 processor.

You may have to execute the BTR in the PLC-5 scanner channel twice if the BTR's time delay is greater than 2-3 program scans. If you do not run the BTR twice, the BTR will read old data from the adapter processor.

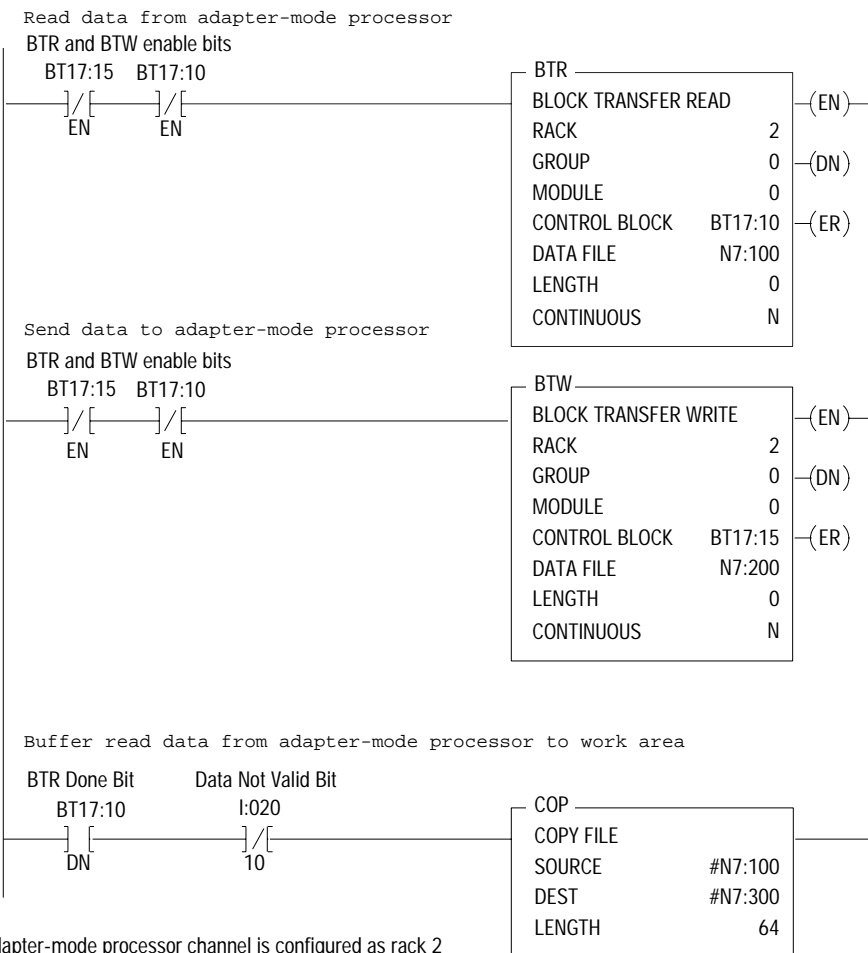



**Example Bidirectional Repeating Block Transfer in PLC-5/250 Supervisory Controller**

- Enter the following parameters in the block-transfer instructions in the supervisory processor.
- Set the length to 0.
  - Use the remote I/O rack number for which you configure the adapter-mode processor.
  - Use the group and module numbers for which the adapter-mode processor is configured.
  - Condition the use of BTR data with a "data valid" bit.
- All address comments for contacts shown in the following examples represent the set (1) state of the bit in the PLC-5 processor.

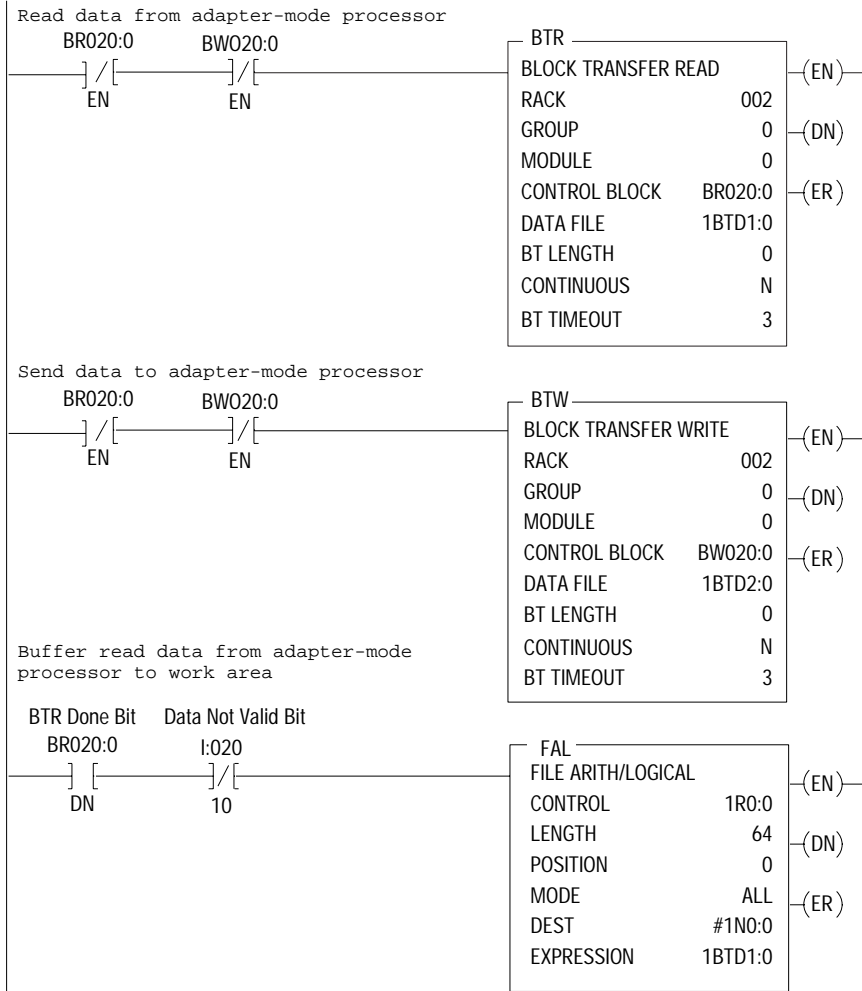

PLC-5 adapter-mode processor is configured for rack 2

**Effects of Programming Block-Transfers to an Adapter-Mode Controller Channel on Discrete Data Transfer**

Because the discrete transfer configuration files are used for discrete data transfer as well as block-transfer status exchanges between a supervisory controller and adapter-mode controller channel, performing multiple block-transfer to and from the adapter-mode controller channel impacts discrete data transfer.

Each group/module that is programmed as an adapter channel block transfer uses one byte in the adapter channel's input destination file.  
 For example:

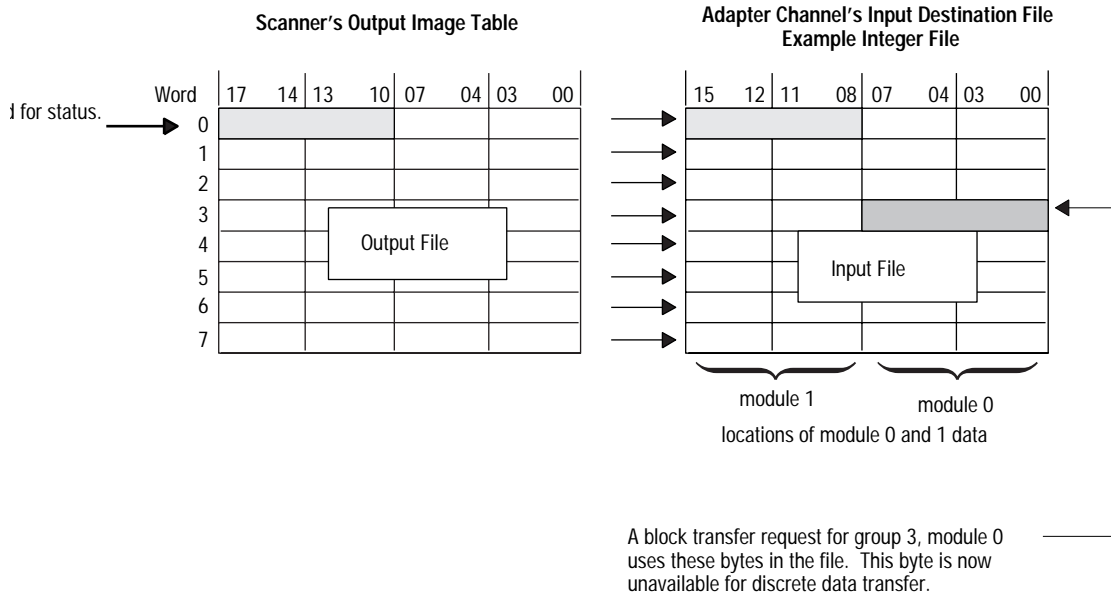

Use care when planning block-transfer and discrete transfers of data to an adapter-mode controller channel.

**ATTENTION**



Use caution when performing data transfer. The discrete output data is over-written by the block transfer control on a group/module basis. If you write both types of transfer to the same group slot, unpredictable machine operation and possible damage to equipment or injury to personnel can occur.

Do not program a block-transfer to group 0, module 1 since this area of the discrete transfer configuration file is used for communication status exchanges between the supervisory controller and the adapter-mode controller channel. For example:

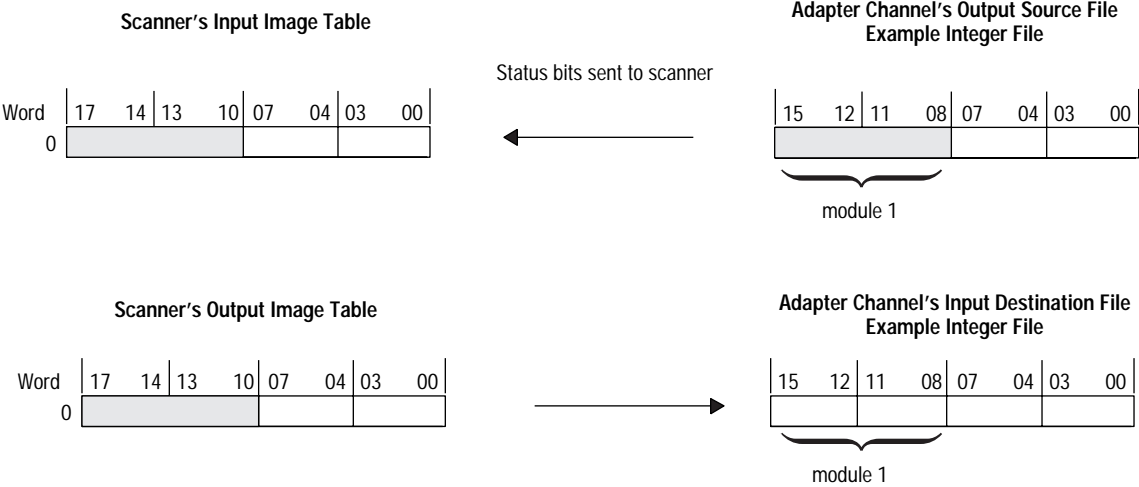

### Monitoring the Status of the Adapter Channel

The supervisory controller receives status bits from the adapter-mode controller in word 0 of the input image table for the rack that the adapter-mode controller is emulating.

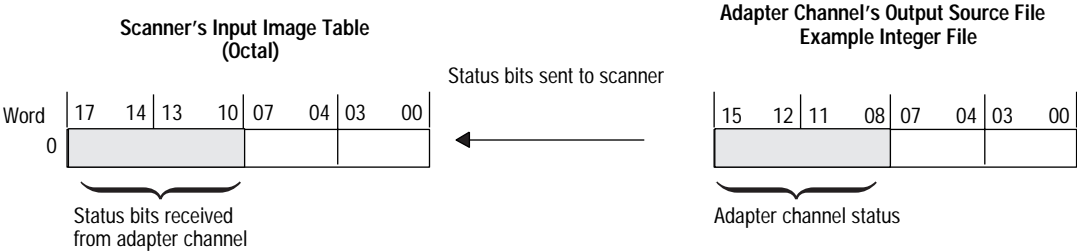

When this Bit(s)	Is	It Indicates
10 octal (8 decimal) and 15 octal (13 decimal)	0	adapter-mode controller is in run mode
10 octal (8 decimal) and 15 octal (13 decimal)	1	adapter-mode controller is in program or test mode

Write ladder logic in the supervisory controller to monitor the rack-fault bits for the rack that the adapter-mode controller channel is emulating to determine the status of the remote I/O link.

### Monitoring the Status of the Supervisory Controller

The adapter-mode controller channel reserves bits 10-17 of the first word of the input destination file for status. These bits tell the adapter-mode controller channel the status of the supervisory controller and the integrity of the remote I/O communication link.



When this Bit(s)	Is	It Indicates that the Adapter-Mode Controller
10 octal (8 decimal)	1	detects a communication failure or receives a reset command from the supervisory controller  will be set if either bit 11 octal (9 decimal) or bit 15 octal (13 decimal) is set
11 octal (9 decimal)	1	receives a reset command from the supervisory controller (controller in program or test mode)
13 octal (11 decimal)	1	detects that the supervisory controller has powered up; this bit is reset with the first communication from the supervisory controller
15 octal (13 decimal)	1	detects a communication failure (e.g., no communication activity on the remote I/O communication link within the last 100 ms)

## Monitoring Remote I/O Adapter Channels

To monitor channels that are configured to support adapter mode, use the adapter mode status screen. The data displayed is stored in the diagnostic file you defined in the adapter mode configuration screen of your programming software.

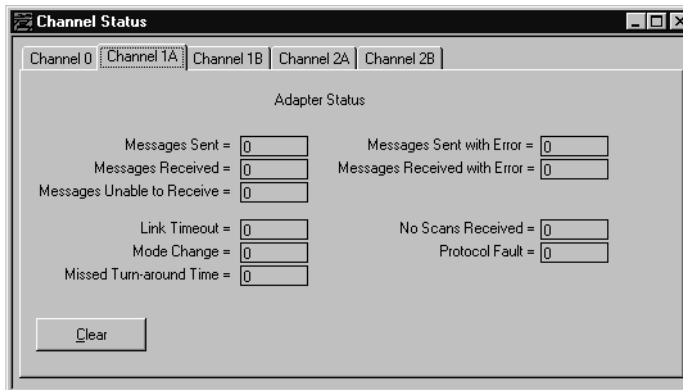

Status Field	Location	Description
Messages sent	word 1	Displays the number of messages sent by the channel.
Messages sent with error	word 3	Displays the number of messages containing errors sent by the channel.
Messages received	word 0	Displays the number of error-free messages received by the channel.
Messages received with error	word 2	Displays the number of messages containing errors received by the channel.
Messages unable to receive	word 4	Displays number of messages that contained protocol errors or packets that were garbled by the adapter.
Link timeout	word 5	Displays the number of times a timeout occurred on the remote I/O link.
No scans received	word 6	Displays the number of times an adapter channel did not receive a packet addressed to itself.
Mode changed	word 7	Displays the number of times the adapter channel switched to online.
Protocol fault	word 8	Displays the number of invalid I/O messages the adapter channel received.
Missed turn-around time	word 9	Displays the number of times the adapter channel took longer than 2 ms to process a message packet. The turn around-time for message packet processing is 2 ms.

## Notes

## Communicating with Extended-Local I/O

### Using This Chapter

For Information About	Go to Page
Selecting devices that you can connect	8-1
Cabling	8-2
Addressing and placing I/O	8-2
Transferring data	8-4
Configuring the controller as an extended-local I/O scanner	8-9
Monitoring extended-local I/O status	8-12

This chapter explains how to configure the controller to communicate with extended-local I/O:

1. Configure channel 2 for extended-local I/O.
2. Define a diagnostic file.
3. Use a unique, unused integer file.
4. Define the scan list.

### Selecting Devices That You Can Connect

The only products that can form the extended-local I/O link are the PLC-5/40L and -5/60L controllers and the extended-local I/O adapter module.

The extended-local I/O processor cannot be an extended-local I/O adapter.

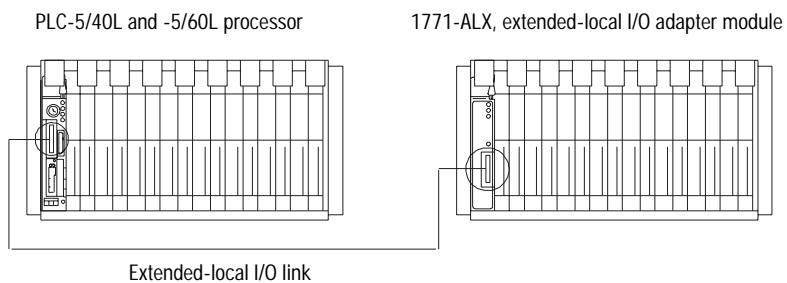

## Cabling

The maximum cable length for an extended-local I/O system is 30.5 cable-m (100 cable-ft). Connect extended-local I/O adapters by using any of these cables:

Cable Length	Catalog Number
1 m (3.3 ft)	1771-CX1
2 m (6.6 ft)	1771-CX2
5 m (16.5 ft)	1771-CX5

**IMPORTANT**

You cannot connect or splice extended-local I/O cables to form a custom cable length. For example, if you have a distance of 4 m between two extended-local I/O adapters or between a controller and an extended-local I/O adapter, you cannot connect two 2 m cables together. You would have to use the 5 m cable and have the extra 1 m as slack.

Terminate the link by installing the local I/O terminator (1771-CXT) on the last adapter module. The system will not run without it. The terminator is included with the controller.

## Addressing and Placing I/O

When a PLC-5/40L or -5/60L controller is used to scan both extended-local I/O and remote I/O racks, the total of both remote I/O and extended-local I/O racks must not exceed the maximum number of racks allowed for the controller (16 racks for a PLC-5/40L or 24 racks for a PLC-5/60L). shows a PLC-5/40L controller controlling both extended-local I/O and remote I/O racks.



**PLC-5/40L Controller with 16-rack Addressing Capability (Split Between Extended-Local I/O and Remote I/O)**

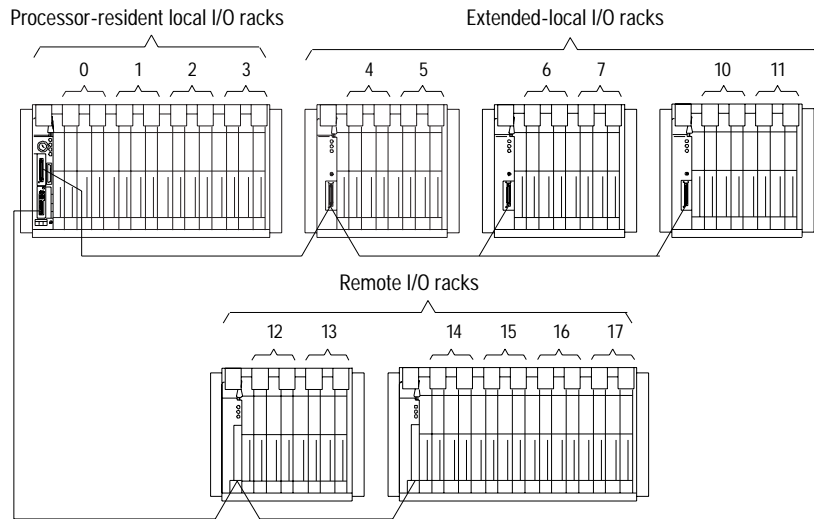

**Note:** Racks numbers do not need to be consecutive per channel. For example, remote I/O racks can be numbered 6, 7, 14, 15, 16, and 17, while extended-local I/O racks can be numbered 4, 5, 10, 11, 12, and 13.

18584

The PLC-5 controller and the 1771-ALX adapter module automatically allocate the next higher rack number(s) to the remaining I/O group(s) of the chassis. For example, if you select 1/2-slot addressing for your controller-resident local chassis and you are using a 16-slot (1771-A4B) chassis, the controller will address racks 0, 1, 2, and 3 in this chassis.

When assigning a rack number to extended local I/O, follow these guidelines:

- Do not split a rack number between extended-local I/O and remote I/O. For example, if you use a partial rack for remote I/O, you cannot use the remaining partial rack for extended-local I/O. See <sup>2</sup>.
- You can distribute extended-local I/O racks across multiple chassis on the extended-local I/O bus as shown below.

**Extended-local I/O Rack Number Assigned to Multiple I/O Chassis**

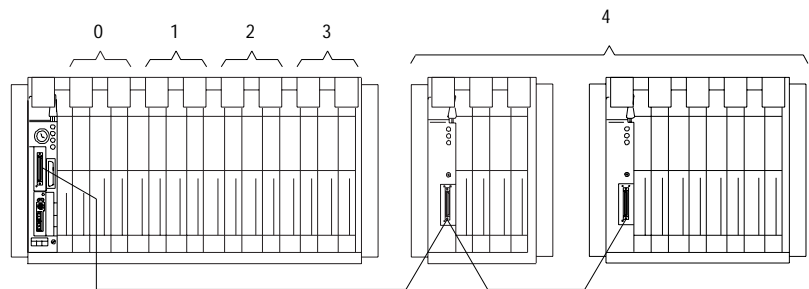

- You can select a different hardware addressing method for each extended-local I/O chassis in your PLC-5 system.

- You cannot configure more than one rack to have the same starting rack number and module group; that is, you cannot use chassis to chassis complementary I/O.

Follow these guidelines when you plan your extended-local I/O system.

- Do not configure controller input interrupts (PIIs) for inputs in an extended-local I/O chassis. The PII inputs must be in the controller-resident local I/O rack.
- You can either use 32-point I/O modules and any addressing method or use 1771-IX or -IY modules and any addressing method in extended-local I/O racks. You must specify the type of I/O modules you are using by setting the configuration plug on the extended-local I/O adapter.
- If you need to use a thermocouple module and 32-point I/O modules in the same I/O chassis, use the 1771-IXE module.

## Transferring Data

The PLC-5/40L or -5/60L controller can scan controller-resident I/O, extended local I/O, and remote I/O. The following figure shows how a PLC-5/40L or -5/60L controller accomplishes I/O scanning and update.

PLC-5/40L and -5/60L I/O Scanning and Update

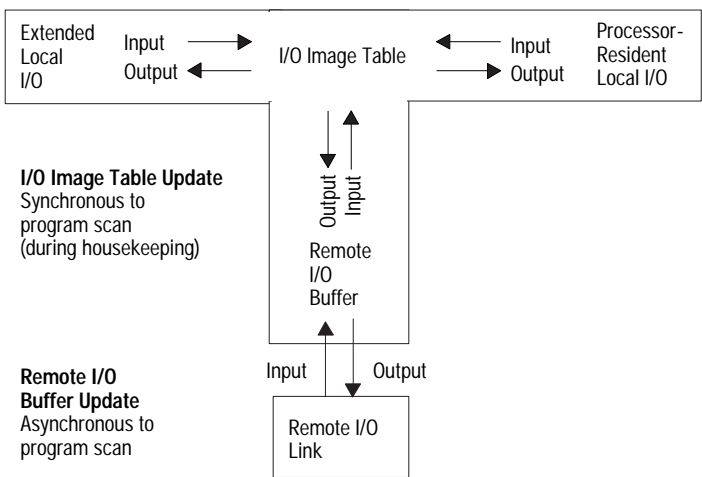

## Discrete Data Transfer

The processors scan the extended-local I/O chassis during the housekeeping portion of the program scan. Extended-local I/O discrete data is exchanged between the processor's data table image and the I/O in the extended-local I/O chassis.

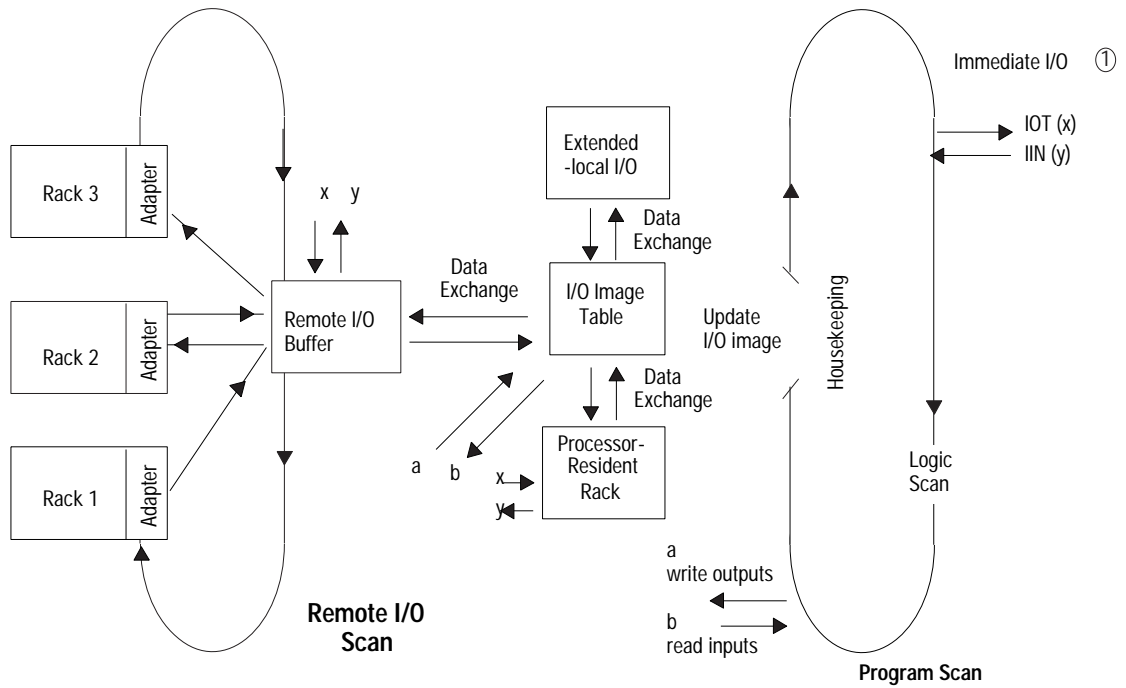

Data exchange occurs during housekeeping. Outputs are written to and inputs read from the I/O image table during the logic scan.

① IIN and IOT data transfer directly to and from I/O modules extended-local I/O chassis.

The time that it takes to scan extended-local I/O chassis is added to the housekeeping time as shown in the following figure.

### PLC-5/40L and -5/60L Extended-Local I/O Scan Time

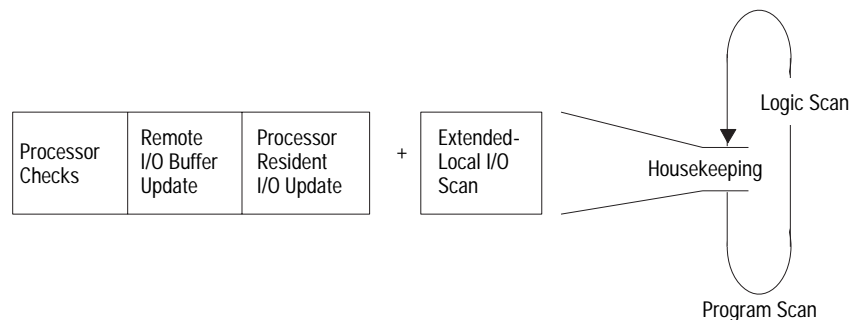

The time in ms that it takes to scan extended-local I/O chassis depends on the number of 1771-ALX adapter modules and the number of extended- local I/O racks. The formula used to calculate the total time to scan extended-local I/O chassis is:

$$\text{extended-local I/O scan time} = (0.32 \text{ ms} \times A) + (0.13 \text{ ms} \times L)$$

where:

$A$  = the number of 1771-ALX modules and

$L$  = the number of racks in the extended-local I/O system

---

**EXAMPLE**

If you have three 1771-ALX modules in three chassis and a total of 4 racks, the total time is calculated as follows:

$$\text{extended-local I/O scan time} = (0.32 \text{ ms} \times 3) + (0.13 \text{ ms} \times 4)$$

$$\text{extended-local I/O scan time} = 1.48 \text{ ms}$$

$$\text{housekeeping time} = 1.48 \text{ ms (extended-local I/O)} + 4.50 \text{ ms (other housekeeping)}$$

$$\text{housekeeping time} = 5.98 \text{ ms}$$

---

## Transferring Block Data

Requests for block-transfer data occur during the logic scan. Concurrent with the execution of the program logic, block-transfer requests are forwarded to the appropriate 1771-ALX adapter module(s) and data is transferred.

A 1771-ALX adapter module may start block-transfer operations to multiple slots and have block-transfer data transactions on-going in parallel within the I/O chassis.

The block-transfer duration shown above does not affect logic scan time. This transfer of data occurs concurrent with execution of program logic.

Block-transfer duration is the time interval between the enabling of the block-transfer instruction and the receipt of the done bit.

## Calculating Block-Transfer Completion Time

You can calculate two types of block-transfer timing:

- worst-case calculation for the completion of all block-transfers in the system
- the time to perform a block-transfer for any one block-transfer module in the system

This formula assumes:

- block-transfer instructions are consecutively placed in the logic program
- block-transfer modules in the I/O chassis are ready to perform when operations are requested

### Calculating Worst-Case Completion Time

**block-transfer duration (ms) = D R**

**D = 2E L + (0.1W) and**

$$R = \frac{\text{logic scan} + \text{housekeeping}}{\text{logic scan}}$$

or

$$R = 1 \text{ (when } D < \text{logic scan time)}$$

where:

**E** = number of extended-local I/O chassis with block-transfer modules

**L** = largest number of block-transfer modules in any extended-local I/O chassis

**W** = number of words in the longest block-transfer request

### Calculating Completion Time for any One Block-Transfer

**block-transfer duration (ms) = D R**

**D = [2E M + (0.1W)] and**

$$R = \frac{\text{logic scan} + \text{housekeeping}}{\text{logic scan}}$$

or

$$R = 1 \text{ (when } D < \text{logic scan time)}$$

where:

**E** = number of extended-local I/O chassis with 1771-ALX adapter modules and block-transfer modules

**M** = number of block-transfer modules in the chassis of the module being calculated

**W** = number of words in block-transfer request being calculated

**Example Calculations:**

Here is an example system that provides sample calculations of a worst case block-transfer completion time and the completion time of the modules in chassis 2.

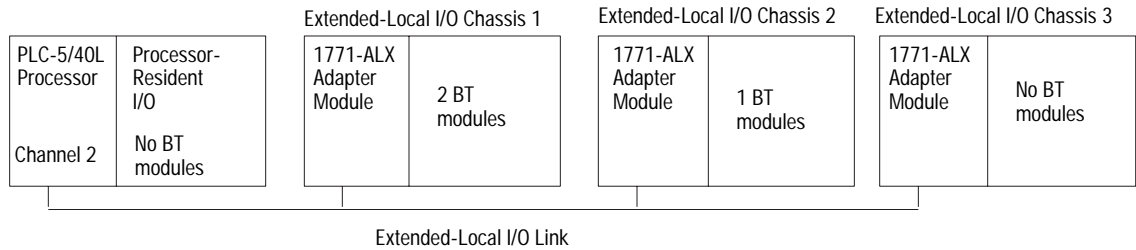

The logic scan completes in 15 ms. Housekeeping completes in approximately 6 ms (as calculated in the formula on page NO TAG). The longest block-transfer request is 20 words.

**Worst-case time (T) = D X R**

$$D = 2E \quad L + (0.1W) \quad \text{and} \quad R = 1 \quad \text{Because } 10 < 15 \text{ (which is the logic scan)}$$

$$D \text{ (ms)} = (2 \quad 2) \quad (2) + (0.1 \quad 20 \quad )]$$

$$D = 10 \text{ ms}$$

$$T = 10 \quad 1$$

$$T = 10 \text{ ms}$$

**Completion time (T) for module in chassis 2 transfer: = D X R**  
 Block-transfer length = 20

$$D = 2E \quad M + (0.1W) \quad \text{and} \quad R = 1 \quad \text{Because } 6 < 15 \text{ (which is the logic scan)}$$

$$D \text{ (ms)} = (2 \quad 2) \quad (1) + (0.1 \quad 20 \quad )]$$

$$D = 6 \text{ ms}$$

$$T = 6 \quad 1$$

$$T = 6 \text{ ms}$$

**Considerations for Extended-local Racks**

The following are programming considerations when you are transferring block data in an extended-local rack:

- Block-transfer instructions to any of the following modules that reside in an extended-local rack will result in frequent checksum errors:
  - 1771-OFE1, -OFE2, and -OFE3 modules, all versions prior to series B, revision B
  - IMC-120 and IMC-123, all versions

- If you are using block-transfer to a 2760-RB module located in the extended-local rack, make sure you **do not set the timeout bit** in the block-transfer control file.

## Configuring the Controller as an Extended-Local I/O Scanner

To configure the extended-local I/O (channel 2), use the extended-local I/O configuration screen.

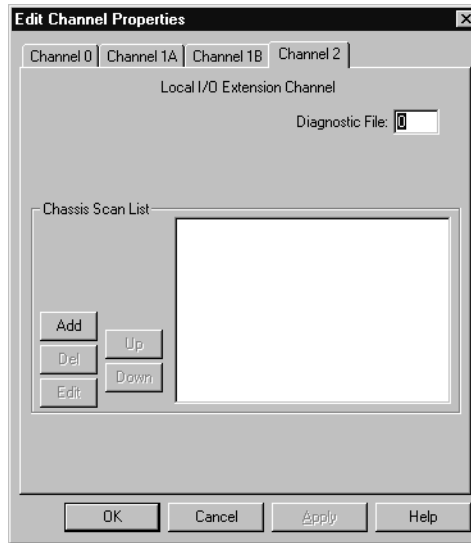

This Field	Specifies	Configure by Doing the Following
Diagnostic file	The file containing the channel's status information	<p>Cursor to the field enter enter an integer file number (9-999).</p> <p><b>ATTENTION:</b> Assign a unique diagnostic file to each channel. Do not assign a diagnostic file that is the I/O status file you assigned or any other used integer file. Unpredictable machine damage can result.</p> <p><b>Important:</b> You must define a diagnostics file for a channel configured for anything but unused (even if you are not using the channel) if you want to get status information for that channel.</p>
Scan list	The channel I/O configuration	See the next section for information on creating and modifying a scan list.

The scan list for extended-local I/O is similar to the scan list for remote I/O. The differences are:

- The remote I/O scan list displays rack size. The rack size is determined by the chassis size (number of slots) and backplane addressing used by the chassis. The following table explains the relationship among chassis size, backplane addressing and rack size.

**How Chassis Size and Backplane Addressing Determine the Quantity of I/O Racks**

If You are Using this Chassis Size	And 2-Slot Addressing (Single Density)	Or 1-Slot Addressing (Double Density)	Or 1/2-Slot Addressing (Quad Density)
4-slot	1/4 logical rack	1/2 logical rack	1 logical rack
8-slot	1/2 logical rack	1 logical rack	2 logical racks
12-slot	3/4 logical rack	1 1/2 logical rack	3 logical racks
16-slot	1 logical rack	2 logical racks	4 logical racks

On the extended-local-I/O scan list, the actual chassis size and backplane addressing is displayed, not the rack size.

- The scan list for extended local I/O has one entry for each physical chassis on the extended local I/O channel.

If an adapter on a remote I/O channel resides in a physical chassis that contains more than one I/O rack, more than one entry appears on the remote I/O scan list for that single chassis.

The following table shows the scan list for both remote I/O and extended local I/O. Each channel shows a 16-slot chassis using 1-slot addressing with a starting address of rack 4, module group 0. This chassis contains logical racks 4-5.

**Remote I/O Scan List vs Extended-local I/O Scan List**

Remote				Extended				
Rack ##	Starting Group	Rack Size	Range	Rack Address	Starting Group	Chassis Size	Backplane Addressing	Range
4	0	FULL	040-047	4	0	16-SLOT	1-SLOT	040-057
5	0	FULL	050-057					

A scan list includes the following:

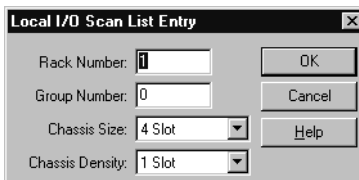



<b>For this Field</b>	<b>A Scan List Contains</b>
Scan rack address	1-17 octal (PLC-5/40L controllers) 1-27 octal (PLC-5/60L controllers)
Starting group number	0, 2, 4, or 6
Chassis size	4-slot, 8-slot, 12-slot, 16-slot
Backplane addressing	1-slot, 2-slot, or 1/2-slot
Range	Automatically calculated based upon rack address, starting module group and chassis size.  An asterisk (*) after a range indicates the last valid rack entry.

Keep the following limitations in mind when creating/modifying your scan list:

- A scan list only can have 16 entries because only 16 adapters can be on channel 2.
- The automatic configuration always displays the actual hardware configuration, except for chassis that have their global inhibit bit set. In this case, that global bit overrides the automatic configuration. You must first clear the global inhibit bits for all chassis on the channel, and then use the autoconfigure function.
- Clear global inhibit bits by using the controller status status screen.
- A scan list can have a maximum of 16 chassis. Entries cannot be repeated on the scan list.

**Use the following table for information about creating/modifying your scan list:**

<b>To:</b>	<b>Do the Following</b>
Create a scan list	<p>Make sure the controller is in Remote Program or Program mode.</p> <ol style="list-style-type: none"> <li>1. Make sure that you defined an I/O status file on the controller configuration screen.</li> <li>2. Accept any edits made to the channel configuration.</li> <li>3. Use the autoconfiguration function</li> </ol> <p>If you have errors when you accept edits, clear the scan list and accept edits again.</p> <p>If some or all adapters are not on the scan list and should be, check to see that they are powered-up and that the channels are connected properly. Also verify that all switch settings on the adapters are set correctly.</p>
Insert an entry into the scan list	<p>Make sure the controller is in Remote Program, Program, or Remote Run mode.</p> <ol style="list-style-type: none"> <li>1. Position the cursor at the place on the scan list where you want to insert an entry.</li> <li>2. Insert an entry into the list and enter the appropriate values for the list.</li> </ol> <p><b>Important:</b> If incorrect information is entered for an entry, the controller will not display the new configuration when you save edits.</p>
Delete an entry for the scan list	<p>Make sure the controller is in Remote Program, Program, or Remote Run mode.</p> <ol style="list-style-type: none"> <li>1. Position the cursor at the place on the scan list where you want to delete an entry.</li> <li>2. Delete the entry from the list.</li> </ol> <p><b>Important:</b> If incorrect information is entered for an entry, the controller will not display the new configuration when you save edits.</p>

## Monitoring Extended-Local I/O Status

To monitor extended-local I/O of PLC-5/40L and PLC-5/60L controllers, use the extended local I/O status screen in your programming software.

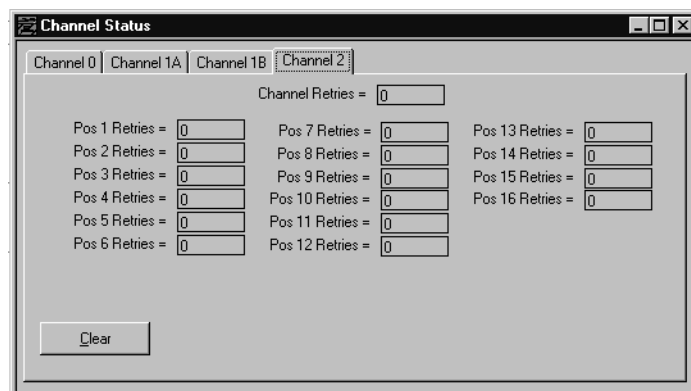

<b>Status Field</b>	<b>Location</b>	<b>Description</b>
Channel retry	word 0	Displays the number of times extended local I/O scanner tried and failed to communicate with all adapters on the channel. This value is the sum of all adapter retry counts.
Retry	word 10 word 20 word 30 etc. word 160	Displays the number of retries for the corresponding rack entry (word numbers are in multiples of 10).  Entry 1 Entry 2 Entry 3 etc. Entry 16

---

---

**IMPORTANT**

Setting inhibit bits in the I/O status file does not update inhibit bits in the controller status file.

---

## Notes

---

## Communicating with Devices on a DH+ Link

### Using This Chapter

<b>For Information About</b>	<b>Go to Page</b>
Selecting devices that you can connect	9-1
Link design	9-2
Configuring the channel for DH+ communication	9-3
Using the global status flag file	9-5
Monitoring DH+ communication channels	9-7
Estimating DH+ link performance	9-12
Application guidelines	9-17

### Selecting Devices That You Can Connect

You can use a DH+ link for data transfer to other PLC-5 controllers or higher level computers and as a link for programming multiple PLC-5 controllers. A PLC-5 controller can communicate over a DH+ link with other controllers and with a personal computer. You can connect a maximum of 64 stations to a single DH+ link.

**Devices that You Can Connect**

<b>Product</b>	<b>Catalog Number</b>	<b>Application</b>	<b>Required Cables</b>
ControlLogix Data Highway Plus Remote I/O Interface Module	1756-DHRIO	Allows communication between PLC-5 controllers over different networks, such as Data Highway Plus, ControlNet and Ethernet	1770-CD
Data Highway or Data Highway Plus (RS-232C or RS-422-A) Interface Module	1770-KF2	Connects an asynchronous (RS-232C) device to a Data Highway or DH+ network	1770-CD
Data Highway / Data Highway Plus on Broadband	1771-KRF	Media bridge connecting as many as 18 Data Highway networks to communicate over a facility-wide broadband cable system	
Communication Interface Card	1784-KL	Connects the T47 Portable Programming Terminal to DH+	1784-CP
Data Highway Plus XT/AT Interface Module	1784-KT	Connects IBM XT or AT compatible computers to DH+	1784-CP2 1784-CP3
Data Highway Plus PS/2 Interface Module	1784-KT2	Connects IBM PS/2 compatible computers to DH+	1784-CP5 1784-CP6
Data Highway Plus to Data Highway Interface Module	1785-KA	Connects a Data Highway network to a DH+ network	1770-CD
DH+ to DH-485 Interface Module	1785-KA5	Connects a DH-485 link to a DH+ link.	
Data Highway Plus RS-232C Interface Module	1785-KE	Connects an asynchronous (RS-232C) device and DH+	
PCMCIA Card	1785-PCMK	Connects PCMCIA Bus notebook computers to DH+	1784-PCM5

**Link Design**

**Trunk line/drop line considerations:**

When using a trunk line/drop line configuration, use 1770-SC station connectors and follow these cable-length guidelines:

- trunk line-cable length – depends on the communication rate of the link
- drop-cable length – 30.4 m (100 cable-ft)

For more information about designing trunk line/drop line configurations, see the *Data Highway Plus/Data Highway II/Data Highway-485 Cable Installation Manual*, publication 1770-6.2.2.

Specify 1770-CD (Belden 9463) cable. Connect a DH+ network using a daisy chain or trunk line/drop line configuration.

Verify that your system’s design plans specify cable lengths within allowable measurements.

**IMPORTANT**

The maximum cable length for DH+ depends on the transmission rate. Configure all devices on a DH+ link to communicate at the same transmission rate.

For daisy chain configurations, use this table to determine the total cable length you can use.

<b>A DH+ link using this communication rate</b>	<b>Cannot exceed this cable length</b>
57.6 kbps	3,048 m (10,000 ft)
115.2 kbps	1,524 m (5,000 ft)
230.4 kbps	762 m (2,500 ft)

**IMPORTANT** If you select the baud rate as 230.4 kbps, and you are using the serial port or a PLC-5 coprocessor, use channel 2 for better overall system performance.

For proper operation, terminate **both** ends of a DH+ link by using the external resistors shipped with the programmable controller. Selecting either a 150Ω or 82Ω terminator determines how many devices you can connect on a single DH+ link.

If Your DH+ I/O Link Operates at	Use this Resistor Rating
230.4 kbps	82Ω
57.6 kbps or 115.2 kbps	150Ω

### Configuring the Channel for DH+ Communication

Depending on the controller you are using, you can configure these channels:

Controller	Channels that Support DH+
PLC-5/11	1A
PLC-5/20	1A (fixed DH+), 1B
PLC-5/30    PLC-5/20E	1A, 1B
PLC-5/40L    PLC-5/40E	
PLC-5/60L    PLC-5/80E	
PLC-5/40	1A, 2A, 1B, 2B
PLC-5/60	
PLC-5/80	

**IMPORTANT** To define the DH+ address and baud rate for channel 1A, you must set switch assembly SW1 on the controller; you cannot set this node address through the programming software.

To configure a channel to support a DH+ link, use the DH+ configuration screen in your programming software.

configure the channel for DH+ →

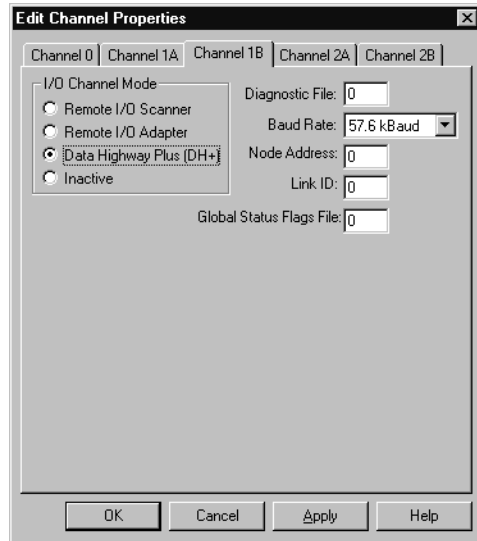

This Field	Specifies	Configure by Doing the Following
Diagnostic file	The file containing the channel's status information	<p>Enter an integer file number (10-999). The system creates an integer file 40 words long.</p> <p><b>ATTENTION:</b> Assign a unique diagnostic file to each channel. Do not assign a diagnostic file that is the I/O status file you assigned or any other used file. Unpredictable machine damage can result.</p> <p><b>Important:</b> You must define a diagnostics file for a channel configured for anything but unused (even if you are not using the channel) if you want to get status information for that channel.</p>
Baud rate	Communication rate for the current channel	<p>If the DH+ channel is channel 1A, specify the baud rate by setting SW1 (see chapter 23)</p> <p>any other channel, select 57.6 kbps, 115.2 kbps, or 230.4 kbps through the programming software</p>
Node address	The station address of your controller	<p>If your DH+ channel is:</p> <p>1A—specify the DH+ station number by setting SW1 on your controller (see chapter 23).</p> <p>anything other than 1A—cursor to Node Address field, enter a value of 0-77 octal, and press <b>[Enter]</b>.</p> <p>Each station on a DH+ link must have a unique address.</p>
Link ID	The local link where the channel resides	<p>If your DH+ link is bridged to another Data Highway network, cursor to the field, type a decimal number to identify the protocol link to which the channel is connected, and press <b>[Enter]</b>.</p>



This Field	Specifies	Configure by Doing the Following
Global status flag file	The file where you want to store token pass data	<p data-bbox="747 279 1466 352">Cursor to the field, type an integer file number (10-999), and press <b>[Enter]</b>. The system creates an integer file 64 words long.</p> <p data-bbox="747 405 1466 499"><b>ATTENTION:</b> When you change the controller from run or test to program mode, the controller writes zeroes in the global status flags file. Any information previously in this file is lost.</p> <p data-bbox="747 520 1466 558">For more information on the global status flags file, see below.</p>

## Using the Global Status Flag File

Use the global status flag file to store token pass data. This file stores a 16-bit word of data for each station on the DH+ network. The stations use this file to automatically share data with other stations without requiring user programming.

When a station sends the token to the next station, it, in effect, sends a broadcast message that contains 1 word of information from its own address area in its global status flag file. The data sent out is taken from the word in the global status file that is equal to its own station address. The token is seen by all stations. Each station on the network examines the token and places the word of global status data from the sending station into the word that corresponds to the sending station's address

This process lets each station automatically see the newly updated data. You can create ladder logic to monitor and interpret this data according to your application.

The Global Status Flag data for each node address on your DH+ link is stored in the word address corresponding to the octal node address. For example, if your DH+ link has processors at node addresses 7, 10, 15, and 30 and your global status flag file is N10 for each processor, the global status flag data is stored as follows:

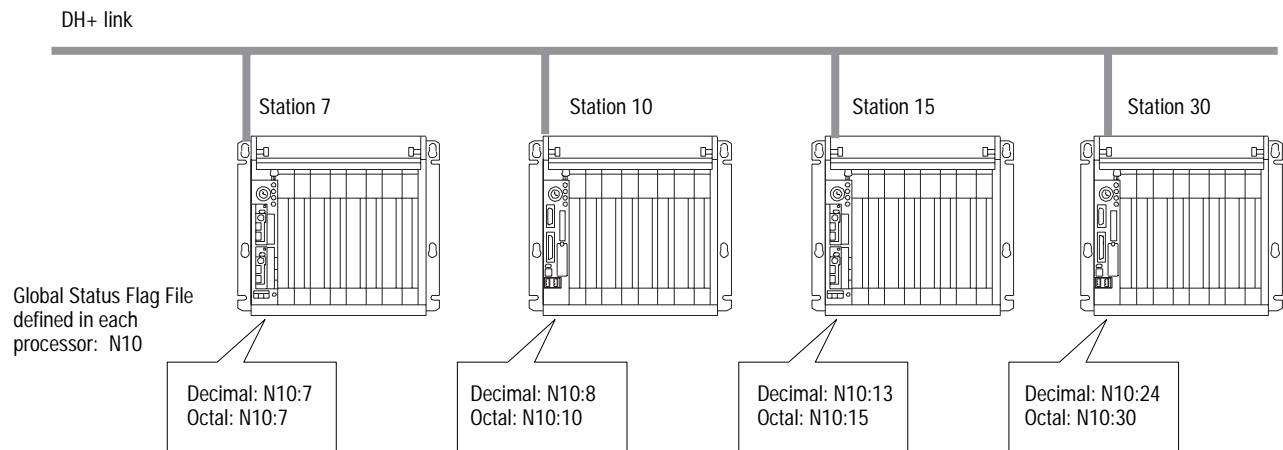

You can specify any integer file in the processor to be the global status flag file; however, for simplicity, specify the same file for all your PLC-5 processors on the DH+ link. The files are updated during housekeeping.

Make sure that the global status flag file in all of the controllers on your DH+ link is as large as the highest node address, so that all of the nodes can communicate with each other. If station 30 is the highest node number, for example, the global status flag file (N10) in each controller must be 24 words long (octal 30 = decimal 24). When you first configure the global status file, it automatically gets 64 words.

#### IMPORTANT

Do not allow either external or internal messages to write into the global status flag file. Writing into the global status file faults the controller.

You can change the radix in the data monitor to display the file address in octal so that you can see the element number of the octal address matching the node address.

## Monitoring DH+ Communication Channels

Use the DH+ status screen in your programming software to monitor channels that are configured to support a DH+ link. The data displayed is stored in the diagnostic file defined on the DH+ configuration screen in your programming software. Note that this screen does not display the active node table, which is also stored in the diagnostic file.

### Monitoring messages

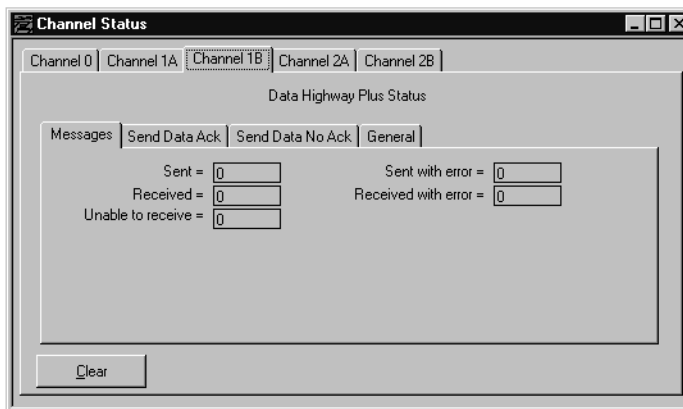

Status Field	Word(s)	Description
Sent	5	Total number of messages sent by the station  This number is the sum of the send data acknowledge counters (SDA) and send data no acknowledge (SDN) transmit confirm counters.
Sent with error	7	Number of messages sent that were not acknowledged. This number is the sum of the following:  SDA transmit NAK misc • SDA/SDN retrans  transmit NAK full • dropped token  SDA transmit NAKed SAP
Received	4	Number of error-free messages the station has received. This number is the sum of the SDA and SDN received counters.
Received with error	6	Number of invalid messages that the station has received. This number is the sum of the SDA received with error and the SDA received SAP off counters.
Unable to receive	8	Total number of times the station NAKed an incoming message due to the lack of an available buffer. This number should be the same as the SDA received but full counter.

## Monitoring Data Sent with Acknowledgment

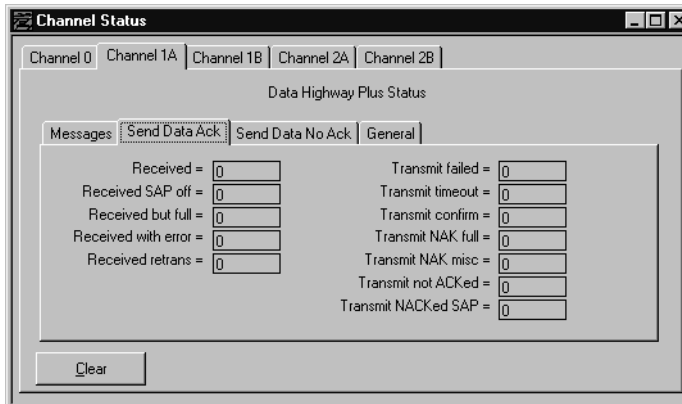

Status Field	Word(s)	Description
Received	19	Number of error-free SDA messages that the station received.
Received SAP off	23	Number of SDA messages that the station received but could not process because its service access point (SAP) was off.  This counter should always be 0.
Received but full	22	Number of SDA messages that the station could not receive because of lack of memory.
Received with error	20	Number of invalid SDA messages that the station received. Some causes are:  bad CRC  the message has an invalid source address  the message has an unrecognizable control byte  the transmission was aborted  This counter indicates noise; increase the cable's shielding from noise.
Received retransmissions	21	Number of times the sending station re-transmitted an SDA message, which was ACKed or NAKed  If node sends a message but does not receive an ACK or a NAK response, the node will re-transmit the message. If a node retransmitted a message because the acknowledge response to the first message was lost, the node receiving the message detects the retransmission and sends an acknowledge response. But the receiving node discards the duplicate message. High counts of this counter indicates noise or cable problems; check that the cable is secure and properly shielded from noise.
Transmit failed	29	Number of SDA messages sent by the station that were determined to be in error. This counter is the sum of the SDA transmit not ACKed and SDA transmit timeout counters.
Transmit timeout	26	The number of SDA messages that were sent but not ACKed or NAKed by the receiving station  This counter increments even if the message does get through during a retry and if the receiving station is unable to communicate. This counter indicates a noise or a cabling problem (the receiving station is not seeing the messages).

Status Field	Word(s)	Description
Transmit confirm	24	Number of SDA messages successfully sent to and acknowledged by the addressed station
Transmit NAK full	30	<p>Number of times the station received a NAK to a message because the destination station was full</p> <p>This indicates that messages are being sent to the receiving station faster than the PLC-5 controller can process them. Most likely, more than one station on the DH+ link is sending messages to the same station. Check to see that you are:</p> <ul style="list-style-type: none"> <li>not scheduling unnecessary traffic (e.g., your are sending continuous messages when you only need updates once per second)</li> <li>implementing report-by-exception so that data is sent only if it is new data</li> </ul>
Transmit NAK misc.	25	Number of incoming SDA messages that were NAKed due to reasons other than the NAKed full and NAKed inactive counters (e.g., a NAK due to a bad CRC)
Transmit not ACKed	27	<p>Number of SDA messages that were sent but were not ACKed by the receiving station</p> <p>The following could have occurred:</p> <ul style="list-style-type: none"> <li>message could have been NAKed</li> <li>an invalid ACK was returned</li> <li>nothing was returned</li> </ul> <p>This counter can indicate:</p> <ul style="list-style-type: none"> <li>a noise or a cabling problem</li> <li>the receiving station has been removed from the link</li> <li>the receiving station cannot communicate</li> </ul>
Transmit NAKed SAP	31	<p>Number of SDA messages that were successfully sent to but were NAKed by the addressed station because the SAP specified in the message was illegal</p> <p>This counter should always be 0.</p>

## Monitoring Data Sent without Acknowledgment

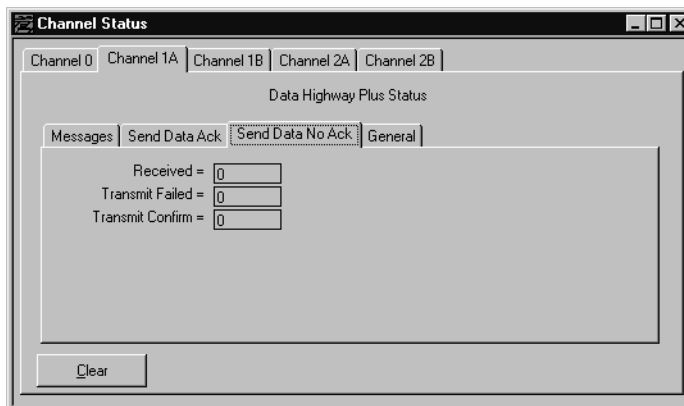

Status Field	Word(s)	Description
Received	35	Number of valid SDN messages received
Transmit failed	33	Number of SDN messages sent by the station that were in error This error should never be seen.
Transmit confirm	32	Number of valid SDN messages sent by the station

## Monitoring General Status

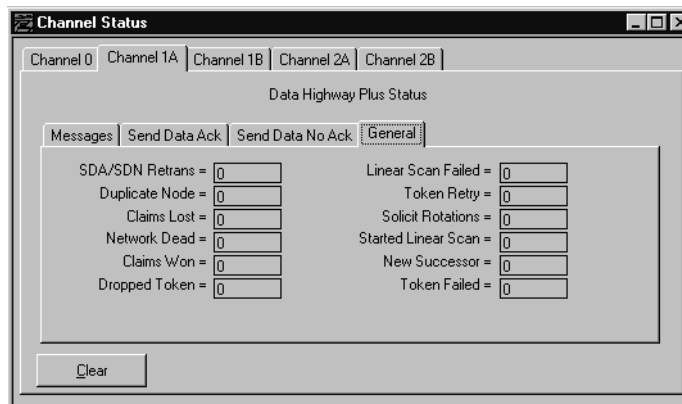

Status Field	Word(s)	Description
SDA or SDN transmit retry	28	Total number of SDA or SDN messages that were re-transmitted. Some reasons why the station would retry a message are:  the ACK was lost or corrupted on an SDA message, indicating a possible noise problem  the original message was NACKed
Duplicate node	17	Number of times the station has detected the same station address as itself on the network. As a result, the station goes offline.
Claims lost	11	Number of times the station did not win the claim token sequence. See claims won below for more information.
Network dead	9	Number of times the station detects no traffic on the network.  This usually occurs when the station with the token is powered down or is removed from the network. The other stations are waiting for the token to be passed to them. Eventually a network dead situation is declared and a claim token sequence initiated. (See claims won for more information.)
Claims won	10	Number of times the station has won the claim token sequence.  All the stations initiated a claim token sequence when a network goes down, is just powered up and the stations on the network detect that no one has the token, or when a station with the token is powered down or removed from the network. A claim token sequence is when all the stations on a network attempt to claim the token. When multiple stations attempt to claim the token, the lowest numbered station wins.
Dropped token	18	Number of times that the station detected that a duplicate node existed on the link and consequently dropped itself off the link  A station determines that there is a duplicate node when it detects that the response to a message or solicit successor is incorrect. For example, if a response is received from a station which was not communicated with, then the sending station assumes that the response is for a packet sent by another station with the same node number. Once the station drops itself off the link, it waits indefinitely to be solicited back into the network. It will only be solicited back into the network if the duplicate node is removed from the link, because station numbers that already exist on the link are not solicited into the network.

Status Field	Word(s)	Description
Linear scan failed	16	Number of times the station solicited every station number without getting a response. See started linear scan below for more information.
Token retry	13	Number of times the station had to re-transmit a token pass. The station re-transmits a token pass if it detects that the station it passed the token to did not receive the token. Noise can cause this to occur.
Solicit rotations	34	Number of times a complete solicit successor of all stations not on the link is completed.  A solicit successor occurs during a token pass around the link. Here a station that is currently not on the link is solicited to see if it has been added to the link. During each token pass, a different station number is solicited; solicitation occurs sequentially. A station can only join the link when it is solicited into it.
Started linear scan	15	Number of times the station has attempted to pass the token to everyone in its active node table and no one has responded.  The station will then start a linear scan where it solicits every station number until a station responds.
New successor	12	Number of times the station found a new successor for the token.  A new successor occurs when the station detects that a new station with a station number between its and a the station it was passing the token to was added to the link. The station now must pass the token to the newly added station.
Token failed	14	Number of times station could not pass token to its listed successor. This usually occurs due to:  the station being removed from the network  noise or cabling problems

## Estimating DH+ Link Performance

Many factors affect the performance of your DH+ link, including:

- nodes
- size and number of messages
- message destination
- internal processing time



## Nodes

Nodes affect transmission time in the following ways:

- During one complete token rotation, each node on the DH+ link receives the token whether or not it has something to send.
- Each node spends from 1.5 ms (if it has no messages to send) to 38 ms (maximum time allotted) with the token, assuming there are no retries, as shown below.

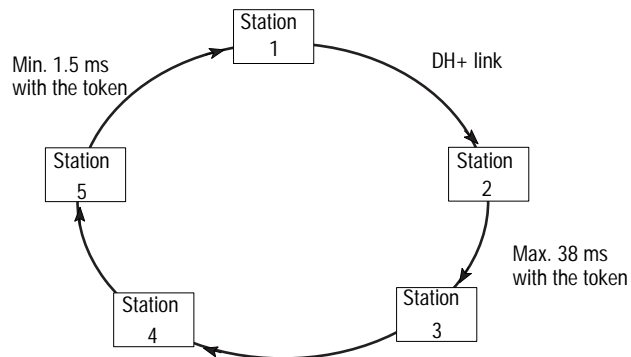

## Size and Number of Messages

A PLC-5 controller encodes messages into packets for transmission on the DH+ link. The maximum number of data words in a packet depends on the sending station and command type as shown in the table below.

Sending Station	Command Type	Maximum Packet Size (Data Words)
PLC-5	Typed READ/WRITE	114
PLC-5	Word range READ/WRITE	117
PLC-2	Unprotected READ/WRITE	121

This limit comes from the network protocol, which limits a station to transmitting a maximum of 271 bytes per token pass. A station can send more than one message in a token pass, provided that the total number of combined command and data bytes does not exceed 271.

If a message exceeds the maximum packet size allotted, however, the sending station will require more than one token pass to complete the message. For example, if a PLC-5 controller wants to send a 150-word message, it will have to transmit two messages, possibly requiring multiple token rotations.

The number of messages a station has to send also affects throughput time. For example, if a station has three messages queued and a fourth is enabled, the fourth message may have to wait until the previous three are processed.

### Message Destination

Throughput times vary depending on whether a receiving station can process the message and generate a reply before it receives the token. The figure below assumes that station 1 wants to send a message to station 4.

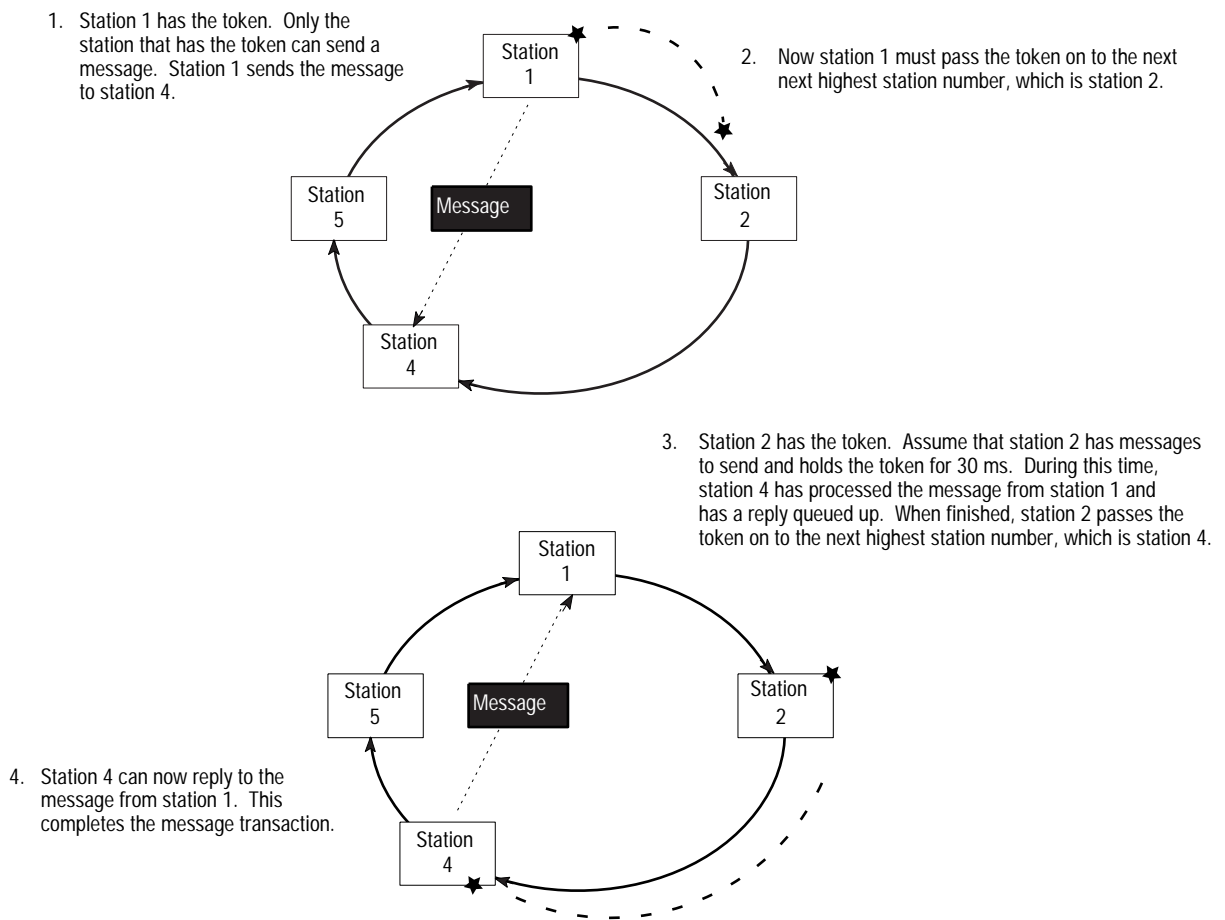

In the following figure, station 4 has had time to process the message and generate a reply. However, in , station 2 does not have sufficient time to process a MSG reply.

1. In this figure, we assume that station 1 wants to send the identical message as shown in Figure but to station 2. Station 1 has the token. Station 1 sends the message to station 2 and then passes the token on to station 2.

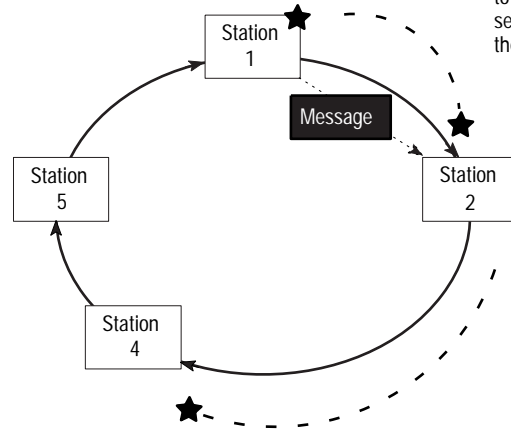

2. Now station 2 has the token but has not had time to generate a reply to station 1. So station 2 sends any other messages it has queued and then passes the token on to station 4.

4. The token then returns to station 2, which then sends its reply to station 1.

3. Stations 4, 5, and 1 all receive the token in order and send any messages they have queued.

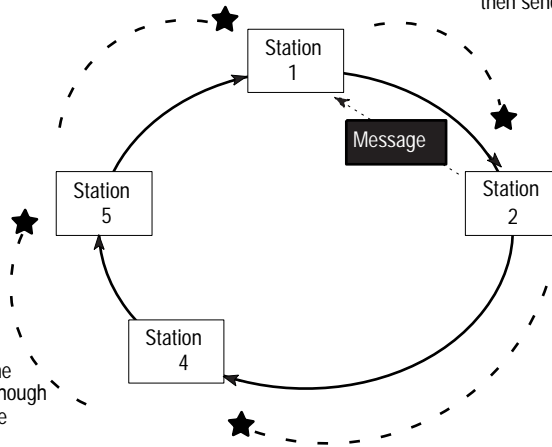

In this example, it took an extra token pass around the network to complete the message transaction even though the message was identical to the one shown in Figure 10.2.

## Internal Processing Time

Internal processing time depends on how busy a given controller on the network is when sending or receiving a message.

For example, controller A has just received a READ request from controller B on the network. If controller A already has three messages of its own to send, the reply to the READ request from controller B will have to wait until the station completes the processing of the messages queued ahead of it.

**Test Setup**

One to 22 PLC-5 controllers were used with one personal computer online. Each PLC-5 controller executes 1K of ladder logic.

Initial testing was done with one PLC-5 controller writing data to another PLC-5 controller. The response time was recorded. Additional PLC-5 controllers were added to the network, each writing the same amount of data to a PLC-5 controller at the next highest station address. Four separate tests were run using data transmissions of 50, 100, 250, and 500 words.

**Average DH+ Link Response Time Test Results**

This section shows graphically the results of testing performed on a DH+ link where the number of stations and words sent in the message varies.

The figure below shows the average response time of messages of varying sizes on a DH+ link with a varying numbers of stations. It also gives you an idea of the typical response time you can expect on a given DH+ link.

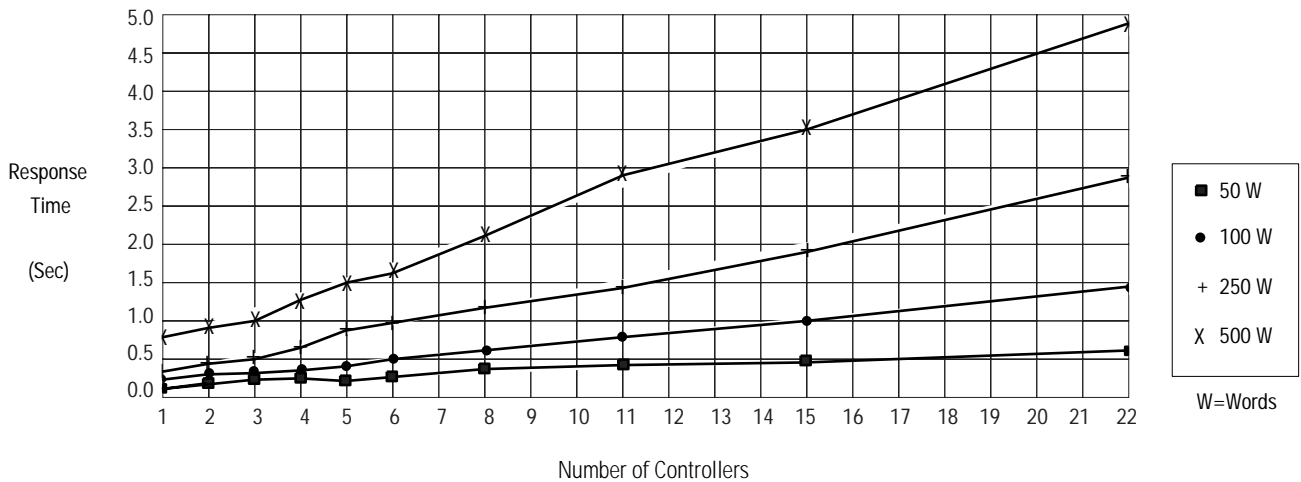

The following figure shows the effect of a personal computer on message response time under various configurations.

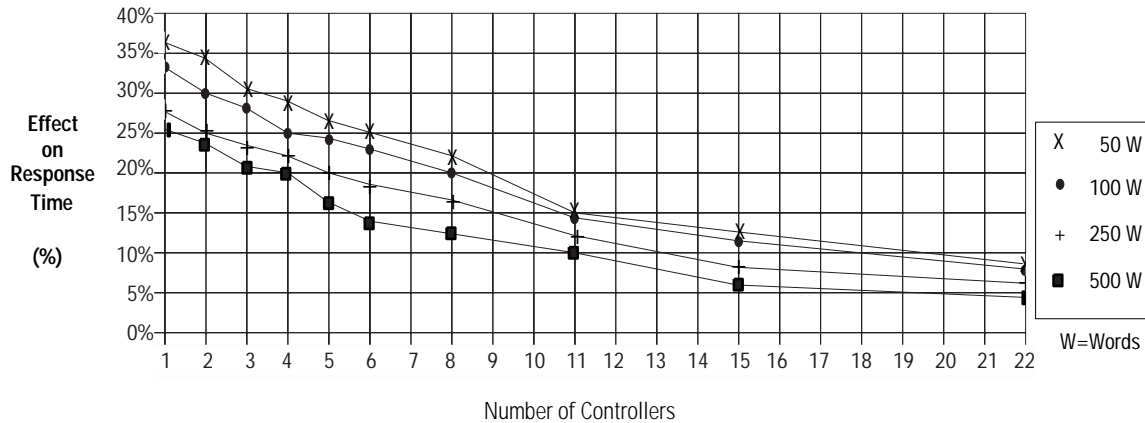

## Application Guidelines

Consider the following application guidelines when configuring a DH+ link for your system.

- Minimize the number of DH+ nodes to achieve acceptable response times. Keep in mind the size and frequency of messages exchanged between devices.
- Limit the number of nodes on your network when you are trying to achieve fastest control response time. You can establish separate DH+ networks to bring-on additional stations. Use a bridge to connect the DH+ links.
- When you connect a computer to the link for operator interface or a third-party serial device to the DH+ link, select the fastest possible serial interface communication rate.
- Do not add or remove nodes from the network during machine or process operation. If the network token resides with a device that is removed, the token may be lost to the rest of the network. The network is automatically re-established, but it could take several seconds. Control would be unreliable or interrupted during this time.
- A DH+ link has a 90 s timeout period; however, you can include watchdog timers in logic programs for DH+ transfer of data (to provide an orderly shutdown if failure occurs).
- When possible, do not program controllers online during machine or process operation. This could result in long bursts of DH+ activity that could increase response time. See chapter 9 for more information.
- When possible, add a separate DH+ link for programming controllers to keep effects of the personal computer from the process DH+ link.

## Notes

## Communicating with Devices on a Serial Link

### Using This Chapter

For Information About:	Go to Page:
Choosing between RS-232C, RS-422A, and RS-423	10-1
Configuring the controller serial port	10-2
Using channel 0	10-2
Cabling	10-5
Configuring channel 0	10-6
Monitoring channel 0 status	10-22

If you are using PLC-5 controllers in Supervisory Control and Data Acquisition (SCADA) applications, see the SCADA System Selection Guide, publication AG-SG001.

### Choosing Between RS-232C, RS-422A, and RS-423

The table below summarizes some of the differences between RS-232C, RS-422A, and RS-423 communication modes:

This Method	Is Normally Used When You
RS-232C	<p>have a data transmission range of up to 50 ft. (15.2m).</p> <p>Applications requiring longer distances can use modems or line drivers.</p> <p>Use RS-232C for half- or full-duplex communication. For example, computers communicating with controllers or modems in SCADA applications.</p>
RS-422A	<p>want to transmit data to RS-422A-compatible devices over ranges greater than RS-232C allows. See on page 10-5.</p> <p>Use RS-422A for point-to-point communication, with one device communicating with as many as 10 other devices.</p>
RS-423	<p>want to transmit data to RS-423-compatible devices over ranges greater than RS-232C allows. See on page 10-5.</p> <p>Use RS-423 for point-to-point communication, with one device communicating with as many as 10 other devices.</p>

## Configuring the Controller Serial Port

Channel 0 is the serial port and is configurable for RS-232C, RS-423, or RS-422A compatible communication. Use switch assembly SW2 to specify the serial port configuration.

To set the controller switch, see chapter 23 or look on the side label of the controller, which shows the switches in switch assembly SW2 and a table listing the settings.

## Using Channel 0

You can use the controller's serial port (channel 0) to connect the controller to devices that:

- can send and receive ASCII characters by using User mode (ASCII communication)
- communicate using DF1 protocol by using one of three available System modes

### User Mode

In user mode, all data are received and sent via a buffer. To access or send this data, use ASCII instructions in your ladder program. The ASCII data a PLC-5 controller sends contain no additional protocol characters.

In user mode, only ASCII instructions can be used. If you try to use a message (MSG) instruction that references the serial port, the error (.ER) bit is set.

Examples of ASCII peripheral devices are:

- ASCII terminals
- Bar code readers
- Allen-Bradley Dataliners
- Weigh scales
- Printers

### System Mode

In system mode, the controller interprets a command from another device. Use system mode when you need to communicate with other devices on a link. System mode, with DF1 protocol, is a separate and unique communication link from the DH+ link.



In system mode, you can send data to a device using:

- the message (MSG) instruction; or
- ASCII write instructions (send as an ASCII string)

All data is encapsulated inside a DF1 protocol packet; therefore, the controller can communicate only with peripheral devices that support the DF1 protocol.

Examples of DF1 peripheral devices are:

- personal computers
- communication modules such as 1771-KF2 series C, 1771-KE, 1771-KF, and 1785-KE
- modems

Use this Mode	For
Point-to-Point	<p>communication between a PLC-5 controller and one other DF1 protocol compatible device</p> <p>In point-to-point mode, a PLC-5 controller uses DF1 full-duplex protocol.</p>
DF1 Master Mode	<p>control of polling and message transmission between the master and each remote node</p> <p>In master mode, a PLC-5 controller uses DF1 half-duplex polled protocol.</p> <p>The master/remote network includes one PLC-5 controller configured as the master node and up to 254 remote nodes. You link remote nodes using modems or line drivers.</p> <p>A master/remote network can have node numbers from 0 to 376 (octal). Node 377 is reserved for broadcast. Each node must have a unique node address. Also, at least 2 nodes must exist to define your link as a network (1 master and 1 remote station are two nodes).</p>
DF1 Slave Mode	<p>using controller as a remote station in a master/slave serial communication network</p> <p>When there are multiple remote stations on the network, you link remote nodes using modems or line drivers. When you have a single remote station on the network, you do not need a modem to connect the remote station to the master; you can configure the control parameter for no handshaking. You can connect from 2 to 255 nodes to a single link. In slave mode, a PLC-5 controller follows DF1 half-duplex protocol.</p> <p>One node is designated as the master and it controls who has access to the link. (For example, a master can be a PLC-5/250 or PLC-5/40 controller or a computer running ControlView SCADA option software. All other nodes are remote stations and must wait for permission from the master before transmitting. The master (except PLC-5/250) can send and receive messages from all nodes on the link and to nodes on other Data Highway links connected to the multidrop; whereas, a remote station can only respond to the master.</p>

## Master Station to Remote Station Communication Methods

A PLC-5 master station can communicate with remote stations in two ways:

Method	Option Name	Principal Benefits
<p>initiating polling packets to remote stations according to their position on a polling list</p> <p>Polling packets are formed independently of any user-programming.</p>	<p>standard communication mode</p>	<p>This is the communication mode used most often in point-to-multipoint configurations.</p> <p>Provides for these capabilities:</p> <ul style="list-style-type: none"> <li>remote stations can send messages to the master station (polled report-by-exception)</li> <li>remote stations can send messages to each other</li> <li>lets the master station maintain an active node table</li> <li>The poll list resides in a user designated and accessible integer-type data file. You can:                             <ul style="list-style-type: none"> <li>include the master on the poll list</li> <li>configure the master for between-station polls (master transmits any message that it needs to send before polling the next remote station)</li> <li>have the master both in the poll list and configured for between-station polls</li> </ul> </li> </ul>
<p>initiating communication to remote stations using only user-programmed message (MSG) instructions</p> <p>Each request for data from a remote station must be programmed via a message instruction.</p> <p>The master polls the remote station for a reply to the message after waiting a user-configured period of time. The waiting period gives the remote station time to formulate a reply and prepare the reply for transmission. After all of the messages in the master's message-out queue are transmitted, the remote-to-remote queue is checked for messages to send.</p>	<p>message-based communication mode</p>	<p>If your application uses satellite transmission or public switched telephone network transmission, consider choosing message-based. Communication to a remote station can be initiated on an as needed basis.</p> <p>Or choose this method if you need to communicate with non-intelligent remote terminal units (RTUs).</p>

## Polling Inactive Priority Stations

Through the channel configuration feature of your programming software, you can choose to poll one or all of the inactive priority stations when the PLC-5 controller is in master mode on channel 0. The default selection is to poll one inactive priority station during each polling sequence.

If you choose to poll all inactive stations, you are alerted immediately when an inactive station becomes active; you do not have to wait for all of the other polling sequences to complete. Polling all inactive stations might slow down channel performance.

## Changing Modes

Configure channel 0 of the controller to change communication modes via:

- the channel configuration screen in your programming software (in program mode only) ; or
- communication mode change characters (ASCII control characters) sent remotely to the controller, which switches modes

## Cabling

The following table lists the maximum cable lengths you can use with channel 0.

Port	Transmission Rate(s)	Maximum Cable Length
RS-232C	All	15 m (50 ft)
RS-422A (compatible)	All	61 m (200 ft)
RS-423	All	61 m (200 ft)

### IMPORTANT

#### Follow these guidelines:

- When channel 0 is configured for RS-422A compatibility, do not use terminating resistors anywhere on the link.
- When channel 0 is configured for RS-422A (compatible) and RS-423, do not go beyond 61 m (200 ft). This distance restriction is independent from the transmission rate.

## Configuring Channel 0

Use switch assembly SW2 controllers to specify RS232-C, RS422A (compatible), or RS423 communications for channel 0.

You can configure channel 0 to communicate using these protocols:

If You Want to Use	See Page
System mode	DF1 point-to-point 10-6
	DF1 slave 10-9
	DF1 master 10-12
User mode	ASCII 10-18

### Configure Channel 0 for DF1 Point-to-Point

To configure channel 0 for DF1 point-to-point communication, use the system mode configuration screen in your programming software.

configure the serial communications as system point-to-point →

specify the details →

The screenshot shows the 'Edit Channel Properties' dialog box with the following settings:

- Channel Selection:** Channel 0 (selected)
- Communication Mode:** System (Point-To-Point) (selected)
- System (Slave):** Unselected
- System (Master):** Unselected
- User (ASCII):** Unselected
- Remote Mode Change:** Unchecked
- Attention Char:** \0x1b
- System:** S
- User:** U
- Diagnostic File:** 0
- Serial Port Options:**
  - Baud Rate: 2400
  - Parity: None
  - Bits Per Char: 8
  - Error Detect: BCC
  - Stop Bits: 1
  - Control Line: No Handshaking

This Field	Specifies	Configure by Doing the Following
Diagnostic file	The file containing the channel's status information	<p>Enter an integer file number (10-999).</p> <p><b>ATTENTION:</b> Assign a unique diagnostic file to each channel. Do not assign a diagnostic file that is the I/O status file you assigned or any other used integer file. Unpredictable machine operation can result.</p> <p><b>Important:</b> You must define a diagnostics file for a channel configured for anything but unused (even if you are not using the channel) if you want to get status information for that channel.</p>
Enable	Whether the remote mode change option is enabled	Select ENABLED.
Mode attention char.	The attention character for the system or the user mode character for remote change	Enter a character. If the attention character you want to use is a control character, specify the ASCII equivalent.
System mode char.	The character to be used with the mode attention character (above)	<p>Enter a character. If the attention character you want to use is a control character, specify the ASCII equivalent.</p> <p>When the controller encounters the attention character and the system mode character, the controller sets channel 0 communication to system mode. The remote mode change option must be ENABLED.</p>
User mode char.	The character for the mode attention character (above)	<p>Enter a character. If the attention character you want to use is a control character, specify the ASCII equivalent.</p> <p>When the controller encounters the attention character and the user mode character, the controller sets channel 0 communication to user mode. The remote mode change option must be ENABLED.</p>
<b>Serial Settings</b>		
Baud rate	<p>Communication rate for channel 0</p> <p>Configure all devices in the system for the same communication rate</p>	Select 110, 300, 600, 1200, 2400, 4800, 9600, or 19.2k bps.
Parity	<p>Parity setting for channel 0</p> <p>Parity provides additional message packet error detection.</p>	Select NONE or EVEN.
Bits per character	Select the number of bits that make up a transmitted character.	Select 7 or 8.
Error detect	Whether you want error detection set to BCC or CRC	<p>Select one of the following:</p> <p>BCC: the controller sends and accepts messages that end with a BCC byte for error checking. BCC is quicker and easier to implement in a computer driver.</p> <p>CRC: the controller sends and accepts messages with a 2-byte CRC for error checking. CRC is more complete checking</p> <p>Configure both stations to use the same type of error checking.</p>

<b>This Field</b>	<b>Specifies</b>	<b>Configure by Doing the Following</b>
Stop bits	Match the number of stop bits to the device with which you are communicating	Select 1, 1.5, or 2.
Control line	Select the mode in which the driver operates.	Select a method appropriate for your system's configuration:  If you are not using a modem, choose NO HANDSHAKING.  If you are using a full-duplex modem, choose FULL-DUPLEX.
<b>Option Settings</b>		
Duplicate detect	Whether you want the controller to detect and ignore duplicate messages	Select the desired setting.
ACK timeout	The amount of time you want the controller to wait for an acknowledgment to its message transmission	Enter a value 0-65535. Limits are defined in 20 ms intervals. For example to wait 40 ms, type 2. The recommended time elapse is 1 second. Specify 1 second by typing 50.
MSG appl timeout	The number of seconds within which the reply message must be received before the error bit is set on the message. The timer starts when the ladder program first initiates the message and is restarted if/when the ACK is received	Enter one of the following values:  1:30-60 seconds  2:60-90 seconds  3:90-120 seconds  4:120-150 seconds  5:150-180 seconds  6:180-210 seconds  7:210-240 seconds
NAK receive	The number of NAKs your controller can receive in response to a transmitted message	Enter a value 0-255. The recommended setting is 3.
DF1 ENQS	The number of enquiries (ENQs) that you want the controller to send after an ACK timeout	Enter a value 0-255. The recommended setting is 3.

## Configure Channel 0 as a Slave Station

To configure channel 0 for DF1 slave communication, use the system mode configuration screen in your programming software.

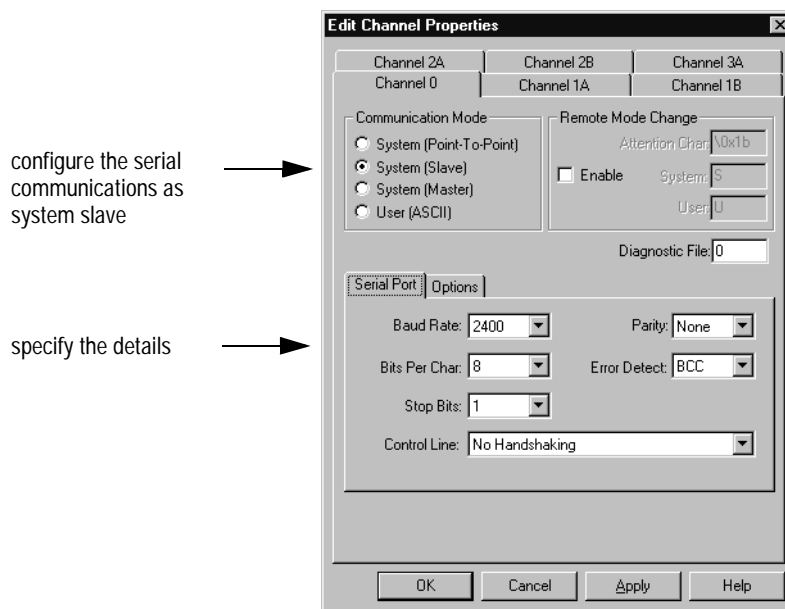

This Field	Specifies:	Configure by Doing the Following
Diagnostic file	The file containing the channel's status information	Enter an integer file number (10-999).  <b>ATTENTION:</b> Assign a unique diagnostic file to each channel. Do not assign a diagnostic file that is the I/O status file you assigned or any other used integer file. Unpredictable machine action can result.  <b>Important:</b> You must define a diagnostics file for a channel configured for anything but unused (even if you are not using the channel) if you want to get status information for that channel.
Enable	Whether the remote mode change option is enabled	Select ENABLED or DISABLED.
Mode attention char.	The attention character for the system mode or the user mode character for a remote mode change	Enter a character. If the attention character you want to use is a control character, specify the ASCII equivalent.
System mode char.	The character for the mode attention character (above)	Enter an attention character. If the attention character you want to use is a control character, specify the ASCII equivalent.  When the controller encounters the attention character and the system mode character, the controller sets channel 0 communication to system mode. The remote mode change option must be ENABLED.

<b>This Field</b>	<b>Specifies:</b>	<b>Configure by Doing the Following</b>
User mode char.	The character for the mode attention character (above)	Enter a character. If the attention character you want to use is a control character, specify the ASCII equivalent.  When the controller encounters the attention character and the user mode character, the controller sets channel 0 communication to user mode. The remote mode change option must be ENABLED.
<b>Serial Settings</b>		
Baud rate	Communication rate for channel 0  Configure all devices in the system for the same communication rate	Select 110, 300, 600, 1200, 2400, 4800, 9600, or 19.2k bps.
Parity	Parity setting for channel 0  Parity provides additional message packet error detection.	Select NONE or EVEN.
Bits per character	Select the number of bits that make up a transmitted character.	Select 7 or 8.
Error detect	Whether you want error detection set to BCC or CRC	Select one of the following:  BCC: the controller sends and accepts messages that end with a BCC byte for error checking. BCC is quicker and easier to implement in a computer driver.  CRC: the controller sends and accepts messages with a 2-byte CRC for error checking. CRC is more complete checking  Configure both stations to use the same type of error checking.
Stop bits	Match the number of stop bits to the device with which you are communicating	Select 1, 1.5, or 2.
Control line	Select the mode in which the driver operates.	Select a method appropriate for your system's configuration:  If you are not using a modem, choose NO HANDSHAKING.  If you are using a full-duplex modem, choose FULL-DUPLEX.
<b>Option Settings</b>		
Station address	The station address for channel 0 on the DF1 half-duplex link	Enter a valid DF1 address (0-376 octal).
DF1 retries	The number of times the remote station retries a message before the station declares the message undeliverable	Enter a value 0-255. The recommended setting is 3.



This Field	Specifies:	Configure by Doing the Following
RTS send delay	<p>The amount of time that elapses between the assertion of the RTS signal and the beginning of the message transmission</p> <p>This time allows the modem to prepare to transmit the message.</p> <p>The CTS signal must be high for transmission to occur.</p>	<p>Enter a value 0-255. Limits are defined in 20 ms intervals. For example to wait 40 ms, type 2. The recommended time elapse is 0, unless you are using a modem that automatically returns the CTS as soon as it receives the RTS. If this is the case, enter a delay time to make sure the modem is able to transmit before it attempts to send the message.</p>
RTS off delay	<p>The amount of time that elapses between the end of the message transmission and the de-assertion of the RTS signal.</p> <p>This time delay is a buffer to make sure that the modem has transmitted the message.</p>	<p>Enter a value 0-255. Limits are defined in 20 ms intervals. For example to wait 40 ms, type 2.</p>
ACK timeout	<p>The amount of time you want the controller to wait for an acknowledgment to its message transmission</p>	<p>Enter a value 0-65535. Limits are defined in 20 ms intervals. For example to wait 40 ms, type 2. The recommended time elapse is 1 second. Specify 1 second by typing 50.</p>
Duplicate detect	<p>Whether you want the controller to detect and ignore duplicate messages</p>	<p>Select the desired setting.</p>
MSG application timeout	<p>The number of seconds within which the reply message must be received before the error bit is set on the message</p> <p>The timer starts when the ladder program first initiates the message and is restarted if/when the ACK is received.</p>	<p>Cursor to the field, type in a value 1-7, and press <b>[Enter]</b>.</p> <p>Available options are:</p> <ul style="list-style-type: none"> <li>1:30-60 seconds</li> <li>2:60-90 seconds</li> <li>3:90-120 seconds</li> <li>4:120-150 seconds</li> <li>5:150-180 seconds</li> <li>6:180-210 seconds</li> <li>7:210-240 seconds</li> </ul>

## Configure Channel 0 as a Master Station

To configure channel 0 for DF1 master communication, use the system mode configuration screen in your programming software.

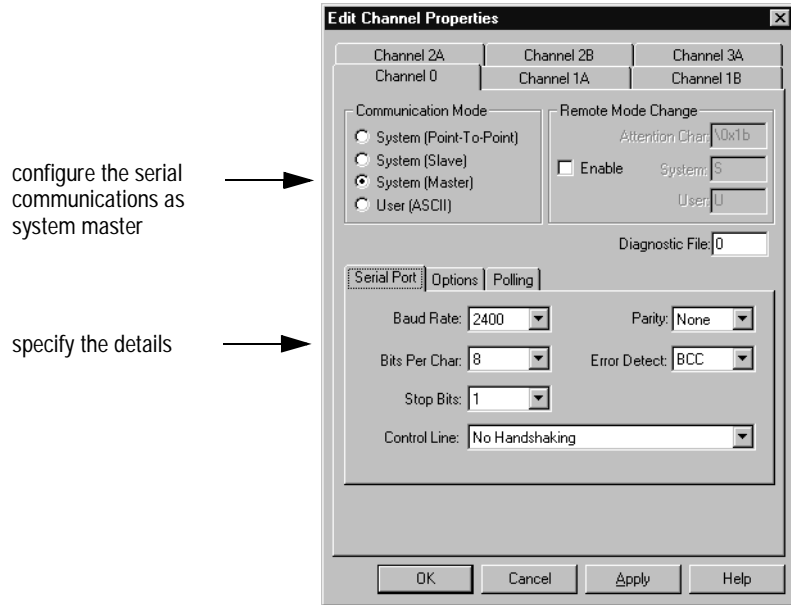

This field	Specifies	Configure by Doing the Following
Diagnostic file	The file containing the channel's status information	Enter an integer file number (10-999).  <b>ATTENTION:</b> Assign a unique diagnostic file to each channel. Do not assign a diagnostic file that is the I/O status file you assigned or any other used integer file. Unpredictable machine action can result.  <b>Important:</b> You must define a diagnostics file for a channel configured for anything but unused (even if you are not using the channel) if you want to get status information for that channel.
Enable	Whether the remote mode change option is enabled	Select ENABLED or DISABLED.
Mode attention char.	The attention character for the system mode or the user mode character for a remote mode change	Enter a valid attention character. If the attention character you want to use is a control character, specify the ASCII equivalent.
System mode char.	The character for the mode attention character (above)	Enter a valid attention character. If the attention character you want to use is a control character, specify the ASCII equivalent.  When the controller encounters the attention character and the system mode character, the controller sets channel 0 communication to system mode. Note that the remote mode change option must be ENABLED.

<b>This field</b>	<b>Specifies</b>	<b>Configure by Doing the Following</b>
User mode char.	The character for the mode attention character (above)	Enter a valid attention character. If the attention character you want to use is a control character, specify the ASCII equivalent.  When the controller encounters the attention character and the user mode character, the controller sets channel 0 communication to user mode. Note that the remote mode change option must be ENABLED.
<b>Serial Settings</b>		
Baud rate	Communication rate for channel 0  Configure all devices in the system for the same communication rate	Select 110, 300, 600, 1200, 2400, 4800, 9600, or 19.2k bps.
Parity	Parity setting for channel 0  Parity provides additional message packet error detection.	Select NONE or EVEN.
Bits per character	Select the number of bits that make up a transmitted character.	Select 7 or 8.
Error detect	Whether you want error detection set to BCC or CRC	Select one of the following:  BCC: the controller sends and accepts messages that end with a BCC byte for error checking. BCC is quicker and easier to implement in a computer driver.  CRC: the controller sends and accepts messages with a 2-byte CRC for error checking. CRC is more complete checking  Configure both stations to use the same type of error checking.
Stop bits	Match the number of stop bits to the device with which you are communicating	Select 1, 1.5, or 2.
Control line	Select the mode in which the driver operates.	Select a method appropriate for your system's configuration:  If you are not using a modem, choose NO HANDSHAKING.  If you are using a full-duplex modem, choose FULL-DUPLEX.
<b>Option Settings</b>		
Station address	The node's address on the DF1 link	Enter a valid DF1 station address. Valid station addresses are: 0-376 octal
DF1 retries	The number of times a message is retried before being declared undeliverable	Enter a valid value 0-255.
RTS send delay	The time delay between the time the RTS is asserted and the beginning of the message transmission  This time allows the modem to prepare to transmit the message.	Enter a value 0-255. Limits are defined in 20 ms intervals. For example to wait 40 ms, type 2. The recommended time elapse is 0, unless you are using a modem that automatically returns the CTS as soon as it receives the RTS. If this is the case, enter a delay time to make sure the modem is able to transmit before it attempts to send the message.

This field	Specifies	Configure by Doing the Following
RTS off-delay	<p>The time delay between the time the end of the message transmission and the RTS is de-asserted</p> <p>This time delay is a buffer to make sure that the modem has transmitted the message.</p>	<p>Enter a value 0-255. Limits are defined in 20 ms intervals. For example to wait 40 ms, type 2. The recommended time elapse is 0, unless you are using a modem that automatically returns the CTS as soon as it receives the RTS. If this is the case, enter a delay time to make sure the modem is able to transmit before it attempts to send the message.</p>
ACK timeout	<p>The amount of time you want the controller to wait for an acknowledgment from a remote station to its transmitted message before the controller retries the message or the message errors out</p>	<p>Enter a value 0-65535. Limits are defined in 20 ms intervals. For example to wait 40 ms, type 2. The recommended time elapse is 1 second. Specify 1 second by typing 50.</p>
Reply msg wait	<p>The amount of time the master will wait after receiving an ACK (to a master-initiated message) before polling the slave for a reply</p>	<p>Only define this if you are message-based mode. Enter a valid value 0-65535 (in 20ms increments).</p>
MSG application timeout	<p>The number of seconds within which the reply message must be received before the error bit is set on the message</p> <p>The timer starts when the ladder program first initiates the message and is restarted if/when the ACK is received.</p>	<p>Select one of the following:</p> <ul style="list-style-type: none"> <li>1:30-60 seconds</li> <li>2:60-90 seconds</li> <li>3:90-120 seconds</li> <li>4:120-150 seconds</li> <li>5:150-180 seconds</li> <li>6:180-210 seconds</li> <li>7:210-240 seconds</li> </ul>
<b>Polling Settings</b>		
Polling mode	The current value of the polling mode	<p>Select one of the following:</p> <p>MESSAGE BASED (ALLOW SLAVE TO INITIATE MESSAGES)—default—this option allows remote station initiated messages to be processed after all master-initiated messages</p> <p>MESSAGE BASED (DO NOT ALLOW SLAVE TO INITIATE MESSAGES)—remote station-initiated messages will be acknowledged but not processed</p> <p>STANDARD (MULTIPLE MESSAGE TRANSFER PER NODE SCAN)—the master polls stations based on a list; each station can transmit multiple messages per node scan</p> <p>STANDARD (SINGLE MESSAGE TRANSFER PER NODE SCAN)—the master polls stations based on a list; each station can transmit only one message per node scan</p>

This Field	Specifies	Configure by Doing the Following
Master message transmit	The current value of channel 0 master message transmit	<p>If you want the master station to:</p> <p>send all of the master station-initiated MSG instructions to the remote stations before polling the next remote station in the poll list, choose <b>Between Station Polls</b></p> <p>This method makes certain that master station-initiated messages are sent in a timely and regular manner (after every remote station poll).</p> <p>only send master station-initiated MSG instructions when the master's station number appears in the polling sequence, choose <b>In Poll Sequence</b></p> <p>With this method, sending master station-initiated messages are dependent upon where and how often the master station appears in the poll list. To achieve the same goal as the <b>Between Station Polls</b> method, the master-station's address would have to appear after every remote-station's address.</p> <p>The controller sets a minor fault if you are using <b>IN POLL SEQUENCE</b> and the master's station is not in either the normal poll list or the priority poll list.</p>
Normal poll node file	The integer file that contains the addresses of the remote stations you want in the normal poll list	Enter an integer file number 0-255
Normal poll group size	The quantity of active stations located in the normal poll list that you want polled during a scan through the normal poll list before returning to the priority poll list	Enter a valid value 10-999.
Priority poll node file	The integer file that contains the addresses of the remote stations you want in the priority poll list	Enter an integer file number 10-999.
Active station file	The binary file that stores the station addresses of all active stations on the link.	Enter a binary file number 10-999.

To define a polling scheme using standard mode, you must specify the following on the DF1 master configuration screen in your programming software:

Configuration Parameter	Definition
Polling mode	How you want the master to poll the station lists.
Master message transmit	When you want the master to send messages.
Normal poll file	An integer file in which you place the station addresses of the remote stations.  The default size is 64 words.
Priority poll file	An integer file in which you place the addresses of stations from which you need to collect data more frequently.  The default size is 64 words.
Normal poll group size	The number of stations that the master polls before it polls a station in the priority poll list.
Active station file	A binary file that stores the station addresses of all active stations on the link.  The default size is 18 words.  Both the normal poll list and the priority poll list can have active and inactive stations. A station becomes inactive when it does not respond to a master's request for data.

The master station polls the slave station in the following a definitive sequence:

1. All stations in the **active** priority poll file.
2. Specified stations in the active normal poll file. The number of stations polled in this file is determined by the normal poll group size specified on the configuration screen. If the group size was 3, for example, then three stations would be polled in the normal file before the master continues to the next step in the sequence.
3. One station in the inactive poll file after all active stations in the normal poll file have been polled.

To create station lists, place each station address in an individual word in a poll file (normal and/or priority) starting at word 2. The poll file layout is as follows:

This Word in a Poll File	Contains this Information
Word 0	total number of stations in the list
Word 1	address location (poll offset) of the station currently being polled  For example: a value of 1 means the station address stored in word 2 is being polled, 2 means the address stored in word 3 is being polled, etc.  This word is automatically updated by the master station as a new remote station is polled.
Word 2 through word xx	remote station address in the order that the station should be polled

To place a station address in a poll file, do the following:

1. Access the data monitor in your programming software.
2. Specify the address of the integer file that is either the normal poll file or priority poll file (e.g., if the normal poll file is N11, then you specify N11:0).
3. Enter the station addresses of the remote stations you want in the poll list starting at word 2. Put them in the order you want them polled.

**IMPORTANT**

Station addresses are octal addresses. The poll files are integer files. The default radix is decimal. To properly enter station addresses in a poll file, you must either:

- change the radix of the file to octal
- convert the octal station addresses to decimal before entering the addresses

Below is an example of a station list containing three stations: octal addresses 10, 11, and 12 have been entered. Station 12 (10 decimal) is being polled.

Poll File	Word 0	Word 1	Word 2	Word 3	Word 4
N:11	3	3	08	09	10
N:xx	total number of stations	pointer showing the station address being polled (Station 12 in word 4 is being polled.)	address of first station in list	address of second station in list	address of third station in list

## Configure Channel 0 for User Mode (ASCII Protocol)

To configure channel 0 for user mode, use the user mode configuration screen in your programming software.

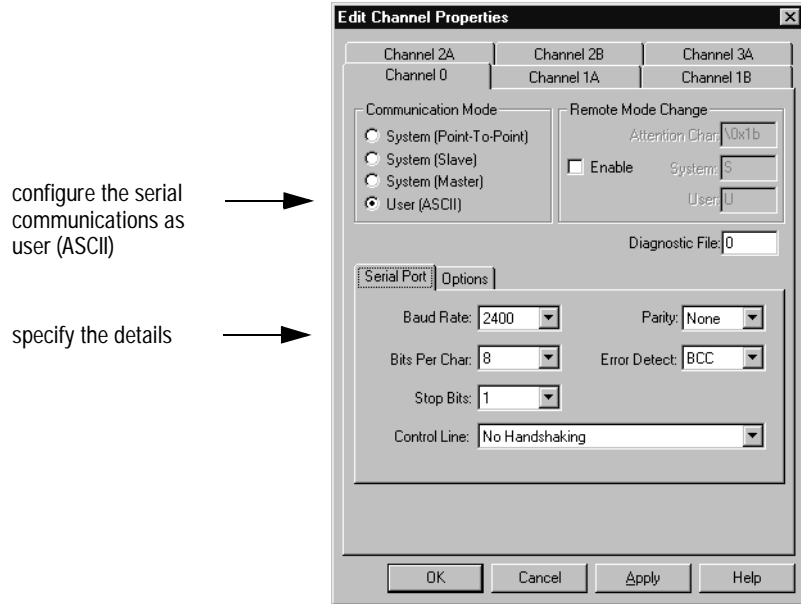

This Field	Specifies	Configure by Doing the Following
Diagnostic file	The file containing the channel's status information	Enter an integer file number (10-999).  <b>ATTENTION:</b> Assign a unique diagnostic file to each channel. Do not assign a diagnostic file that is the I/O status file you assigned or any other used integer file. Unpredictable machine action can result.  <b>Important:</b> You must define a diagnostics file for a channel configured for anything but unused (even if you are not using the channel) if you want to get status information for that channel.
Remote mode change	Whether the remote mode change option is enabled	Select ENABLED or DISABLED.
Mode attention char.	The attention character for the system mode or the user mode character	Enter a character. If the attention character you want to use is a control character, specify the ASCII equivalent.
System mode char.	The character for the mode attention character (above)	Enter a character. If the attention character you want to use is a control character, specify the ASCII.  When the controller encounters the attention character and the system mode character, the controller sets channel 0 communication to system mode. The remote mode change option must be ENABLED.



This Field	Specifies	Configure by Doing the Following
User mode char.	The character for the mode attention character (above)	Enter a valid attention character. If the attention character you want to use is a control character, specify the ASCII equivalent.  When the controller encounters the attention character and the user mode character, the controller sets channel 0 communication to user mode. The remote mode change option must be ENABLED.
<b>Serial Settings</b>		
Baud rate	Communication rate for channel 0  Configure all devices in the system for the same communication rate	Select 110, 300, 600, 1200, 2400, 4800, 9600, or 19.2k bps.
Parity	Parity setting for channel 0  Parity provides additional message packet error detection.	Select NONE or EVEN.
Bits per character	Select the number of bits that make up a transmitted character.	Select 7 or 8.
Error detect	Whether you want error detection set to BCC or CRC	Select one of the following:  BCC: the controller sends and accepts messages that end with a BCC byte for error checking. BCC is quicker and easier to implement in a computer driver.  CRC: the controller sends and accepts messages with a 2-byte CRC for error checking. CRC is more complete checking  Configure both stations to use the same type of error checking.
Stop bits	Match the number of stop bits to the device with which you are communicating	Select 1, 1.5, or 2.
Control line	Select the mode in which the driver operates.	Select a method appropriate for your system's configuration:  If you are not using a modem, choose NO HANDSHAKING.  If you are using a full-duplex modem, choose FULL-DUPLEX.
<b>Option Settings</b>		
RTS send delay	The time delay between the time the RTS is asserted and the beginning of the message transmission	Enter a value between 0 and 255. Limits are defined in 20 ms intervals. For example to wait 40 ms, type 2. The recommended time elapse is 0, unless you are using a modem that automatically returns the CTS as soon as it receives the RTS. If this is the case, enter a delay time to make sure the modem is able to transmit before it attempts to send the message.
RTS off-delay	The time delay between the time the end of the message transmission and the RTS is de-asserted	Enter a value between 0 and 255. Limits are defined in 20 ms intervals. For example to wait 40 ms, type 2. The recommended time elapse is 0, unless you are using a modem that automatically returns the CTS as soon as it receives the RTS. If this is the case, enter a delay time to make sure the modem is able to transmit before it attempts to send the message.

This Field	Specifies	Configure by Doing the Following
Delete mode	Select how the controller responds to a delete character.	Select Ignore, CRT, or Printer. If you select Ignore, the controller ignores the delete character. If you select CRT or Printer, the controller ignores the character it received immediately before the delete character. The controller then sends a signal to the CRT or printer to erase the deleted character. Select CRT or Printer only if you enable the echo mode.
XON/XOFF	Whether or not you want XON/XOFF enabled	<p>As the controller receives characters, it constantly determines how many more it can receive without losing any. When XON/XOFF is enabled, the controller sends a "stop sending character," XOFF. If the sending device has the XON/XOFF feature, it stops sending characters. When the controller has more room, it will send a "start sending" character (XON).</p> <p>Select ENABLED or DISABLED.</p>
Echo	What the controller should do when it receives an ASCII delete character	If you disable the echo mode, characters received by the controller are sent only to the echo counter and not to an output device, such as a CRT or printer. If you enable the echo mode, the controller sends any characters it receives through an ASCII read or read line instruction to a waiting output device. For example, if you want the controller to print a message to a LED marquee, enable the echo mode.
Termination 1 Termination 2	The termination characters you defined	<p>Enter a maximum of two characters (hexadecimal).</p> <p>Use termination characters with the ASCII Read Line instruction or with the Test Buffer for Line (ABL) to indicate a line has been entered.</p> <p>The default character is the ASCII equivalent for [RETURN], 0x0D. You can also use the ASCII equivalent for LINE FEED (0x0A). To specify no character, enter \FF.</p>
Append 1 Append 2	The append characters you defined	<p>Enter a maximum of two characters (hexadecimal).</p> <p>Use append characters with the ASCII Write with Append (AWA) instruction to indicate the end of a line. Append characters are the last characters sent after a line of information.</p> <p>The default characters are the ASCII equivalent for [RETURN] (/0D) and LINE FEED (/0A). To specify no character, enter \FF.</p>

## Configure Channel 0 for a Communication Mode Change

You can configure channel 0 so that it switches from one communication mode to another upon receiving a control command. You define a mode attention character and either a system or user mode character.

Character	Tells the Controller to	Default Character
Mode attention character	expect a change communication mode command	[ <b>Esc</b> ]
System mode character	switch the communication mode to system mode	<b>S</b>
User mode character	switch the communication mode to the user mode	<b>U</b>

Every time the controller receives the mode attention character and either a system or user mode character, channel 0's communication mode will be switched to the new mode.

To configure channel 0 for a remote communication-mode change, follow the steps on the left:

If You Want To	Select
Change the communication mode of channel 0 remotely	ENABLE
Not change the communication mode of channel 0 remotely	DISABLE

### IMPORTANT

Make sure the remote mode change option is disabled if you do not want to change channel 0's communication mode over a remote link. Having the mode disabled prevents an unexpected communication mode change.

The Mode Attention character tells the controller to expect a communication mode change. If you are using a control character, enter the ASCII equivalent in hexadecimal. With other characters, just enter the character. Do one of the following:

Enter the character you want to use to tell the controller to switch communication modes for channel 0. If you are using a control character, use the ASCII equivalent in hexadecimal. With other characters, just enter the character.

## Monitoring Channel 0 Status

The channel 0 status screens display the information stored in the diagnostic file you specified when you configured channel 0.

### Using the System Mode Status Display

This section explains the status data displayed on system mode screens in your programming software:

#### System Mode (DF1 Point-to-Point) Status Screen

Channel Status

Channel 0 | Channel 1A | Channel 1B | Channel 2A | Channel 2B | Channel 3A

System (Point to Point)

DCD Recover =       Lost Modem =

Messages Sent =       Undelivered Messages =

Messages Received =       Duplicate Messages Received =

ENQs Received =       ENQs Sent =

Received NAK =       Bad Packet/Sent NAK =

Lack of Memory/Sent NAK =

Modem Lines:    DTR    DSR    RTS    CTS    DCD

#### System Mode (DF1 Slave) Status Screen

Channel Status

Channel 0 | Channel 1A | Channel 1B | Channel 2A | Channel 2B | Channel 3A

System (Slave)

DCD Recover =       Lost Modem =

Messages Sent =       Messages Retried =

Messages Received =       Undelivered Messages =

Polls Received =       Duplicate Messages Received =

Received NAK =       Bad Packet/No ACK Sent =

Lack of memory/No ACK Sent =

Modem Lines:    DTR    DSR    RTS    CTS    DCD

### System Mode (DF1 Master) Status Screen

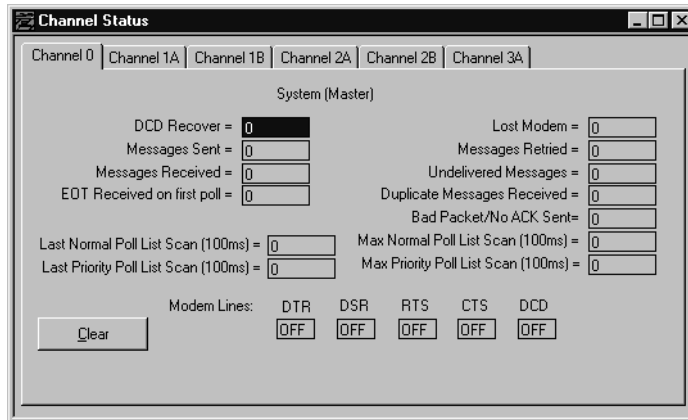

### Descriptions of System Mode Status Screen Fields

Status Field	Word Bit	Description
DCD recover	11	Displays the number of times the controller detects the DCD-handshaking line has gone low to high.
Messages sent	1	Displays the total number of DF1 messages sent by the controller (included message retry).
Messages received	2	Displays the number of messages the controller received with no error.
EOT received on first poll	8	Displays the number of times the master received an EOT in response to the first poll of a station.
Lost modem	12	Displays the number of times a modem was disconnected.
Messages retried	4	For slave and master mode, displays the number of messages resent.
Undelivered messages	3	Displays number of messages that were sent by controller but not received by the destination device.
Duplicate messages received	9	Displays the number of times the controller received a message packet identical to the previous message packet.
Bad packet/no ACK sent	7	Displays the number of incorrect data packets that the controller has received.
Last poll list scan last	5	The time it took to complete the previous scan of the normal station poll list.
Last priority poll list scan last	10	The time it took to complete the previous scan of the priority station poll list.
Max normal poll list scan	6	The maximum time taken to complete a scan of the normal station poll list.
Max priority poll list scan	13	The maximum time taken to complete a scan of the priority station poll list.
ENQs received	6	For point-to-point mode, displays the number of inquiries made by the destination device.
ENQs sent	4	For point-to-point mode, displays the number of inquiries made by the controller.
Received NAK	5	For Point-to-point and slave mode, displays the number of NAK messages received by the controller.
Lack of memory/sent NAK Lack of memory/no ACK sent	8	For point-to-point and slave mode, displays the number of times the controller could not receive a message because it did not have enough memory.
Polling received	6	For slave mode, displays number of times a DF1 master device has polled controller for a message.

Status Field	Word Bit	Description
<b>Modem Lines</b>		
DTR	0: 4	Displays the status of the DTR handshaking line (asserted by the controller)
DSR	0: 2	Displays the status of the DSR handshaking line (received by the controller)
RTS	0: 1	Displays the status of the RTS handshaking line (asserted by the controller)
CTS	0: 0	Displays the status of the CTS handshaking line (received by the controller)
DCD	0: 3	Displays the status of the DCD handshaking line (received by the controller)

### Using the User Mode (ASCII) Status Display

This section describes the user-mode status data displayed on the user mode (ASCII) status screen in your programming software.

#### User Mode Status Screen

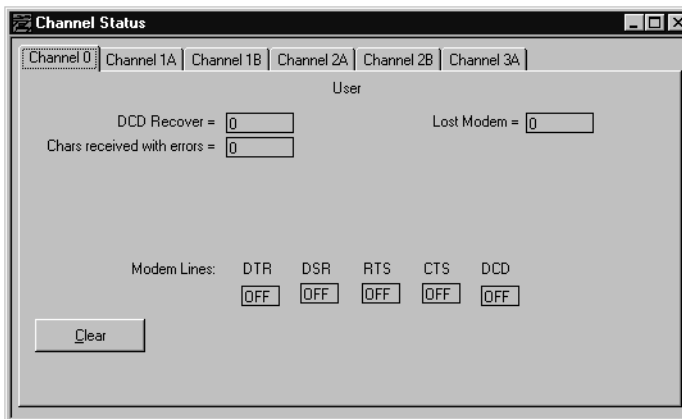

#### Descriptions of User Mode Status Screen Fields

Status Field	Word Bit	Description
DCD recover	11	Displays the number of times the controller detects the DCD-handshaking line has gone low to high.
Character received with error	10	Displays the number of characters the controller received with parity or with errors and discarded
Lost modem	12	Displays the number of times a modem was disconnected.
<b>Modem Lines</b>		
DTR	0: 4	Displays the status of the DTR handshaking line (asserted by the controller)
DSR	0: 2	Displays the status of the DSR handshaking line (received by the controller)
RTS	0: 1	Displays the status of the RTS handshaking line (asserted by the controller)
CTS	0: 0	Displays the status of the CTS handshaking line (received by the controller)
DCD	0: 3	Displays the status of the DCD handshaking line (received by the controller)

# Communicating with Devices on an Ethernet Network

## Using This Chapter

<b>For Information About</b>	<b>Go to Page</b>
Media and cabling	11-1
Assigning your IP address	11-2
Network addressing	11-2
Configuring channel 2 for Ethernet communication	11-2
Using advanced Ethernet functions	11-9
Using domain name service	11-15
Using the embedded web server	11-16
Using multihop messaging	11-29
Communicating with ControlLogix devices	11-32
Interpreting error codes	11-33
Interpreting Ethernet status data	11-34
Ethernet PLC-5 performance considerations	11-37

## Media and Cabling

Ethernet is a local area network that provides communication between various devices at 10 Mbps. The physical communication media you use can be any standard 802.3 media, including:

- thick-wire coaxial cable (10Base5)
- thin-wire coaxial cable (10Base2)
- twisted pair (10Base-T)
- fiber optic
- broadband

The Ethernet port (channel 2) connects to either a thin-wire, thick-wire, or twisted-pair network via a 15-pin transceiver or Medium Access Unit (MAU) connection. See Appendix G for detailed information about Ethernet cable connections.

## Assigning Your IP Address

Contact your network administrator or the Network Information Center for a unique IP address to assign to your PLC-5/20E, -5/40E, or 5/80E controller.

## Network Addressing

Because the Ethernet PLC-5 controller uses the TCP/IP protocol, each controller on the network requires a unique IP address. The IP address is software-configurable using either the BOOTP protocol or your programming software.

If you are using the BOOTP protocol, you must also obtain the hardware Ethernet address. Rockwell Automation assigns each Ethernet PLC-5 controller a hardware Ethernet address at the factory. Look for the address either:

- in the back, upper corner of your module; or
- in the channel 2 configuration screen of your programming software

## Configuring Channel 2 for Ethernet Communication

After you assign a unique IP address to your Ethernet PLC-5 controller, you must configure channel 2 so your network recognizes the controller. Configure this channel using one of two methods:

- manually entering module configuration information using the screens within your programming software package
- entering module configuration information using a BOOTP utility (use a BOOTP server on your network to edit the BOOTPTAB file)

## Manually Configuring Channel 2

The default for the Ethernet PLC-5 controller is BOOTP enabled. You must first disable BOOTP before you can use the programming software to enter module configuration information.



You can manually configure channel 2 for Ethernet communication using your programming software over a DH+ or serial link

The screenshot shows the 'Edit Channel Properties' dialog box for Channel 2. The 'Ethernet Configuration' section includes the following fields and values:

- Ethernet Address: 00:00:00:00:00:00
- BOOTP Enabled
- IP Address: 0 . 0 . 0 . 0
- Message Connect Timeout (msec): 15000
- Message Reply Timeout (msec): 3000
- Inactivity Timeout (minutes): 30

The 'Advanced Functions' section includes the following fields and values:

- Broadcast Address: 0 . 0 . 0 . 0
- Subnet Mask: 0 . 0 . 0 . 0
- Gateway Address: 0 . 0 . 0 . 0

Buttons at the bottom: OK, Cancel, Apply, Help.

Enter the IP address and toggle the BOOTP enable field to No. Enter further configuration information in the appropriate fields. See the following table on the next page.

**IMPORTANT**

BOOTP enabled is the factory default. You cannot manually change the IP address with your programming software if BOOTP is enabled

### Ethernet Channel 2 Configuration Fields

This Field	Specifies	Configure by Doing the Following
Diagnostic file	The file containing the channel's status information.	<p>Enter an integer file number (10-999). The system creates an integer file 44 words long.</p> <p><b>ATTENTION:</b> Assign a unique diagnostic file to each channel. Do not assign a diagnostic file that is the I/O status file you assigned or any other used file. Unpredictable machine action can result.</p> <p><b>Important:</b> You must define a diagnostics file for a channel configured for anything but unused (even if you are not using the channel) if you want status information for that channel.</p>
Ethernet Address	<p>The controller's Ethernet hardware address.</p> <p>Display only</p>	Assigned by Rockwell Automation and cannot be changed. Displayed as a set of 6 bytes (in hex), separated by colons.
BOOTP Enable	Whether BOOTP is enabled.	<p>Select NO.</p> <p><b>Before</b> you specify NO, make sure you have an IP address specified. With BOOTP set to NO, the controller uses the parameters that you specify locally.</p> <p>To enable BOOTP, see page 11-5.</p>
IP Address	The controller's Internet address.	<p>Disable BOOTP first. <b>You cannot manually change the IP address with programming software if BOOTP is enabled.</b></p> <p>Enter an address in this form:</p> <p>a.b.c.dWhere: a, b, c, d are between 1-254 (decimal)</p> <p>You must specify the IP address to have the controller connect to the TCP/IP network. Do not use 0 or 255 as a, b, c, or d in the IP address.</p>
Message Connect Timeout	The number of milliseconds allowed for an MSG instruction to establish a connection with the destination node.	<p>Enter a timeout period in milliseconds. (The controller rounds to the nearest 250 ms.) The valid range for a timeout period is 0-65,535 ms.</p> <p>The default is 15,000 ms.</p>
Message Reply Timeout	The number of milliseconds the Ethernet interface waits for a reply to a command it initiated (through an MSG instruction).	<p>Enter a timeout period in milliseconds. (The controller rounds to the nearest 250 ms.) The valid range for a timeout period is 0-65,535 ms.</p> <p>The default is 3,000 ms.</p>
Inactivity Timeout	The number of minutes of inactivity before the connection is closed.	<p>Enter a timeout period in minutes. The valid range for a timeout period is 0-65,535 minutes.</p> <p>The default is 30 minutes.</p>

This Field	Specifies	Configure by Doing the Following
<b>Advanced Functions</b>		
Broadcast Address	The broadcast address to which the controller should respond.	See page 11-9 for information about advanced network functions, including the use of broadcast addressing.  This function does not allow for sending one message simultaneously to multiple PLC-5E controllers.
Subnet Mask	The controller's subnet mask.  The subnet mask is used to interpret IP addresses when the network is divided into subnets.	See page 11-11 for information about subnetworks and gateways.
Gateway Address	The IP address of the gateway that provides a connection to another IP network.  This field is required when you communicate with other devices not on a local subnet.	See page 11-11 for information about subnetworks and gateways.
Link ID	A DH+ link number  Use the link ID number to identify the network when configuring a ControlLogix system using the Gateway software.	Enter a link ID number. The valid range is 0-199.

## Using BOOTP to Enter Configuration Information

You can also use BOOTP to obtain subnet masks and gateway addresses. See page 11-12.

**BOOTP is a protocol that will supply the controller with configuration information at power-up. BOOTP lets you dynamically assign IP addresses to controllers on the Ethernet link.**

**To use BOOTP, a BOOTP server must exist on the local Ethernet subnet. The server is a computer (either a personal computer, VAX, or UNIX system) that has BOOTP-server software installed and reads a text file containing network information for individual nodes on the network.**

To enable BOOTP, use the Ethernet channel 2 configuration screen in your programming software. Specify YES for BOOTP Enable.

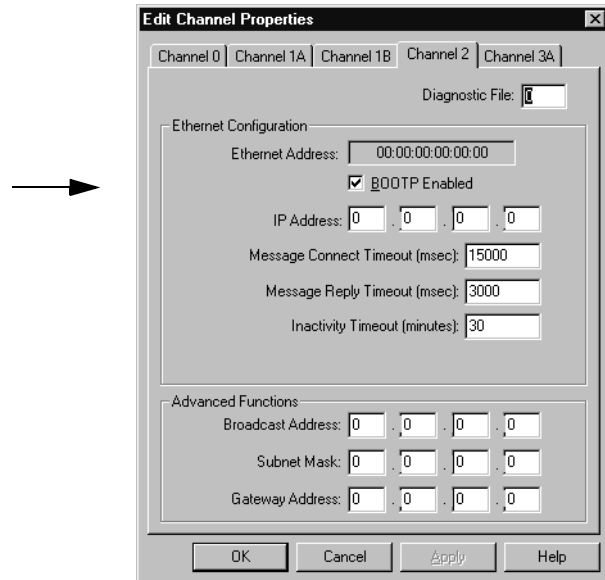

### IMPORTANT

If you change this field from NO to YES, the change does not take effect until you cycle power.

Specify further configuration information using this screen.

When BOOTP is enabled, the following events occur at power-up:

- The controller broadcasts a BOOTP-request message containing its hardware address over the local network or subnet.
- The BOOTP server compares the hardware address with the addresses in its look-up table in the BOOTPTAB file.
- The BOOTP server sends a message back to the controller with the IP address and other network information that corresponds to the hardware address it received.

With all hardware and IP addresses in one location, you can easily change IP addresses in the BOOTP configuration file if your network needs change.

If you have BOOTP enabled and the message `BOOTP response not received` appears, check the cabling connections and the BOOTP server system.

**IMPORTANT**

If BOOTP is disabled, or no BOOTP server exists on the network, you must use PLC-5 programming software to enter/change the IP address for each controller.

## Editing the BOOTPTAB Configuration File

**IMPORTANT**

Be sure you know the Ethernet hardware address of the module. You will enter it in this file.

You must edit the `BOOTPTAB` file, which is an ASCII text file, to include the name, IP address, and hardware address for each Ethernet PLC-5 controller you want the server to boot. To edit this file:

1. Open the `BOOTPTAB` file using a text editor.

- The file contains lines that look like this:

```
#Default string for each type of Ethernet client
defaults5E: ht=1:vm=rfc1048
```

These are the default parameters for Ethernet PLC-5 controllers and must always precede the client lines in the `BOOTPTAB` file.

- The file also contains a line that looks like this:

```
plc5name: tc=defaults5E:ip=aa.bb.cc.dd:ha=0000BC1Cxyy
```

**IMPORTANT**

Use this line as the configuration template for Ethernet PLC-5 controllers.

1. Make one copy of the Ethernet PLC-5 controller template for every Ethernet PLC-5 controller in your system.
2. Edit each copy of the template as follows:
  - A. Replace `plc5name` with the name of the Ethernet PLC-5 controller. Use only letters and numbers; do not use underscores.
  - B. Replace `aa.bb.cc.dd` with the IP address to be assigned to the controller.

C. Replace *xyyy* with the last four digits of the hardware address. Use only valid hexadecimal digits (0-9, A-F); do not use the hyphens that separate the numbers. (You will find the hardware address on a label affixed to the printed circuit board of the Ethernet PLC-5 controller.)

3. Save, close, and make a backup copy of this file.

**EXAMPLE**

In this example there are three Ethernet PLC-5 controllers and an HP 9000 personal computer. The names and hardware addresses are device specific:

DeviceName	IP Address	Hardware Address
Ethernet PLC-5sigma1	12.34.56.100	00:BC:1C:12:34
Ethernet PLC-5sigma2	12.34.56.200	00:BC:1C:56:78
Ethernet PLC-5sigma3	12.34.56.300	00:BC:1C:90:12

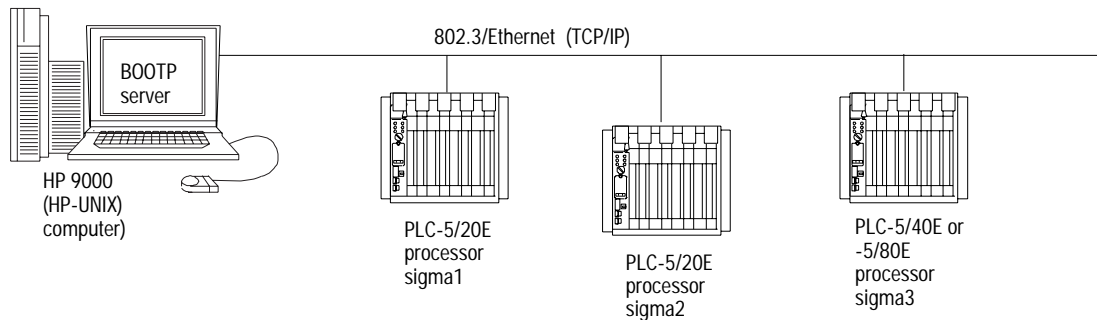

Based on this configuration, the BOOTPTAB file looks like:

```
# Legend: gw -- gateways
#          ha -- hardware address
#          ht -- hardware type(1)
#          ip -- host IP address
#          sm -- subnet mask
#          vm -- BOOTP vendor extensions format(2)
#          tc -- template host

#Default string for each type of Ethernet client
defaults5E: ht=1:vm=rfc1048

#Entries for Ethernet PLC-5 controllers:
device1: tc=defaults5E:ip=12.34.56.1:ha=0000BC1C1234
device2: tc=defaults5E:ip=12.34.56.2:ha=0000BC1C5678
device4: tc=defaults5E:ip=12.34.56.3:ha=0000BC1C9012
```

<sup>(1)</sup> 1 = 10MB Ethernet  
<sup>(2)</sup> use rfc1048

Run your BOOTP utility to send the configuration information to the Ethernet interface module.

## Using Advanced Ethernet Functions

Configure the following advanced communication characteristics using the Ethernet channel 2 configuration screen:

- broadcast address
- subnet mask
- gateway address

If You are Using	See Page
Broadcast addressing	11-9
Subnet masks and gateways	11-11

### IMPORTANT

If BOOTP is enabled, you can't change any of the advanced Ethernet communications characteristics.

## Using Broadcast Addressing

The broadcast address is part of the IP protocol used by a host to send messages to every IP address on the link. This field in the channel 2 configuration screen identifies the address on which the module will receive broadcast messages sent by a host.

### IMPORTANT

The broadcast address is used only for the reception of messages. When used in the context of Ethernet addressing, the broadcast function does **not** refer to ladder-logic messaging.

This function does not allow for sending one message to multiple PLC-5E controllers at the same time.

In most cases, you can leave the broadcast address at the default setting.

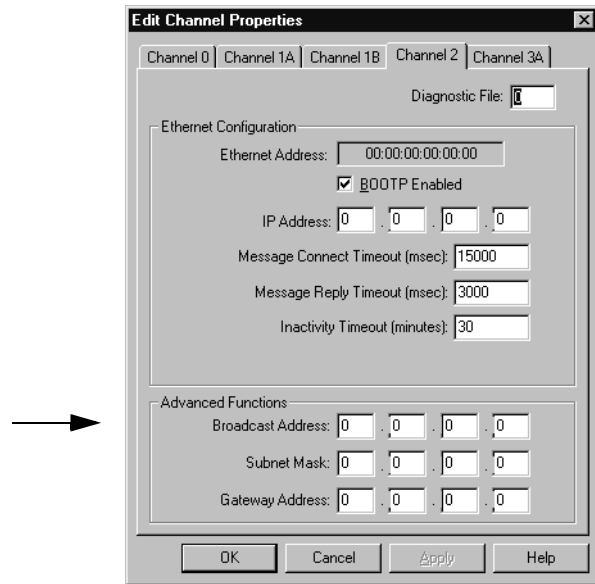

---

<b>Configure this Field</b>	<b>By Doing the Following</b>
-----------------------------	-------------------------------

---

Broadcast Address	Cursor to the field, and enter an address of the following form:  a.b.c.dWhere: a, b, c, d are between 0-255 (decimal)  If you change the default and need to reset it, type 0.0.0.0.
-------------------	---

---



## Using Subnet Masks and Gateways

If your network is divided into subnetworks that use gateways or routers, you must indicate the following information when configuring channel 2:

- subnet mask
- gateway address

A subnet mask is a filter that a node applies to IP addresses to determine if an address is on the local subnet or on another subnet. If an address is located on another subnetwork, messages are routed through a local gateway to be transferred to the destination subnetwork.

If your network is not divided into subnets, then leave the subnet mask field at the default.

If You are	Then	See Page
manually configuring channel 2 and have a network with subnets	be sure the BOOTP enable field is set to <code>NO</code> . use your programming software to enter the subnet mask and gateway address; see .	11-12
using BOOTP to configure channel 2 and have a network with subnets	be sure BOOTP is enabled configure the BOOTPTAB file to include the subnet mask(s) and gateway address(es)	11-13

## Manually Configuring Channel 2 for Controllers on Subnets

If you are manually configuring channel 2 for a controller located on a subnet, see refer to the table below to configure the subnet mask and gateway address fields for each controller via your programming software.

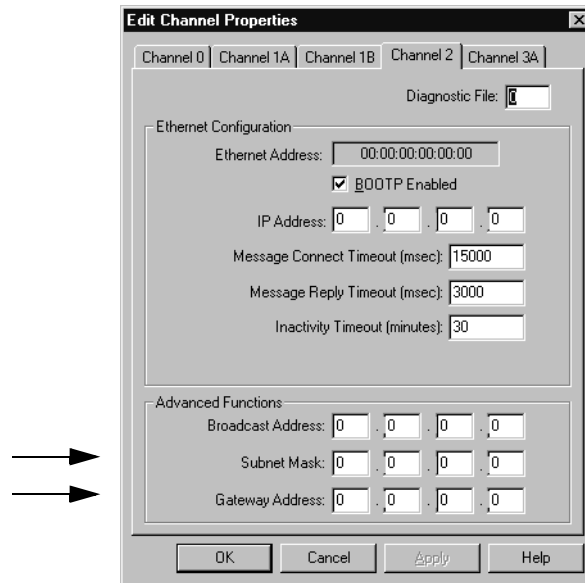

### Ethernet Channel 2 Configuration Screen Advanced Functions

This Field	Specifies	Configure by Doing the Following
Subnet Mask	<p>The controller's subnet mask.</p> <p>The subnet mask is used to interpret IP addresses when the internet is divided into subnets.</p>	<p>Enter an address of the following form:</p> <p>a.b.c.dWhere: a, b, c, d are between 0-255 (decimal)</p> <p>If your network is not divided into subnets, then leave the subnet mask field at the default. If you change the default and need to reset it, type 0.0.0.0.</p>
Gateway Address	<p>The IP address of the gateway that provides a connection to another IP network.</p> <p>This field is required when you communicate with other devices not on a local subnet.</p>	<p>Enter an address of the following form:</p> <p>a.b.c.dWhere: a, b, c, d are between 0-255 (decimal)</p> <p>The default address is No Gateway.</p>

## Using BOOTP to Configure Channel 2 for Controllers on Subnets

Configure the BOOTPTAB file according to the subnet mask and gateway address for each PLC-5E controller on the link. See the example below and the corresponding BOOTPTAB file on the next page.

**IMPORTANT** Because BOOTP requests are seen only on the local subnet, each subnet needs its own BOOTP server and BOOTPTAB file.

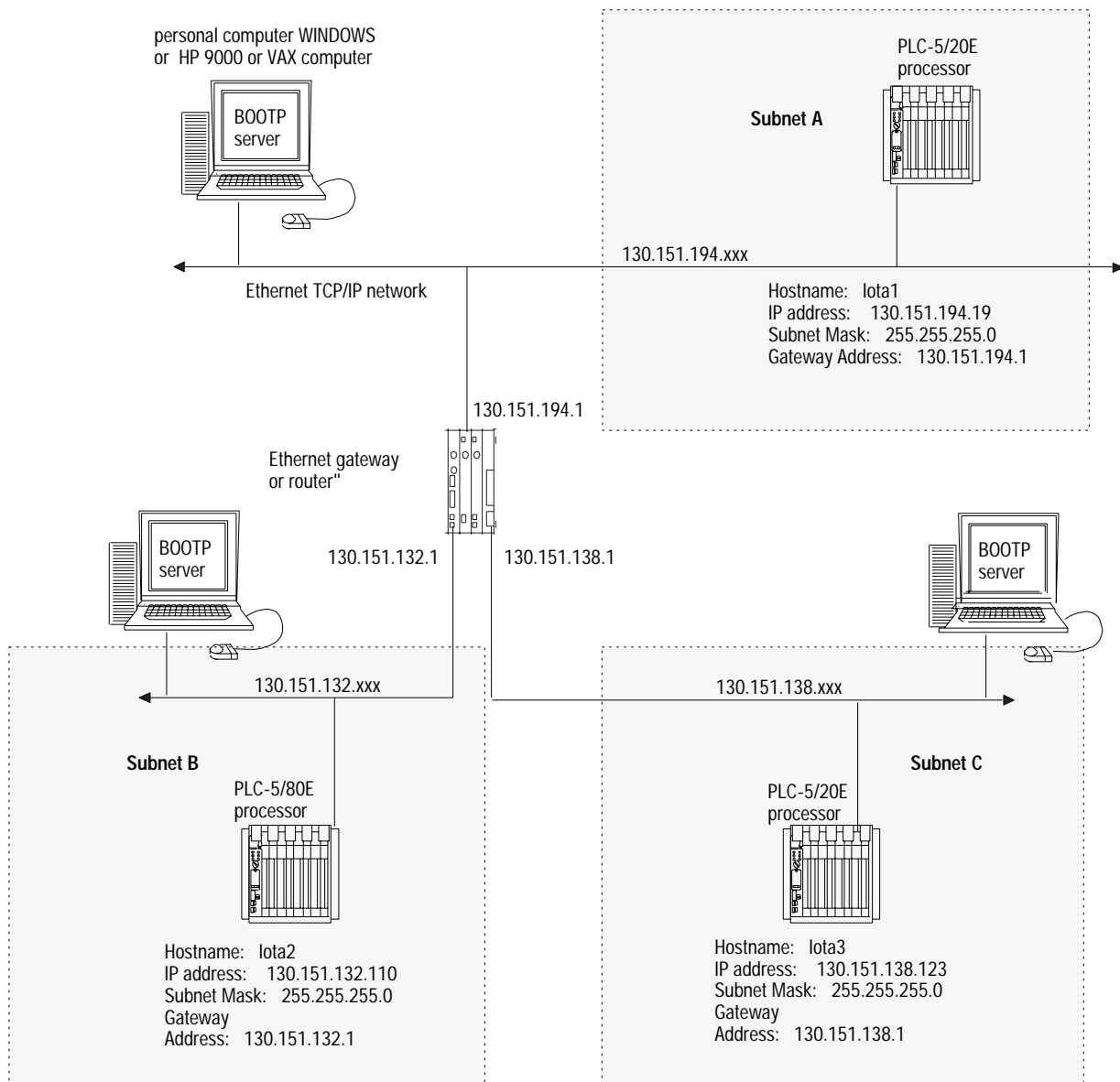

### The BOOTPTAB files that correspond to this example looks like:

---

```
# Legend:  gw -- gateways
#          ha -- hardware address
#          ht -- hardware type
#          ip -- host IP address
#          sm -- subnet mask
#          vm -- BOOTP vendor extensions format
#          tc -- template host

#Default string for each type of Ethernet client
defaults5E: ht=1:vm=rfc1048:sm=255.255.255.0

#Entries for Ethernet PLC-5 controllers:
iota1:\
        tc=defaults5E:\
        gw=130.151.194.1:\
        ha=0000BC1C1234:/
        ip=130.151.194.19
```

---

```
# Legend:  gw -- gateways
#          ha -- hardware address
#          ht -- hardware type
#          ip -- host IP address
#          sm -- subnet mask
#          vm -- BOOTP vendor extensions format
#          tc -- template host

#Default string for each type of Ethernet client
defaults5E: ht=1:vm=rfc1048:sm=255.255.255.0

#Entries for Ethernet PLC-5 controllers:
iota2:\
        tc=defaults5E:\
        gw=130.151.132.1:\
        ha=0000BC1C5678:/
        ip=130.151.132.110
```

---

```
# Legend:  gw -- gateways
#          ha -- hardware address
#          ht -- hardware type
#          ip -- host IP address
#          sm -- subnet mask
#          vm -- BOOTP vendor extensions format
#          tc -- template host

#Default string for each type of Ethernet client
defaults5E: ht=1:vm=rfc1048:sm=255.255.255.0

#Entries for Ethernet PLC-5 controllers:
iota3:\
        tc=defaults5E:\
        gw=130.151.138.1:\
        ha=0000BC1C9012:/
        ip=130.151.138.123
```

---

## Using Domain Name Service

DNS allows an Internet Protocol (IP) address in symbolic form to be converted into the equivalent numeric IP address. For the PLC-5 controller, this conversion is a service provided by a remote host on the network.

With this release of Ethernet PLC-5 controllers and release 5.20 or greater of RSLogix programming software, you may enter the symbolic form of the IP address as the IP address in the Message Block.

The Channel Configuration feature in RSLogix5 programming software allows you to configure a primary and secondary DNS server, as well as a Default Domain Name (for example, cle.ab.com).

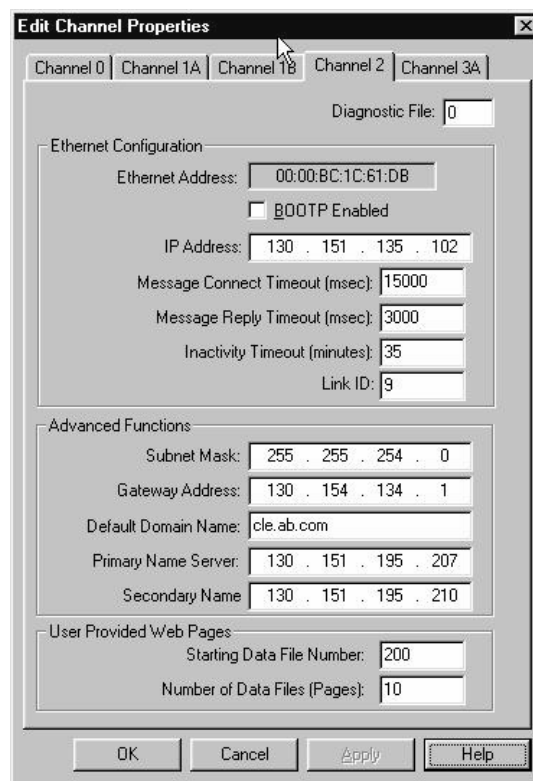

DNS names consist of a label name and a domain name. When programming the message instruction, you can enter the full label and domain name (for example, Motor1.cle.ab.com) or just the label name (Motor1). The default domain name (cle.ab.com) is appended to the label name.

Label names must start with a letter and can only consist of letters, digits and hyphens.

When a message instruction with a label name is first used, the PLC-5 controller verifies that label name with the name servers. When the IP address is returned, the connection is made. After the connection is made, subsequent message instruction will not require label name verification.

## Using the Embedded Web Server

To use the embedded web server:

1. Go online at your controller IP address (for example, www.cle.ab.com).

The 1785-ENET Ethernet Programmable Controllers main page appears:

2. Click on the first item, Module Information.

The Module Information page appears and displays specific controller information:

Processor	PLC-5/40E
Series/Revision	C/Q
RAM Status	Good
Processor Mode	Remote Program
Major Faults	00000000 00000000
Minor Faults 1	00000000 00011010
Minor Faults 2	00000000 10000000
Program Name	WWWDEMO
Firmware Identification	1785_np540e 2.36 01-Oct-01
Module Uptime	5 days, 05h:52m:26s

3. At the bottom of the Module Information page, click on TCP/IP Configuration.

The TCP/IP Configuration page appears and displays TCP/IP parameters:

**PLC-5 Ethernet Module**

*TCP/IP Configuration*

---

IP Address	130.151.135.83
Subnet Mask	255.255.254.0
Gateway Address	130.151.134.1
Name Server	130.151.135.207
Secondary Name Server	130.151.135.210
Default Domain Name	cle.ab.com
BOOTP Enable	No
Ethernet Address	00:00:BC:1C:14:92

---

[Module Home Page](#) | [Module Information](#) | [TCP/IP Configuration](#) | [Diagnostic Information](#) | [Memory Map](#) | [D/T Monitor](#) | [User Provided Pages](#)

4. At the bottom of the TCP/IP configuration page, click on Diagnostic Information.

The Diagnostic Information page appears and displays two lists of statistics pages:

**PLC-5 Ethernet Module**

*Diagnostic Information*

---

*Network Stack Statistics*

- [General Ethernet Counters](#)
- [Ethernet Interface Statistics \(SONIC\)](#)
- [ICMP Statistics](#)
- [IP Statistics](#)
- [UDP Statistics](#)
- [TCP Statistics](#)
- [TCP Extended Statistics](#)
- [Network Memory Statistics](#)
- [Mbuf Statistics](#)

*Application Level Statistics*

- [Application Memory Statistics](#)
- [CSP Session Tables](#)
- [Encapsulation Protocol Session Table](#)
- [Encapsulation Protocol Statistics](#)
- [CIP Connection Statistics](#)
- [CIP Counters](#)

---

[Module Home Page](#) | [Module Information](#) | [TCP/IP Configuration](#) | [Diagnostic Information](#) | [Memory Map](#) | [D/T Monitor](#) | [User Provided Pages](#)

The first list contains Network Stack Statistics. These pages present information about the TCP/IP stack.

5. For example, under Network Stack Statistics, click on the first entry General Ethernet Counters.

This page displays general messaging statistics:

**PLC-5 Ethernet Module**  
*General Ethernet Counters*

Commands Sent	0	Replies Sent	543383
Commands Received	543393	Replies Received	0
		Replies Sent With Error	10
		Replies Received With Error	0
		Replies Timed Out	0
In Octets	1885349104	Out Octets	9686629
In Packets	4175330	Out Packets	81251
Alignment Errors	0	FCS Errors	0
Carrier Sense Errors	0	Excessive Collisions	0
Excessive Deferrals	0	MAC Receive Errors	2
MAC Transmit Errors	0	Single Collisions	37
Multiple Collisions	33	Deferred Transmissions	46
Late Collisions	0	Packet Storms	60

Clear Counters   Refresh counters every  seconds.   Change   Default   Disable

Use the information on this page when troubleshooting the network.



Details of each counter on the **General Ethernet Counters** page are described in the following table.

This Counter	Totals
Commands Sent	number of PCCC (programmable controller communication commands) sent by the module
Replies Sent	number of PCCC replies sent by the module
Command Received	number of PCCC commands received by the module
Replies Received	number of PCCC replies received by the module
Replies Sent with Error	number of PCCC replies with error status sent by the module
Replies Received with Error	number of PCCC replies with error status received by the module
Replies Timed Out	number of PCCC replies that were not received within the time period specified on the Ethernet Configuration page
In Octets	number of octets received by the module
Out Octets	number of octets sent by the module
In Packets	number of packets received by the module, including broadcast packets
Out Packets	number of packets sent by the module, including broadcast packets
Alignment Errors	count of frames received that are not an integral number of octets in length
FCS Errors	count of frames that do not pass the FCS check
Carrier Sense Errors	number of times that the carrier sense condition was lost or never asserted when attempting to transmit a frame
Excessive Collisions	count of frames when transmission fails caused by excessive collisions
Excessive Deferrals	count of frames when transmission is deferred for an excessive period of time
MAC Receive Errors	count of frames when transmission fails because of an internal MAC sublayer receive error
MAC Transmit Errors	count of frames when transmission fails because of internal MAC sublayer transmit error
Single Collisions	count of successfully transmitted frames when transmission is inhibited by one collision
Multiple Collisions	count of successfully transmitted frames when transmission is inhibited by more than one collision
Deferred Transmissions	count of frames when the first transmission attempt is delayed because the medium is busy
Late Collisions	number of times that a collision is detected later than 512 bit-times into the transmission of a packet
Packet Storms	number of times the SONIC driver has entered storm or throttle back operation due to excessive traffic

**6.** At the bottom of the **General Ethernet Counters** page, click on **Diagnostic Information** to return to that page.

The second list contains Application Level Statistics. These pages present information about the Client Server Protocol (CSP) and the Control Information Protocol (CIP), such as:

- memory usage
- inbound/outbound connection information
- packet processing

Details of the first three of these pages are described in the following table:

This Page	Indicates
Application Memory Statistics	information on the number of connections available and the number currently in use for inbound/outbound connections
CSP Session Table	inbound/outbound information for the CSP connection
Encapsulation Protocol Session Table	inbound/outbound connection information for the CIP connections

The remainder of the Application Level Statistics pages present detailed information on CIP protocol counters. This information may be used in the event you must call Rockwell Automation Technical Support for troubleshooting.

7. On the bottom of your current page, click on *Memory Map*.

The Data Table Memory Map page appears and displays a table that lists the data table files and their type and size in elements of the connected PLC-5 as shown in the following example:

**PLC-5 Ethernet Module**

*Data Table Memory Map*

File	# Elements	File Type
O0	128	Output
I1	128	Input
S2	128	Status
B3	2	Binary
T4	2	Timer
C5	2	Counter
R6	2	Control
N7	340	Integer
F8	4	Floating Point
ST9	17	String
A10	958	ASCII
MG20	2	Message
BT21	2	Block Transfer
A22	20	ASCII
ST23	4	String
N24	33	Integer

[Module Home Page](#) | [Module Information](#) | [TCP/IP Configuration](#) | [Diagnostic Information](#) | [Memory Map](#) | [D/T Monitor](#) | [User Provided Pages](#)

Each file contains a hyperlink that takes you to the specific Data Table Monitor page for that file.

8. On the bottom of the Data Table Memory Map page, click on `DT Monitor`.

The Data Table Monitor page appears and displays a table that shows the contents of the selected PLC-5 data table file:

**PLC-5 Ethernet Module**

*Data Table Monitor*

Address	0	1	2	3	4	5	6	7	8	9
N7:100	0	0	0	0	0	0	0	0	0	0
N7:110	0	0	0	0	0	0	0	0	0	0
N7:120	0	0	0	0	0	0	0	0	0	0
N7:130	0	0	0	0	0	0	0	0	0	0
N7:140	0	0	0	0	0	0	0	0	0	0
N7:150	0	0	0	0	0	0	0	0	0	0
N7:160	0	0	0	0	0	0	0	0	0	0
N7:170	0	0	0	0	0	0	0	0	0	0
N7:180	0	0	0	0	0	0	0	0	0	0
N7:190	0	0	0	0	0	0	0	0	0	0

Data Table Address	<input type="text" value="N7:100"/>	Display format	<input type="text" value="Decimal"/>	<input type="button" value="Prev"/>
Refresh data every	<input type="text" value="15"/> seconds.	<input type="button" value="Default"/>	<input type="button" value="Disable"/>	<input type="button" value="Next"/>
<input type="button" value="Change Parameters"/>				

The available and default display formats depend on the data type of the file.

Press the `Prev` or `Next` buttons to display the previous or next page of the data table file.

You can change the `Data Table Address`, `Display Format` and `Refresh data every` fields by entering the data in the text boxes and clicking the `Change Parameters` button.

To change the refresh data function back to the default of 15 seconds, click the `Default` field. To disable the refresh data function, click the `Disable` button.

## Generating User Provided Web Pages

You can use a text editor to generate up to 16 user provided web pages. The pages are stored in consecutive ASCII files of the PLC-5 controller. The channel configuration feature of RSLogix5 (release 5.20 or later) allows you to select the starting file and number of files used, as shown in the following example:

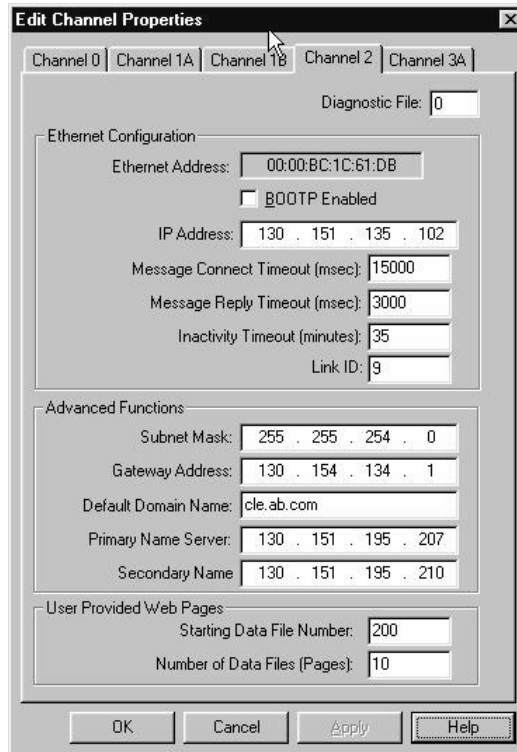

The software also allows you to import your user file from your PC to a specified ASCII file in the PLC-5 controller.

### *HTML Pages*

**Referencing Other Pages/Servers** - following are some basic considerations when referencing other pages or servers:

- reference User Specified Pages in the PLC-5 by using the names **user1.html** through **user 16.html**
- to reference a page on the same controller, specify a URL such as **/user2.html**
- to reference a page on another controller, specify a URL such as **http://iota4/user2/html**

- you can reference other WWW servers and display images from other sources without affecting your usage of data table memory (except for the size of the HTTP reference)

**Referencing Data Table Memory** - reference data table memory locations by placing custom tags into your HTML source which specify the data table location and optional formatting information. Use the following format for the custom tag:

```
<!ABDTR-file_type{file_number}:{file_element}[, #elements]
[%format]>
```

The items surrounded by {} are sometimes optional. The items surrounded by [] are always optional.

You must always specify the basic file reference. Depending on which file is being referenced, **file\_number** or **file\_element** may be defaulted. If the **file\_type** is I, O or S, the **file\_number** does not need to be specified, but the **file\_element** must be specified. If the **file\_type** is not one of the three special files, the **file\_number** must be specified and the **file\_element** may default to zero (the input, output and status files have fixed numbers).

Other considerations:

**#elements** - if not specified, this defaults to one. If less than one, also defaults to one. Each element gets output using the same format (whether specified with %format or defaulted).

**%format** - legal values are %d for decimal and %x for hexadecimal. The following file types allow the format to be specified:

- |          |           |           |       |
|----------|-----------|-----------|-------|
| • Input  | • Integer | • MSG     | • BCD |
| • Output | • Timer   | • BT      | • PID |
| • Status | • Counter | • Control | • SFC |

**Display format defaults** - Input and Output file elements are output in octal format. Status and BCD file elements are output in hexadecimal format with a leading 0x. Integer file elements are output in decimal format. Complex data types (Timer, Counter, MSG, BT, Control, PID, SCF) are output as a table with bits and important words specified.

**Fixed display formats** - float files are always output in floating point format ("C"%g format). ASCII and string files are always output as a null terminated text string. Binary files are always output as two binary bytes.

**HTML Examples** - the following examples shows an HTML code segment in **bold** with a short description of what you would see on a web browser:

The input image word is I:0 is **<b><!ABDTR-I:0></b>**  
*(this segment displays the value of the first word of the input image table in the default format of octal with bold type)*

The time values in T4:0 are**<!ABDTR-T4:0>**  
*(this segment will display the values of the timer in T4:0 in the default format of a table)*

I:0 is **<,b><!ABDTR-I:0%d></b>**  
*(this segment displays the value of the first word of the input image table in decimal with bold type)*

T4:0 is **<b><!ABDTR-T4:0%d></B>**  
*(this segment displays the values of the three words comprising timer T4:0 in decimal with bold type)*

N24:0 to n24:3 are **<b><!ABDTR-N24:0,4></b>**  
*(this segment displays the values of the four words in N24:0 through N24:3 in decimal with bold type)*

S:21-S:23 are **<b><!ABDTR-S:21, 3%d></b>**  
*(this segment displays the values of the three words in S:21 through S:23 in decimal with bold type)*

### Generating Custom Data Table Monitor Pages

You can generate Custom Data Table Monitor pages with your text editor and then download them to the PLC-5 controller. The first element of the file must contain a special tag as follows:

**<!ABCDM-xx>**

where **xx** is the automatic refresh rate in seconds (01-99).  
 A value outside the range defaults to a “snapshot” display.  
 You can modify the refresh rate three different ways:

- enter the desired refresh rate and press the Change button
- select the default button for a 15 second refresh
- disable the refresh by selecting the disable button

**Referencing Data Table Memory** - the Data Table locations in the Custom Data Table Monitor are referenced by placing custom tags into the ASCII file of the controller. The format of the custom tag is:

```
<!ABDTR-file_type{file_number}:{file_element}[,#elements][%format][#expand]!comment>
```

The items surrounded with {} are sometimes optional, whereas the items surrounded by [] are always optional.

You must always specify the basic file reference. Depending on which file is being referenced, **file\_number** or **file\_element** may be defaulted. If the **file\_type** is I, O or S, the **file\_number** does not need to be specified, but the **file\_element** must be specified. If the **file\_type** is not one of the three special files, the **file\_number** must be specified and the **file\_element** may default to zero (because the input, output and status files have fixed numbers).

Other considerations:

**#elements** - if not specified, this defaults to one. If less than one, also defaults to one. Each element gets output using the same format (whether specified with %format or defaulted). Any associated comment is displayed only for the first element.

**%format** - legal values are %b for binary, %d for decimal, %0 for octal and %x for hexadecimal. The following file types allow the format to be specified:

- Input
- Output
- Status
- Integer
- BCD

All other file types are displayed in an appropriate format. If a % format modifier is present, the format may be changed by clicking on the file type/number via a web browser.

**#expand** - legal values are #c and #e. This modifier determines whether the structure file types are displayed in their expanded or compacted formats. If a # modifier is present, the format may be changed by clicking on the [+]/[-] via a web browser. If a #modifier is not present, the default display of expanded will be used.

**!comment** - data after the exclamation point and up to the closing > will be displayed in the Comment column of the monitor.

**Fixed display formats** - float files are always output in floating point format (“C”%g format). String files are always output as a null terminated text string. Binary files are always output as four binary nibbles. ASCII files are displayed in a memory dump format.

## Importing User Page Files to the PLC-5 Controller

Use RSLogix5 to import user page files to the PLC-5 ASCII files:

1. In the Project folder (under Data Files folder), right-click on the ASCII file where you will import the user page file, and choose `Properties`.
2. Click on `Import HTML`.
3. Use the browser to locate the user page file you want to import.
4. Double-click on the file to select it and click `OK`.
5. Repeat this process for each user page file.
6. When all user page files have been imported, go online with your PLC-5 controller.



- Click on the User Provided Pages link to view the User Provided Pages menu, as shown in the following example:

**PLC-5 Ethernet Module**

*User Provided Pages*

Page	File
User Provided Page #1	<a href="#">A10</a>
User Provided Page #2	<a href="#">A11</a>
User Provided Page #3	<a href="#">A12</a>
User Provided Page #4	<a href="#">A13</a>
User Provided Page #5	<a href="#">A14</a>
User Provided Page #6	<a href="#">A15</a>

---

[Module Home Page](#) | [Module Information](#) | [TCP/IP Configuration](#) | [Diagnostic Information](#) | [Memory Map](#) | [D/T Monitor](#) | [User Provided Pages](#)

- Click on the User Provided Page # to display that specific page.
- Click on the link under the file heading to display an ASCII dump of the ASCII file.  
For example, click on the A15 to display the following screen:

**PLC-5 Ethernet Module**

*File A15 Dump*

Address	0	1	2	3	4	5	6	7	8	9	ASCII
A15:0	3C21	4142	4344	4D2D	3030	3E0A	3C21	4142	4454	522D	<IABCDM-00>.<IABDTR-
A15:10	5434	3A30	2363	2154	343A	3020	496E	6469	7669	6475	T4:0#c!T4:0 Individu
A15:20	616C	3E0A	3C21	4142	4454	522D	533A	3231	2C33	2564	al>.<IABDTR-S:2L,3#d
A15:30	2152	6561	6C20	5469	6D65	2043	6C6F	636B	2048	6F75	!Real Time Clock Hou
A15:40	7273	2F4D	696E	7574	6573	2F53	6563	6F6E	6473	3E0A	rs/Minutes/Seconds>.
A15:50	3C21	4142	4454	522D	4E32	343A	3225	6821	496E	7465	<IABDTR-N24:2#h!Inte
A15:60	6765	7220	5661	6C75	653E	0D0A	3C21	4142	4454	522D	ger Value>..<IABDTR-
A15:70	4638	3A31	2C32	2146	6C6F	6174	2056	616C	7565	733E	F8:1,2!Float Values>
A15:80	0D0A	3C21	4142	4454	522D	4D47	3230	3A30	2363	214D	..<IABDTR-MG20:0#c!M
A15:90	6573	7361	6765	2042	6C6F	636B	3E0A	3C21	4142	4454	essage Block>.<IABDT
A15:100	522D	5354	3233	3A30	2C32	2153	7472	696E	6773	206C	R-ST23:0,2!strings 1
A15:110	6F61	6361	7465	6420	696E	2053	5432	333E	0A3C	2141	ocated in ST23>.<IA
A15:120	4244	5452	2D41	3232	2144	6973	706C	6179	2044	756D	BDTR-A22!Display Dum
A15:130	7020	6F66	2074	6869	7320	4153	4349	4920	6669	6C65	p of this ASCII file
A15:140	3E0A	3C21	4142	4454	522D	4233	2142	696E	6172	7920	>.<IABDTR-B3!Binary
A15:150	5661	6C75	653E	0A0A	0000						Value>...

---

[Module Home Page](#) | [Module Information](#) | [TCP/IP Configuration](#) | [Diagnostic Information](#) | [Memory Map](#) | [D/T Monitor](#) | [User Provided Pages](#)

10. Select the User Provided Page #4 to display the following screen:

**PLC-5 Ethernet Module**  
*Custom Data Table Monitor (A15)*

Address	Data	Comment
[+]T4:0	(...)	T4:0 Individual
S2:21	6	Real Time Clock Hours/Minutes/Seconds
.2:22	35	
.2:23	40	
N24:2	13	
F8:1	-1024.204956	Float Values
F8:2	8.578958e+12	
[+]MG20:0	(...)	Message Block
ST23:0	String one	Strings located in ST23
ST23:1	String two	
[+]A22	(...)	Display Dump of this ASCII file
B3:0	0000 0000 0011 0011	Binary Value

[<< Previous](#)

Refresh data every  seconds.

[Module Home Page](#) | [Module Information](#) | [TCP/IP Configuration](#) | [Diagnostic Information](#) | [Memory Map](#) | [D/T Monitor](#) | [User Provided Pages](#)

11. Click on [+] A22 to display the following screen:

**PLC-5 Ethernet Module**  
*File A22 Dump*

Address	0	1	2	3	4	5	6	7	8	9	ASCII
A22:0	5468	6973	2069	7320	616E	2041	5343	4949	2073	7472	This is an ASCII str
A22:10	696E	672E	0000	0000	0000	0000	0000	0000	0000	0000	ing.....

[Module Home Page](#) | [Module Information](#) | [TCP/IP Configuration](#) | [Diagnostic Information](#) | [Memory Map](#) | [D/T Monitor](#) | [User Provided Pages](#)

You can change the radix display of N7:0 through N7:2:

1. Go back to the Custom Data Table Monitor page.
2. In the Address column, click on N : 70 to display the radix selection page:

Hex  
 Dec  
 Oct  
 Bin

3. Click on a radio button to select the desired radix type.

To see the Sample Extended Format page:

1. Go back to the Custom Data Table Monitor page.
2. In the Address column, click on the + before the T4:0 to display the Sample Extended Format:

**PLC-5 Ethernet Module**  
*Custom Data Table Monitor (A15)*

Address	Data	Comment
[+]T4:0	(...)	T4:0 Individual
--- DN	0	
--- TF	1	
--- EN	1	
--- PRE	100	
--- ACC	54	
--- BASE	10 ms	
S2:21	6	Real Time Clock Hours/Minutes/Seconds
..2:22	39	
..2:23	12	
N24:2	13	
F8:1	-1024.204956	Float Values
F8:2	8.578958e+12	
[+]MG20:0	(...)	Message Block
ST23:0	String one	Strings located in ST23
ST23:1	String two	
[+]A22	(...)	Display Dump of this ASCII file
B3:0	0000 0000 0011 0011	Binary Value

[<< Previous](#)

Refresh data every  seconds.

[Module Home Page](#) | [Module Information](#) | [TCP/IP Configuration](#) | [Diagnostic Information](#) | [Memory Map](#) | [D/T Monitor](#) | [User Provided Pages](#)

This completes the Embedded Web Server enhancements and descriptions. Corrected anomalies and previous controller enhancements are described on the following pages.

## Using Multihop Messaging

You can use multihop messaging over Ethernet, so that controllers can communicate over Ethernet with ControlLogix devices or through a ControlLogix Ethernet module (1756-ENET) to other PLC-5 and SLC controllers. You need a series E, revision D or later PLC-5 controller, and if using a sidecar module, you will need a series B or later 1785-ENET interface module.

To take advantage of these enhancements, you need RSLogix 5 programming software, release 3.2 or later.

Keep in mind these considerations:

- RSLogix programming software on ControlNet and DH+ links cannot see the controllers on an Ethernet link.
- The RSLinx DDE server on a ControlNet link cannot poll data from the controllers on an Ethernet link.
- The RSLinx DDE server on a ControlNet link cannot accept unsolicited data from controllers on an Ethernet link.
- Applications that register themselves as nodes on the RSLinx “Virtual Link” in workstations on ControlNet cannot accept unsolicited packets from controllers on Ethernet.
- Applications that register themselves as nodes on the RSLinx “Virtual Link” in workstations on an Ethernet link cannot accept unsolicited packets from the controllers on an Ethernet link.

### Multihop Examples

The following examples use this system configuration:

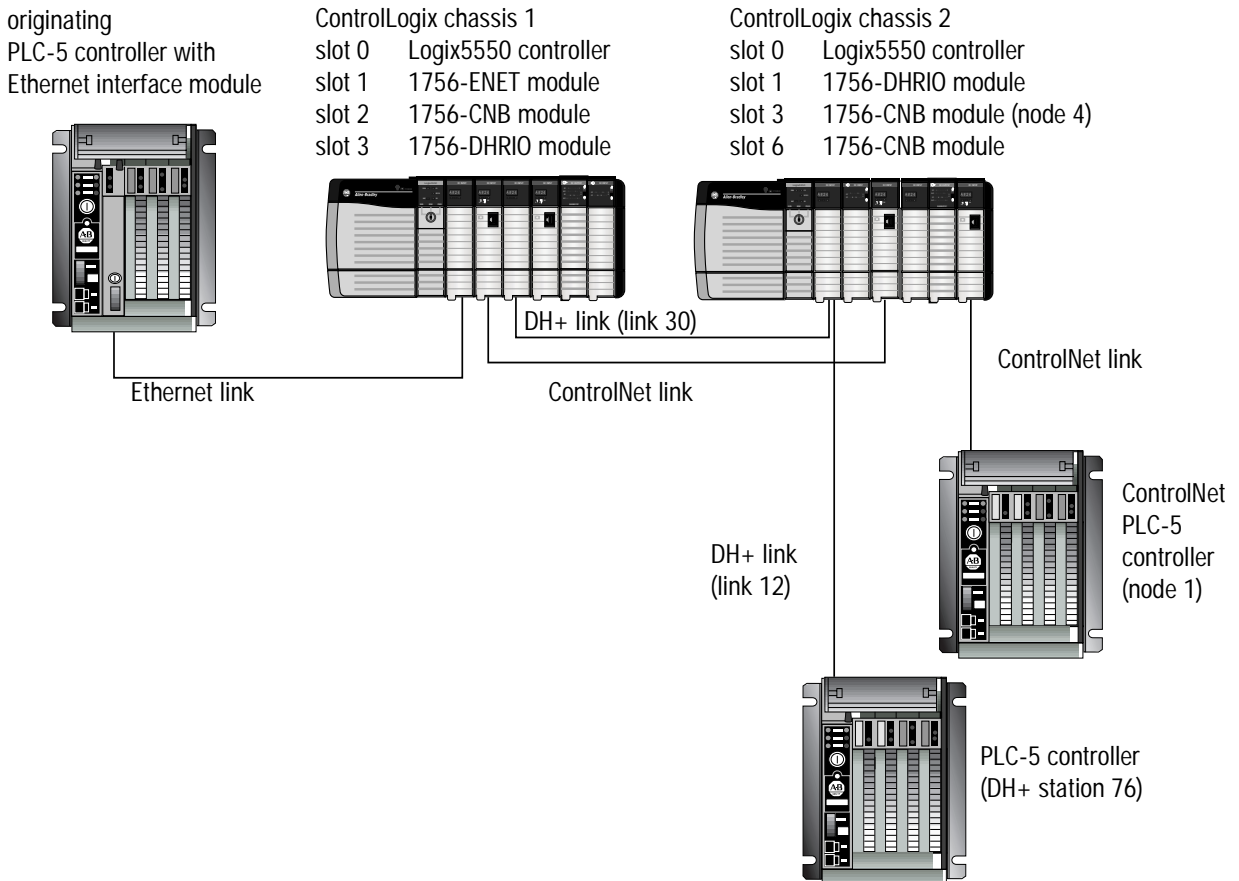

The following table shows the multihop path you enter to communicate over these scenarios.

**Scenario**

**Multihop Path**

originating PLC-5 with Ethernet interface  
to  
ControlLogix controller in chassis 1

From Device	From Port	To Address Type	To Address
This PLC5	3A	1756-ENet I.P. (str):	130.151.132.29
ControlLogix Backplane	N/A	1756 Backplane Slot(dec):	0

originating PLC-5 with Ethernet interface  
to  
PLC-5 (station 76) on DH+ link (link 12)

**Note:** Both 1756-DHRIO modules need routing tables that show a path to both link 12 and the link ID that is configured for the Ethernet port of the originating PLC-5 controller.

From Device	From Port	To Address Type	To Address
This PLC5	3A	1756-ENet I.P. (str):	130.151.132.29
ControlLogix Backplane	N/A	1756 Backplane Slot(dec):	3
1756-DHRIO	Channel A	Remote(Link ID)	12
Remote (DH/DH+)	N/A	DH/DH+ Station (oct):	76

originating PLC-5 with Ethernet interface  
to  
ControlNet PLC-5 (node 1)

From Device	From Port	To Address Type	To Address
This PLC5	3A	1756-ENet I.P. (str):	130.151.132.29
ControlLogix Backplane	N/A	1756 Backplane Slot(dec):	2
1756-CNB	N/A	ControlNet Node(dec):	4
ControlLogix Backplane	N/A	1756 Backplane Slot(dec):	6
1756-CNB	N/A	ControlNet Node(dec):	1

## Comparing Multihop and Non-Multihop Messages Over Ethernet

When an outbound connection's inactivity timer has expired and a MSG is pending on that connection, the MSG receives an error.

On a multihop connection, the error is 0x18 (Broken Connection).

On a non-multihop connection, the error is 0x16 (Connection Timeout).

For non-multihop connections, the Connection Inactivity Timeout is user configurable. For multihop connections, it is not configurable. Instead, it uses a default timeout value of 17 seconds.

## Communicating with ControlLogix Devices

To communicate through a ControlLogix 1756-ENET module, you configure the multihop feature of a MSG instruction from the Ethernet PLC-5 controller (or PLC-5 controller with 1785-ENET sidecar module) to the target device. You need RSLogix 5 programming software. For more information, see the MSG instruction in the PLC-5 Programmable Controller Instruction Set Reference Manual, publication 1785-6.1.

If you want to go through the ControlLogix 1756-ENET module and out the 1756-DHRIO module to the target device, you:

- use Gateway configuration software to configure the 1756-DHRIO module routing table in the ControlLogix system.
- specify a Link ID number on channel properties for channel 2/3A of the Ethernet PLC-5 controller (or PLC-5 controller with a 1785-ENET sidecar module).

For more information about configuring a PLC-5 channel or specifying the path of the MSG instruction, see the documentation for your programming software.

## TCP/IP

TCP/IP communications have been updated for enhanced UDP message support and super-netting.

## Interpreting Error Codes

When the controller detects an error during the transfer of message data, the controller sets the .ER bit and enters an error code:

<b>Code - Hexadecimal</b> (word 1 of the control block)	<b>Description</b> (displayed on the data monitor screen)
0010	No IP address configured for the network
0011	Already at maximum number of connections
0012	Invalid internet address or host name
0013	No such host
0014	Cannot communicate with the name server
0015	Connection not completed before user-specified timeout
0016	Connection timed out by the network
0017	Connection refused by destination host
0018	Connection was broken
0019	Reply not received before user-specified timeout
001A	No network buffer space available
0037	Message timed out in local controller
0083	Controller is disconnected
0089	Controller's message buffer is full
0092	No response (regardless of station type)
00D3	You formatted the control block incorrectly
00D5	Incorrect address for the local data table
1000	Illegal command from local controller
2000	Communication module not working
4000	Controller connected but faulted (hardware)
5000	You used the wrong station number
6000	Requested function is not available
7000	Controller is in program mode
8000	Controller's compatibility file does not exist

<b>Code - Hexadecimal</b> (word 1 of the control block)	<b>Description</b> (displayed on the data monitor screen)
9000	Remote node cannot buffer command
B000	Controller is downloading so it is inaccessible
F001	Controller incorrectly converted the address
F002	Incomplete address
F003	Incorrect address
F006	Addressed file does not exist in target controller
F007	Destination file is too small for number of words requested
F00A	Target controller cannot put requested information in packets
F00B	Privilege error, access denied
F00C	Requested function is not available
F00D	Request is redundant
F011	Data type requested does not match data available
F012	Incorrect command parameters
F01A	File owner active – the file is being used
F01B	Program owner active – someone is downloading, online editing, or set the program owner with APS in the WHO Active screen

## Interpreting Ethernet Status Data

Monitor the status of Ethernet PLC-5 controllers by accessing the Ethernet channel 2 status screen of your programming software. The diagnostic counter data displayed is stored in the diagnostic file defined on the Ethernet channel 2 configuration screen.



## Monitoring general Ethernet status

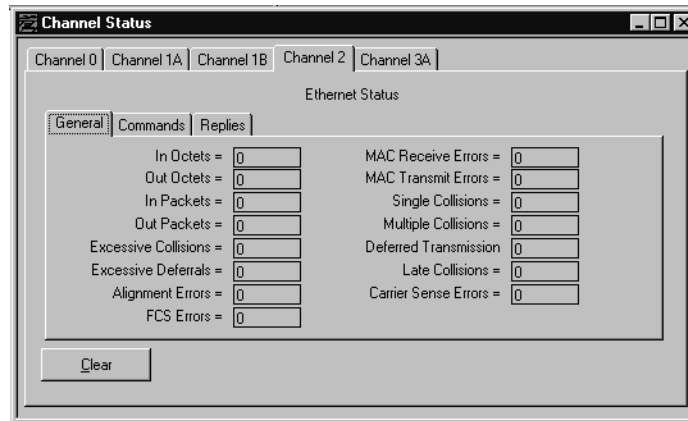

Status Field	Bytes	Displays the Number of
In Octets	28-31	Octets received on the channel
Out Octets	32-35	Octets sent on the channel
In Packets	36-39	Packets received on the channel, including broadcast packets
Out Packets	40-43	Packets sent on the channel, including broadcast packets
Excessive collisions	56-59	Frames for which a transmission fails due to excessive collisions
Excessive deferrals	60-63	Frames for which transmission is deferred for an excessive period of time
Alignment errors	44-47	Frames received on the channel that are not an integral number of octets in length
FCS errors	48-51	Frames received on the channel that do not pass the FCS check
MAC receive errors	64-67	Frames for which reception on an interface fails due to internal MAC sublayer receive error
MAC transmit errors	68-71	Frames for which reception on an interface fails due to internal MAC sublayer transmit error
Single collisions	72-75	Successfully transmitted frames for which transmission was delayed because of collision.
Multiple collisions	76-79	Successfully transmitted frames for which transmission was delayed more than once because of collision.
Deferred transmission	80-83	Frames for which the first transmission attempt is delayed because the medium is busy
Late collisions	84-87	Times that a collision is detected later than 512 bit-times into the transmission of a packet
Multiple collisions	88-89	Network storms encountered
Ethernet Address	90-95	Ethernet Hardware Address
IP Address	96-99	Assigned Internet Protocol Address
Carrier sense errors	52-55	Times that the carrier sense condition was lost or never asserted while trying to transmit a frame

## Monitoring Ethernet commands

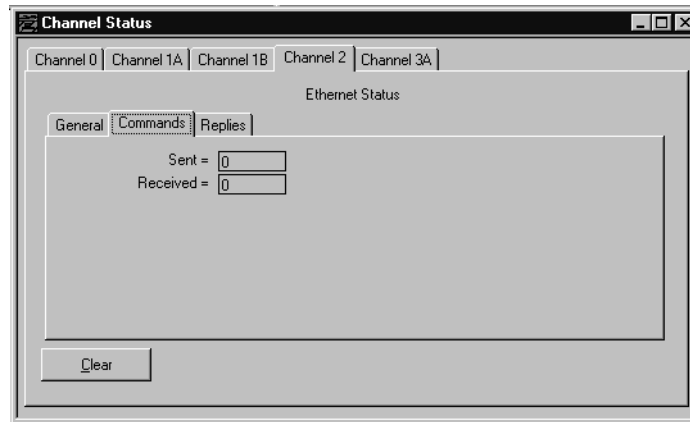

Status Field	Bytes	Displays the Number of
Sent	0-3	Commands sent by the channel
Received	4-7	Commands received by the channel

## Monitoring Ethernet replies

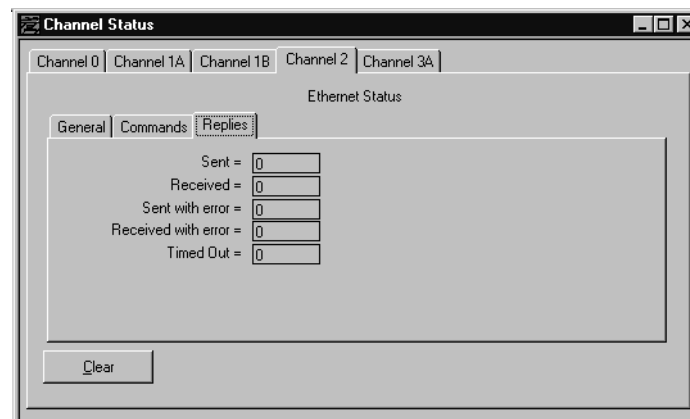

Status Field	Bytes	Displays the Number of
Sent	8-11	Replies sent by the channel
Received	12-15	Replies received by the channel
Sent with error	16-19	Replies containing errors sent by the channel
Received with error	20-23	Replies containing errors received by the channel
Timed out	24-27	Replies not received within the specified timeout period

## Ethernet PLC-5 Performance Considerations

Actual performance of an Ethernet PLC-5 controller varies according to:

- size of Ethernet messages
- frequency of Ethernet messages
- network loading
- the implementation of and performance of your controller application program

The following charts show performance of the Ethernet PLC-5 controller, depending on packet size.

### Performance: Host to Ethernet PLC-5 Controller

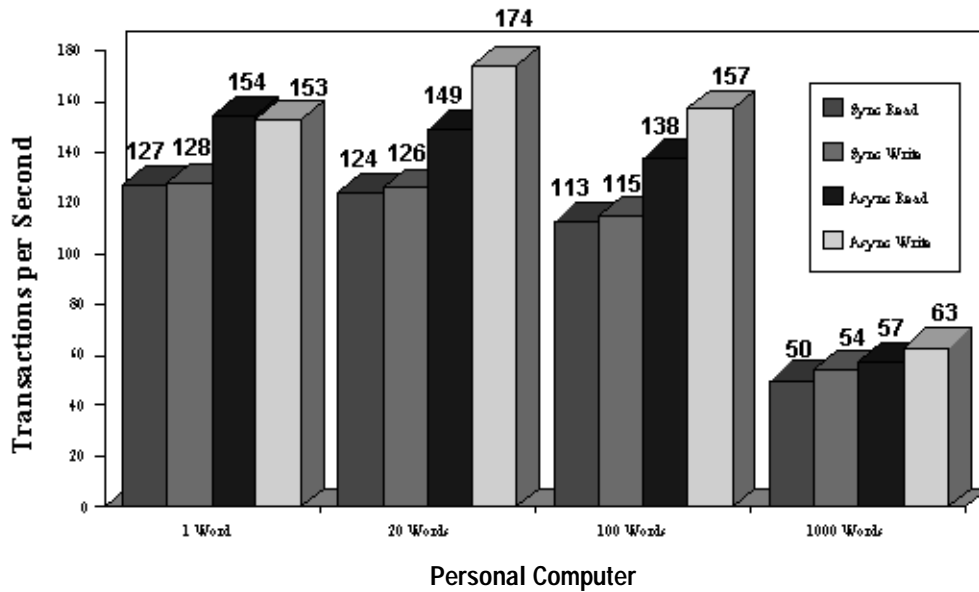

### Performance: Ethernet PLC-5 Controller to Ethernet PLC-5 Controller

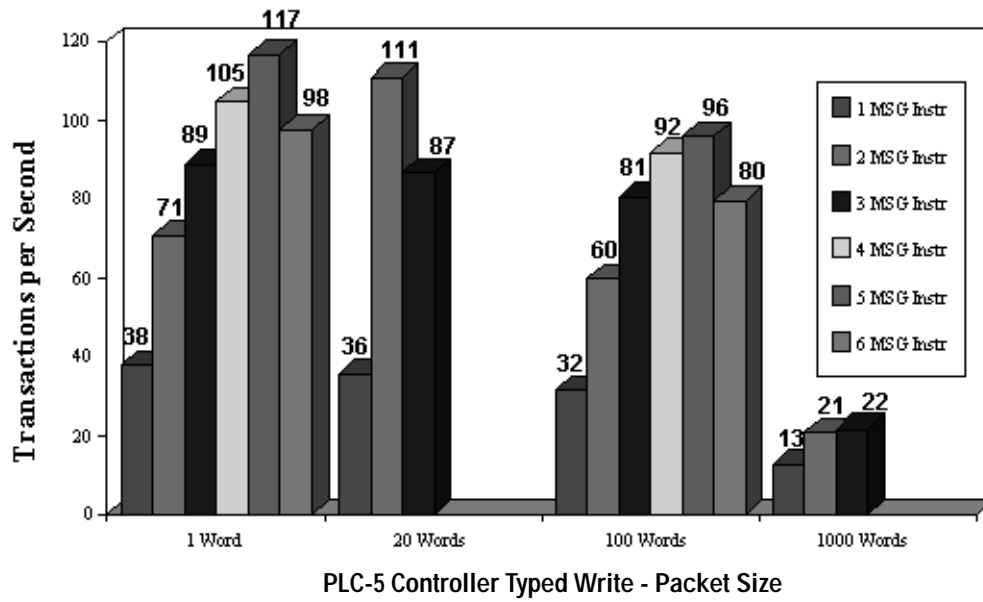

---

## Protecting Your Programs

### Using This Chapter

For Information About	Go to Page
Passwords and privileges	12-2
Defining privilege classes	12-3
Assigning a privilege class to a channel or offline file	12-4
Assigning a privilege class to a node	12-4
Assigning read/write privileges to a program file	12-5
Assigning read/write privileges to a data file	12-5
Using protected controllers	12-6

Read this chapter for an overview of:

- defining privilege classes
- assigning a privilege class to a channel or offline file
- assigning a privilege class to a node
- assigning read/write privileges to a program file
- assigning read/write privileges to a data file

---

**IMPORTANT**

To use these options, select the full passwords and privileges feature when you install the software.

---

For detailed information about configuring privileges, see the documentation for your programming software.

If your application requires privileges beyond those provided by the enhanced or Ethernet PLC-5 controllers, see the PLC-5 Protected Controller Product Data for 1785-5/26, -5/46, and -5/86 controllers, publication 1785-2.28.

## About Passwords and Privileges

The passwords and privileges function supported by enhanced and Ethernet PLC-5 controllers helps you protect your programs by restricting access to controller files and functions.

You can assign a privilege class to a node, channel or file. The privilege class defines the level of access (read or write) or type of function (I/O forcing, memory clearing) the PLC-5 controller allows.

This Privilege	Restricts Access
Node	from a particular node to the controller.
Channel	to a particular channel on the controller.
File	to view or change a file.

**IMPORTANT**

Node privileges override the default privilege class of the channel.

### Privileges Supported by Enhanced and Ethernet PLC-5 Controllers

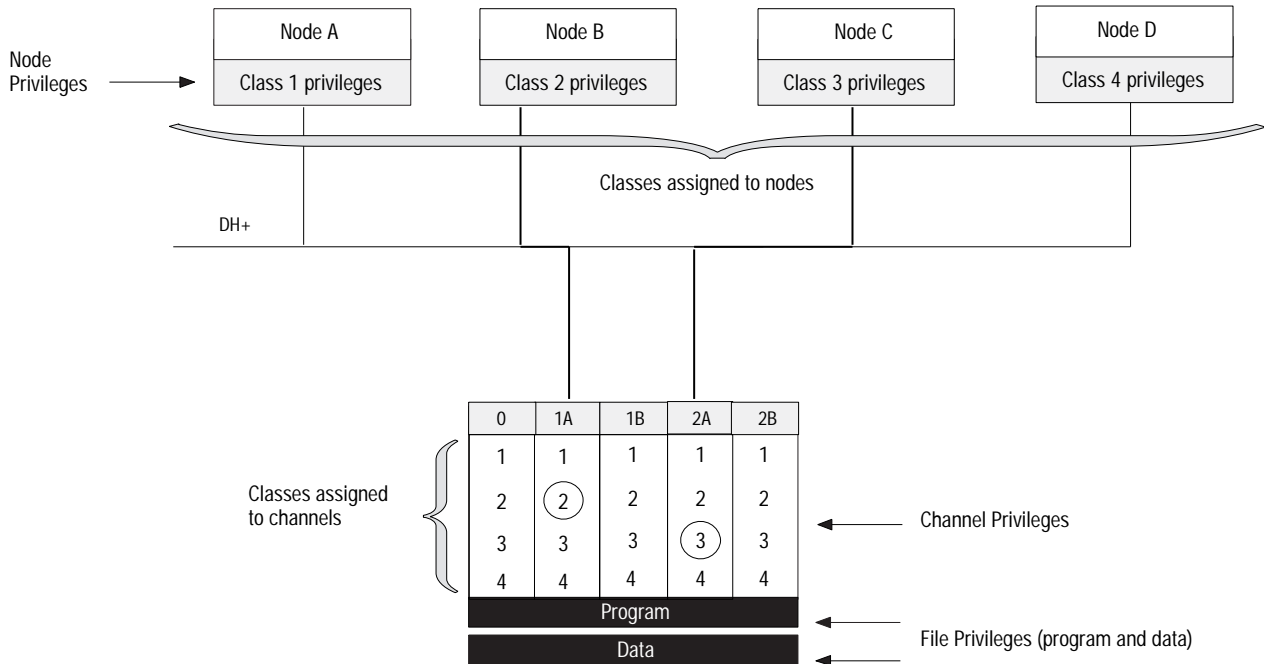

In , the class privileges assigned to each node govern the access the device has to the controller. For example:

- Node B has Class 2 access to channel 1A, based on the node privilege the controller has assigned it

- Node C has Class 3 access to channel 2A, based on the node privilege the controller has assigned it

**IMPORTANT**

If node privileges had not been assigned in this example, the node would have had the same privilege class as that assigned to its channel.

Follow these guidelines when using the passwords and privileges:

- You must define the passwords and privileges information for each controller in your system.
- You **cannot** assign default class privileges to channels configured as scanner or adapter. The read/write privileges you see on the channel privileges screen apply to read/write access of the channel configuration screen of that channel. The read/write privileges for each channel's diagnostic file (channel status screen) must be set up through the data table privileges screen. The default privilege fields on the channel privileges screen determine the privilege class of all stations/nodes that are attached through that channel.
- Tell all of the users of your software which privilege class they can use and the appropriate password. If they want to change to a different class (other than the one for which the personal computer is configured), they must enter the new class and password.
- The passwords and privileges feature helps prevent unauthorized or accidental changes to the system. However, the passwords and privileges feature has limitations; it will not prevent acts of malicious tampering nor can it ensure that changes made by an individual with the password will be appropriate for a particular application.

## Defining Privilege Classes

You can define four privilege classes (class 1-4), each with its own password. Within each class, you then can assign access to certain operations in the software (such as modifying program or data files, or channel configurations). These privilege classes are the upper level organization for your password structure.

You can define Class 1 to have all privileges, equivalent to a system manager. Then, define the remaining three classes to have fewer privileges.

For example, set your privilege classes as follows on the channel privileges screen of your programming software (an X indicates that the privilege is enabled):

Privileges \ Privilege Class Names	Class1	Class2	Class3	Class4
Modify Privileges	X			
Data Table File Create/Delete	X	X	X	
Program File Create/Delete	X	X	X	
Logical Write	X	X	X	X
Physical Write	X	X	X	X
Logical Read	X	X	X	X
Physical Read	X	X	X	X
Mode Change	X	X	X	X
I/O Force	X	X		
SFC Force	X	X		
Clear Memory	X			
Restore	X			
On-line Editing	X			
Modify passwords	X			

### Assigning a Privilege Class to a Channel or Offline File

You can assign a privilege class to all channels (except remote I/O scanner or adapter channels) and offline files. Each channel and offline file has a Class 1 privilege by default.

The read/write privileges you see on the channel privileges screen apply to read/write access to the channel configuration screen of that channel. The read/write privileges for each channel's diagnostic file (channel status screen) must be set up through the data table privileges screen. The default privilege fields on the channel privileges screen determine the privilege class of all stations/nodes that are attached through that channel.

---

**IMPORTANT** You cannot assign default class privileges to scanner or adapter channels.

---

### Assigning a Privilege Class to a Node

All stations/nodes default to the same privilege class as that of the channel they communicate through. You can give a node its own privilege class if you want it to have a class different from the default privilege assigned to that channel.

---

**IMPORTANT** Node privileges override the default privilege class of the channel assigned on the channel privileges screen.

---



## Assigning Read/Write Privileges to a Program File

You can assign read and write privileges for each program file in a controller. These privileges limit the access of users to view or change your program files. Two privileges determine whether a user can read or write to a program file:

- the users' privilege class
- whether read and write privileges have been assigned to the program file itself

## Assigning Read/Write Privileges to a Data File

You can assign read and write privileges for each data file in a controller. These privileges limit the access of users to view or change data file values. Two privileges determine whether a user can read or write to a data file:

- the users' privilege class
- whether read and write privileges have been assigned to the data file itself

---

**IMPORTANT**

Removing both the read and write access from a data table file prevents you from accessing that file.

---

## Notes

## Programming Considerations

### Using This Chapter

For Information About	Go to Page
Forcing	13-1
Extended forcing	13-2
Using special programming routines	13-10
Priority scheduling for interrupts and MCPs	13-11
Defining and programming interrupt routines	13-15

### Forcing

Forcing I/O lets you turn specific input and output bits on or off for testing purposes. Forcing bits on or off or forcing SFC transitions lets you simulate operation or control of a device.

#### IMPORTANT

Forcing inputs lets you force the bits in the input image file. Forcing output lets you force the actual output module, leaving the output image table file in its original state.

Forces are held by the controller (and not the personal computer). Forces remain even if the personal computer is disconnected

#### ATTENTION



When anything is forced on or off, keep personnel away from the machine area. Forcing can cause unexpected machine motion that could injure personnel.

### Forcing Inputs and Outputs

You can force bits directly from the ladder editor or the force monitor screens in your programming software. After you configure which bits to force, you must enable forces before the forces take effect.

You can only force live I/O points, which are bits in an input or output word that are physically attached to and configured for your system.

With the controller-resident local rack set for 1/2-slot addressing, you cannot force the input bits for the upper word of any slot that is empty or that has an 8-point or 16-point I/O module. For example, if you have an 8-point or a 16-point I/O module in the first slot of your local rack (words 0 and 1 of the I/O image table, 1/2-slot addressing), you cannot force the input bits for word 1 (I:001) on or off.

You can't force:

- output addresses on input instructions
- input addresses on output instructions
- other bit addresses other than inputs and outputs, such as N, B, T, C, etc. addresses

## Forcing SFC Transitions

When you monitor an SFC through your programming software, you can force transitions on or off. This lets you override the flow of your SFC for troubleshooting purposes.

## Extended Forcing

Extended forcing is useful when using the 1771-SDN module because it allows you to force discrete I/O on a DeviceNet network. Extended forcing is also useful for forcing analog I/O. With series E, revision B and later Enhanced, Ethernet, and ControlNet PLC-5 controllers, you gain the capability to force a total of 1,024 block-transfer data words. These words can be either integer, binary, ASCII, or hexadecimal/BCD data type.

To use the extended forcing feature, you select the block-transfer files that contain words or bits you want to force. You then use your programming software to enter this data along with the associated force values in the extended force configuration table. Once you do this, you can force all data you send or receive via block-transfer instructions.

Extended forcing works with the following block-transfer instructions:

- block-transfer read (BTR)
- block-transfer write (BTW)
- 1771 read command type of the CIO instruction
- 1771 write command type of the CIO instructions

The 1771 read command type of the CIO instruction operates in the same manner as the BTR instruction; the 1771 write command type of the CIO instruction operates in the same manner as the BTW instruction. For simplicity, the following descriptions and examples of extended forcing refer to the BTR instruction (for BTR and 1771 read command type of CIO instructions) and the BTW instruction (for BTW and 1771 write command type of CIO instructions).

You program block-transfer instructions in the same manner, regardless of whether you configure the data file in the extended force configuration table. The following figure shows how block-transfer data table files are updated during housekeeping.

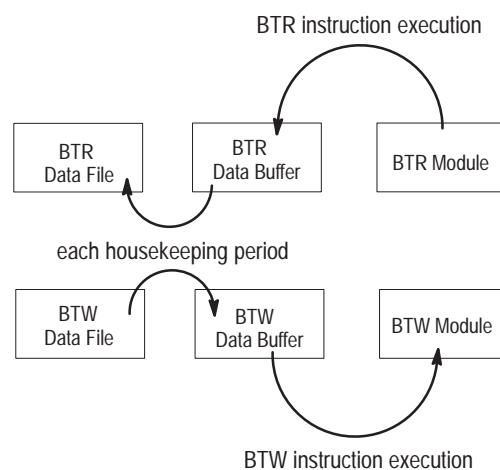

When you use extended forcing, you affect the way your programmable controller system operates. Before you begin to use this forcing feature, read this entire section to understand the effects.

**ATTENTION**

Any block-transfers or data table locations included in the extended force configuration table will be affected **regardless** of whether forces are enabled.

**ATTENTION**

Do not use BTR data tables files to store non-block-transfer data. All non-block-transfer data that you include in the extended force configuration table as read data will be forced to zero during housekeeping at the end of each program scan. If your ladder program expects values other than zero for this data, unpredictable machine operation could result.

For BTR instructions using non-configured data tables, the .DN bit indicates when data is valid in the BTR data file. When you configure files in the extended force configuration table, the .DN bit indicates that the data is in the BTR data buffer. The BTR data is not forced and moved into the BTR data file until the next housekeeping period. Delay using the BTR data until the scan after the .DN bit is set.

For BTW instructions using non-configured data tables, the data that is in the BTW data file when the block-transfer is enabled is transferred. When you configure files in the extended force configuration table, the data that in the BTW data buffer when the block-transfer is enabled is transferred. Any new data in the BTW data file is not forced or moved into the BTW data buffer until the next housekeeping period. Delay enabling the BTW instruction until the scan after the BTW data file is updated.

## Increased Program Scan Time

When you use the extended forcing feature, program scan time increases proportionately to the number of words you configure in the extended force configuration table. The amount of increase depends on whether you enable or disable forces. Typical increases in program scan time when you configure data table files in the extended force configuration table are:

When Forces are	Scan Time Increases by this Much	
	Per Word	Per 1000 Words
enabled	0.003 ms	3.0 ms
disabled	0.0015 ms	1.5 ms

## I/O Force Privileges

The I/O forcing privilege lets you enable, disable, or clear all forces in the controller. This privilege now includes extended forcing.

Extended forcing reads force data in a read data file; extended forcing writes force output data, leaving the write data file in its original state.

---

**IMPORTANT**

Forces are held by the controller (and not the personal computer). Forces remain even if the personal computer is disconnected.

---

## Using Protected Controllers

If you are using a PLC-5 protected controller, you must configure forcing online since, by their design, protected controllers cannot download forcing operations. This protects controller operation from possible force operations programmed in offline mode. For more information about protected controllers, see the PLC-5 Protected Controller Supplement, publication 1785-6.5.13.

## Using Selectable Timed Interrupts (STIs) and Controller Input Interrupts (PIIs)

We recommend that you do not use forcible block-transfer data table files within STIs or PIIS due to the unique data flow of forcible block-transfer data. Block-transfer data that is written out or read in is never valid within the interrupt program file execution itself. Any necessary additional program scan time may defeat the purpose for programming the STI or PII.

## Setting Up and Using Extended Forcing

Use your programming software to set up and use the extended forcing feature. The following table lists the software requirements for the extended forcing feature.

With the Programming Software Package	You Need this Software Release
RSLogix5	2.0 or later
6200	5.3 or later
A.I. 5	8.03 or later
WinLogic 5	3.22 or later

To set up and use the extended forcing feature, you need to:

1. Select the group of data you want to force.
2. Use the programming software to enter or edit the data you want to force in the extended force configuration table.
3. Use the programming software to enter force values for the specified data table files.
4. Enable or disable the forces.

## Step 1 - Select Which Group of Data You Want to Force

**IMPORTANT**

Group the data in the extended force configuration table so that you separate read data from write data. If you do not separate read and write data, you encounter error code -3 if:

- program a BTW instruction using a data file that you configured in the extended force configuration table as a read application
- program a BTR instruction using a data file that you configured in the extended force configuration table as a write application

You also encounter this error if you try to transfer block-transfer data that crosses the forcible range you configured in the extended force configuration table.

When you select the group of data you want to force, you must select and configure data that corresponds to an entire “chunk” or multiple “chunks” of block-transfer data. For example:

You want to force some data associated with block-transfer read #2 and with block-transfer read #4. To select the data, you could:

- Select all of data file N11
- Select N11 beginning at word 20 for 60 words (i.e., beginning at the start of BTR #2 and ending at the end of BTR #4)
- Make two selections, one beginning at the start of BTR #2 with the size of BTR #2 (N11:20 for 12 words), and one beginning at the start of BTR #4 with the size of BTR #4 (N11:55 for 25 words).

Word	Data Table File N11
0	BTR #1
20	BTR #2
32	
55	BTR #3
80	BTR #4



## Step 2 - Use the Programming Software to Enter or Edit the Data You Want to Force in the Extended Force Configuration Table

The extended force configuration table lets you specify as many as four groups of block-transfer data words to force. Each group can contain as many as 256 words of block-transfer data. When you plan your forcing, you can group together multiple block-transfer instructions until you reach the 256-word maximum for each group. Keep in mind that the data in each group should be all read data or all write data.

Specify each group by entering the address of the first block-transfer instruction in that group in the extended force configuration table. Use the programming software's edit function on the extended force configuration table to clear entries, modify entries, or change block-transfer instructions.

Use your programming software to edit the extended force configuration table:

1. Choose the software option that lets you modify entries in the extended force configuration table.
2. Enter the file number and starting element.
3. Enter the file size (1-256 words).
4. Enter the direction of the instruction (R=read; W=write).

Forced data table files must be of type B, A, N, or D or this error appears:

FORCES MUST BE OF TYPE B, A, N, OR D

Data files are automatically created and their size automatically increased if necessary. To delete or reduce the size of a data file, you must use the memory map function of the programming software. If you configure a file using the extended force configuration table, you must delete the file from the extended force configuration table before you can delete it from the memory map.

### Step 3 - Use the Programming Software to Enter Force Values for the Specified Data Table Files

The block-transfer forcing screens include a function that lets you change the radix among binary, octal, HEX/BCD, and ASCII. If you select the binary radix, the display is similar to the I/O forcing display. The programming software displays forces differently, depending on the selected radix:

Radix	Force	Screen Display
binary	no force	. (period)
	off	0
	on	1
other	no force	. (period)
	all bits	forced value
	some bits	BINARY  (use binary radix to view the forced bits)

If you enter a force value on the block-transfer force screen, you force the entire word to the value you enter, even if the word was only partially force before.

### Step 4 - Enable or Disable the Forces

Enabling and disabling extended block-transfer forces is similar to enabling and disabling I/O forces. For more information, see page 13-1.

### Using Extended Forcing with Time-Critical Applications

For many applications in which you execute multiple block-transfers on a continuous basis, you do not need any additional programming when using extended forcing. When you configure extended forcing, block-transfer instructions only move data between the block-transfer modules and the block-transfer data buffers. Data is forced and moved during housekeeping. In applications in which you perform a single block-transfer or in which new block-transfer data must be completely transferred in every block-transfer instruction, you must include additional programming to make sure that you are using valid, updated data.

To ensure that the received BTR data table file has been properly updated before you use the data, do the following:

1. Enable the input conditions of the BTR rung.
2. Wait for the BTR done bit to be set.
3. Allow time for housekeeping to force and send the changed data from the block-transfer data buffer to the block-transfer data table file.

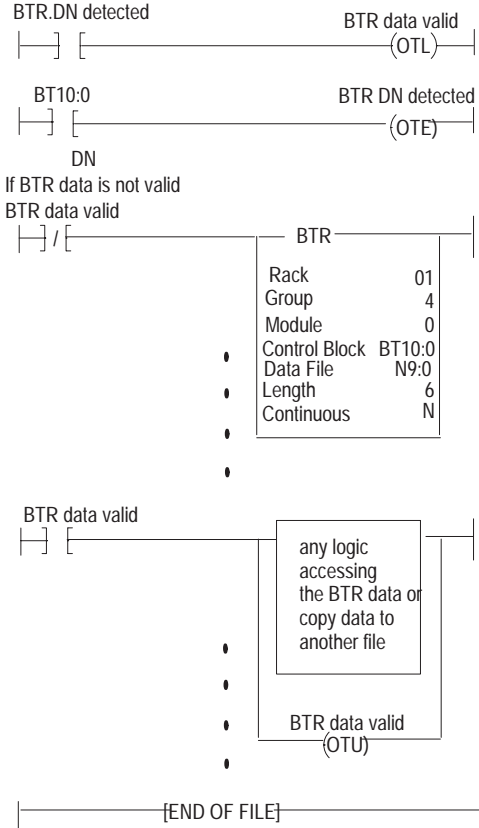

After the BTR done bit is set, the valid data in the BT data buffer is copied to the BTR data table file during housekeeping.

41401

To ensure that the intended BTW data table file was properly transferred, do the following:

1. Change the data in the block-transfer output data table.
2. Allow time for housekeeping to force and send the changed data from the block-transfer output data table file to the block-transfer data buffer.
3. Enable the BTW

**4. Ensure that data does not change in the block-transfer data table output file until the BTW is complete.**

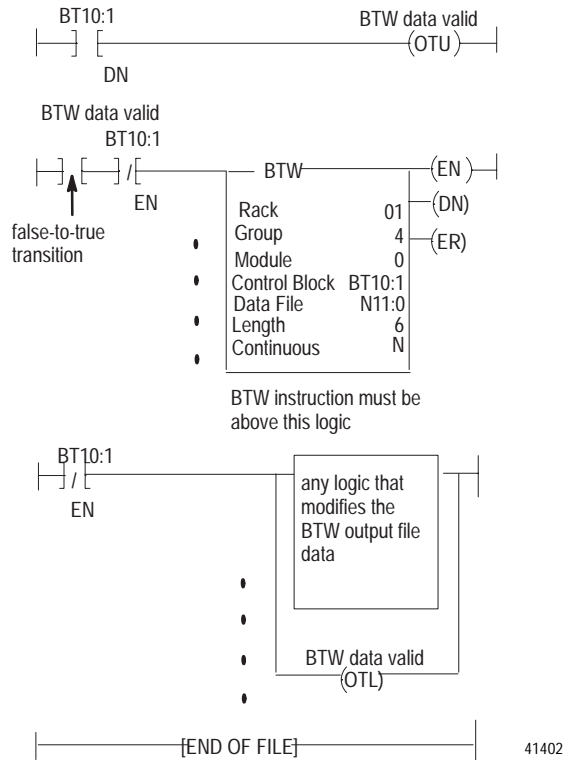

## Using Special Programming Routines

Use your design specification to determine if you need one or more of the following special programming routines:

- power-up routines
- fault-driven routines (necessary to safely manage equipment faults)
- time-driven interrupt routines (selectable timed interrupts)
- event-driven interrupt routines (controller input interrupts)

The following table explains when to use these programming features.

### Deciding When to Use Special Routines

If a Portion of Logic Should Execute	Example	Use	By Doing the Following:
Immediately on detecting conditions that require a startup	Restart the system after the system has been shut down	Power-Up Routine	Create a separate file for a controlled start-up procedure for the first time you start a program or when you start a program after system down time. The controller executes the power-up routine to completion.
Immediately on detecting a major fault	Shut down plant floor devices safely upon detecting a major fault  or  Send critical status to a supervisory controller via DH+ after detecting a major fault	Fault Routine	Create a separate file for a controlled response to a major fault. The first fault detected determines which fault routine is executed. The controller executes the fault routine to completion. If the routine clears the fault, the controller resumes the main logic program where it was interrupted. If not, the controller faults and switches to program mode.
At a specified time interval	Monitor machine position every 250ms and calculate the average rate-of-change  or  Take a measurement and compare it with a standard every 1.0 seconds	Selectable Timed Interrupt (STI)	Create a separate program file and specify the interrupt time interval. The controller interrupts the main logic program at the specified interval, runs the STI to completion, then resumes the main logic program where it left off.  The controller interrupts the main logic program at the specified interval and runs the STIs. When a block-transfer instruction to remote I/O is encountered in an STI, the controller resumes execution of lower priority programs (main logic program) until the block-transfer is completed. When this occurs and you want your STI to run to completion before returning to the main logic program, use UID and UIE instructions in your STI program file.
Immediately when an event occurs	Eject a faulty bottle from a bottling line	Controller Input Interrupt (PII)	Create a separate program file and specify 16 inputs of an input word in the I/O rack. When the event(s) occurs, the controller interrupts the main logic program, runs the PII to completion, then resumes the main logic program where it left off.  When a block-transfer instruction to remote I/O is encountered in a PII, the controller resumes execution of lower priority programs (main logic program) until the block-transfer is completed. When this occurs and you want your PII to run to completion before returning to the main logic program, use UID and UIE instructions in your PII program file.

### Priority Scheduling for Interrupts and MCPs

PLC-5 controllers prioritize when fault routines, interrupts, and main control programs are executed. This prioritization is called “scheduling.” The PLC-5 controller considers some scheduling tasks to be of greater importance than others. The scheduling priority of each task is as follows (from highest to lowest):

1. Fault Routine
2. Controller Input Interrupt (PII)
3. Selectable Timed Interrupt (STI)
4. Main Control Program (MCP)

This scheduling determines what controls the program execution path. For example, if a PII is currently executing, it cannot be interrupted by an STI until the PII is completed (since the PII has scheduling priority over the STI). If an MCP is executing and a fault routine is called, however, the MCP's execution will be interrupted because fault routines have priority over the MCPs.

---

**IMPORTANT**

You can temporarily override this priority scheduling by using the UID and UIE instructions. These instructions can be interrupted by a fault routine (see page 13-14).

---

Fault routines, PIIs, and STIs are interrupt driven. They can execute at any time except during run-time edit operations. MCPs, however, are executed to completion from first user program to last.

## Program Execution States

User programs in the PLC-5 controller are always in one of the following five states: completed, ready, executing, waiting, or faulted.

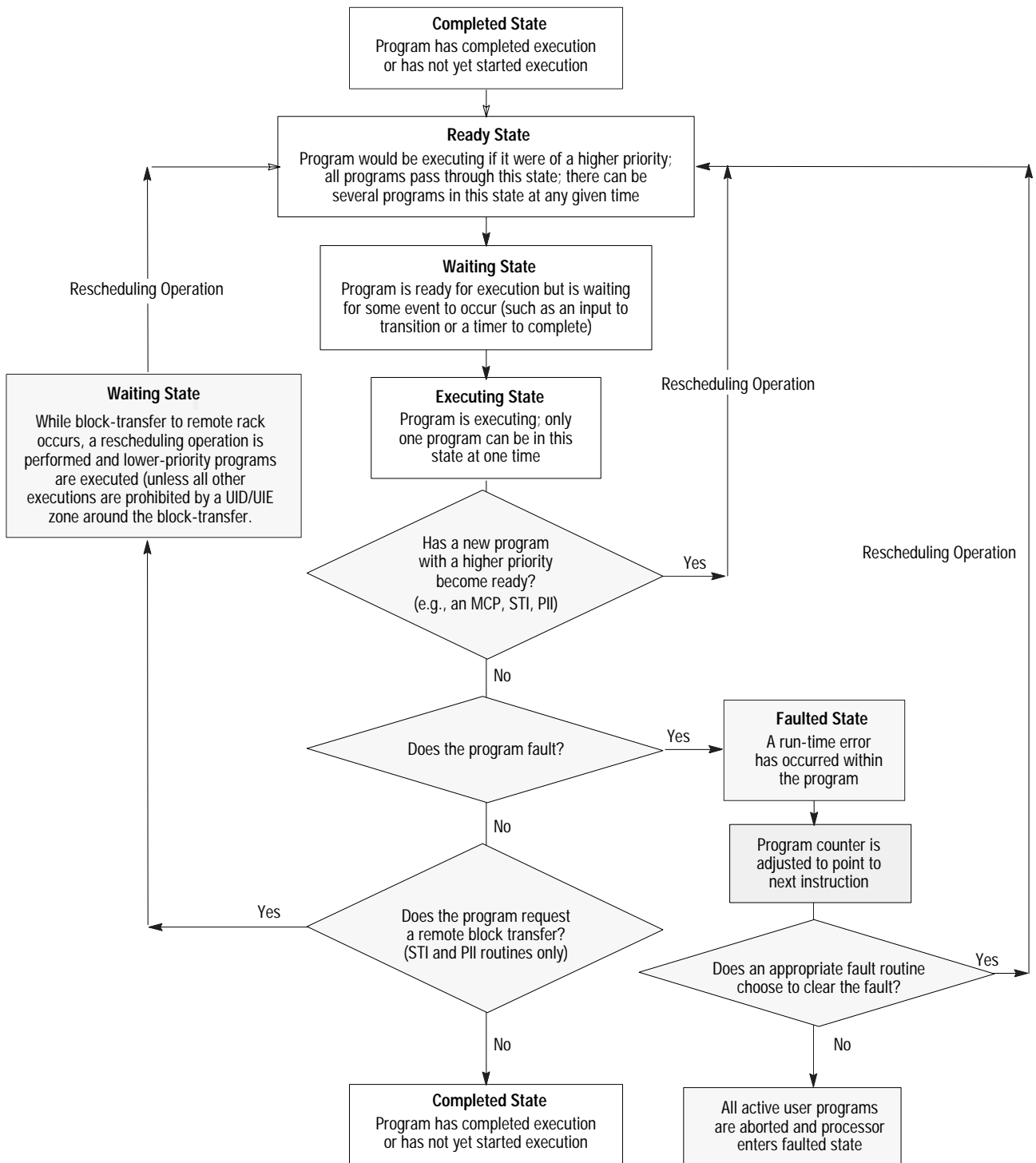

### Influencing Priority Scheduling

Use the UID (user interrupt disable) and UIE (user interrupt enable) instructions to influence user program scheduling. They can be used to protect important portions of ladder logic that must be executed through to completion. The UID/UIE instructions are designed to be used in pairs. For example:

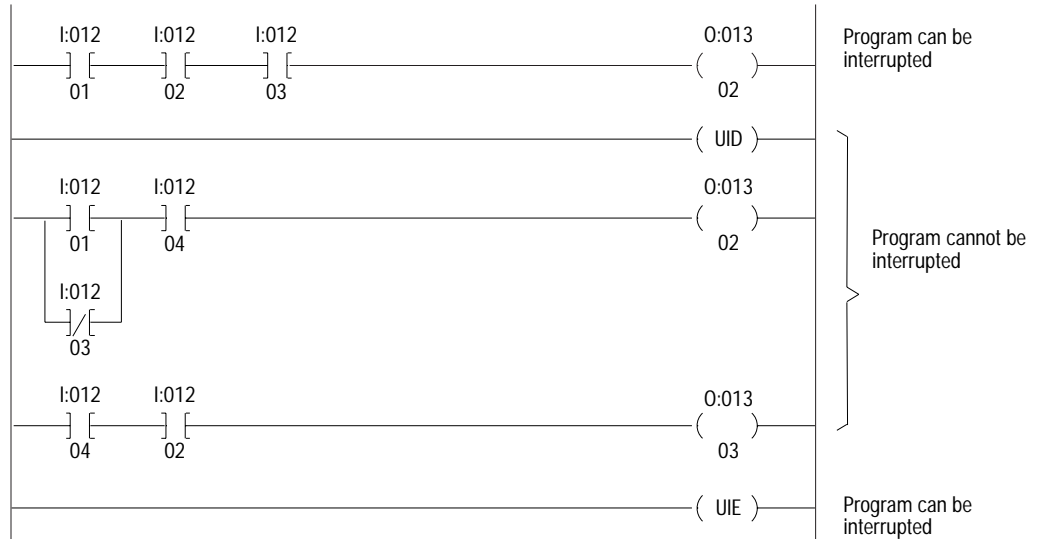

After a UID instruction has executed, interrupts are postponed. The interrupt program is placed in the *ready* state. After a UIE instruction has executed, any user programs that are currently in the *ready* state are checked for priority. If the **ready** program is of a higher priority than the currently executing program, the executing program returns to the *ready* status while the interrupt program begins executing. While the controller is executing within a UID/UIE zone, the executing program cannot be interrupted except by a fault routine.

For more information on programming UID or UIE instructions, see the PLC-5 Programming Software Instruction Set Reference, publication 1785-6.1.



## Defining and Programming Interrupt Routines

For information about configuring and programming these routines, see the appropriate chapter:

<b>For Information About</b>	<b>See Chapter</b>
Power-up routines	14
Fault routines	15
Main control programs (MCPs)	16
Selectable timed interrupts (STIs)	17
Controller input interrupts (PIIs)	18

## Notes

## Preparing Power-Up Routines

### Using This Chapter

For Information About:	Go to Page
Setting power-up protection	14-1
Allowing or inhibiting startup	14-2
Defining controller power-up procedure	14-2

### Setting Power-Up Protection

You can configure your controller so that if a power-loss is experienced while in run mode, the controller does not come back up in run mode. User control bit S:26/1 defines whether power-up protection (e.g., fault routine) is executed upon power-up.

If S:26/1 is	After power loss, the controller
Set (1)	Scans the fault routine before returning to normal program scan  When set, the controller scans the fault routine once to completion after the controller recovers from a power loss. You can program the fault routine to determine whether the controller's status will let the controller respond correctly to logic and whether to allow or inhibit the startup of the controller.
Reset (0)	Powers up directly at the first rung on the first program file

Set S:26/1 manually from the Controller Status screen, or latch this bit through ladder logic.

## Allowing or Inhibiting Startup

Major fault bit S:11/5 controls whether you can power up the controller in run mode after a loss of power. Do not confuse this bit with user control bit S:26/1.

This Bit	Tells the Controller
user control S:26/1	whether or not to scan a fault routine upon power up before returning to normal program scan.
major fault S:11/5	whether or not to fault at the end of scanning the fault routine.

After a power loss is experienced while the controller is in run mode, the controller automatically sets major fault bit S:11/5 if user control bit S:26/1 has been set.

If the Fault Routine Makes S:11/5	Then the Controller
Set (1)	Faults at the end of scanning the fault routine Leave this bit set to inhibit startup
Reset (0)	Resumes scanning the controller memory file Reset this bit to allow startup

**IMPORTANT** You can use JMP and LBL instructions to scan only the portion of the fault routine associated with a particular fault or power-up condition.

## Defining a Controller Power-Up Procedure

The user control bits S:26/0 and S:26/1 define how the controller starts in run mode after a power loss or when you switch to run mode from program or test mode.

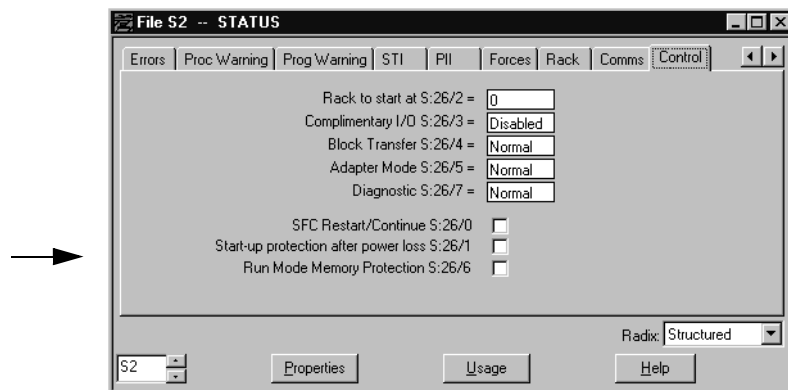

To set and reset bits:

1. Cursor to the bit location.
2. Set by entering 1; reset the bit by entering 0.

Use this Bit	To
0	Control controllers that are using SFCs  This bit determines if the SFC restarts or resumes at the last active step after a power loss.
1	Select power-loss protection  If this bit is set and a power loss occurs, the controller sets major fault bit 5 and executes a fault routine you define before it returns to normal program scan.

The above table describes the possible start-up routines. For more information about fault routines, see chapter 16.

See chapter 21 for definitions of the user control bits (S:26/0-6).

#### Possible Controller Power-Up Routines

If You are	With	And You Want to:	Then Set Bit 0 and 1 as Shown: 15.....0
Using SFCs	No fault routine	Restart at the first step	xxxxxxx xxxxxx00
		Restart at the last active step	xxxxxxx xxxxxx01
Not using SFCs	Fault routine	Start at the first file	xxxxxxx xxxxxx0x
		Restart using the fault routine file	xxxxxxx xxxxxx1x
Using a fault file	SFCs	Restart using the fault file and then the first step	xxxxxxx xxxxxx10
		Restart using the fault file and then the last active step	xxxxxxx xxxxxx11
Not using a fault file	Not using SFCs	Start at the first file in the controller's memory.	xxxxxxx xxxxxx00

Each x indicates a bit that can be 0 or 1 for the status value described.

## Notes

## Preparing Fault Routines

### Using This Chapter

For Information About	See Page
Understanding the fault routine concept	15-1
Understanding controller-detected major faults	15-2
Defining a fault routine	15-4
Defining a watchdog timer	15-5
Programming a fault routine	15-6
Monitoring faults	15-11

### Understanding the Fault Routine Concept

Fault routines execute when a PLC-5 controller encounters a major fault during program execution.

Use a fault routine to specify how you want the controller to respond to a major fault. If your controller experiences a fault during program execution, you can tell the controller to interrupt the current program, run your fault routine, and then continue processing the original program.

A fault routine processes the major fault bit found in S:11 and determines the course of program execution based on the fault bit present. Fault routines provide a means to either:

- systematically shut down a process or control operation
- log and clear the fault and continue normal operation

For a detailed list of the words in the controller status file, see Appendix B.

### Responses to a Major Fault

When the controller detects a major fault, the controller immediately interrupts the current program. If a fault routine exists (i.e., program file is specified in S:29 as a fault routine), the controller runs that fault routine program for recoverable faults. Depending on the type of fault, the controller then:

- returns to the current ladder program file if the controller can recover from the fault
- enters fault mode if the controller cannot recover from the fault

For example, this rung includes an instruction that causes a major fault:

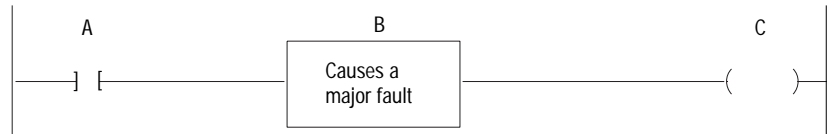

In this example, the processor runs the fault routine after detecting the fault. If the fault routine resets the faulted bits, the processor returns to the next instruction in the program file that follows the one that faulted and continues executing the remainder of the rung. If you do not program a fault routine for fault B, the processor immediately faults.

## Understanding Controller-Detected Major Faults

In general:

If the Controller Detects a	It Sets
major fault	a major fault bit and resets I/O
memory loss fault	outputs in 1771-ASB remote I/O racks and/or 1771-ALX extended-local I/O racks are set according to their last state switch setting
	The outputs remain in their last state or they are de-energized, based on how you set the last state switch in the I/O chassis.

### IMPORTANT

In the PLC-5 controller-resident chassis, outputs are reset regardless of the last state switch setting when one of the following occurs:

- controller detects a major fault
- you set a status file bit to reset a local rack
- you select program or test mode



To decide how to set this switch, evaluate how the machines in your process will be affected by a fault. For example:

- how will the machine react to outputs remaining in their last state or to outputs being automatically de-energized?
- what is each output connected to?
- will machine motion continue?
- could this cause the control of your process to become unstable?

To set this switch, see Appendix E.

## Fault in a Controller-Resident or Extended-Local I/O Rack

If a problem occurs with the chassis backplane, the controller sets the appropriate minor fault bit (S:7/0-7) and continues scanning the program and I/O. As soon as this bit is set, the outputs for that rack are reset. However, the controller continues normal run-time operation.

The outputs are enabled again only if the faulted rack condition is cleared. For example, if a local I/O module faults, all outputs in that rack are reset and the controller continues executing the program scan. Outputs will be enabled only after the faulted module is removed.

Your ladder program should monitor the I/O rack fault bits (S:7/0-7) and take the appropriate recovery action.

### ATTENTION



If a controller-resident local I/O rack fault occurs and you have no recovery methods, the input image table and outputs for the faulted rack remain in their last state. Potential injury to personnel and damage to the machine may result.

## Fault in a Remote I/O Chassis

A remote I/O rack fault can be a loss of communications with the remote I/O device or a problem with the remote I/O device itself. When the controller detects a remote I/O rack fault, the controller sets an I/O rack fault bit in the controller status table. The controller then continues scanning the program and controlling I/O.

The outputs in the faulted rack remain in their last state or they are de-energized, based on how you set the last state switch in the I/O chassis.

**ATTENTION**

If outputs are controlled by inputs in a different rack and a remote I/O rack fault occurs (in the inputs rack), the inputs are left in their last non-faulted state. The outputs may not be properly controlled and potential injury to personnel and damage to the machine may result. Be sure you have recovery methods.

---

Outputs in the controller-resident chassis and in any non-faulted remote rack can remain active if a remote I/O rack fault is detected. Make sure to design your program so that the system goes to a known state in the event that outputs in the controller-resident chassis or non-faulted remote racks are controlled by inputs from the faulted remote I/O rack. Your program must be able to account for the inputs remaining in their last state or the program must monitor the rack fault status bits and reset the input image data table to make remote inputs inactive.

Here are two programming methods you can use:

- In the very first executable instruction, the program monitors the rack fault bits. If any faults bits are set, the program copies zeros (0) to the faulted rack's input image data table. The program must continually copy zeros at the beginning of the program scan to the input image table as long as the fault condition remains because the controller sets the input image bits back to the last state at the end of the program scan.
- In the very first executable instruction, the program monitors the rack fault bits. If any fault bits are set, the program sets the corresponding inhibit bit for the faulted rack. The program must then execute a one time copy of zeros to the faulted rack's input image table to reset all inputs.

## Defining a Fault Routine

You can write multiple fault routine programs and store them in multiple fault routine files, but the controller runs only one fault routine program when the PLC-5 controller detects a major fault. You can, however, change the fault routine program that is to be run through ladder logic. If you do not specify a program file number, the controller immediately enters fault mode after detecting a fault.

To define a controller fault routine:

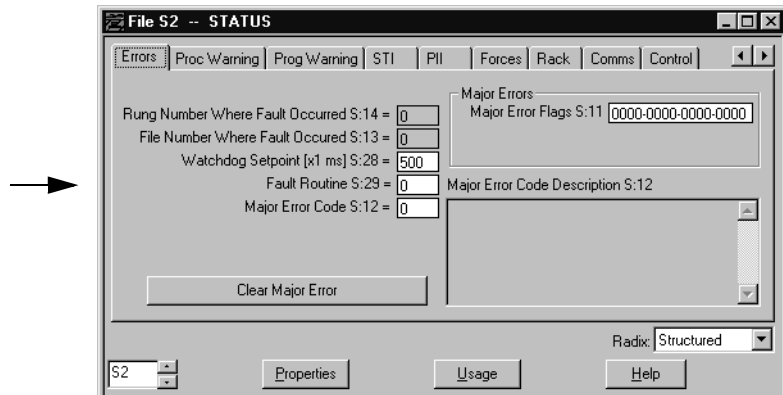

For more information about fault codes, see the documentation for your programming software.

## Defining a Watchdog Timer

The watchdog timer (S:28) monitors the program scan. If the scan takes longer than the watchdog timer value, a fault routine is initiated and executed.

The timer is the maximum time (in ms) for the watchdog; or if you use an SFC, it is the maximum time for a single pass through all the active steps.

To define a different value other than the default: .

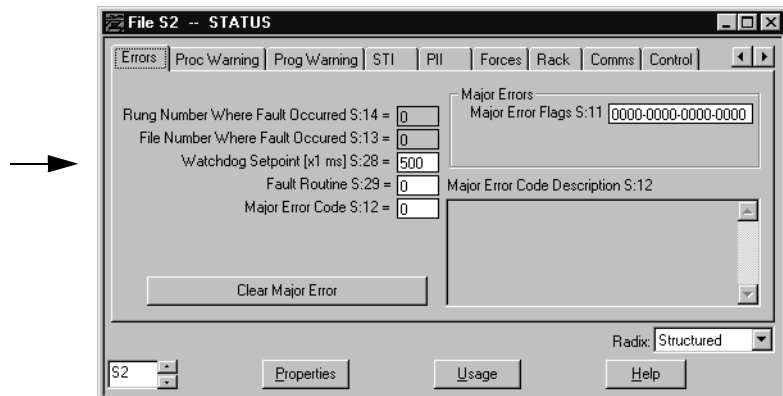

### IMPORTANT

The watchdog timer can go only as low as 10 ms, even though the programming software allows single-digit inputs

## Avoiding Multiple Watchdog Faults

If you encounter a memory loss fault or watchdog major fault, it may be because multiple watchdog faults occurred while the controller was busy servicing a ladder-related major fault. The memory loss fault occurs when the fault queue, which stores a maximum of six faults, becomes full and cannot store the next fault.

Before calling a service representative when you encounter either a memory loss fault or multiple watchdog faults, check:

If You Encounter	Then
watchdog error and a fault bit	<p>Extend the watchdog timer so that the real run-time error is not masked.</p> <p>Check your major fault bits. Ignore the watchdog faults and use any remaining fault bits to help indicate the source of the controller fault.</p>
memory loss fault	<ol style="list-style-type: none"> <li>1. Power down then power up the controller.</li> <li>2. Reload the program.</li> <li>3. Set the watchdog timer to a value = 10 current setting</li> <li>4. Run the program again.</li> </ol>

If you continue to encounter the memory loss fault, call your local Rockwell Automation representative.

## Programming a Fault Routine

To prepare your fault-routine program, first examine the major fault information recorded by the PLC-5 controller and then decide whether to do the following before the PLC-5 controller automatically goes to fault mode:

- set an alarm
- clear the fault
- execute the appropriate fault routine through ladder logic
- execute the appropriate ladder logic to recover from a fault

### IMPORTANT

If the PLC-5 controller detects a fault in the fault routine (double-fault condition), the PLC-5 controller goes directly to fault mode without completing the fault routine.

## Setting an Alarm

If you need an alarm to signal the occurrence of a major fault, put this rung first in your fault routine program:



and combine it with a counter. You can also set an alarm in your fault routine to signal when the fault routine clears a major fault.

## Clearing a Major Fault

You can clear a major fault with one of these methods:

- Turn the keyswitch on the PLC-5 controller from REM to PROG to RUN.
- Use the programming software to clear the major fault (if recoverable).

### ATTENTION



Clearing a major fault does **not** correct the cause of the fault. Be sure to examine the fault bit and correct the cause of the fault before clearing it.

For example, if a major fault is encountered causing bit S:11/2 to be set, indicating a programming error, **do not** use a fault routine to clear the fault until you correct your program.

If you decide to clear the fault in the fault routine, follow these steps:

1. Place the ladder logic for clearing the fault at the beginning of the fault routine.
2. Identify the possible major faults.
3. Select only those your application will let you safely clear. These are your reference fault codes.
4. From the fault routine, examine the major fault code that the controller stores in S:12.
5. Use an FSC instruction to compare the fault code to the reference file that contains “acceptable” fault codes (word-to-file comparison).

6. If the controller finds a match, the FSC instruction sets the found (.FD) bit in the specified control structure.
7. Use a MOV instruction to clear the fault in S:11. In the following figure, #N10:0 is the reference file.

**Example of Comparing a Major Fault Code with a Reference**

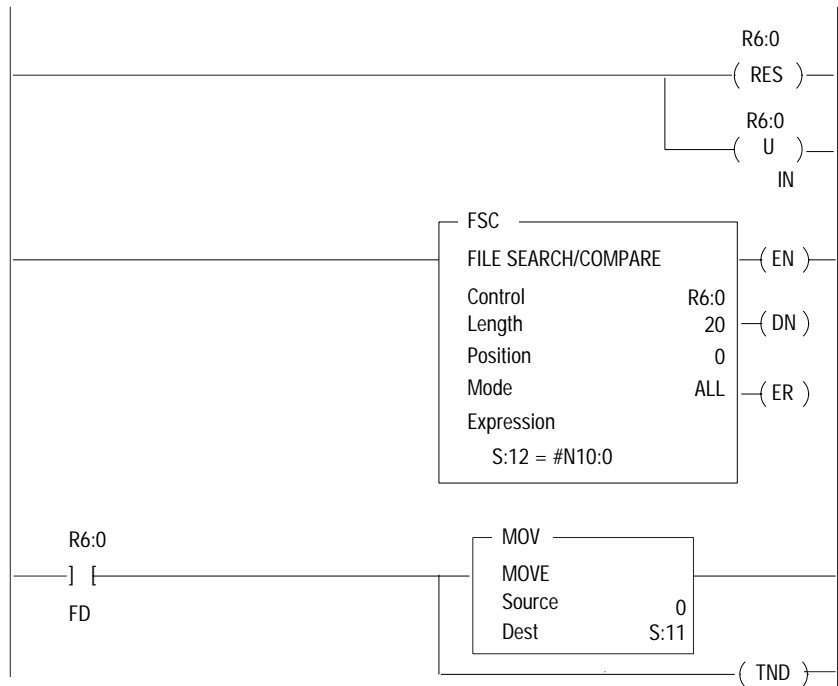

Remainder of fault routine follows

If the Fault Routine	Then the Controller
clears S:11	returns to the program file and resumes program execution.
does not clear S:11	executes the rest of the fault routine and then faults

**IMPORTANT**

If the fault routine clears the major fault, the controller completes the fault routine and returns to the next instruction in the program file that follows the one that contained the faulted instruction.

The remainder of the rung is executed and it appears that the fault never occurred. The fault routine execution continues until you correct the cause of the fault.

Follow these guidelines when creating fault routines:

- Store initial conditions and reset other data to achieve an orderly start-up later.
- Monitor the shutdown of critical outputs. Use looping if needed to extend the single fault routine scan time up to the limit of the controller watchdog timer so your program can confirm that critical events took place.

**IMPORTANT**

When you clear a fault within the fault routine, it is possible for the controller to clear the fault, return to the faulty code, experience the same fault again and repeat the process over and over. When this happens, the controller is executing the faulty code and the fault routine code, but not the main ladder program. This causes the inputs and outputs to remain in their last state. To avoid this problem, place additional code in the fault routine to instruct the controller to execute the main portion of the ladder code once the fault is cleared.

### Changing the Fault Routine from Ladder Logic

You can change the specified fault routine from ladder logic by copying a new fault routine file number into word 29 of the controller status file.

The following figure shows an example rung for changing the fault routine file number.



**ATTENTION**



Do not corrupt the program-file number of the fault routine or use the same file for any other purpose. If the file number you specify results in a non-existent fault routine, the controller immediately enters fault mode after detecting a fault. Unexpected machine operation may result with damage to equipment and/or injury to personnel.

## Using Ladder Logic to Recover from a Fault

If you have the appropriate fault routine and ladder logic to perform an orderly shutdown of the system, you may want to configure an I/O rack fault as a minor fault. You can program ladder logic in several ways to recover from an I/O rack fault.

### Ways to Recover from a Rack Fault

Method	Description
User-generated major fault	<p>The program jumps to a fault routine when a remote I/O rack fault occurs. In other words, if the status bits indicate a fault, you program the controller to act as if a major fault occurred (i.e., jump to the fault routine). You then program your fault routine to stop the process or perform an orderly shutdown of your system. When the controller executes the end-of-file instruction for the fault routine, a user-generated major fault is declared.</p>
Reset input image table	<p>You monitor the status bits and, if a fault is detected, you program the controller to act as if a minor fault occurred. After the status bits indicate a fault, use the I/O status screen in your programming software to inhibit the remote rack that faulted. You then use ladder logic to set or reset critical input image table bits according to the output requirements in the non-faulted rack.</p> <p>If you reset input image table bits, during the next I/O update, the input bits are set again to their last valid state. To prevent this from occurring, your program should set the inhibit bits for the faulted rack. The global inhibit bits control the input images on a rack by rack basis; the partial rack inhibit bits control the input images on a 1/4-rack basis. For more information on these global status bits, see the documentation for your programming software.</p> <p>This method requires an extensive and careful review of your system for recovery operations. For more information on inhibiting I/O racks, see the documentation for your programming software.</p>
Fault zone programming method	<p>Using fault zone programming method, you disable sections of your program with MCR zones. Using the status bits, you monitor your racks; when a fault is detected, you control the program through the rungs in your MCR zone. With this method, outputs within the MCR zone must be non-retentive to be de-energized when a rack fault is detected.</p> <p>For more information on MCR zone programming, see the documentation for your programming software.</p>



## Block-Transfers in Fault Routines

If the controller runs a fault routine that contains block-transfer instructions, the controller performs these block-transfers immediately upon completing any block-transfers currently in the active buffer, ahead of block-transfer requests waiting in the queue.

The block-transfers in a fault routine should be between the controller and local I/O only.

<b>ATTENTION</b>	If you program block-transfer instructions to remote chassis within a fault routine, be aware that all ladder scanning will stop until the block transfer either completes or errors.
------------------	---



## Testing a Fault Routine

To test a fault routine, use a JSR instruction to jump to the fault routine. Send a fault code as the first input parameter of the JSR instruction. The controller stores the fault code in S:12 and sets the corresponding bit in S:11.

You can detect and set your own faults by using fault codes 0-9 or by using the controller-defined fault codes 10-87.

## Monitoring Faults

Monitor controller faults using the controller status screen in your programming software.

You can Monitor	Description	See Page
Minor and major faults	Controller faults are categorized into major and minor faults. The controller displays a unique bit for each fault and displays text that describes the fault.	15-12
Fault codes	Fault codes provide information about controller-defined errors.	B-5
Global status bits	Global status bits are set if a fault occurs in any one of the logical racks.	15-13
Multiple chassis status bits	Multiple chassis status bits are used to monitor the racks in your I/O system.	15-13

## Monitoring Major/Minor Faults and Fault Codes

When a fault occurs, the controller status screen in your programming software displays program file and rung number indicators that point to where the fault occurred.

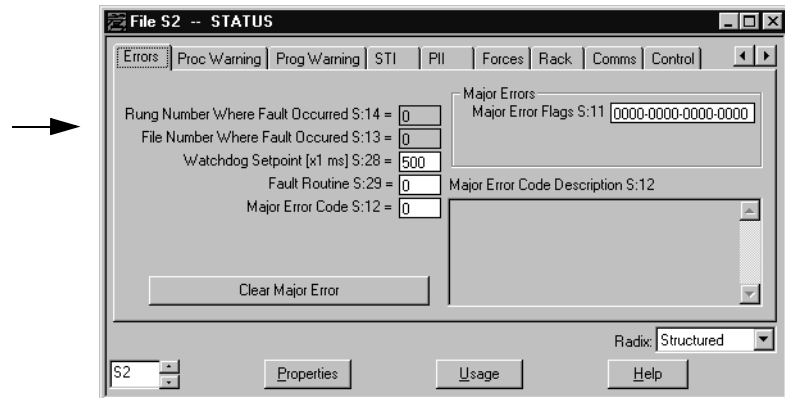

## Interpreting Major Faults

### Displaying a Description of the Major Faults

- The status text that appears corresponds to the most significant fault when the cursor is not on the major fault status word.
- If the cursor is on a major fault word bit and that bit is set, the status text that appears corresponds to the bit that the cursor is on.
- If no bits are set, the message area is blank.

### Clear the Faults by

- Using the clear major-fault-function on the controller status screen of your programming software. When you clear major faults, the fault code, program file, and rung number fields are also cleared.
- Resetting individual bits. If you have more than one major fault and you reset a bit, the status text displays the next major fault message.

For a description of the major faults (S:11), see Appendix B.

## Interpreting Minor Faults

### Displaying a Description of the Minor Faults

- The status text that appears corresponds to the most significant fault when the cursor is not on the minor fault status words.
- If the cursor is on a minor fault word bit and that bit is set, the status text that appears corresponds to the bit that the cursor is on.
- If no bits are set the message area is blank.

### Clear the Faults by

- Using the clear minor-fault-function on the controller status screen of your programming software.
- Resetting individual bits. If you have more than one minor fault and you reset a bit, the status text displays the next minor fault message.

For a description of the minor faults in word 1 (S:10) and word 2 (S:17), see Appendix B.

## Monitoring Status Bits

Two types of status bits display information about your system: global status bits and multiple chassis status bits.

Each bit represents an entire rack, no matter how many chassis make up a rack. (Remember that you can have a maximum of four chassis configured as quarter racks to make up one I/O rack.) These bits are stored in the lower eight bits of words S:7, S:32, and S:34.

The **global status bits** are set if a fault occurs in any one of the racks. See the table below to determine the number of bits.

Controller	Possible I/O Rack Bits
PLC-5/11, -5/20, 5/20E	4
PLC-5/30	8
PLC-5/40, -5/40L, 5/40E	16
PLC-5/60, -5/60L, -5/80, 5/80E	24

The **multiple chassis status bits** are used to monitor the racks in your I/O system. This information is stored in the I/O status file (S:16, low byte) that you specify using the controller configuration screen in your programming software. The software automatically creates an integer data file to store two words of status bits for every rack configured in your system.

For more information on global status bits and multiple chassis status bits, see the documentation for your programming software.

## Notes

## Using Main Control Programs

### Using This Chapter

For Information About	Go to Page
Selecting main control programs	16-1
Understanding how the controller interprets MCPs	16-2
Configuring MCPs	16-3
Monitoring MCPs	16-5

### Selecting Main Control Programs

You can have as many as 16 control programs active at one time. Each of these programs is called a “main control program” (MCP). You can define one MCP for each particular machine or function of your process. This lets you separate sequential function charts (SFCs), ladder logic, and structured text to better modularize your process and make troubleshooting easier.

Consider Using this Technique	If You are
SFC	defining the order of events in the process
Ladder Logic	<ul style="list-style-type: none"> <li>more familiar with ladder logic than with programming languages such as BASIC</li> <li>performing diagnostics</li> </ul>
Structured Text	<ul style="list-style-type: none"> <li>more familiar with programming languages such as BASIC than with ladder logic</li> <li>using complex mathematical algorithms</li> <li>using program constructs that repeat or “loop”</li> <li>creating custom data-table monitoring screens</li> </ul>

A main control program can be an SFC numbered 1-999; it can also be a ladder or structured-text program numbered 2-999 in any program file. You can use any mix of SFC, ladder, and structured-text programs to define 16 main control programs. One data table is used by all MCPs (i.e., you do not have a separate data table for each MCP).

## Understanding How the Controller Interprets MCPs

The MCPs are scheduled to execute in the order in which you specify on the Crocessor Configuration screen. You can configure:

- an I/O image update and housekeeping after each MCP is completed (default parameter), **or**
- the controller to skip the I/O scan and run the next MCP

After the last MCP is completed, all MCPs are then repeated in the same order. Note that the watchdog setpoint covers one scan of all MCPs. The figure below shows how the controller interprets MCPs when an I/O image update is specified to occur after each MCP is completed.

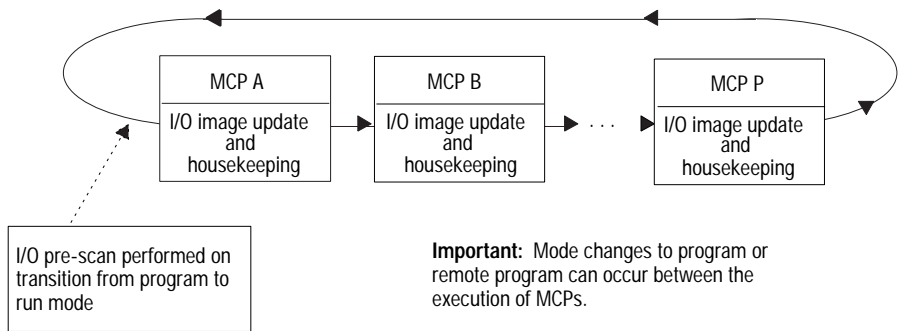

By disabling I/O scans between MCPs, you can gain 2-3 ms of program-scan time per disabled I/O scan. The controller updates your I/O when it reaches the next I/O scan command, which can be:

- an enabled I/O scan between MCPs, **and/or**
- the end of a pass through the entire MCP list.

The controller always performs an I/O scan after a pass through the MCP list.

The following figure shows how the controller skips I/O scans and moves to the next MCP.

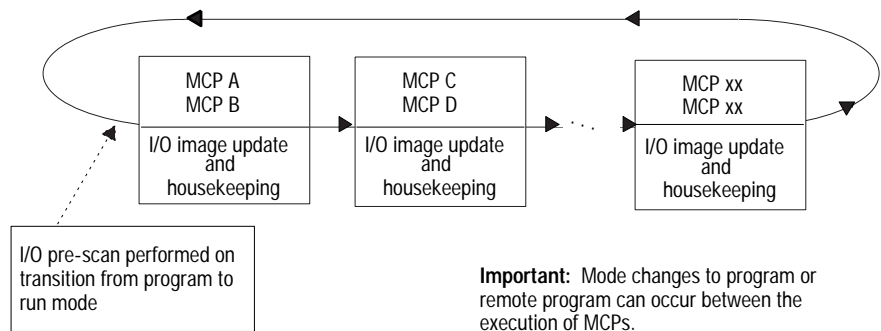

If the MCP is a	The Following Occurs:
Ladder-logic program	<ol style="list-style-type: none"> <li>1.All rungs are executed—from the first rung to the last, with all timers, counters, jumps, and subroutines active.</li> <li>2.After the END instruction in the ladder program, the controller initiates an I/O update—reading local inputs, writing local outputs, reading remote buffers, and writing remote outputs to the buffer.</li> <li>3.The controller starts the next MCP.</li> </ol>
Structured-text program	<ol style="list-style-type: none"> <li>1.Code is executed normally.</li> <li>2.After the last instruction in the program, the controller initiates an I/O update.</li> <li>3.The controller starts the next MCP.</li> </ol>
SFC	<ol style="list-style-type: none"> <li>1.Only the active steps are scanned, and transitions from those active steps are examined.</li> <li>2.After one complete pass through the active steps, the controller initiates an I/O update.</li> <li>3.The controller starts the next MCP.</li> </ol>

## Configuring MCPs

You configure MCPs on the controller configuration screen in your programming software.

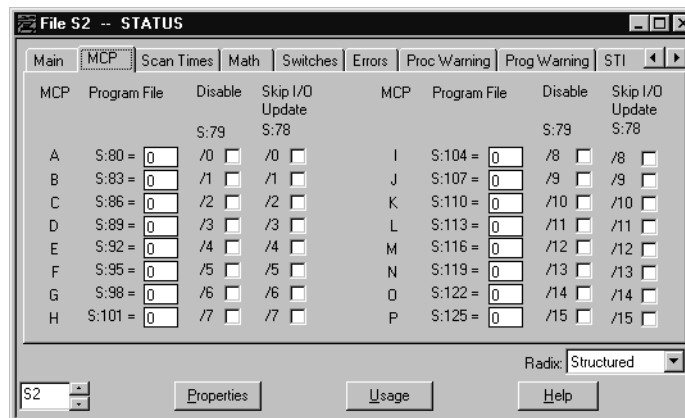

In this Field	Do the Following	Status File
Program file	<p>Specify the program file numbers for MCPs A-P and the order in which the MCPs should be run. This configuration is read before the MCP is executed; if you make a change to the configuration screen regarding an MCP, that change takes effect on the next execution of the MCP. You can change the MCP information on the Controller Configuration screen or through ladder logic.</p> <p>If you specify an MCP file that does not exist or is not a ladder-logic program, structured-text program, or SFC file, a major fault is logged in the status file. A minor fault is also logged if all MCP program files are set to zero.</p> <p>You can have the same program file number specified more than once as an MCP. For example, you may want a program to execute frequently and have a higher priority over other programs.</p> <p>If you do not want to use multiple main programs, program an SFC (program file 1), ladder-logic program (program file 2), or structured-text program (program file 2) and the controller will execute your main program. You do not need to make any entries on the Controller Configuration screen (the controller automatically enters the first configured program file number in the first MCP entry).</p>	S:80-S:127
Disable	<p>By setting or resetting the bit in these fields, you tell the controller to skip over the MCP until the bit is reset. If an MCP program file is inhibited, the controller skips the file and goes to the next program file.</p> <p><b>ATTENTION:</b> If you disable an MCP, outputs remain in the state that they were in during the last scan (i.e., all actions remain active). Make sure that you consider any outputs that might be controlled within that MCP before disabling it. Otherwise, injury to personnel or damage to equipment may result.</p> <p>Disable an MCP if you temporarily want to hold a machine state, regardless of transitions (for example, in machine fault conditions). Disabling an MCP also can help improve scan time; if you know you don't need to run one of your MCPs every scan, you can disable it until you need it.</p> <p>To set and reset the bits for Main Control Programs A-P, cursor to the appropriate field and type 1 to disable (skip) this MCP or 0 to enable (scan) this MCP.</p> <p>If the disable bit is set for all the MCP program files (which indicates that all control programs are to be skipped), a minor fault is logged in the controller status file.</p>	S:79
Skip I/O update	<p>A <b>1</b> in this field tells the controller to skip the I/O scan after this MCP. The default <b>0</b> tells the controller to perform the I/O scan after the corresponding MCP.</p> <p>To specify the I/O bit, cursor to the appropriate field and enter 0 or 1.</p>	S:78



**IMPORTANT**

If you plan to use SFC subcharts, make sure you define something for MCP A - even an empty ladder file is sufficient. If a MCP is undefined, the controller faults on the second SFC scan with major fault code 71 SFC subchart is already executing.

---

## Monitoring MCPs

The program scan times for each MCP are stored in the controller status file, including the previous and maximum scan time. The status file also stores the cumulative scan time, S:8 (the scan time for one complete pass through all MCPs) and the maximum cumulative scan time, S:9.

## Notes

## Using Selectable Timed Interrupts

### Using This Chapter

For Information About	Go to Page
Using a selectable timed interrupt	17-1
Defining a selectable timed interrupt	17-3
Monitoring selectable timed interrupts	17-4

### Using a Selectable Timed Interrupt

A selectable timed interrupt (STI) tells the controller to periodically interrupt program execution (due to elapsed time) to run an STI program once to completion. Then, the controller resumes executing the original program file from where it was interrupted. For example, you might want to use an STI to periodically update analog values for a process control loop or send machine data to a host at scheduled intervals.

### Writing STI Ladder Logic

Follow these guidelines when you write ladder logic for an STI.

- Store the STI program in its own ladder file.
- Make sure that the interrupt interval you specify (in status word S:30) is longer than the execution time of the STI program. If it is not, an STI overlap can occur and the controller sets a minor fault bit at S:10/2.
- Note that the controller's watchdog timer continues to run while the controller runs an STI program.

#### **IMPORTANT**

If the interrupt occurs during the execution of an instruction, the controller stops executing the instruction, scans the interrupt file once to completion, and then resumes executing the instruction. In effect, STI execution is transparent to program execution time unless you specify too short an interval. An interval that is too short can cause the watchdog timer to time out or cause excessively long program scans.

Online editing affects the performance of an STI routine. The STI cannot interrupt the controller while it is managing its memory due to the online edits being made. The STI input must be on for an amount of time slightly greater than the actual time required to complete the online edits. If not, the STI does not execute.

### STI Application Example

Periodically check the status of PLC-5 family controllers on the DH+ communication link. Compare the status of each controller with a file of reference data (see rungs below). Set a bit if a mismatch is found. Perform this comparison once every 800 ms. Assume that another active step retrieves status data from the PLC-5 controllers with a MSG instruction and loads it into a temporary source file (N5:10).

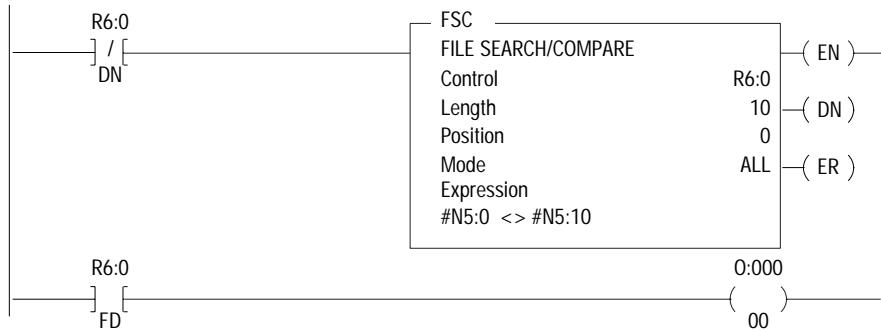

### Block-Transfers in Selectable Timed Interrupts (STIs)

If the controller runs an STI that contains block-transfer instructions, the controller performs these block-transfers immediately on completing any block-transfers currently in the active buffer, ahead of block-transfer requests waiting in the queue.

You can program “immediate” block-transfers to a local I/O chassis using the STI program (i.e., the STI is invoked and the block-transfer occurs immediately). The controller executes the block-transfer immediately, completes the remaining rungs in the STI, then resumes execution of the ladder program.

Set the .TO bit on any block-transfer instruction destined for the same slot as the block-transfer in the STI. These block-transfers only try to execute once so as not to keep the STI from completing.

The block-transfers in an STI should only be between the controller and local I/O. Remote block-transfer instructions in an STI cause the controller to resume executing the user program while waiting for the block-transfer to complete. If you want the STI to run to completion before returning to your main logic program, include an UID and UIE instruction pair in your STI program file. Place the block-transfer instruction inside of a UID/UIE pair.

**ATTENTION**

When the controller runs an STI with a block-transfer instruction to a remote chassis, the MCP resumes processing while waiting for the block-transfer to complete unless a UIE/UID instruction pair is used.

## Defining a Selectable Timed Interrupt

To configure a selectable timed interrupt, you must specify:

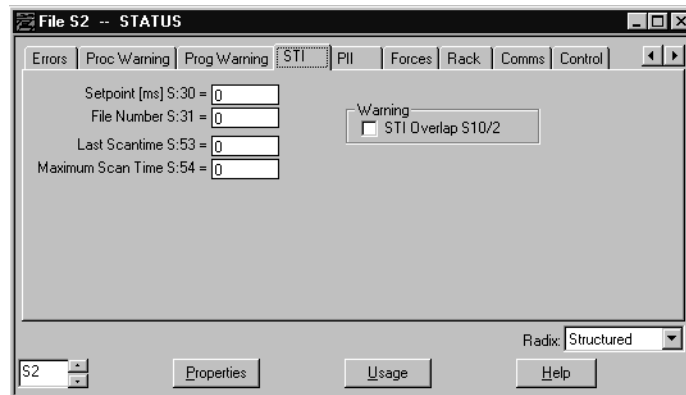

In this Field	Do the Following	Status File
Setpoint	Enter the time interval between interrupts (1 to 32767 ms).  If you are not using or want to disable an STI, enter zero.  <b>Important:</b> Remember to specify an interrupt time longer than the STI file execution time. If you do not, the controller sets a minor fault (S:10, bit 2).	S:30
File number	Enter the number of the program file that contains the STI program.  If you are not using an STI, enter zero.	S:31

For example, you could enter a 7 in S:31 and a 15 in S:30. This causes the controller to execute ladder file 7 every 15 ms.

You can use only one STI at any one time. However, you can enable or disable the interrupt, change to a different interrupt file, or change the time between interrupts. Use ladder logic to change the values in word S:30 and word S:31 as needed.

**ATTENTION**



STI programs lengthen the program scan by an amount equal to the interrupt delay multiplied by the number of times the interrupt occurs during a program scan.

**IMPORTANT**

If you disable the STI through ladder logic (write a 0 to S:30), it could take the controller up to 100 ms to re-enable the STI. If you disable the STI (write a 0 to S:31), the controller uses the value in S:30 to determine how often to check for a non-zero value in S:31.

## Monitoring Selectable Timed Interrupts

Use the controller status screen in your programming software to monitor STIs.

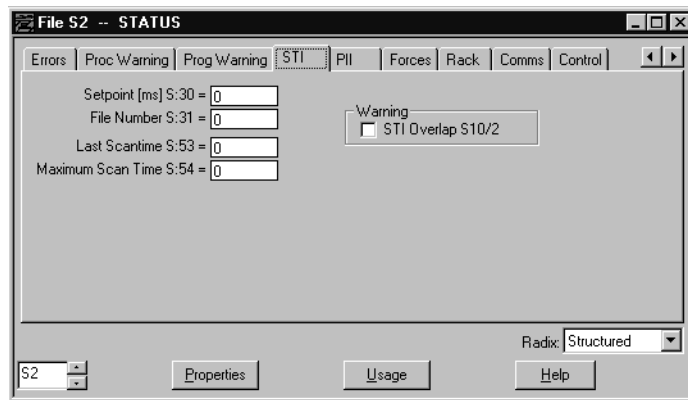

In this Field	Do the Following	Status File
Last scan time	This field displays the time it took for the current or last scan of the STI.	S:53
Maximum scan time	This field displays the longest time that was ever displayed in the Last scan field for the specific STI.	S:54
STI Overlap	This box is checked if an STI overlap occurs. This condition results if the interrupt interval you specify for the setpoint is shorter than the execution time of the STI program.	S:10/2

---

## Using Processor Input Interrupts

### Using This Chapter

For Information About	Go to Page
Using a processor input interrupt	18-1
Defining a processor input interrupt	18-5
Monitoring processor input interrupts	18-5

### Using a Processor Input Interrupt

A processor input interrupt (PII) specifies when an event-driven input causes the controller to interrupt program execution and run a PII program file once to completion. Afterwards, the controller resumes executing the program file from where it was interrupted. Use PIIs only for inputs in the controller-resident chassis.

You can use a processor input interrupt (PII) as an event-driven interrupt or in high-speed processing applications. For example, you may need to count inputs quickly to track production, such as in a canning line. Or, use a PII if your application calls for an immediate input update when a part is seen on a conveyor and you need to do an immediate output update to perform the next action. For example, when a part moving down a conveyor line is detected, you may need to stop it so the next piece can be added.

Your PII program can contain immediate update instructions to complete high-speed control functions. As your ladder program is running and the input condition occurs, the controller interrupts program execution and runs the PII program file. Then, the controller resumes executing the program file from the point where it was interrupted.

## Writing PII Ladder Logic

Follow these rules when you write ladder logic for a PII.

- Store the PII program in a ladder file.
- Make sure the input condition (to cause the interrupt) doesn't occur faster than the execution time of the PII program. If a second identical input condition occurs before the interrupt program has finished executing for the first input condition, a PII overlap occurs and the controller sets a minor fault bit at S:10/12.

The timing for a PII is as follows:

–1 ms to switch to the PII task

–PII ladder logic execution time

–1 ms to return to executing the control program

Since you need to allow at least 1 ms to run your PII logic, define a PII time of at least 3 ms to help prevent PII overlaps.

- The controller's watchdog timer continues to run while running a PII program.
- A PII can detect an event within 100  $\mu$ s; however, you must allow at least 3 ms between successive PII events.

## PII Application Examples

Two ways that you can use a PII program:

Mode	Description
Counter	Using counter mode, you make use of the controller's internal counter. You configure the PII with a preset value so that the hardware counts an input condition and then runs the PII when the preset equals the accumulated value. The PII ladder logic only needs to contain the output that you want to occur.
Bit transition	Using bit-transition mode, you configure the PII to occur every time the input condition is true. For example, you want to count tablets as they leave the production line at a rate of 100 tablets per second. The machinery packs 100 tablets per package. Assume an optical switch detects each tablet.



As shown in the following figure, the PII program must:

- count 100 tablets per group
- set an output at the 100th tablet
- reset the counter for the next group

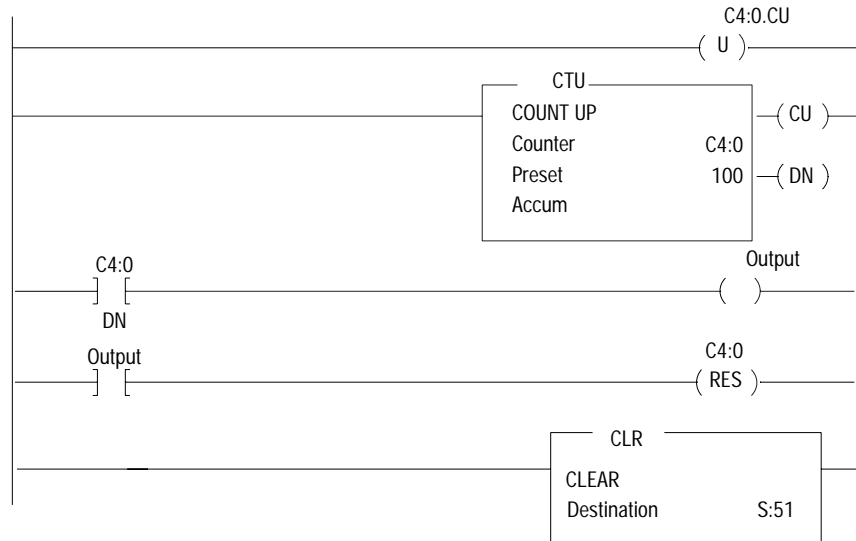

The output image bit remains set until the next count.

## Block-Transfers in Processor Input Interrupts (PIIs)

If the controller runs a PII that contains block-transfer instructions, the controller performs these block-transfers immediately on completing any block-transfers currently in the active buffer, ahead of block-transfer requests waiting in the queue.

You can program “immediate” block-transfers to a local I/O chassis using the PII program (i.e., the PII is invoked and the block-transfer occurs immediately). The controller executes the block-transfer immediately, completes the remaining rungs in the PII, then resumes execution of the ladder program.

You can use the PII for a block-transfer to remote I/O. Remote block-transfer instructions in a PII cause the controller to resume executing user programs, while waiting for the block-transfer to complete. If you want the PII to run to completion before returning to your main logic program, include a UID and UIE instruction pair in your PII program file. Place the block-transfer instruction inside of a UID/UIE pair.

**IMPORTANT**

When the controller runs a PII with a block-transfer instruction to a remote chassis, the MCP resumes processing while waiting for the block-transfer to complete unless a UIE/UID instruction pair is used.

---

PII configuration changes are not put into effect until the controller goes from program to run or test mode.

## Design Considerations

Consider the following guidelines when planning PIIs.

- Do not use 2-slot addressing when using PIIs.
- Do not use 1771-IG or -IGD, 8- and 16-point TTL modules for the PII. Use the 1771-IQ16 input module instead. Since the module's input delay filter is selectable, you can set the delay to 0 or about 200 ms.
- Avoid using a block-transfer module in the controller-resident rack with a PII configured because you could miss an input pulse while a block-transfer of data is in progress. However, if you need to use block-transfers, make sure that a PII input pulse is at least 400 ms, which causes the block-transfer not to affect the PII.
- Online editing affects the performance of a PII routine. A PII cannot interrupt the controller while it is managing its memory due to the online edits being made. The PII input must be on for an amount of time slightly greater than the actual time required to complete the online edits. If not, the PII does not execute.
- Clear S:51 in one of two ways:
  - using a CLR instruction (see <sup>2</sup>)
  - placing a MOV (move) instruction on the last rung in the PII file. Move a 0 into S:51 to reset the PII bits before finishing the PII file.

**IMPORTANT**

If S:51 is not cleared, a PII overlap bit is set on that status page, causing a minor fault.

---

## Defining a Controller Input Interrupt

To define a PII, use the controller configuration screen in your programming software.

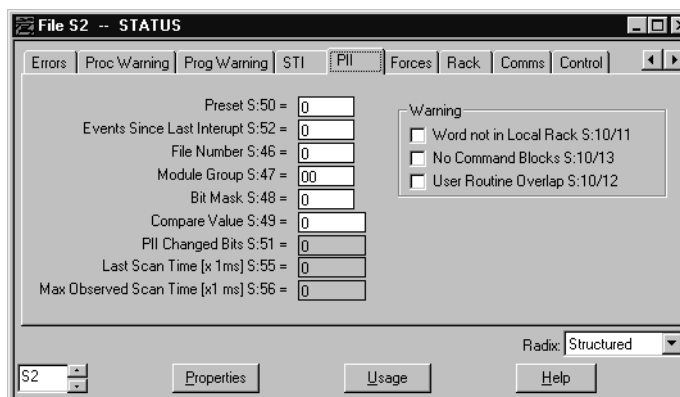

In this PII Configuration Field	Do the Following	Status File Address
Preset	Enter a preset value to determine how many conditions you want to occur before the interrupt. Valid range is 0 - 32,767.  If you want the interrupt to occur every time, enter a 0 or 1.	S:50
File number	Enter the number of the program file that contains the PII program.  This is the only PII parameter that you can change while the controller is in RUN mode.	S:46
Module group	Enter the assigned rack number and I/O group number of the input to monitor (e.g., 21 for rack 2, group 1). Do not enter the address. (Only for inputs in the controller-resident chassis).  If the input word number specified is not in the local rack or if there is not an input module in the slot addressed, a minor fault bit (S:10/11) is set at mode transition.	S:47
Bit mask	Each module group (specified in S:47) has a control bit that is used to monitor the input bit.  <ul style="list-style-type: none"> <li>To monitor the bit, enter a 1.</li> <li>To ignore the bit, enter a 0.</li> </ul>	S:48
Compare value	Each module group (specified in S:47) has a bit that is used when controlling a PII through bit transition.  <ul style="list-style-type: none"> <li>For a false to true transition to count (bit trigger), enter a 1.</li> <li>For a true to false transition to count (event trigger), enter a 0.</li> </ul>	S:49

### IMPORTANT

If you change the PII configuration while in run mode, you must toggle the mode to program, then back to run mode for the change to take effect.

## Monitoring Controller Input Interrupts

Use the controller status screen in your programming software to monitor PIIs.

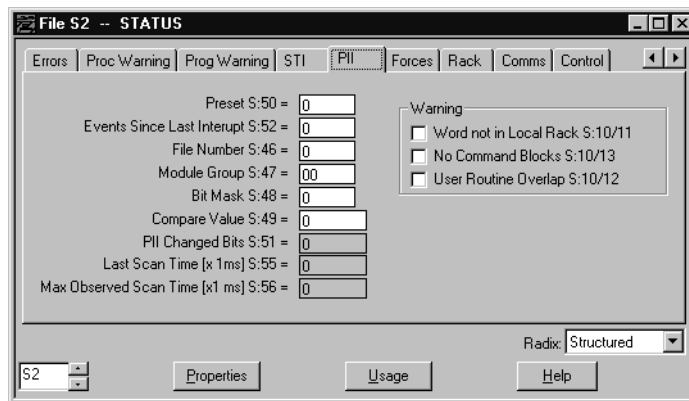

This PII Field	Stores	Status File Address
Events since last interrupt	Displays the number of PII events (the input conditions that caused the interrupt) since the last interrupt.	S:52
PII changed bits	Displays the bit transitions that caused the interrupt. You can use this information to condition other rungs in your ladder program.  If one of these bits is already set (i.e., a previous interrupt set the bit), the controller sets a minor fault (S:10/2) to indicate a possible PII overlap. If you want to monitor this overlap, make sure the last rung in your PII program clears this return mask in the status file.	S:51
Last scan time	Displays the current or last scan time through the PII.	S:55
Max observed scan time	Displays the maximum value that was displayed in the last scan field.	S:56
Word not in local rack	This box is checked if the input word number specified is not on the local rack or if there is not an input module in the slot addressed.	S:10/11
No command blocks	This box is checked if no command blocks exist to get the PII. You can use the controller's internal counter or bit transition to execute the PII.	S:10/13
User routine overlap	This box is checked if a set condition exists in the PII return mask or changed bits (possibly set by a previous interrupt) before completing the currently executing PII routine. PII changed bits are retentive. It may be necessary to place a MOV instruction on the last rung in the PII file. Move 0 in S:51 to reset the PII bits before finishing the PII file. If this is not done, a PII overlap bit will be set on that status page, causing this minor fault.	S:10/12

Use S:51/0-15 within the PII file because these bits are:

- mapped from the actual input module being used for the PII
- retentive

For the PII routine to execute properly, do not use the addresses of the input module's bits within the PII routine.

## System Specifications

### Controller Specifications

For all controller-related specifications, please refer to the related installation instructions:

- Enhanced PLC-5 Controllers Installation Instructions, publication 1785-IN062
- Ethernet PLC-5 Programmable Controllers Installation Instructions, publication 1785-IN063

To get this documentation, you can either:

- view or download an electronic version from the internet at [www.rockwellautomation.com/literature](http://www.rockwellautomation.com/literature)
- contact your local distributor or Rockwell Automation representative to place an order

## Memory and Channel Specifications

Controller/ Cat. No.	Maximum User Memory Words	Total I/O Maximum (Any Mix)	Types of Communication Ports	Maximum Number of I/O Racks (Rack Addresses)	Maximum Number of I/O Chassis		
					Total	Ext Local	Remote
PLC-5/11 (1785-L11B)	8 K	512 (any mix) or 384 in + 384 out (complementary)	1 DH+/Remote I/O (Adapter or Scanner)  1 serial port, configurable for RS-232 and 423 and RS-422A compatible	4 (0-3)	5	0	4 (must be rack 3)
PLC-5/20 (1785-L20B)  PLC-5/26 (1785-L26B)	16K	512 (any mix) or 512 in + 512 out (complementary)	1 DH+ (Fixed)  1 DH+/Remote I/O (Adapter or Scanner)  1 serial port, configurable for RS-232 and 423 and RS-422A compatible	4 (0-3)	13	0	12
PLC-5/20E (1785-L20E)	16K	512 (any mix) or 512 in + 512 out (complementary)	1 DH+ (Fixed)  1 DH+/Remote I/O (Adapter or Scanner)  1 serial port, configurable for RS-232 and 423 and RS-422A compatible  1 channel Ethernet only	4 (0-3)	13	0	12
PLC-5/30 (1785-L30B)	32 K	1024 (any mix) or 1024 in and 1024 out (complementary)	2 DH+/Remote I/O (Adapter or Scanner)  1 serial port, configurable for RS-232 and 423 and RS-422A compatible	8 (0-7)	29	0	28
PLC-5/40 (1785-L40B)  PLC-5/46 (1785-L46B)	48 K <sup>(1)</sup>	2048 (any mix) or 2048 in + 2048 out (complementary)	4 DH+/Remote I/O (Adapter or Scanner)  1 serial port, configurable for RS-232 and 423 and RS-422A compatible	16 (0-17)	61	0	60
PLC-5/40E (1785-L40E)	48 K <sup>1</sup>	2048 (any mix) or 2048 in + 2048 out (complementary)	2 DH+/Remote I/O (Adapter or Scanner)  1 channel Ethernet only  1 serial port, configurable for RS-232 and 423 and RS-422A compatible	16 (0-17)	61	0	60
PLC-5/40L (1785-L40L)	48 K <sup>1</sup>	2048 (any mix) or 2048 in + 2048 out (complementary)	2 DH+/Remote I/O (Adapter or Scanner)  1 serial port, configurable for RS-232 and 423 and RS-422A compatible  1 Extended-Local I/O	16 (0-17)	61	16	60

Controller/ Cat. No.	Maximum User Memory Words	Total I/O Maximum (Any Mix)	Types of Communication Ports	Maximum Number of I/O Racks (Rack Addresses)	Maximum Number of I/O Chassis		
PLC-5/60 (1785-L60B)	64 K <sup>(2)</sup>	3072 (any mix) or 3072 in + 3072 out (complementary)	4 DH+/Remote I/O (Adapter or Scanner)  1 serial port, configurable for RS-232 and 423 and RS-422A compatible	24 (0-27)	93	0	92
PLC-5/60L (1785-L60L)	64 K <sup>2</sup>	3072 (any mix) or 3072 in + 3072 out (complementary)	2 DH+/Remote I/O (Adapter or Scanner)  1 serial port, configurable for RS-232 and 423 and RS-422A compatible  1 Extended Local I/O	24 (0-27)	81	16	64
PLC-5/80 (1785-L80B)  PLC-5/86 (1785-L86B)	100 K <sup>(3)</sup>	3072 (any mix) or 3072 in + 3072 out (complementary)	4 DH+/Remote I/O (Adapter or Scanner)  1 serial port, configurable for RS-232 and 423 and RS-422A compatible	24 (0-27)	93	0	92
PLC-5/80E (1785-L80E)	100 K <sup>3</sup>	3072 (any mix) or 3072 in + 3072 out (complementary)	2 DH+/Remote I/O (Adapter or Scanner)  1 serial port, configurable for RS-232 and 423 and RS-422A compatible  1 channel Ethernet only	24 (0-27)	65	0	64

<sup>1</sup> The PLC-5/40, -5/40E, -5/40L controllers have a limit of 32K words per data table file.

<sup>2</sup> The PLC-5/60 and -5/60L controllers have a limit of 56K words per program file and 32K words per data table file.

<sup>3</sup> The PLC-5/80, -5/80E controllers have 64K words of total data table space with a limit of 56K words per program file and 32K words per data table file.

## Battery Specifications

Enhanced and Ethernet PLC-5 programmable controllers use 1770-XYC batteries that contain 0.65 grams of lithium.

In these Controllers	At this Temperature	Battery Life Estimates		
		Power Off 100%	Power Off 50%	Battery Duration After the LED Lights <sup>1</sup>
PLC-5/11B, -5/20B and -5/20E	60°C	256 days	1.4 years	11.5 days
	25°C	2 years	4 years	47 days
PLC-5/30B -5/40B, -5/40E, -5/40L, -5/60B, -5/60L, -5/80B and -5/80E	60°C	84 days	150 days	5 days
	25°C	1 year	1.2 years	30 days

<sup>1</sup> The battery indicator (BATT) warns you when the battery is low. These durations are based on the battery supplying the only power to the controller (power to the chassis is off) once the LED first lights.

## Memory Backup Devices

You can add an EEPROM to the PLC-5 controller to provide backup memory for your program in case the controller loses power. These memory cards are available:

Catalog Number	For This Product	Memory Size
1785-ME16	Enhanced PLC-5 controllers	16K words
1785-ME32	Enhanced PLC-5 controllers	32K words
1785-ME64	Enhanced PLC-5 controllers	64K words
1785-ME100	Enhanced PLC-5 controllers	100K words

Use your programming software to save a program currently in the controller to the EEPROM card. If you restore a program from the EEPROM to controller memory and controller memory is bad, the restore changes the date and time in the controller status file to the date and time the EEPROM was saved. If you restore a program from the EEPROM to controller memory and controller memory is valid, the status file retains its current date and time.

## EEPROM Compatibility

EEPROM compatibility is related to:



Area	Description
ControlNet PLC-5 controllers	<p>EEPROM memory cannot be loaded to a non-ControlNet PLC-5 controller if the EEPROM was saved on a ControlNet PLC-5 controller.</p> <p>EEPROM memory cannot be loaded to a ControlNet PLC-5 controller if the EEPROM was burned on a non-ControlNet PLC-5 controller.</p>
PLC-5 catalog numbers	<p>EEPROM memory can be loaded to a PLC-5 controller if its I/O memory size is greater than or equal to the I/O memory of the PLC-5 controller from which the EEPROM was saved. The I/O memory sizes are:</p> <p>PLC-5/11, -5/204 racks  PLC-5/308 racks  PLC-5/4016 racks  PLC-5/60, -5/8024 racks</p> <p>EEPROM memory can be loaded to a PLC-5 controller if its user memory is greater than or equal to the user memory used on the PLC-5 controller from which the EEPROM was saved. The available user memory is:</p> <p>PLC-5/118,192 words  PLC-5/2016,384 words  PLC-5/3032,768 words  PLC-5/4065,536 words  PLC-5/80102,400 words</p>
Firmware release compatibility	<p>EEPROM memory saved on a series D, revision B PLC-5 controller cannot be loaded on a PLC-5 controller with an earlier firmware release.</p> <p>EEPROM memory saved on a series E, revision A PLC-5 controller cannot be loaded on a PLC-5 controller with an earlier firmware release.</p> <p>EEPROM memory saved on a series E, revision B PLC-5 controller cannot be loaded on a PLC-5 controller with an earlier firmware release.</p>

## Notes

## Processor Status File

Processor status data is stored in data file 2.

**IMPORTANT**

For more information about any of these topics, see the description in this manual or the documentation for your programming software.

### S:0 - S:2

This Word	Stores
S:0	Arithmetic flags <ul style="list-style-type: none"> <li>• bit 0 = carry</li> <li>• bit 1 = overflow</li> <li>• bit 2 = zero</li> <li>• bit 3 = sign</li> </ul>
S:1	Processor status and flags
S:1/00	RAM checksum is invalid at power-up
S:1/01	Controller in run mode
S:1/02	Controller in test mode
S:1/03	Controller in program mode
S:1/04	Controller uploading to memory module
S:1/05	Controller in download mode
S:1/06	Controller has test edits enabled
S:1/07	Mode select switch in REMOTE position
S:1/08	Forces enabled
S:1/09	Forces present
S:1/10	Controller controllerr successfully uploaded to memory module
S:1/11	Performing online programming
S:1/12	Not defined
S:1/13	User program checksum calculated
S:1/14	Last scan of ladder or SFC step
S:1/15	Controller running first program scan or the first scan of the next step in an SFC

This Word	Stores
S:2Switch setting information	
S:2/00 through S:2/05	Channel 1A DH+ station number
S:2/06	Channel 1A DH+ baud rate  057.6 kbps  1230.4 kbps
S:2/07 S:2/08	Not defined
S:2/09	Last state  0outputs are turned off  1outputs retain last state
S:2/11 S:2/12	I/O chassis addressing  <u>bit 12bit 11</u> 00illegal 101/2-slot 011-slot 112-slot
S:2/13 S:2/14	Memory module transfer  <u>bit 14bit 13</u> 00memory module transfers to controller memory if controller memory is not valid 01memory module does not transfer to controller memory 11memory module transfers to controller memory at powerup
S:2/15	Controllercontroller memory protection  0enabled  1disable

**S:3-10**

<b>This Word</b>	<b>Stores</b>
S:3 to S:6	Active Node table for channel 1A <u>WordBitsDH+ Station #</u> 30-1500-17 40-1520-37 50-1540-57 60-1560-77
S:7	Global status bits: (See also S:27, S:32, S:33, S:34, and S:35)  <ul style="list-style-type: none"> <li>• S:7/0-7      rack fault bits for racks 0-7</li> <li>• S:7/8-15     unused</li> </ul>
S:8	Last program scan (in ms)
S:9	Maximum program scan (in ms)
S:10	Minor fault (word 1) See also S:17
S:10/00	Battery is low (replace in 1-2 days)
S:10/01	DH+ active node table has changed
S:10/02	STI delay too short, interrupt program overlap
S:10/03	memory module transferred at power-up
S:10/04	Edits prevent SFC continuing; data table size changed during program mode; reset automatically in run mode
S:10/05	Invalid I/O status file
S:10/06	reserved
S:10/07	No more command blocks exist to execute block-transfers
S:10/08	Not enough memory on the memory module to upload the program from the controller
S:10/09	No MCP is configured to run
S:10/10	MCP not allowed
S:10/11	PII word number not in local rack
S:10/12	PII overlap
S:10/13	no command blocks exist to get PII
S:10/14	Arithmetic overflow
S:10/15	SFC "lingering" action overlap - step was still active when step was reactivated

## S:11

<b>This Word</b>	<b>Stores</b>
S:11major fault word	
S:11/00	Corrupted program file (codes 10-19). See major fault codes (S:12).
S:11/01	Corrupted address in ladder program (codes 20-29). See major fault codes (S:12).
S:11/02	Programming error (codes 30-49). See major fault codes (S:12).
S:11/03	Controller detected an SFC fault (codes 71-79). See major fault codes (S:12).
S:11/04	Controller detected an error when assembling a ladder program file (code 70); duplicate LBLs found.
S:11/05	Start-up protection fault. The controller sets this major fault bit when powering up in Run mode if the user control bit S:26/1 is set.
S:11/06	Peripheral device fault
S:11/07	User-generated fault; controller jumped to fault routine (codes 0-9). See major fault codes (S:12).
S:11/08	Watchdog faulted
S:11/09	System configured wrong (codes 80-82, 84-88, 200-208). See major fault codes (S:12).
S:11/10	Recoverable hardware error
S:11/11	MCP does not exist or is not a ladder or SFC file
S:11/12	Pll file does not exist or is not a ladder file
S:11/13	STI file does not exist or is not a ladder file
S:11/14	Fault routine does not exist or is not a ladder file
S:11/15	Faulted program file does not contain ladder logic

**S:12**

This word stores the following fault codes:

This Fault Code	Indicates this Fault	And the Fault Is
00-09	Reserved for user-defined fault codes.  You can use user-defined fault codes to identify different types of faults or error conditions in your program by generating your own recoverable fault. To use these fault codes, choose an input condition that decides whether to jump to a fault routine file, then use the JSR instruction as the means to jump to the fault routine file.  To use the JSR instruction, enter the fault code number 0-9 (an immediate value) as the first input parameter of the instruction. Any other input parameters are ignored (even if you have an SBR instruction at the beginning of your fault routine file. You cannot pass parameters to the fault routine file using JSR/SBR instructions).  You do not have to use the user-defined fault codes to generate your own fault. If you program a JSR with no input parameters, the controller will write a zero to the Fault Code field. The purpose of using the user-defined fault codes is to allow you to distinguish among <b>different</b> types of faults or error codes based on the 0-9 fault code numbers.  When the input condition is true, the controller copies the fault code number entered as the first input parameter of the JSR instruction into word 12 of the processor status file (S:12), which is the Fault Code field. The controller sets a Major Fault S:11/7 "User-Generated Fault." The controller then faults unless you clear the Major Fault word (S:11) or the specific fault bit via ladder logic in the fault routine.	Recoverable:  The fault routine can instruct the controller to clear the fault and then resume scanning the program.  A fault routine executes when any of these faults occur.
10	Run-time data table check failed	Recoverable:  The fault routine can instruct the controller to clear the fault and then resume scanning the program.
11	Bad user program checksum	
12	Bad integer operand type, restore new controller memory file	
13	Bad mixed mode operation type, restore new controller memory file	
14	Not enough operands for instruction, restore new controller memory file	
15	Too many operands for instructions, restore new controller memory file	
16	Corrupted instruction, probably due to restoring an incompatible controller memory file (bad opcode)	
17	Can't find expression end; restore new controller memory file	
18	Missing end of edit zone; restore new controller memory file	
19	Download aborted	
20	You entered too large an element number in an indirect address	Recoverable
21	You entered a negative element number in an indirect address	
22	You tried to access a non-existent program file	
23	You used a negative file number, you used a file number greater than the number of existing files, or you tried to indirectly address files 0, 1, or 2	
24	You tried to indirectly address a file of the wrong type	

<b>This Fault Code</b>	<b>Indicates this Fault</b>	<b>And the Fault Is</b>
30	You tried to jump to one too many nested subroutine files	Non-recoverable
31	You did not enter enough subroutine parameters	The fault routine will be executed but cannot clear major fault bit 2.
32	You jumped to an invalid (non-ladder) file	
33	You entered a CAR routine file that is not 68000 code	
34	You entered a negative preset or accumulated value in a timer instruction	Recoverable
35	You entered a negative time variable in a PID instruction	
36	You entered an out-of-range setpoint in a PID instruction	
37	You addressed an invalid module in a block-transfer, immediate input, or immediate output instruction	
38	You entered a RET instruction from a non-subroutine file	Non-recoverable
39	FOR instruction with missing NXT	The fault routine will be executed but cannot clear major fault bit 2.
40	The control file is too small for the PID, BTR, BTW, or MSG instruction	Recoverable
41	NXT instruction with missing FOR	Non-recoverable
42	You tried to jump to a non-existent label	The fault routine will be executed but cannot clear major fault bit 2.
43	File is not an SFC	
44	Error using SFR. This error occurs if: <ul style="list-style-type: none"> <li>• you tried to reset into a simultaneous path</li> <li>• you specified a step reference number that is not found or is not tied to a step (it is a transition)</li> <li>• the previous SFR to a different step is not complete</li> </ul>	
45	Invalid channel number entered	Recoverable
46	Length operand of IDI or IDO instruction is greater than the maximum allowed	
47	SFC action overlap. An action was still active when the step became re-activated	
		Non-recoverable. The fault routine will be executed but cannot clear major fault bit 2.



<b>This Fault Code</b>	<b>Indicates this Fault</b>	<b>And the Fault Is</b>
70	The controller detected duplicate labels	Non-recoverable
71	The controller tried to start an SFC subchart that is already running	
72	The controller tried to stop an SFC subchart that isn't running	
73	The controller tried to start more than the allowed number of subcharts	
74	SFC file error detected	
75	The SFC has too many active functions	
76	SFC step loops back to itself.	
77	The SFC references a step, transition, subchart, or SC file that is missing, empty or too small	
78	The controller cannot continue to run the SFC after power loss	
79	You tried to download an SFC to a controller that cannot run SFCs	
80	You have an I/O configuration error	
81	You illegally set an I/O chassis backplane switch by setting both switch 4 and 5 on	
82	Illegal cartridge type for selected operation. This error also occurs if the controller doesn't have a memory module, but the backplane switches are set for a memory module. Make sure the backplane switches are correct (set switch 6 ON and switch 7 OFF if the controller doesn't have a memory module).	
83	User watchdog fault	Recoverable
84	Error in user-configured adapter mode block-transfer	Non-recoverable
85	Memory module bad	
86	Memory module is incompatible with host	Non-recoverable
87	Scanner rack list overlap	
88	Scanner channels are overloading the remote I/O buffer; too much data for the controller to process. If you encounter fault code 88, be sure you followed the design guidelines listed on page 4-9. Specifically, make sure you: <ul style="list-style-type: none"> <li>• group together 1/4-racks and 1/2-racks of each logical rack. Do not intersperse these with other rack numbers</li> <li>• if using complementary I/O addressing, treat complementary rack addresses individually when grouping racks; primary rack numbers are separate from complement rack numbers</li> </ul>	

This Fault Code	Indicates this Fault	And the Fault Is
90	Sidecar module extensive memory test failed. Call your Allen-Bradley representative for service	Recoverable
91	Sidecar module undefined message type	
92	Sidecar module requesting undefined pool	
93	Sidecar module illegal maximum pool size	
94	Sidecar module illegal ASCII message	
95	Sidecar module reported fault, which may be the result of a bad sidecar program or of a hardware failure	
96	Sidecar module not physically connected to the PLC-5 controller	
97	Sidecar module requested a pool size that is too small for PC <sup>3</sup> command (occurs at power-up)	
98	Sidecar module first/last 16 bytes RAM test failed	
99	Sidecar module-to-controller data transfer faulted	
100	Controller-to-sidecar module transfer failed	
101	Sidecar module end of scan transfer failed	
102	The file number specified for raw data transfer through the sidecar module is an illegal value	
103	The element number specified for raw data transfer through the sidecar module is an illegal value	
104	The size of the transfer requested through the sidecar module is an illegal size	
105	The offset into the raw transfer segment of the sidecar module is an illegal value	
106	Sidecar module transfer protection violation; for PLC-5/26, -5/46, and -5/86 controllers only	

**S:13-S:24**

<b>This Word:</b>	<b>Stores</b>
S:13	Program file where fault occurred
S:14	Rung number where fault occurred
S:15	VME status file
S:16	I/O status File
S:17	Minor fault (word 2) See also S:10.
S:17/00	BT queue full to remote I/O
S:17/01	Queue full - channel 1A; maximum remote block-transfers used
S:17/02	Queue full - channel 1B; maximum remote block-transfers used
S:17/03	Queue full - channel 2A; maximum remote block-transfers used
S:17/04	Queue full - channel 2B; maximum remote block transfers used
S:17/05	No modem on serial port
S:17/06	<ul style="list-style-type: none"> <li>• Remote I/O rack in local rack table or</li> <li>• Remote I/O rack is greater than the image size. This fault can also be caused by the local rack if the local rack is set for octal density scan and the I/O image tables are smaller than 64 words (8 racks) each.</li> </ul>
S:17/07	Firmware revision for channel pairs 1A/1B or 2A/2B does not match controller firmware revision
S:17/08	ASCII instruction error
S:17/09	Duplicate node address
S:17/10	DF1 master poll list error
S:17/11	Protected controller data table element violation
S:17/12	Protected controller file violation
S:17/13	Using all 32 ControlNet MSGs
S:17/14	Using all 32 ControlNet 1771 READ and/or 1771 WRITE CIOs
S:17/15	Using all 8 ControlNet Flex I/O CIOs
S:18	Controller clock year
S:19	Controller clock month
S:20	Controller clock day
S:21	Controller clock hour
S:22	Controller clock minute
S:23	Controller clock second
S:24	Indexed addressing offset
S:25	Reserved

## S:26-S:35

This Word	Stores
S:26 User control bits	
S:26/00	Restart/continuous SFC: when reset, controller restarts at first step in SFC. When set, controller continues with active step after power loss or change to RUN
S:26/01	Start-up protection after power loss: when reset, no protection. When set, controller sets major fault bit S:11/5 when powering up in run mode.
S:26/02	Define the address of the local rack: when reset, local rack address is 0. When set, local rack address is 1.
S:26/03	Set complementary I/O (series A only): when reset, complementary I/O is not enabled. When set, complementary I/O is enabled.
S:26/04	Local block-transfer compatibility bit: when reset, normal operation. When set, eliminates frequent checksum errors to certain BT modules.
S:26/05	PLC-3 scanner compatibility bit: when set (1), adapter channel response delayed by 1 ms; when reset (0) operate in normal response time.
S:26/06	Data table-modification inhibit bit. When set (1), user cannot edit the data table or modify forces while the controller keyswitch is in the RUN position. You control this bit with your programming software
S:26/07 through S:26/15	Reserved
S:27	Rack control bits: (See also S:7, S:32, S:33, S:34, and S:35) <ul style="list-style-type: none"> <li>• S:27/0-7 - - I/O rack inhibit bits for racks 0-7</li> <li>• S:27/8-15 - - I/O rack reset bits for racks 0-7</li> </ul>
S:28	Program watchdog setpoint
S:29	Fault routine file
S:30	STI setpoint
S:31	STI file number
S:32	Global status bits: (See also S:7, S:27, S:33, S:34, and S:35) <ul style="list-style-type: none"> <li>• S:32/0-7 rack fault bits for racks 10-17 (octal)</li> <li>• S:32/8-15 unused</li> </ul>
S:33	Rack control bits: (See also S:7, S:27, S:32, S:34, and S:35) <ul style="list-style-type: none"> <li>• S:33/0-7 I/O rack inhibit bits for racks 10-17</li> <li>• S:33/8-15 I/O rack reset bits for racks 10-17</li> </ul>
S:34	Global status bits: (See also S:7, S:27, S:32, S:33, and S:35) <ul style="list-style-type: none"> <li>• S:34/0-7 rack fault bits for racks 20-27 (octal)</li> <li>• S:34/8-15 unused</li> </ul>
S:35	Rack control bits: (See also S:7, S:27, S:32, S:33, and S:34) <ul style="list-style-type: none"> <li>• S:35/0-7 I/O rack inhibit bits for racks 20-27</li> <li>• S:35/8-15 I/O rack reset bits for racks 20-27</li> </ul>

**IMPORTANT**

Setting inhibit bits in the processor status file (S:27, S:33, or S:35) does not update inhibit bits in the I/O status file.

**S:36-S:78**

<b>This Word</b>	<b>Stores</b>
S:36 - S:45	Reserved
S:46	PII program file number
S:47	PII module group
S:48	PII bit mask
S:49	PII compare value
S:50	PII down count
S:51	PII changed bit
S:52	PII events since last interrupt
S:53	STI scan time (in ms)
S:54	STI maximum scan time (in ms)
S:55	PII last scan time (in ms)
S:56	PII maximum scan time (in ms)
S:57	User program checksum
S:58	Reserved
S:59	Extended-local I/O channel discrete transfer scan (in ms)
S:60	Extended-local I/O channel discrete maximum scan (in ms)
S:61	Extended-local I/O channel block-transfer scan (in ms)
S:62	Extended-I/O channel maximum block-transfer scan (in ms)
S:63	Protected controller data table protection file number
S:64	The number of remote block-transfer command blocks being used by channel pair 1A/1B.
S:65	The number of remote block-transfer command blocks being used by channel pair 2A/2B.
S:66	Reserved.

This Word	Stores
S:68	<p>Installed memory card type:</p> <ul style="list-style-type: none"> <li>0 - No memory card installed</li> <li>1 - 1785-ME16</li> <li>2 - 1785-ME32</li> <li>3 - 1785-ME64</li> <li>4 - 1785-ME100</li> <li>5 - 1785-CHBM</li> <li>6 - 1785-RC</li> <li>7-15 - Reserved</li> </ul> <p>When the 1785-RC module is installed, the eight least-significant bits indicate the memory card's status:</p> <ul style="list-style-type: none"> <li>Bit 3 is set when the memory card is installed</li> <li>Bit 2 is set when contact is detected closed</li> <li>Bit 1 is set when the relay is driven open</li> <li>Bit 0 is set when 120V ac is present on the memory card</li> </ul> <p>When any other memory card is installed, the bits are undefined.</p>
S:77	Communication time slice for communication housekeeping functions (in ms)
S:78	<p>MCP I/O update disable bits</p> <p>Bit 0 for MCP A Bit 1 for MCP B etc.</p>

**S:79-S:127**

This Word	Stores
S:79	<p>MCP inhibit bits</p> <p>Bit 0 for MCP A Bit 1 for MCP B etc.</p>
S:80-S:127	<p>MCP file number MCP scan time (in ms) MCP max scan time (in ms)</p> <p>The above sequence applies to each MCP; therefore, each MCP has 3 status words.</p> <p>For example, word 80: file number for MCP A word 81: scan time for MCP A word 82: maximum scan time for MCP A word 83: file number for MCP B word 84: scan time for MCP B etc.</p>

---

## Maximizing System Performance

### Using This Chapter

For Information About	Go to Page
Program scan	C-1
Calculating throughput	C-5
Input and output modules delay	C-6
I/O backplane transfer	C-6
Remote I/O scan time	C-6
Controller time	C-11
Example calculation	C-12
Performance effects of online operations	C-12
Inserting ladder rungs at the 56K-word limit	C-13
Using program control instructions	C-14

For information about the time that it takes the controller to execute a specific instruction, see Appendix D.

### Program Scan

Since the program scan is comprised of the logic scan and housekeeping, any event that impacts the time of one segment affects the program scan.

You can monitor the scan time by using the controller status screen in your programming software.

If no change in input status occurs and the controller continues to execute the same ladder logic instructions, the program scan cycle is consistent. In real systems, however, the program scan cycle fluctuates due to the following factors:

- false logic executes faster than true logic
- different instructions execute at different rates
- different input states cause different sections of logic to be executed
- interrupt programs affect program scan times
- editing programs while online affects housekeeping times

## Effects of False Logic versus True Logic on Logic Scan Time

The rung below—which changes states from one program scan to the next—will change your scan time by about 400  $\mu$ s.

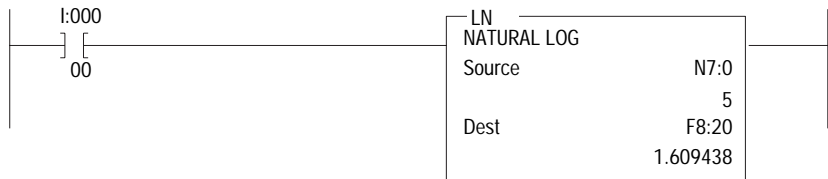

If I:000/00 is	Then the Rung is
On	True, and the controller calculates the natural log. A natural log instruction takes 409 $\mu$ s to execute.
Off	False, and the controller scans the rung but does not execute it. It takes only 1.4 $\mu$ s to only scan the rung.

Other instructions may have a greater or lesser effect.

## Effects of Different Input States on Logic Scan Time

You can write your logic so that it executes different rungs at different times, based on input conditions. The amount of logic executed in logic scans causes differences in program scan times. For example, the simple differences in rung execution in the following example cause the program scan to vary.

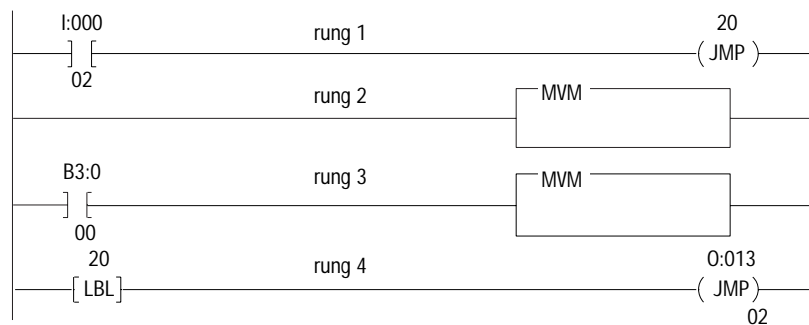

If I:000/02 is	Rungs 2 and 3 are
On	Skipped
Off	Executed



If you use subroutines, program scan times can vary by the scan time of entire logic files.

## Effects of Different Instructions on Logic Scan Time

Some instructions have a much greater effect on logic scan time than others based on the time that it takes to execute each instruction.

Program scan time is also affected by the construction of your ladder rungs. The size of the rung and the number of branches can cause the scan time to fluctuate greatly.

## Effects of Using Interrupts on Logic Scan Time

Program scan time is also affected by interrupt programs. An interrupt is a special situation that causes a separate program to run independently from the normal program scan. You define the special event and the type of interrupt that is to occur. For more information on interrupt programs, see chapters 18 and 19.

For example, a selectable timed interrupt (STI) is a program file that you define to execute once every time period. The example shown below has these parameters:

- you configure an STI to execute every 20 ms
- the STI program takes 3 ms to execute
- the logic scan is 21.8 ms
- housekeeping takes 3.2 ms

The first program scan in this example lasts a total of 28 ms. The program scans look like:

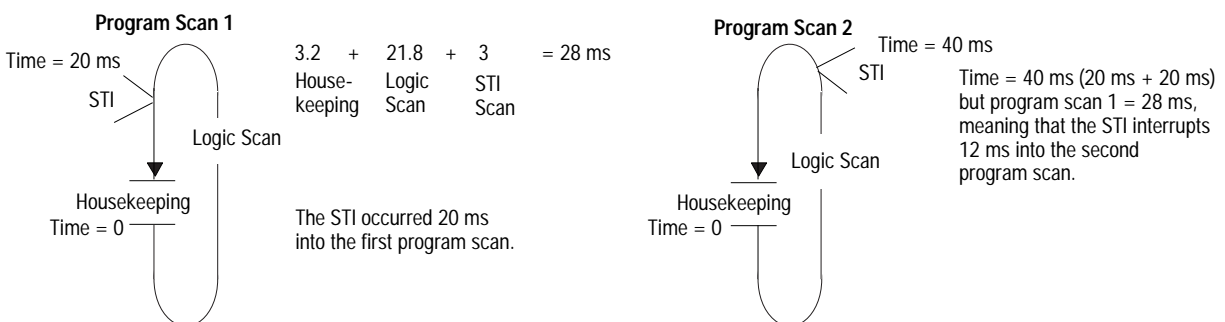

Because the first program scan takes 28 ms, the STI actually occurs 12 ms into the second program scan ( $28 + 12 = 40$ , which is the time for the second STI to occur). This example points out that when the STI time period is different than the program scan time, the STI occurs in different places in the program scan. Also note that, due to fluctuations in program-scan times, multiple STIs may be executed during one scan and no STIs during other scans.

## Effects of Housekeeping Time

In PLC-5 controllers, basic housekeeping takes 3.5 ms. If it takes the controller 21.8 ms to execute a ladder program, the overall program scan time is 25.3 ms. Any increase in housekeeping affects your program scan.

The following activities can increase housekeeping time:

- editing while in remote run mode
- putting block-transfer modules in the controller-resident chassis
- using the global status flag files

## Editing While in Remote Run Mode

The online editing times for ladder programs are as follows:

For this Editing Operation	And this Type of Program	The Times are
Accept Rung (after inserting, modifying, or deleting a rung edit)	other than the edited file	0.35 ms per 1000 words
	no labels	3 ms + 0.35 ms per 1000 words
	with labels	3.5 ms + 0.35 ms per 1000 words
Test Edits of the program (impacts one program scan)		0.2 ms to change the status of edits from TEST to UNTEST or UNTEST to TEST
Assemble Edits	no edits pending	0.35 ms per 1000 words
	edits pending, no labels	2.0 ms + 1.5 ms per 1000 words
	edits pending, with labels	2.0 ms + 1.9 ms per 1000 words

---

**IMPORTANT**

Editing programs online also delays the execution of PIIIs and STIs.

---

## Putting Block-Transfer Modules in Controller-Resident Chassis

Because controller-resident racks cannot be updated until after active block-transfers are completed, putting block-transfer modules in the controller-resident chassis can affect housekeeping by a worst-case time of approximately 100  $\mu$ s per one word of block-transfer data. Note that this estimate is based on a worst-case scenario. Typically, the effect, if any, on housekeeping will be minimal.

## Using Global Status Flag Files

The global status flag files are updated during housekeeping. This increases housekeeping time as follows:

- each global status flag file on a channel (for example, channel 1A or 1B) adds 3ms
- housekeeping time does not increase more than 6ms, even if there are more than two global status flag files

If you need two global status flag files, split them across two channels.

## Calculating Throughput

Throughput is the time that it takes for an output to be energized after its associated input has been energized. You need to consider the following components when evaluating throughput:

- input and output module delay
- I/O backplane transfer
- remote I/O scan time
- controller time

To calculate throughput, use the following equation:

$$\text{Input Card Delay} + \text{I/O Backplane} + \text{Worst-Case Remote I/O Scan Time} + \text{Worst-Case Processor Time} + \text{Worst-Case Remote I/O Scan Time} + \text{I/O Backplane} + \text{Output Card Delay}$$

## Input and Output Modules Delay

All input and output modules have a “delay time,” which is the time that it takes the module to transfer information to/from the I/O backplane through the I/O module to/from the field device.

Depending on the type of modules you are using, these delay times vary; but, the times must be taken into account when calculating system throughput. Choose modules that perform the function that you need with the lowest possible delay times.

## I/O Backplane Transfer

The I/O backplane transfer time is the time it takes for the 1771-ASB adapter module to exchange data with the I/O modules in the same chassis, generally 1-2 ms for a full I/O rack.

This time is fairly insignificant compared to total system throughput, but can be optimized in situations where empty slots or modules that use only backplane power in the chassis exist. For example, if the last four slots of a rack contain a 1785-KA module and power supply (with two empty slots), the 1771-ASB can be configured to ignore those last four slots.

For more information about configuring adapter modules, see the 1771 Remote I/O Adapter Module User Manual, publication 1771-UM001.

## Remote I/O Scan Time

The remote I/O scan time is the time it takes for the scanner to communicate with each device in the remote I/O system.

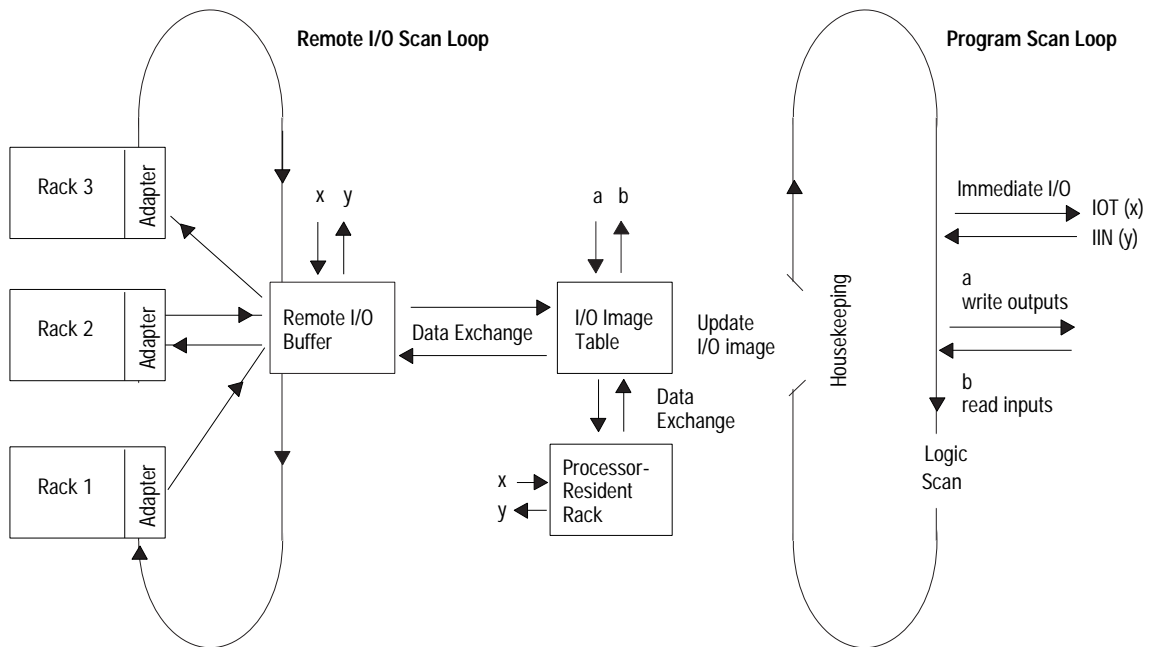

These three factors affect the remote I/O scan time:

- communication rate
- number of rack entries
- block-transfers

## Communication Rate

The communication rate determines the time it takes for the scanner to communicate with each individual entry in its scan list. The following table lists the amount of time required to communicate to a device at each communication rate.

Communication Rate (kbps):	Time (ms):	
57.6	10	Note that these are full rack times. Smaller racks will decrease this time.
115.2	7	
230.4	3	

If four full-rack entries are in the scan list, the I/O scan for that channel at 57.6 kbps is  $4 \times 10 = 40$  ms. If you change the communication rate to 230.4 kbps, the I/O scan decreases to  $4 \times 3 = 12$  ms.

## Number of Rack Entries

You determine the total remote I/O scan time in the remote I/O system by this formula:

**total remote I/O scan time** = # of rack entries X time per rack-entries in the scan list (see on page 7)

If one channel has twice as many racks as another, for example, the scan time for the first channel is twice as long.

To optimize this scan time, divide your I/O racks between multiple channels. Place your most time-critical I/O on one channel, and non- time-critical I/O on the other channel. Since all I/O channels are independent, a long remote I/O scan on one channel will not affect the remote I/O scan on another channel.

## Block-Transfers

A block-transfer is an interruption of the normal remote I/O scan in order to transfer a block of data to a specific I/O module. Most of the time that the controller spends in performing the block-transfer is for the handshaking that occurs between the controller and the block-transfer module. This handshaking is embedded in the discrete I/O transfer and has no effect on the remote I/O scan. The remote I/O scan is affected when the actual data transfer occurs.

The amount of time that the block-transfer interrupts the remote I/O scan depends on the number of words being transferred, the communication rate, and associated overhead:

Use this formula and the table below to calculate block-transfer time:

**block-transfer time** = (number of words being transferred ms/word based on the communication rate) + overhead for the communication rate

Communication Rate (kbps)	ms/Word	Overhead (ms)
57.6	.28	3
115.2	.14	2.5
230.4	.07	2

For example, if the communication rate is 115.2 kbps and you want to block-transfer 10 words, the interruption of the remote I/O scan is:

$$(10 \times .14) + 2.5 = 1.4 + 2.5 = 3.9 \text{ ms}$$

For the particular remote I/O scan in which the block-transfer takes place, 3.9 ms will be added to the remote I/O scan time.

---

**IMPORTANT**

If you select the baud rate as 230.4 kbps, and you are using the serial port or a PLC-5 coprocessor, use channel 2 for better overall system performance.

---

## Calculating Worst-Case Remote I/O Scan Time

Since it is impossible to predict within which remote I/O scan a block-transfer will occur, you only can calculate the worst-case remote I/O scan time. To calculate the worst case time:

1. Determine the normal I/O time (without block-transfers)
2. Add the time of the longest block-transfer to each entry in the scan list. (The controller can only perform one block-transfer per entry in the scan list per I/O scan.)

For example, if your system is:

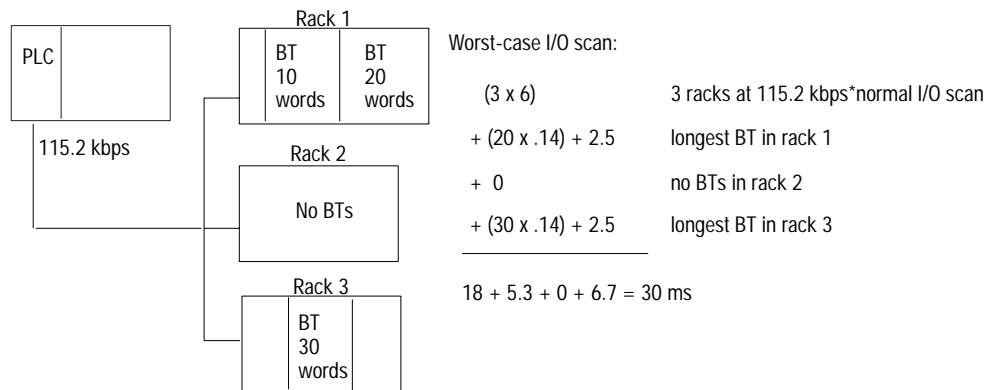

## Optimizing Remote I/O Scan Time

The best way to optimize your scan time is to place your most time-critical I/O on a separate channel from non-critical I/O. If you have only one channel available for I/O, however, you can still optimize the scanning by using the controller's configurable scan list.

In a normal 4-rack system, the scan list would be:

rack 1  
rack 2  
rack 3  
rack 4

If you are using 57.6 kbps, the normal I/O scan is 4 racks x 10 ms = 40 ms. Each entry is of equal priority, so each rack is scanned every 40 ms.

However, if rack 2 has the most time-critical I/O, use the configurable scan list to specify:

- rack 1
- rack 2
- rack 3
- rack 2
- rack 4
- rack 2

Using this scan list, rack 2 is scanned every other rack. The list has 6 entries, so the normal I/O scan time is  $6 \times 10 \text{ ms} = 60 \text{ ms}$ . Since rack 2 is scanned every other rack, however, the rack 2 **effective** scan time is  $2 \times 10 \text{ ms} = 20 \text{ ms}$ . The remaining racks are scanned every 60 ms. Thus, the tradeoff for the more frequent scanning of rack 2 (every 20 ms) means that the other racks are scanned only every 60 ms.

You can also optimize block-transfers within the channel. You block-transfer to only one block-transfer module per entry in the scan list per I/O scan. If you have three block-transfer modules in one I/O rack, it takes a minimum of three I/O scans to complete the block-transfers to all of the modules:

**System Optimized for Discrete-Data Transfer**

With this arrangement, only one block-transfer can occur to each BT module for every 3 discrete I/O scans.

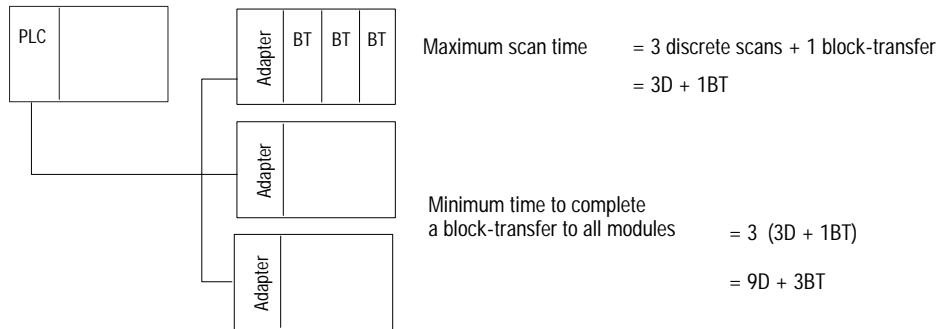

If you place the three block-transfer modules in different racks, however, you can block-transfer to all three modules in one I/O scan.



To optimize your system layout for block-data transfers, use an arrangement similar to the following:

**System Optimized for Block-Data Transfer**

With this arrangement, a block-transfer to each BT module can occur in a single discrete I/O scan.

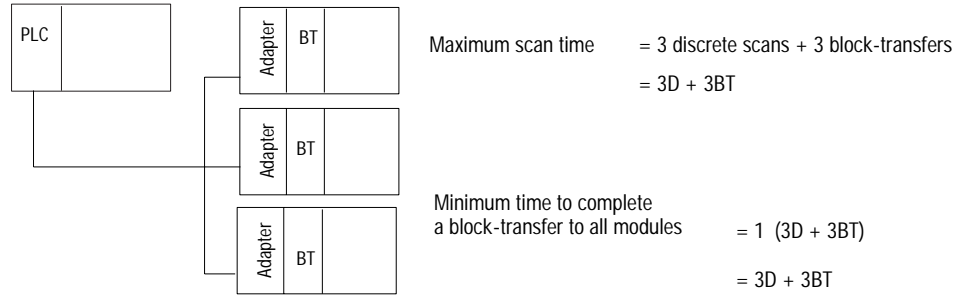

**Controller Time**

The controller time is the time needed to process the inputs and set the corresponding outputs. This controller time varies for different controllers and is based on input buffering, program scan, etc.

In a PLC-5 system, inputs are buffered between the I/O image table and the remote I/O buffer. The movement of inputs from the remote I/O buffer to the input buffer is asynchronous to the movement of data from the input buffer to the input image table.

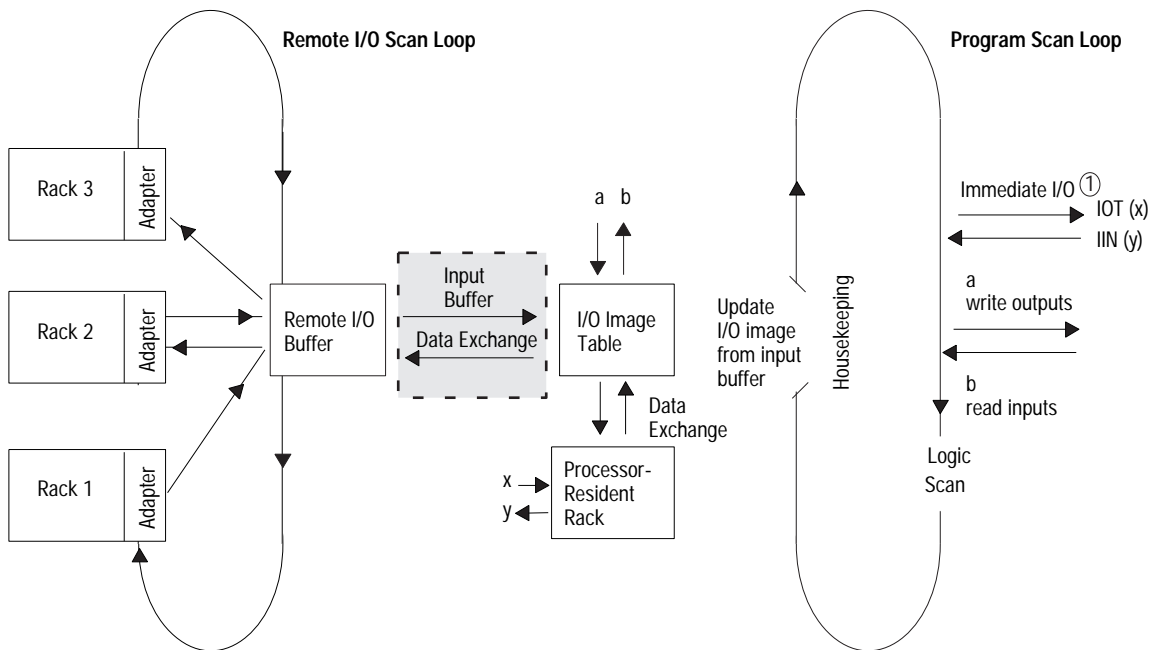

The worst-case controller time is:

Variable	Value
periodic input buffer update from remote I/O buffer	10 ms
one program scan to guarantee inputs received	xx ms
one program scan to guarantee outputs received	xx ms
0.18 ms times number of racks	xx ms
total	

For a 3-rack system with a 20 ms program scan, the worst-case controller time is:  $10 + 20 + 20 + (0.18 * 3) = 50.54$  ms.

## Example Calculation

Based on the results of each throughput component calculation presented within the chapter, an example of a worst-case update time calculation is:

Variable	Value
input card delay	10 ms typical
I/O backplane	1 ms
worst-case remote I/O scan time	30 ms
worst-case controller time	50.54 ms
worst-case remote I/O scan time	30 ms
I/O backplane	1 ms
output card delay	1 ms typical
total	123.54 ms

## Performance Effects of Online Operations

The performance of the PLC-5 controller is affected when you perform online operations via a DH+ link to your program files while in Run mode. Affected activities are:

- DH+ messages
- serial port messages
- channel 3A messages
- remote block-transfers

The amount of time that the messaging and block-transfers can be delayed is **proportional to the size (K words) of the ladder file**. The following table lists the performance effects (when using any of the 6200 Series PLC-5 Programming Software releases that support the controller you are using).

Effected Data Transfers	Online Operations via any DH+ Channel:	
	Perform a Page Up/Page Down at the End of a Program File	Insert/Delete Ladder Rungs
Remote block-transfers	20 ms/K words	50 ms/Kwords
DH+ messages	20 ms/K words	50 ms/Kwords
Serial port messages	200 ms/K words	50 ms/Kwords
Channel 3A messages	no impact	50 ms/Kwords

You should re-design your programs to avoid possible communication pauses if you currently:

- use large ladder logic program files
- have time critical remote block-transfers and/or serial, DH+, and channel 3A messages
- must edit the program online during run mode

For best controller performance, segment your program files by using modular programming design practices, such as main control programs (MCPs), sequential function charts (SFCs), and the jump to subroutine (JSR) instruction.

## Effect of Inserting Ladder Rungs at the 56K-word Limit

This consideration applies to PLC-5/60, -5/60L, -5/80, and -5/80E controllers when you are editing a program file that approaches the maximum file limit of 57,344 words.

Performing run-time or program-mode editing of ladder files that approach the maximum program file size of 57,344 words could:

- prevent the rung from being inserted
- cause suspension of the operation by 6200 Series PLC-5 Programming Software (release 4.3 and later)

To avoid or correct this problem, segment your program file using modular programming, such as main control programs (MCPs), sequential function charts (SFCs), and the jump to subroutine (JSR) instruction.

If you cannot segment your program file, save the file often while editing it.

If you encounter the error `Memory Unavailable for Attempted Operation`, then clear controller memory.

## Using Program Control Instructions

Scan time can increase based on how you use JMP/LBL instructions and FOR/NXT instructions.

### Using JMP/LBL Instructions

Keep in mind these issues when programming JMP/LBL instructions:

Instruction	Consideration
JMP	<p>The execution time required for a JMP instruction depends on the program file that contains the JMP instruction.</p> <p>The estimated execution time for a JMP instruction is:</p> $8.9 + (\text{file\_number} - 2) * 0.96$ <p>The greater the program file number, the longer it takes to complete a scan of the JMP instruction.</p>
LBL	<p>Each LBL instruction uses 2 words of memory in the program file plus additional memory, depending on the label number itself. Each label number is placed in a label table. Each entry in the label table uses 2 words of memory, starting from label 0. For example, LBL 10 uses 22 (2 words * 11th entry) words of memory in the label table.</p> <p>If you later delete LBL 10, the label table does not deallocate previously used space. The only way to recover this space is to upload and then re-download the program.</p>

### Using FOR/NXT Instructions

The FOR/NXT instructions have the same impact on execution time as the JMP instruction. The execution for a FOR/NXT loop depends on the program file that contains the instructions.

The estimated execution time for a FOR/NXT loop is:

$$8.1 + (\text{number\_of\_loops} * 15.9) + (\text{file\_number} - 2) * 0.96$$

The greater the program file number, the longer it takes to complete the FOR/NXT loops.

---

## Instruction Set Quick Reference

### Using This Chapter

<b>If You Want to Read About</b>	<b>Go to Page</b>
Relay instructions	D-2
Timer instructions	D-3
Counter instructions	D-4
Compare instructions	D-5
Compute instructions	D-7
Logical instructions	D-14
Conversion instructions	D-15
Bit modify and move instructions	D-16
File instructions	D-17
Diagnostic instructions	D-19
Shift register instructions	D-20
Sequencer instructions	D-21
Program control instructions	D-22
Process control and message instructions	D-25
Block Transfer instructions	D-25
ASCII instructions	D-27
Timing and memory requirements for bit and word instructions	D-30
Timing and memory requirements for file program control, and ASCII instructions	D-38

---

**IMPORTANT**

For a more detailed description of each of these instructions, see the PLC-5 Programming Software Instruction Set Reference, publication 1785-6.1.

---

## Relay Instructions

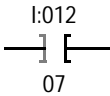
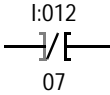
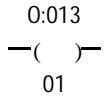
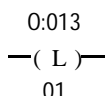
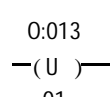
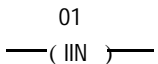
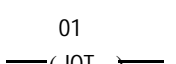
Instruction		Description
	Examine On XIC	Examine data table bit I:012/07, which corresponds to terminal 7 of an input module in I/O rack 1, I/O group 2. If this data table bit is set (1), the instruction is true.
	Examine Off XIO	Examine data table bit I:012/07, which corresponds to terminal 7 of an input module in I/O rack 1, I/O group 2. If this data table bit is reset (0), the instruction is true.
	Output Energize OTE	If the input conditions preceding this output instruction on the same rung go true, set (1) bit O:013/01, which corresponds to terminal 1 of an output module in I/O rack 1, I/O group 3.
	Output Latch OTL	If the input conditions preceding this output instruction on the same rung go true, set (1) bit O:013/01, which corresponds to terminal 1 of an output module in I/O rack 1, I/O group 3. This data table bit remains set even if the rung condition goes false.
	Output Unlatch OTU	If the input conditions preceding this output instruction on the same rung go true, reset (0) bit O:013/01, which corresponds to terminal 1 of an output module in I/O rack 1, I/O group 3. This is necessary to reset a bit that has been latched on.
	Immediate Input IIN	This instruction updates a word of input-image bits before the next normal input-image update. Address this instruction by rack and group (RRG). For a local chassis, program scan is interrupted while the inputs of the addressed I/O group are scanned; for a remote chassis, program scan is interrupted only to update the input image with the latest states as found in the remote I/O buffer.
	Immediate Output IOT	This instruction updates a word of output-image bits before the next normal output-image update. Address this instruction by rack and group (RRG). For a local chassis, program scan is interrupted while the outputs of the addressed I/O group are updated; for a remote chassis, program scan is interrupted only to update the remote I/O buffer with the latest states as found in the output image.

## Timer Instructions

Instruction	Description
-------------	-------------

<table border="1" style="width: 100%; border-collapse: collapse;"> <tr><td>TON</td><td></td></tr> <tr><td>TIMER ON DELAY</td><td></td></tr> <tr><td>Timer</td><td>T4:1</td></tr> <tr><td>Time Base</td><td>1.0</td></tr> <tr><td>Preset</td><td>15</td></tr> <tr><td>Accum</td><td>0</td></tr> </table>	TON		TIMER ON DELAY		Timer	T4:1	Time Base	1.0	Preset	15	Accum	0	<p>Timer On Delay TON</p> <p>Status Bits: EN - Enable TT - Timer Timing DN - Done</p>	<p>If the input conditions go true, timer T4:1 starts incrementing in 1-second intervals. When the accumulated value is greater than or equal to the preset value (15), the timer stops and sets the timer done bit.</p> <table border="1" style="width: 100%; border-collapse: collapse; margin-top: 10px;"> <thead> <tr> <th>Rung Condition</th> <th>EN 15</th> <th>TT 14</th> <th>DN 13</th> <th>ACC Value</th> <th>TON Status</th> </tr> </thead> <tbody> <tr> <td>False</td> <td>0</td> <td>0</td> <td>0</td> <td>0</td> <td>Reset</td> </tr> <tr> <td>True</td> <td>1</td> <td>1</td> <td>0</td> <td>increase</td> <td>Timing</td> </tr> <tr> <td>True</td> <td>1</td> <td>0</td> <td>1</td> <td>&gt;= preset</td> <td>Done</td> </tr> </tbody> </table>	Rung Condition	EN 15	TT 14	DN 13	ACC Value	TON Status	False	0	0	0	0	Reset	True	1	1	0	increase	Timing	True	1	0	1	>= preset	Done
TON																																						
TIMER ON DELAY																																						
Timer	T4:1																																					
Time Base	1.0																																					
Preset	15																																					
Accum	0																																					
Rung Condition	EN 15	TT 14	DN 13	ACC Value	TON Status																																	
False	0	0	0	0	Reset																																	
True	1	1	0	increase	Timing																																	
True	1	0	1	>= preset	Done																																	

See page F-8 for a description of prescan operation for this instruction.

<table border="1" style="width: 100%; border-collapse: collapse;"> <tr><td>TOF</td><td></td></tr> <tr><td>TIMER OFF DELAY</td><td></td></tr> <tr><td>Timer</td><td>T4:1</td></tr> <tr><td>Time Base</td><td>.01</td></tr> <tr><td>Preset</td><td>180</td></tr> <tr><td>Accum</td><td>0</td></tr> </table>	TOF		TIMER OFF DELAY		Timer	T4:1	Time Base	.01	Preset	180	Accum	0	<p>Timer Off Delay TOF</p> <p>Status Bits: EN - Enable TT - Timer Timing DN - Done</p>	<p>If the input conditions are false, timer T4:1 starts incrementing in 10 1-ms intervals as long as the rung remains false. When the accumulated value is greater than or equal to the preset value (180), the timer stops and resets the timer</p> <table border="1" style="width: 100%; border-collapse: collapse; margin-top: 10px;"> <thead> <tr> <th>Rung Condition</th> <th>EN 15</th> <th>TT 14</th> <th>DN 13</th> <th>ACC Value</th> <th>TOF Status</th> </tr> </thead> <tbody> <tr> <td>True</td> <td>1</td> <td>0</td> <td>1</td> <td>0</td> <td>Reset</td> </tr> <tr> <td>False</td> <td>0</td> <td>1</td> <td>1</td> <td>increase</td> <td>Timing</td> </tr> <tr> <td>False</td> <td>0</td> <td>0</td> <td>0</td> <td>&gt;= preset</td> <td>Done</td> </tr> </tbody> </table>	Rung Condition	EN 15	TT 14	DN 13	ACC Value	TOF Status	True	1	0	1	0	Reset	False	0	1	1	increase	Timing	False	0	0	0	>= preset	Done
TOF																																						
TIMER OFF DELAY																																						
Timer	T4:1																																					
Time Base	.01																																					
Preset	180																																					
Accum	0																																					
Rung Condition	EN 15	TT 14	DN 13	ACC Value	TOF Status																																	
True	1	0	1	0	Reset																																	
False	0	1	1	increase	Timing																																	
False	0	0	0	>= preset	Done																																	

See page F-8 for a description of prescan operation for this instruction.

Instruction	Description																														
<div style="border: 1px solid black; padding: 5px; display: inline-block;">                     RTO                      RETENTIVE TIMER ON                      Timer T4:10                      Time Base 1.0                      Preset 10                      Accum 0                 </div>	<p>Retentive Timer On RTO</p> <p>Status Bits: EN - Enable TT - Timer Timing DN - Done</p>																														
	<p>If the input conditions go true, timer T4:10 starts incrementing i 1-second intervals as long as the rung remains true. When the rung goes false, the timer stops. If the rung goes true again, th timer continues. When the accumulated value is greater than c equal to the preset (10), the timer stops and sets the timer don bit.</p> <table border="1"> <thead> <tr> <th>Rung Condition</th> <th>EN 15</th> <th>TT 14</th> <th>DN 13</th> <th>ACC Value</th> <th>RTO Status</th> </tr> </thead> <tbody> <tr> <td>False</td> <td>0</td> <td>0</td> <td>0</td> <td>0</td> <td>Disabled</td> </tr> <tr> <td>True</td> <td>1</td> <td>1</td> <td>0</td> <td>increase</td> <td>Timing</td> </tr> <tr> <td>False</td> <td>0</td> <td>0</td> <td>0</td> <td>maintains</td> <td>Disabled</td> </tr> <tr> <td>True</td> <td>1</td> <td>0</td> <td>1</td> <td>&gt;= preset</td> <td>Done</td> </tr> </tbody> </table>	Rung Condition	EN 15	TT 14	DN 13	ACC Value	RTO Status	False	0	0	0	0	Disabled	True	1	1	0	increase	Timing	False	0	0	0	maintains	Disabled	True	1	0	1	>= preset	Done
Rung Condition	EN 15	TT 14	DN 13	ACC Value	RTO Status																										
False	0	0	0	0	Disabled																										
True	1	1	0	increase	Timing																										
False	0	0	0	maintains	Disabled																										
True	1	0	1	>= preset	Done																										
<p>T4:1 — ( RES ) —</p>	<p>Timer Reset RES</p> <p>If the input conditions go true, timer T4:1 is reset. This instruction resets timers and counters, as well as control blocks. This is necessary to reset the RTO accumulated value.</p>																														

### Counter Instructions

Instruction	Description																														
<div style="border: 1px solid black; padding: 5px; display: inline-block;">                     CTU                      COUNT UP                      Counter C5:1                      Preset 10                      Accum 0                 </div>	<p>Count Up CTU</p> <p>Status Bits: CU-Count Up CD-Count Down DN-Count Up done OV-Overflow UN-Underflow</p>																														
	<p>If the input conditions go true, counter C5:1 starts counting, incrementing by 1 every time the rung goes from false-to-true. When the accumulated value is greater than or equal to the preset value (10), the counter sets the counter</p> <table border="1"> <thead> <tr> <th>Rung Condition</th> <th>CU 15</th> <th>DN 13</th> <th>OV 12</th> <th>ACC Value</th> <th>CTU Status</th> </tr> </thead> <tbody> <tr> <td>False</td> <td>0</td> <td>0</td> <td>0</td> <td>0</td> <td>Disabled</td> </tr> <tr> <td>Toggle True</td> <td>1</td> <td>0</td> <td>0</td> <td>incr by 1</td> <td>Counting</td> </tr> <tr> <td>True</td> <td>1</td> <td>1</td> <td>0</td> <td>&gt;= preset</td> <td>Done</td> </tr> <tr> <td>True</td> <td>1</td> <td>1</td> <td>1</td> <td>&gt;32767</td> <td>Overflow</td> </tr> </tbody> </table> <p>See page F-8 for a description of prescan operation for this instruction.</p>	Rung Condition	CU 15	DN 13	OV 12	ACC Value	CTU Status	False	0	0	0	0	Disabled	Toggle True	1	0	0	incr by 1	Counting	True	1	1	0	>= preset	Done	True	1	1	1	>32767	Overflow
Rung Condition	CU 15	DN 13	OV 12	ACC Value	CTU Status																										
False	0	0	0	0	Disabled																										
Toggle True	1	0	0	incr by 1	Counting																										
True	1	1	0	>= preset	Done																										
True	1	1	1	>32767	Overflow																										



Instruction	Description																																				
<b>CTD</b> COUNT DOWN Counter C5:1 Preset 10 Accum 35	<p>Count Down CTD</p> <p>Status Bits:                      CU-Count Up                      CD-Count Down                      DN-Count Down done                      OV-Overflow                      UN-Underflow</p> <table border="1" style="margin-top: 10px;"> <thead> <tr> <th>Rung Condition</th> <th>CD 14</th> <th>DN 13</th> <th>UN 11</th> <th>ACC Value</th> <th>CTD Status</th> </tr> </thead> <tbody> <tr> <td>False</td> <td>0</td> <td>0</td> <td>0</td> <td>0</td> <td>Disabled</td> </tr> <tr> <td>False</td> <td>0</td> <td>1</td> <td>0</td> <td>&gt;= preset</td> <td>Preload</td> </tr> <tr> <td>Toggle True</td> <td>1</td> <td>1</td> <td>0</td> <td>dec by 1</td> <td>Counting</td> </tr> <tr> <td>True</td> <td>1</td> <td>0</td> <td>0</td> <td>&lt; preset</td> <td>Done</td> </tr> <tr> <td>True</td> <td>1</td> <td>0</td> <td>1</td> <td>&lt; -32768</td> <td>Underflow</td> </tr> </tbody> </table>	Rung Condition	CD 14	DN 13	UN 11	ACC Value	CTD Status	False	0	0	0	0	Disabled	False	0	1	0	>= preset	Preload	Toggle True	1	1	0	dec by 1	Counting	True	1	0	0	< preset	Done	True	1	0	1	< -32768	Underflow
Rung Condition	CD 14	DN 13	UN 11	ACC Value	CTD Status																																
False	0	0	0	0	Disabled																																
False	0	1	0	>= preset	Preload																																
Toggle True	1	1	0	dec by 1	Counting																																
True	1	0	0	< preset	Done																																
True	1	0	1	< -32768	Underflow																																

See page F-8 for a description of prescan operation for this instruction.

### Compare Instructions

Instruction	Description																												
<b>LIM</b> LIMIT TEST (CIRC) Low limit N7:10 3 Test N7:15 4 High limit N7:20 22	<p>Limit Test LIM</p> <p>If the Test value (N7:15) is &gt;= the Low Limit (N7:10) and &lt;= the High Limit (N7:20), this instruction is true.</p> <table border="1" style="margin-top: 10px;"> <thead> <tr> <th>Low Limit</th> <th>Test</th> <th>High Limit</th> <th>LIM</th> </tr> </thead> <tbody> <tr> <td>0</td> <td>0</td> <td>10</td> <td>T</td> </tr> <tr> <td>-5</td> <td>5</td> <td>10</td> <td>T</td> </tr> <tr> <td>5</td> <td>11</td> <td>10</td> <td>F</td> </tr> <tr> <td>10</td> <td>0</td> <td>0</td> <td>T</td> </tr> <tr> <td>10</td> <td>5</td> <td>-5</td> <td>F</td> </tr> <tr> <td>10</td> <td>11</td> <td>5</td> <td>T</td> </tr> </tbody> </table>	Low Limit	Test	High Limit	LIM	0	0	10	T	-5	5	10	T	5	11	10	F	10	0	0	T	10	5	-5	F	10	11	5	T
Low Limit	Test	High Limit	LIM																										
0	0	10	T																										
-5	5	10	T																										
5	11	10	F																										
10	0	0	T																										
10	5	-5	F																										
10	11	5	T																										

<b>MEQ</b> MASKED EQUAL Source D9:5 0000 Mask D9:6 0000 Compare D9:10 0000	<p>Mask Compare Equal MEQ</p> <p>The controller takes the value in the Source (D9:5) and passes that value through the Mask (D9:6). Then the controller compares the result to the Compare value (D9:10). If the result and this comparison values are equal, the instruction is true.</p> <table border="1" style="margin-top: 10px;"> <thead> <tr> <th>Source</th> <th>Mask</th> <th>Compare</th> <th>MEQ</th> </tr> </thead> <tbody> <tr> <td>0008</td> <td>0008</td> <td>0009</td> <td>T</td> </tr> <tr> <td>0008</td> <td>0001</td> <td>0001</td> <td>F</td> </tr> <tr> <td>0087</td> <td>000F</td> <td>0007</td> <td>T</td> </tr> <tr> <td>0087</td> <td>00F0</td> <td>0007</td> <td>F</td> </tr> </tbody> </table>	Source	Mask	Compare	MEQ	0008	0008	0009	T	0008	0001	0001	F	0087	000F	0007	T	0087	00F0	0007	F
Source	Mask	Compare	MEQ																		
0008	0008	0009	T																		
0008	0001	0001	F																		
0087	000F	0007	T																		
0087	00F0	0007	F																		

Instruction	Description																																																
CMP COMPARE Expression N7:5 = N7:10	Compare CMP If the expression is true, this input instruction is true. The CMP instruction can perform these operations: equal (=), less than (<), less than or equal (<=), greater than (>), greater than or equal (>=), not equal (<>), and complex expressions (up to 80 characters).																																																
xxx xxxxxxxxxxxxxx Source A        N7:5 3 Source B        N7:10 1	<table border="1" style="width: 100%; text-align: center;"> <thead> <tr> <th>Source A</th> <th>Source B</th> <th>EQU</th> <th>GEO</th> <th>GRT</th> <th>LEQ</th> <th>LES</th> <th>NEQ</th> </tr> </thead> <tbody> <tr> <td>10</td> <td>10</td> <td>T</td> <td>T</td> <td>F</td> <td>T</td> <td>F</td> <td>F</td> </tr> <tr> <td>5</td> <td>6</td> <td>F</td> <td>F</td> <td>F</td> <td>T</td> <td>T</td> <td>T</td> </tr> <tr> <td>21</td> <td>20</td> <td>F</td> <td>T</td> <td>T</td> <td>F</td> <td>F</td> <td>T</td> </tr> <tr> <td>-30</td> <td>-31</td> <td>F</td> <td>T</td> <td>T</td> <td>F</td> <td>F</td> <td>T</td> </tr> <tr> <td>-15</td> <td>-14</td> <td>F</td> <td>F</td> <td>F</td> <td>T</td> <td>T</td> <td>T</td> </tr> </tbody> </table>	Source A	Source B	EQU	GEO	GRT	LEQ	LES	NEQ	10	10	T	T	F	T	F	F	5	6	F	F	F	T	T	T	21	20	F	T	T	F	F	T	-30	-31	F	T	T	F	F	T	-15	-14	F	F	F	T	T	T
Source A	Source B	EQU	GEO	GRT	LEQ	LES	NEQ																																										
10	10	T	T	F	T	F	F																																										
5	6	F	F	F	T	T	T																																										
21	20	F	T	T	F	F	T																																										
-30	-31	F	T	T	F	F	T																																										
-15	-14	F	F	F	T	T	T																																										
	Equal to EQU If the value in Source A (N7:5) is = to the value in Source B (N7:10), this instruction is true.																																																
	Greater than or Equal GEO If the value in Source A (N7:5) is > or = the value in Source B (N7:10), this instruction is true.																																																
	Greater than GRT If the value in Source A (N7:5) is > the value in Source B (N7:10), this instruction is true.																																																
	Less than or Equal LEQ If the value in Source A (N7:5) is < or = the value in Source B (N7:10), this instruction is true.																																																
	Less than LES If the value in Source A (N7:5) is < the value in Source B (N7:10), this instruction is true.																																																
	Not Equal NEQ If the value in Source A (N7:5) is not equal to the value in Source B (N7:10), this instruction is true.																																																

## Compute Instructions

Instruction	Description																				
<table border="1" style="width: 100%; border-collapse: collapse;"> <tr><td style="padding: 2px;">CPT</td><td style="padding: 2px;"></td></tr> <tr><td style="padding: 2px;">COMPUTE</td><td style="padding: 2px;"></td></tr> <tr><td style="padding: 2px;">Dest</td><td style="padding: 2px; text-align: right;">N7:3 3</td></tr> <tr><td style="padding: 2px;">Expression</td><td style="padding: 2px;">N7:4 - (N7:6 * N7:10)</td></tr> </table>	CPT		COMPUTE		Dest	N7:3 3	Expression	N7:4 - (N7:6 * N7:10)	<p>Compute CPT</p> <p>If the input conditions go true, evaluate the Expression N7:4 - (N7:6 * N7:10) and store the result in the Destination (N7:3).</p> <p>The CPT instruction can perform these operations: add (+), subtract (-), multiply (*), divide (/), convert from BCD (FRD), convert to BCD (TOD), square root (SQR), logical and (AND), logical or (OR), logical not (NOT), exclusive or (XOR), negate (-), clear (0), and move, X to the power of Y (**), radians (RAD), degrees (DEG), log (LOG), natural log (LN), sine (SIN), cosine (COS), tangent (TAN), inverse sine (ASN), inverse cosine (ACS), inverse tangent (ATN), and complex expressions (up to 80 characters)</p>												
CPT																					
COMPUTE																					
Dest	N7:3 3																				
Expression	N7:4 - (N7:6 * N7:10)																				
<table border="1" style="width: 100%; border-collapse: collapse;"> <tr><td style="padding: 2px;">ACS</td><td style="padding: 2px;"></td></tr> <tr><td style="padding: 2px;">ARCCOSINE</td><td style="padding: 2px;"></td></tr> <tr><td style="padding: 2px;">Source</td><td style="padding: 2px; text-align: right;">F8:19 0.7853982</td></tr> <tr><td style="padding: 2px;">Dest</td><td style="padding: 2px; text-align: right;">F8:20 0.6674572</td></tr> </table>	ACS		ARCCOSINE		Source	F8:19 0.7853982	Dest	F8:20 0.6674572	<p>Arc cosine ACS</p> <p>If input conditions go true, take the arc cosine of the value in F8:19 and store the result in F8:20.</p> <table border="1" style="width: 100%; border-collapse: collapse; margin-top: 10px;"> <thead> <tr> <th style="text-align: center; padding: 5px;">Status Bit</th> <th style="text-align: left; padding: 5px;">Description</th> </tr> </thead> <tbody> <tr> <td style="text-align: center; padding: 5px;">C</td> <td style="padding: 5px;">always resets</td> </tr> <tr> <td style="text-align: center; padding: 5px;">V</td> <td style="padding: 5px;">sets if overflow is generated; otherwise resets</td> </tr> <tr> <td style="text-align: center; padding: 5px;">Z</td> <td style="padding: 5px;">sets if the result is zero; otherwise resets</td> </tr> <tr> <td style="text-align: center; padding: 5px;">S</td> <td style="padding: 5px;">always resets</td> </tr> </tbody> </table>	Status Bit	Description	C	always resets	V	sets if overflow is generated; otherwise resets	Z	sets if the result is zero; otherwise resets	S	always resets		
ACS																					
ARCCOSINE																					
Source	F8:19 0.7853982																				
Dest	F8:20 0.6674572																				
Status Bit	Description																				
C	always resets																				
V	sets if overflow is generated; otherwise resets																				
Z	sets if the result is zero; otherwise resets																				
S	always resets																				
<table border="1" style="width: 100%; border-collapse: collapse;"> <tr><td style="padding: 2px;">ADD</td><td style="padding: 2px;"></td></tr> <tr><td style="padding: 2px;">ADD</td><td style="padding: 2px;"></td></tr> <tr><td style="padding: 2px;">Source A</td><td style="padding: 2px; text-align: right;">N7:3 3</td></tr> <tr><td style="padding: 2px;">Source B</td><td style="padding: 2px; text-align: right;">N7:4 1</td></tr> <tr><td style="padding: 2px;">Dest</td><td style="padding: 2px; text-align: right;">N7:12 4</td></tr> </table>	ADD		ADD		Source A	N7:3 3	Source B	N7:4 1	Dest	N7:12 4	<p>Addition ADD</p> <p>When the input conditions are true, add the value in Source A (N7:3) to the value in Source B (N7:4) and store the result in the Destination (N7:12).</p> <table border="1" style="width: 100%; border-collapse: collapse; margin-top: 10px;"> <thead> <tr> <th style="text-align: center; padding: 5px;">Status Bit</th> <th style="text-align: left; padding: 5px;">Description</th> </tr> </thead> <tbody> <tr> <td style="text-align: center; padding: 5px;">C</td> <td style="padding: 5px;">sets if carry is generated; otherwise resets</td> </tr> <tr> <td style="text-align: center; padding: 5px;">V</td> <td style="padding: 5px;">sets if overflow is generated; otherwise resets</td> </tr> <tr> <td style="text-align: center; padding: 5px;">Z</td> <td style="padding: 5px;">sets if the result is zero; otherwise resets</td> </tr> <tr> <td style="text-align: center; padding: 5px;">S</td> <td style="padding: 5px;">sets if the result is negative; otherwise resets</td> </tr> </tbody> </table>	Status Bit	Description	C	sets if carry is generated; otherwise resets	V	sets if overflow is generated; otherwise resets	Z	sets if the result is zero; otherwise resets	S	sets if the result is negative; otherwise resets
ADD																					
ADD																					
Source A	N7:3 3																				
Source B	N7:4 1																				
Dest	N7:12 4																				
Status Bit	Description																				
C	sets if carry is generated; otherwise resets																				
V	sets if overflow is generated; otherwise resets																				
Z	sets if the result is zero; otherwise resets																				
S	sets if the result is negative; otherwise resets																				

Instruction		Description											
ASN ARCSINE Source           F8:17 0.7853982  Dest             F8:18 0.9033391	Arc sine ASN	When input conditions go true, take the arc sine of the value in F8:17 and store the result in F8:18.	<table border="1"> <thead> <tr> <th>Status Bit</th> <th>Description</th> </tr> </thead> <tbody> <tr> <td>C</td> <td>always resets</td> </tr> <tr> <td>V</td> <td>sets if overflow is generated; otherwise resets</td> </tr> <tr> <td>Z</td> <td>sets if the result is zero; otherwise resets</td> </tr> <tr> <td>S</td> <td>always resets</td> </tr> </tbody> </table>	Status Bit	Description	C	always resets	V	sets if overflow is generated; otherwise resets	Z	sets if the result is zero; otherwise resets	S	always resets
Status Bit	Description												
C	always resets												
V	sets if overflow is generated; otherwise resets												
Z	sets if the result is zero; otherwise resets												
S	always resets												
ATN ARCTANGENT Source           F8:21 0.7853982  Dest             F8:22 0.6657737	Arc tangent ATN	When input conditions go true, take the arc tangent of the value in F8:21 and store the result in F8:22.	<table border="1"> <thead> <tr> <th>Status Bit</th> <th>Description</th> </tr> </thead> <tbody> <tr> <td>C</td> <td>always resets</td> </tr> <tr> <td>V</td> <td>sets if overflow is generated; otherwise resets</td> </tr> <tr> <td>Z</td> <td>sets if the result is zero; otherwise resets</td> </tr> <tr> <td>S</td> <td>sets if the result is negative; otherwise resets</td> </tr> </tbody> </table>	Status Bit	Description	C	always resets	V	sets if overflow is generated; otherwise resets	Z	sets if the result is zero; otherwise resets	S	sets if the result is negative; otherwise resets
Status Bit	Description												
C	always resets												
V	sets if overflow is generated; otherwise resets												
Z	sets if the result is zero; otherwise resets												
S	sets if the result is negative; otherwise resets												
AVE AVERAGE FILE File             #N7:1 Dest            N7:0 Control         R6:0 Length         4 Position        0	Average AVE  Status Bits: EN - Enable DN - Done bit ER - Error Bit	When the input conditions go from false-to-true, take the average of the file #N7:1 and store the result in N7:0.	<table border="1"> <thead> <tr> <th>Status Bit</th> <th>Description</th> </tr> </thead> <tbody> <tr> <td>C</td> <td>always resets</td> </tr> <tr> <td>V</td> <td>sets if overflow is generated; otherwise resets</td> </tr> <tr> <td>Z</td> <td>sets if the result is zero; otherwise resets</td> </tr> <tr> <td>S</td> <td>sets if the result is negative; otherwise resets</td> </tr> </tbody> </table>	Status Bit	Description	C	always resets	V	sets if overflow is generated; otherwise resets	Z	sets if the result is zero; otherwise resets	S	sets if the result is negative; otherwise resets
Status Bit	Description												
C	always resets												
V	sets if overflow is generated; otherwise resets												
Z	sets if the result is zero; otherwise resets												
S	sets if the result is negative; otherwise resets												

Instruction	Description
-------------	-------------

<table border="1" style="width: 100%; border-collapse: collapse;"> <tr><td style="padding: 2px;">CLR</td><td style="padding: 2px;"></td></tr> <tr><td style="padding: 2px;">CLR</td><td style="padding: 2px;"></td></tr> <tr><td style="padding: 2px;">Dest</td><td style="padding: 2px; text-align: right;">D9:34 0000</td></tr> </table>	CLR		CLR		Dest	D9:34 0000	Clear CLR	When the input conditions are true, clear decimal file 9, word (set to zero).				
CLR												
CLR												
Dest	D9:34 0000											
<table border="1" style="width: 100%; border-collapse: collapse;"> <thead> <tr> <th style="width: 15%; padding: 2px;">Status Bit</th> <th style="padding: 2px;">Description</th> </tr> </thead> <tbody> <tr><td style="padding: 2px;">C</td><td style="padding: 2px;">always reset</td></tr> <tr><td style="padding: 2px;">V</td><td style="padding: 2px;">always reset</td></tr> <tr><td style="padding: 2px;">Z</td><td style="padding: 2px;">always set</td></tr> <tr><td style="padding: 2px;">S</td><td style="padding: 2px;">always reset</td></tr> </tbody> </table>			Status Bit	Description	C	always reset	V	always reset	Z	always set	S	always reset
Status Bit	Description											
C	always reset											
V	always reset											
Z	always set											
S	always reset											

<table border="1" style="width: 100%; border-collapse: collapse;"> <tr><td style="padding: 2px;">COS</td><td style="padding: 2px;"></td></tr> <tr><td style="padding: 2px;">COSINE</td><td style="padding: 2px;"></td></tr> <tr><td style="padding: 2px;">Source</td><td style="padding: 2px; text-align: right;">F8:13 0.7853982</td></tr> <tr><td style="padding: 2px;">Dest</td><td style="padding: 2px; text-align: right;">F8:14 0.7071068</td></tr> </table>	COS		COSINE		Source	F8:13 0.7853982	Dest	F8:14 0.7071068	Cosine COS	When input conditions go true, take the cosine of the value in F8:13 and store the result in F8:14.		
COS												
COSINE												
Source	F8:13 0.7853982											
Dest	F8:14 0.7071068											
<table border="1" style="width: 100%; border-collapse: collapse;"> <thead> <tr> <th style="width: 15%; padding: 2px;">Status Bit</th> <th style="padding: 2px;">Description</th> </tr> </thead> <tbody> <tr><td style="padding: 2px;">C</td><td style="padding: 2px;">always resets</td></tr> <tr><td style="padding: 2px;">V</td><td style="padding: 2px;">sets if overflow is generated; otherwise resets</td></tr> <tr><td style="padding: 2px;">Z</td><td style="padding: 2px;">sets if the result is zero; otherwise resets</td></tr> <tr><td style="padding: 2px;">S</td><td style="padding: 2px;">sets if the result is negative; otherwise resets</td></tr> </tbody> </table>			Status Bit	Description	C	always resets	V	sets if overflow is generated; otherwise resets	Z	sets if the result is zero; otherwise resets	S	sets if the result is negative; otherwise resets
Status Bit	Description											
C	always resets											
V	sets if overflow is generated; otherwise resets											
Z	sets if the result is zero; otherwise resets											
S	sets if the result is negative; otherwise resets											

Instruction	Description
-------------	-------------

<table border="1" style="width: 100%; border-collapse: collapse;"> <tr><td style="padding: 2px;">DIV</td><td style="padding: 2px;"></td></tr> <tr><td style="padding: 2px;">DIVIDE</td><td style="padding: 2px;"></td></tr> <tr><td style="padding: 2px;">Source A</td><td style="padding: 2px; text-align: right;">N7:3 3</td></tr> <tr><td style="padding: 2px;">Source B</td><td style="padding: 2px; text-align: right;">N7:4 1</td></tr> <tr><td style="padding: 2px;">Dest</td><td style="padding: 2px; text-align: right;">N7:12 3</td></tr> </table>	DIV		DIVIDE		Source A	N7:3 3	Source B	N7:4 1	Dest	N7:12 3	Division DIV	When the input conditions are true, divide the value in Source A (N7:3) by the value in Source B (N7:4) and store the result in the Destination (N7:12).
DIV												
DIVIDE												
Source A	N7:3 3											
Source B	N7:4 1											
Dest	N7:12 3											
<table border="1" style="width: 100%; border-collapse: collapse;"> <thead> <tr> <th style="width: 15%; padding: 2px;">Status Bit</th> <th style="padding: 2px;">Description</th> </tr> </thead> <tbody> <tr><td style="padding: 2px;">C</td><td style="padding: 2px;">always resets</td></tr> <tr><td style="padding: 2px;">V</td><td style="padding: 2px;">sets if division by zero or overflow; otherwise resets</td></tr> <tr><td style="padding: 2px;">Z</td><td style="padding: 2px;">sets if the result is zero; otherwise resets; undefined if overflow is set</td></tr> <tr><td style="padding: 2px;">S</td><td style="padding: 2px;">sets if the result is negative; otherwise resets; undefined if overflow is set</td></tr> </tbody> </table>			Status Bit	Description	C	always resets	V	sets if division by zero or overflow; otherwise resets	Z	sets if the result is zero; otherwise resets; undefined if overflow is set	S	sets if the result is negative; otherwise resets; undefined if overflow is set
Status Bit	Description											
C	always resets											
V	sets if division by zero or overflow; otherwise resets											
Z	sets if the result is zero; otherwise resets; undefined if overflow is set											
S	sets if the result is negative; otherwise resets; undefined if overflow is set											

Instruction	Description
-------------	-------------

<table border="1" style="width: 100%; border-collapse: collapse;"> <tr><td style="padding: 2px;">LN</td><td style="padding: 2px;"></td></tr> <tr><td style="padding: 2px;">NATURAL LOG</td><td style="padding: 2px;"></td></tr> <tr><td style="padding: 2px;">Source</td><td style="padding: 2px;">N7:0 5</td></tr> <tr><td style="padding: 2px;">Dest</td><td style="padding: 2px;">F8:20 1.609438</td></tr> </table>	LN		NATURAL LOG		Source	N7:0 5	Dest	F8:20 1.609438	Natural log LN	When input conditions go true, take the natural log of the value in N7:0 and store the result in F8:20. <table border="1" style="width: 100%; border-collapse: collapse; margin-top: 10px;"> <thead> <tr> <th style="width: 10%; padding: 2px;">Status Bit</th> <th style="padding: 2px;">Description</th> </tr> </thead> <tbody> <tr> <td style="text-align: center; padding: 2px;">C</td> <td style="padding: 2px;">always resets</td> </tr> <tr> <td style="text-align: center; padding: 2px;">V</td> <td style="padding: 2px;">sets if overflow is generated; otherwise resets</td> </tr> <tr> <td style="text-align: center; padding: 2px;">Z</td> <td style="padding: 2px;">sets if the result is zero; otherwise resets</td> </tr> <tr> <td style="text-align: center; padding: 2px;">S</td> <td style="padding: 2px;">sets if the result is negative; otherwise resets</td> </tr> </tbody> </table>	Status Bit	Description	C	always resets	V	sets if overflow is generated; otherwise resets	Z	sets if the result is zero; otherwise resets	S	sets if the result is negative; otherwise resets
LN																				
NATURAL LOG																				
Source	N7:0 5																			
Dest	F8:20 1.609438																			
Status Bit	Description																			
C	always resets																			
V	sets if overflow is generated; otherwise resets																			
Z	sets if the result is zero; otherwise resets																			
S	sets if the result is negative; otherwise resets																			

<table border="1" style="width: 100%; border-collapse: collapse;"> <tr><td style="padding: 2px;">LOG</td><td style="padding: 2px;"></td></tr> <tr><td style="padding: 2px;">LOG BASE 10</td><td style="padding: 2px;"></td></tr> <tr><td style="padding: 2px;">Source</td><td style="padding: 2px;">N7:2 5</td></tr> <tr><td style="padding: 2px;">Dest</td><td style="padding: 2px;">F8:3 0.6989700</td></tr> </table>	LOG		LOG BASE 10		Source	N7:2 5	Dest	F8:3 0.6989700	When input conditions go true, take the log base 10 of the value in N7:2 and store the result in F8:3. <table border="1" style="width: 100%; border-collapse: collapse; margin-top: 10px;"> <thead> <tr> <th style="width: 10%; padding: 2px;">Status Bit</th> <th style="padding: 2px;">Description</th> </tr> </thead> <tbody> <tr> <td style="text-align: center; padding: 2px;">C</td> <td style="padding: 2px;">always resets</td> </tr> <tr> <td style="text-align: center; padding: 2px;">V</td> <td style="padding: 2px;">sets if overflow is generated; otherwise resets</td> </tr> <tr> <td style="text-align: center; padding: 2px;">Z</td> <td style="padding: 2px;">sets if the result is zero; otherwise resets</td> </tr> <tr> <td style="text-align: center; padding: 2px;">S</td> <td style="padding: 2px;">sets if the result is negative; otherwise resets</td> </tr> </tbody> </table>	Status Bit	Description	C	always resets	V	sets if overflow is generated; otherwise resets	Z	sets if the result is zero; otherwise resets	S	sets if the result is negative; otherwise resets
LOG																			
LOG BASE 10																			
Source	N7:2 5																		
Dest	F8:3 0.6989700																		
Status Bit	Description																		
C	always resets																		
V	sets if overflow is generated; otherwise resets																		
Z	sets if the result is zero; otherwise resets																		
S	sets if the result is negative; otherwise resets																		

<table border="1" style="width: 100%; border-collapse: collapse;"> <tr><td style="padding: 2px;">MUL</td><td style="padding: 2px;"></td></tr> <tr><td style="padding: 2px;">MULTIPLY</td><td style="padding: 2px;"></td></tr> <tr><td style="padding: 2px;">Source A</td><td style="padding: 2px;">N7:3 3</td></tr> <tr><td style="padding: 2px;">Source B</td><td style="padding: 2px;">N7:4 1</td></tr> <tr><td style="padding: 2px;">Dest</td><td style="padding: 2px;">N7:12 3</td></tr> </table>	MUL		MULTIPLY		Source A	N7:3 3	Source B	N7:4 1	Dest	N7:12 3	Multiply MUL	When the input conditions are true, multiply the value in Source A (N7:3) by the value in Source B (N7:4) store the result in the Destination (N7:12). <table border="1" style="width: 100%; border-collapse: collapse; margin-top: 10px;"> <thead> <tr> <th style="width: 10%; padding: 2px;">Status Bit</th> <th style="padding: 2px;">Description</th> </tr> </thead> <tbody> <tr> <td style="text-align: center; padding: 2px;">C</td> <td style="padding: 2px;">always resets</td> </tr> <tr> <td style="text-align: center; padding: 2px;">V</td> <td style="padding: 2px;">sets if overflow is generated; otherwise resets</td> </tr> <tr> <td style="text-align: center; padding: 2px;">Z</td> <td style="padding: 2px;">sets if the result is zero; otherwise resets</td> </tr> <tr> <td style="text-align: center; padding: 2px;">S</td> <td style="padding: 2px;">sets if the result is negative; otherwise resets</td> </tr> </tbody> </table>	Status Bit	Description	C	always resets	V	sets if overflow is generated; otherwise resets	Z	sets if the result is zero; otherwise resets	S	sets if the result is negative; otherwise resets
MUL																						
MULTIPLY																						
Source A	N7:3 3																					
Source B	N7:4 1																					
Dest	N7:12 3																					
Status Bit	Description																					
C	always resets																					
V	sets if overflow is generated; otherwise resets																					
Z	sets if the result is zero; otherwise resets																					
S	sets if the result is negative; otherwise resets																					

Instruction	Description
-------------	-------------

NEG	
NEGATE	
Source	N7:3 3
Dest	N7:12 -3

Negate  
NEG

When the input conditions are true, take the opposite sign of the Source (N7:3) and store the result in the Destination (N7:12). This instruction turns positive values into negative values and negative values into positive values.

Status Bit	Description
C	sets if the operation generates a carry; otherwise resets
V	sets if overflow is generated; otherwise resets
Z	sets if the result is zero; otherwise resets
S	sets if the result is negative; otherwise resets

SIN	
SINE	
Source	F8:11 0.7853982
Dest	F8:12 0.7071068

Sine  
SIN

When input conditions go true, take the sine of the value in F8:11 and store the result in F8:12.

Status Bit	Description
C	always resets
V	sets if overflow is generated; otherwise resets
Z	sets if the result is zero; otherwise resets
S	sets if the result is negative; otherwise resets

SQR	
SQUARE ROOT	
Source	N7:3 25
Dest	N7:12 5

Square Root  
SQR

When the input conditions are true, take the square root of the Source (N7:3) and store the result in the Destination (N7:12).

Status Bit	Description
C	always resets
V	sets if overflow occurs during floating point to integer conversion; otherwise resets
Z	sets if the result is zero; otherwise resets
S	always reset

Instruction		Description											
SRT SORT File #N7:1 Control R6:0 Length 4 Position 0	Sort SRT Status Bits: EN-Enable DN-Done Bit ER-Error Bit	When the input conditions go from false-to-true, the values in N7:1, N7:2, N7:3.and N7:4 are sorted into ascending order.											
STD STANDARD DEVIATION File #N7:1 Dest N7:0 Control R6:0 Length 4 Position 0	Standard Deviation STD Status Bits: EN - Enable DN - Done Bit ER - Error Bit	When the input conditions go from false-to-true, take the standard deviation of the values in file #N7:1 and store the result in the Destination (N7:0).											
		<table border="1"> <thead> <tr> <th>Status Bit</th> <th>Description</th> </tr> </thead> <tbody> <tr> <td>C</td> <td>always resets</td> </tr> <tr> <td>V</td> <td>sets if overflow is generated; otherwise resets</td> </tr> <tr> <td>Z</td> <td>sets if the result is zero; otherwise resets</td> </tr> <tr> <td>S</td> <td>always resets</td> </tr> </tbody> </table>	Status Bit	Description	C	always resets	V	sets if overflow is generated; otherwise resets	Z	sets if the result is zero; otherwise resets	S	always resets	
Status Bit	Description												
C	always resets												
V	sets if overflow is generated; otherwise resets												
Z	sets if the result is zero; otherwise resets												
S	always resets												



Instruction	Description
-------------	-------------

<table border="1" style="width: 100%; border-collapse: collapse;"> <tr><td style="padding: 2px;">SUB</td><td style="padding: 2px;"></td></tr> <tr><td style="padding: 2px;">SUBTRACT</td><td style="padding: 2px;"></td></tr> <tr><td style="padding: 2px;">Source A</td><td style="padding: 2px;">N7:3 3</td></tr> <tr><td style="padding: 2px;">Source B</td><td style="padding: 2px;">N7:4 1</td></tr> <tr><td style="padding: 2px;">Dest</td><td style="padding: 2px;">N7:12 2</td></tr> </table>	SUB		SUBTRACT		Source A	N7:3 3	Source B	N7:4 1	Dest	N7:12 2	Subtract SUB	When the input conditions are true, subtract the value in Sour B (N7:4) from the value in Source A (N7:3) and store the result the Destination (N7:12).
SUB												
SUBTRACT												
Source A	N7:3 3											
Source B	N7:4 1											
Dest	N7:12 2											
		<table border="1" style="width: 100%; border-collapse: collapse;"> <thead> <tr> <th style="width: 15%; padding: 2px;">Status Bit</th> <th style="padding: 2px;">Description</th> </tr> </thead> <tbody> <tr> <td style="padding: 2px;">C</td> <td style="padding: 2px;">sets if borrow is generated; otherwise resets</td> </tr> <tr> <td style="padding: 2px;">V</td> <td style="padding: 2px;">sets if underflow is generated; otherwise resets</td> </tr> <tr> <td style="padding: 2px;">Z</td> <td style="padding: 2px;">sets if the result is zero; otherwise resets</td> </tr> <tr> <td style="padding: 2px;">S</td> <td style="padding: 2px;">sets if the result is negative; otherwise resets</td> </tr> </tbody> </table>	Status Bit	Description	C	sets if borrow is generated; otherwise resets	V	sets if underflow is generated; otherwise resets	Z	sets if the result is zero; otherwise resets	S	sets if the result is negative; otherwise resets
Status Bit	Description											
C	sets if borrow is generated; otherwise resets											
V	sets if underflow is generated; otherwise resets											
Z	sets if the result is zero; otherwise resets											
S	sets if the result is negative; otherwise resets											

<table border="1" style="width: 100%; border-collapse: collapse;"> <tr><td style="padding: 2px;">TAN</td><td style="padding: 2px;"></td></tr> <tr><td style="padding: 2px;">TANGENT</td><td style="padding: 2px;"></td></tr> <tr><td style="padding: 2px;">Source</td><td style="padding: 2px;">F8:15 0.7853982</td></tr> <tr><td style="padding: 2px;">Dest</td><td style="padding: 2px;">F8:16 1.000000</td></tr> </table>	TAN		TANGENT		Source	F8:15 0.7853982	Dest	F8:16 1.000000	Tangent TAN	When input conditions go true, take the tangent of the value in F8:15 and store the result in F8:16.		
TAN												
TANGENT												
Source	F8:15 0.7853982											
Dest	F8:16 1.000000											
		<table border="1" style="width: 100%; border-collapse: collapse;"> <thead> <tr> <th style="width: 15%; padding: 2px;">Status Bit</th> <th style="padding: 2px;">Description</th> </tr> </thead> <tbody> <tr> <td style="padding: 2px;">C</td> <td style="padding: 2px;">always resets</td> </tr> <tr> <td style="padding: 2px;">V</td> <td style="padding: 2px;">sets if overflow is generated; otherwise resets</td> </tr> <tr> <td style="padding: 2px;">Z</td> <td style="padding: 2px;">sets if the result is zero; otherwise resets</td> </tr> <tr> <td style="padding: 2px;">S</td> <td style="padding: 2px;">sets if the result is negative; otherwise resets</td> </tr> </tbody> </table>	Status Bit	Description	C	always resets	V	sets if overflow is generated; otherwise resets	Z	sets if the result is zero; otherwise resets	S	sets if the result is negative; otherwise resets
Status Bit	Description											
C	always resets											
V	sets if overflow is generated; otherwise resets											
Z	sets if the result is zero; otherwise resets											
S	sets if the result is negative; otherwise resets											

<table border="1" style="width: 100%; border-collapse: collapse;"> <tr><td style="padding: 2px;">XPY</td><td style="padding: 2px;"></td></tr> <tr><td style="padding: 2px;">X TO POWER OF Y</td><td style="padding: 2px;"></td></tr> <tr><td style="padding: 2px;">Source A</td><td style="padding: 2px;">N7:4 5</td></tr> <tr><td style="padding: 2px;">Source B</td><td style="padding: 2px;">N7:5 2</td></tr> <tr><td style="padding: 2px;">Dest</td><td style="padding: 2px;">N7:6 25</td></tr> </table>	XPY		X TO POWER OF Y		Source A	N7:4 5	Source B	N7:5 2	Dest	N7:6 25	X to the power of Y XPY	When input conditions go true, take the the value in N7:4, raise it to the power stored in N7:5, and store the result in
XPY												
X TO POWER OF Y												
Source A	N7:4 5											
Source B	N7:5 2											
Dest	N7:6 25											
		<table border="1" style="width: 100%; border-collapse: collapse;"> <thead> <tr> <th style="width: 15%; padding: 2px;">Status Bit</th> <th style="padding: 2px;">Description</th> </tr> </thead> <tbody> <tr> <td style="padding: 2px;">C</td> <td style="padding: 2px;">always resets</td> </tr> <tr> <td style="padding: 2px;">V</td> <td style="padding: 2px;">sets if overflow is generated; otherwise resets</td> </tr> <tr> <td style="padding: 2px;">Z</td> <td style="padding: 2px;">sets if the result is zero; otherwise resets</td> </tr> <tr> <td style="padding: 2px;">S</td> <td style="padding: 2px;">sets if the result is negative; otherwise resets</td> </tr> </tbody> </table>	Status Bit	Description	C	always resets	V	sets if overflow is generated; otherwise resets	Z	sets if the result is zero; otherwise resets	S	sets if the result is negative; otherwise resets
Status Bit	Description											
C	always resets											
V	sets if overflow is generated; otherwise resets											
Z	sets if the result is zero; otherwise resets											
S	sets if the result is negative; otherwise resets											

## Logical Instructions

Instruction	Description																									
<table border="1" style="width: 100%; border-collapse: collapse;"> <tr><td style="padding: 2px;">AND</td><td style="padding: 2px;"></td></tr> <tr><td style="padding: 2px;">BITWISE AND</td><td style="padding: 2px;"></td></tr> <tr><td style="padding: 2px;">Source A</td><td style="padding: 2px;">D9:3 3F37</td></tr> <tr><td style="padding: 2px;">Source B</td><td style="padding: 2px;">D9:4 00FF</td></tr> <tr><td style="padding: 2px;">Dest</td><td style="padding: 2px;">D9:5 0037</td></tr> </table>	AND		BITWISE AND		Source A	D9:3 3F37	Source B	D9:4 00FF	Dest	D9:5 0037	<p>AND</p> <p>When the input conditions are true, the controller performs an AND operation (bit-by-bit) between Source A (D9:3) and Source B (D9:4) and stores the result in the Destination (D9:5). The truth table for an AND operation is:</p> <table style="margin-left: 20px;"> <tr><td>Source A</td><td>Source B</td><td>Result</td></tr> <tr><td>000</td><td></td><td></td></tr> <tr><td>100</td><td></td><td></td></tr> <tr><td>010</td><td></td><td></td></tr> <tr><td>111</td><td></td><td></td></tr> </table>	Source A	Source B	Result	000			100			010			111		
AND																										
BITWISE AND																										
Source A	D9:3 3F37																									
Source B	D9:4 00FF																									
Dest	D9:5 0037																									
Source A	Source B	Result																								
000																										
100																										
010																										
111																										
<table border="1" style="width: 100%; border-collapse: collapse;"> <tr><td style="padding: 2px;">NOT</td><td style="padding: 2px;"></td></tr> <tr><td style="padding: 2px;">NOT</td><td style="padding: 2px;"></td></tr> <tr><td style="padding: 2px;">Source A</td><td style="padding: 2px;">D9:3 00FF</td></tr> <tr><td style="padding: 2px;">Dest</td><td style="padding: 2px;">D9:5 FF00</td></tr> </table>	NOT		NOT		Source A	D9:3 00FF	Dest	D9:5 FF00	<p>NOT Operation</p> <p>When the input conditions are true, the controller performs a NOT (takes the opposite of) operation (bit-by-bit) on the Source (D9:3) and stores the result in the Destination (D9:5). The truth table for a NOT operation is:</p> <table style="margin-left: 20px;"> <tr><td>Source</td><td>Destination</td></tr> <tr><td>01</td><td></td></tr> <tr><td>10</td><td></td></tr> </table>	Source	Destination	01		10												
NOT																										
NOT																										
Source A	D9:3 00FF																									
Dest	D9:5 FF00																									
Source	Destination																									
01																										
10																										
<table border="1" style="width: 100%; border-collapse: collapse;"> <tr><td style="padding: 2px;">OR</td><td style="padding: 2px;"></td></tr> <tr><td style="padding: 2px;">BITWISE INCLUSIVE OR</td><td style="padding: 2px;"></td></tr> <tr><td style="padding: 2px;">Source A</td><td style="padding: 2px;">D9:3 3F37</td></tr> <tr><td style="padding: 2px;">Source B</td><td style="padding: 2px;">D9:4 00FF</td></tr> <tr><td style="padding: 2px;">Dest</td><td style="padding: 2px;">D9:5 3FFF</td></tr> </table>	OR		BITWISE INCLUSIVE OR		Source A	D9:3 3F37	Source B	D9:4 00FF	Dest	D9:5 3FFF	<p>OR</p> <p>When the input conditions are true, the controller performs an OR operation (bit-by-bit) between Source A (D9:3) and Source B (D9:4) and stores the result in the Destination (D9:5). The truth table for an OR operation is:</p> <table style="margin-left: 20px;"> <tr><td>Source A</td><td>Source B</td><td>Result</td></tr> <tr><td>000</td><td></td><td></td></tr> <tr><td>101</td><td></td><td></td></tr> <tr><td>011</td><td></td><td></td></tr> <tr><td>111</td><td></td><td></td></tr> </table>	Source A	Source B	Result	000			101			011			111		
OR																										
BITWISE INCLUSIVE OR																										
Source A	D9:3 3F37																									
Source B	D9:4 00FF																									
Dest	D9:5 3FFF																									
Source A	Source B	Result																								
000																										
101																										
011																										
111																										
<table border="1" style="width: 100%; border-collapse: collapse;"> <tr><td style="padding: 2px;">XOR</td><td style="padding: 2px;"></td></tr> <tr><td style="padding: 2px;">BITWISE EXCLUSIVE OR</td><td style="padding: 2px;"></td></tr> <tr><td style="padding: 2px;">Source A</td><td style="padding: 2px;">D9:3 3F37</td></tr> <tr><td style="padding: 2px;">Source B</td><td style="padding: 2px;">D9:4 3F37</td></tr> <tr><td style="padding: 2px;">Dest</td><td style="padding: 2px;">D9:5 0000</td></tr> </table>	XOR		BITWISE EXCLUSIVE OR		Source A	D9:3 3F37	Source B	D9:4 3F37	Dest	D9:5 0000	<p>Exclusive OR XOR</p> <p>When the input conditions are true, the controller performs an exclusive OR operation (bit-by-bit) between Source A (D9:3) and Source B (D9:4) and stores the result in the Destination (D9:5). The truth table for an XOR operation is:</p> <table style="margin-left: 20px;"> <tr><td>Source A</td><td>Source B</td><td>Result</td></tr> <tr><td>000</td><td></td><td></td></tr> <tr><td>101</td><td></td><td></td></tr> <tr><td>011</td><td></td><td></td></tr> <tr><td>110</td><td></td><td></td></tr> </table>	Source A	Source B	Result	000			101			011			110		
XOR																										
BITWISE EXCLUSIVE OR																										
Source A	D9:3 3F37																									
Source B	D9:4 3F37																									
Dest	D9:5 0000																									
Source A	Source B	Result																								
000																										
101																										
011																										
110																										

Status Bit	Description
C	always
V	always
Z	sets if the result is zero; otherwise
S	sets if the most significant bit (bit 15 for decimal or bit 17 for octal) is set (1); otherwise resets

## Conversion Instructions

Instruction	Description																
<table border="1" style="border-collapse: collapse; width: 100%;"> <tr> <td style="padding: 2px;">FRD</td> <td style="padding: 2px;">FROM BCD</td> </tr> <tr> <td style="padding: 2px;">Source</td> <td style="padding: 2px;">D9:3 0037</td> </tr> <tr> <td style="padding: 2px;">Dest</td> <td style="padding: 2px;">N7:12 37</td> </tr> </table>	FRD	FROM BCD	Source	D9:3 0037	Dest	N7:12 37	<p>Convert from BCD FRD</p> <p>When the input conditions are true, convert the BCD value in the Source (D9:3) to a integer value and store the result in the Destination (N7:12). The source must be in the range of</p> <table border="1" style="border-collapse: collapse; width: 100%;"> <thead> <tr> <th style="padding: 2px;">Status Bit</th> <th style="padding: 2px;">Description</th> </tr> </thead> <tbody> <tr> <td style="padding: 2px;">C</td> <td style="padding: 2px;">always resets</td> </tr> <tr> <td style="padding: 2px;">V</td> <td style="padding: 2px;">always resets</td> </tr> <tr> <td style="padding: 2px;">Z</td> <td style="padding: 2px;">sets if the destination value is zero; otherwise resets</td> </tr> <tr> <td style="padding: 2px;">S</td> <td style="padding: 2px;">always resets</td> </tr> </tbody> </table>	Status Bit	Description	C	always resets	V	always resets	Z	sets if the destination value is zero; otherwise resets	S	always resets
FRD	FROM BCD																
Source	D9:3 0037																
Dest	N7:12 37																
Status Bit	Description																
C	always resets																
V	always resets																
Z	sets if the destination value is zero; otherwise resets																
S	always resets																
<table border="1" style="border-collapse: collapse; width: 100%;"> <tr> <td style="padding: 2px;">TOD</td> <td style="padding: 2px;">TO BCD</td> </tr> <tr> <td style="padding: 2px;">Source</td> <td style="padding: 2px;">N7:3 44</td> </tr> <tr> <td style="padding: 2px;">Dest</td> <td style="padding: 2px;">D9:5 0044</td> </tr> </table>	TOD	TO BCD	Source	N7:3 44	Dest	D9:5 0044	<p>Convert to BCD TOD</p> <p>When the input conditions are true, convert the integer value in Source (N7:3) to a BCD format and store the result in the</p> <table border="1" style="border-collapse: collapse; width: 100%;"> <thead> <tr> <th style="padding: 2px;">Status Bit</th> <th style="padding: 2px;">Description</th> </tr> </thead> <tbody> <tr> <td style="padding: 2px;">C</td> <td style="padding: 2px;">always resets</td> </tr> <tr> <td style="padding: 2px;">V</td> <td style="padding: 2px;">sets if the source value is negative or greater than 9999 (i.e. outside of the range of 0-9999)</td> </tr> <tr> <td style="padding: 2px;">Z</td> <td style="padding: 2px;">sets if the destinationvalue is zero; otherwise resets</td> </tr> <tr> <td style="padding: 2px;">S</td> <td style="padding: 2px;">always resets</td> </tr> </tbody> </table>	Status Bit	Description	C	always resets	V	sets if the source value is negative or greater than 9999 (i.e. outside of the range of 0-9999)	Z	sets if the destinationvalue is zero; otherwise resets	S	always resets
TOD	TO BCD																
Source	N7:3 44																
Dest	D9:5 0044																
Status Bit	Description																
C	always resets																
V	sets if the source value is negative or greater than 9999 (i.e. outside of the range of 0-9999)																
Z	sets if the destinationvalue is zero; otherwise resets																
S	always resets																
<table border="1" style="border-collapse: collapse; width: 100%;"> <tr> <td style="padding: 2px;">DEG</td> <td style="padding: 2px;">RADIANS TO DEGREE</td> </tr> <tr> <td style="padding: 2px;">Source</td> <td style="padding: 2px;">F8:7 0.7853982</td> </tr> <tr> <td style="padding: 2px;">Dest</td> <td style="padding: 2px;">F8:8 45</td> </tr> </table>	DEG	RADIANS TO DEGREE	Source	F8:7 0.7853982	Dest	F8:8 45	<p>Convert to Degrees DEG</p> <p>When the input conditions are true, convert radians (the value in Source A) to degrees and stores the result in the Destination (Source times 180/p).</p> <table border="1" style="border-collapse: collapse; width: 100%;"> <thead> <tr> <th style="padding: 2px;">Status Bit</th> <th style="padding: 2px;">Description</th> </tr> </thead> <tbody> <tr> <td style="padding: 2px;">C</td> <td style="padding: 2px;">always resets</td> </tr> <tr> <td style="padding: 2px;">V</td> <td style="padding: 2px;">sets if overflow generated; otherwise resets</td> </tr> <tr> <td style="padding: 2px;">Z</td> <td style="padding: 2px;">sets if result is zero; otherwise resets</td> </tr> <tr> <td style="padding: 2px;">S</td> <td style="padding: 2px;">sets if result is negative; otherwise resets</td> </tr> </tbody> </table>	Status Bit	Description	C	always resets	V	sets if overflow generated; otherwise resets	Z	sets if result is zero; otherwise resets	S	sets if result is negative; otherwise resets
DEG	RADIANS TO DEGREE																
Source	F8:7 0.7853982																
Dest	F8:8 45																
Status Bit	Description																
C	always resets																
V	sets if overflow generated; otherwise resets																
Z	sets if result is zero; otherwise resets																
S	sets if result is negative; otherwise resets																

Instruction	Description										
RAD DEGREES TO RADIAN Source        N7:9 45 Dest            F8:10 0.785398	Convert to Radians RAD When the input conditions are true, convert degrees (the value in Source A) to radians and stores the result in the Destination (Source times p/180).  <table border="1" style="width: 100%; border-collapse: collapse;"> <thead> <tr> <th style="width: 10%;">Status Bit</th> <th>Description</th> </tr> </thead> <tbody> <tr> <td>C</td> <td>always resets</td> </tr> <tr> <td>V</td> <td>sets if overflow generated; otherwise resets</td> </tr> <tr> <td>Z</td> <td>sets if result is zero; otherwise resets</td> </tr> <tr> <td>S</td> <td>sets if result is negative; otherwise resets</td> </tr> </tbody> </table>	Status Bit	Description	C	always resets	V	sets if overflow generated; otherwise resets	Z	sets if result is zero; otherwise resets	S	sets if result is negative; otherwise resets
Status Bit	Description										
C	always resets										
V	sets if overflow generated; otherwise resets										
Z	sets if result is zero; otherwise resets										
S	sets if result is negative; otherwise resets										

### Bit Modify and Move Instructions

Instruction	Description										
MOV MOVE Source        N7:3 20 Dest            F8:12 20.000000	Move MOV When the input conditions are true, move a copy of the value in Source (N7:3) to the Destination (F8:12), converting from one data type to another. This overwrites the original value in the Destination.  <table border="1" style="width: 100%; border-collapse: collapse;"> <thead> <tr> <th style="width: 10%;">Status Bit</th> <th>Description</th> </tr> </thead> <tbody> <tr> <td>C</td> <td>always resets</td> </tr> <tr> <td>V</td> <td>sets if overflow is generated during floating point-to-integer conversion; otherwise resets</td> </tr> <tr> <td>Z</td> <td>sets if the destination value is zero; otherwise resets</td> </tr> <tr> <td>S</td> <td>sets if result MSB is set; otherwise resets</td> </tr> </tbody> </table>	Status Bit	Description	C	always resets	V	sets if overflow is generated during floating point-to-integer conversion; otherwise resets	Z	sets if the destination value is zero; otherwise resets	S	sets if result MSB is set; otherwise resets
Status Bit	Description										
C	always resets										
V	sets if overflow is generated during floating point-to-integer conversion; otherwise resets										
Z	sets if the destination value is zero; otherwise resets										
S	sets if result MSB is set; otherwise resets										

MVM MASKED MOVE Source        D9:3 478F Mask          D9:5 00FF Dest            D9:12 008F	Masked Move MVM When the input conditions are true, the controller passes the value in the Source (D9:3) through the Mask (D9:5) and stores the result in the Destination (D9:12). This overwrites the original value in the Destination.  <table border="1" style="width: 100%; border-collapse: collapse;"> <thead> <tr> <th style="width: 10%;">Status Bit</th> <th>Description</th> </tr> </thead> <tbody> <tr> <td>C</td> <td>always resets</td> </tr> <tr> <td>V</td> <td>always resets</td> </tr> <tr> <td>Z</td> <td>sets if the result is zero; otherwise resets</td> </tr> <tr> <td>S</td> <td>sets if most significant bit of resulting value is set; otherwise resets.</td> </tr> </tbody> </table>	Status Bit	Description	C	always resets	V	always resets	Z	sets if the result is zero; otherwise resets	S	sets if most significant bit of resulting value is set; otherwise resets.
Status Bit	Description										
C	always resets										
V	always resets										
Z	sets if the result is zero; otherwise resets										
S	sets if most significant bit of resulting value is set; otherwise resets.										

Instruction	Description																		
<table border="1" style="width: 100%;"> <tr> <td colspan="2">BTD</td> </tr> <tr> <td colspan="2">BIT FIELD DISTRIB</td> </tr> <tr> <td>Source</td> <td>N7:3</td> </tr> <tr> <td></td> <td>0</td> </tr> <tr> <td>Source bit</td> <td>3</td> </tr> <tr> <td>Dest</td> <td>N7:4</td> </tr> <tr> <td></td> <td>0</td> </tr> <tr> <td>Dest bit</td> <td>10</td> </tr> <tr> <td>Length</td> <td>6</td> </tr> </table>	BTD		BIT FIELD DISTRIB		Source	N7:3		0	Source bit	3	Dest	N7:4		0	Dest bit	10	Length	6	<p>Bit Distribute BTD</p> <p>When the input conditions are true, the controller copies the number of bits specified by Length, starting with the Source bit (3) of the Source (N7:3), and placing the values in the Destination (N7:4), starting with the Destination bit (10).</p>
BTD																			
BIT FIELD DISTRIB																			
Source	N7:3																		
	0																		
Source bit	3																		
Dest	N7:4																		
	0																		
Dest bit	10																		
Length	6																		

## File Instructions

Instruction	Description																
<table border="1" style="width: 100%;"> <tr> <td colspan="2">FAL</td> </tr> <tr> <td colspan="2">FILE ARITH/LOGICAL</td> </tr> <tr> <td>Control</td> <td>R6:1</td> </tr> <tr> <td>Length</td> <td>8</td> </tr> <tr> <td>Position</td> <td>0</td> </tr> <tr> <td>Mode</td> <td>ALL</td> </tr> <tr> <td>Dest</td> <td>#N15:10</td> </tr> <tr> <td>Expression</td> <td>#N14:0 - 256</td> </tr> </table>	FAL		FILE ARITH/LOGICAL		Control	R6:1	Length	8	Position	0	Mode	ALL	Dest	#N15:10	Expression	#N14:0 - 256	<p>File Arithmetic and Logic FAL</p> <p>Status Bits: EN - Enable DN - Done Bit ER - Error Bit</p> <p>When the input conditions go from false-to-true, the controller reads 8 elements of N14:0, and subtracts 256 (a constant) from each element. This example shows the result being stored in the eight elements beginning with N15:10. The control element R6:1 controls the operation. The Mode determines whether the controller performs the expression on all elements in the files (ALL) per program scan, one element in the files (INC) per false-to-true transition, or a specific number of elements (NUM) per scan.</p> <p>The FAL instruction can perform these operations: add (+), subtract (-), multiply (*), divide (/), convert from BCD (FRD), convert to BCD (TOD), square root (SQR), logical and (AND), logical or (OR), logical not (NOT), exclusive or (XOR), negate (-), clear (0), move, and the new math instructions (see the CPT list).</p>
FAL																	
FILE ARITH/LOGICAL																	
Control	R6:1																
Length	8																
Position	0																
Mode	ALL																
Dest	#N15:10																
Expression	#N14:0 - 256																
<table border="1" style="width: 100%;"> <tr> <td colspan="2">FSC</td> </tr> <tr> <td colspan="2">FILE SEARCH/COMPARE</td> </tr> <tr> <td>Control</td> <td>R9:0</td> </tr> <tr> <td>Length</td> <td>90</td> </tr> <tr> <td>Position</td> <td>0</td> </tr> <tr> <td>Mode</td> <td>10</td> </tr> <tr> <td>Expression</td> <td>#B4:0 &lt;&gt; #B5:0</td> </tr> </table>	FSC		FILE SEARCH/COMPARE		Control	R9:0	Length	90	Position	0	Mode	10	Expression	#B4:0 <> #B5:0	<p>File Search and Compare FSC</p> <p>Status Bits: EN - Enable DN - Done Bit ER - Error Bit IN - Inhibit Bit FD - Found Bit</p> <p>When the input conditions go from false-to-true, the controller performs the not-equal-to comparison on 10 elements between files B4:0 and B5:0. Mode determines whether the controller performs the expression on all elements in the files (ALL) per program scan, one element in the files (INC) per false-to-true transition, or a specific number of elements (NUM) per scan. Control element R9:0 controls the operation.</p> <p>When the corresponding source elements are not equal (element B4:4 and B5:4 in this example), the controller stops the search and sets the found .FD and inhibit .IN bits so your ladder program can take appropriate action. To continue the search comparison, you must reset the .IN bit.</p> <p>To see a list of the available comparisons, see the comparisons listed under the CMP instruction.</p>		
FSC																	
FILE SEARCH/COMPARE																	
Control	R9:0																
Length	90																
Position	0																
Mode	10																
Expression	#B4:0 <> #B5:0																

Instruction		Description										
<table border="1"> <tr> <td colspan="2">COP</td> </tr> <tr> <td colspan="2">COPY FILE</td> </tr> <tr> <td>Source</td> <td>#N7:0</td> </tr> <tr> <td>Dest</td> <td>#N12:0</td> </tr> <tr> <td>Length</td> <td>5</td> </tr> </table>	COP		COPY FILE		Source	#N7:0	Dest	#N12:0	Length	5	File Copy COP	<p>When the input conditions are true, the controller copies the contents of the Source file (N7) into the Destination file (N12). The source remains unchanged. The COP instruction copies the number of elements from the source as specified by the Length.</p> <p>As opposed to the MOV instruction, there is no data type conversion for this instruction.</p>
COP												
COPY FILE												
Source	#N7:0											
Dest	#N12:0											
Length	5											
<table border="1"> <tr> <td colspan="2">FLL</td> </tr> <tr> <td colspan="2">FILL FILE</td> </tr> <tr> <td>Source</td> <td>N10:6</td> </tr> <tr> <td>Dest</td> <td>#N12:0</td> </tr> <tr> <td>Length</td> <td>5</td> </tr> </table>	FLL		FILL FILE		Source	N10:6	Dest	#N12:0	Length	5	File Fill FLL	<p>When the input conditions are true, the controller copies the value in Source (N10:6) to the elements in the Destination (N12). The FLL instruction only fills as many elements in the destination as specified in the Length.</p> <p>As opposed to the MOV instruction, there is no data type conversion for this instruction.</p>
FLL												
FILL FILE												
Source	N10:6											
Dest	#N12:0											
Length	5											

## Diagnostic Instructions

Instruction	Description																						
<table border="1" style="width: 100%; border-collapse: collapse;"> <tr> <td colspan="2" style="text-align: left; padding: 2px;">FBC</td> </tr> <tr> <td colspan="2" style="text-align: left; padding: 2px;">FILE BIT COMPARE</td> </tr> <tr> <td style="padding: 2px;">Source</td> <td style="padding: 2px;">#I:031</td> </tr> <tr> <td style="padding: 2px;">Reference</td> <td style="padding: 2px;">#B3:1</td> </tr> <tr> <td style="padding: 2px;">Result</td> <td style="padding: 2px;">#N7:0</td> </tr> <tr> <td style="padding: 2px;">Cmp Control</td> <td style="padding: 2px;">R6:4</td> </tr> <tr> <td style="padding: 2px;">Length</td> <td style="padding: 2px;">48</td> </tr> <tr> <td style="padding: 2px;">Position</td> <td style="padding: 2px;">0</td> </tr> <tr> <td style="padding: 2px;">Result Control</td> <td style="padding: 2px;">R6:5</td> </tr> <tr> <td style="padding: 2px;">Length</td> <td style="padding: 2px;">10</td> </tr> <tr> <td style="padding: 2px;">Position</td> <td style="padding: 2px;">0</td> </tr> </table>	FBC		FILE BIT COMPARE		Source	#I:031	Reference	#B3:1	Result	#N7:0	Cmp Control	R6:4	Length	48	Position	0	Result Control	R6:5	Length	10	Position	0	<p>File Bit Compare FBC</p> <p>Status Bits: EN - Enable DN - Done Bit ER - Error Bit IN - Inhibit Bit FD - Found Bit</p> <p>When the input conditions go from false-to-true, the controller compares the number of bits specified in the CMP Control Length (48) of the Source file (#I:031) with the bits in the Reference file (#B3:1). The controller stores the results (mismatched bit numbers) in the Result file (#N7:0). File R6:4 controls the compare and file R6:5 controls the file that contains the results. The file containing the results can hold up to 10 (the number specified in the Length field) mismatches between the compared files.</p> <p><b>Note:</b> To avoid encountering a possible run-time error when executing this instruction, add a ladder rung that clears S:24 (indexed addressing offset) immediately before a FBC instruction.</p>
FBC																							
FILE BIT COMPARE																							
Source	#I:031																						
Reference	#B3:1																						
Result	#N7:0																						
Cmp Control	R6:4																						
Length	48																						
Position	0																						
Result Control	R6:5																						
Length	10																						
Position	0																						
<table border="1" style="width: 100%; border-collapse: collapse;"> <tr> <td colspan="2" style="text-align: left; padding: 2px;">DDT</td> </tr> <tr> <td colspan="2" style="text-align: left; padding: 2px;">DIAGNOSTIC DETECT</td> </tr> <tr> <td style="padding: 2px;">Source</td> <td style="padding: 2px;">#I:030</td> </tr> <tr> <td style="padding: 2px;">Reference</td> <td style="padding: 2px;">#B3:1</td> </tr> <tr> <td style="padding: 2px;">Result</td> <td style="padding: 2px;">#N10:0</td> </tr> <tr> <td style="padding: 2px;">Cmp Control</td> <td style="padding: 2px;">R6:0</td> </tr> <tr> <td style="padding: 2px;">Length</td> <td style="padding: 2px;">20</td> </tr> <tr> <td style="padding: 2px;">Position</td> <td style="padding: 2px;">0</td> </tr> <tr> <td style="padding: 2px;">Result Control</td> <td style="padding: 2px;">R6:1</td> </tr> <tr> <td style="padding: 2px;">Length</td> <td style="padding: 2px;">5</td> </tr> <tr> <td style="padding: 2px;">Position</td> <td style="padding: 2px;">0</td> </tr> </table>	DDT		DIAGNOSTIC DETECT		Source	#I:030	Reference	#B3:1	Result	#N10:0	Cmp Control	R6:0	Length	20	Position	0	Result Control	R6:1	Length	5	Position	0	<p>Diagnostic Detect DDT</p> <p>Status Bits: EN - Enable DN - Done Bit ER - Error Bit IN - Inhibit Bit FD - Found Bit</p> <p>When the input conditions go from false-to-true, the controller compares the number of bits specified in the CMP Control Length (20) of the Source file (# I:030) with the bits in the Reference file (#B3:1). The controller stores the results (mismatched bit numbers) in the Result file (#N10:0). Control element R6:0 controls the compare and the control element R6:1 controls the file that contains the results (#N10:0). The file containing the results can hold up to 5 (the number specified in the Length field) mismatches between the compared files. The controller copies the source bits to the reference file for the next comparison.</p> <p>The difference between the DDT and FBC instruction is that each time the DDT instruction finds a mismatch, the controller changes the reference bit to match the source bit. You can use the DDT instruction to update your reference file to reflect changing machine or process conditions.</p> <p><b>Note:</b> To avoid encountering a possible run-time error when executing this instruction, add a ladder rung that clears S:24 (indexed addressing offset) immediately before a DDT instruction.</p>
DDT																							
DIAGNOSTIC DETECT																							
Source	#I:030																						
Reference	#B3:1																						
Result	#N10:0																						
Cmp Control	R6:0																						
Length	20																						
Position	0																						
Result Control	R6:1																						
Length	5																						
Position	0																						
<table border="1" style="width: 100%; border-collapse: collapse;"> <tr> <td colspan="2" style="text-align: left; padding: 2px;">DTR</td> </tr> <tr> <td colspan="2" style="text-align: left; padding: 2px;">DATA TRANSITION</td> </tr> <tr> <td style="padding: 2px;">Source</td> <td style="padding: 2px;">I:002</td> </tr> <tr> <td style="padding: 2px;">Mask</td> <td style="padding: 2px;">OFFF</td> </tr> <tr> <td style="padding: 2px;">Reference</td> <td style="padding: 2px;">N63:11</td> </tr> </table>	DTR		DATA TRANSITION		Source	I:002	Mask	OFFF	Reference	N63:11	<p>Data Transition DTR</p> <p>The DTR instruction compares the bits in the Source (I:002) through a Mask (OFFF) with the bits in the Reference (N63:11). When the masked source is different than the reference, the instruction is true for only 1 scan. The source bits are written into the reference address for the next comparison. When the masked source and the reference are the same, the instruction remains false.</p>												
DTR																							
DATA TRANSITION																							
Source	I:002																						
Mask	OFFF																						
Reference	N63:11																						

## Shift Register Instructions

Instruction	Description
<div style="border: 1px solid black; padding: 5px;"> <p>BSL BIT SHIFT LEFT</p> <p>File #B3:1 Control R6:53 Bit Address I:022/12 Length 5</p> </div>	<p>Bit Shift Left BSL</p> <p>Status Bits: EN - Enable DN - Done Bit ER - Error Bit UL - Unload Bit</p> <p>If the input conditions go from false-to-true, the BSL instruction shifts the number of bits specified by Length (5) in File (B3), starting at bit 16 (B3:1/0 = B3/16), to the left by one bit position. The source bit (I:022/12) shifts into the first bit position, B3:1/0 (B3/16). The fifth bit, B3:1/4 (B3/20), is shifted into the UL bit of the control structure (R6:53).</p>
<div style="border: 1px solid black; padding: 5px;"> <p>BSR BIT SHIFT RIGHT</p> <p>File #B3:2 Control R6:54 Bit Address I:023/06 Length 3</p> </div>	<p>Bit Shift Right BSR</p> <p>Status Bits: EN - Enable DN - Done Bit ER - Error Bit UL - Unload Bit</p> <p>If the input conditions go from false-to-true, the BSR instruction shifts the number of bits specified by Length (3) in File (B3), starting with B3:2/0 (=B3/32), to the right by one bit position. The source bit (I:023/06) shifts into the third bit position B3/34. The first bit (B3/32) is shifted into the UL bit of the control element (R6:54).</p>
<div style="border: 1px solid black; padding: 5px;"> <p>FFL FIFO LOAD</p> <p>Source N60:1 FIFO #N60:3 Control R6:51 Length 64 Position 0</p> </div>	<p>FIFO Load FFL</p> <p>Status Bits: EN - Enable Load DN - Done Bit EM - Empty Bit</p> <p>When the input conditions go from false-to-true, the controller loads N60:1 into the next available element in the FIFO file, #N60:3, as pointed to by R6:51. Each time the rung goes from false-to-true, the controller loads another element. When the FIFO file (stack) is full, (64 words loaded), the DN bit is set.</p> <p>See page F-8 for a description of prescan activities for this instruction.</p>
<div style="border: 1px solid black; padding: 5px;"> <p>FFU FIFO UNLOAD</p> <p>FIFO #N60:3 Dest N60:2 Control R6:51 Length 64 Position 0</p> </div>	<p>FIFO Unload FFU</p> <p>Status Bits: EU - Enable Unload DN - Done Bit EM - Empty Bit</p> <p>When the input conditions go from false-to-true, the controller unloads an element from #N60:3 into N60:2. Each time the rung goes from false-to-true, the controller unloads another value. All the data in file #N60:3 is shifted one position toward N60:3. When the file is empty, the EM bit is set.</p> <p>See page F-8 for a description of prescan activities for this instruction.</p>



Instruction	Description														
<table border="1"> <tr> <td>LFL</td> <td></td> </tr> <tr> <td colspan="2">LIFO LOAD</td> </tr> <tr> <td>Source</td> <td>N70:1</td> </tr> <tr> <td>LIFO</td> <td>#N70:3</td> </tr> <tr> <td>Control</td> <td>R6:61</td> </tr> <tr> <td>Length</td> <td>64</td> </tr> <tr> <td>Position</td> <td>0</td> </tr> </table>	LFL		LIFO LOAD		Source	N70:1	LIFO	#N70:3	Control	R6:61	Length	64	Position	0	<p>LIFO Load LFL</p> <p>Status Bits: EN - Enable Load DN - Done Bit EM - Empty Bit</p> <p>When the input conditions go from false-to-true, the controller loads N70:1 into the next available element in the LIFO file #N70:3, as pointed to by R6:61. Each time the rung goes from false-to-true, the controller loads another element. When the LIFO file (stack) is full (64 words have been loaded), the DN bit is set.</p> <p>See page F-8 for a description of prescan activities for this instruction.</p>
LFL															
LIFO LOAD															
Source	N70:1														
LIFO	#N70:3														
Control	R6:61														
Length	64														
Position	0														
<table border="1"> <tr> <td>LFU</td> <td></td> </tr> <tr> <td colspan="2">LIFO UNLOAD</td> </tr> <tr> <td>LIFO</td> <td>#N70:3</td> </tr> <tr> <td>Dest</td> <td>N70:2</td> </tr> <tr> <td>Control</td> <td>R6:61</td> </tr> <tr> <td>Length</td> <td>64</td> </tr> <tr> <td>Position</td> <td>0</td> </tr> </table>	LFU		LIFO UNLOAD		LIFO	#N70:3	Dest	N70:2	Control	R6:61	Length	64	Position	0	<p>LIFO Unload LFU</p> <p>Status Bits: EU - Enable Unload DN - Done Bit EM - Empty Bit</p> <p>When the input conditions go from false-to-true, the controller unloads the last element from #N70:3 and puts it into N70:2. Each time the rung goes from false-to-true, the controller unloads another element. When the LIFO file is empty, the EM bit is set.</p> <p>See page F-8 for a description of prescan activities for this instruction.</p>
LFU															
LIFO UNLOAD															
LIFO	#N70:3														
Dest	N70:2														
Control	R6:61														
Length	64														
Position	0														



### Sequencer Instructions



Instruction	Description																
<table border="1"> <tr> <td>SQL</td> <td></td> </tr> <tr> <td colspan="2">SEQUENCER INPUT</td> </tr> <tr> <td>File</td> <td>#N7:11</td> </tr> <tr> <td>Mask</td> <td>FFF0</td> </tr> <tr> <td>Source</td> <td>I:031</td> </tr> <tr> <td>Control</td> <td>R6:21</td> </tr> <tr> <td>Length</td> <td>4</td> </tr> <tr> <td>Position</td> <td>0</td> </tr> </table>	SQL		SEQUENCER INPUT		File	#N7:11	Mask	FFF0	Source	I:031	Control	R6:21	Length	4	Position	0	<p>Sequencer Input SQL</p> <p>The SQL instruction filters the Source (I:031) input image data through a Mask (FFF0) and compare the result to Reference data (#N7:11) to see if the two values are equal. The operation is controlled by the information in the control file R6:21. When the status of all unmasked bits of the word pointed to by control element R6:21 matches the corresponding reference bits, the rung condition remains true if preceded by a true rung condition.</p>
SQL																	
SEQUENCER INPUT																	
File	#N7:11																
Mask	FFF0																
Source	I:031																
Control	R6:21																
Length	4																
Position	0																
<table border="1"> <tr> <td>SQL</td> <td></td> </tr> <tr> <td colspan="2">SEQUENCER LOAD</td> </tr> <tr> <td>File</td> <td>#N7:20</td> </tr> <tr> <td>Source</td> <td>I:002</td> </tr> <tr> <td>Control</td> <td>R6:22</td> </tr> <tr> <td>Length</td> <td>5</td> </tr> <tr> <td>Position</td> <td>0</td> </tr> </table>	SQL		SEQUENCER LOAD		File	#N7:20	Source	I:002	Control	R6:22	Length	5	Position	0	<p>Sequencer Load SQL</p> <p>Status Bits: EN - Enable DN - Done Bit ER - Error Bit</p> <p>The SQL instruction loads data into the sequencer File (#N7:20) from the source word (I:002) by stepping through the number of elements specified by Length (5) of the Source (I:002), starting at the Position (0). The operation is controlled by the information in the control file R6:22. When the rung goes from false-to-true, the SQL instruction increments the next step in the sequencer file and loads the data into it for every scan that the rung remains true.</p> <p>See page F-8 for a description of prescan operation for this instruction.</p>		
SQL																	
SEQUENCER LOAD																	
File	#N7:20																
Source	I:002																
Control	R6:22																
Length	5																
Position	0																

Instruction	Description
<div style="border: 1px solid black; padding: 5px; width: fit-content;"> <p>SQO</p> <p>SEQUENCER OUTPUT</p> <p>File #N7:1</p> <p>Mask 0F0F</p> <p>Dest 0:014</p> <p>Control R6:20</p> <p>Length 4</p> <p>Position 0</p> </div>	<p>Sequencer Output SQO</p> <p># Status Bits: EN - Enable DN - Done Bit ER - Error Bit</p> <p>When the rung goes from false-to-true, the SQO instruction increments to the next step in the sequencer File (#N7:1). The data in the sequencer file is transferred through a Mask (0F0F) to the Destination (0:014) for every scan that the rung remains true.</p> <p>See page F-8 for a description of prescan operation for this instruction.</p>

### Program Control Instructions

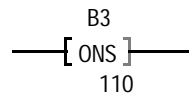
Instruction	Description
<p>———— (MCR) ————</p>	<p>Master Control Reset MCR</p> <p>If the input conditions are true, the program scans the rungs between MCR instruction rungs and processes the outputs normally. If the input condition is false, rungs between the MCR-instruction rungs are executed as false.</p>
<p>———— (JMP) ————</p> <p style="text-align: center;">10</p>	<p>Jump JMP</p> <p>If the input conditions are true, the controller skips rungs by jumping to the rung identified by the label (10).</p>
<p>———— [ LBL ] ————</p> <p style="text-align: center;">10</p>	<p>Label LBL</p> <p>When the controller reads a JMP instruction that corresponds to label 10, the controller jumps to the rung containing the label and starts executing.</p> <p><b>Important:</b> Must be the first instruction on a rung.</p>
<div style="border: 1px solid black; padding: 5px; width: fit-content;"> <p>FOR</p> <p>FOR</p> <p>Label Number 0</p> <p>Index N7:0</p> <p>Initial Value 0</p> <p>Terminal Value 10</p> <p>Step Size 1</p> </div>	<p>FOR Loop FOR</p> <p>The controller executes the rungs between the FOR and the NXT instruction repeatedly in one program scan, until it reaches the terminal value (10) or until a BRK instruction aborts the operation. Step size is how the loop index is incremented.</p> <p>See page F-8 for a description of prescan operation for this instruction.</p>
<div style="border: 1px solid black; padding: 5px; width: fit-content;"> <p>NXT</p> <p>NEXT</p> <p>Label Number 0</p> </div>	<p>Next NXT</p> <p>The NXT instruction returns the controller to the corresponding FOR instruction, identified by the label number specified in the FOR instruction. NXT must be programmed on an unconditional rung that is the last rung to be repeated in a For-Next loop.</p>
<p>———— [ BRK ] ————</p>	<p>Break BRK</p> <p>When the input conditions go true, the BRK instruction aborts a For-Next loop.</p>

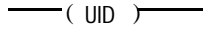
Instruction		Description
<div style="border: 1px solid black; padding: 5px;">                     JSR                      JUMP TO SUBROUTINE                      Program File    90                      Input par        N16:23                      Input par        N16:24                      Input par        231                      Return par      N19:11                      Return par      N19:12                 </div>	Jump to Subroutine JSR	If the input conditions are true, the controller starts running a subroutine Program File (90). The controller passes the Input Parameters (N16:23, N16:24, 231) to the subroutine and the RET instruction passes Return Parameters (N19:11, N19:12) back to the main program, where the controller encountered the JSR instruction.
<div style="border: 1px solid black; padding: 5px;">                     SBR                      SUBROUTINE                      Input par        N43:0                      Input par        N43:1                      Input par        N43:2                 </div>	Subroutine SBR	The SBR instruction is the first instruction in a subroutine file. This instruction identifies Input Parameters (N43:0, N43:1, N43:2) the controller receives from the corresponding JSR instruction. You do not need the SBR instruction if you do not pass input parameters to the subroutine.
<div style="border: 1px solid black; padding: 5px;">                     RET                      RETURN ()                      Return par      N43:3                      Return par      N43:4                 </div>	Return RET	If the input conditions are true, the RET instruction ends the subroutine and stores the Return Parameters (N43:3, N43:4) to be returned to the JSR instruction in the main program.
	Always False AFI	The AFI instruction disables the rung (i.e., the rung is always false).
	Temporary End TND	If the input conditions are true, the TND instruction stops the controller from scanning the rest of the program (i.e., this instruction temporarily ends the program).
	One Shot ONS	If the input conditions preceding the ONS instructions on the same rung go from false-to-true, the ONS instruction conditions the rung so that the output is true for one scan. The rung is false on successive scans.  See page F-8 for a description of prescan operation for this instruction.
<div style="border: 1px solid black; padding: 5px;">                     OSF                      ONE SHOT FALLING                      Storage Bit      B3/0                      Output Bit       15                      Output Word     N7:0                 </div>	One Shot Falling OSF  Status Bits: OB - Output Bit SB - Storage Bit	The OSF instruction triggers an event to occur one time. Use the OSF instruction whenever an event must start based on the change of state of a rung from true-to-false, not on the resulting rung status. The output bit (N7:0/15) is set (1) for one program scan when the rung goes from true-to-false.  See page F-8 for a description of prescan operation for this instruction.
<div style="border: 1px solid black; padding: 5px;">                     OSR                      ONE SHOT RISING                      Storage Bit      B3/0                      Output Bit       15                      Output Word     N7:0                 </div>	One Shot Rising OSR  Status Bits: OB - Output Bit SB - Storage Bit	The OSR instruction triggers an event to occur one time. Use the OSR instruction whenever an event must start based on the change of state of a rung from false-to-true, not on the resulting rung status. The output bit (N7:0/15) is set (1) for one program scan when the rung goes from false-to-true.  See page F-8 for a description of prescan operation for this instruction.

Instruction		Description
<div style="border: 1px solid black; padding: 5px; display: inline-block;">                     SFR                      SFC Reset                      Prog File Number 3                      Restart Step At                 </div>	SFC Reset SFR	The SFR instruction resets the logic in a sequential function chart. When the SFR instruction goes true, the controller performs a lastscan/postscan on all active steps and actions in the selected file, and then resets the logic in the SFC on the next program scan. The chart remains in this reset state until the SFR instruction goes false.
	End of Transition EOT	The EOT instruction should be the last instruction in a transition file. If you do not use an EOT instruction, the controller always evaluates the transition as true.  See page F-8 for a description of prescan operation for this instruction.
	User Interrupt Disable UID	The UID instruction temporarily disables an interrupt-driven ladder program (such as an STI or PII) from interrupting the currently executing program.
	User Interrupt Enable UIE	The UIE instruction re-enables the interrupt-driven ladder program to interrupt the currently executing ladder program.

## Process Control, Message Instructions

Instruction	Description																
<div style="border: 1px solid black; padding: 5px; margin-bottom: 10px;">                     PID                      PID                      Control Block PD10:0                      Proc Variable N15:13                      Tieback N15:14                      Control Output N20:21                 </div>	<p>Proportional, Integral, and Derivative PID</p> <p>Status Bits: EN - Enable DN - Done Bit (for N control blocks only)</p> <p>The control block (PD10:0) contains the instruction information for the PID. The PID gets the process variable from N15:13 and sends the PID output to N20:21. The tieback stored in N15:14 handles the manual control station.</p> <p>If you use an N control block, the rung must transition from false to true for execution.</p> <p>If you use PD control block, then there is no done bit. Also, the rung input conditions need to be true.</p> <p>See page F-8 for a description of prescan operation for this instruction.</p>																
<div style="border: 1px solid black; padding: 5px; margin-bottom: 10px;">                     MSG                      SEND/RECEIVE MESSAGE                      Control Block MG7:10                 </div> <table border="1" style="border-collapse: collapse; width: 100%;"> <thead> <tr> <th style="text-align: left;">Bit #</th> <th style="text-align: left;">Status Bits</th> </tr> </thead> <tbody> <tr><td>15</td><td>EN - Enable</td></tr> <tr><td>14</td><td>ST - Start Bit</td></tr> <tr><td>13</td><td>DN - Done Bit</td></tr> <tr><td>12</td><td>ER - Error Bit</td></tr> <tr><td>11</td><td>CO - Continuous</td></tr> <tr><td>10</td><td>EW - Enabled-Waiting</td></tr> <tr><td>9</td><td>NR - No Response</td></tr> </tbody> </table>	Bit #	Status Bits	15	EN - Enable	14	ST - Start Bit	13	DN - Done Bit	12	ER - Error Bit	11	CO - Continuous	10	EW - Enabled-Waiting	9	NR - No Response	<p>If the input conditions go from false to true, the data is transferred according to the instruction parameters you set when you entered the message instruction. The Control Block (MG7:10) contains status and instruction parameters.</p> <p>You can also use N control blocks.</p> <p>For continuous MSGs, condition the rung to be true for only one scan.</p> <p>See page F-8 for a description of prescan operation for this instruction.</p>
Bit #	Status Bits																
15	EN - Enable																
14	ST - Start Bit																
13	DN - Done Bit																
12	ER - Error Bit																
11	CO - Continuous																
10	EW - Enabled-Waiting																
9	NR - No Response																

## Block Transfer Instructions

Integer (N) control block

Word Offset	Description
0	status bits (see below)
1	requested word count
2	transmitted word count
3	file number
4	element number

Block Transfer (BT) control block

Word Mnemonic	Description
.EN through .RW	status bits
.RLEN	requested length
.DLEN	transmitted word length/error code
.FILE	file number
.ELEM	element number
.RGS	rack/group/slot

Word 0

15	14	13	12	11	10	09	08	07	06	05	04	03	02	01	00
EN	ST	DN	ER	CO	EW	NR	TO	RW	**	rack	**	**	group**	slot	

Instruction	Description																		
<table border="1" style="width: 100%;"> <tr> <td colspan="2">BTR</td> </tr> <tr> <td colspan="2">BLOCK TRANSFER READ</td> </tr> <tr> <td>Rack</td> <td style="text-align: right;">1</td> </tr> <tr> <td>Group</td> <td style="text-align: right;">0</td> </tr> <tr> <td>Module</td> <td style="text-align: right;">0</td> </tr> <tr> <td>Control Block</td> <td style="text-align: right;">BT11:100</td> </tr> <tr> <td>Data File</td> <td style="text-align: right;">N10:110</td> </tr> <tr> <td>Length</td> <td style="text-align: right;">40</td> </tr> <tr> <td>Continuous</td> <td style="text-align: right;">Y</td> </tr> </table>	BTR		BLOCK TRANSFER READ		Rack	1	Group	0	Module	0	Control Block	BT11:100	Data File	N10:110	Length	40	Continuous	Y	<p>Block Transfer Read BTR</p> <p>If the input conditions go from false to true, a block transfer read is initiated for the I/O module located at rack 1, group 0, module 0. The Control Block (BT11:100, 6-word file) contains status for the transfer. The Data File (N10:110) is where the data read from the module is stored. The BT Length (40) identifies the number of words in the transfer. A non-continuous block transfer is queued and run only once on a false-to-true rung transition; a continuous block transfer is repeatedly requested.</p>
BTR																			
BLOCK TRANSFER READ																			
Rack	1																		
Group	0																		
Module	0																		
Control Block	BT11:100																		
Data File	N10:110																		
Length	40																		
Continuous	Y																		

You can also use the N data type for the control blocks.

See page F-8 for a description of prescan operation for this instruction.

PLC-5/30, -5/40, -5/40E, -5/40L -5/60, -5/60L, -5/80, -5/80E controllers		PLC-5/40, -5/40L, -5/60, -5/60L, -5/80, -5/40E, -5/80E controllers		PLC-5/60, -5/60L, -5/80, -5/80E controllers	
S:7 bit #	BT queue full for rack	S:32 bit #	BT queue full for rack	S:34 bit #	BT queue full for rack
08 <sup>(1)</sup>	0	08	10	08	20
09 <sup>1</sup>	1	09	11	09	21
10 <sup>1</sup>	2	10	12	10	22
11 <sup>1</sup>	3	11	13	11	23
12	4	12	14	12	24
13	5	13	15	13	25
14	6	14	16	14	26
15	7	15	17	15	27

<sup>(1)</sup> PLC-5/11, -5/20, and 5/20E controllers also

Instruction	Description																		
<table border="1" style="width: 100%;"> <tr> <td colspan="2">BTW</td> </tr> <tr> <td colspan="2">BLOCK TRANSFER WRITE</td> </tr> <tr> <td>Rack</td> <td style="text-align: right;">1</td> </tr> <tr> <td>Group</td> <td style="text-align: right;">0</td> </tr> <tr> <td>Module</td> <td style="text-align: right;">0</td> </tr> <tr> <td>Control Block</td> <td style="text-align: right;">BT11:0</td> </tr> <tr> <td>Data File</td> <td style="text-align: right;">N10:10</td> </tr> <tr> <td>Length</td> <td style="text-align: right;">40</td> </tr> <tr> <td>Continuous</td> <td style="text-align: right;">Y</td> </tr> </table>	BTW		BLOCK TRANSFER WRITE		Rack	1	Group	0	Module	0	Control Block	BT11:0	Data File	N10:10	Length	40	Continuous	Y	<p>Block Transfer Write BTW</p> <p>If the input conditions go from false-to-true, the block transfer write is initiated for the I/O module located at rack 1, group 0, module 0. The Control Block (BT11:0, 6-word file) contains status for the transfer. The Data File contains the data to write to the module (N10:10). The BT Length (40) identifies the number of words in the transfer. A non-continuous block transfer is queued and run only once on a false-to-true rung transition; a continuous block transfer is repeatedly requested. You can also use the N data type for the control block.</p>
BTW																			
BLOCK TRANSFER WRITE																			
Rack	1																		
Group	0																		
Module	0																		
Control Block	BT11:0																		
Data File	N10:10																		
Length	40																		
Continuous	Y																		

See page f-8 for a description of prescan operation for this instruction.

## ASCII Instructions

Status Bits:  
 EN - Enable  
 EM - Empty Bit  
 DN - Done Bit  
 EU - Queue  
 ER - Error Bit  
 FD - Found Bit

Instruction		Description																				
<table border="1"> <tr><td colspan="2">- ABL -</td></tr> <tr><td colspan="2">ASCII TEST FOR LINE</td></tr> <tr><td>Channel</td><td>0</td></tr> <tr><td>Control</td><td>R6:32</td></tr> <tr><td>Characters</td><td></td></tr> </table>	- ABL -		ASCII TEST FOR LINE		Channel	0	Control	R6:32	Characters		ASCII Test for Line ABL	If input conditions go from false-to-true, the controller reports the number of characters in the buffer, up to and including the end-of-line characters and puts this value into the position word of the control structure (R6:32.POS). The controller also displays this value in the characters field of the display.  See page F-8 for a description of prescan operation for this instruction.										
- ABL -																						
ASCII TEST FOR LINE																						
Channel	0																					
Control	R6:32																					
Characters																						
<table border="1"> <tr><td colspan="2">- ACB -</td></tr> <tr><td colspan="2">ASCII CHARS IN BUFFER</td></tr> <tr><td>Channel</td><td>0</td></tr> <tr><td>Control</td><td>R6:32</td></tr> <tr><td>Characters</td><td></td></tr> </table>	- ACB -		ASCII CHARS IN BUFFER		Channel	0	Control	R6:32	Characters		ASCII Characters in Buffer ACB	If input conditions go from false-to-true, the controller reports the total number of characters in the buffer and puts this value into the position word (.POS) of the control structure. The controller also displays this value in the characters field of the display.  See page F-8 for a description of prescan operation for this instruction.										
- ACB -																						
ASCII CHARS IN BUFFER																						
Channel	0																					
Control	R6:32																					
Characters																						
<table border="1"> <tr><td colspan="2">- ACI -</td></tr> <tr><td colspan="2">STRING TO INTEGER CONVERSION</td></tr> <tr><td>Source</td><td>ST38:90</td></tr> <tr><td>Dest</td><td>N7:123</td></tr> <tr><td></td><td>75</td></tr> </table>	- ACI -		STRING TO INTEGER CONVERSION		Source	ST38:90	Dest	N7:123		75	Convert ASCII String to Integer ACI	If input conditions are true, the controller converts the string in ST38:90 to an integer and stores the result in N7:123.  <table border="1"> <thead> <tr> <th>Status Bit</th> <th>Description</th> </tr> </thead> <tbody> <tr> <td>C</td> <td>set if a carry was generated during the conversion; otherwise resets</td> </tr> <tr> <td>V</td> <td>set if source is &gt; 32,767 or &lt; -32,768, otherwise resets</td> </tr> <tr> <td>Z</td> <td>set if source is zero; otherwise resets</td> </tr> <tr> <td>S</td> <td>set if destination is negative; otherwise resets</td> </tr> </tbody> </table>	Status Bit	Description	C	set if a carry was generated during the conversion; otherwise resets	V	set if source is > 32,767 or < -32,768, otherwise resets	Z	set if source is zero; otherwise resets	S	set if destination is negative; otherwise resets
- ACI -																						
STRING TO INTEGER CONVERSION																						
Source	ST38:90																					
Dest	N7:123																					
	75																					
Status Bit	Description																					
C	set if a carry was generated during the conversion; otherwise resets																					
V	set if source is > 32,767 or < -32,768, otherwise resets																					
Z	set if source is zero; otherwise resets																					
S	set if destination is negative; otherwise resets																					
<table border="1"> <tr><td colspan="2">- ACN -</td></tr> <tr><td colspan="2">STRING CONCATENATE</td></tr> <tr><td>Source A</td><td>ST38:90</td></tr> <tr><td>Source B</td><td>ST37:91</td></tr> <tr><td>Dest</td><td>ST52:76</td></tr> </table>	- ACN -		STRING CONCATENATE		Source A	ST38:90	Source B	ST37:91	Dest	ST52:76	ASCII String Concatenate ACN	If input conditions are true, the controller concatenates the string in ST38:90 with the string in ST37:91 and store the result in ST52:76.										
- ACN -																						
STRING CONCATENATE																						
Source A	ST38:90																					
Source B	ST37:91																					
Dest	ST52:76																					

Instruction		Description
<p>AEX</p> <p>STRING EXTRACT</p> <p>Source ST38:40</p> <p>Index 42</p> <p>Number 10</p> <p>Dest ST52:75</p>	<p>ASCII String Extract</p> <p>AEX</p>	<p>If input conditions are true, the controller extracts 10 characters starting at the 42nd character of ST38:40 and store the result in ST52:75.</p>
<p>AIC</p> <p>INTEGER TO STRING CONVERSION</p> <p>Source 876</p> <p>Dest ST38:42</p>	<p>Convert Integer to ASCII String</p> <p>AIC</p>	<p>If input conditions are true, the controller converts the value 876 to a string and store the result in ST38:42.</p>
<p>AHL</p> <p>ASCII HANDSHAKE LINE</p> <p>Channel 0</p> <p>AND Mask 0001</p> <p>OR Mask 0003</p> <p>Control R6:23</p> <p>Channel Status</p>	<p>ASCII Handshake Lines</p> <p>AHL</p> <p>Status Bits:</p> <p>EN-Enable</p> <p>DN-Done Bit</p> <p>ER-Error Bit</p>	<p>If input conditions go from false-to-true, the controller uses the AND and OR masks to determine whether to set or reset the DTR (bit 0) and RTS (bit 1) lines, or leave them unchanged. Bit 0 and 1 of the AND mask cause the line(s) to reset if 1 and leave the line(s) unchanged if 0. Bit 0 and 1 of the OR mask cause the line(s) to set if 1 and leave the line(s) unchanged if 0.</p> <p>See page F-8 for a description of prescan operation for this instruction.</p>
<p>ARD</p> <p>ASCII READ</p> <p>Channel 0</p> <p>Dest ST52:76</p> <p>Control R6:32</p> <p>String Length 50</p> <p>Characters Read</p>	<p>ASCII Read</p> <p>ARD</p> <p>Status Bits</p> <p>EN - Enable</p> <p>DN - Done Bit</p> <p>ER - Error Bit</p> <p>UL - Unload</p> <p>EM - Empty</p> <p>EU - Queue</p>	<p>If input conditions go from false-to-true, read 50 characters from the buffer and move them to ST52:76. The number of characters read is stored in R6:32.POS and displayed in the Characters Read Field of the instruction display.</p> <p>See page F-8 for a description of prescan operation for this instruction.</p>
<p>ARL</p> <p>ASCII READ LINE</p> <p>Channel 0</p> <p>Dest ST50:72</p> <p>Control R6:30</p> <p>String Length 18</p> <p>Characters Read</p>	<p>ASCII Read Line</p> <p>ARL</p> <p>Status Bits</p> <p>EN - Enable</p> <p>DN - Done Bit</p> <p>ER - Error Bit</p> <p>UL - Unload</p> <p>EM - Empty</p> <p>EU - Queue</p>	<p>If input conditions go from false-to-true, read 18 characters (or until end-of-line) from the buffer and move them to ST50:72. The number of characters read is stored in R6:30.POS and displayed in the Characters Read Field of the instruction display.</p> <p>See page F-8 for a description of prescan operation for this instruction.</p>



Instruction	Description	
<p>ASC</p> <p>STRING SEARCH</p> <p>Source ST38:40</p> <p>Index 35</p> <p>Search ST52:80</p> <p>Result 42</p>	<p>ASCII String Search</p> <p>ASC</p>	<p>If input conditions are true, search ST52:80 starting at the 35th character, for the string found in ST38:40. In this example, the string was found at index 42. If the string is not found, the ASCII instruction minor fault bit S:17/8 is set and the result is zero.</p>
<p>ASR</p> <p>ASCII STRING COMPARE</p> <p>Source A ST37:42</p> <p>Source B ST38:90</p>	<p>ASCII String Compare</p> <p>ASR</p>	<p>If the string in ST37:42 is identical to the string in ST38:90, the instruction is true. Note that this is an input instruction. An invalid string length causes the ASCII instruction error minor fault bit S:17/8 to be set, and the instruction is false.</p>
<p>AWA</p> <p>ASCII WRITE APPEND</p> <p>Channel 0</p> <p>Source ST52:76</p> <p>Control R6:32</p> <p>String Length 50</p> <p>Characters Sent</p>	<p>ASCII Write Append</p> <p>AWA</p> <p>Status Bits</p> <p>EN - Enable</p> <p>DN - Done Bit</p> <p>ER - Error Bit</p> <p>UL - Unload</p> <p>EM - Empty</p> <p>EU - Queue</p>	<p>If input conditions go from false-to-true, read 50 characters from ST52:76 and write it to channel 0 and append the two character configuration in the channel configuration (default CR/LF). The number of characters sent is stored in R6:32.POS and displayed in the characters sent field of the instruction display.</p> <p>See page F-8 for a description of prescan operation for this instruction.</p>
<p>AWT</p> <p>ASCII WRITE</p> <p>Channel 0</p> <p>Source ST37:40</p> <p>Control R6:23</p> <p>String Length 40</p> <p>Characters Sent</p>	<p>ASCII Write</p> <p>AWT</p> <p>Status Bits</p> <p>EN - Enable</p> <p>DN - Done Bit</p> <p>ER - Error Bit</p> <p>UL - Unload</p> <p>EM - Empty</p> <p>EU - Queue</p>	<p>If input conditions go from false-to-true, write 40 characters from ST37:40 to channel 0. The number of characters sent is stored in R6:23.POS and displayed in the characters sent field of the instruction display.</p> <p>See page F-8 for a description of prescan operation for this instruction.</p>

### Bit and Word Instructions

Category	Code	Title	Execution Time (μs) Integer		Execution Time (μs) Floating Point		Words of Memory <sup>(1)</sup>
			True	False	True	False	
Relay	XIC	examine if closed	.32	.16			1 <sup>(2)</sup>
	XIO	examine if open	.32	.16			1 <sup>2</sup>
	OTL	output latch	.48	.16			1 <sup>2</sup>
	OTU	output unlatch	.48	.16			1 <sup>2</sup>
	OTE	output energize	.48	.48			1 <sup>2</sup>
Branch		branch end	.16	.16			1
		next branch					1
		branch start					1
Timer and Counter	TON	timer on(0.01 base)	3.8	2.6			2-3
		(1.0 base)	4.1	2.5			
	TOF	timer off(0.01 base)	2.6	3.2			2-3
		(1.0 base)	2.6	3.2			
	RTO	retentive timer on (0.01 base)	3.8	2.4			2-3
		(1.0 base)	4.1	2.3			
	CTU	count up	3.4	3.4			2-3
CTD	count down	3.3	3.4			2-3	
RES	reset	2.2	1.0			2-3	

<sup>(1)</sup> Use the larger number for addresses beyond 2048 words in the controller's data table.

<sup>(2)</sup> For every bit address above the first 256 words of memory in the data table, add 0.16 μs and 1 word of memory.

Category	Code	Title	Execution Time (μs) Integer		Execution Time (μs) Floating Point		Words of Memory <sup>(1)</sup>
			True	False	True	False	
			Arithmetic	ADD	add	6.1	
	SUB	subtract	6.2	1.4	15.6	1.4	4-7
	MUL	multiply	9.9	1.4	18.2	1.4	4-7
	DIV	divides	12.2	1.4	23.4	1.4	4-7
	SQR	square root	9.9	1.3	35.6	1.3	3-5
	NEG	negate	4.8	1.3	6.0	1.3	3-5
	CLR	clear	3.4	1.1	3.9	1.1	2-3
	AVE	average file	152+E25.8	30	162+E22.9	36	4-7
	STD	standard deviation	262+E92.5	34	295+E85.5	34	4-7
	TOD	convert to BCD	7.8	1.3			3-5
	FRD	convert from BCD	8.1	1.3			3-5
	RAD	radian	57.4	1.4	50.1	1.4	3-5
	DEG	degree	55.9	1.4	50.7	1.4	3-5
	SIN	sine			414	1.4	3-5
	COS	cosine			404	1.4	3-5
	TAN	tangent			504	1.4	3-5
	ASN	inverse sine			426	1.4	3-5
	ACS	inverse cosine			436	1.4	3-5
	ATN	inverse tangent			375	1.4	3-5
	LN	natural log	409	1.4	403	1.4	3-5
	LOG	log	411	1.4	403	1.4	3-5
	XPY	X to the power of Y	897	1.5	897	1.5	4-7
	SRT	sort file					3-5
		(5/11, -5/20)	276 + 12[E**1.34]	227	278 + 16[E**1.35]	227	
		(-5/30, -5/40, -5/60, -5/80)	224 + 25[E**1.34]	189	230 + 33[E**1.35]	189	

<sup>(1)</sup> Use the larger number for addresses beyond 2048 words in the controller's data table.

E = number of elements acted on per scan

SRT true is only an approximation. Actual time depends on the randomness of the numbers.

## File, Program Control, and ASCII Instructions

Category	Code	Title	Time ( $\mu$ s) Integer		Time ( $\mu$ s) Floating Point		Words of Memory <sup>(1)</sup>
			True	False	True	False	
File Arithmetic and Logic	FAL	all	$11 + (S[2.3 + i])E$	$6.16 + Wi[0.16]$	$11 + (\Sigma[2.3 + i])E$	$6.16 + Wi[0.16]$	$3-5 + Wi$
File Search and Compare	FSC	all	$11 + (S[2.3 + i])E$	$6.16 + Wi[0.16]$	$11 + (\Sigma[2.3 + i])E$	$6.16 + Wi[0.16]$	$3-5 + Wi$
File	COP	copy	$16.2+E[0.72]$	1.4	$17.8+E[1.44]$	1.4	4-6
		counter, timer, and control	$15.7+E[2.16]$	1.4			
	FLL	fill	$15.7+E[0.64]$	1.5	$18.1+E[0.80]$	1.5	4-6
		counter, timer, and control	$15.1+E[1.60]$	1.5			
Shift Register	BSL	bit shift left	$10.6+B[0.025]$	5.2			4-7
	BSR	bit shift right	$11.1 + B[0.025]$	5.2			4-7
	FFL	FIFO load	8.9	3.8			4-7
	FFU	FIFO unload	$10.0+E[0.43]$	3.8			4-7
	LFL	LIFO load	9.1	3.7			4-7
	LFU	LIFO unload	10.6	3.8			4-7
Diagnostic	FBC	0 mismatch	$15.4 + B[0.055]$	2.9			6-11
		1 mismatch	$22.4 + B[0.055]$	2.9			
		2 mismatches	$29.9+ B[0.055]$	2.9			
	DDT	0 mismatch	$15.4 + B[0.055]$	2.9			6-11
		1 mismatch	$24.5 + B[0.055]$	2.9			
		2 mismatches	$34.2 + B[0.055]$	2.9			
	DTR	data transitional	5.3	5.3			4-7

<sup>(1)</sup> Use the larger number for addresses beyond 2048 words in the controller's data table.

i = execution time of each instruction (e.g., ADD, SUB, etc.) used within the FAL or the FSC expression

E = number of elements acted on per scan

B = number of bits acted on per scan

Wi = number of words used by the instruction (e.g., ADD, SUB, etc.) within the FAL or FSC expression

FAL or FSC instructions are calculated with short direct addressing

Category	Code	Title	Time (μs) Integer		Time (μs) Floating Point		Words of Memory <sup>(1)</sup>
			True	False	True	False	
Sequencer	SQL	sequencer input	7.9	1.3			5-9
	SQL	sequencer load	7.9	3.5			4-7
	SQO	sequencer output	9.7	3.7			5-9
Immediate I/O <sup>(2)</sup>	IIN	immediate input  • PLC-5/11, -5/20, and -5/20E • PLC5/30, -5/40, -5/40E, -5/40L -5/60, -5/60L, and -5/80, -5/80E	• 357 • 307	1.1			2
	IOT	immediate output  • PLC-5/11, -5/20, and -5/20E • PLC5/30, -5/40, -5/40E, -5/40L -5/60, -5/60L, -5/80, and -5/80E	• 361 • 301	1.1			2
Zone Control	MCR	master control	0.16	0.16			1
Program Control	JMP	jump	$8.9 + (\text{file\#} - 2) * 0.96$	1.4			2
	JSR <sup>(3)</sup> /RET	— 0 parameters	12.3	1.0	not applicable	not applicable	3+parameters/JSR
		— 1 parameter	16.1	1.0	17.3	1.0	1+parameters/RET
		— increase/ parameter	3.8	not applicable	5.0	not applicable	
SBR						1+ parameters	

<sup>(1)</sup> Use the larger number for addresses beyond 2048 words in the controller's data table.

<sup>(2)</sup> Timing for immediate I/O instructions is the time for the instruction to queue-up for processing.

<sup>(3)</sup> Calculate execution times as follows: (time) + (quantity of additional parameters)(time/parameter). For example: if you are passing 3 integer parameters in a JSR within a PLC-5/11 controller, the execution time = 16.1 + (2)(3.8) = 23.7 ms

Category	Code	Title	Time (μs) Integer		Time (μs) Floating Point		Words of Memory <sup>(1)</sup>
			True	False	True	False	
Program Control	LBL	label	0.16	0.16			2
	END	end	negligible				1
	TND	temporary end					1
	EOT	end of transition					1
	AFI	always false	0.16	0.16			1
	ONS	one shot	3.0	3.0			2-3
	OSR	one shot rising	6.2	6.0			4-6
	OSF	one shot falling	6.2	5.8			4-6
	FOR/ NXT	for next loop	8.1 + L[15.9] + (file# - 2) * 0.96	5.3 + N[0.75]			FOR 5-9 NXT 2
	BRK	break	11.3 + N[0.75]	0.9			1
	UID	user interrupt disable (PLC-5/11, -5/20, -5/30, -5/40, -5/60, and -5/80 controllers)	175 119	1.0			1
UIE	user interrupt enable (PLC-5/11, -5/20, -5/30, -5/40, -5/60, and -5/80 controllers)	170 100	1.0			1	

<sup>(1)</sup> Use the larger number for addresses beyond 2048 words in the controller's data table.

L = number of FOR/NXT loops

N = number of words in memory between FOR/NXT or BRK/NXT

Category	Code	Title	Time (μs) Integer		Time (μs) Floating Point		Words of Memory <sup>(1)</sup>	
			True	False	True	False		
Process Control	PID	PID loop control					5-9	
		Gains	Independent	• 462 • 655	3.0	1120		58
			<ul style="list-style-type: none"> <li>PLC-5/11, -5/20, -5/20E</li> <li>PLC-5/30, -5/40, -5/40E, -5/40L, -5/60, -5/60L, -5/80, -5/80E</li> </ul>					
		Modes	ISA	• 560 • 895		1180		
			<ul style="list-style-type: none"> <li>PLC-5/11, -5/20, and -5/20E</li> <li>PLC-5/30, -5/40, -5/40E, -5/40L, -5/60, -5/60L, -5/80, and -5/80E</li> </ul>					
			Manual	• 372 • 420		1150		
		Cascade	Set Output	• 380 • 440		1130		
<ul style="list-style-type: none"> <li>PLC-5/11, -5/20, and -5/20E</li> <li>PLC-5/30, -5/40, -5/40E, -5/40L, -5/60, -5/60L, -5/80, and -5/80E</li> </ul>								
	Slave			1530				
	Master			1080				
ASCII <sup>(2)</sup>	ABL	test buffer for line	• 316 • 388	• 214 • 150			3-5	
		<ul style="list-style-type: none"> <li>PLC-5/11, -5/20, and -5/20E</li> <li>PLC-5/30, -5/40, -5/40E, -5/40L, -5/60, -5/60L, -5/80, and -5/80E</li> </ul>						

<sup>(1)</sup> Use the larger number for addresses beyond 2048 words in the controller's data table.

<sup>(2)</sup> Timing for ASCII instructions is the time for the instruction to queue-up for processing in channel 0.

C = number of ASCII characters

Category	Code	Title	Time (μs) Integer		Time (μs) Floating Point		Words of Memory <sup>(1)</sup>
			True	False	True	False	
	ACB	no. of characters in buffer  <ul style="list-style-type: none"> <li>• PLC-5/11, -5/20, and -5/20E</li> <li>• PLC-5/30, -5/40, -5/40E, -5/40L, -5/60, -5/60L, -5/80, and -5/80E</li> </ul>	<ul style="list-style-type: none"> <li>• 316</li> <li>• 389</li> </ul>	<ul style="list-style-type: none"> <li>• 214</li> <li>• 150</li> </ul>			3-5
	ACI	string to integer  <ul style="list-style-type: none"> <li>• PLC-5/11, -5/20, and -5/20E</li> <li>• PLC-5/30, -5/40, -5/40E, -5/40L, -5/60, -5/60L, -5/80, and -5/80E</li> </ul>	<ul style="list-style-type: none"> <li>• 220 + C[11]</li> <li>• 140 + C[21.4]</li> </ul>	1.4			3-5
	ACN	string concatenate  <ul style="list-style-type: none"> <li>• PLC-5/11, -5/20, and -5/20E</li> <li>• PLC-5/30, -5/40, -5/40E, -5/40L, -5/60, -5/60L, -5/80, and -5/80E</li> </ul>	<ul style="list-style-type: none"> <li>• 237 + C[2.6]</li> <li>• 179 + C[5.5]</li> </ul>	1.9			4-7
	AEX	string extract  <ul style="list-style-type: none"> <li>• PLC-5/11, -5/20, and -5/20E</li> <li>• PLC-5/30, -5/40, -5/40E, -5/40L, -5/60, -5/60L, -5/80, and -5/80E</li> </ul>	<ul style="list-style-type: none"> <li>• 226 + C[1.1]</li> <li>• 159 + C[2.2]</li> </ul>	1.9			5-9
	AHL <sub>i</sub>	set or reset lines  <ul style="list-style-type: none"> <li>• PLC-5/11, -5/20, and -5/20E</li> <li>• PLC-5/30, -5/40, -5/40E, -5/40L, -5/60, -5/60L, -5/80, and -5/80E</li> </ul>	<ul style="list-style-type: none"> <li>• 318</li> <li>• 526</li> </ul>	<ul style="list-style-type: none"> <li>• 213</li> <li>• 157</li> </ul>			5-9

<sup>(1)</sup> Use the larger number for addresses beyond 2048 words in the controller's data table.



Category	Code	Title	Time (μs) Integer		Time (μs) Floating Point		Words of Memory <sup>(1)</sup>
			True	False	True	False	
ASCII <sup>(2)</sup>	AIC	integer to string  <ul style="list-style-type: none"> <li>• PLC-5/11, -5/20, and -5/20E</li> <li>• PLC-5/30, -5/40, -5/40E, -5/40L, -5/60, -5/60L, -5/80, and -5/80E</li> </ul>	<ul style="list-style-type: none"> <li>• 260</li> <li>• 270</li> </ul>	1.4			3-5
	ARD	read characters  <ul style="list-style-type: none"> <li>• PLC-5/11, -5/20, and -5/20E</li> <li>• PLC-5/30, -5/40, -5/40E, -5/40L, -5/60, -5/60L, -5/80, and -5/80E</li> </ul>	<ul style="list-style-type: none"> <li>• 315</li> <li>• 380</li> </ul>	<ul style="list-style-type: none"> <li>• 214</li> <li>• 149</li> </ul>			4-7
	ARL	read line  <ul style="list-style-type: none"> <li>• PLC-5/11, -5/20, and -5/20E</li> <li>• PLC-5/30, -5/40, -5/40E, -5/40L, -5/60, -5/60L, -5/80, and -5/80E</li> </ul>	<ul style="list-style-type: none"> <li>• 316</li> <li>• 388</li> </ul>	<ul style="list-style-type: none"> <li>• 214</li> <li>• 151</li> </ul>			4-7
	ASC	string search  <ul style="list-style-type: none"> <li>• PLC-5/11, -5/20, and -5/20E</li> <li>• PLC-5/30, -5/40, -5/40E, -5/40L, -5/60, -5/60L, -5/80, and -5/80E</li> </ul>	<ul style="list-style-type: none"> <li>• 222 + C[1.7]</li> <li>• 151 + C[3.0]</li> </ul>	1.9			5-9
	ASR	string compare  <ul style="list-style-type: none"> <li>• PLC-5/11, -5/20, and -5/20E</li> <li>• PLC-5/30, -5/40, -5/40E, -5/40L, -5/60, -5/60L, -5/80, and -5/80E</li> </ul>	<ul style="list-style-type: none"> <li>• 234 + C[1.3]</li> <li>• 169 + C[2.4]</li> </ul>	<ul style="list-style-type: none"> <li>• 202</li> <li>• 119</li> </ul>			3-5

(1) Use the larger number for addresses beyond 2048 words in the controller's data table.

(2) Timing for ASCII instructions is the time for the instruction to queue-up for processing in channel 0.

C = number of ASCII characters

Category	Code	Title	Time (μs) Integer		Time (μs) Floating Point		Words of Memory <sup>(1)</sup>
			True	False	True	False	
ASCII <sup>(2)</sup>	AWA	write with append  <ul style="list-style-type: none"> <li>• PLC-5/11, -5/20, and -5/20E</li> <li>• PLC-5/30, -5/40, -5/40E, -5/40L, -5/60, -5/60L, -5/80, and -5/80E</li> </ul>	<ul style="list-style-type: none"> <li>• 319</li> <li>• 345</li> </ul>	<ul style="list-style-type: none"> <li>• 215</li> <li>• 154</li> </ul>			4-7
	AWT	write  <ul style="list-style-type: none"> <li>• PLC-5/11, -5/20, and -5/20E</li> <li>• PLC-5/30, -5/40, -5/40E, -5/40L, -5/60, -5/60L, -5/80, and -5/80E</li> </ul>	<ul style="list-style-type: none"> <li>• 318</li> <li>• 344</li> </ul>	<ul style="list-style-type: none"> <li>• 215</li> <li>• 151</li> </ul>			4-7

<sup>(1)</sup> Use the larger number for addresses beyond 2048 words in the controller's data table.

<sup>(2)</sup> Timing for ASCII instructions is the time for the instruction to queue-up for processing in channel 0.

C = number of ASCII characters

---

## Switch Setting Reference

### Using This Chapter

<b>For this Switch Setting</b>	<b>Go to Page</b>
Enhanced and Ethernet PLC-5 switch 1 for defining the controller's DH+ address	E-2
Enhanced and Ethernet PLC-5 switch 2 for defining the controller's serial port electrical interface	E-3
I/O chassis containing a PLC-5 controller	E-4
I/O chassis containing a 1771-ASB, remote I/O adapter module	E-5
I/O chassis configuration plug for defining an external or slot power supply	E-6
1771-ASB not using complementary I/O	E-7
1771-ALX adapter module	E-9

# Controller Switches Switch 1

Side View of PLC-5/11, -5/20, -5/26, -5/20E controllers Switch Assembly SW1

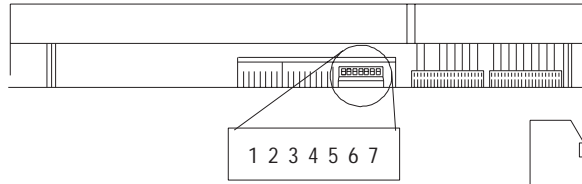

Side View of PLC-5/30, -5/40, -5/46, -5/40L, -5/60, -5/60L, -5/80, -5/86, -5/40E, and -5/80E controllers Switch Assembly SW1

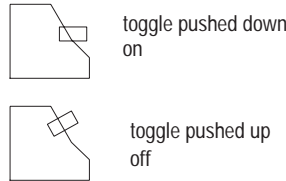
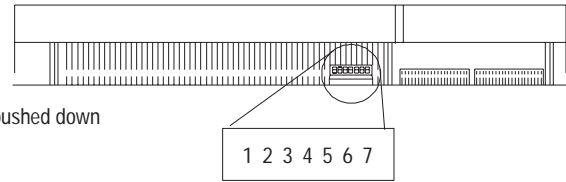

**To Select DH+ Baud Rate for Channel 1A:**

**Set sSwitch: To:**

DH+ address	1 through 6 (See below)
DH+ baud rate	7 on (down) 57.6 kbps off (up) 230.4 kbps

DH+ Station Number	Switch					
	1	2	3	4	5	6
0	on	on	on	on	on	on
1	off	on	on	on	on	on
2	on	off	on	on	on	on
3	off	off	on	on	on	on
4	on	on	off	on	on	on
5	off	on	off	on	on	on
6	on	off	off	on	on	on
7	off	off	off	on	on	on
10	on	on	on	off	on	on
11	off	on	on	off	on	on
12	on	off	on	off	on	on
13	off	off	on	off	on	on
14	on	on	off	off	on	on
15	off	on	off	off	on	on
16	on	off	off	off	on	on
17	off	off	off	off	on	on
20	on	on	on	on	off	on
21	off	on	on	on	off	on
22	on	off	on	on	off	on
23	off	off	on	on	off	on
24	on	on	off	on	off	on
25	off	on	off	on	off	on
26	on	off	off	on	off	on
27	off	off	off	on	off	on
30	on	on	on	off	off	on
31	off	on	on	off	off	on
32	on	off	on	off	off	on
33	off	off	on	off	off	on
34	on	on	off	off	off	on
35	off	on	off	off	off	on
36	on	off	off	off	off	on
37	off	off	off	off	off	on

DH+ Station Number	Switch					
	1	2	3	4	5	6
40	on	on	on	on	on	off
41	off	on	on	on	on	off
42	on	off	on	on	on	off
43	off	off	on	on	on	off
44	on	on	off	on	on	off
45	off	on	off	on	on	off
46	on	off	off	on	on	off
47	off	off	off	on	on	off
50	on	on	on	off	on	off
51	off	on	on	off	on	off
52	on	off	on	off	on	off
53	off	off	on	off	on	off
54	on	on	off	off	on	off
55	off	on	off	off	on	off
56	on	off	off	off	on	off
57	off	off	off	off	on	off
60	on	on	on	on	off	off
61	off	on	on	on	off	off
62	on	off	on	on	off	off
63	off	off	on	on	off	off
64	on	on	off	on	off	off
65	off	on	off	on	off	off
66	on	off	off	on	off	off
67	off	off	off	on	off	off
70	on	on	on	off	off	off
71	off	on	on	off	off	off
72	on	off	on	off	off	off
73	off	off	on	off	off	off
74	on	on	off	off	off	off
75	off	on	off	off	off	off
76	on	off	off	off	off	off
77	off	off	off	off	off	off

## Switch 2

Bottom View of PLC-5/11, -5/20, -5/26, and -5/20E processors Switch Assembly SW2

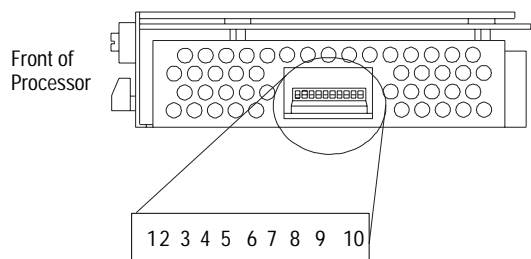

Bottom View of PLC-5/30, -5/40, -5/46 -5/40L, -5/60, -5/60L, -5/80, -5/86, -5/40E, and -5/80E processors Switch Assembly SW2

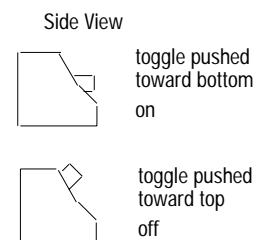
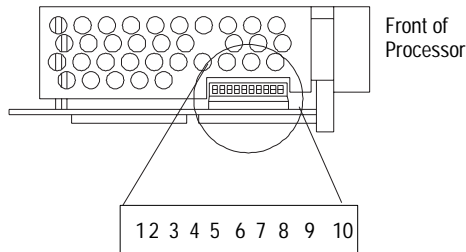

**To Specify:**      **Set Switches:**

	1	2	3	4	5	6	7	8	9	10
RS-232C	on	on	on	off	off	on	on	off	on	off
RS-422A	off	off	on	off	off	off	off	off	on	off
RS-423	on	on	on	off	off	on	off	off	on	off

# I/O Chassis Backplane

# PLC-5 Controller in the I/O Chassis

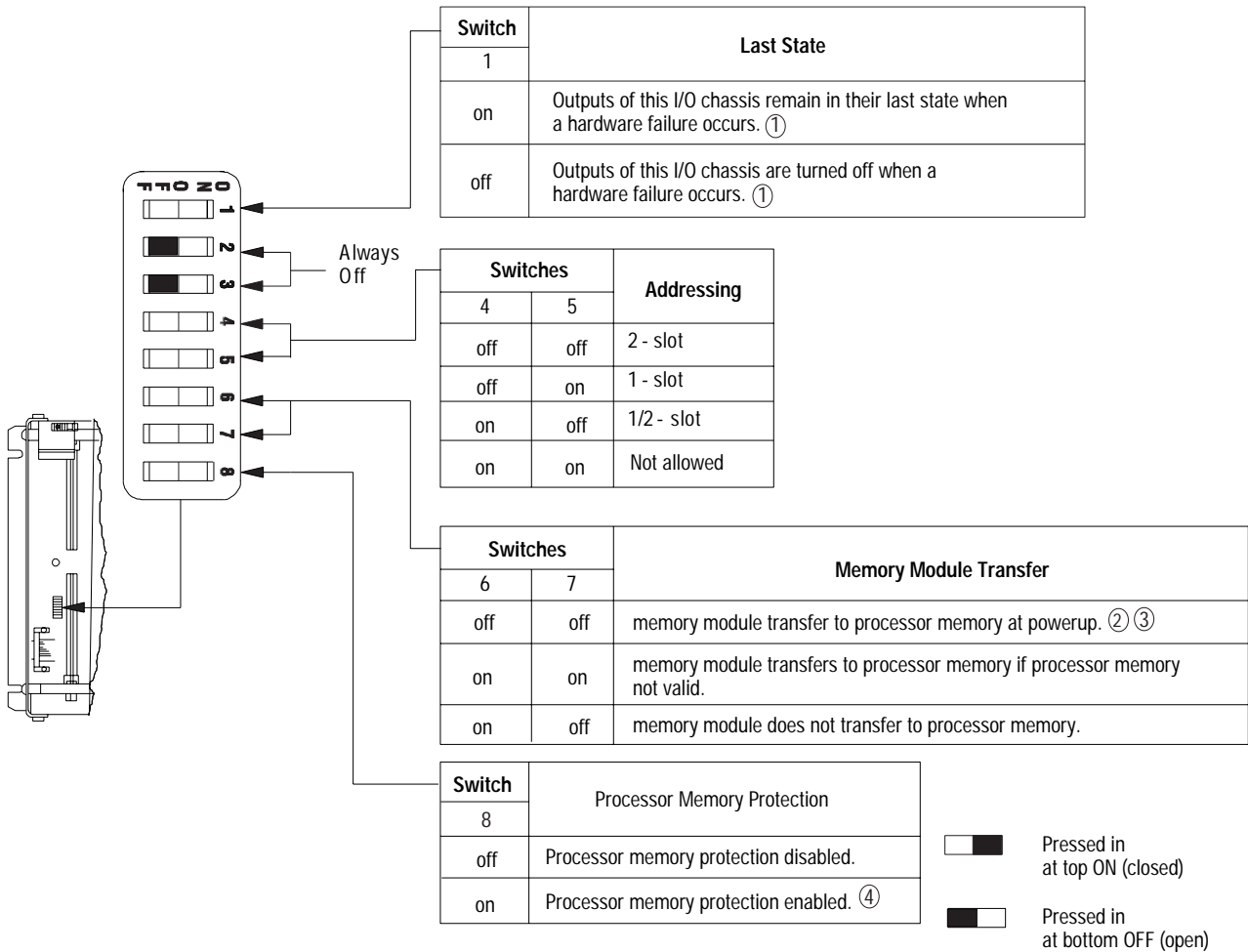

- ① Regardless of this switch setting, outputs are turned off when any of the following occurs:
  - processor detects a major fault
  - an I/O chassis backplane fault occurs
  - you select program or test mode
  - you set a status file bit to reset a local rack
- ② If a memory module is not installed and processor memory is valid, the processor's PROC LED indicator blinks, and the processor sets S:11/9 in the major fault status word. Power down the processor chassis and either install the correct memory module or set switch 6 ON.
- ③ If the processor's keyswitch is set in REMote, the processor enters remote RUN after it powers up and has its memory updated by the memory module.
- ④ You cannot clear processor memory when this switch is on.

## 1771-ASB Remote I/O Adapter or 1771-ALX Extended-Local I/O Adapter

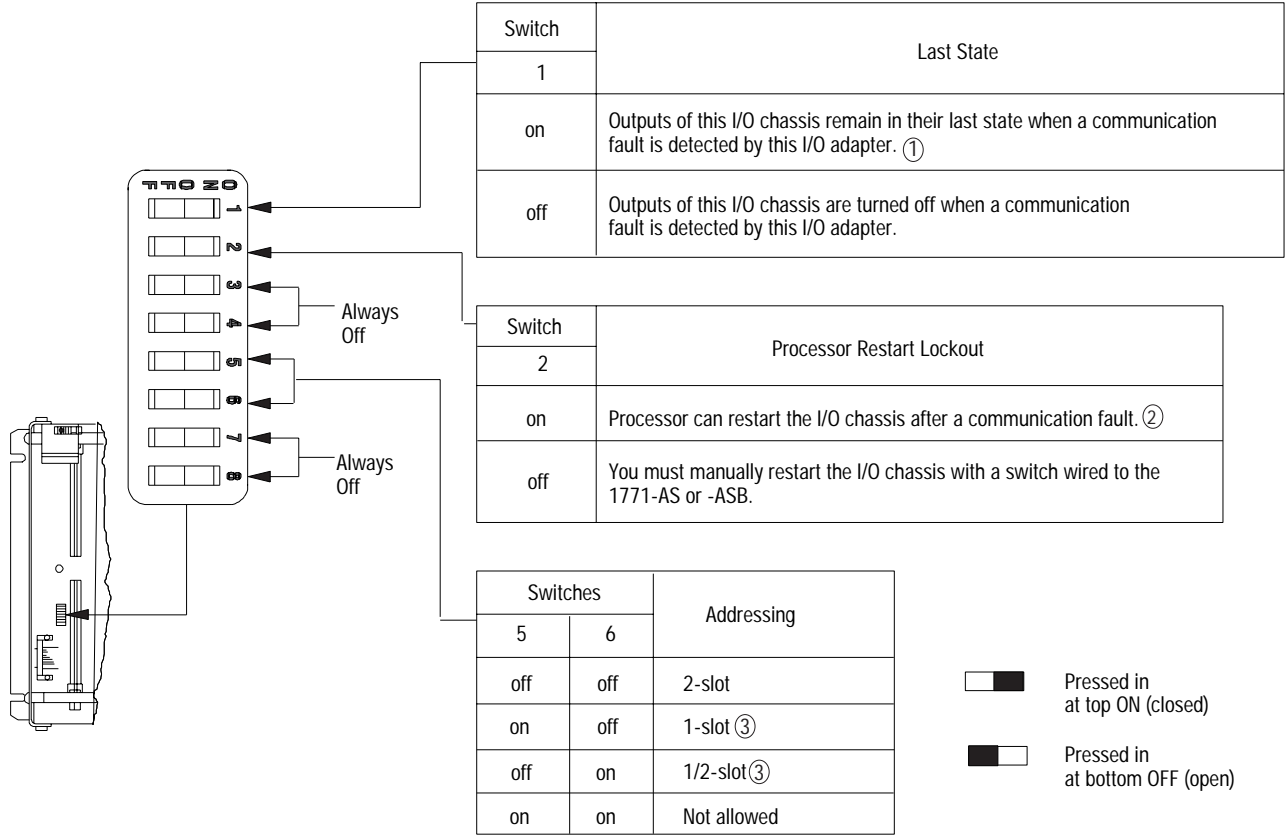

19308

**ATTENTION**



If you set this switch to the ON position, when a communication fault is detected, outputs connected to this chassis remain in their last state to allow machine motion to continue. We recommend that you set switch 1 to the OFF position to de-energize outputs wired to this chassis when a fault is detected.

Also, if outputs are controlled by inputs in a different rack and a remote I/O rack fault occurs (in the inputs rack), the inputs are left in their last non-faulted state. The outputs may not be properly controlled and potential personnel and machine damage may result. If you want your inputs to be anything other than their last non-faulted state, then you need to program a fault routine.

Set this switch to ON if you plan to use I/O rack auto-configuration. The 1771-ASB series A adapter does not support 1/2-slot addressing.

### I/O Chassis Configuration Plug

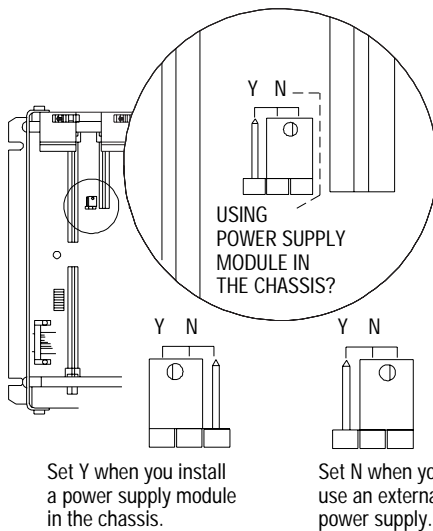

1. Locate the chassis configuration plug (between the first two left-most slots of the chassis).
2. Set the I/O chassis configuration plug. The default setting is N (not using a power supply module in the chassis).

**Important:** You cannot power a single I/O chassis with both a power supply module and an external power supply.



## Remote I/O Adapter Module (1771-ASB Series C and D) without Complementary I/O

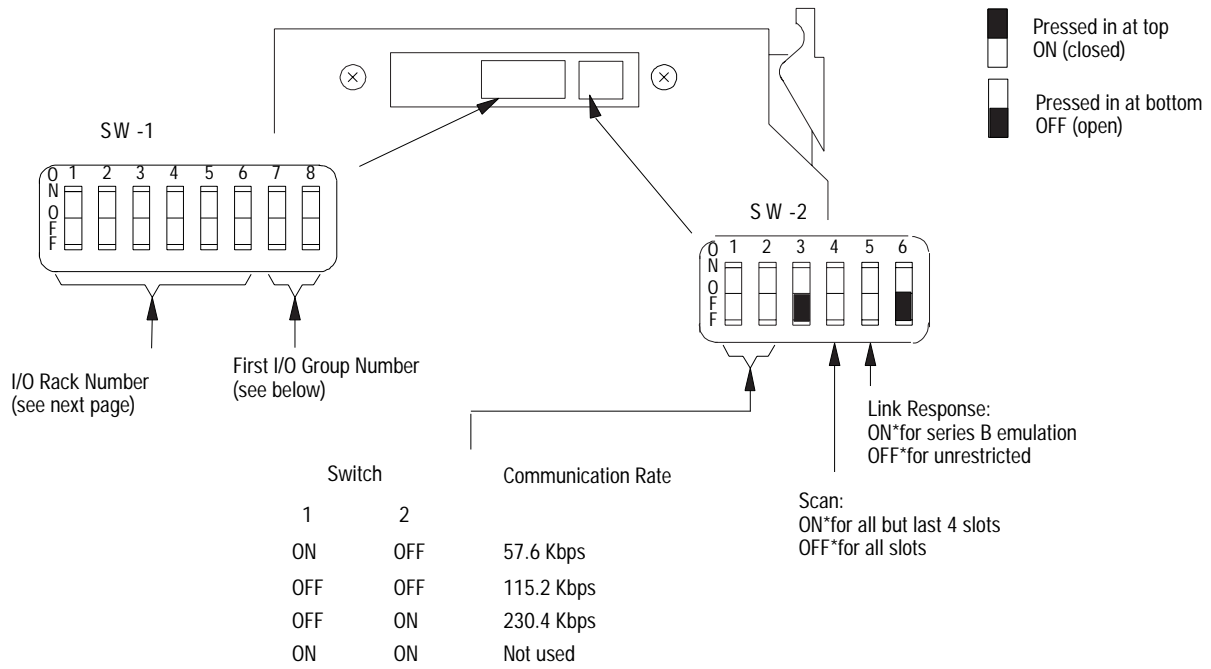

First I/O Group Number:	7	8
0	on	on
2	on	off
4	off	on
6	off	off

**(1771-ASB Series C and D) I/O Rack Number -  
without Complementary I/O**

<b>Rack</b>	<b>1</b>	<b>2</b>	<b>3</b>	<b>4</b>	<b>5</b>	<b>6</b>
01	on	on	on	on	on	off
02	on	on	on	on	off	on
03	on	on	on	on	off	off
04	on	on	on	off	on	on
05	on	on	on	off	on	off
06	on	on	on	off	off	on
07	on	on	on	off	off	off
10	on	on	off	on	on	on
11	on	on	off	on	on	off
12	on	on	off	on	off	on
13	on	on	off	on	off	off
14	on	on	off	off	on	on
15	on	on	off	off	on	off
16	on	on	off	off	off	on
17	on	on	off	off	off	off
20	on	off	on	on	on	on
21	on	off	on	on	on	off
22	on	off	on	on	off	on
23	on	off	on	on	off	off
24	on	off	on	off	on	on
25	on	off	on	off	on	off
26	on	off	on	off	off	on
27	on	off	on	off	off	off

## Extended-Local I/O Adapter Module

### (1771-ALX) Switch SW1

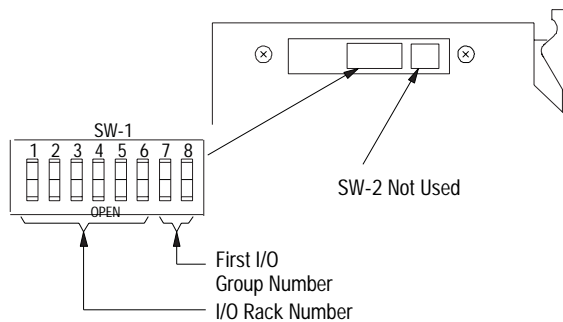

Rack:	1	2	3	4	5	6
01	on	on	on	on	on	off
02	on	on	on	on	off	on
03	on	on	on	on	off	off
04	on	on	on	off	on	on
05	on	on	on	off	on	off
06	on	on	on	off	off	on
07	on	on	on	off	off	off
10	on	on	off	on	on	on
11	on	on	off	on	on	off
12	on	on	off	on	off	on
13	on	on	off	on	off	off
14	on	on	off	off	on	on
15	on	on	off	off	on	off
16	on	on	off	off	off	on
17	on	on	off	off	off	off
20	on	off	on	on	on	on
21	on	off	on	on	on	off
22	on	off	on	on	off	on
23	on	off	on	on	off	off
24	on	off	on	off	on	on
25	on	off	on	off	on	off
26	on	off	on	off	off	on
27	on	off	on	off	off	off

## (1771-ALX) Configuration Plug

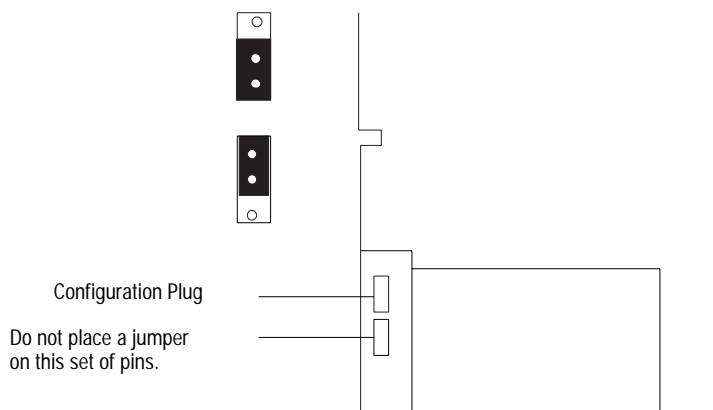

1. Lay the module on its right side.

The configuration plugs are visible on the lower rear of the module.

2. Set the configuration plug as shown below according to your application.

17341

If You are Using	But Not	Set Configuration Plug
32-point I/O modules and any address method	1771-IX or 1771-IY	on the 2 lower pins
1771-IX and 1771-IY modules and any addressing method	32-point I/O modules	on the 2 upper pins

# Troubleshooting

## Using This Chapter

<b>For Information About Troubleshooting:</b>	<b>Go to Page:</b>
PLC-5 controller	F-2
Remote I/O system	F-6
Extended-local I/O system	F-9
Unexpected PLC-5 controller operation when entering run mode	F-10

## PLC-5 Controller General Problems

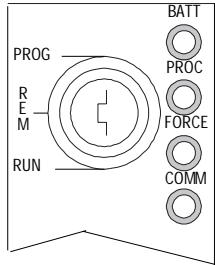

Indicator	Color	Description	Probable Cause	Recommended Action
PROC	Green (steady)	Controller is in run mode and fully operational	Normal operation	No action required
	Green (blinking)	Controller memory is being transferred to EEPROM	Normal operation	No action required
	Red (blinking)	Major fault	<ul style="list-style-type: none"> <li>RSLogix 5 download in progress</li> <li>Run-time error</li> </ul>	During RSLogix 5 download, this is normal operation - wait for download to complete.  If not during RSLogix 5 download:  <ul style="list-style-type: none"> <li>Check major fault bit in status file (S:11) for error definition</li> <li>Clear fault, correct problem, and return to run mode</li> </ul>
	Alternating Red and Green	Controller in FLASH-memory programming mode	Normal operation if controller's FLASH memory is being reprogrammed	No action required - allow flash update to complete
	Red (steady)	Power cycle with problem battery	Battery is low, disconnected or not installed	Properly replace or install battery (see Chapter 1 for more information)
	Red (steady)	Fault with memory loss	New controller  Invalid ControlNet network address  Controller has failed internal diagnostics	Use programming software to clear and initialize memory  Verify that ControlNet address switch is not set to 0  Install battery (to preserve failure diagnostics), then power down, reseal controller and power up; then reload your program. If you are unable to reload your program, replace the controller. If you are able to reload your program and fault persists, contact Technical Support at 440.646.6800 to diagnose the problem.
Off	Controller is in program load or test mode or is not receiving power		Check power supply and connections	

<b>Indicator</b>	<b>Color</b>	<b>Description</b>	<b>Probable Cause</b>	<b>Recommended Action</b>
FORCE	Amber (steady)	SFC and/or I/O forces enabled	Normal operation	No action required
	Amber (blinking)	SFC and/or I/O forces present but not enabled		
	Off	SFC and/or I/O forces not present		
COMM	Off	No transmission on channel 0	Normal operation if channel is not being used	
	Green (blinking)	Transmission on channel 0	Normal operation if channel is being used	

## Controller Communication Channel Troubleshooting

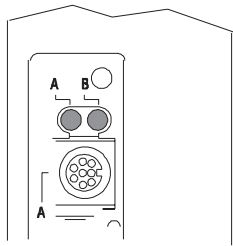

Indicator	Color	Channel Mode	Description	Probable Cause	Recommended Action
A or B	Green (steady)	Remote I/O Scanner	Active Remote I/O link, all adapter modules are present and not faulted	Normal operation	No action required
		Remote I/O Adapter	Communicating with scanner		
		DH+	Controller is transmitting or receiving on DH+ link		
	Green (blinking rapidly or slowly)	Remote I/O Scanner	At least one adapter is faulted or has failed	<ul style="list-style-type: none"> <li>Power off at remote rack</li> <li>Cable broken</li> </ul>	<ul style="list-style-type: none"> <li>Restore power to the rack</li> <li>Repair cable</li> </ul>
		DH+	No other nodes on network		
	Red (steady)	Remote I/O Scanner Remote I/O Adapter DH+	Hardware fault	Hardware error	Turn power off, then on  Check that the software configurations match the hardware set-up  Replace the controller.
Red (blinking rapidly or slowly)		Remote I/O Scanner	All adapters faulted	<ul style="list-style-type: none"> <li>Cable not connected or broken</li> <li>Power off at remote racks</li> </ul>	<ul style="list-style-type: none"> <li>Repair cable</li> <li>Restore power to racks</li> </ul>
		DH+	Bad communication on DH+	Duplicate node detected	Correct station address
	Off	Remote I/O Scanner Remote I/O Adapter DH+	Channel offline	Channel is not being used	Place channel online if needed

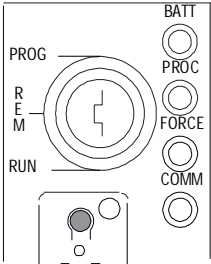

## Extended-Local I/O Troubleshooting

Indicator	Color	Channel Mode	Description	Probable Cause	Recommended Action
 <p>PLC-5/40L and -5/60L processors only</p>	2	Extended local I/O Scanner	active extended-local I/O link, all adapter modules are present and not faulted	normal operation	no action required
	green (steady)		at least one adapter is faulted or has failed	<ul style="list-style-type: none"> <li>power off at extended-local I/O rack</li> <li>communication fault</li> <li>cable broken</li> </ul>	<ul style="list-style-type: none"> <li>restore power to the rack</li> <li>restart adapters using the controller restart lockout pushbutton</li> <li>repair cable</li> </ul>
	green (blinking rapidly or slowly)	Extended local I/O Scanner	hardware fault	hardware error	Turn power off, then on. Check that the software configurations match the hardware set-up. Replace the controller.
	red (steady)		all adapters faulted	<ul style="list-style-type: none"> <li>cable disconnected or broken</li> <li>terminator off</li> <li>power off at extended-local racks</li> </ul>	<ul style="list-style-type: none"> <li>repair cable</li> <li>replace or repair terminator</li> <li>restore power to racks</li> </ul>
	red (blinking rapidly or slowly)		channel offline	channel is not being used	Place channel online if needed
off					

## Ethernet Status Indicator

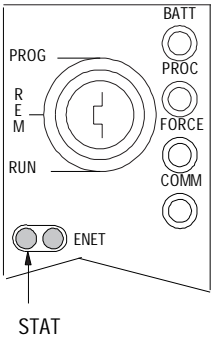
Indicator	Color	Description	Probable Cause	Recommended Action	
	STAT	Solid red	Critical hardware fault	Controller requires internal repair	Contact your local Allen-Bradley representative
		Blinking red	Hardware or software fault (detected and reported via a code)	Fault-code dependent	Contact Allen-Bradley's Global Technical Support (GTS)
		Off	Ethernet interface is functioning properly but it is not attached to an active Ethernet network	Normal operation	Attach the Controller to an active Ethernet network
		Green	Ethernet channel 2 is functioning properly and has detected that it is connected to an active Ethernet network	Normal operation	No action required

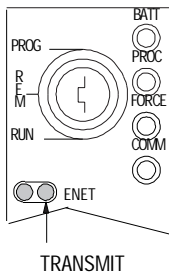

### Ethernet Transmit LED

The PLC-5 Ethernet interface contains an Ethernet Transmit LED that lights (green) briefly when the Ethernet port is transmitting a packet. It does not indicate whether or not the Ethernet port is receiving a packet.

### Remote I/O System

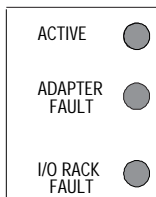

### Troubleshooting Guide for the 1771-ASB Series C and D Adapter Module

Indicators			Description	Probable Cause	Recommended Action
Active	Adapter Fault	I/O Rack			
On	Off	Off	Normal indication; remote adapter is fully operational		
Off	On	Off		RAM memory fault, watchdog timeout	Replace module.
On	Blink	Off	Module placement error	I/O module in incorrect slot.	Place module in correct slot in chassis.
Blink in unison		Off	Incorrect starting I/O group number	Error in starting I/O group number or I/O rack address	Check switch settings.
On	On	On	Module not communicating	Incorrect transmission rate setting	
Off	On	On	Module not communicating	Scan switch set for "all but last four slots" in 1/4 rack	Reset scan switch setting.
Blink	Off	Off	Remote adapter not actively controlling I/O (scanner to adapter communication link is normal) <sup>(1)</sup>	Controller is in program or test mode Scanner is holding adapter module in fault mode	Fault should be cleared by I/O scanner.
LEDs sequence on/off from top to bottom			Module not communicating	Another remote I/O adapter with the same address is on the link.	Correct the address.

Indicators			Description	Probable Cause	Recommended Action
Active	Adapter Fault	I/O Rack			
Blink alternately		Off	<p>Adapter module not actively controlling I/O<sup>(2)</sup></p> <p>Adapter module in controller restart lockout mode (adapter to scanner link is normal)</p>	<p>Controller restart lockout switch on chassis backplane switch assembly on<sup>(3)</sup></p>	<p>Press reset button to clear lockout feature or cycle power; if after repeated attempts indicators are still blinking, check:</p> <ul style="list-style-type: none"> <li>• push button not wired properly to field wiring arm</li> <li>• wiring arm not connected to adapter module</li> <li>• adapter module was reset by process or/ scanner, then immediately faulted</li> </ul>

<sup>(1)</sup> If a fault occurs and the Controller is in the run mode but is actually operating in the dependent mode, the chassis fault response mode is selected by the last state switch on the chassis backplane.

<sup>(2)</sup> The I/O chassis is in faulted mode as selected by the last state switch on the chassis backplane.

<sup>(3)</sup> You must select the operating mode of the remote I/O adapter module as outlined in the publication furnished with the remote I/O scanner/distribution panel, remote I/O scanner-program interface module, or I/O scanner-message handling module. Pay close attention to the disable search mode in the 1771-SD, -SD2.

## Troubleshooting Guide for the 1771-ASB Series C and D Adapter Module (continued)

Indicators			Description	Probable Cause	Recommended Action
Active	Adapter Fault	I/O Rack			
Off	Off	On	I/O chassis fault. <sup>(1)</sup> No communication on link.	Problem exists between: <ul style="list-style-type: none"> <li>• adapter and module in chassis; the module will stay in fault mode until fault is corrected</li> <li>• shorted printed circuit board runs on backplane or I/O module</li> </ul>	Cycle power to the chassis to clear a problem resulting from high noise. <sup>(2)</sup> <ul style="list-style-type: none"> <li>• Remove and replace all I/O modules one at a time</li> <li>• If problem does not clear, something is wrong in chassis or I/O module</li> </ul>
Blink	Off	On	Communication on link. Possible shorted backplane	<ul style="list-style-type: none"> <li>• Noise on backplane</li> <li>• Shorted circuit board runs</li> <li>• Faulty card in chassis</li> </ul>	<ul style="list-style-type: none"> <li>• Eliminate noise</li> <li>• Isolate noise</li> <li>• Add surge suppression</li> <li>• Replace chassis</li> <li>• Replace defective card in chassis</li> </ul>
Blink	On	Off	Module identification line fault	Excessive noise on backplane	Verify power supply and chassis grounding.
Off	Off	Off	Module not communicating	Power supply fault  Wiring from scanner to adapter module disrupted  Scanner not configured properly  One faulted chassis within a rack group address causing scanner/distribution panel to fault all chassis in rack group address (when in disable search mode)	Check power supply, cable connections, and make sure adapter module is fully seated in chassis.  Correct cable and wiring defects  See publication 1772-2.18 for scanner configuration.  Check sequentially from the first module to the last module to pinpoint fault; correct any faults and proceed to the next chassis.

<sup>(1)</sup> The I/O chassis is in faulted mode as selected by the last state switch on the chassis backplane.

<sup>(2)</sup> Cycling power clears block-transfer request queue. All pending block transfers are lost. Your program must repeat the request for block transfers.

## Extended-Local I/O System Troubleshooting Guide for the 1771-ALX Adapter Module

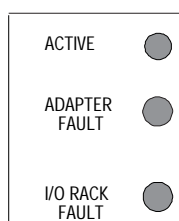

Indicators			Description	Probable Cause	Recommended Action
Active	Adapter Fault	I/O Rack			
On	Off	Off	Normal indication; remote adapter is fully operational		
Off	On	Off	Local adapter fault <sup>(1)</sup>	Local adapter not operating; it will stay in fault mode until fault is corrected	Cycle power to the chassis to clear the adapter fault. <sup>(2)</sup> Replace adapter if fault does not clear.
Off	Off	On	I/O chassis fault <sup>1</sup>	Problem exists between: <ul style="list-style-type: none"> <li>• adapter and module in chassis; the module will stay in fault mode until fault is corrected</li> <li>• shorted printed circuit board runs on backplane or I/O module</li> </ul>	Cycle power to the chassis to clear a problem resulting from high noise. <sup>2</sup> <ul style="list-style-type: none"> <li>• remove and replace all I/O modules one at a time</li> <li>• replace adapter</li> <li>• If problem does not clear, something is wrong in chassis or I/O module</li> </ul>
Blinking	Off	Off	Outputs are reset	Controller is in program or test mode Local I/O Scanner is holding adapter module in fault mode	None  Fault should be cleared by extended-local I/O scanner.
Blinking alternately	Off	Off	Adapter module not actively controlling I/O <sup>1</sup> Adapter module in controller restart lockout mode (adapter to scanner link is normal)	Controller restart lockout switch on chassis backplane switch assembly on <sup>(3)</sup>	Press chassis reset button to clear lockout feature or cycle power; if after repeated attempts indicators are still blinking, check that adapter module was reset by controller/scanner, then immediately faulted.
Off	Off	Off	No power or no communication.	Power supply fault	Check power supply, I/O cable and power supply cable connections, and make sure adapter module is fully seated in chassis.
On	Blinking	Off	Module placement error in extended-local I/O chassis	Incorrect placement of high-density modules	Verify addressing modes and switch settings.

<sup>(1)</sup> Cycling power clears the block-transfer request queue. All pending block transfers are lost. Your program must repeat the request for block transfers from the chassis.

<sup>(2)</sup> If a fault occurs and the controller is in the run mode but is actually operating in the dependent mode, the chassis fault response mode is selected by switch 1 (the last state switch) on the chassis backplane.

<sup>(3)</sup> The I/O chassis is in faulted mode as selected by switch 1 (the last state switch) on the chassis backplane.

## Unexpected Operation when Entering Run Mode

If unexpected operation occurs whenever your controller enters run mode, be sure to examine the prescan operation of the instructions in this section. These instructions execute differently during prescan than they do during a normal scan.

The prescan function is an intermediate scan between the transition from program to run modes, during which all rungs are scanned as false. The prescan examines all ladder program files and instructions and initializes the data table based on the results of the program.

For example, a subroutine that is called infrequently may contain a bad indirect address and generate a major fault. However, many normal program scans may occur before the major fault is actually generated. Prescan provides the opportunity for the controller to examine the program for errors such as this before transitioning to Run mode.

### Instructions with Unique Prescan Operations

Use the table below to track prescan operations that deviate from normal instruction operation.

This Instruction:	Executes These Actions During Prescan:
ARD	If the EN bit is set and the DN and ER bits are cleared, then the control word is cleared. If either the DN or ER bit is set, then the EN bit is cleared and the DN bit is set.
ARL	
AWT	
AWA	
ACB	
ABL	
AHL	
BTR	All non-user configuration bits 15, 14, 13, 12, 10, and 9 are cleared (for both INT and BT file types).
BTW	
CTU	The CU/CD bit is set to prevent a false count when the first run-mode scan begins.
CTD	
EOT	This instruction is skipped so all ladder instructions can be prescanned.
FFL	The EL bit is set to prevent a false load when the first run-mode scan begins.
LFL	
FFU	The EU bit is set to prevent a false unload when the first run-mode scan begins.
LFU	
FND	This instruction is skipped so all ladder instructions can be prescanned.

<b>This Instruction:</b>	<b>Executes These Actions During Prescan:</b>
FOR	Ladder instructions within the FOR/NXT loop <b>are</b> prescanned.
MSG	If the SFC startover bit is cleared and the CO bit is cleared, then all non-user configuration bits 15, 14, 13, 12, 10, and 9 are cleared in both the INT and MG file types. The MG file type also clears bits 11, 7, 6, 5, 4, 2, 1, and 0.
ONS	The programmed bit address of the instruction is set to inhibit false triggering when the first run-mode scan begins.
OSF	The programmed bit address of the instruction is cleared to inhibit false triggering when the first run-mode scan begins. The output bit is also cleared.
OSR	
PID	For PD file type, the INI bit is cleared.  INT file type clears status bits 8, 9, and 10 (deadband, upper, and lower output alarm). The error register from the previous scan is set to 32767, which indicates that the setpoint and ER bits from previous scans have not yet been initialized). The Integral Accumulator and Derivative Error bits are cleared.
SQL	The EN bit is set to prevent a false increment of the table pointer when the first run-mode scan occurs.
SQO	
TOF	The TT, TC, TE, and TO bits are cleared and the ACC = preset.
DTR <sup>(1)</sup>	The reference value is updated (regardless of the rung condition).

<sup>(1)</sup> The DTR instruction operates in this manner during a normal scan as well.

## Suggested Action

To avoid unexpected operation that may result from these prescan activities, follow these guidelines:

- Do not use indexed or indirect addressing with the instructions listed in the above table.
- If you *must* use indexed or indirect addressing, use the first scan bit (S:1/15) to pre-initialize all of the other used variables.
- If using indirect addressing with any ladder instructions, do not use the data variable holding the indirect address for multiple functions.

## Notes



## Cable Reference

### Using This Chapter

For Information About	Go to Page
Channel 0 pin assignments	G-1
Serial cable pin assignments	G-2
Connecting diagrams	G-3
Programming cable specification	G-5
Ethernet cable connections	G-9

**Channel 0 Pin Assignments** The side label of the controller shows a table listing channel 0 (RS-port) pin assignments. This table shows the same information:

Pin	RS-232C	RS-422A	RS-423	Pin	RS-232C	RS-422A	RS-423
1	C.GND	C.GND	C.GND	14	NOT USED	TXD.OUT <sup>-</sup>	SEND COM
2	TXD.OUT	TXD.OUT <sup>+</sup>	TXD.OUT	15			
3	RXD.IN	RXD.IN <sup>+</sup>	RXD.IN	16	NOT USED	RXD.IN <sup>-</sup>	REC COM
4	RTS.OUT	RTS.OUT <sup>+</sup>	RTS.OUT	17			
5	CTS.IN	CTS.IN <sup>+</sup>	CTS.IN	18			
6	DSR.IN	DSR.IN <sup>+</sup>	DSR.IN	19	NOT USED	RTS.OUT <sup>-</sup>	NOT USED
7	SIG.GND	SIG.GND	SIG.GND	20	DTR.OUT	DTR.OUT <sup>+</sup>	DTR.OUT
8	DCD.IN	DCD.IN <sup>+</sup>	DCD.IN	21			
9				22	NOT USED	DSR.IN <sup>-</sup>	NOT USED
10	NOT USED	DCD.IN <sup>-</sup>	NOT USED	23	NOT USED	DTR.OUT <sup>-</sup>	NOT USED
11				24			
12				25			
13	NOT USED	CTS.IN <sup>-</sup>	NOT USED				

The shading indicates that the pin is reserved.

## Serial Cable Pin Assignments

The following diagrams show the pin assignments for the cables you need for serial port communications.

**Cable #1**

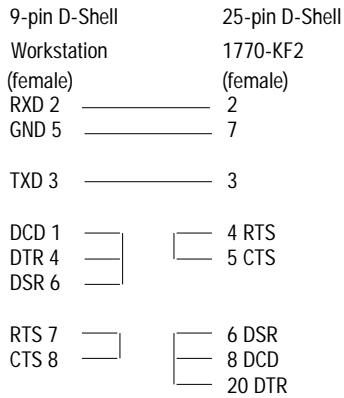

11955-I

**Cable #2**

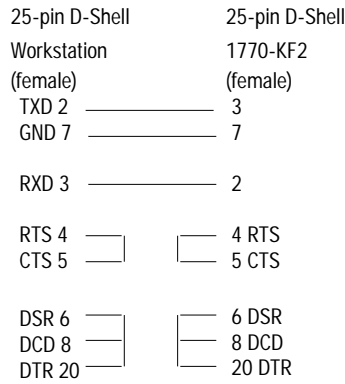

11957-I

**Cable #3**

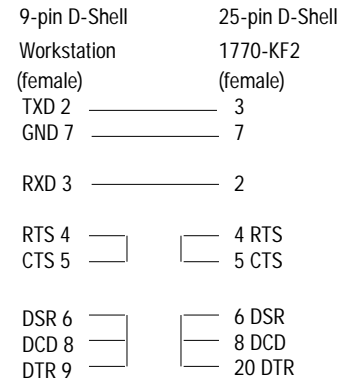

11958-I

**Cable #4**

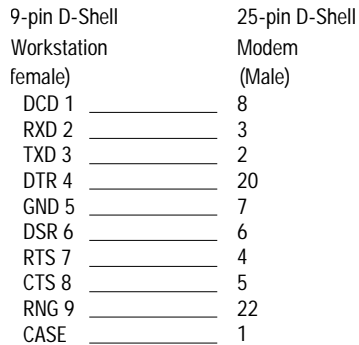

11959-I

**Cable #5**

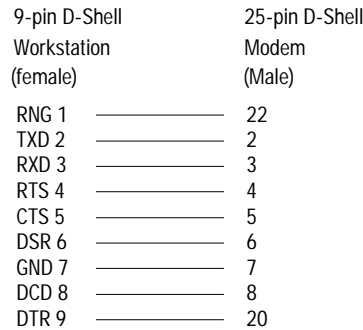

11960-I

**Cable #6**

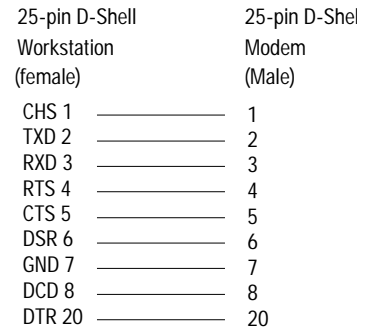

11961-I

## Connecting Diagrams

### 9-Pin Serial Port Workstation

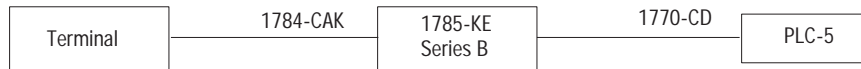
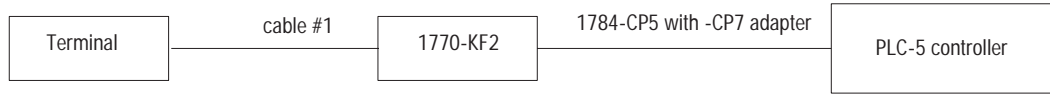

Note: 1785-KE Series A uses 1785-CP5 cable and 1785-CP7 adapter with the Enhanced and Ethernet PLC-5 Programmable Controllers

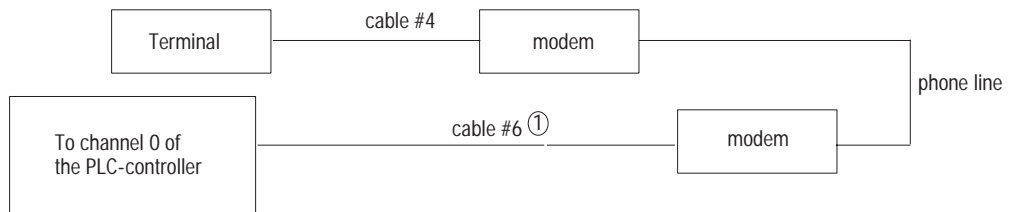
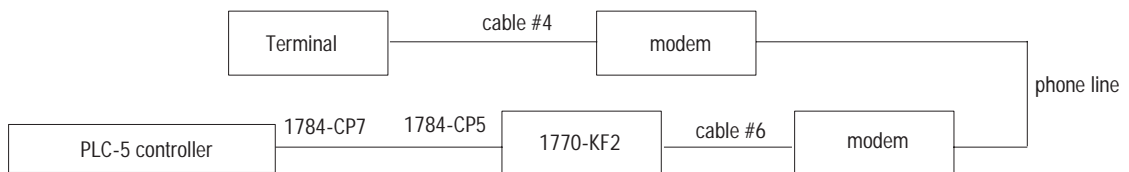

① Requires either a gender changer or one end of cable #2 fitted with a male 25-pin plug.

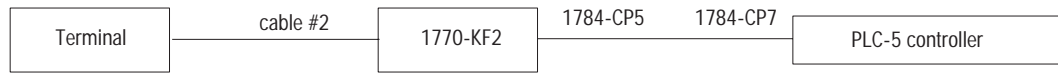

**25-Pin Serial Port Workstation**

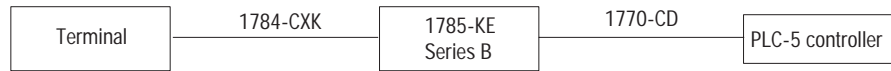

Note: 1785-KE Series A uses 1785-CP5 cable and 1785-CP7 adapter with the Enhanced and Ethernet PLC-5 controller

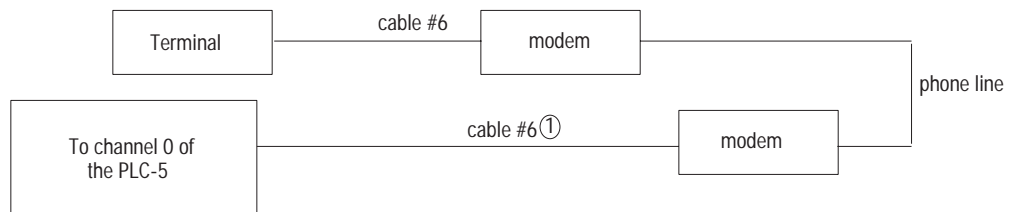
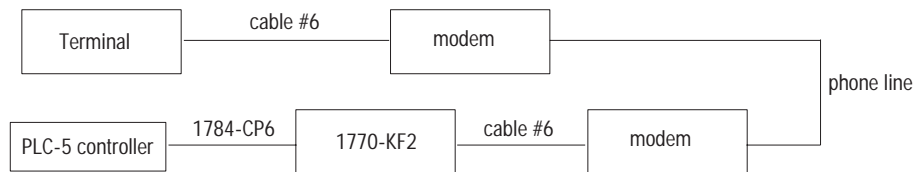
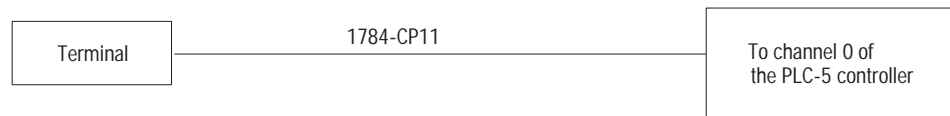

① Requires either a gender changer or one end of cable #2 fitted with a male 25-pin plug.

# Programming Cable Specifications

The specifications for each Allen-Bradley cable used for DH+ communications are shown on the following pages. Refer to the following table for the exact location.

For	To	Use this Cable	See Page
Workstation	1785-KE	1784-CAK	25-5
Enhanced or Ethernet PLC-5 controller	Workstation (using a 1784-KT, -KT2, -KL, or -KL/B)	1784-CP6	25-6
		1784-CP with a 1784-CP7 adapter	25-6
		1784-CP8 adapter	25-7
	Workstation (using a 1784-KTK1)	1784-CP5 with a 1785-CP7 adapter	25-6
	Workstation (using a 9-pin serial cable)	1784-CP10	25-7
	Workstation (using a serial 25-pin cable)	1784-CP11	25-8
Workstation (using a 1784-PCMK)	1784-PCM5 with a 1784-CP7 adapter	25-8 and 25-6	

## Cable - 1784-CAK Connects 1785-KE to Workstation<sup>T</sup>

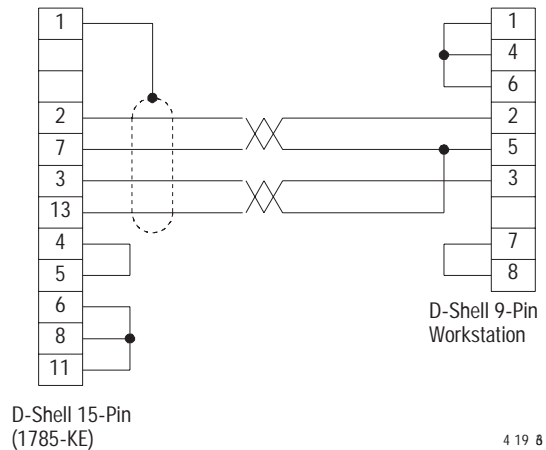
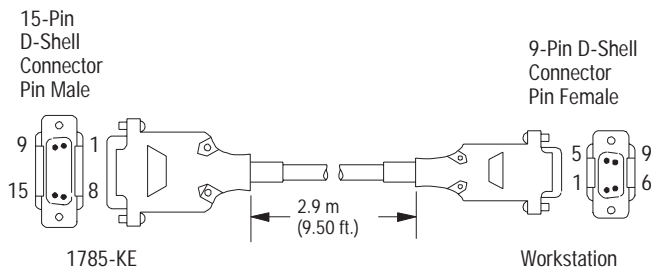

4 19 8



**Cable Adapter - 1784-CP8 Connects a Workstation Using a 1784-KT, -KT2, or -KL Card to a Permanent DH+ Network**

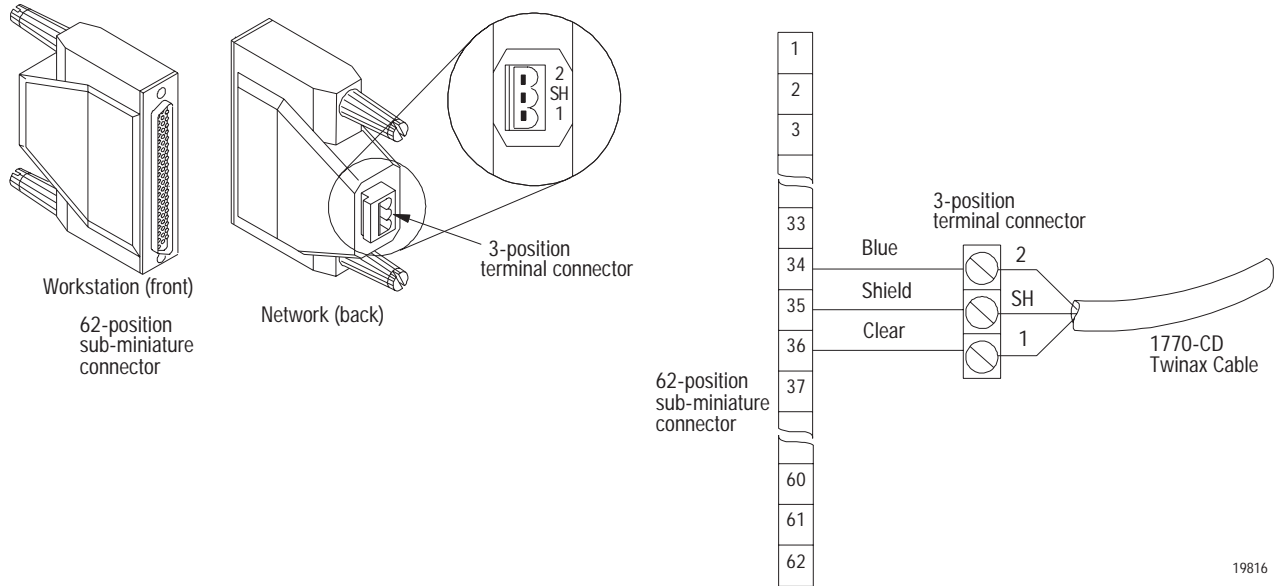

19816

**Cable - 1784-CP10 Connects Workstation to Controller Using Serial Port**

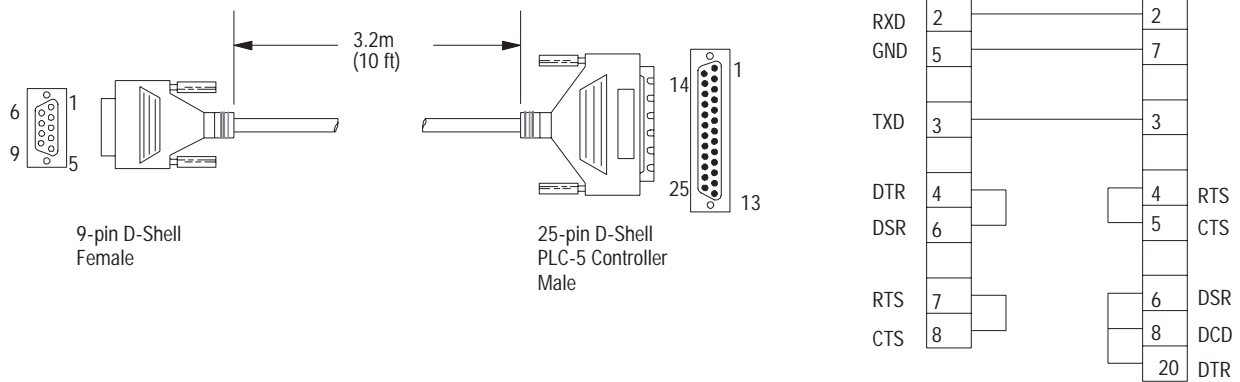

19870

**Cable - 1784-CP11  
Controller to Workstation Using a Serial Port**

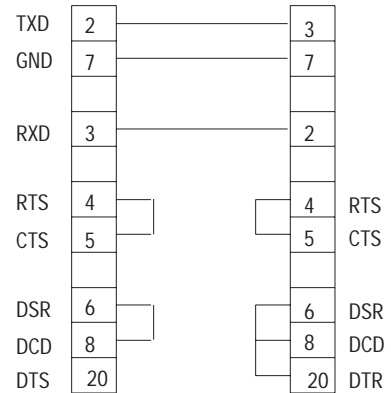
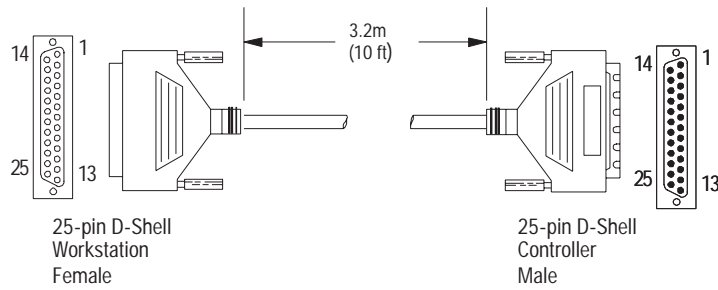

19871

**Cable - 1784-PCM5  
Controller to Workstation (using a 1784-PCMK)**

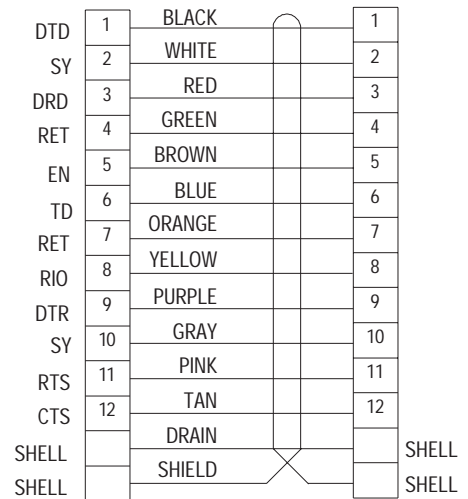
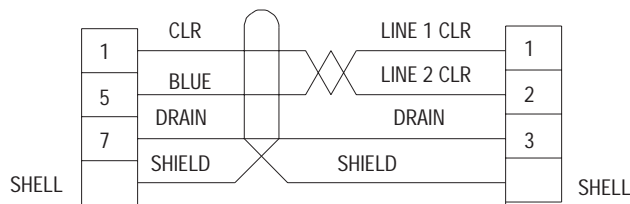
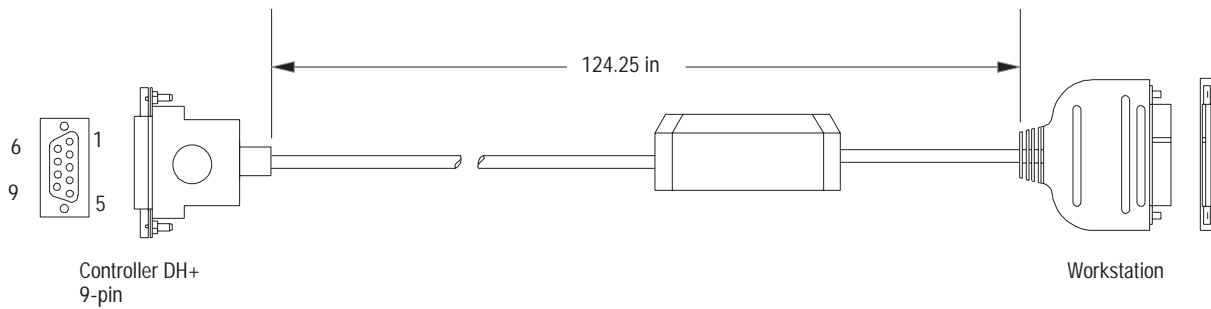

19872



## Ethernet Cable Connections

The Ethernet port connects to either a thin-wire or thick-wire network via a 15-pin transceiver or Medium Access Unit (MAU) connection.

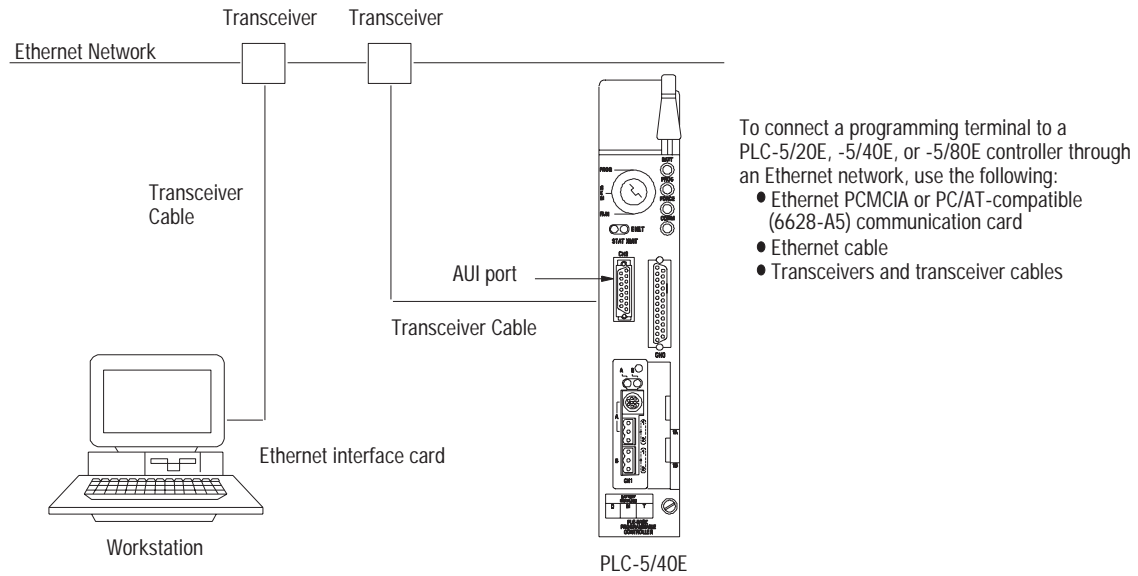

The table below describes Allen-Bradley transceivers:

Catalog Number	Description
1785-TR10BT	Twisted pair transceiver
1785-TR10BF	Optical transceiver
1785-TR10B2	Thin-wire transceiver
1785-TR10B5	Thick-wire transceiver
5810-AXMT	Thin-wire Ethernet/802.3 transceiver
5810-AXMH	Thick-wire Ethernet/802.3 transceiver

The controller connects to the transceiver using a standard transceiver cable, which is also known as an Access Unit Interface (AUI) cable. Allen-Bradley has two lengths of transceiver cables and four kits consisting of transceivers and cables.

<b>Catalog Number</b>	<b>Description</b>
5810-TER	Thinwire Ethernet terminating resistors
5810-TC02/A	Thick-wire 2.0 m (6.5 ft) transceiver cable
5810-TC15/A	Thick-wire 15.0 m (49.2 ft) transceiver cable
5810-TAS/A (kit)	Thin-wire transceiver and 2.0 m (6.5 ft) cable
5810-TAM/A (kit)	Thin-wire transceiver and 15.0 m (49.2 ft) cable
5810-TBS/A (kit)	Thick-wire transceiver and 2.0 m (6.5 ft) cable
5810-TBM/A (kit)	Thick-wire transceiver and 15.0 m (49.2 ft) cable

Connection to “10baseT” (fiber-optic) and broadband networks is also supported if you purchase the appropriate transceivers and cables from a third-party source.

## Numerics

1/2slot addressing 4-3, E-4, E-5  
 1770KF2 9-2  
 1771AF 6-6  
 1771ALX 8-1, E-5, F-9  
 1771AS 6-6  
 1771ASB 6-6, 6-11, E-5, F-6  
 1771CD 9-2  
 1771DCM 6-6  
 1771KRF 9-2  
 1771SN 6-6  
 1772SD, SD2 6-6  
 1775S4A, S4B 6-6  
 1775SR 6-6  
 1784CAK G-5  
 1784CP 9-2, G-6  
 1784CP10 G-2, G-5, G-7  
 1784CP11 G-2, G-5, G-8  
 1784CP2 9-2  
 1784CP3 9-2  
 1784CP5 9-2, G-5, G-6  
 1784CP6 9-2, G-5, G-6  
 1784CP7 G-5, G-6  
 1784CP8 G-5, G-7  
 1784KL 9-2, G-5, G-6, G-7  
 1784KT 9-2, G-5, G-6, G-7  
 1784KT2 9-2, G-5, G-6, G-7  
 1784KTK1 G-5  
 1784PCM5 9-2, G-5, G-6, G-8  
 1784PCMK 9-2, G-5, G-8  
 1785KA 9-2  
 1785KA5 9-2  
 1785KE 9-2, G-5  
 1785-RC Relay Cartridge 1-1  
 1slot addressing 4-3, E-4, E-5  
 2slot addressing 4-3, E-4, E-5  
 6008SQH1, SQH2 6-6

## A

active buffers 6-14  
 adapter mode
 

- adapter channel status 7-17, 7-19
- blocktransfer programming example 7-14
- channel configuration 7-2
- communicating with 7-1
- configuring channels 7-3
- defined 1-12

discrete transfer configuration file 7-2, 7-9  
 effects of blocktransfer on discrete data 7-15  
 programming block transfers 7-10  
 supervisory processor status 7-18  
 transferring data 7-10

## addressing

32point example 4-5  
 8 and 16point example 4-4  
 assigning
 

- DH+ node address 9-4
- rack numbers 4-8

 blocktransfer modules 4-7  
 choosing a mode 4-3  
 concept 4-1  
 data files 4-16  
 Ethernet 11-2  
 Ethernet broadcast 11-9  
 extendedlocal I/O 8-2  
 I/O image 4-16  
 I/O status file 6-24  
 indexed 4-20  
 indirect 4-18  
 logical 4-17  
 mnemonics 4-18  
 racks 8-10  
 relating a bit to an input/output device 4-2  
 remote I/O racks 4-9  
 selecting mode E-4, E-5  
 stations in poll file 10-17  
 summary 4-7  
 symbolic 4-21  
 terms 4-1

## ASCII

configuring serial port 10-18  
 instructions D-27  
 status 10-24

automatic configuration 6-9, 6-10, 8-9, 8-11

## B

backpanel spacing 3-5

## backplane

switch settings E-4, E-5

**Belden 9463** 6-3

## bit

data storage 4-11

**bit modify instructions** D-16

**blocktransfer** 2-3, 4-7, 5-3, 5-4, 6-13, 6-14, 6-15, 6-16, 6-17, 6-19, 6-20, 7-7, 7-10, 7-11, 7-14, 8-6, 8-7, 15-11, 17-2, 18-3, C-8, C-12, D-25

## **BOOTP**

disabling 11-4  
example 11-8  
hardware address 11-8  
IP address 11-7  
using 11-5

**broadcast addressing** 11-9

## **C**

### **cables**

Belden 9463 6-3  
communication interfaces G-5  
DH+ link 9-2  
Ethernet 11-1, G-9  
extendedlocal I/O 8-2  
pin assignments G-2  
programming 9-2  
raceway layout 3-4  
reference G-1  
remote I/O 6-5  
routing conductors 3-4  
serial 10-5

### **calculating**

processor scan time C-11, C-12  
remote I/O scan time C-9  
throughput C-5  
timing C-5

**changing modes** 1-9

### **channel**

adapter configuration 7-2  
configuring  
remote I/O adapter 7-3  
remote I/O scanner 6-6  
DH+ configuration 9-3, 9-4  
Ethernet  
using 6200 software 11-3  
using BOOTP 11-5  
extendedlocal I/O 8-9  
extendedlocal I/O scanner configuration 8-9  
monitoring  
DH+ link 9-12  
extendedlocal I/O 8-12  
remote I/O adapter 7-19  
remote I/O scanner 6-21  
privilege class 12-4  
remote I/O scanner configuration 6-7

serial 10-6  
troubleshooting F-4

### **channel status**

DH+ 9-12  
Ethernet 11-35  
extendedlocal I/O 8-12  
remote I/O adapter 7-19  
remote I/O scanner 6-21  
serial 10-22

### **chassis**

configuration plug E-6  
dimensions 3-1  
setting switches E-4, E-5  
spacing 3-1

### **classes**

privileges 12-3

### **communicating**

1771ASB 6-11  
DH+ link 9-1  
Ethernet 11-1  
extendedlocal I/O 8-1  
pointtopoint 10-3  
serial devices 10-1  
with adapter channel 7-1

### **communication**

configuring serial mode change 10-21  
rate C-7

**compare instructions** D-5

**complementary I/O** 4-24

### **completed**

program state 13-12

### **components**

front panel 1-2  
spacing 3-1

**compute instructions** D-7

**conductors** 3-4

### **configuring**

ASCII (user mode) 10-18  
blocktransfer requests in an adapter channel 7-11  
chassis  
extendedlocal I/O E-10  
power supply E-6  
communication mode change 10-21  
DF1 master 10-12  
DF1 slave 10-9  
DH+ channel 9-3  
discrete transfer configuration files 7-5  
Ethernet  
using 6200 software 11-3  
using BOOTP 11-5  
extendedlocal I/O scanner channel 8-9  
fault routine 15-4

- I/O status file 6-7
  - main control programs 16-4
  - PII 18-5
  - pointtopoint 10-6
  - processorresident rack 5-4
  - remote I/O adapter channel 7-2, 7-3
  - remote I/O scanner channel 6-6
  - serial port 10-2, 10-6
  - startup procedure 14-3
  - STI 17-3
  - connections**
    - Ethernet G-9
  - control bits** 14-3
  - controller documentation** A-1
  - controller specifications** A-1
  - controlling outputs** 15-3
  - conversion instructions** D-15
  - cooling** 3-1
  - counter instructions** D-4
- D**
- daisy chain** 6-5, 9-2
  - data block** 4-11
  - data file**
    - addressing 4-13
    - range of values 4-15
    - read/write privileges 12-5
    - types of addressing 4-16
    - unused 4-12
  - data storage**
    - bit 4-11
    - concepts 4-10
    - data block 4-11
    - files 4-11
    - member 4-11
    - structure 4-11
    - type 4-11
    - userdefined 4-11
    - words 4-11
  - data table**
    - file defaults 4-13
    - memory per file 4-12
  - data transfer** 6-11
    - blocktransfer 8-6
    - effects of blocktransfer on discrete data 7-15
    - extendedlocal I/O 8-4
    - I/O backplane transfer time C-6
    - I/O transfer time C-6
    - system design C-10
    - types 1-12
  - data type**
    - valid values 4-15
  - delay**
    - due to online editing C-4
  - density**
    - I/O modules 2-2
  - design tip**
    - addressing and placing extendedlocal I/O 8-2
    - addressing extendedlocal I/O racks 8-3
    - assigning privileges 12-3
    - assigning racks 4-8
    - assigning remote I/O rack numbers 4-9
    - blocktransfer programming 6-19
    - DH+ link design 9-17
    - editing the scan list for multiple rackupdates 6-10
    - extendedlocal I/O link design 8-2
    - global status flag file 9-6
    - group data 4-12
    - guidelines for PIs 18-4
    - guidelines for writing STI programs 17-1
    - optimizing instruction execution time 4-22
    - optimizing processor memory 4-22
    - organizing files 4-12
    - placing blocktransfer modules 5-3
    - placing extendedlocal I/O modules 8-4
    - program design tips C-13
    - programming considerations for extendedlocal I/O 8-8
    - remote I/O cable design 6-5
    - remote I/O link 6-4
    - RS232, 422A, and 423 cable lengths 10-5
    - split global status flags files across channels C-5
    - using blocktransfers in STIs 17-2
    - writing PII programs 18-2
  - devices**
    - DH+ link 9-2
    - extendedlocal I/O 8-1
    - maximum 6-4
    - remote I/O 6-2
    - serial 10-1
  - DF1 master**
    - communication 10-3
    - configuring 10-12
    - polling scheme 10-16

**DH+ link**

- cable lengths **9-2**
- communicating with devices **9-1**
- configuring channels **9-3**
- default address **9-3**
- defining the processor address **9-4**
- design tip **9-17**
- diagnostic counters **9-12**
- estimating performance **9-12**
- global status flag file **9-5**
- internal processing time **9-15**
- message destination **9-14**
- monitoring status **9-12**
- nodes/timing **9-13**
- planning cabling **9-2**
- response time test results **9-16**
- size and number of messages **9-13**
- terminating **9-3**
- token passing **9-13**
- transmission rate **9-4**
- troubleshooting **F-4**

**diagnostic counters**

- DH+ **9-12**
- remote I/O **6-21**

**diagnostic instructions D-19****dimensions**

- chassis **3-1**
- power supplies **3-6**

**discrete data transfer**

- between scanner and remote I/O adapter **7-7**
- extendedlocal I/O **8-5**

**discretetransfer configuration files 7-2, 7-5****discretetransfer data 5-3, 7-10, 7-17, 7-18****DNS 11-15****Domain Name Service 11-15****E****element 4-11****Embedded Web Server 11-16****environment**

- proper **3-1**

**error codes 11-33**

- Ethernet messaging **11-33**

**ESD protection 3-3****Ethernet**

- addressing **11-2**
- advanced functions **11-9**
- broadcast addressing **11-9**
- cables **G-9**
- communication **11-1**
- configuring
  - using 6200 software **11-3**
  - using BOOTP **11-5**
- error codes **11-33**
- gateways **11-11**
- messaging **11-37**
- network requirements **11-1**
- processor performance **11-37**
- status data **11-35**
- subnet masks **11-11**
- transceivers **G-9**
- transmit indicator **F-6**
- troubleshooting **F-5**

**eventdriven interrupts 13-10****example**

- 32point addressing **4-5**
- 8 and 16point addressing **4-4**
- adaptermode blocktransfer **7-14**
- blocktransfer timing in extendedlocal I/O **8-8**
- BOOTP **11-8**
- calculating processor time **C-12**
- efficiently using image table space **4-6**
- PII application **18-2**
- STI application **17-2**

**executing**

- program state **13-12**

**extendedlocal I/O**

- grounding configuration **3-7**

**extendedlocal I/O 1-14, 6-13, 8-1, 8-2, 8-4, 8-7, 8-8, 8-9, 8-10, 8-12, 15-3, E-5, E-9, E-10, F-5, F-9****F****fault routines**

- blocktransfer data **15-11**
- change from ladder logic **15-9**
- configuring **15-4**
- controlling outputs **15-3**
- enabling **15-4**
- how to program **15-6**
- powerup protection **14-1**
- preparing **15-1**
- program flow **13-10**
- programming feature **13-10**
- recover rack fault via ladder logic **15-10**

- startup 14-2
- testing 15-11
- using 15-1
- watchdog timer 15-5
- when to use 13-11
- faulted**
  - program state 13-12
- faults**
  - blocktransfer, minor 6-15
  - clearing 15-7, 15-12
  - detecting major 15-2
  - extendedlocal I/O rack 15-3
  - major 15-1, 15-12
  - major and minor 15-11
  - minor 15-12
  - monitoring 15-12
  - processorresident local I/O rack 15-3
  - remote I/O chassis 15-3
  - remote I/O rack 15-4
  - status information 15-11
- file instructions** D-17
- files** 4-15
  - data storage 4-11
  - read/write privileges 12-5
- floating point**
  - valid value range 4-15
- forcing**
  - inputs and outputs 13-1
  - SFC transitions 13-2
- front panel**
  - PLC5/11,5/20 1-3
  - PLC5/20E 1-6
  - PLC5/30 1-4
  - PLC5/40, 5/60, and 5/80 1-5
  - PLC5/40E and 5/80E 1-7
  - PLC5/40L, 5/60L 1-8

## G

- gapping** 4-12
- gateways** 11-11
- General Ethernet Counters** 11-19
- generating web user provided pages** 11-22
- global inhibit bits**
  - clearing 6-10, 8-11
- global status bits** 15-11, 15-13
  - racks 07 B-3
  - racks 1017 B-10
- global status flags file** C-5
- grounding**
  - extendedlocal I/O system 3-7

- processorresident chassis 3-7
- remote I/O system 3-7

## groups

- definition 4-1

## guidelines

- addressing 4-6, 4-7
- cable routing 3-4
- I/O point size (density) selection 2-2
- I/O selection 2-1
- PII programming considerations 18-4
- placing extendedlocal I/O modules 8-4
- placing I/O modules 2-3
- proper environment 3-1
- selecting interrupt routines 13-11
- STI programming considerations 17-1
- when to use interrupt routines 13-11

## H

### hardware

- fault 15-2

### housekeeping

- effects of C-4

### HTML pages

## I

### I/O addressing

### I/O modules

- cable categories 3-4
- placing 2-3
- select point size (density) 2-2
- selection guidelines 2-1

### I/O scan

- disabling 16-2

### I/O status file

- addressing 6-24
- bit layout 6-24, 6-26
- configuring 6-7

### I/O update

- configuring 16-4

### ignoring empty slots

### image table

- address 4-16
- input and output 4-1

### immediate I/O

- programming with blocktransfers 6-21
- timing 5-3
- using with adjacent blocktransfer modules 5-4

### indexed

- address 4-20

**indicators**

1771ALX **F-9**  
 1771ASB **F-6**  
 communication **F-4**  
 Ethernet **F-5, F-6**  
 extendedlocal I/O **F-5**  
 PLC5/11,5/20 **1-3**  
 PLC5/20E **1-6**  
 PLC5/30 **1-4**  
 PLC5/40, 5/60, and 5/80 **1-5**  
 PLC5/40E and 5/80E **1-7**  
 PLC5/40L, 5/60L **1-8**  
 processor **F-2**

**indirect**

address **4-18**

**instructions**

ASCII **D-27**  
 bit modify **D-16**  
 blocktransfer **D-25**  
 compare **D-5**  
 compute **D-7**  
 conversion **D-15**  
 counter **D-4**  
 diagnostic **D-19**  
 file **D-17**  
 logical **D-14**  
 memory  
   bit and word instructions **D-30**  
   file, program control, and ASCII  
   **D-38**  
 message **D-25**  
 move **D-16**  
 PID **D-25**  
 prescan timing **F-10**  
 program control **D-22**  
 quick reference **D-1**  
 relay **D-2**  
 sequencer **D-21**  
 shift register **D-20**  
 timer **D-3**  
 timing  
   bit and word instructions **D-30**  
   file, program control, and ASCII  
   **D-38**

**interrupt routines 13-10****interrupts C-3**

scheduling **13-11**

**introduction**

processor scanning **5-1**  
 remote I/O **6-3**

**K****keyswitch**

operation **1-9**  
 PLC5/11, 5/20 **1-3**  
 PLC5/20E **1-6**  
 PLC5/30 **1-4**  
 PLC5/40, 5/60, and 5/80 **1-5**  
 PLC5/40E and 5/80E **1-7**  
 PLC5/40L, 5/60L **1-8**

**L****ladder logic 1-10****last state 15-2, E-4, E-5****logic scan 5-2**

time **C-2**

**logical address**

mnemonic **4-18**  
 specifying **4-17**

**logical instructions D-14****M****main control program 16-4****main control programs 1-10, 16-1****major faults**

clearing **15-7, 15-12**  
 defined **15-2**  
 responses **15-1**

**master communication 10-12**

DF1 master mode **10-3**  
 messagebased mode, defined **10-4**  
 pointtopoint **10-6**  
 standard mode **10-4**

**master station polling 10-4****maximizing system performance 16-2****MCPs 1-10**

configuring **16-4**  
 monitoring **16-5**  
 scan time **16-5**  
 scheduling **13-11, 16-2**  
 specify order **16-4**  
 temporarily disable **16-4**  
 using **16-1**

**media**

Ethernet **11-1**

**member**

data storage **4-11**

**memory**

bit and word instructions **D-30**  
 data storage **4-10**  
 data table file sizes **4-13**



- file, program control, and ASCII instructions **D-38**
- gapping **4-12**
- optimizing **4-22**
- program files **4-15**
- protection **E-4**
- memory card diagnostics B-12**
- memory module**
  - transfer **E-4**
- message instruction D-25**
- messagebased communication 10-4**
- messages**
  - DH+ link **9-13**
  - editing online **C-12**
  - Ethernet error codes **11-33**
- minor faults 15-12**
- mnemonic**
  - addressing **4-18**
- modes**
  - adapter **1-12**
  - addressing **4-3**
  - extendedlocal **1-14**
  - keyswitch **1-9**
  - scanner **1-11**
- monitoring**
  - adapter channel status **7-17**
  - DH+ channel status **9-12**
  - Ethernet channel status **11-35**
  - extendedlocal I/O **8-12**
  - faults **15-11**
  - PII **18-6**
  - remote I/O adapter channel status **7-19**
  - remote I/O scanner channel status **6-21**
  - serial port channel status **10-22**
  - STI status **17-4**
  - supervisory processor status **7-18**
- mounting**
  - I/O chassis dimensions **3-5**
  - power supply dimensions **3-6**
- move instructions D-16**
- multihop examples 11-30**
- multihop messaging 11-29**
- multiple chassis status bits 15-11, 15-13**

## N

- noise protection 3-4**
- non-multihop messaging 11-32**

## O

- offline file**
  - privileges **12-4**
- online editing**
  - housekeeping **C-4**
  - messages and blocktransfers **C-12**
  - PIIs **18-4**
  - STIs **17-2**
- operating temperature 3-1**
- optimizing**
  - processor memory and instruction execution **4-22**
  - system **C-5**
- outputs, controlling after a fault 15-3**

## P

- passwords 12-2**
- performance**
  - DH+ link **9-12**
  - Ethernet processor **11-37**
  - housekeeping **C-4**
  - impact of online editing **C-12**
  - maximizing **16-2**
  - maximizing your system **C-1**
  - optimizing instruction execution time **4-22**
  - optimizing processor memory **4-22**
  - PII **18-4**
  - STI **17-2**
- PID D-25**
- PII C-3, C-4**
  - configuring **18-5**
  - example application ladder logic **18-2**
  - monitoring **18-6**
  - performance **18-4**
  - program flow **13-10**
  - programming considerations **18-4**
  - status **18-6**
  - to extendedlocal I/O chassis **8-4**
  - using **18-1**
  - when to use **13-11**
  - with a blocktransfer instruction **18-3**
  - writing ladder logic **18-2**
- placing**
  - backpanels **3-5**
  - extendedlocal I/O **8-2**
  - extendedlocal I/O modules **8-4**
  - I/O modules **2-3**
- points**
  - definition **4-1**
- pointtopoint communication 10-3**

- polling**
    - schemes 10-16
    - techniques 10-4
  - power supplies**
    - mounting dimensions 3-6
  - powerup routines** 13-10, 13-11, 14-1, 14-3
  - priority scheduling** 13-11
  - privilege class**
    - assigned to channel 12-4
    - assigned to node 12-4
    - assigned to offline file 12-4
  - privileges**
    - assigning class to channels 12-4
    - assigning class to offline files 12-4
    - assigning to data files 12-5
    - assigning to program files 12-5
    - defining classes 12-3
    - guidelines for assigning 12-3
    - types of 12-2
  - process control instructions** D-25
  - Processor**
    - specifications A-1
  - processor input interrupt** 8-4, 18-1
  - processor status file**
    - layout B-1
  - processor time**
    - data exchange C-11
    - example C-12
  - processorresident I/O** 6-20, 13-2, 15-3
  - Program (PROG) mode** 1-9
  - program constant**
    - valid value range 4-15
  - program control instructions** D-22
  - program execution** 1-9, 13-12
  - program file**
    - memory 4-15
    - read/write privileges 12-5
    - storage 4-15
  - program scan**
    - activities that can affect the time C-1
    - effect of housekeeping C-4
    - false versus true logic C-2
    - input states C-2
    - instructions C-3
    - introduction 5-2
    - MCP 16-5
    - using interrupts C-3
  - program states** 13-12
  - programming**
    - blocktransfers to an adapter channel 7-10
    - considerations 13-1
    - design tips for better performance C-13
    - effects of blocktransfers on discrete data 7-15
    - extendedlocal I/O 8-8
    - fault routines 15-6
    - features 1-10
    - handling faults in remote I/O chassis 15-4
    - multiple blocktransfers in an adapter channel 7-13
    - protecting 12-1
    - recover from rack fault 15-10
    - terminal connections G-5
  - protecting programs** 12-1
- R**
- raceway layout** 3-4
  - rack addressing limits** A-2
  - rack control bits**
    - racks 07 B-10
    - racks 1017 B-10
  - rack entries, how they affect scan time** C-7
  - rack size**
    - extendedlocal I/O scanner 8-9
    - remote I/O scanner 6-9
  - racks**
    - addressing 8-10
    - definition 4-1
    - extendedlocal I/O 8-3
    - processorresident local I/O 4-8
    - relationship to chassis size and addressing mode 4-8
    - remote I/O 4-9
  - read/write privileges**
    - assigned to data file 12-5
    - assigned to program file 12-5
  - ready**
    - program state 13-12
  - relative humidity** 3-1
  - relay cartridge** 1-1
  - relay instructions** D-2
  - Remote (REM) mode** 1-9
  - remote I/O**
    - adapter mode 7-2
    - adaptermode status 7-19
    - blocktransfers 6-13, 6-15
    - cable lengths 6-5
    - calculating scan time C-9
    - chassis backplane switch setting E-5

- communication rate **C-7**
- configuration overview **6-1**
- configuration steps **6-12**
- data transfer **6-11**
- design **C-10, C-11**
- faults **15-3**
- how blocktransfers affect scan time **C-8**
- I/O status file **6-7**
- introduction **6-3**
- maximum devices **6-4**
- number of rack entries in scan list **C-7**
- optimizing scan time **C-9**
- possible devices **6-2**
- programming blocktransfers **7-10**
- rack fault **15-4**
- scan list **6-3, 6-9**
- scan time **C-6**
- scanner channel configuration **6-6**
- status **6-21**
- switch settings **E-7**
- system setup **6-4**
- terminating the link **6-5**
- troubleshooting **F-4, F-6**
- remote I/O adapter**
  - defined **1-12**
- remote I/O scanner**
  - defined **1-11**
- remote I/O system**
  - grounding configuration **3-7**
- remote mode change** **10-5**
- Run (RUN) mode** **1-9**

## S

- SCADA** **10-1**
- scan list** **6-3**
  - contents **6-9**
  - creating **6-9**
  - extendedlocal I/O **8-9**
  - how entries affect scan time **C-7**
  - limitations **6-10, 8-11**
  - modifying **6-10**
- scan time**
  - calculating **C-5**
- scanner**
  - configuring channels **6-7**
  - creating a scan list **8-9, 8-12**
  - modifying a scan list **8-11**
- scanner mode**
  - block transfer in a PII **18-3**

- blocktransfer **6-15**
- blocktransfer in an STI **17-2**
- channel configuration **6-6**
- communicating with 1771ASB **6-11**
- configuring extendedlocal I/O channels **8-9**
  - creating a scan list **6-9, 8-11**
  - data transfer **6-11**
  - defined **1-11**
  - introduction **5-3**
  - monitoring status **6-21**
- scanning**
  - blocktransfer data **6-13**
  - introduction to **5-1**
- scheduling** **13-11**
- selectable timed interrupt** **17-1**
- sequencer instructions** **D-21**
- sequential function charts** **1-10**
- serial**
  - ASCII (user mode) **10-18**
  - cables **G-2**
  - changing modes **10-5**
  - choosing the digital interface **10-1**
  - communication mode change **10-21**
  - configuring **10-6**
  - DF1 master **10-3, 10-12**
  - DF1 master status **10-23**
  - DF1 pointpoint **10-3**
  - DF1 slave **10-3, 10-9**
  - DF1 slave status **10-22**
  - pin assignments **G-1**
  - planning cabling **10-5**
  - pointpoint **10-6**
  - pointpoint status **10-22**
  - protocols **10-6**
  - setting switches (SW2) **10-2**
  - status **10-22**
  - system mode **10-2**
  - user mode **10-2**
  - user mode (ASCII) status **10-24**
  - using channel 0 **10-2**
- serial devices** **10-1**
- setting switches**
  - chassis backplane **E-4, E-5**
  - extendedlocal I/O **E-9**
  - last state **15-2**
  - remote I/O
    - without complementary I/O **E-7**
  - SW1 **E-2**
  - SW2 **E-3**

- SFC transitions**
    - forcing 13-2
  - SFCs 1-10**
  - shift register instructions D-20**
  - site preparation**
    - conductor categories 3-4
    - raceway layout 3-4
    - routing conductors 3-4
  - slave communication 10-3, 10-9**
  - spacing chassis 3-1**
  - Specification**
    - battery A-2
  - Specifications A-1**
  - specifications A-1**
  - standard communication 10-4**
  - startup 14-2**
  - status**
    - adaptermode channel 7-17
    - remote I/O 6-21
    - supervisory processor 7-18
  - status bits**
    - monitoring 15-13
  - status file**
    - processor B-1
    - size 4-13
  - status information**
    - main control program scan 16-5
    - PIIs 18-6
    - STIs 17-4
  - STI 15-11, C-3, C-4**
    - application example ladder logic 17-2
    - configuring 17-3
    - performance 17-2
    - program flow 13-10
    - program scan 17-4
    - status 17-4
    - using 17-1
    - when to use 13-11
    - with a blocktransfer instruction 17-2
    - writing ladder logic 17-1
  - storage**
    - program files 4-15
    - temperature 3-1
  - structure**
    - data storage 4-11
  - structured text 1-10**
  - subnet masks 11-11**
  - subroutines 1-10**
  - switch assemblies**
    - chassis E-4, E-5
    - chassis configuration plug E-6
    - extendedlocal I/O E-9
    - remote I/O
      - without complementary I/O E-7
    - SW1 E-2
    - SW2 E-3
  - switch assembly SW1**
    - defining the default DH+ address 9-3
  - switch setting**
    - reference E-1
  - symbol**
    - address 4-21
  - system**
    - design C-10, C-11
    - performance 16-2, C-1
  - system layout**
    - backpanel spacing 3-5
    - environment 3-1
  - system mode 10-2**
    - DF1 master 10-3
    - DF1 slave 10-3
    - pointtopoint 10-3
    - status 10-22
  - system specifications A-1**
- T**
- TCP/IP 11-32**
  - TCP/IP configuration 11-16**
  - terminating**
    - DH+ link 9-3
    - extendedlocal I/O link 8-2
    - remote I/O link 6-5
  - termination resistors 6-5, 9-3**
  - testing**
    - fault routines 15-11
  - throughput**
    - calculating C-5
    - I/O backplane transfer time C-6
    - I/O transfer time C-6
    - processor scan time C-11
    - remote I/O scan time C-6
  - timed driven interrupts 13-10**
  - timer instructions D-3**
  - timing**
    - bit and word instructions D-30
    - blocktransfer data 6-13, 8-6
    - calculating blocktransfer completion time 8-7, C-8
    - calculating throughput C-5
    - communication rate C-7
    - example C-12
    - false vs. true logic C-2

- file, program control, and ASCII instructions **D-38**
- global status flags file **C-5**
- housekeeping **C-4**
- input states **C-2**
- instructions **C-3**
- internal processing **9-15**
- nodes **9-13**
- optimizing for remote I/O **C-9**
- prescan **F-10**
- program scan **5-2, 5-3**
- to extended local I/O **8-5**
- using interrupts **C-3**
- token passing 9-13**
- transceivers G-9**
- troubleshooting**
  - communications **F-4**
  - Ethernet **F-5**
  - extended local I/O **F-5, F-9**
  - processor **F-2**
  - remote I/O **F-6**
- trunk line/drop line 6-5, 9-2**
- type**
  - data storage **4-11**

## U

### UID/UIE

- influencing processor priorities **13-14**
- STI **15-11, 17-3**

### understanding

- processor memory **4-10**

### user control bits

- processor status file **B-10**
- startup procedure **14-3**

### user interrupts 13-14

### user mode 10-2, 10-18

## W

### waiting

- program state **13-12**

### waiting queues 6-14

### watchdog timer 15-5

### Web Server 11-16

### words

- data storage **4-11**





# How Are We Doing?

Your comments on our technical publications will help us serve you better in the future. Thank you for taking the time to provide us feedback.

You can complete this form and mail (or fax) it back to us or email us at [RADocumentComments@ra.rockwell.com](mailto:RADocumentComments@ra.rockwell.com)

Pub. Title/Type Enhanced and Ethernet PLC-5 Programmable Controllers User Manual

Cat. No. 1785-L11B...-L86B Pub. No. 1785-UM012D-EN-P Pub. Date July 2005 Part No. 957782-07

Please complete the sections below. Where applicable, rank the feature (1=needs improvement, 2=satisfactory, and 3=outstanding).

<b>Overall Usefulness</b> 1    2    3	How can we make this publication more useful for you?		
<b>Completeness</b> (all necessary information is provided)    1    2    3	Can we add more information to help you?		
	procedure/step	illustration	feature
	example	guideline	other
	explanation	definition	
<b>Technical Accuracy</b> (all provided information is correct)    1    2    3	Can we be more accurate?		
	text	illustration	
<b>Clarity</b> (all provided information is easy to understand)    1    2    3	How can we make things clearer?		
<b>Other Comments</b>	You can add additional comments on the back of this form.		

Your Name \_\_\_\_\_  
 Your Title/Function \_\_\_\_\_  
 Location/Phone \_\_\_\_\_

Would you like us to contact you regarding your comments?  
 No, there is no need to contact me  
 Yes, please call me  
 Yes, please email me at \_\_\_\_\_  
 Yes, please contact me via \_\_\_\_\_

Return this form to: Rockwell Automation Technical Communications, 1 Allen-Bradley Dr., Mayfield Hts., OH 44124-9705  
 Fax: 440-646-3525    Email: [RADocumentComments@ra.rockwell.com](mailto:RADocumentComments@ra.rockwell.com)

PLEASE FASTEN HERE (DO NOT STAPLE)

Other Comments

PLEASE FOLD HERE

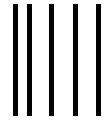

NO POSTAGE  
NECESSARY  
IF MAILED  
IN THE  
UNITED STATES

PLEASE REMOVE

**BUSINESS REPLY MAIL**

FIRST-CLASS MAIL PERMIT NO. 18235 CLEVELAND OH

POSTAGE WILL BE PAID BY THE ADDRESSEE



**Rockwell  
Automation**

**1 ALLEN-BRADLEY DR  
MAYFIELD HEIGHTS OH 44124-9705**

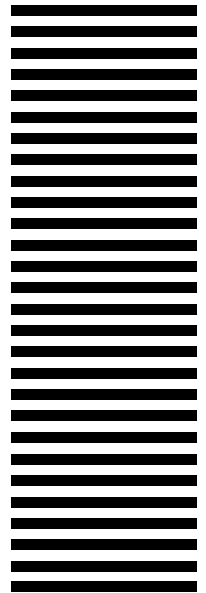









# Rockwell Automation Support

Rockwell Automation provides technical information on the web to assist you in using its products. At <http://support.rockwellautomation.com>, you can find technical manuals, a knowledge base of FAQs, technical and application notes, sample code and links to software service packs, and a MySupport feature that you can customize to make the best use of these tools.

For an additional level of technical phone support for installation, configuration and troubleshooting, we offer TechConnect Support programs. For more information, contact your local distributor or Rockwell Automation representative, or visit <http://support.rockwellautomation.com>.

## Installation Assistance

If you experience a problem with a hardware module within the first 24 hours of installation, please review the information that's contained in this manual. You can also contact a special Customer Support number for initial help in getting your module up and running:

United States	1.440.646.3223 Monday – Friday, 8am – 5pm EST
Outside United States	Please contact your local Rockwell Automation representative for any technical support issues.

## New Product Satisfaction Return

Rockwell tests all of its products to ensure that they are fully operational when shipped from the manufacturing facility. However, if your product is not functioning and needs to be returned:

United States	Contact your distributor. You must provide a Customer Support case number (see phone number above to obtain one) to your distributor in order to complete the return process.
Outside United States	Please contact your local Rockwell Automation representative for return procedure.

[www.rockwellautomation.com](http://www.rockwellautomation.com)

### Corporate Headquarters

Rockwell Automation, 777 East Wisconsin Avenue, Suite 1400, Milwaukee, WI, 53202-5302 USA, Tel: (1) 414.212.5200, Fax: (1) 414.212.5201

### Headquarters for Allen-Bradley Products, Rockwell Software Products and Global Manufacturing Solutions

Americas: Rockwell Automation, 1201 South Second Street, Milwaukee, WI 53204-2496 USA, Tel: (1) 414.382.2000, Fax: (1) 414.382.4444

Europe: Rockwell Automation SA/NV, Vorstlaan/Boulevard du Souverain 36-BP 3A/B, 1170 Brussels, Belgium, Tel: (32) 2 663 0600, Fax: (32) 2 663 0640

Asia Pacific: Rockwell Automation, 27/F Citicorp Centre, 18 Whitfield Road, Causeway Bay, Hong Kong, Tel: (852) 2887 4788, Fax: (852) 2508 1846

### Headquarters for Dodge and Reliance Electric Products

Americas: Rockwell Automation, 6040 Ponders Court, Greenville, SC 29615-4617 USA, Tel: (1) 864.297.4800, Fax: (1) 864.281.2433

Europe: Rockwell Automation, Brühlstraße 22, D-74834 Elztal-Dallau, Germany, Tel: (49) 6261 9410, Fax: (49) 6261 17741

Asia Pacific: Rockwell Automation, 55 Newton Road, #11-01/02 Revenue House, Singapore 307987, Tel: (65) 351 6723, Fax: (65) 355 1733