

Conrad Meier™

Fish Harvester

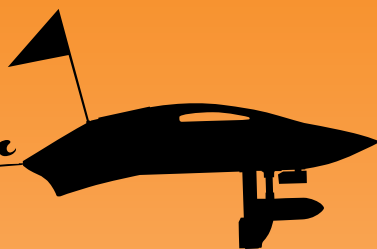

**Owner's
Manual**



Contents

Welcome	1
Why read this manual	1
Checklist	2
Support	2
Safety	3
Safety first!	3
Keep your distance from other fishers	3
Look out for the safety of others.	3
Keep yourself safe	4
Be safe around other vessels.	5
Legal requirements	6
Know what local rules apply	6
Limit traces and hooks to 25	6
Identify your equipment	6
Your kit	7
Conrad Meier Fish Harvester	7
Beach trolley	11
Assembly of beach trolley	12
Electric winch and main line	13
Trace rack	14
Remote control	14
Batteries and charger	14
Strobe light	15
Visibility flag	16
Setting up	17
Overview	17
Charging the batteries	17
Installing the batteries	17

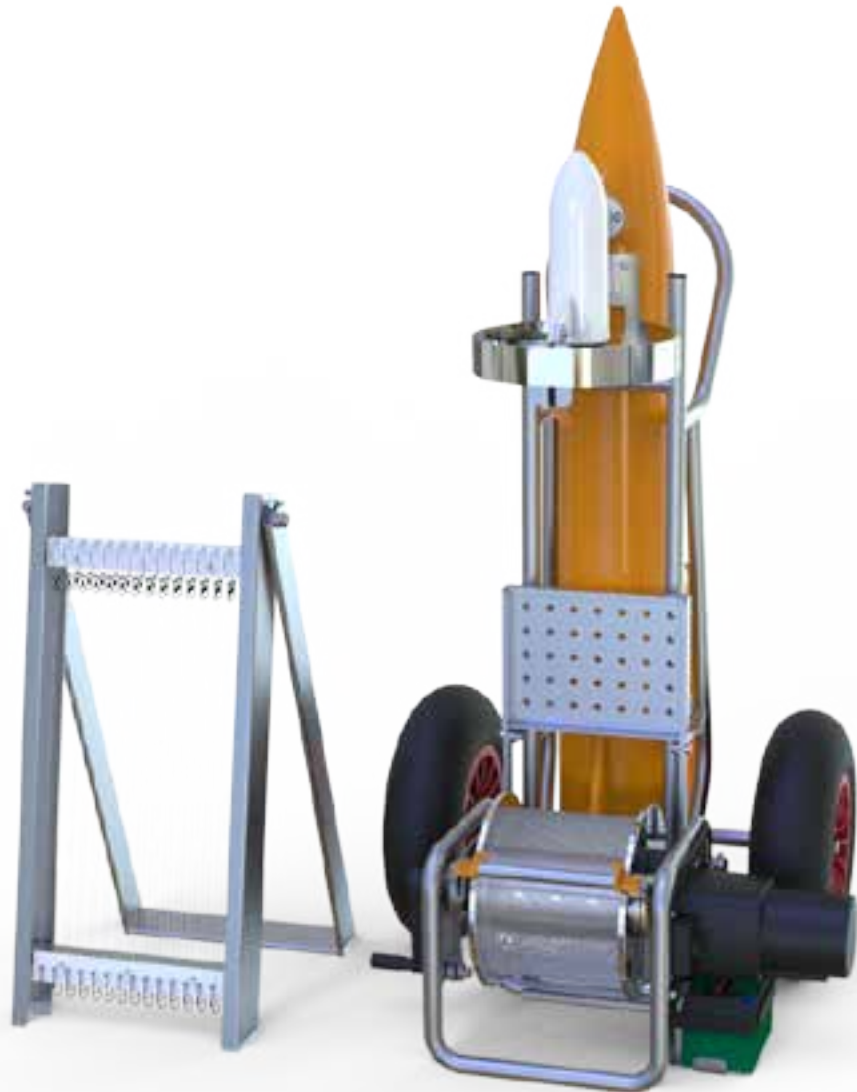

- Loading the beach trolley 20
- Using the Fish Harvester. 23**
 - Overview 23
 - Activating the remote control 23
 - Loading traces with bait. 24
 - Check before you launch 24
 - Launching the Conrad Meier Fish Harvester 25
 - Attaching traces and sinkers 26
 - Engaging the gear when the line is out 27
- Tips and troubleshooting 29**
 - Guiding the Conrad Meier Fish Harvester on the water 29
 - Positioning the hooks and sinkers. 30
 - Operating the winch. 30
 - Getting the best out of the batteries 31
- Looking after your kit 32**
 - Clean after every use 32
 - Check and replace 32
 - Waterproofing 32
- Two (2) Year Limited Replacement Warranty Statement. 34**

Welcome

Why read this manual

Fishing with the Conrad Meier Fish Harvester is not complex, but there are a few things you need to know to ensure you get maximum enjoyment from it, and that you comply with **International** maritime regulations.

Take the time to read this manual before you get to the beach, so you can maximise fishing time.

Please also read the maintenance section to avoid any unnecessary maintenance bills.



Checklist

Use the checklist below to make sure that you have everything you need in your Conrad Meier Fish Harvester kit.

- ✓ Conrad Meier Fish Harvester
- ✓ Remote control
- ✓ Beach trolley
- ✓ Electric winch
- ✓ Emergency winch handle
- ✓ Main line
- ✓ Trace rack
- ✓ Catch and trace rack carry bag
- ✓ Hooks and sinkers
- ✓ Strobe light
- ✓ Visibility flag
- ✓ 12V batteries x 3
- ✓ Battery charger
- ✓ Gloves

These items are described in detail in **Your kit** starting on page 7.

Support

If you experience problems with your equipment or its performance, please call **0800 002 999** or **1 800 200 3111** for assistance.

Safety

Safety first!

Your Conrad Meier Fish Harvester is an advanced fishing system. Your enjoyment will rely on observing a high level of personal safety as well as protecting the safety of others.

This section sets out important safety guidelines for operating your Conrad Meier Fish Harvester.

Keep your distance from other fishers

Keep clear of other beach users and fishers – whether surfcasters, kite fishers or others.

Safety guideline

- Keep a distance of at least 400 metres (¼ mile) between yourself and other beach users and fishers, and note the direction of the current.

Look out for the safety of others

Be considerate to other beach occupants at all times when using your Conrad Meier Fish Harvester. Watch out for:

- Children
- Onlookers and passers-by
- Animals (such as dogs, cats or seagulls)
- Swimmers and other water users
- Boats.

Follow the guidelines below to ensure the safety of others.

Safety guidelines

- Take extra care during launch time
- Warn other beach users of any dangers and make them aware of where your Conrad Meier Fish Harvester line is.
- Keep young children away from the Conrad Meier Fish Harvester.
- Never leave hooks unattended.
- Don't leave baited hooks lying around as animals may try to eat them.
- Keep baited hooks submerged with weights so seagulls can't reach them.
- Keep clear of swimmers and warn anyone swimming near your line.
- If anyone is helping you use the Conrad Meier Fish Harvester, warn them of the dangers.

Keep yourself safe

Follow the guidelines below to ensure your personal safety while operating the Conrad Meier Fish Harvester.

Safety guidelines

- Be aware of tides and currents, and where they may carry your Conrad Meier Fish Harvester.
- You will be exposed to the elements, so be prepared for the weather. Take sun protection or wet weather gear.
- Handle hooks with care. If a hook gets fouled, don't try to release it. Hooks only cost a few cents – trying to save one isn't worth the risk of a painful injury.
- Always disconnect the battery during transport or when it's not in use.

Be safe around other vessels

Follow the guidelines below to operate your Conrad Meier Fish Harvester safely around boats or other vessels.

Safety guidelines

- Always know where your Conrad Meier Fish Harvester is. Use binoculars if necessary.
- Make sure your line is weighted so that it can't be snagged by boats (see **Attaching traces and sinkers** on page 25).
- If the line gets snagged, or you need to stop the Conrad Meier Fish Harvester for any reason, press STOP on the remote.
- Always attach the strobe light to warn other vessels if you are fishing at dusk or at night.

Note: Using the strobe at night is mandatory, but we recommend you also attach it if you begin fishing late in the afternoon or in very dull, overcast conditions.

Legal requirements

Know what local rules apply

In some parts of New Zealand, longline fishing is restricted or even prohibited. Fishing limits also vary depending on the location.

Always find out what specific local regulations apply when you plan your fishing expedition.

Where to find fisheries information

Go to www.mpi.govt.nz, or contact the Ministry of Primary Industries on **0800 00 83 33**.

Limit traces and hooks to 25

The maximum number of hooks and traces allowed on a longline in **New Zealand is 25**.

The Conrad Meier Fish Harvester trace rack holds 28 traces. During normal use traces will get damaged, hence the rack holds 3 spare traces.

Identify your equipment

The Ministry of Fisheries requires all fishing equipment to be labelled with the owner's name and contact details.

Engrave your name and mobile phone number on your Conrad Meier Fish Harvester and all related equipment. Alternatively, use a waterproof marker.

Labelling your Conrad Meier Fish Harvester and equipment is a safeguard in the event of loss at sea, or if you leave something on the beach.

Your insurance company may also cover the Conrad Meier Fish Harvester as a recreational item against loss. We recommend you check the extent of cover with your insurer.



Your kit

Conrad Meier Fish Harvester

The hull

The Conrad Meier Fish Harvester hull design allows it to travel easily through the water, penetrating high waves and keeping a good line. It has excellent buoyancy, which increases running time on the surface and allows high visibility and remote control contact.

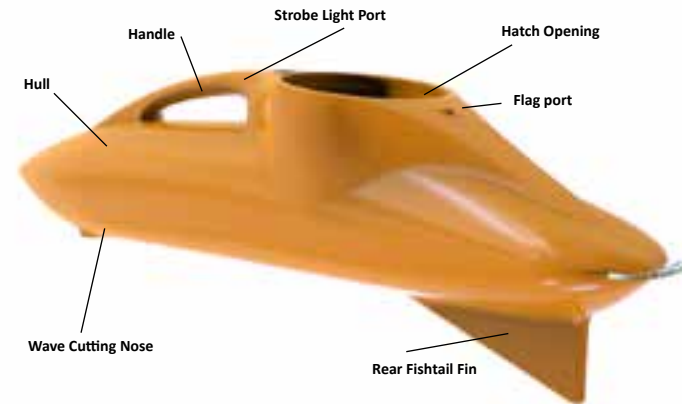

Main line tow plate

The main line tow plate is located at the rear of the hull. A series of holes allows you to choose the orientation of the main line.

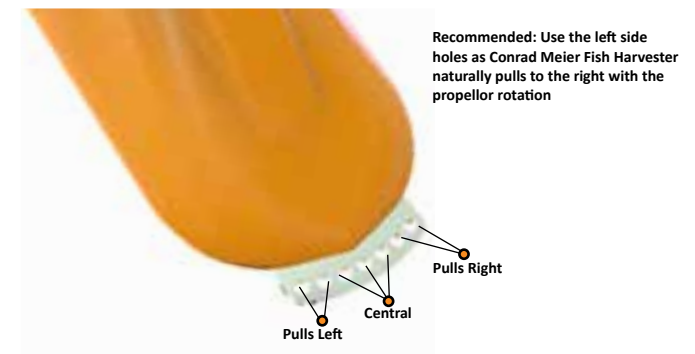

Tip: Clip the carabiner to the left side hole to compensate for the natural pull to the right created by the rotating propellor.

The hatch

The hatch gives access to the interior of the hull. Follow the instructions below to open and close the hatch.

Open the hatch by turning it counter-clockwise until the locking tabs disengage.

The hatch may then be removed.

Close the hatch by:

- Making sure the locking tabs, the seals, and the locking surfaces are all clear of obstructions (especially sand).
- Guiding the three locking tabs into the slots.
- Pushing down, and turning the hatch clockwise until the lock padlock lines up with the black dot on the hull. When the locking tabs engage, you'll feel a small bump.



Warning!

Ensure the hatch is secure – failure to do so may result in the battery compartment becoming flooded.

Operational components

The table below describes the Conrad Meier Fish Harvester's most important operational components.

Part and description	
<p>Motor</p> <p>A 14kg (30lbs) thrust single-speed motor propels the Conrad Meier Fish Harvester through the water. It is capable of reaching a distance of 2km (1 ¼ miles), and can get two runs at approximately 30 minutes on two 12V batteries (if fully charged).</p> <p>The control unit is able to shut down the propellor if it becomes obstructed.</p>	<p>Motor Shaft Pemserts 14kg (31lbs) Thrust Motor Stabilising Fin Propellor Blades Stainless Steel Propellor Guard</p>
<p>Servo and rudder</p> <p>The rudder steers the Conrad Meier Fish Harvester. The rudder shape is designed to minimise drag and increase steering capability.</p> <p>The servo is mounted with two bolts and water-proofed by a double O-ring protection system.</p>	<p>Servo Motor Servo Housing O-Ring Seals Rudder</p>

Warning!

Do not manually turn the rudder, as this can damage the servo gears.

Part and description (continued)

Battery box

The battery box protects the two 12V batteries and secures them in place.



Emergency winch handle

The emergency winch handle is initially located under the beach trolley's foldaway transport shelf. It is used in the event that the batteries run out or there is a problem with the motor.

To use the emergency winch handle:

- disengage the motor by pulling out the motor engage/disengage knob, then
- slot the emergency winch handle onto the shaft inside the motor engage/disengage knob.



Beach trolley

The beach trolley is a convenient way to carry all your Conrad Meier Fish Harvester equipment when you need to walk to the fishing area, particularly when walking in deep sand.

Note: You will need to assemble the trolley when it first arrives (see page 12).

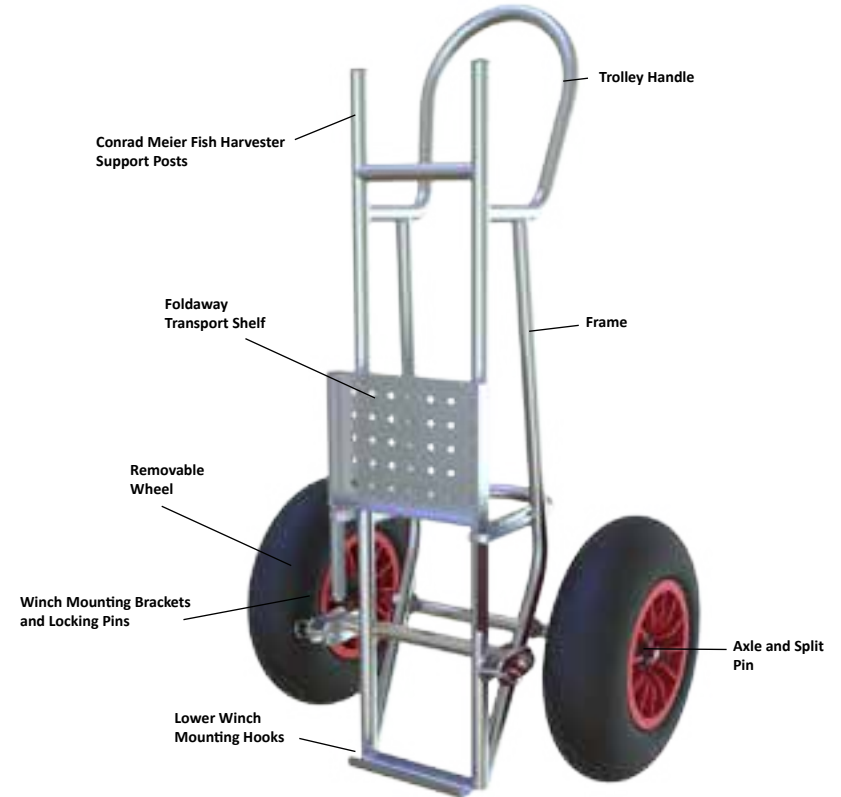

Easy transport

The beach trolley has mounting brackets and locking pins designed to house the electric winch. The winch weighs 25kg (55lbs) with the battery attached. We recommend you leave the winch mounted on the trolley for fishing. There is no need to un-mount it.

The beach trolley also has a foldaway transport shelf (capable of supporting up to 100kg (220lbs) for carrying your extra equipment.

Assembly of beach trolley

1.

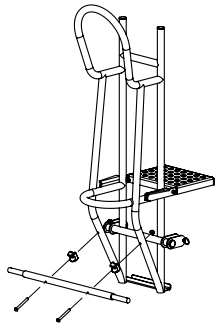

Secure axle in place using 2 x M8 screws, 2 x axle location clips & 2 x M8 nuts

2.

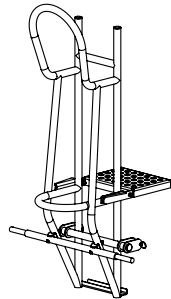

Axle mounted correctly, as pictured

3.

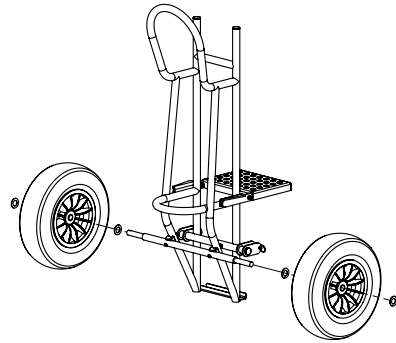

To fit wheels, slide 1 x washer, 1 x wheel & remaining washer onto axle. Repeat for opposite side

4.

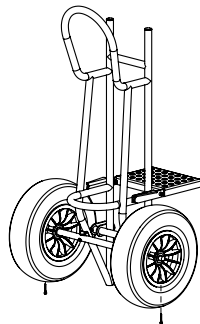

Lock in place using a split pin on each end of the axle

5.

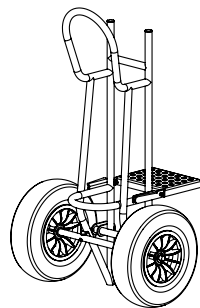

Completed trolley assembly

Electric winch and main line

Key features of the electric winch are listed below:

- 150W trawling motor with a weatherproof cover
- 12V battery secured by a wrap-around velcro strap
- Automatic line breaking system with a line guiding bar (over-spooling brake), designed to let the line out when the Conrad Meier Fish Harvester is travelling forward, and slow the drum when the line goes slack
- Overload and low battery automatic cutoff
- Replaceable brake pads
- Variable speed control (with variable speed selection and an emergency stop – see **Using the winch** on page 28)
- Easy push/pull motor engagement system
- Emergency winch handle.

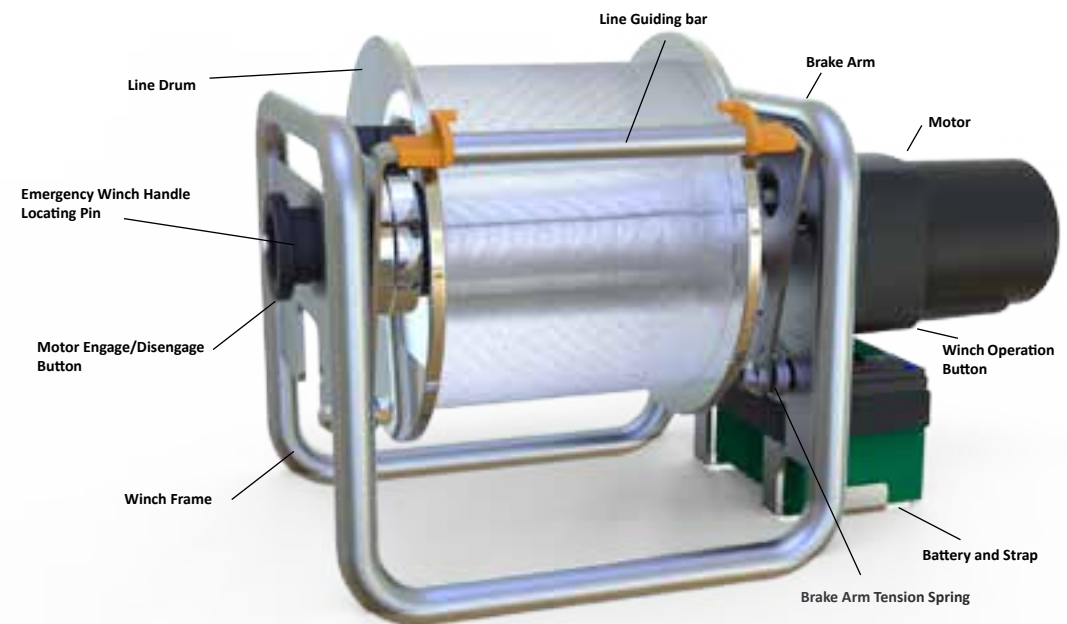

The main line

The line drum holds 2km (1 ¼ miles) of nylon main line, with a breaking strain of 80kg (176lbs). The main line has 100 stoppers.

- from the 150 metre (164 yards) to the 350 metre (382 yards) mark

Trace rack

The trace rack has:

- a main line guide bar, which keeps the outgoing main line directly above the traces for quick and easy clipping.

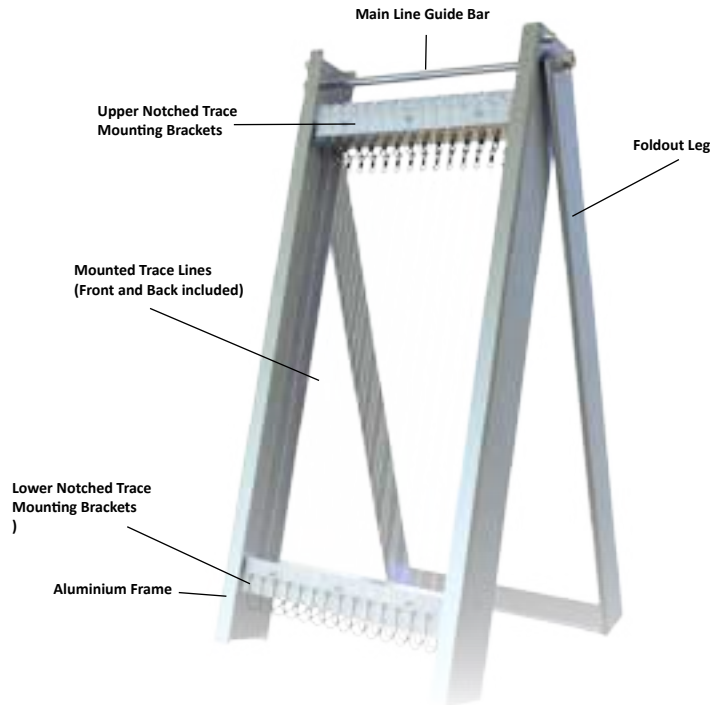

The trace rack holds up to 28 traces, which are mounted on two sides of the frame. See **Attaching traces and sinkers** on page 25 for more information about using the trace rack.

The trace rack carry and bag

The trace rack can be stored in its protective carry bag, which helps avoid tangling with other equipment during transport.

Note: Always fully open the carry bag when stowing or removing the trace rack.



Remote control

The remote control determines the movement and direction of the Conrad Meier Fish Harvester when it is out on the water. It has a range of up to 1000 metres ($\frac{3}{4}$ mile).

The remote control takes two AAA batteries.

See **Using the Conrad Meier Fish Harvester** on page 23 for more information about the remote control.



Batteries and charger

Your Conrad Meier Fish Harvester kit includes three 12V batteries and a battery charger. Two of the 12V batteries are for powering the Fish Harvester, and one is for powering the electric winch.

These batteries must be fully charged each time you use the Fish Harvester. See **Setting up** on page 17 for more information about charging and installing the batteries.

For tips about getting the most out of your batteries, see:

- **Tips and troubleshooting** on page 29, and
- **Looking after your kit** on page 32.

Strobe light

The strobe light is an important piece of safety equipment. It alerts you and other beach users to the position of the Conrad Meier Fish Harvester, especially in conditions of low visibility.

Note: The strobe light is light-sensitive, and will automatically turn on at night or in dull light.

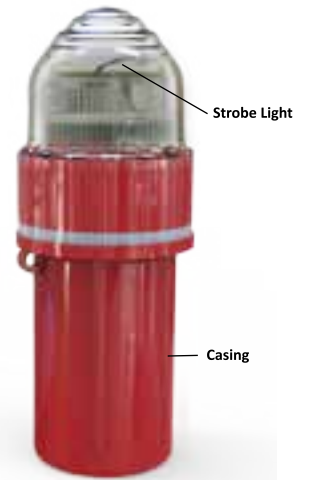

If you're fishing at night, you must use the strobe light. In dull, overcast conditions, or late in the afternoon, attaching the strobe light is also recommended.

The strobe light takes one D-size battery, which is included in the kit.

Note: Remove the battery when not in use.

Using the strobe light

Follow the instructions below to use the strobe light.

Step	Action
1	Unscrew the casing and insert D-size battery. Replace top and screw on firmly.
2	If operating properly, the light will flash at 1 second intervals.
3	Insert strobe light into the port provided at the top of the Conrad Meier Fish Harvester hull.

Visibility flag

Insert the flag into the small port located just behind the hatch on the Conrad Meier Fish Harvester hull.

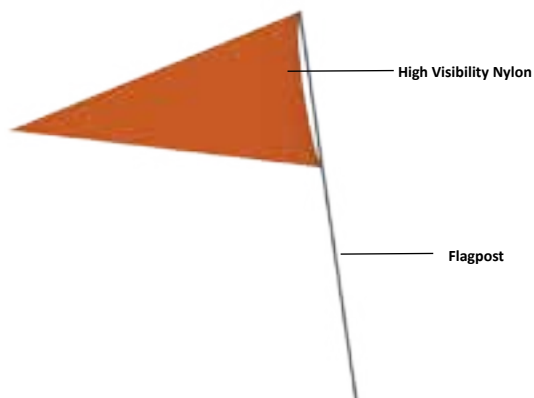

Note: Ensure it is fully inserted and will not come out easily.

Always insert the flag before launching the Conrad Meier Fish Harvester. When transporting or storing, the flag can be stowed inside the hull.

Setting up

Overview

Before you launch your Conrad Meier Fish Harvester, you'll need to set up the components of your kit. This process involves the following stages:

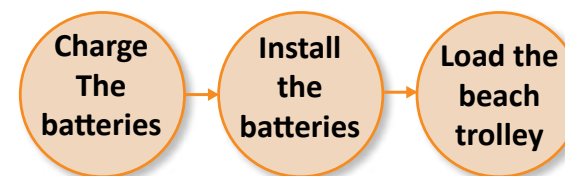

Charging the batteries

Your kit includes three rechargeable 12V batteries and a battery charger. Follow the steps below to charge them.

Step	Action
1	Plug in the charger and connect the 12V batteries. You can connect two batteries at a time. A constant red LED light indicates that the batteries are charging.
2	When the light turns from red to green, disconnect the batteries. The green light indicates that the batteries are finished charging. This will usually take 10 to 12 hours per battery.

Additional chargers are available for purchase (go to www.fishharvester.com).

Installing the batteries

Follow the instructions below to install the batteries for the Conrad Meier Fish Harvester and its associated equipment.

Installing the batteries for the remote control

The remote control takes two AAA batteries. Your remote will be shipped to you with batteries installed. If you need to replace them, simply open the battery case at the back of the remote control to install. Be careful not to damage the seal, or trap any dirt in the seal to ensure it remains water tight.

Installing the batteries for the Conrad Meier Fish Harvester

The Conrad Meier Fish Harvester takes two rechargeable 12V batteries (included in your kit). Follow the instructions below to install them.



Step	Action
1	Remove the hatch. Tips: <ul style="list-style-type: none">Remove the visibility flag to give yourself more room.Straddling and holding the hull between your legs is a good way to prevent it from tipping over.
2	Inside the Conrad Meier Fish Harvester, undo the strap and open the door to the battery box. <i>(new instructions to arrive)</i>
3	Insert the first battery into the open hatch in an upright position, with the terminals entering last. Warning! Grip the battery by the STRAP (not by the cables).

Step	Action Continued
4	Connect the terminals firmly and securely only prior to use.
5	Repeat steps 1 to 4 for the second battery.
6	Check that the Conrad Meier Fish Harvester is receiving control signals from the remote control.
7	If the battery power level and rudder are responding correctly, replace the battery box lid and strap the box closed.
8	Securely close and lock the Conrad Meier Fish Harvester hatch.

Installing the batteries for the electric winch

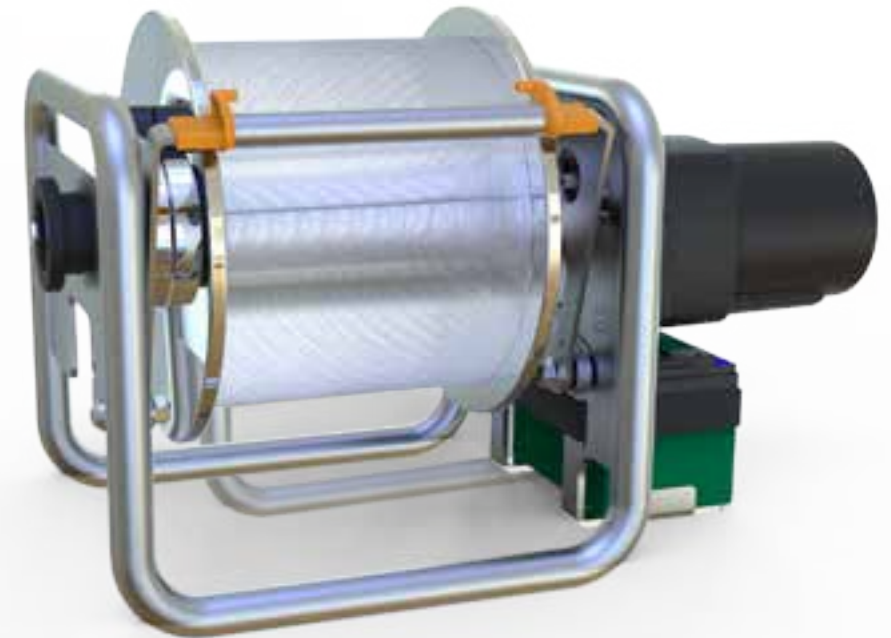

The electric winch takes one rechargeable 12V battery (included in your kit). Follow the instructions below to install it.

Step	Action
1	Undo the Velcro battery strap located beneath the winch motor.
2	Place the battery on the shelf located beneath the winch motor in an upright position. <div style="border: 1px solid black; background-color: #f4a460; border-radius: 15px; padding: 10px; margin: 10px 0;"> <p>Warning! Grip the battery by the plastic housing (not by the cables).</p> </div>
3	Connect the terminals firmly and securely only prior to use.
4	Secure the battery in place with the Velcro strap.
5	Test that the winch is operating properly (see Using the winch on page 28). Tip: If the winch is not working properly, check: <ul style="list-style-type: none"> • the terminal connections • the battery power level • that the motor is engaged (see Engaging the gear when the line is out on page 27).

Loading the beach trolley

Once the batteries have been charged and installed, follow the instructions below to mount the winch, the Conrad Meier Fish Harvester and other equipment onto the trolley.

Mounting the winch

The winch must be mounted onto the beach trolley first. Before you begin, ensure that the:

- winch brake arm is in the upright position
- the main line is fully wound in, and
- the end of the line is secured.

Follow the steps below to complete mounting the winch.

Step	Action
1	Align the back of the winch against the mounting bracket on the front of the beach trolley.
2	Lift the rear cross frame bar of the winch onto the mounting bracket of the beach trolley.
3	Remove the locking pins from the mounting bracket.
4	Slide the left and right frame bars of the winch into the locking brackets.
5	Fully insert the locking pins to secure the winch.

Mounting the Conrad Meier Fish Harvester

Before you begin, ensure that:

- the hatch is in the locked position, and
- the winch is mounted securely to the beach trolley.

Follow the steps below to complete mounting the Conrad Meier Fish Harvester.

Step	Action	
1	Stand to one side of the beach trolley. Hold the Conrad Meier Fish Harvester with the nose pointing straight up, and with the propellor and thrust motor facing towards the front of the beach trolley.	
2	Lift the Conrad Meier Fish Harvester straight up above the beach trolley and guide the bottom of the Fish Harvester through the centre of the trolley frame. When properly mounted, the propellor guard should come to rest on the top cross bar of the beach trolley, with its outside positioned between the two support posts.	

Mounting extra equipment

Follow the steps below to mount extra equipment on the beach trolley.

Step	Action
1	Fold down the transport shelf.
2	Neatly stack your extra equipment on the shelf.
3	Secure with straps or ties (not included in your kit).

Using the Conrad Meier Fish Harvester

Overview

When your equipment is set up, you'll be ready to use your Conrad Meier Fish Harvester. This process involves the following stages:

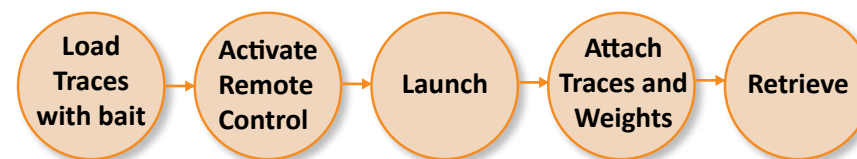

Warning!

Do not run the Conrad Meier Fish Harvester out of water.
Damage caused by doing so will void your warranty.

Activating the remote control

The Conrad Meier Fish Harvester is operated via a remote control. Before you launch, you'll need to activate it. Follow the instructions below to activate the remote control.

Step	Action
1	Press and hold the Start button.
2	The LED indicator will then display the Battery level of the Conrad Meier Fish Harvester batteries (not the remote) when the batteries are connected. The LED indicators then switch to TIME SET mode.
3	Use the left and right arrow buttons to select the required run time.
4	To deactivate and lock the remote, press and hold the STOP button for a few seconds. The remote will automatically lock and deactivate if no buttons are pushed for 30 minutes.



Note: The range of the remote is approximately 1000 metres (¾ mile).

Loading traces with bait

Put the trace rack in position and bait the hooks.

Note: Once the Conrad Meier Fish Harvester is launched, you'll have to work fast to clip the traces on the line, so it is important that the traces are ready for use.

Check before you launch

Before you launch the Conrad Meier Fish Harvester, go through the checklist below to ensure everything is ready.

- ✓ All batteries are charged and plug batteries in.
- ✓ The hatch is closed securely.
- ✓ The Fish Harvester is responsive to remote control commands.

- ✓ The main line is connected securely and clipped to desired steering hole.
- ✓ The motor engage/disengage knob is pulled out so that the winch motor is disengaged and able to spin freely and plug batteries in.
- ✓ The trace rack is in position and loaded with traces (baited hooks or sinkers).

Launching the Conrad Meier Fish Harvester

Follow the instructions below to launch the Conrad Meier Fish Harvester in the water.

Step	Action
1	Place the Conrad Meier Fish Harvester in water (at least knee deep level), pointed in the desired direction.
2	Make sure the line is clear and free from obstruction.
3	Press GO on the remote control to activate the motor. Two LEDs will light up to show the position of the rudder. Tips: <ul style="list-style-type: none"> • Change direction by pushing the LEFT or RIGHT arrows. • Stop the Conrad Meier Fish Harvester by pressing STOP. Pressing GO again will continue its original time setting and rudder position.

Launching the Conrad Meier Fish Harvester in strong currents

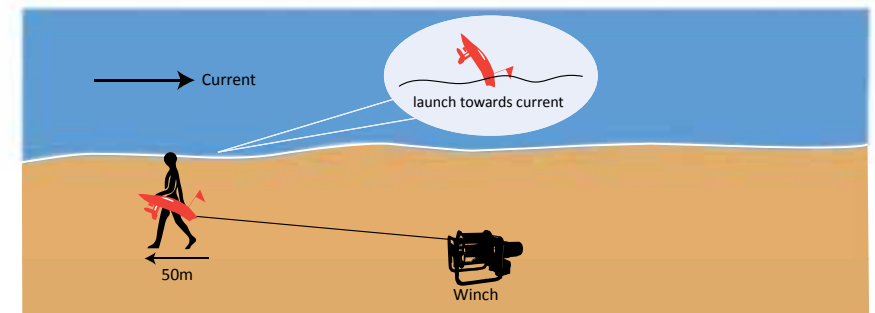

Dealing with strong currents and tricky conditions

- If the Conrad Meier Fish Harvester is driven off course by a strong current, walk Fish Harvester 50m up the beach into the current.
- Always launch pointing into the prevailing current, as more line is fed out the drag on the Conrad Meier Fish Harvester will increase.
- It may take you a few times to get the Conrad Meier Fish Harvester heading in the correct direction. First time users often need to relaunch the Fish Harvester a couple of times until they get the hang of the current.

Attaching traces and sinkers

After the first 150 metres (160 yards) of clear main line has gone out, the stoppered section of the main line will begin to unwind. The stoppers on this section are where you attach your traces (with either a baited hook or a sinker).

Note: The Conrad Meier Fish Harvester moves fast once launched. Do not stop the Fish Harvester while you're clipping on the traces. They will become entangled if you stop or slow down the speed.

Follow the steps below to attach traces and sinkers.

Step	Action
1	Position the trace rack underneath the outgoing line, so the main line rests on the trace rack's main line guiding bar.
2	When the first stopper passes over the rack, attach the first sinker.
3	Detach the first trace by the clip and snap it onto the main line.
4	Leave a gap (of between 2 and 4 stoppers) between each trace so the trace lines don't become entangled. Reminder: By New Zealand law, you're only allowed to clip up to 25 hooks to the main line.
5	When the first side of the trace rack is empty, you need to flip over the trace rack. To flip the trace rack: <ul style="list-style-type: none">• fold the forward trace frame back through the fold out leg, and• spin the rack 180 degrees to ready the second side of traces for attachment.

Step	Action
6	Attach another sinker after the last stopper.

Adjusting the course

When all the hooks and sinkers have been sent out, you can adjust the course of the Conrad Meier Fish Harvester using the remote control, if still in range (up to 1000 metres (¾ mile) in good conditions).

To stop the Conrad Meier Fish Harvester, press the STOP button on the remote control. When you press GO on the remote, the Fish Harvester will carry on with its original time setting and rudder position.

The Conrad Meier Fish Harvester will stop automatically when the designated time (set with the remote control before launch) has elapsed.

Engaging the gear when the line is out

Once the line has stopped, follow the instructions below to engage the gear. This stops the axle from free spooling further than you intended it to go.

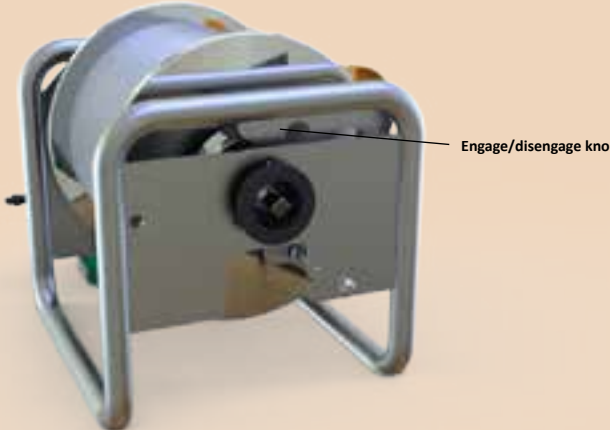
Step	Action
1	While rotating drum with hand push in the motor engage/disengage knob to engage the gear. 
2	This locks the axle ready to retrieve your fish.

Using the winch

When you are ready to retrieve the main line and the Conrad Meier Fish Harvester, follow the instructions below.

Note: If the Conrad Meier Fish Harvester is a long way down the beach, wheel the trolley closer to the Fish Harvester before you start the winch. This will avoid dragging the Fish Harvester through the sand and shallow water.

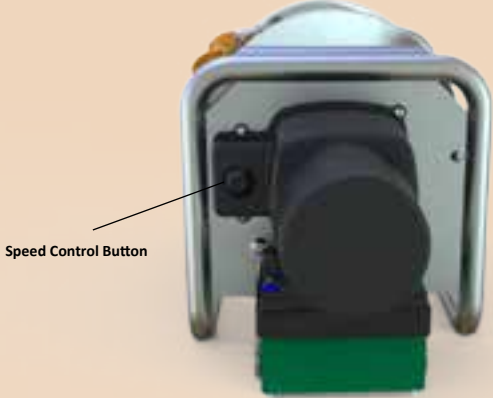
Step	Action
1	Check that the motor engage/disengage knob is pushed in. If not, push in the motor engage/disengage knob before starting the winch.
2	Press and hold the speed control button to start the winch.
	
3	To alter the speed while the winch is running: <ul style="list-style-type: none"> press and hold the speed control button to reduce speed. press and hold the speed control button again to increase speed.
4	To stop the winch press the speed control button once and release.
5	On restarting the winch, it will return to the speed it was last running at. Press and hold the speed control button to alter the speed as in step 3 above.
6	When you have retrieved the Conrad Meier Fish Harvester and the entire line, press the speed control button once to stop the winch.

Tips and troubleshooting

Guiding the Conrad Meier Fish Harvester on the water

Always operate the Conrad Meier Fish Harvester in water. Running the motor out of water will damage motor seal.

Warning!

Do not run the Conrad Meier Fish Harvester out of water.
Damage caused by doing so will void your warranty.

Launching

- Make sure you launch the Conrad Meier Fish Harvester in water that's deep enough for it to float without the propellor touching the bottom.
- Release it just after a wave has come through. This will allow it to steady itself on its course before the next wave arrives.



Remote control signals

- Big waves can disrupt the signal from the remote control, so try to time your transmissions as the Conrad Meier Fish Harvester comes into view between wave sets.
- If the Conrad Meier Fish Harvester is out of range, you will need to wait for the timer to stop it, then retract the machine and restart.

Positioning the hooks and sinkers

If you know the area well, you can target the spots you'd like to fish by adjusting the run time and the distribution of hooks and sinkers on the main line. You can experiment to find the optimum position of the hooks by:

- spreading out the hooks to cover a bigger area, or
- clustering the hooks close together to concentrate on a smaller area.

Using the Conrad Meier Fish Harvester is always better with a partner – one person can operate the remote control, and one can clip on the traces as the main line goes out.

Operating the winch

Keep an eye on the main line and spool when sending out or retrieving the Conrad Meier Fish Harvester, to avoid the possibility of tangles. In addition:

- Keep the emergency winch handle with you at all times.
- Avoid holding the line as it goes out. The outgoing Conrad Meier Fish Harvester will gradually increase the pressure on the line, and may rip it from your hands if held for too long.

As the main line travels out from the line drum, the line may creep with the current and pull the line to one side of the brake arm and guide bar. **Adjust the position of the beach trolley and winch** so that the line is spooling out from the centre of the line guide again. You'll probably need to do this a few times during fishing, and again before you winch the line back in.

Getting the best out of the batteries

Taking care of your batteries will ensure the high performance of the Conrad Meier Fish Harvester out on the water, as well as prolong their life.

Keep batteries rinsed and cleaned. Exposure to sea water will speed up the corrosion of the batteries.

Use the batteries and charger **supplied by Conrad Meier Fish Harvester**. Batteries from other manufacturers are unlikely to achieve the high level of performance needed (and using them will invalidate your warranty). Replacement batteries can be purchased (go to www.fishharvester.com).

Charging

Always:

- Fully charge the 12V batteries after using the Conrad Meier Fish Harvester and winch.
- Take care not to over-charge the battery.
- To charge the batteries, it is recommended that you remove them from the Conrad Meier Fish Harvester and charge in an open space (charging batteries in enclosed spaces can damage the battery, or cause it to explode)

Leave the batteries in a charged state. Get into the habit of charging the batteries at the end of each fishing trip so they maintain their capacity. Batteries will self-discharge approximately 5% each month. Storing batteries in a discharged condition will greatly reduce their useful life.



Looking after your kit

Clean after every use

To ensure that any sand, salt and other foreign matter is removed, clean all your equipment with fresh water **after every use**, including:

- the Conrad Meier Fish Harvester (including the motor, propellor, and rudder)
- the beach trolley
- the winch
- the battery terminals and connectors
- the trace rack, and
- anything that has come into contact with fish.

Pay particular attention to attachments and threading, especially around the hatch.

- Use a damp cloth to clean the remote control casing. **Do not** use soap or solvents, as this may affect the waterproof coating.
- When finished for the day, take the batteries out of the hull and leave the hatch open to the air to ensure all is dry.

Check and replace

Check the main line and traces periodically for weaknesses, damage or wear. Replace any sections that are seriously damaged.

We recommend that you replace the entire main line every 2 years.

After multiple uses, the clips on the traces can become loose. These can be tightened gently with pliers.

Waterproofing

Applying waterproof marine grease will ensure that electrical components are safe and secure from water damage. These parts include:

- **battery terminals and connectors**, and
- **threading in the hatch** and the **strobe light case**.

We recommend that you re-grease the servo unit **at least once a year**.

Notes

TWO (2) YEAR LIMITED REPLACEMENT WARRANTY STATEMENT

If your product (the “Product”) becomes defective due to faulty material or workmanship within a period of 2 years from the date of purchase, we warrant to do the following:

We will replace the Product with a new product, free of charge, or repair the product at our cost, at our discretion.

Your warranty is subject to the following conditions:

- **DO NOT** operate the Product with a damaged plug or cord, or if the unit has been dropped or damaged. To avoid the risk of electric shock, do not disassemble or attempt to repair the appliance on your own. If the supply cord is damaged, **it must be replaced by a qualified electrician in order to avoid a hazard**. Incorrect re-assembly or repair can cause a risk of electric shock or injury to persons when the appliance is used.
- The item has not been misused, abused, neglected, altered, modified or repaired by anyone.
- The item has been subjected to normal wear and tear.
- The item has not been used for trade, professional or hire purposes.
- The item has not sustained damage.

Your warranty does not cover;

- Components that are subject to natural wear and tear caused by normal use in accordance with operating instructions.
- Unauthorized or improper maintenance or handling or overload.
- Accessories that are supplied with this item.

This warranty applies only to the original purchaser and may not be transferred.

Replacement items will be covered by the limited warranty for the balance of the warranty period from the date of the original purchase.

For guarantee claims, you will need to submit a proof of purchase in the form of a valid receipt that displays date and place of purchase.

Please note: Only the defective product or parts returned to place of purchase will be replaced under this warranty.

Dispute Resolution:

In the unlikely event that you have a dispute with us regarding the Product

or this Limited Warranty, you agree that any claim or dispute in connection with the Product or this Limited Warranty shall be resolved in a cost effective manner through binding arbitration. The arbitration shall be instated through an established alternative dispute resolution provider mutually agreed upon by the parties.

If the foregoing arbitration clause does not apply for any reason, you agree to submit to the personal jurisdiction of the state courts located within San Diego County, California and the federal courts in the Southern District of California for the purpose of litigating all such claims or disputes, which courts shall have exclusive jurisdiction of such claims or disputes. Notwithstanding the foregoing, we may seek injunctive or other equitable relief to protect its intellectual property rights in any court of competent jurisdiction.

Contact: To receive this warranty, please contact customer care on the phone number below.

How State Law Applies: This warranty gives you specific legal rights, and you may also have other rights that vary from state to state.

This Limited Warranty shall be governed by the laws of the State of California without giving effect to any conflict of laws principles that may provide the application of the law of another jurisdiction.

United States Contact

Brand Developers USA, LLC
U2440 Clements Ferry Road
Charleston South Carolina,
29492, USA

USA Customer Care: 1-800-200-3111

Australia Contact

461 Plummer Street,
Port Melbourne, VIC 3207, AUSTRALIA
AUST Customer Care: 1800 890 840

New Zealand Contact

Unit H, 686 Rosebank Road,
Avondale, 1026 Auckland, NEW ZEALAND

This device complies with part 15 of the FCC rules. Operation is subject to the following two conditions: (1) This device may not cause harmful interference, and (2) this device must accept any interference received, including interference that may cause undesired operation.

NOTE: THE GRANTEE IS NOT RESPONSIBLE FOR ANY CHANGES OR MODIFICATIONS NOT EXPRESSLY APPROVED BY THE PARTY RESPONSIBLE FOR COMPLIANCE. SUCH MODIFICATIONS COULD VOID THE USER'S AUTHORITY TO OPERATE THE EQUIPMENT.

Conrad Meier™

Fish Harvester



Distributed by:

Brand Developers

Australia • New Zealand • United States

Brand Developers Aust Pty Ltd

461 Plummer Street,
Port Melbourne, VIC 3207, AUSTRALIA
AUST Customer Care: 1800 890 840

Brand Developers Limited

Unit H, 686 Rosebank Road,
Avondale, 1026 Auckland, NEW ZEALAND
NZ Customer Care: 0800 002 999

Brand Developers USA, LLC

U2440 Clements Ferry Road
Charleston South Carolina,
29492, USA
USA Customer Care: 1-800-200-3111

www.fishharvester.com

BDV3