

Operator's Manual for:

Series 04

L955 Consumer
Wheelchair Lifts



"Providing Access to the World"®

International Corporate Hdqrs: P.O. Box 310 Winamac, IN 46996 USA
1-800-THE LIFT (574) 946-6153 FAX: (574) 946-4670



27543-04

January 2003

Patent #5,261,779

Patent #5,806,632

Patents Pending

WARNING



Read manual before operating lift. Failure to do so may result in serious bodily injury and/or property damage. Keep manual in lift storage pouch.

Congratulations

We at The Braun Corporation wish to express our fullest appreciation on your new purchase. With you in mind, our skilled craftsmen have designed and assembled the finest lift available.

This manual includes safety precautions, lift operating instructions, manual operating instructions, and instructions for maintenance and lubrication procedures.

Your lift is built for dependability, and will bring you years of pleasure and independence, as long as maintenance is performed regularly and the lift is operated by an instructed person.

Sincerely,

THE BRAUN CORPORATION

A handwritten signature in black ink that reads "Ralph W. Braun". The signature is written in a cursive style with a large, sweeping "B" and "R".

Ralph W. Braun
Chief Executive Officer

Contents

Lift Terminology

Lift Terminology Illustration	2
Introduction	3
Direction	3
Lift Components	3-5
Lift Actions and Functions	5, 6

Lift Operation Safety

Safety Symbols	7
Lift Operation Safety Precautions	8-11

Pre-Lift Operation Notes and Details

General Safety	12, 13
Lift Control Switches	13, 14
Lift Features	
Bridge Plate	15
Automatic Floor Level Switching	15
Automatic Roll Stops	16-18

Roll Stop Latch	18
Latch Operation	18, 19
Bridging	19
Handrails	19
Lift Passengers	
Passenger Orientation (Boarding Direction) ...	20
Vehicle (Floor Level) Loading and Unloading	20
Wheelchair-equipped Occupant Seat Belts	21
Operation Procedure Review	21, 22
Preventive Maintenance	22, 23
Lift Operating Instructions	24-30
Manual Operating Instructions	31-33
Decals and Antiskid	34, 35
Maintenance and Lubrication	36, 37
Warranty and Registration Instructions	38, 39

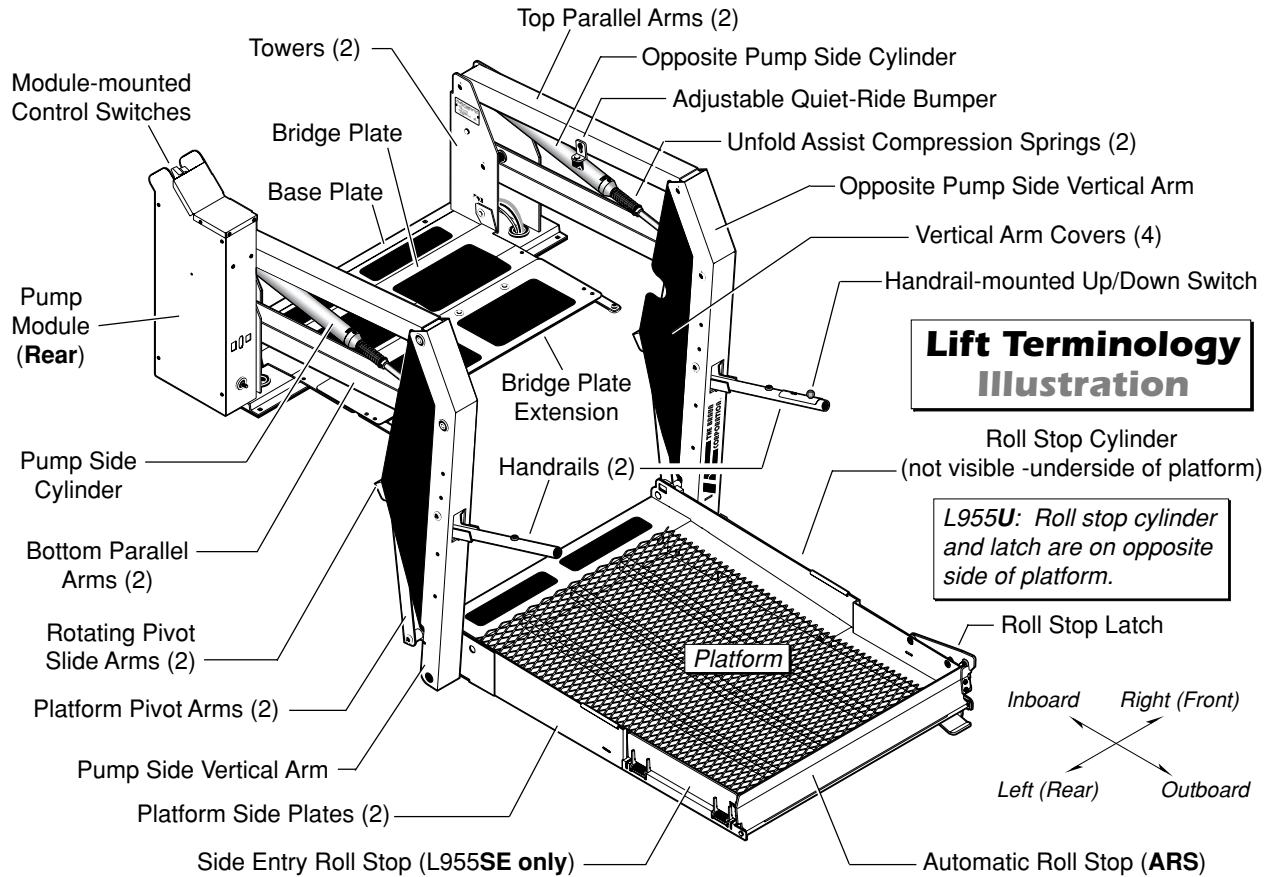

Lift Terminology

Introduction:

Braun L955 Millennium Series lifts are consumer oriented (designed to allow operation by the wheelchair passenger). L955 lift models provide fully automatic operation of all lift functions as well as optional automatic door operators (if so equipped).

The L955 Millennium Lift Series includes variations of L955SE and L955U lift models. Lift model numbers indicate platform/roll stop configuration and physical dimensions. A standard L955SE lift model is depicted in the Lift Terminology Illustration. The bridge plate extension is bolted to the bridge plate (as shipped). In stepwell applications where

additional platform length is required, the extension plate may be bolted to the heel (inboard end) of the platform.

Lift operation procedures are identical for all L955 Series lift models. The operating Instructions contained in this manual and appearing on lift-posted operating instructions decals address the lift control switches and the corresponding lift functions. Instructions are provided for manual operation of the lift in event of power or equipment failure.

Terminology: Become familiar with the terminology that will be used throughout this manual. Become familiar with the identification of lift components and their

functions. Contact your lift sales representative or call The Braun Corporation at 1-800-THE LIFT if any of this information is not fully understood.

Direction: The terms "left (rear)," "right (front)," "inboard," and "outboard" will be used throughout this manual to indicate direction (as viewed from outside the vehicle looking directly at the lift). Refer to the Lift Terminology Illustration for clarification of direction terms.

Lift Components

Refer to the Lift Terminology Illustration for identification of lift components.

Pump Module: The lift-mounted

Lift Terminology

pump module consists of the hydraulic pump, the manual hand pump and electrical components that power the lift electric/hydraulic systems.

Module-mounted Control

Switches: The pump module is equipped with three color-coded and function-labeled control switches (OPEN/CLOSE, IN/OUT and UP/DOWN). The switches activate the automatic lift functions and optional door operators. Further details are provided in the Lift Pre-Lift Operation section (page 13).

Lift Frame: The lift frame consists of the base plate, two towers, the parallel arms, the vertical arms, platform pivot arms and the handrails. The two main

hydraulic cylinders are housed in the parallel arms. The electrical/hydraulic powered lift frame components mechanically unfold, lower, raise and fold the lift platform assembly.

Bridge Plate: The bridge plate assembly consists of the bridge plate (striker back) and the bridge plate extension (flap). The hinged bridge plate assembly bridges the gap between the lift platform and the vehicle floor when the platform is positioned at floor level. **Note:** The bridge plate extension (flap) is bolted to the bridge plate (as shipped) in the Lift Terminology Illustration. In stepwell applications where additional platform length is required, the extension plate may be bolted to the heel (inboard end) of the platform.

Dual Handrails: Dual handrails are provided for wheelchair passenger use. The handrails automatically unfold to the deployed position when the platform unfolds and fold automatically to the stowed position when the platform folds. The passenger may choose to grip the handrails when on the lift platform (if applicable). **Note:** An additional UP/DOWN control switch is built into the right (front) handrail.

Platform Assembly: The lift platform assembly consists of the steel tubing frame with grating surface upon which the wheelchair is positioned, the outboard roll stop, roll stop latch, the side entry roll stop (**SE only**), and the hydraulic cylinder assembly that powers the outboard roll stop.

Lift Terminology

Automatic Roll Stop(s):

L955SE and L955U lift platforms are equipped with a cylinder-powered outboard roll stop that provides a ramp for wheelchair loading and unloading at ground level. L955SE platforms are equipped with an outboard roll stop and a side entry roll stop. The side entry roll stop is useful in tight parking situations by reducing wheelchair caster “turn-out” when boarding and exiting the platform. The two roll stops function together in unison.

Roll Stop Latch: The spring-loaded latch locks the outboard roll stop in the vertical position when the platform raises above ground level.

Manual Operation System: A manual backup hand pump is built into the pump module. The lift platform can be unfolded, lowered, raised and folded using the hand pump. Manual Operation Instructions are provided on pages 31-33.

Lift Actions and Functions

UNFOLD (Out) - Platform

Unfold: Unfold is the action of the platform rotating out and down from the fully-stowed (vertical) position to floor level (horizontal) position when the UNFOLD switch is pressed.

DOWN - Platform Lower: Down is the action of the platform lowering from floor level position to fully-lowered (ground level)

position when the DOWN switch is pressed.

DOWN - Roll Stop Unfold

(Deploy) - When the platform reaches the fully-lowered (ground) position and the DOWN switch is continued to be pressed, the outboard roll stop and the side entry roll stop rotate downward from vertical position to ramp position.

UP - Roll Stop Fold (Raise):

When the lift is fully lowered and the roll stops are in the ramp position, pressing the UP switch first rotates the roll stops upward from ramp position to vertical position.

UP - Platform Raise: Up is the action of the platform raising

Lift Terminology

from ground level to floor level (fully-raised) position when the UP switch is pressed.

FOLD (In) - Platform Fold: Fold is the action of the platform rotating up and in from the floor level (horizontal) position to fully-stowed (vertical) position when the FOLD switch is pressed.

Stowed Position: The lift is stowed when the lift platform has been fully raised and folded fully (vertical position).

Floor Level: Floor level is the position (height) the platform assembly reaches in order for the wheelchair passenger to enter and exit the vehicle (fully raised). The platform automatically stops at floor level when

unfolding from the stowed position and when raising from ground level.

Note: Further details regarding lift control switches and the corresponding lift functions are provided in the Pre-Lift Operation Notes and Details section.

Lift Operation Safety

Safety Symbols

SAFETY FIRST! Know That ...

A All information contained in this manual and supplements (if included), is provided for your safety. Familiarity with proper operation instructions as well as proper maintenance procedures are necessary to ensure safe, troublefree operation. Safety precautions are provided to identify potentially hazardous situations and provide instruction on how to avoid them.

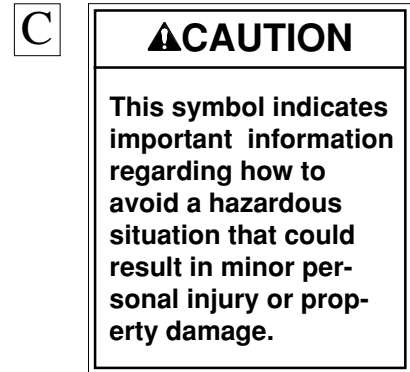
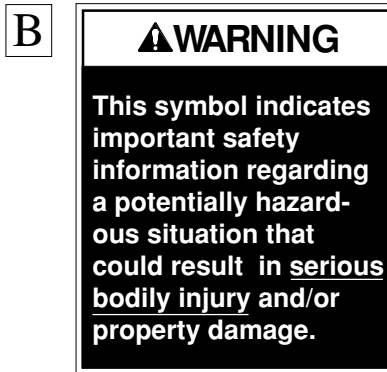

D **Note:** Additional information provided to help clarify or detail a specific subject.

These symbols will appear throughout this manual as well as on the labels posted on your lift. **Recognize the seriousness of this information.**

Lift Operation Safety

Lift Operation Safety Precautions

⚠️ WARNING

If the lift operating instructions, manual operating instructions and/or lift operation safety precautions are not fully understood, contact The Braun Corporation immediately. Failure to do so may result in serious bodily injury and/or property damage.

⚠️ WARNING Read manual and supplement(s) before operating lift. Read and become familiar with all safety precautions, pre-lift operation notes and details, operating instructions and manual operating instructions before operating the lift. **Note:** Wheelchair passengers and all transit agency personnel (drivers and wheelchair lift attendants) must read and become familiar with the contents of this manual and supplement(s) before operation.

⚠️ WARNING Load and unload on level surface only.

⚠️ WARNING Engage vehicle parking brake before operating lift.

⚠️ WARNING Provide adequate clearance outside the vehicle to accommodate the lift before opening lift door(s) or operating lift.

⚠️ WARNING Inspect lift before operation. Do not operate lift if you suspect lift damage, wear or any abnormal condition.

⚠️ WARNING Keep operator and bystanders clear of area in which the lift operates.

Lift Operation Safety

- ⚠️WARNING** Whenever a wheelchair passenger (or standee) is on the platform, the:
- Passenger must be positioned fully inside yellow boundaries
 - Wheelchair brakes must be locked
 - Roll stops must be up (vertical)
 - Roll stop latch must be fully engaged
 - Passenger should grip both handrails (if able).
- ⚠️WARNING** Load and unload clear of vehicular traffic.
- ⚠️WARNING** Do not overload or abuse. The load rating applies to both the raising and lowering functions - continuous lifting capacity is 800 lbs.
- ⚠️WARNING** Do not operate or board the lift if you or your lift operator are intoxicated.
- ⚠️WARNING** Do not raise front wheelchair wheels (pull wheelie) when loading (boarding) the platform.
- ⚠️WARNING** Open lift door(s) fully and secure before operating lift.
- ⚠️WARNING** Position and secure (buckle, engage, fasten, etc.) the wheelchair-equipped occupant seat belt (torso restraint) before loading onto the wheelchair lift platform.
- ⚠️WARNING** Lift attendants must ensure that lift occupants keep hands, arms and all other body parts within the lift occupant area and clear of moving parts.

Lift Operation Safety

Lift Operation Safety Precautions

⚠️ WARNING

If the lift operating instructions, manual operating instructions and/or lift operation safety precautions are not fully understood, contact The Braun Corporation immediately. Failure to do so may result in serious bodily injury and/or property damage.

⚠️ WARNING Platform must be positioned at floor level (bridge plate height) when loading or unloading in and out of vehicle.

⚠️ WARNING Do not use platform roll stops as a barrier (brake). Stop and brake wheelchair when loading onto the platform (manually stop and brake manual wheelchairs — stop powered wheelchairs with the wheelchair controls).

⚠️ WARNING Turn powered (electric) wheelchairs off when on lift platform.

⚠️ WARNING Press the DOWN switch until the entire platform rests on ground level (lowered fully) and the outboard roll stop is fully unfolded (ramp position) before loading or unloading a passenger at ground level.

⚠️ WARNING Outboard platform roll stops must be fully unfolded (ramp position) until the entire wheelchair crosses roll stops when loading or unloading at ground level.

⚠️ WARNING Accidental activation of control switch(es) may cause unintended operation(s).

Lift Operation Safety

- ⚠WARNING** Maintenance and lubrication procedures must be performed as specified in this manual by authorized (certified) service personnel.
- ⚠WARNING** Replace missing, worn or illegible decals.
- ⚠WARNING** Keep this operator's manual in lift-mounted manual storage pouch when not in use.
- ⚠WARNING** Never modify (alter) a Braun Corporation lift.
- ⚠WARNING** Do not use accessory devices not authorized by The Braun Corporation.
- ⚠WARNING** Do not remove any guards or covers.
- ⚠WARNING** Keep clear of any hydraulic leak.
- ⚠WARNING** Failure to follow these safety precautions may result in serious bodily injury and/or property damage.

Pre-Lift Operation Notes and Details

WARNING

Read and become familiar with all lift operation safety precautions, pre-lift operation notes and details, operating instructions and manual operating instructions prior to operating the lift. If this information is not fully understood, contact The Braun Corporation immediately. Failure to do so may result in serious bodily injury and/or property damage.

Braun L955 Millennium Series lifts are consumer oriented (designed to allow operation by the wheelchair passenger). L955 Series lifts are typically installed in vehicles equipped with fully-automatic door operators. The L955 provides fully automatic operation of all lift functions as well as optional automatic door operators (if so equipped).

Note: An attendant must manually open and close lift door(s) in applications where power door operator(s) are not provided.

It is the responsibility of the lift operator (attendant and/or wheelchair passenger) to properly activate all power (lift and door) functions.

Read and become familiar with all lift operation safety precautions, pre-lift operation notes and details, lift

operating instructions and manual operating instructions before attempting lift operating procedures.

Become familiar with all lift features and the proper operation of the lift components **before** attempting lift operation. Refer to the Lift Terminology section for identification of and description of lift components.

Contact The Braun Corporation immediately if any of this information is not fully understood. Call 1-800-THE LIFT.

General Safety: Before operating the lift, always engage the vehicle transmission in Park “P” and engage the vehicle parking brake. Lift operators (attendants), wheelchair passengers and bystanders must keep clear of the area in which the power doors (if equipped), and the lift

Pre-Lift Operation Notes and Details

operates (clear of all moving parts). The lift occupant (passenger) must keep hands, arms and all other body parts within the lift

occupant area and clear of moving parts. Follow all lift operation and wheelchair passenger information detailed in this manual.

Control Switches

Pump Module Control Switches: The lift-mounted

 WARNING
<p>Discontinue lift use immediately if any lift component does not operate properly. Failure to do so may result in serious bodily injury and/or property damage.</p>

control switches are color-coded and function-labeled to correspond to the color coding and switch-function labels that appear on the lift operating instructions decal. Triangular-shaped color-coded symbols (▲) appear on the lift operating instructions decal. The color of the symbol corresponds to the color of the switch to be used. The direction (point) of the symbol corresponds with the direction the switch should be activated (pressed) to produce the intended lift function.

Press switches **upward** for these functions:

Door(s)	Platform	
CLOSE	IN (Fold)	UP
▲ Yellow	▲ Orange	▲ Red



▼ Yellow	▼ Orange	▼ Red
OPEN	OUT (Unfold)	DOWN
Door(s)	Platform	

Press switches **downward** for these functions:

Pre-Lift Operation Notes and Details

Control Switches (continued)

Handrail UP/DOWN Switch: A spring-loaded horizontal-slide style switch is built in the right (front) handrail. The handrail UP/DOWN switch activates the platform and the roll stops (same as pump-mounted UP/DOWN switch). Slide the switch knob out

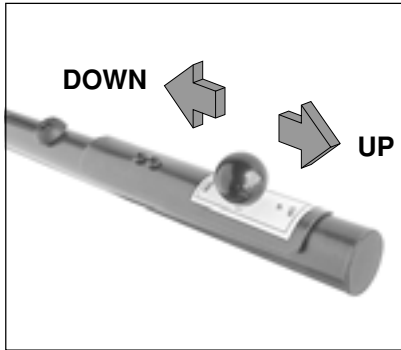

to the UP position to raise the platform. Slide the knob in to the DOWN position to lower the platform.

Auxiliary Control Switches: A six-touch remote control system, a third station control, a hand-held control and an outside control station are available as **options**. All auxiliary controls activate lift functions and automatic door operators except the hand-held control. The hand-held control activates lift functions only.

Do not press lift-mounted switches and auxiliary control station switches at the same time. Do not attempt to interface after-market control systems.

Braun Corporation After-market Control Systems Policy:

The Braun Corporation manufactures dedicated control systems for its products. These control systems have been designed and tested for use in conjunction with specific Braun products. Braun control systems are the **only** control systems authorized for use with Braun products.

Do not attempt to interface aftermarket control systems with Braun products. **To do so may result in serious bodily injury and/or property damage.**

Pre-Lift Operation Notes and Details

Lift Features

Bridge Plate: The hinged bridge plate assembly bridges the gap between the lift platform and the vehicle floor when the platform is positioned at floor level. The bridge plate assembly consists of the bridge plate and the bridge plate extension.

Fully-Unfolded (horizontal)
Bridge Plate (bridging position)

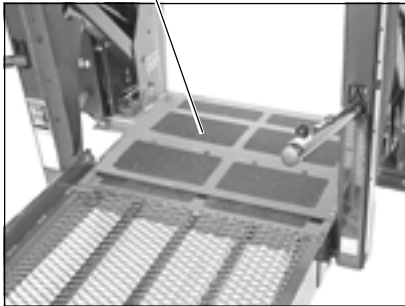

Typically, the bridge plate extension is bolted to the bridge plate as shown in the Lift Terminology Illustration (standard bridge plate configuration). In stepwell applications where additional platform length is required, the extension plate may be bolted to the heel (inboard end) of the platform.

When the OUT (Unfold) switch is pressed and the platform unfolds from stow position to floor level, the bridge plate is automatically deployed to the bridging (horizontal) position. When the IN (Fold) switch is pressed and the platform folds from deployed (horizontal) position to stowed position, the

bridge plate folds (rotates) to the vertical position.

The outboard edge of the bridge plate extension rests on the lift platform (standard bridge plate configuration). When the extension plate is bolted to the heel of the platform, the bridge plate rests on the extension plate.

Automatic Floor Level Switching: When the platform unfolds from the stowed position, the platform stops automatically at floor level when fully unfolded. When raising the platform from ground level, the platform automatically stops at floor level when raised fully.

Pre-Lift Operation Notes and Details

Lift Features (continued)

Although the L955 features automatic floor level switching, the lift operator (wheelchair passenger or attendant), **must view** the platform to **be certain** the platform is properly positioned at vehicle floor level and

WARNING

Discontinue lift use immediately if any lift component does not operate properly. Failure to do so may result in serious bodily injury and/or property damage.

the bridge plate is properly positioned when a passenger is entering or exiting the vehicle. If the lift platform does not automatically stop at floor level as outlined, **discontinue lift operation immediately.**

Automatic Roll Stops: The L955SE platform is equipped with an outboard roll stop and a side entry roll stop (L955U lift models are not equipped with a side entry roll stop). See photos A, B and C. Both cylinder-powered roll stops provide a ramp for wheelchair loading and unloading at ground level. The side entry roll stop is useful in tight parking situations by reducing wheelchair caster “turn-out”

when boarding and exiting the platform. The two roll stops function in unison. Details follow. **Discontinue lift operation immediately if either roll stop does not operate properly.**

Belt-operated Side Entry Roll Stop
(L955SE models only)

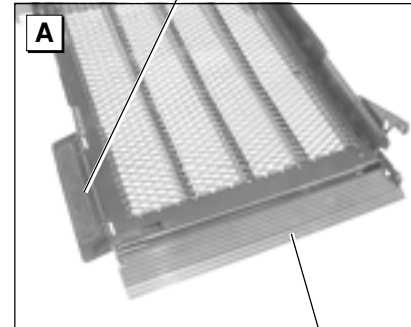

Aluminum Extruded Outboard Roll Stop

Pre-Lift Operation Notes and Details

Outboard Roll Stop: When the platform lowers fully to ground level, the roll stop cylinder compression spring automatically unfolds (rotates) the roll stop to the ramp position (fully unfolded). See photos A and B. Although the outboard roll stop is lift-powered, the activation of

the roll stop is controlled by the lift operator. Activating either DOWN switch unfolds the roll stop. The roll stop is cylinder-powered to automatically fold (rotate) to the vertical position when the UP switch is activated (roll stop raises before platform raises).

Side Entry Roll Stop: When the platform lowers fully to ground level, the spring-loaded side entry roll stop unfolds (rotates) to the ramp position simultaneously with the outboard roll stop (when DOWN switch is activated). See photos A and B. The belt and chain

Fully-Unfolded (Ramp position) Roll Stops

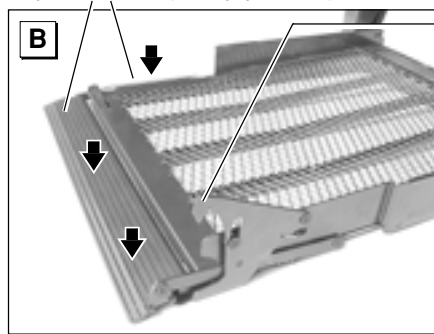

**Disengaged
Roll Stop
Latch**

**Fully-Folded
(Up-vertical)
Roll Stops**

L955U: The roll stop latch is on opposite side of the platform.

Note: The platform must raise approximately two inches before the latch engages fully.

Fully-Engaged Roll Stop Latch

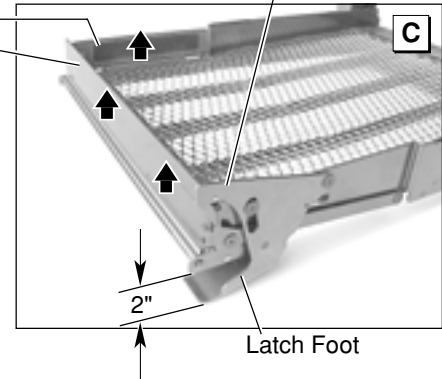

Pre-Lift Operation Notes and Details

Lift Features (continued)

driven roll stop is powered by the roll stop cylinder to automatically fold (rotate) to the vertical position when the UP switch is activated.

⚠ WARNING

Discontinue lift use immediately if any lift component does not operate properly. Failure to do so may result in serious bodily injury and/or property damage.

Roll Stop Latch: A spring-loaded latch engages the outboard roll stop when the roll stop rotates upward from ramp position to the vertical position (UP switch is activated to raise the platform above ground level).

Note: The platform must raise approximately two inches **before** the latch engages **fully** (see photo C on 17). L955U: The roll stop latch and roll stop cylinder are on the opposite (left) side of platform.

The latch disengages the roll stop when the platform lowers fully (reaches ground level) and the latch foot contacts the ground (latch raises above the

roll stop).

Outboard Roll Stop and Roll Stop Latch Operation: The lift



The lift operator or attendant must **be certain the entire platform** reaches and rests safely on the ground.

Pre-Lift Operation Notes and Details

operator must activate the DOWN switch to lower the platform fully to the ground. The lift operator or attendant **must view** the platform as it lowers to **be certain the entire platform** reaches and rests safely on the ground. Stop activating the DOWN switch if any portion of the platform is obstructed while descending or the platform does not reach ground level **for any reason** (contact with an obstruction, mechanical failure, exceeding the lift “floor-to-ground” capacity, etc.).

After the platform is fully lowered (platform reaches the ground), the lift operator should continue to press the DOWN switch to

unfold the outboard roll stop and the side entry roll stop **fully** (ramp position). **Note:** The roll stops **must be fully unfolded** until the entire wheelchair has crossed the roll stops when loading or unloading at ground level. **Discontinue lift operation immediately if the roll stops or latch do not operate properly.**

Bridging: The L955SE incorporates a bridging feature. This feature stops the down travel of the platform if the outboard end of the platform contacts a raised surface (such as a curb), preventing the operator from lowering the inboard end of the platform.

Handrails: Dual handrails are provided for wheelchair passenger (or standee) use. The handrails automatically unfold to the deployed position when the platform unfolds and fold automatically to the stowed position when the platform folds. The passenger may choose to grip the handrails when on the lift platform (if applicable).

Note: The right (front) handrail is equipped with an UP/DOWN control switch (details in Control Switches section). **Discontinue lift operation immediately if the handrails do not operate properly.**

Pre-Lift Operation Notes and Details

Lift Passengers

Do not attempt to load or unload a passenger in a wheelchair or other apparatus that does not fit on the platform area. Do not exceed the 800 pound load capacity of the lift.

Passenger Orientation (Boarding Direction): The wheelchair passenger **must face outward** whenever on the platform.

The passenger must be positioned in the **center of the platform** to prevent side-to-side load imbalance. Other persons should **not** ride on the platform with the wheelchair passenger.

The wheelchair **brakes must be locked**, the roll stops must be in

the **fully-up** (vertical) position and the outboard roll stop latch must be **fully engaged whenever a wheelchair passenger is on the platform**.

Do not use the outboard roll stop as a barrier (brake). Stop and brake the wheelchair when fully loaded on the platform. Manually stop and brake manual wheelchairs. Stop powered wheelchairs with the wheelchair controls. Turn powered (electric) wheelchairs off when on the platform.

Vehicle (Floor Level) Loading and Unloading: The platform **must be fully raised** (at floor level) and the bridge plate must be properly positioned when loading or unloading a passenger

in or out of the vehicle. Although the L955 features automatic floor level switching, **it is the responsibility of the lift operator to ensure the platform and the bridge plate are properly positioned at floor level when loading and unloading passengers.**

If the roll stops, bridge plate, handrails or any other lift component does not operate as outlined in this manual, **discontinue lift use immediately** and contact your sales representative or call The Braun Corporation at 1-800-THE LIFT. One of our national Product Support representatives will direct you to an authorized service technician who will inspect your lift.

Pre-Lift Operation Notes and Details

Wheelchair-Equipped Occupant Seat Belts

The Braun Corporation recommends wheelchair passengers position and buckle their wheel-

chair-equipped seat belt (torso restraint) as specified by the manufacture **before** loading onto a wheelchair lift.

WARNING

Position and secure (buckle, engage, fasten, etc.) the wheelchair-equipped occupant seat belt before loading onto the wheelchair lift platform. Failure to do so may result in serious bodily injury and/or property damage.

Different types of disabilities require different types of wheelchairs and different types of wheelchair-equipped occupant restraint belt systems (torso restraint). It is the responsibility of the wheelchair passenger to have his or her wheelchair equipped with an occupant restraint (seat belt) under the direction of their health care professional.

Wheelchair lift attendants should be instructed on any special

needs and/or procedures required for safe transport of wheelchair passengers.

Operation Procedure Review

The Braun Corporation recommends that the wheelchair lift user and/or attendant review the safety precautions and operation procedures appearing in this manual and on lift-posted decals with your wheelchair lift sales representative, **before** attempting lift operation. Any questions or concerns can be answered by your sales representative at that time.

Using your own wheelchair, operate the lift through all functions and enter and exit the

Pre-Lift Operation Notes and Details

vehicle with the sales representative on hand to ensure the lift is right for you as the end user (applicable for your use based on your physical abilities and the physical characteristics of your personal wheelchair). Become familiar with the proper operation of your lift before operating the lift by yourself.

This lift operator's **manual must be stored in the lift-mounted manual storage pouch when not in use.**

Preventive Maintenance

Maintenance is necessary to ensure safe and trouble-free lift operation. Preventive lift maintenance consisting of **careful** inspections of your lift system and cleaning the lift should be a part of your routine. Simple inspections can detect potential lift operational problems.

Regular preventive maintenance will reduce potential lift operation downtime and increase the service life of the lift, as well as enhancing safety.

During routine inspections, operate the lift through a minimum of one complete cycle and note the following:

- Do the automatic door(s) open fully (if equipped)?
- Does the lift safely clear the door(s) when unfolding and folding?
- Do the lift control switches function properly?
- Do the automatic roll stops operate properly?
- Does the roll stop latch operate properly?
- Do the handrails function properly?
- Is the power source adequate or weak?

Exposure to harsh weather elements, environment conditions, or heavy usage, etc. may require more frequent maintenance.

Pre-Lift Operation Notes and Details

nance and lubrication procedures.

Preventive maintenance visual inspections **do not** take the

place of the procedures specified in the Maintenance and Lubrication Schedule provided in the applicable lift installation and service manual. Refer to the Maintenance and Lubrication section in this manual for further details.

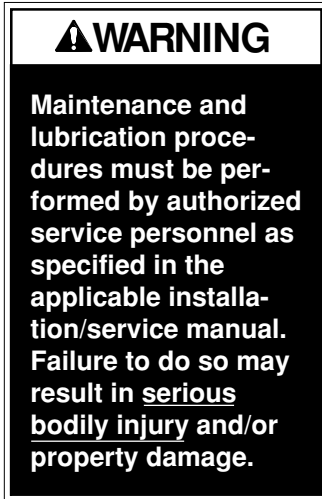

Lift Operating Instructions

⚠️ WARNING

Read and become familiar with all lift operation safety precautions, pre-lift operation notes and details, operating instructions and manual operating instructions prior to operating the lift. If this information is not fully understood, contact The Braun Corporation immediately. Failure to do so may result in serious bodily injury and/or property damage.

⚠️ WARNING

Whenever a passenger is on the platform, the:

- Passenger must face outward
- Wheelchair brakes must be locked
- Roll stops must be UP

Failure to do so may result in serious bodily injury and/or property damage.

Before lift operation, park the vehicle on a level surface, away from vehicular traffic. Place the vehicle transmission in “Park” and engage the parking brake.

Photos appearing in the Lift Operating Instructions depict lift functions being activated by lift-mounted control switches only.

Lift-posted Warnings and Lift Operating Instructions decal 24069 provides lift operating instructions. Replace any missing, worn or illegible decals.

Follow the Manual Operating Instructions provided on pages 31-33 in event of power or equipment failure.

Lift Operating Instructions

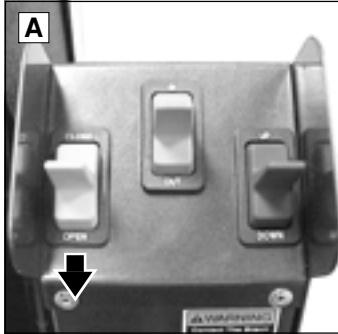

To Open Door(s):

Automatic Door Operator(s):

- ◀ Press yellow OPEN switch until door(s) are **fully open**. Release switch.

Manual Door(s):

Manually open door(s) **fully** and secure.

To Unfold Platform (Out):

- ◀ Press orange OUT switch until platform **stops** (unfolds fully – reaches floor level). Release switch. ▶

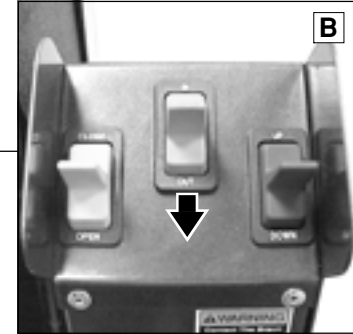

Lift Operating Instructions



To Unload Passenger:

- ▶ 1. **Read notes below!** Load passenger onto platform **facing outward** and **lock** wheelchair brakes.

- ▶ **Note:** Roll stops **must** be UP and roll stop latch **must** be fully engaged **before** loading passenger onto platform. **Lower head** to clear vehicle door jamb header.

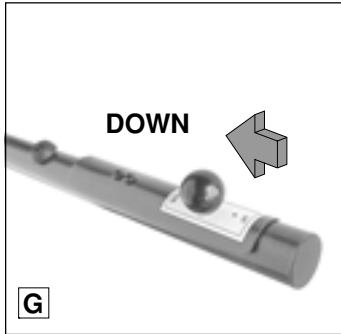
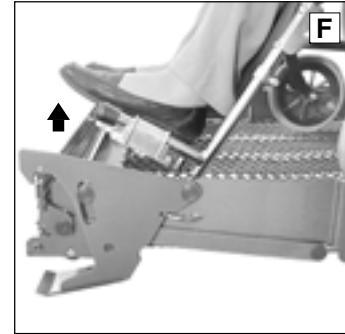

- ▶ 2. Press red DOWN switch until the **entire** platform reaches ground level (stops) and roll stop unfolds **fully** (see Photos H and I). Release switch.

- ▶ Handrail Switch: Slide knob in to DOWN position. See Photo G.



Lift Operating Instructions



To Unload Passenger: (continued)

3. Unlock wheelchair brakes and unload passenger from platform. ▶

Note: Roll stops **must** be **fully unfolded** (ramp position) until the entire wheelchair has crossed the roll stop. See Photos K and L.

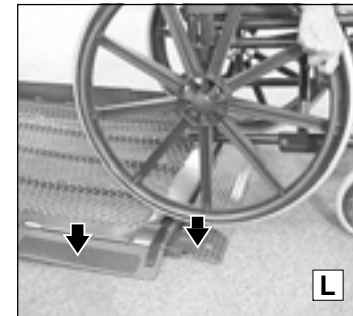
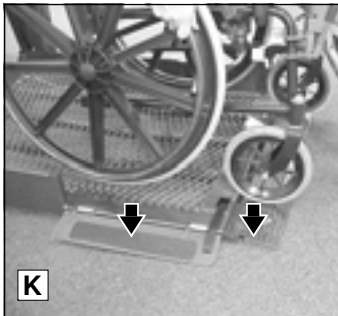
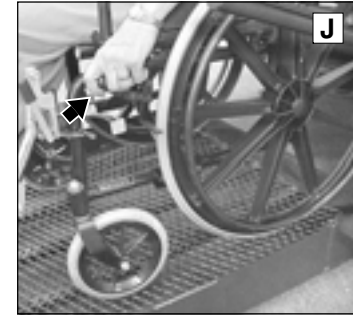

Lift Operating Instructions



To Load Passenger:

- ▶ 1. Load passenger onto platform **facing outward** and **lock wheelchair brakes**.

Note: Roll stops **must** be **fully unfolded** (ramp position) until the entire wheelchair has crossed the roll stop. See Photos K and L.

- ▶ 2. Press red UP switch until platform stops (reaches floor level). Release switch.

- ▶ Handrail Switch: Slide knob out to UP position.

Note: Roll stops **must** be UP and roll stop latch **must** be fully engaged **before** raising platform. Platform will raise above ground level approximately two inches **before** latch engages **fully**.

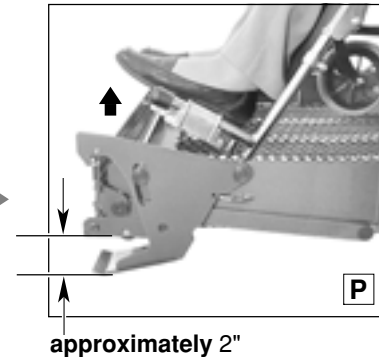
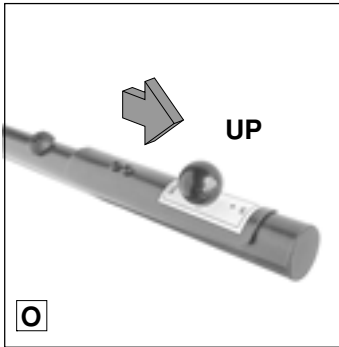
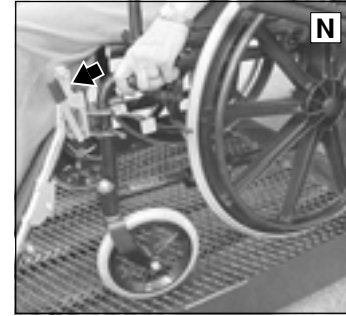

Lift Operating Instructions



To Load Passenger (continued):

3. Unlock wheelchair brakes and load passenger from platform into vehicle. **Note:** Lower head to clear door jamb header.

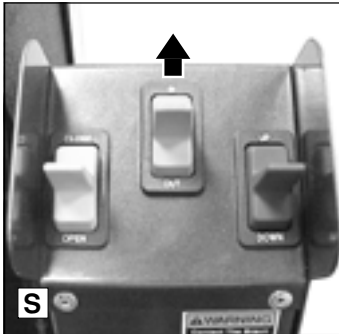

To Fold Platform (In):

- Press orange IN switch until platform **stops** (fully folded). Release switch.

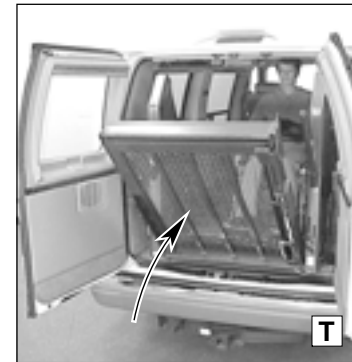

Lift Operating Instructions

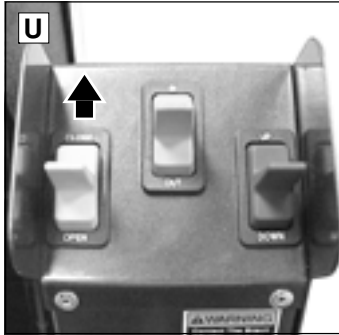

To Close Door(s):

Automatic Door Operator(s):

- ◀ Press yellow CLOSE switch until door(s) are **fully closed**. Release switch.

Manual Door(s):

Manually close door(s) **fully**.

Manual Operating Instructions

If you experience power or equipment failure, refer to the Manual Operating Instructions to operate the lift. Instructions and photos are provided for all steps that differ

from standard lift operation procedures. Manual Instructions Decal 27146 (posted on pump cover) provides manual operating instructions also. Refer to the Lift Operat-

ing Instructions for all normal lift operation procedures (such as loading and unloading passengers). **Follow all Lift Operation Safety Precautions!**



Release Valve



Note: Close backup pump release valve securely **before** operating electric pump.

approximate
1/16" intervals

maximum
30 inch lbs
minimum
15 inch lbs
seats
(stops)

Valve Tightening Specification:
Once valve seats (stops), tighten 15 to 30 inch pounds as shown.

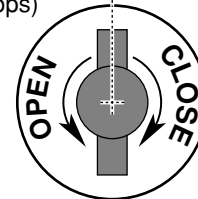

Release Valve

Manual Operating Instructions

Refer to photos and illustration of release valve on previous page.

To Unfold Platform (Out):

Using hand pump handle (Photo B):

- Place slotted end of pump handle onto back-up pump release valve and turn **counterclockwise** (open — **1/2 turn only**) until the platform reaches **floor level (fully unfolded)**. See Photo C.
- Turn the release valve **clockwise** (close) to stop the platform. See Photo C.

Note: Valve must be tight, but **do not** overtighten.

DOWN • To Lower Platform:
• To Unfold Roll Stop:

Place slotted end of pump handle onto back-up pump release valve

and turn **counterclockwise** (open — **1/2 turn only**) until the platform reaches ground level and/or roll stop unfolds.

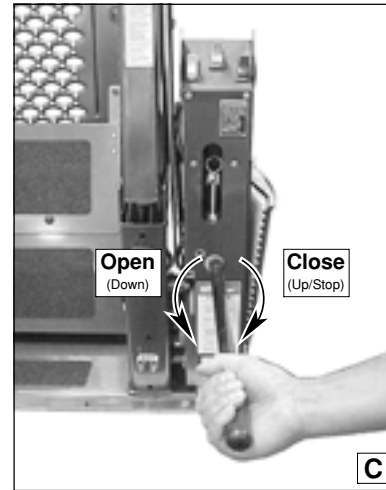

Manual Operating Instructions

Refer to photos and illustration of release valve on page 31.

UP

- To Fold Roll Stop:
- To Raise Platform:

Note: Close back-up pump release valve securely **before** operating electric pump.

Using hand pump handle:

- Place slotted end of pump handle onto back-up pump release valve and turn **clockwise** to close securely. See Photo D.

Note: Valve must be tight, but **do not** overtighten.

- Insert handle into back-up pump and stroke until platform reaches **floor level** (see Photo E).

To Fold Platform (In):

Insert handle into back-up pump and stroke until platform **stops** (folds fully). See Photo E.

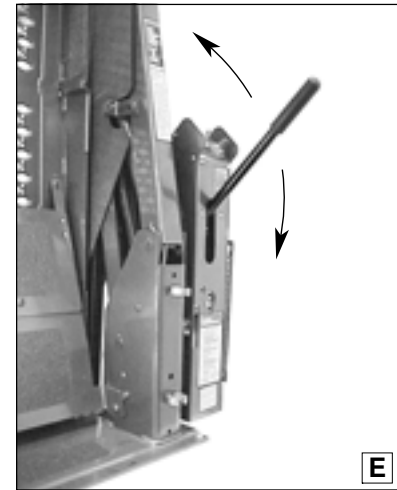
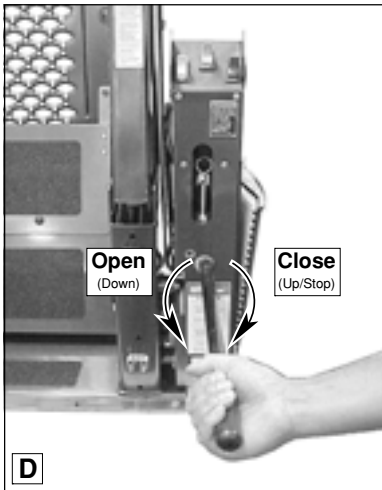

Decals and Antiskid

⚠️ WARNING

Replace missing, worn or illegible decals. Failure to do so may result in serious bodily injury and/or property damage.

Note: Clean surfaces as detailed on opposite page before posting decals.

25675

⚠️ WARNING

Lift installation and servicing prohibited by anyone who has not been certified by The Braun Corporation Sales and Service School. Certified service technicians should call 1-800-THE LIFT to receive applicable installation/service manual. Failure to follow this policy may result in serious bodily injury and/or property damage.

25675

26701



24242

Microswitch Adjustment Instructions

Unfold Down (Top) Microswitch
Turn adjustment bolt counterclockwise to stop platform unfold function sooner. Turn adjustment bolt clockwise to allow platform to unfold further.

Up-Fold (Bottom) Microswitch
Turn adjustment bolt clockwise to stop platform raise function sooner. Turn adjustment bolt counterclockwise to allow platform to raise further.

24242

25652

THE BRAUN CORPORATION

Providing Access to the World

Since 1972

ADA ♿ STANDARDS COMPLIANT

22249

⚠️ WARNING

Contact The Braun Corporation before adjusting hydraulic pressure relief valve. Failure to do so may result in serious bodily injury and/or property damage.

Decals

17866



24069

⚠️ WARNING

- Read manual before use.
- Load and unfold on level surface only.
- Engage vehicle parking brake before operating lift.
- Prohibit passenger entrance outside of vehicle to accommodate lift.
- Do not operate lift if you suspect lift damage, wear or any abnormal condition.
- Keep passenger and platform clear of area in which lift operates.

Whenever a wheelchair passenger is on the platform, the passenger must face forward.

- Wheelchair brakes must be locked.
- Roll stop must be up.
- Failure to follow these rules may result in serious bodily injury and/or property damage.

LIFT OPERATING INSTRUCTIONS

TO OPEN DOORS:

- Press **W** (with switch) until door(s) are fully open.

TO UNFOLD PLATFORM (OUT):

- Press **U** (with switch) until platform steps (reaches floor level).

TO UNLOAD PASSENGER:

- Load passenger onto platform facing forward and lock wheelchair brakes.
- Press **W** (with switch) until platform steps and roll stop unfolds fully.
- Unlock wheelchair brakes and unload passenger from platform.

TO LOAD PASSENGER:

- Load passenger onto platform facing forward and lock wheelchair brakes.
- Press **U** (with switch) until platform steps (reaches floor level).
- Unlock wheelchair brakes and unload passenger from platform.

TO FOLD PLATFORM (IN):

- Press **A** (with switch) until platform steps.

TO CLOSE DOOR(S):

- Press **C** (with switch) until door(s) are fully closed.

12375

Parking Courtesy Requested

THE BRAUN CORPORATION

Providing Access to the World

12375

27146

MANUAL OPERATION

Using hand pump handle:

TO UNFOLD PLATFORM (OUT):

- Close hand pump valve (turn clockwise).
- Insert handle in pump and stroke until platform fully extends.
- Open hand pump valve (turn counterclockwise) until platform reaches floor level. Open 1/2 turn only.
- Close hand pump valve (turn clockwise).

DOWN (TO LOWER):

Open hand pump valve (turn counterclockwise). Open 1/2 turn only.

UP (TO RAISE):

- Close hand pump valve (turn clockwise).
- Insert handle in pump and stroke until platform reaches floor level.

TO FOLD PLATFORM (IN):

Insert handle in pump and stroke.

Close valve before operating electric pump.

Decals and Antiskid

BRAUN MILLENNIUM SERIES

25580 (actual size: 1-1/2" x 24")

Antiskid

Inspect your lift for any missing or worn antiskid. Order as needed.

WARNING

Replace missing or worn antiskid. Failure to do so may result in serious bodily injury and/or property damage.

Note: Clean surfaces with isopropyl alcohol before decal or antiskid application. Use a clean cloth or paper towels. **Do not** use oily shop rags. Wipe surface free of residue with dry portion of cleaning cloth.

Available Antiskid

Size	Color	Part No.
2" x 12"	Black	#24172-BK
2" x 12"	Yellow	#24172-YL
3" x 12"	Black	#24173-BK
3" x 12"	Yellow	#24173-YL
6" x 12"	Black	#24174-BK
6" x 12"	Yellow	#24174-YL

Maintenance and Lubrication

Maintenance is necessary to ensure safe and trouble-free lift operation. General preventive maintenance consisting of inspections of your lift system and cleaning the lift should be a part of your routine.

The L955 has been designed with many self-lubricating components. Lubricate the pivot points specified on page 37 approximately every four weeks (or 100 cycles) with a light penetrating type oil (30 weight or equivalent). Severe conditions (weather, environment, heavy usage, etc.) may require more frequent lubrication.

Preventive maintenance visual inspections and lubrication procedures **do not** take the place

of the procedures specified in the Maintenance and Lubrication Schedule provided in the applicable lift installation and service manual. The procedures outlined in the Maintenance and Lubrication Schedule **must be performed at the recommended scheduled intervals by an authorized Braun Corporation service representative who has attended and been certified by The Braun Corporation Sales and Service School.**

If the scheduled maintenance and lubrication procedures are not being performed, or if there is any sign of lift damage, wear, abnormal condition or improper operation, **discontinue lift use immediately.** Contact your sales representative or call The Braun

Corporation at 1-800-THE LIFT. One of our national Product Support representatives will direct you to an authorized service technician who will inspect your lift.

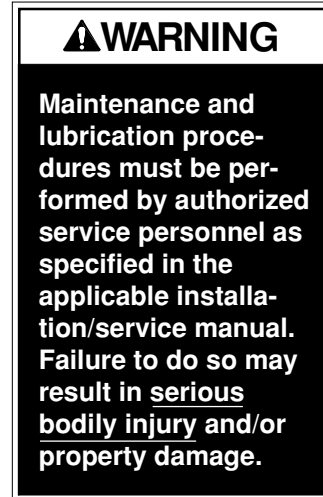

Maintenance and Lubrication

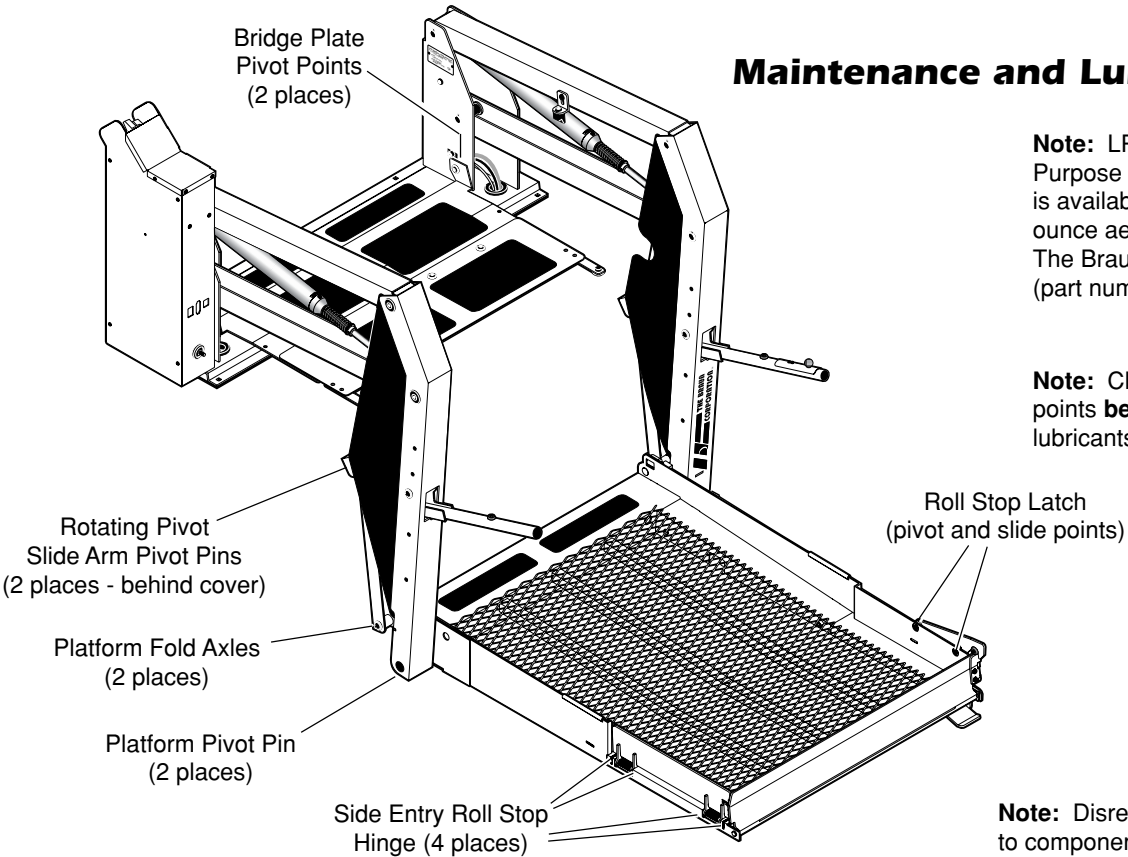

Note: LPS2 General Purpose Penetrating Oil is available in eleven ounce aerosol cans from The Braun Corporation (part number 15807).

Note: Clean lubrication points **before** applying lubricants.

Note: Disregard references to components not present.

Warranty and Registration Instructions

Immediately upon receiving your lift, examine the unit for any damage. Notify the carrier at once with any claims.

Two warranty/registration cards (shown below) are located in the lift-mounted owner's manual storage pouch. The sales representative must process one of the

cards. The consumer must fill out the other card and mail it to The Braun Corporation. The warranty is provided on the back cover of this manual. The **warranty cards must be processed to activate the warranty.**

The Braun Serial No./Series No. identification tag (shown below) is

located on the opposite pump side tower. This I.D. tag contains the product identification information provided on the Warranty/Registration card. Record the information in the space provided on the next page. **This information must be provided when filing a warranty claim or ordering parts.**

Series No. Pump Code
Model No. Serial No. Cylinder Code

OWNER'S WARRANTY REGISTRATION	
L955SE314248-A4-04293-35-14CF	
PURCHASED FROM _____	
OWNER _____	
NAME _____	DATE INSTALLED _____
ADDRESS _____	
CITY _____	
TELEPHONE _____	STATE _____ ZIP _____
TO VALIDATE WARRANTY REGISTRATION CARDS MUST BE RETURNED TO THE BRAUN CORPORATION.	

Sample Warranty/Registration Card

The Braun Corporation PO Box 310 Winamac, IN 46996 (574) 946-6153	
LIFT MODEL #	
L955SE314248	
SERIAL NUMBER	
A4-04293	
PUMP CODE	CYLINDER
35	14CF
MFG DATE	
1/12/2003	
<small>PATENTS PENDING 5,261,779-5,806,832</small>	

Sample Serial No./Series No. Identification Tag

Warranty and Registration Instructions

Model No. _____ Pump Code _____

Series No. _____ Cylinder Code _____

Serial No. _____ Date of Manufacture _____

Note: Retain this information for future use. You must have this information when filing a warranty claim or ordering

"Providing Access to the World"®



**Over 300 Braun
Dealers Worldwide**

Braun "Worry-Free" Three-Year Limited Warranty

The Braun Corporation of Winamac, Indiana, warrants its wheelchair lift against defects in material and workmanship for three years, providing the lift is operated and maintained properly and in conformity with this manual. This warranty is limited to the original purchaser and does not cover defects in the motor vehicle on which it is installed, or defects in the lift caused by a defect in any part of the motor vehicle.

This warranty commences on the date the lift is put in service, providing the warranty registration card is completed and received by The Braun Corporation within 20 days of purchase.

This warranty also covers the cost of labor for the repair or replacement of most parts for one year when performed by an authorized Braun Representative. (A Braun labor schedule determines cost allowance for repairs.)

This warranty does not cover normal maintenance, service, or periodic adjustments necessitated by use or wear. The Braun Corporation will not, under any circumstances, pay for loss of use of lift or vehicle in which it is installed or loss of time.

This warranty will become null and void if the lift has been damaged through accident, misuse, or neglect, or if the lift has been altered in any respect.



All illustrations, descriptions and specifications in this manual are based on the latest product information available at the time of publication. The Braun Corporation reserves the right to make changes at any time without notice.