



MOTOROLA

User Manual

FXC-851L

Cordless fixed wireless phone

USER'S GUIDE

This page is intentionally left blank

PREFACE

WELCOME

Congratulations on the purchase of your FXC-851L product!

Please retain your original dated sales receipt for your records.

For warranty service of your FXC-851L product, you will need to provide a copy of your dated sales receipt to confirm warranty status.

Thank you for choosing Motorola product.

➤ **Please read important safety instructions before use.**

➤ **Read and understand all instructions before use.**

➤ **Please retain this guide for future reference.**

The information contained in the FXC-851L user guide is believed to be correct at the time of printing. We reserve the right to change or modify any information, product specifications, features or functionality without notice. The contents of the FXC-851L user guide are provided "as is."

Certain features may not be activated by your service provider, and/or their network settings may limit the feature's functionality. Additionally, certain features may require a subscription.

Contact your service provider for details.

CONTENTS

SAFETY PRECAUTIONS	6
PRECAUTIONS	6
SAFETY INFORMATION	8
PACKAGE CONTENTS	11
ABOUT YOUR PHONES	12
PHONE OVERVIEW	12
INSTALLATION	13
KEY FUNCTION	16
DISPLAY INDICATORS AND ICONS	18
BASIC FUNCTION	19
BASIC OPERATION	19
USING PHONE MENUS	24
ENTER LETTERS AND NUMBERS	25
MAIN MENU	27
OVERVIEW OF MENU TREE	27
THE CONTACTS	30
READ	30
ADD	31
MEMORY STATUS	31
SERVICE DIAL	32
SPEED DIAL	32
FIXED DIAL	32
COPY	33
CLEAR ALL RECORDS	33
GROUP	34

	MY NUMBER	34
MESSAGE		36
	WRITE NEW	36
	INBOX	37
	OUTBOX	38
	DRAFTS	38
	VOICEMAIL	39
	BROADCAST MESSAGE	39
	MESSAGE SETTINGS	39
	TEMPLATE	40
	MEMORY STATUS	40
DIAL RECORDS		41
	INCOMING CALL	41
	OUTGOING CALL	41
	MISSED CALL	41
	CALL OPTIONS	42
	CALL DURATION	42
SETTINGS		43
	PHONE SETTINGS	43
	MELODY	45
	DISPLAY	45
	CALL SETUP	46
	NETWORK SETUP	49
	SECURITY SETUP	50
	FACTORY DEFAULT	52
APPLICATIONS		53
	ALARM	53
	CALCULATOR	53

CALENDAR	54
TO DO LIST	54
REFERENCE INFORMATION	55
TECHNICAL INFORMATION	55
REGULATORY	56
FCC NOTICE TO USERS	57
TROUBLE SHOOTING	59

SAFETY PRECAUTIONS

PRECAUTIONS

1. Please do not try to take out the SIM card of this phone.

This SIM card is a special encrypt card, it cannot be used in other mobile phones. It's the warranty of the product, if you try to rip or remove the SIM Card, the warrant will be not valid and your product will not be warranty in any case.

2. Please do not turn around the antenna at will, in order to avoid create the damage of antenna.

3. Keep the phone away from water and damp areas.

Water or other liquids may cause overheating, electrical leakage, and failure of the phone.

4. Do not try to disassemble the phone.

This can cause electric shock and failure of the phone. Tampering will also void the phone's warranty.

5. Put the phone in a safe and stable place.

6. Keep away from dust and heat radiation (i.e. microwaves, stoves, etc.)

7. Try to use the phone away from ordinary telephones, television sets, radios, and automated office equipment to avoid interference between the devices.

8. Use clean soft dry cloth to wipe the phone. Do not use any **chemical agents.**

9. Do not put the phone near **explosive or inflammable** materials.

10. Use the phone only within the temperature range of -20°C~60°C and humidity range of 0%~90%.

11. Keep all accessories or batteries out of the reach of small Children or babies.

Please instruct children the proper ways of handling phone during usage.

Shock circuit or breakdown may occur and may cause severe danger to user due to improper usage.

Shock circuit or breakdown may occur and may cause severe danger to user due to improper usage.

SAFETY INFORMATION

1. EXPOSURE TO RADIO FREQUENCY (RF) ENERGY

Your phone contains a transmitter and a receiver. When it is ON, it receives and also sends out radio frequency (RF) signals. When you communicate with your phone, the system handling your call controls the power level at which your phone transmits.

Your phone is designed to comply with local regulatory requirements in your country concerning exposure of human beings to RF energy.

2. OPERATIONAL PRECAUTIONS

To assure optimal phone performance and make sure human exposure to RF energy is within the guidelines set forth in the relevant standards; always adhere to the following procedures.

3. EXTERNAL ANTENNA CARE

Use only the supplied Motorola approved antenna. Unauthorized antennas, modifications, or attachments could damage the phone.

Do NOT hold the antenna when the phone is IN USE. Holding the antenna affects call quality and may cause the phone to operate at a higher power level than needed. In addition, use of unauthorized antennas may result in non-compliance with the local regulatory requirements in your country.

4. PHONE OPERATION

When placing or receiving a phone call, hold your phone as you would use a wireless telephone.

To maintain compliance with RF energy exposure guidelines, ensure the phone antenna is at least 10 inches (25centimeters) from your body when transmitting.

5. APPROVED ACCESSORIES

Use of accessories not approved by Motorola, including but not limited to batteries and antennas, may cause your phone to exceed RF energy exposure guidelines.

6. RF ENERGY INTERFERENCE / COMPATIBILITIES

Nearly every electronic device is susceptible to RF energy interference from external sources if inadequately shielded, designed, or otherwise configured for RF energy compatibility. In some circumstances your phone may cause interference.

7. MEDICAL DEVICES

1) Pacemakers

Pacemaker manufacturers recommend that a minimum separation of 10 inches (25centimeters) be maintained between the fixed wireless phone and a pacemaker.

Persons with pacemakers should:

Always keep the phone more than 10 inches (25 centimeters) from your pacemaker when the phone is turned ON. Turn OFF the phone immediately if you have any reason to suspect that interference is taking place.

2) Hearing Aids

Some digital wireless phones may interfere with some hearing aids. In the event of such interference, you may want to consult your hearing aid manufacturer to discuss alternatives.

3) Other Medical Devices





If you use any other personal medical device, consult the manufacturer of your device to determine if it is adequately shielded from RF energy. Your physician may be able to assist you in obtaining this information.

8. BATTERIES

Batteries can cause property damage and / or bodily injury such as burns if a conductive material such as jewelry, keys, or beaded chains touches exposed terminals. The conductive material may complete an electrical circuit (short circuit) and become quite hot.

Exercise care in handling any charged battery, particularly when placing it inside a pocket, purse or other container with metal objects. Use only original batteries and chargers.

Your battery or phone may contain symbols, defined as follows.

	Important safety information will follow
	Your battery or phone should not be disposed of in a fire
	Your battery or phone may require recycling in accordance with local laws. Contact your local regulatory authorities for more information
	Your battery or phone should not be thrown in the trash

Please don't use any damaged battery or charger and use the battery only for its intended purpose.

Don't apply extreme shock to the battery. It's dangerous to disassemble a battery or to apply extreme shock to the battery via nail or heavy metal objects.

Keep the charger or batteries out of reach of small children or babies.

Always try to keep the battery between -10 ~ 55 Celsius.

Use only manufacturer approved rechargeable batteries and charger designated for this device.

9. Seizures / Blackouts

Some people may be susceptible to epileptic seizures or blackouts when exposed to flashing lights, such as when watching television or playing video games. These seizures or blackouts may occur even if a person never had a previous seizure or blackout.

If you experienced seizures or blackouts, or if you have a family history of such occurrences, please consult with your doctor.

PACKAGE CONTENTS



Transceiver / Phone



Base



Adapter / Charger

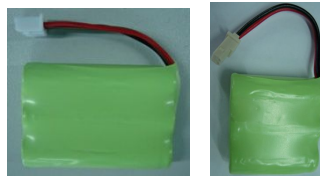

Backup Battery

- The appearance of the parts in your package may be different from those in this Manual.
- Package contents may vary by market. Please check with your service provider.

ABOUT YOUR PHONES

PHONE OVERVIEW

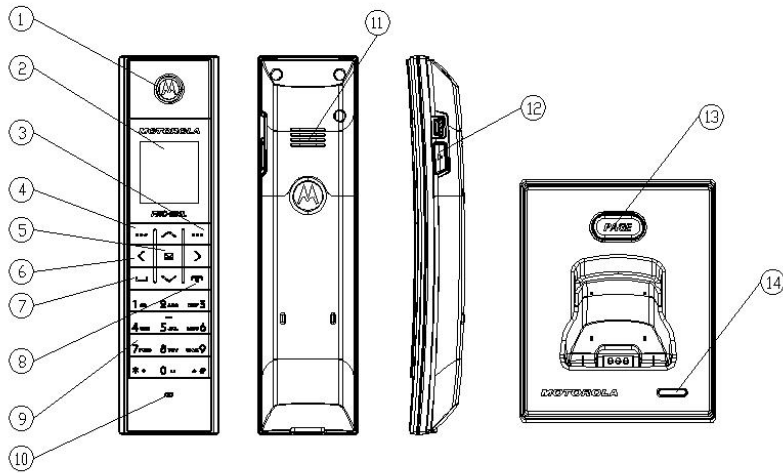

No	Description	No	Description
1	Receiver	2	LCD Display
3	Contacts / Back / Cancel / Right soft Key	4	Menu / OK / Option / Left soft Key
5	SMS Key	6	Scroll / Navigation Key (Up, Down, Right, Left)
7	Send / Answer / Call Key	8	End / Power on off Key
9	Dial / Numeric Key	10	Microphone
11	Speaker	12	Speaker Phone Key
13	Page Button	14	LED Light

INSTALLATION

[1] Plugging AC/DC Adapter in to Cradle

Connect the adaptor to Cradle.

[2] Plugging AC/DC Adapter

Connect the adaptor to AC Wall outlet.

[3] Plugging Cradle

Put the phone on the Cradle.

[4] SIM Card and battery installation in the handset

- 1) Remove the battery cover.
- 2) Insert SIM card into the SIM slot in the right direction
- 3) Connect the rechargeable battery pack into the battery plug
- 4) Replace the battery door.

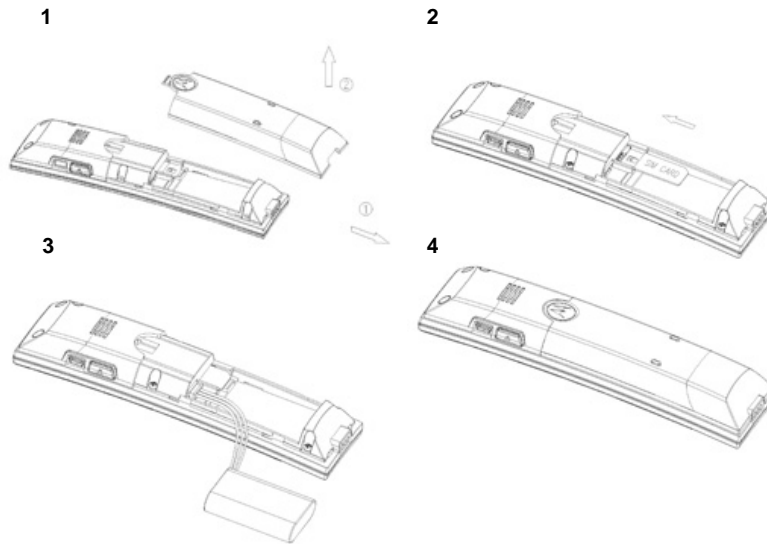

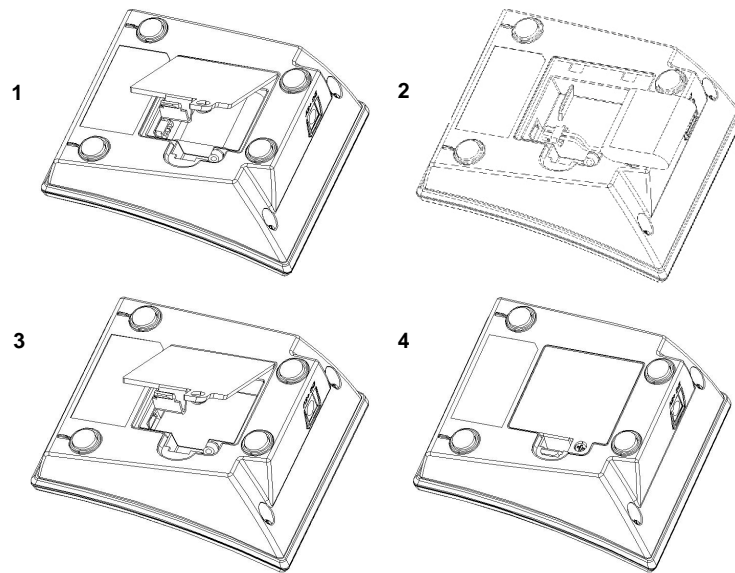

[5] Turning Phone's Power On/Off

After installing the handset correctly, press the power key which is on the right of the front panel for about 3 seconds, the phone will then automatically test whether the SIM Card is inserted and valid. Wait for the antenna icon to display indicator bars before you make a call.

- 1) When the battery icon is empty, put the phone on the Cradle connecting to the external power adapter.
- 2) Plug the external power adapter into the power socket. The unit will power up automatically.
- 3) Check the cellular signal strength and move the unit until the best signal possible is achieved.
- 4) In state of power-on, press and hold power key button, LCD screen closes.

Note:

The battery pack is a backup for emergencies in case of a power failure. Do not operate the phone without having AC/DC adaptor connected.

Be sure to carefully match the positive and negative terminals as shown on the battery.

When using the phone for the first time, charge it for over 6 hours to ensure optimum battery charge.

Caution:

It is prohibited to use the SIM card for this Fixed Wireless Phone in other GSM phone.

Once the SIM pin number is entered, the SIM pin maybe automatically changed so the initial PIN is no longer valid. Therefore, it is highly recommended NOT to take out the SIM card once it is installed in this product.

DO NOT bend or scratch your SIM card, and avoid exposing it to static electricity, water, or dirt.

KEY FUNCTION

[1] Left / Right Soft Key (Menu / **Contacts** key)

- Press the left soft key (**Menu**) to perform the function indicated by the text on the screen above the key.
- Press the right soft key (**Contacts**) to directly access the Contacts list

Note:

The functions of the soft keys depend on the guiding text shown above the keys. For example, when the text **Menu** is above the left soft key, press, and the left key enters the menu functions. Similarly, pressing the right soft key under the text **Contacts** accesses the **Contacts** list functions

[2] Send key

- Press to make a call to a name / number shown on the screen.
- Press to answer a call.
- Press to access the list of recently dialed numbers.

[3] End key

- Press to end a call.
- Press once to exit a function and return to the idle screen.

[4] Numeric Keys / '*' keys / '#' Keys

- Used for entering numbers and letters.
- Press and hold number 1 key to call the voice mailbox.
- Press '#' key to toggle between upper case, lower case and numeric modes. Keep pressing '#' key to change silent mode in the phone.
- Press '*' key to toggle between letters and symbols. Keep pressing '#' key to lock the phone in the idle screen. Also refer to [6.2] section "Phone Lock" in page 51.

[5] Navigation / Scroll keys

- Press **left** navigation key to **Calendar**.
- Press **right** navigation key to **Calculator**.
- Press **up** navigation key to **STK**.
- Press **down** navigation key to **Phonebook**.
- Press this key to press up / down the phone's menu.
- Press to move the cursor when entering letters.

[6] SMS Key

















- Press to enter 'write new message' function in idle mode

[7] Speaker key

- If you are using the handset to call and you want to transfer the call to the speakerphone mode, press the **Speaker key** button in right side to the speakerphone

DISPLAY INDICATORS AND ICONS

The display indicators and icons provide information about the operation of the phone.
 The start screen is displayed when the phone is turned ON. Several features can be used only when the phone is at the start screen.

	<p>Signal Strength Indicator</p> <p>Indicate the strength of the network signal</p> 
	<p>Volume tone Indicator</p> <p>Indicate the tones of the Volume</p> 
	<p>Battery Level indicator</p> 
	<p>Alarm Indicator : shows when the alarm is activated</p>
	<p>Call records</p>
	<p>Voice message</p>
	<p>Received New message</p>
	<p>SMS read already</p>
	<p>Sent SMS</p>
	<p>Unread SMS</p>
	<p>Contacts stored in SIM card</p>
	<p>Contacts stored in Phone</p>
	<p>Keep in silence during a call</p>
	<p>Phone Lock</p>

BASIC FUNCTION

BASIC OPERATION

[1] Switching the phone ON and OFF

- 1) To turn on your phone, press and hold “**End key**” for a few seconds or until the display turns on.
- 2) To turn off your phone, press and hold “**End key**” for a few seconds.

[2] Making a call

1) Dial a Call

Raise your phone and enter phone number which you want to call. After entering phone number and press “Call key” to make a call.

Tip: In some menus like Contacts, Dial Records, etc. which have individual phone number, Press “Call key” directly to make a call.

2) Dial the Fixed Phone Extension Number

Some fixed phone extension can't be called directly, it need a phone exchange. If you input the pause character ‘P’ between the phone number and extension number and press “Call Key”, the phone will start the dial procedure, connect to the extension number. To get the “P”, press the “★” key for a while till the “P” displayed on the phone screen.

3) Dial a International Call

Press the “★” key till the character “+” displayed on the phone screen.

Input the country code and the phone number after the prefix.

4) Dial From Contacts

Press **the right soft** key to get into the phone book. Press **Up / Down navigation** key to scroll the list to search the caller's name. Then press call key to make a call.

5) Speed Dial

Press 2-9 keys for a while, the phone number stored in speed dial list will be sent out. Make sure the speed dial key has been set up.

[3] Answering a call

When your phone rings, press “**Call key**” or “**Speaker key**” to answer in speaker phone mode.

[4] Speaker mode.

You can make or answer a phone call by pressing the **Speaker key** button in right side to the speakerphone.

To make a call:

- 1) Press the number you want to connect to.
- 2) Press Send key.

Note: The call is automatically made without pressing, approximately 3 seconds after you dial the number.

To answer a call

When the phone rings, press **Speaker key** to turn ON the speaker phone mode.

[5] Adjusting the Ring Volume

You can enter the menu and then adjust the ring tone volume by pressing the scroll keys on the phone.

- 1) Incoming a call or During a call, directly press **left / right navigation key** up to enter the **Ring Volume** control screen.
- 2) Press **right navigation key** to increase the volume.
- 3) Press **left navigation key** to decrease the volume.

[6] Redialing the last-dialed number

The phone stores up to 10 last dialed numbers.

- 1) Press **Send key** for a second to find the most recently dialed numbers.
- 2) Press navigation key to scroll to the number you wish to dial.
- 3) Press **Send key** once.

Note: If no recently dialed numbers are stored, you will not be able to use this function.

[7] Caller ID

- Requires a subscription to a calling plan that supports this feature. Not available in all areas. Contact your telephone service provider for availability and details. When Caller ID is active, your phone shows the caller's phone number during an incoming call, as long as this number is a part of your service provider's wireless network.
- The wireless network lets you know if it does not recognize the caller's phone number.
- The wireless network will also let you know if the calling party has blocked the Caller ID feature.
- If you have stored the name and number of the calling party in your Contacts and that number is supported by the wireless network, the caller's name will also appear.

[8] SMS and Voice Mail

Requires a subscription to a calling plan that supports this feature. Not available in all areas. Contact your telephone service provider for availability and details.

A new SMS arrives:

The back light of the LCD is ON and the display shows "New Message, Read Now ?"

text message with SMS icon  . And if you want to read received new Message, press the left soft key (Yes). If you want to check message later, press the right soft key (No).

Voice mail arrives:

The back light of the LCD is ON and the display shows "New Voice Message, Listen Now ?" text message with Voicemail icon  . And if you want to check new voice message, press the left soft key (Yes). If you want to check message later, press the right soft key (No).

[9] Leash Function

Leash is a distance limitation talking function, developed for Cordless fixed wireless phones. If the Cordless fixed wireless phone, during a conversation, passes any of the limits, the end user will hear a beep and if he stays out of the limit, the call will be dropped.

When you move beyond the scope of service, this phone will issue every two seconds a beep and a prompt on the LCD screen that will say "**Please, return to coverage area**" after five consecutive times you will not be able to use the telephone and a prompt will appear in the screen that will say "**No Coverage**"

[10] Page Function

If you couldn't find your phone because of your inadvertence, you can press the button "PAGE" on the desk charge, the phone will be issued a string of so-ling sound then you can find it easily.

When you press page button on cradle:

- In idle mode under coverage: beeping sound for 1 minute or until the user finds the handset and presses any key. Also, show a message in the screen saying: "Paging in progress, press any key to abort"

- No coverage: Based on the fact that the phone is unreachable by the cradle the phone keeps beeping plus a message in the phone screen saying: "Please, return to coverage area"

Synchronization with cradle:

- When inserting handset on cradle: synchronized.
- When you turn ON the phone and the handset is not paired with any cradle the phone display the following message: "Please, return handset to cradle"

Idle mode:

- When phone is in coverage area: Nothing happens.
- When phone is out of coverage area, the phone should reproduce a beep with the message: "Please, return to coverage area"

Calling mode:

- If you are almost out of coverage area : The phone shall reproduce a single low volume beep plus the message: "Please, return to coverage area"
- Out of coverage area: normal beep plus the message: "Please return to coverage area", after some seconds with no return to the coverage area the call must be dropped and the phone must go to "NO coverage" mode.

USING PHONE MENUS

[1] Menus

A menu is a list of choices you can make. Your phone has 5 menus. (And your service provider may add STK menu extra depending on network service) Each menu contains options that allow you to use the message, change the ring tone, etc.

You can use menus and sub-menus in two ways: by scrolling or by using shortcuts.

[2] Scrolling through menus

1) From the Start screen, press **Menu**, and then scroll through the menus using **left / right / up / down navigation key**.

2) Use the scroll and **OK** key to select the submenus and **back** key to return to the Start screen.

[3] Exiting menu levels

1) To return to the previous menu level, press **Back** key or **Cancel** key.

2) To return to the Start screen, press **End** key. No menu setting changes will be saved.

[4] Menu Tree

You can refer to [pages 26](#) about Menu tree for more details.

[5] Using shortcuts through menus

1) **Calendar**: press **left** navigation key directly.

2) **Calculator**: press **right** navigation key directly.

3) **Inbox**: press **up** navigation key directly.

4) **Phonebook**: press **down** navigation key directly.

5) **Write New (Message)**: press **SMS** key directly.

6) **Outgoing call**: press **Call key** one time for a second.

ENTER LETTERS AND NUMBERS

You can enter letters, as well as numbers, when storing information in your phone by using your phone's keypad. To enter letters, press the key associated with the letter you wish to enter until it appears on the screen (numbers will also appear).

[1] Entering Letters

When you want to add new names or when you view names in the Contacts, your phone automatically switches to the abc (ABC) mode and displays the abc icon on the right upper side in Display.

Key Characters

Key	Characters	Key	Characters
1	, . ? ! @ 1	2	a b c 2 å æ ä à ç á
3	d e f 3 è é	4	g h i 4 ì í
5	j k l 5 £	6	m n o 6 ö ø ò ñ ó
7	p q r s 7 ß \$	8	t u v 8 ù ü ú
9	w x y z 9	0	(Space) 0
*	, . ' ? ! " @ ¥ \$ _ ' ^ { } \ [~] # ¢ % & () * + - / : ; < = > ¡ § ¨	#	Change letter case(※)

※ : abc → Abc → ABC →123 rotated

[2] Editing name or phone number

To edit a name already stored in the Contacts:

- 1) From the main screen, use the **right soft key**.
- 2) From the Contacts list (Read), select the name you want to edit by scrolling up / down navigation key and press **OK** key.
- 3) To edit, press the left soft key and scroll down to the edit option and press **OK key**.
- 4) Edit the name you want to change and / or press again **OK key** to change the phone number.
- 5) Press **up or left navigation key** to scroll the cursor to the left.
- 6) Press **down or right navigation key** to scroll the cursor to the right.
- 7) Press **Clear** to correct any mistakes or press **hold to clear all**.
- 8) Press the **left soft key OK** to save changes or the **right soft key** to cancel.

[3] Changing the case of letters and numbers

You can switch the mode among uppercase and lowercase letters and numbers by pressing # key.

MAIN MENU

OVERVIEW OF MENU TREE

Your phone's menu may differ from the following list, depending on the Network services to which you have subscribed and the accessories you are using. If you have any questions, please call your service provider

1. Contacts	
1. Read	
2. Add	1. Save to SIM
	2. Save to Phone
3. Memory Status	
4. Service dial	
5. Speed dial	
6. Fixed Dial	1. Enable FDN
	2. Read
7. Copy	1. SIM to Phone
	2. Phone to SIM
8. Clear all records	1. Phone Records
	2. SIM Records
9. Group	1. Family
	2. Friends
	3. Office
	4. Others

	10. My number	
2. Messges		
	1. Write New	
	2. Inbox	
	3. Outbox	
	4. Drafts	
	5. Voice mail	1. Number
		2. Clear
		3. Call Voice mail
	6. Broadcast Message	1. Receive Mode
		2. Languages
	7. Message Settings	1. Service center number
		2. Expire Period
		3. Message Type
		4. Status Report
		5. Alert Period
	8. Template	
	9. Memory Status	
3. Dial Records		
	1. Incoming Call	
	2. Outgoing Call	
	3. Missed Call(s)	
	4. Call Duration	
4. Settings		
	1. Phone Settings	1. Clock Settings
		2. Language
		3. Answer Mode
	2. Melody	1. Melody Setup

	2. Volume
	3. Ring Type
3. Display	1. Idle Display
	2. Contrast
	3. Backlight
4. Call Setup	1. Call Divert
	2. Call Barring
	3. Call Waiting
	4. Auto Redial
	5. Caller ID
5. Network Setup	1. Network select mode
	2. Preferred Networks
6. Security Setup	1. PIN SIM
	2. Phone Lock
	3. Change Password
	7. Factory Default
5. Applications	
1. Alarm	1. Alarm 1
	2. Alarm 2
	3. Alarm 3
2. Calculator	
3. Calendar	
4. To Do List	
6. STK	

THE CONTACTS

New entries can be stored in the SIM card or in your Phone.

You can store up to 100 entries in the phone and an additional 250 in the SIM depending on the SIM limitations. Entries stored in the phone allow numbers of up to 30 digits, and names of up to 16 characters.

In standby mode, you can press Right Soft key to immediately access the Contacts list. When the name is found by pressing Contacts, press OK and option key to select option sub menu (you can choose to send Message to, edit, clear, add to group, copy)

Using Contact Menus

The Contacts has several menus to select from. These menus appear when you press **Menu** (Left Soft key) and select Contacts menu by pressing OK key. Press right soft key (back) to move back to the main menu.

- **Read:** Show the names stored in phone and / or SIM card.
- **Add:** Add new entry (s)
- **Memory Status:** Memory status of phone and SIM
- **Service dial :** Show service name provided by Service networks the phone
- **Speed Dial:** One button dialing
- **Fixed Dial :** Limit to call or send message
- **Copy:** Copy from SIM (Phone) to Phone (SIM)
- **Clear All Records :** Clear all Phone or SIM entries
- **Group:** Organizing group of Contacts
- **My number:** Inputting or check your own number

[1] **Read (by name)**

- From the Contacts menu, select Read and press left **OK** key or just press 1
 - Enter the first letters of the name you need and then the cursor goes to the name you wanted directly after one second or select name using to scroll and press left **OK** key
 - After choosing one of the name, you can select left **option** and you can choose five sub menus.
- **Send Message To:** You can send SMS to this entry
 - **Edit :** You can edit the name and number of this entry
 - **Clear :** You can delete this entry only (You need to re-confirm)
 - **Add to group:** You can put this entry to group, but you cannot use SIM entry to a group.
 - **Copy:** If you select a SIM card's entry and select **Copy**, you can copy it to phone memory. If your selection is Phone memory's entry, **Copy** means copy chosen entry to SIM card

[2] Adding a new Contacts Entry

To create a Contacts entry:

- 1) Press **Menu > Contacts >** Scroll to **Add** and press **OK**
- 2) Press **Save To SIM** or **Save To Phone** depending on where you want to store the phone entry.
- 3) Add Name and press **OK** key
- 4) Add Number and press **OK** key

[3] Memory Status

To press 'Memory Status' and you can see the capacity of SIM card used / SIM card total and Phone used / Phone total.

[4] Service dial

You can check or / and call service number provided by your network Service. This menu may differ depending on the Network services to which you have subscribed. Not available in all areas. Contact your telephone service provider for availability and details.

[5] Speed Dial

- 1) Press **Menu > Contacts**
- 2) Scroll to **Speed Dial** and press **OK**
- 3) Select one entry. If the numbers are Empty, Press **OK > Select Set/Change** and press **OK**, you can assign one phone number. After choosing one, press **OK**
- 4) If you assigned one phone number already, you can see four sub categories

- Set / Changes : You can change the assigned number
- Detail : You can see the number of this entry
- Clear : You can delete this entry
- Dial to : You can dial to this entry

You can use only phone entries and SIM entries and appoint 8 entries. On the idle display, press one assigned button and press Call button or press one assigned number for about 3 seconds till make a call.

Ex> If the number assigned in 2 is 01-34-567, just press 2 and Call button

[6] Fixed Dial

Fixed Dial is a function depends on SIM, it limits to call or send message. In default status, the FDN function is closed (disabled).

If FDN enabled, you can a) hide your contacts records in SIM card and b) forbid to add new contacts into SIM card and c) forbid to call or send SMS except the contact

numbers in fixed dial list.

If FDN disabled, you can call, send SMS and add records to SIM card in normal. You can also see all SIM contacts.

- 1) Press **Menu > Contacts**
- 2) Scroll to **Fixed Dial** and press **OK**

➔ Enable FDN/Disable FDN: Input PIN2 code to enable FDN or disable FDN function.

➔ Read: When the FDN enabled, you can read / edit / clear / add FDN list through the input PIN2 Code and when the FDN disabled, you can't read / edit / clear / add FDN list.

[7] Copy

You can use this function to copy all numbers from the SIM card to your fixed phone, or vice versa:

- 1) Press **Menu > Contacts**
- 2) Scroll to **Copy** and press **OK**
- 3) Press **SIM to phone** or **Phone to SIM** depending on where you want to copy all Contacts entries.
- 4) Press **YES**, then the copy process is done promptly

[8] Clear All Records

You can delete all Contacts entries:

- 1) Press **Menu > Contacts**
- 2) Scroll to **Clear all Records** and press **OK**
- 3) Press **Phone Records** or **SIM Records**, depending on where you want to delete all Contacts entries.

- 4) Press **OK** to confirm the deletion of all Contacts entries.
- 5) Select **Yes** if you want to delete. Otherwise, select **No** to go back to the previous menu.

Caution: When complete all information stored in your Contacts will be deleted and can no longer be restored.

[9] Group

Contacts entries can be grouped to some units:

- 1) Press **Menu > Contacts**
- 2) Scroll to **Group** and press **OK**
- 3) And you can see four groups 1) Family 2) Friends 3) Office 4) Others
- 4) Select one and press left **OK** and you can see the sub menus

In one group, you can select three sub menus

- **Group Member: You can see entry (s) belongs to the group**
- **Rename : You can edit the name of this group itself (Ex> Family (Home)**
- **Alert Tone: You can change the tone when the member of this group called you.**

Note: Only phone memory numbers can be added to group

[10] My Number

You can check, edit, erase and save your owner name and number

- 1) Press **Menu > Contacts**
- 2) Scroll to **My number** and press **OK**

3) Select **Line 1 Number** or **Line 2 Number** and press OK

➤ Press Option>**Edit** to edit your own name and number and press **OK**.

➤ Press Option>**Clear** to remove your own name and number and press **OK**.

MESSAGES

Requires a subscription to a calling plan that supports this feature. Not available in all areas. Contact your telephone service provider for availability and details. You can send or receive text messages with your phone. Text messages that you receive may contain ring tones that you can store in your phone. It supports 160 characters.

You can also send maximum about 600 characters. If your message is about 600 characters, the phone divides the message into four parts and sends these in each time. This function is called SMS concatenation.

After completing the message content, you can choose to send it out right away, or save it as a draft.

- ➔ **Write New**
- ➔ **Inbox**
- ➔ **Outbox**
- ➔ **Drafts**
- ➔ **Voice Mail**
- ➔ **Broadcast Message**
- ➔ **Message Settings**
- ➔ **Template**
- ➔ **Memory Status**

[1] **Write New**

You can send a text message to one recipient. You can manually enter each Recipient's phone number, or you can select the numbers from the Contacts.

Note: The maximum length of a text message differs, depending on the

capabilities of the network from which it originated. Also, text messages may appear different at different times because messages can originate in networks other than your own. Contact your service provider for more information about this feature.

- 1) Press **Menu > Message> OK**.
- 2) Scroll to Write New and press **OK**
- 3) You can create the message.
- 4) When you press **OK**, you can see three submenus;
 - **Only Send:** After sending, the message is deleted
 - **Only save:** No sending. The message is saved into **Drafts**.
 - **Send and Save :** After sending the message is saved into **Outbox**

[2] **Inbox**

When a message arrives, a pop-up message is displayed and a new message icon appears. You can read it immediately, or read it later in your Inbox. You can see the icon 

- 1) Press Menu > **Message**.
- 2) Scroll to the **Inbox** and press **OK**.
- 3) From the list, highlight the one you need and press **OK**.
- 4) You can choose six options
 - **Reply:** You can reply your messages.
 - **Forward :** You can forward the chosen message
 - **Edit:** You can edit the chosen message.
 - **Clear:** You can delete the chosen one.
 - **Clear All:** You can empty the Inbox
 - **Cut Number :** You can cut and save the phone number from Inbox message

[3] Outbox

The Outbox stores messages sent and saved.

- 1) Press Menu > **Message**.
- 2) Scroll to the **Outbox** and press **OK**.
- 3) From the list, highlight the one you need and press **OK**.
- 4) You can choose six options
 - **Send:** You can send the chosen message.
 - **Forward :** You can forward the chosen message to others
 - **Edit:** You can edit the chosen message.
 - **Clear:** You can delete the chosen one.
 - **Clear All:** You can empty the Out box
 - **Cut Number:** You can cut and save the phone number from outbox message.

[4] Drafts

You can see draft messages which you already saved. After choosing one of them, you can have four choices

- **Forward:** You can send the chosen message.
- **Edit:** You can edit and save the chosen message.
- **Clear:** You can delete the chosen one.
- **Clear All:** You can empty the draft box.

[5] Voicemail (Network Service)

You can listen to your voicemail messages by calling your network voicemail phone number. Voicemail messages are stored in the network voicemail box, not in your phone.

Also refer to [8] section in pages 21

- 1) Press **MENU > Message**.
- 2) Scroll to **Voice Mail** and press **OK**.
- 3) There are three submenus. Select one and press **OK**
 - **Number:** Enter or modify the network service number.
 - **Clear:** Delete Pre-saved service number
 - **Call Voice Mail:** Dial the network service number and connect to the Voicemail Server.

[6] Broadcast Message

There are 2 submenus you can choose

- **Receive Mode**
- **Languages**

[7] Message Settings

There are 5 submenus you can choose.

- **Service Center Number:** The SMS Center Number is required in order to send messages. Ask your service provider for this number.
- **Expire Period:** Set the period of time the message is stored in the service center. You can set the period for 1 hour, 12 hours, 1 day, 1week, maximum. When the set period expires, the service center will delete all messages, even if the user

has not received the message.

- **Message Type:** When you set the message type, the network will convert the message to the type you have set. (Text//Fax//E-mail)
- **Status Report:** If you turn On this option, you can be notified if the recipient received your message.
- **Alert Period:** you can choose message alert time with one time // Every 2 min // Off when we receive new message.

[8] Template

There are some sample messages in SMS template and you can edit & save the template or send the message you selected.

- 1) Press Menu > **Message**.
- 2) Scroll to the **Template** and press **OK**.

There are 2 options as below

- **Edit:** press Option>**Edit**, you can edit the message template and press **save**.
- **Forward:** press Option>**Forward**, you can use SMS template to send the message

[9] Memory Status

Check memory status in the SIM and in the Phone. The total capacity of SIM is depends on your SIM card, total capacity of phone is 100. Also you can see used area of SIM and phone.

DIAL RECORDS

The Call History function keeps track of:

- **Incoming Calls**
- **Outgoing Calls**
- **Missed Calls**
- **Call Duration**

Note: Your phone can store up to 30 call numbers including missed, received and dialed calls.

When you miss a call (s), the Missed Calls message appears on your phone's screen. You can press **Yes** to view the Missed Calls list or press **No** to ignore the message and go back to Standby. The records will be stored in Call History. You are notified of missed calls only when your phone is turned ON in the service area from which the missed call originated.

[1] **Checking Incoming/Outgoing/Missed Call**

- 1) Press **Menu > Dial Records**
- 2) Select Incoming // Outgoing // Missed Call and press **OK**
- 3) From the list of records, scroll the one you need
- 4) The screen shows Call Information including Number, Date and Time of receiving.

[2] Call options

You can choose some options in related with Missed Calls, Dialed Calls or Received Calls when you have any call log.

- 1) Press **Menu > Dial Records**
- 2) Choose one of them;
Incoming call / Outgoing call / Missed call and press **OK**
- 3) You can press left **Option**
- 4) You can see six different menus;
 - **Dial To:** When you choose one entry and select **OK**, directly calls to.
 - **Send Message To:** You can send this entry the SMS message without selecting recipient.
 - **Clear :** You can delete chosen entry
 - **Save Number:** You can save chosen number to SIM or Phone.
 - **Clear all:** You can delete all entries in the category (If you select **Outgoing call** all the **Outgoing call** entries are deleted)
 - **Show Number:** You can see the number of chosen entry

[3] Call Duration

You can check the total duration of incoming call and last call duration

You can see **Outgoing Duration, Incoming Duration** and **Last Call Duration** in one display.

The type of checking time is hh : mm : ss (h: Hours, m: Minute, s: Second)

You can press left **Reset** to erase all call duration time.

SETTINGS

Setting menu includes:

- **Phone Settings**
- **Melody**
- **Display**
- **Call Setup**
- **Network Setup**
- **Security Setup**
- **Factory Default**

[1] Phone Settings

[1.1] Clock settings

This menu guides you to set Time/Date.

Date & Time Setting: Set the correct time and date to ensure the Alarm is working correctly.

Date & Time Setting

- 1) Press Menu > **Settings** > **OK**
- 2) Scroll Phone Settings and press **OK**.
- 3) Select Clock Settings then press **OK**.
- 4) Select Date & Time Setting and press **OK**.
- 5) Input month / day / year and hour/minute/am or pm by using numeric keys and left and right navigation key
- 6) Press **Save**

Date Format: There are four types of expressions of dates

- ➔ DD / MM / YY (day / month / last two digits of this year)
- ➔ MM / DD / YY
- ➔ DD / MM / YYYY (day / month / full digits of this year)
- ➔ MM / DD / YYYY

Date Separator: There are four types of separators of date digits

- ➔ OO-OO-OO (Hyphen)
- ➔ OO/OO/OO (Slash)
- ➔ OO.OO.OO (Dot)
- ➔ OO OO OO (Blank)

Time Format:

You can choose 12h or 24 hours. For example, if the time is 1:22 pm (12h expression) , it can be shown as 13:22 (24h expression)

[1.2] Language

Three languages options can be selected: English / Spanish (Español). Also you may choose automatic option; Your native language can be chosen without manual selection.

- 1) Press **Menu > Settings** and press **OK**
- 2) Scroll **Phone Settings** and press **OK**
- 3) Select **Language** and then press **OK**
- 4) Select the language you need and press **OK**

[1.3] Answer Mode

Normal answer: You can press only answer key and speaker phone key to receive the incoming call.

You can also receive the incoming call by pick the handset up without press any other key.

Any key answer: To answer your receiving call, you can press any key except End key.

[2] Melody

[2.1] Melody setup

Set Melody for Incoming Call and Message Tone

Note: For each tone setup, you can choose one of 10 ring tones for Incoming call and 4 ring tones for Message Tone.

[2.2] Volume

Eight volume levels are available for Call, ring tone and keypad tone. Adjust the volume to your preference using left / right navigation key.

[2.3] Ring Type

- 1) Press **Menu > Settings** and press **OK**
- 2) Scroll **Melody** and press **OK**
- 3) Select **Ring Type** and then press **OK**
- 4) Select **Ring Once** or **Repeat Ring** as you need and press **OK**

[3] Display

[3.1] Idle Display

Clock and Date

When you choose **Enable**, you can see the date and clock on your idle display

Wallpaper

There are some pictures for your selection.

[3.2] Contrast

There are 20 levels for LCD contrast. Press right navigation key then the contrast goes up. Press left navigation key then the contrast is down

[3.3] Backlight

Set Specific LCD and Keypad Backlight time.

- 1) Select **Backlight** and press **OK**
- 2) Toggle Always on, 5 seconds On, 15 seconds On, 30 seconds On or 45 seconds On and press **OK**

[4] Call Setup

The following features may require a subscription to a calling plan that supports them. Not available in all areas. Contact your telephone service provider for availability and details

[4.1] Call Divert

Call Divert is a network or subscription dependent service. It allows you to forward a call to another number, based on various conditions.

- 1) Press **Menu > Settings** and press **OK**
- 2) Scroll **Call Setup** and press **OK**
- 3) Press **Call Divert** and press **OK**
- 4) Select one of the options below, and then press **OK**

- ➔ **All Voice Calls:** All incoming calls to a designated number.
 - ➔ **On Busy:** Divert all incoming calls when there is at least one call in progress.
 - ➔ **No Answer :** Divert the incoming call if it is not answered
 - ➔ **Unreachable:** Divert all incoming calls when the phone is not reachable due to a network error or some other reason.
- 5) Select Check Status, Activate, or Deactivate and press **OK**
- ➔ **Check Status:** Check current Call Divert setting status.
 - ➔ **Activate:** Activate the chosen Call Divert option. Type the number you want a call to be forwarded to.
 - ➔ **Deactivate:** Deactivate the chosen Call Divert option.

[4.2] Call Barring (Network Service)

Call Barring is a network or subscription dependent service.

This feature allows you to restrict or bar certain or all types of calls to and from your phone.

- 1) Press **Menu > Settings** and press **OK**
 - 2) Scroll **Call Setup** and press **OK**
 - 3) Press **Call Barring** and press **OK**
 - 4) Select one of the options below, and then press **OK**
 - ➔ **All Outgoing Calls:** Bar all outgoing calls.
 - ➔ **All Calls abroad:** Bar all outgoing international calls.
 - ➔ **Abroad but Home:** Prevent users from making any international calls other than to home
 - ➔ **All Incoming Calls:** All Calls Bar all incoming calls.
 - ➔ **Incoming While Roam:** Bar all incoming calls when the phone is roaming.
- 5) Select Check Status, Activate, Deactivate and press **OK**
- ➔ **Check Status:** Check current Call Barring setting status.
 - ➔ **Activate:** the chosen Call Barring option.

➔ **Deactivate:** Deactivate the chosen Call Barring option.

Note: To activate and deactivate Outgoing, Incoming, and Cancel Calls, the SIM password may be required. Contact your service provider.

[4.3] Call waiting (Network service)

Call Waiting is a network or subscription dependent service. If set it to Activate, the Call Waiting feature enables the network to remind you of other incoming calls during a call in progress.

- 1) Press **Menu > Settings** and press **OK**
 - 2) Scroll **Call Setup** and press **OK**
 - 3) Select **Call Waiting** and press **OK**
 - 4) Select Check Status, Activate, Deactivate and then press **OK**
- ➔ **Check Status:** Check current Call Waiting setting status.
- ➔ **Active:** Activate Call Waiting function
- ➔ **Deactivate:** Deactivate Call Waiting function.

[4.4] Auto Redial

If set the Auto Redial to toggle enable, the phone would keep dialing until the called party is available or end the call.

- 1) Press **Menu > Settings** and press **OK**
- 2) Scroll **Call Setup** and press **OK**
- 3) Select **Auto Redial** and press **OK**
- 4) Toggle Enable or Disable, and then press **OK**

[4.5] Caller ID

Caller ID is a network or subscription dependent service. Not available in all areas.

Contact your telephone service provider for availability and details.

If call ID is enabled, you can choose to send/hide your phone number to/from the calling party under your network service provider's support.

If call ID is disabled, the phone number shown or not in the call party depends on your network service provider's support. You cannot choose to send/hide your phone number to/from the calling party.

- 1) Press **Menu > Settings** and press **OK**
 - 2) Scroll **Call Setup** and press **OK**
 - 3) Select **Caller ID** and press **OK**
 - 4) Toggle **Set by Network**, **Hide Number** or **Show Number** and then press **OK**
- **Set By Network:** Accepts the default value set by Network.
 - **Show ID:** Shows your phone number to the calling party.
 - **Hide ID:** Does not show your phone number to the calling party.

[5] Network Setup

[5.1] Network Select mode

You can set the phone to automatically search the most suitable network to camp on or to manually select the network you need.

- 1) Press **Menu > Settings** and press **OK**
- 2) Scroll **Network Setup** and press **OK**
- 3) Select **Network Select mode** and press **OK**
- 4) Select **Automatic selection** or **Manual selection** and then press **OK**

Manual mode: The phone starts searching available networks. Use the up and down key to browse the network list, and press OK to set the highlighted networks

[5.2] Preferred Networks

You can set the phone to search the Preferred networks automatically by below steps.

- 1) Press **Menu > Settings** and press **OK**
- 2) Scroll **Network Setup** and press **OK**
- 3) Select **Preferred Networks** and press **OK**

[6] Security Setup

There are three options available:

- ➔ **SIM PIN** : Prevent unauthorized use of the SIM card and or the some features of services of telephone service provider
- ➔ **Phone Lock**: Prevent unauthorized use of the phone
- ➔ **Change Password** : Change by inputting the phone password two times

[6.1] SIM PIN

SIM PIN (SIM Personal Identification number) is a four-to-eight digit numeric or password. It is related with the service of your service provider. For more detail, contact your service provider.

- 1) Press **Menu > Settings** and press **OK**
 - 2) Scroll **Security Set Up** and press **OK**
 - 3) Select **SIM PIN** and press **OK**
 - 4) Select **PIN Check, Change PIN1, Change PIN2** and then press **OK**.
- ➔ **PIN Check** : Allow or disallow the use of SIM PIN by entering SIM PIN code
 - ➔ **Change PIN 1**: This is a pin code that locks the SIM card until you enter the correct code. The default code is set by the Service Provider. You can change it if you like by entering defaulted PIN code by Service provider, but make sure you

don't forget the new code

- **Change PIN 2:** This SIM card code controls access to some of the more advanced features of the phone. The default code is set by the Service Provider. You can change it if you like by entering defaulted PIN code by Service provider, but make sure you don't forget the new code. Not all networks support pin 2.

Caution: If you unsuccessfully enter the SIM PIN code some times depends on SIM card or country in succession the SIM card will be Locked. And then contact your telephone service provider to get PUK code to unlock SIM card.

[6.2] Phone Lock

The default password is "0000".

- 1) Press **Menu > Settings** and press **OK**
- 2) Scroll **Security Set Up** and press **OK**
- 3) Select **Phone Lock** and press **OK**
- 4) When 'On' is chosen, there are two options.
 - **Verify when Power-on:** Every time you must enter password when power on
 - **Verify with new SIM:** When you change SIM card, you enter the password

Change Password

This feature allows you to change the password.

- 1) Press **Menu > Settings** and press **OK**
- 2) Scroll **Security Setup** and press **OK**
- 3) Select **Change Password** and press **OK**

Note: You need to input three times. Old password, the new password and

confirmation. Every time you enter the input press OK

[7] Factory Default

This feature resets the current settings to the factory default values. The default phone code is "0000".

- 1) Press **Menu > Settings** and press **OK**
- 2) Select **Factory Default** and press **OK**
- 3) Enter the 4-digit password and press **OK**

Note: Before factory reset please save you important information!

APPLICATIONS

Applications include:

- ➔ **Alarm**
- ➔ **Calculator**
- ➔ **Calendar**
- ➔ **To Do List**

[1] Alarm

When alarm is set, the icon appears on the standby screen.

- 1) Press **Menu > Applications** and press **OK**
- 2) Select **Alarm** and press **OK**
- 3) Select Alarm 1 and or 2 and or 3 for setting alarm and Press **OK**
- 4) You can select four cases. Off//One time // Mon~Fri // Everyday. Select your favorite by scrolling left and right navigation key
- 5) After selecting one type, you can go down using up down navigation key and set the alarm time by pressing numeric key (time) and left right navigation key (am / pm).
- 6) After setting the time, you can go down using up down navigation key and choose alarm ring tone by pressing left and right key. There are 3 options of ring tone.
- 7) Press **Save**

[2] Calculator

You can calculate 9 digits.

Key description:

- ➔ +, -, /, x: Use left / right navigation keys to select.
- ➔ Clear: Press once to clear one digit.

➔ . (Point) : Press ' #' Key.

- 1) Press Menu > Applications and press OK
- 2) Select Calculator and press OK.
- 3) Enter the first value by number keys
- 4) Select the calculating mark by the left and right navigation keys.
- 5) The calculating mark will toggle among + , - , × , ÷ by turns
- 6) Enter the second value by number keys
- 7) Press Select to display the result of calculation. And you can press Select again to use calculated results in the next calculation.

[3] Calendar

You can examine the month and date by Navigation keys .

- 1) Press Menu > Applications and press OK
- 2) Select Calendar and press OK

[4] To Do List

- 1) Press Menu > Applications and press OK
- 2) Select To Do List and press OK.
- 3) Enter words and press Option, Select Add, Clear or Edit and press OK.
 - ➔ Add: Add new entry (s)
 - ➔ Clear: You can delete this entry
 - ➔ Edit: You can edit and save the chosen notice. You can set Time, date and Alarm Ring and then Save

REFERENCE INFORMATION

TECHNICAL INFORMATION

Technical Specification

Weight	Transceiver	138gram
	Cradle	140gram
Size	Transceiver	45mm(W)*170mm(L)*25mm(H)
	Cradle	88mm(W)*105.5mm(L)*60.5mm(H)
Wireless Network		850 / 1900 MHz
Frequency range		824~960MHz, 1710~1990MHz
Battery	Type	Rechargeable / Ni-MH
	Talk time	2 Hours
	Standby time	32 Hours
Antenna		Internal
LCD	Resolution	128*128 (pixel * pixel)
Cradle +Adapter	Type	AC
	Input Voltage	100 V ~ 240 V
	Output Voltage	5 V

* Above technical specification maybe changed without any notice

REGULATORY



Brightstar Corp. hereby declares this unit to be in compliance with the relevant Provisions of the Low Voltage Directive 73/23/EEC and the EMC Directive 89 / 336 / EEC.

Brightstar Corp. hereby declares this unit to be in compliance with the essential requirements and other relevant provisions of Directive 1999/5/EEC.

The FCC certification is applicable only for GP-857.

FCC NOTICE TO USERS

We have not approved any changes or modifications to this device by the user. Any changes or modifications could void the user's authority to operate the equipment. See 47 CFR Sec. 15.19(3).

This device complies with part 15 of the FCC Rules. Operation is subject to the following two conditions:

- 1) This device may not cause harmful interference, and
- 2) this device must accept any interference received, including interference that may cause undesired operation. See 47 CFR Sec. 15.19(3).

If your mobile device or accessory has a USB connector, or is otherwise considered a computer peripheral device whereby it can be connected to a computer for purposes of transferring data, then it is considered a Class B device and the following statement applies:

This equipment has been tested and found to comply with the limits for a Class B digital device, pursuant to part 15 of the FCC Rules. These limits are designed to provide reasonable protection against harmful interference in a residential installation.

This equipment generates uses and can radiate radio frequency energy and, if not installed and used in accordance with the instructions, may cause harmful interference to radio communications.

However, there is no guarantee that interference will not occur in a particular installation. If this equipment does cause harmful interference to radio or television reception, which can be determined by turning the equipment off and on, the user is encouraged to try to correct the interference by one or more of the following measures:

- Reorient or relocate the receiving antenna.
- Increase the separation between the equipment and the receiver.

- Connect the equipment to an outlet on a circuit different from that to which the receiver is connected.
- Consult the dealer or an experienced radio/TV technician for help.

RF Exposure Information and Statement

The SAR limit of USA (FCC) is 1.6 W/kg averaged over one gram of tissue. This model (FCC ID: WVB-FXC851L) has also been tested against this SAR limit. The highest SAR value reported under this standard during product certification for use at the ear is 1.012 W/kg and when properly worn on the body is 0.278 W/kg.

This device was tested for typical body-worn operations with the back of the handset kept 1.5cm from the body. To maintain compliance with FCC RF exposure requirements, use accessories that maintain a 1.5cm separation distance between the user's body and the back of the handset. The use of belt clips, holsters and similar accessories should not contain metallic components in its assembly. The use of accessories that do not satisfy these requirements may not comply with FCC RF exposure requirements, and should be avoided.

TROUBLE SHOOTING

Before contacting the after-sales service, perform the following simple checks. They may save you the time and expense of an unnecessary service call.

When you power your phone on, the following messages appear

Insert SIM Card

- Check that the SIM card is correctly installed. (Try opposite direction)

Phone Locked

- The automatic locking function has been enabled. You must enter the phone's password before you can use the phone.

Enter PIN

- You are using your phone for the first time. You must enter the Personal Identification Number supplied with the SIM card.
- The option requiring that the PIN be entered each time when the phone is powered on has been enabled. You must enter your PIN and then disable this option if so required.

Enter PUK

- The PIN code was entered wrongly some times depends on SIM card or Country in succession and the phone is now blocked. Enter the PUK supplied by your network operator.

“No service” is displayed

- The network connection was lost. You may be in a weak reception area (in a tunnel or

surrounded by buildings). Move and try again.

- You are trying to access an option for which you have not taken out a subscription with your service provider. Contact the service provider for further details.

You have entered a number but it was not dialed

- Have you pressed?
- Are you accessing the right cellular network?
- You may have set an outgoing call barring option.

Your correspondent cannot reach you

- Is your phone switched on (pressed for more than one second)?
- Are you accessing the right cellular network?
- You may have set an incoming call barring option.

Your correspondent cannot hear you speaking

- Have you switched off the microphone (appears)?
- Are you holding the phone close enough to your mouth? The microphone is located in the right side of front cover of the phone.

The audio quality of the call is poor

- Check the signal strength indicator in the display. The number of bars after it indicates the Signal strength from strong to weak.
- Try moving the phone slightly or moving closer to a window if you are in a building.

No number is dialed when you recall a phonebook entry

- Check that the numbers have been stored correctly, by using the Contacts Read feature.
- Re-store them, if necessary.

Access Codes

There are several access codes that are used by your phone and its SIM card. These codes help you protect the phone against unauthorized use.

The access codes (except for the PUK codes) can be changed using the Security Settings menu options.

Phone Password

The phone password can be set to avoid unauthorized use of the phone. The password generally supplied with the phone is 0000. You are advised to change it before you start using your phone.

Keep the new password secret and in a safe place, separate from the phone.

PIN

The PIN (Personal Identification Number) protects your SIM card against unauthorized use. The PIN is usually supplied with the SIM card. When the PIN Check feature is enabled, the PIN is needed each time the phone is powered on.

If you key in an incorrect PIN some times depends on SIM card or Country in succession, key in the PUK and press the OK soft key.

Key in a new PIN and press the OK soft key. Key in the new PIN again and press the OK soft key.

PUK

The PUK (Personal Unblocking Key) is required to change a blocked PIN. The PUK may be supplied with the SIM card. If not, contact your local service provider.

If you key in an incorrect PUK some times depends on SIM card or Country in succession, the SIM card cannot be used anymore.

Contact your service provider for a new card.

You cannot change the PUK.

User Manual of FXC-851L version 1.1 [ENG]

Copyright 2010, Motorola Inc., All rights reserved