

CT6540ARINC

Reference Guide v. 1.2



The picture is just for illustration and may differ from components supplied

This document and the information contained in it is the property of Broadcast Microwave Services Inc. and may be the subject of patents pending and granted. It must not be used for commercial purposes nor copied, disclosed, reproduced, stored in a retrieval system or transmitted in any form or by any means (electronic, mechanical, photocopying, recording or otherwise), whether in whole or in part, without prior written agreement issued by BMS.

Copyright © 2009 Broadcast Microwave Services, Inc. All rights reserved.

Broadcast Microwave Services Europe GmbH
Schwalbacherstraße 12
65321 Heidenrod, Germany

Tel: +49 (6124) 7239 00
Fax: +49 (6124) 7239 29

E-Mail: saleseurope@bms-inc.com
Internet: www.bms-inc.com

Broadcast Microwave Services, Inc.
12367 Crosthwaite Circle, Dock 10
Poway, CA 92064

Tel: +1 (858) 391-3050 • Toll-free (US): 800-669-9667
Fax: +1 (858) 391-3049

Email: support@bms-inc.com
Internet: www.bms-inc.com



Contents

1	About This Reference Guide	1
1.1	Read this first	1
1.2	Versions of this Reference Guide.....	3
1.3	Designation and P/N	3
2	Safety Warnings	4
2.1	Registered and General Trademarks	4
2.2	EMC Compliance	5
2.3	Compliance	5
2.4	C-Tick Marking	5
2.5	CE Marking.....	5
2.6	FCC Marking	5
2.7	RTCA/DO-160.....	5
3	Installing the Transmitter	6
3.1	ARINC Mounting Plate	7
3.2	Mounting Instructions	8
4	Dismounting the Transmitter	11
5	Controlling the System.....	12
6	Technical Specifications	16
6.1	CE Marking.....	16
6.2	FCC Marking	16
6.3	C-Tick Marking	17
6.4	Safety	17
6.5	Signal Parameters.....	18
6.6	Connectors Transmitter.....	19
6.7	Connectors Control Panel	21
6.8	Cabling and Connectors Overview.....	22
6.9	Cable DC for ARINC Control Panel.....	23
6.10	Cable CT6540ARINC (CONTROL) to ARINC Control Panel ...	23
6.11	Cable Actuator to ARINC Control Panel.....	24
6.12	Programming Cable for ARINC Control Panel	24

7	Warranty	25
8	Glossary	27
9	Index	31
10	Contact Information	33
	10.1 Customer Support	33
	10.2 Training Courses	33
	10.3 Claims	33

List of Figures

Figure 1: Ventilation Openings7

Figure 2: Mounting Plate Overview7

Figure 3: Retainer Locations.....8

Figure 4: Fixing the Transmitter8

Figure 5: Locking the Transmitter8

Figure 6: Mounted Transmitter9

Figure 7: CT6540ARINC Connector Panel9

Figure 8: Control panel connectors (with actuator control).....10

Figure 9: Control panel connector (without actuator control).....10

Figure 10: Control panel with actuator switch12

Figure 11: Control panel without actuator switch.....12

Figure 12: Cabling and Connectors Overview22

Figure 13: DC cabling for ARINC Control Panel (PT06SE-12-4S)23

Figure 14: CT6540ARINC to ARINC Control Panel cabling23

Figure 15: Actuator to Control Panel Cabling24

Figure 16: Programming Cable.....24

1 About This Reference Guide

This Reference Guide provides instructions and information on the installation and operation of the CT6540ARINC transmitter.

The Reference Guide should be stored in a safe place and remain readily available during the operational lifetime of the unit. It is not intended for this Reference Guide to be revised by issuing and replacing individual pages. Any revision will be done by a complete reissue. Additional copies of this Reference Guide can be ordered from the address shown on page 33. The equipment should only be passed on to a third party together with the relevant documentation.

For further information please visit our website at www.bms-inc.com

1.1 Read this first

DEUTSCH

LESEN SIE ZUERST DIESEN HINWEIS!

Sollte Ihnen der Inhalt dieses Handbuches nicht klar verständlich sein, dann bedienen Sie dieses Gerät nicht. Eine Übersetzung des Handbuchs in dieser Sprache ist gegen Berechnung lieferbar.

ENGLISH (UK)

Please read this first!

If you do not understand the contents of this manual: Do not operate this equipment. Also, translation of this manual into any EC official language can be made available, at your cost.

ITALIANO

LEGGERE QUESTO AVVISO PER PRIMO!

Se non si capisce il contenuto del presente manuale **NON UTILIZZARE L'APPARECCHIATURA**. È anche disponibile la versione italiana di questo manuale, ma il costo è a carico dell'utente.

ESPAÑOL

LEA ESTE AVISO PRIMERO!

Si no entiende el contenido de este manual **NO OPERE ESTE EQUIPO**. Podemos asimismo suministrarle una traducción de este manual al (idioma) previo pago de una cantidad adicional que deberá abonar usted mismo.

NEDERLANDS

LEES DIT EERST!

Als u de inhoud van deze handleiding niet begrijpt STEL DEZE APPARATUUR DAN NIET IN WERKING. U kunt tevens, op eigen kosten, een vertaling van deze handleiding krijgen.

DANSK

LÆS DETTE FØRST!

Udstyret må ikke betjenes MEDMINDRE DE TIL FULDE FORSTÅR INDHOLDET AF DENNE HÅNDBOG. Vi kan også for Deres regning levere en dansk oversættelse af denne håndbog.

SVENSKA

LÄS DETTA FÖRST!

Om Ni inte förstår informationen i denna handbok ARBETA DÅ INTE MED DENNA UTRUSTNING. En översättning till detta språk av denna handbok kan också anskaffas, på Er bekostnad.

PORTUGUÊS

LEIA O TEXTO ABAIXO ANTES DE MAIS NADA!

Se não compreende o texto deste manual NÃO UTILIZE O EQUIPAMENTO. O utilizador poderá também obter uma tradução do manual para o português à própria custa.

ΕΛΛΗΝΙΚΑ

ΔΙΑΒΑΣΤΕ ΠΡΩΤΑ ΑΥΤΟ!

Αν δεν καταλάβετε το περιεχόμενο αυτού του βοηθήματος/εγχειριδίου ΜΗΝ ΛΕΙΤΟΥΡΓΗΣΕΤΕ ΑΥΤΟΝ ΤΟΝ ΕΞΟΠΛΙΣΜΟ. Επίσης, αυτό το εγχειρίδιο είναι διαθέσιμο σε μετάφραση σε αυτή τη γλώσσα και μπορείτε να το αγοράσετε.

SUOMI

LUE ENNEN KÄYTTÖÄ!

Jos et ymmärrä käsikirjan sisältöä ÄLÄ KÄYTÄ LAITETTA. Käsikirja voidaan myös suomentaa asiakkaan kustannuksella.

FRANÇAIS

AVANT TOUT, LISEZ CE QUI SUIT!

Si vous ne comprenez pas les instructions contenues dans ce manuel NE FAITES PAS FONCTIONNER CET APPAREIL. En outre, nous pouvons vous proposer, à vos frais, une version française de ce manuel.

1.2 Versions of this Reference Guide

The releases of this reference guide are listed below

Release	Date	Version	Notes
1	July 2010	1.0	First edition
2	November 2010	1.1	FCC part added
3	May 2011	1.2	Part number correction

Note

Preliminary versions stated in the table refer to a superordinate number, which encompasses the different software and firmware versions for video and audio of the unit.

1.3 Designation and P/N

Designation	Frequency Range	P/N
CT6540ARINC	6425 – 6525 MHz	11.2535.100

2 Safety Warnings

Heed Warnings

All warnings on the product and in the operating instructions should be adhered to. The manufacturer can not be held responsible for injuries or damage where warnings and cautions have been ignored or taken lightly.

Read Instructions

All the safety and operating instructions should be read before this product is operated.

Follow Instructions

All operating and use instructions must be followed.

Retain Instructions

The safety and operating instructions should be retained for future reference.

Warning

Text boxes labelled as “Warning” give information, which, if strictly observed, will prevent PERSONAL INJURY OR DEATH, OR DAMAGE TO PERSONAL PROPERTY OR THE ENVIRONMENT.

They are boxed and shaded for emphasis, as in this example. They are placed immediately preceding the point at which the reader requires them.

Caution

Text boxes labelled as “Caution” give information which, if strictly followed, will prevent damage to equipment or other goods.

They are boxed and shaded for emphasis, as in this example. They are placed immediately preceding the point at which the reader requires them.

Note

Text boxes labelled as “Note” provide supplementary information. They are highlighted for emphasis, as in this example. They are placed immediately preceding the point at which the reader requires them.

2.1 Registered and General Trademarks

Best endeavours have been made to acknowledge registered trademarks and trademarks used throughout this Reference Guide. Any notified omissions will be

rectified in the next issue of this Reference Guide. Some trademarks may be registered in some countries, but not in others.

Registered trademarks and trademarks used are acknowledged below and marked with their respective symbols. They are not referenced within the text of this Reference Guide.

- ▶ AC-3®, Dolby Digital® and Pro Logic® are registered trademarks of Dolby Laboratories Licensing Corporation.
- ▶ Musicam® is a registered trademark of Thomson and Télédiffusion de France (TDF), Europe, and is a registered trademark of CCS (now Musicam USA Incorporated), USA.
- ▶ Ethernet® is a registered trademark of Xerox Corporation.
- ▶ XILINX® is a registered trademark of Xilinx Inc.
- ▶ Pozidriv™ is a trademark of European Industrial Services.
- ▶ Windows NT™ is a trademark of Microsoft Corporation.
- ▶ NDS™ is a trademark of NDS Limited.

2.2 EMC Compliance

The equipment has been designed to meet and has been tested against EMC standards. In order to maintain the certification in effect only original cables must be used. For any questions please contact our technical service. The address is given on page 33.

2.3 Compliance

This device complies with several standards. Please refer to chapter 6 for a complete list of standards.

2.4 C-Tick Marking

The CE mark is affixed to this device. Please refer to chapter 6 for further information.

2.5 CE Marking

The C-Tick mark is affixed to this device. Please refer to chapter 6 for further information.

2.6 FCC Marking

The FCC mark is affixed to this device. Please refer to chapter 6 for further information.

2.7 RTCA/DO-160

The device complies with requirements of RTCA/DO-160 according to Eurocopter Document SPX 9021 A 002 E01.

Note

Operators are advised to always confirm that their application complies with the requirements of the relevant frequency authority. Frequency allocations are subject to assignment by national or local authorities. Most require individual licences for operation. Contact details for EU authorities can be found at <http://ec.europa.eu/enterprise/rtte/spectr.htm>

3 Installing the Transmitter

Warning

The VDE01000 regulations must be observed during the installation and operation of the equipment.

Caution

- ▶ Protect the unit from wet and damp conditions.
- ▶ Avoid unnecessary jolting and movement during transportation and operation of the unit.
- ▶ Ensure that there is adequate ventilation during installation and operation to guarantee appropriate cooling of the unit.
- ▶ Before commencing operation, all necessary configuration of the CT6540ARINC should be concluded. Transmission efficiency should be exhaustively tested.
- ▶ All necessary cabling should be in place before the unit is switched on. Operating the transmitter without having the antenna connected may harm the device.
- ▶ A valid video signal must be present on the selected video input of the CT6540ARINC during switch on.
- ▶ Please ensure that the safety instructions are adhered to when you connect the CT6540ARINC. See the following chapters.

Warning

To ensure that the unit is vented properly, air circulation through the unit must be guaranteed. In any installation a minimum space of 20mm must be held over and underneath the housing.

If the unit is to be permanently mounted, active ventilation should be provided.

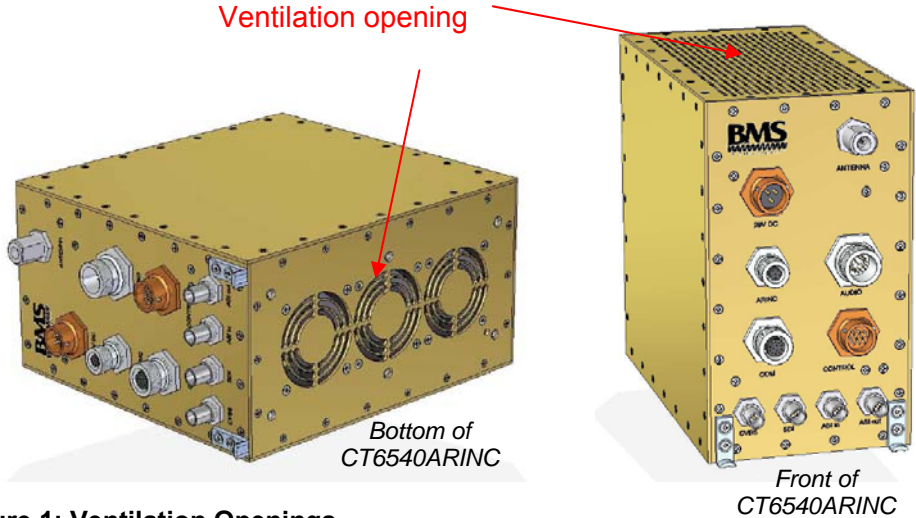

Figure 1: Ventilation Openings

Note
For helicopter installation it is recommended to use the CT6540ARINC mounting tray.

3.1 ARINC Mounting Plate

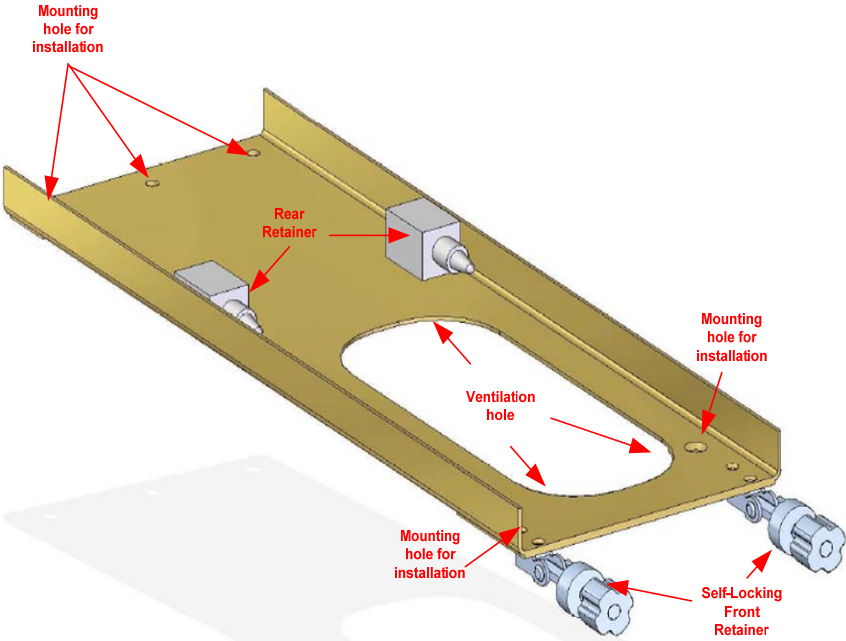

Figure 2: Mounting Plate Overview

The mounting plate disposes of five mounting holes. Two of them are to be found on the front end, the other three on the back end.

3.2 Mounting Instructions

► Fixing the mounting plate

1. Fix the mounting plate to the ground by drilling screws through the mounting holes.

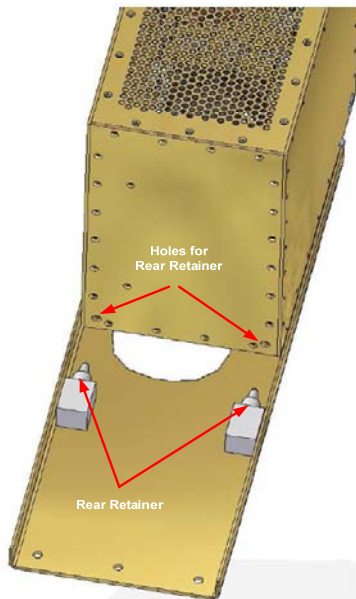

Figure 3: Retainer Locations

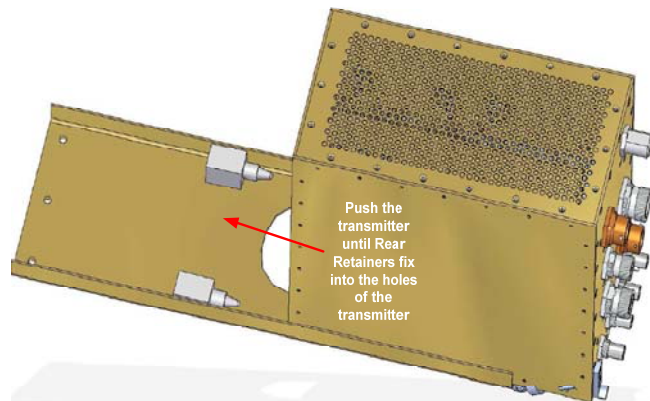

Figure 4: Fixing the Transmitter

► Fixing the transmitter to the mounting plate

2. Slide the transmitter into the mounting plate
3. Push the transmitter back until stabilised by the retainers

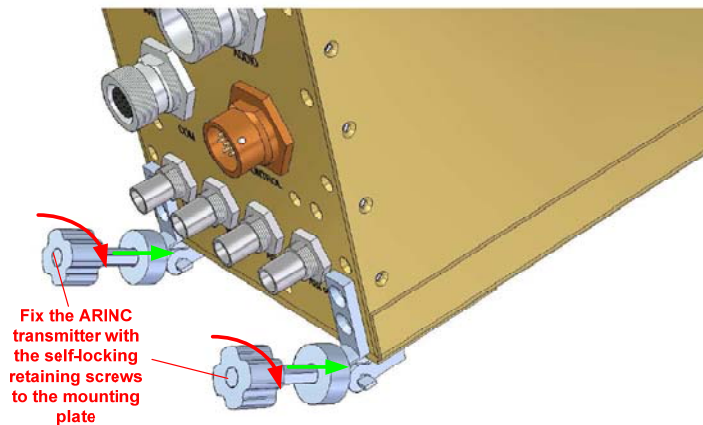

Figure 5: Locking the Transmitter

4. Lock the transmitter with the retaining screw

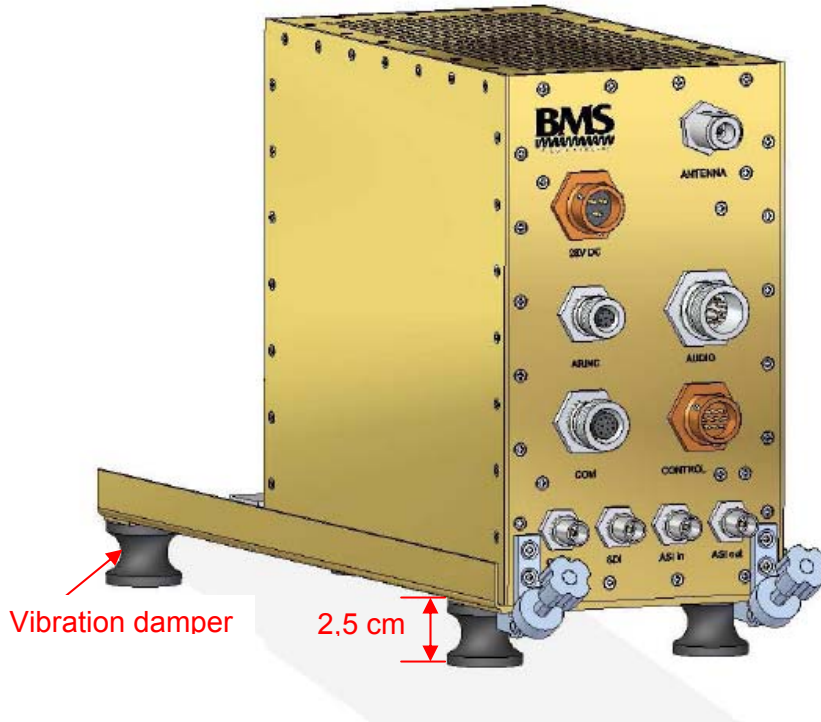

Figure 6: Mounted Transmitter

► **Cabling the transmitter**

Please refer to chapter Connectors Transmitter on page 19 for a detailed description of the connectors.



Figure 7: CT6540ARINC Connector Panel

5. Connect the antenna to the socket labelled "ANTENNA"
6. Connect the control panel to the socket labelled "CONTROL"

7. Connect available video source to the BNC sockets labelled “CVBS
8. Connect all available audio sources to the connector labelled “AUDIO”
9. Connect optional devices to the output labelled “ASI out” if necessary
10. Connect other devices to the sockets labelled “COM” and “ARINC” if necessary

Note

The ports “COM” and “ARINC” are subject of customised applications. Please refer to separate instructions.

► Installing the control panel

There are two types of control panels available. One version controls the antenna actuator, the other does not.

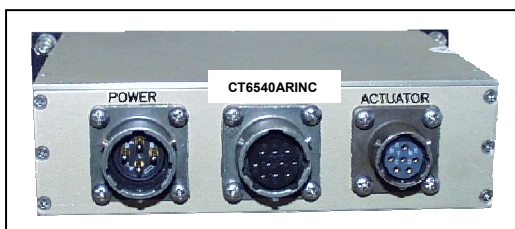

Figure 8: Control panel connectors (with actuator control)



Figure 9: Control panel connector (without actuator control)

11. Connect the antenna actuator cable to the socket labelled “ACTUATOR” if available
12. Connect the transmitter to the socket labelled “COM”
13. Connect the power supply to the socket labelled “POWER” if available
14. Fix the control panel in the cockpit centre console with the four retaining screws
15. After all connections are made securely, connect the power supply to the socket labelled “28V DC” transmitter

Caution

When using a power pack, make sure that the maximum supply current is at least 8 A and the output voltage matches the input voltage range of the CT6540ARINC transmitter.

Failure to comply with these requirements may cause fatal damage to the power pack and/or CT6540ARINC.

You must use original cables. If you have questions please contact BMS customer service.

Before connecting the 28V DC power supply cable, ensure all other equipment, esp. the antenna, is connected.

4 Dismounting the Transmitter

Before you start dismantling the system make sure it is powered down. Confirm that the power switch on the control panel is shifted to position "OFF".

▶ **Unplugging all cables**

1. Unplug the power cables of the transmitter and the control panel first
2. Unplug all remaining cables

▶ **Remove the components**

3. Release the retaining screws of the transmitter and the control panel
4. Remove the control panel and the transmitter

5 Controlling the System

The whole system is controlled through the control panel located in the cockpit. There are two types of control panels available. One version controls the antenna actuator, the other does not.



Figure 10: Control panel with actuator switch



Figure 11: Control panel without actuator switch

INBUILT DISPLAY

The inbuilt display show different configuration parameters, the current transmitter state, or alarm messages.

ROTARY KNOB

Use the rotary knob to select the different configuration parameters like “CH”, “SCRAMBL”, and “RF LEVEL”.

► Preset selection

1. Press the rotary knob labelled “TUNE” for approximately two seconds
2. Turn the knob until “CH” is shown
3. Press the knob for approximately two seconds
4. Turn the knob until the desired preset number is shown
5. The transmitter loads the settings
6. Press the rotary knob for approximately two seconds to select the loaded configuration

Note

If you press the rotary knob short the transmitter discards your selection.

Note

The programming of the different presets must be done through a computer and configuration software.

► Scrambling

1. Press the rotary knob labelled “TUNE” for approximately two seconds
2. Turn the knob until “SCRAMBL” is shown
3. Press the knob for approximately two seconds to activate or deactivate scrambling

4. Press the rotary knob for approximately two seconds to select the loaded configuration

Note

If you press the rotary knob short the transmitter discards your selection.

Note

If you change the scrambling mode of a preset this is only stored temporarily. For permanent activation resp. deactivation of scrambling use a computer and the configuration software.

▶ Power amplifier level

1. Press the rotary knob labelled "TUNE" for approximately two seconds
2. Turn the knob until "RF LEVEL" is shown
3. Press the knob for approximately two seconds to set the level of the power amplifier to low or high
4. Press the rotary knob for approximately two seconds to select the loaded configuration

Note

If you press the rotary knob short the transmitter discards your selection.

Note

By default RF power is set to high.

SYSTEM POWER SWITCH**▶ Power on the system**

Shift the switch to position "ON". The display lights up orange during initialisation phase. After approximately 10 seconds the display lights green.

Note

When switching on the system a valid video (and optionally audio) signal must be present on the selected input.

▶ Power off the system

Shift the switch to position "OFF". The display switches off. Now the CT6540ARINC transmitter is powered off.

RF POWER BUTTON

▶ Power on the power amplifier

When the power amplifier is turned off push the button labelled “RF” to switch on the power amplifier of the transmitter. The display lights green.

▶ Power off the power amplifier

When the power amplifier is turned on push the button labelled “RF” to switch on the power amplifier of the transmitter. The display lights orange.

Caution

Before switching on the power amplifier ensure the antenna is connected properly. Otherwise the transmitter may get damaged.

DIMMING THE DISPLAY

Press the button labelled “DIM” to reduce the brightness of the display.

Note

The control panel is night vision capable per MIL-L85762A and complies with MIL STD 3009.

ACTUATOR CONTROL (OPTIONAL)

▶ Stow antenna for landing

Shift the switch labelled “ACTUATOR” to the position “UP” in order to move the antenna to horizontal position and stow the antenna for landing. The green LED lights up

▶ Bring antenna into flight position

Shift the switch labelled “ACTUATOR” to the position “DOWN” in order to move the antenna to vertical position. The amber LED lights up. In this position the best transmission signal is achieved.

Caution

Before landing make sure the antenna is moved into horizontal position. Otherwise the antenna and/or actuator may get damaged.

Note

The actuator switch is secured. Before shifting pull it slightly and release it from the interlock.

PROGRAMMING THE TRANSMITTER

The connector labelled "REMOTE" on the control panel is used to connect a computer through a special cable.

The transmitter is pre-configured by BMS. In case that you desire to modify the settings of the transmitter please contact BMS customer service.

ALARMS

In case of malfunction those are indicated by the transmitter.

- ▶ "COM" alarm is shown when the communication between the transmitter and the control panel is missing. Switch the system off and check all cabling.
- ▶ "VIDEO FAIL" alarm is shown when no video signal is available on the video inputs. Check all cabling and make sure your video source is working properly.
- ▶ "ANT FAIL" alarm is shown when the antenna is not working properly or not connected. Check the antenna cabling.

Caution

If there is no antenna connected to the transmitter the system may get damaged.

- ▶ "RF FAIL" alarm is shown when the power amplifier does not work properly or the system is overheating. Make sure cooling air flows properly and the ventilation openings are not choking.

Note

If the problem persists please contact BMS customer service.

6 Technical Specifications

Technical specifications of the CT6540ARINC transmitter

6.1 CE Marking

	<p>The CE mark is affixed to indicate compliance with the following directives:</p> <p>89/336/EEC of 3 May 1989 on the approximation of the laws of the Member States relating to electromagnetic compatibility.</p> <p>2006/95/EEC of January 2007 on the harmonisation of the laws of the Member States relating to electrical equipment designed for use within certain voltage limits.</p> <p>Complies with the essential requirements and provisions of the Directive 1999/5/EC of the European Parliament and of the council of March 9, 1999 (R & TTE Directive).</p>
---	--

6.2 FCC Marking

	<p>VFB-CT6540ARI6466</p> <p>This equipment has been tested and found to comply with the limits for Class B digital devices pursuant to Part 15 of the FCC Rules and ICES-003 of industry Canada. This equipment generates, uses, and can radiate radio frequency energy, and if not installed and used in accordance with the instruction manual, may cause harmful interference to radio communications. However, there is no guarantee that interference will not occur in a particular installation. If this equipment does cause harmful interference to radio or television reception, which can be determined by turning the equipment off and on, the user is encouraged to try and correct the interference by one or more of the following measures:</p> <ul style="list-style-type: none"> • Reorient or relocate the receiving antenna. • Increase the separation between the equipment and the receiver. • Connect the equipment to an outlet on a circuit different from that to which the receiver is connected. • Consult the dealer or an experienced radio/TV technician for help.
--	---

6.3 C-Tick Marking

	The C-Tick mark is affixed to denote compliance with the Australian Radiocommunications (Compliance and Labelling – Incidental Emissions) Notice made under s.182 of Radiocommunications Act 1992.
---	--

6.4 Safety





The equipment has been designed and tested to meet the following standards:

- ▶ EN 60950
- ▶ IEC 60950

6.5 Signal Parameters

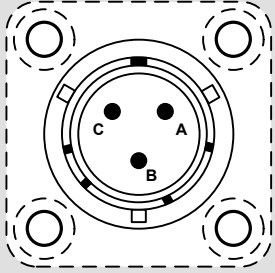
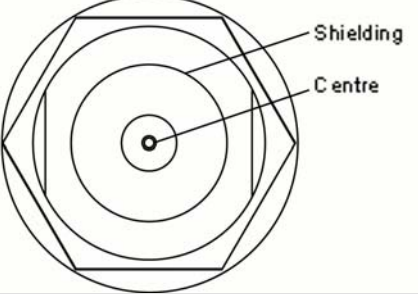
Frequency Range	6425 - 6525 MHz (P/N 11.2535.100)	N male 50 Ω
RF Power	<ul style="list-style-type: none"> ▶ 5 W (37dBm) ▶ 10 W (40dBm) (switchable)	
Video Input	▶ CVBS (PAL and NTCS)	BNC 75 Ω
Transport Stream Input	▶ ASI transport stream (optional)	BNC 75 Ω
Transport Stream Output	▶ ASI transport stream (optional)	BNC 75 Ω
Audio Input	▶ 1x Analogue audio pair in (Line or Mic Level)	+6 dBu 600 Ω
Video Coding	MPEG-2	
Audio Coding	MPEG-2 Layer 2	
Modulation	COFDM, ETS 300744, 2k carriers Bandwidth 8 MHz <ul style="list-style-type: none"> ▶ QPSK ▶ 16QAM ▶ 64QAM 	
Power Supply	28V DC	
Power Consumption	< 350 W	
Environmental Conditions	-10°C to +50°C at 5% - 95% humidity	
Dimensions (HxWxD)	216mm x 124mm x 250mm	
Weight	5.5 kg	
Dimensions Control Panel (HxWxD)	38mm x 146mm x 106mm	
Weight Control Panel	0.5 kg	

6.6 Connectors Transmitter

	<p>Power Input</p> <p>3-pin SOURIAU (male), 851-02R12-3P50</p> <ul style="list-style-type: none"> A. 28V DC B. GND C. n.c.
	<p>RF output</p> <p>N connector (female), 50 Ω</p> <p>Centre Signal</p> <p>Shielding GND</p>
	<p>ARINC</p> <p>D38999-26WA35SN</p> <ul style="list-style-type: none"> 1. Data TX+ 2. Data TX- 3. Data RX+ 4. Data RX- 5. GPS Data GND 6. GPS Data RX
	<p>Com</p> <p>D38999-26WA35SN</p> <ul style="list-style-type: none"> 1. Config Data GND 2. Config Data TX 3. Config Data RX- 4. - 13. Do not use
	<p>Audio</p> <p>D38999-26WC35PN</p> <ul style="list-style-type: none"> 1. Audio 1L GND 2. Audio 1L+ 3. Audio 1L- 4. Audio 1R GND 5. Audio 1R+ 6. Audio 1R- 7. - 12. n.c. 13. - 22. Do not use

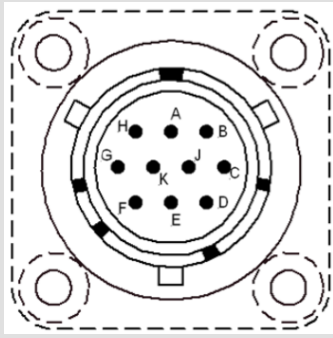

Control Panel

10-pin SOURIAU (male)

- A. On/Off A 28V DC out
- B. On/Off B 28V DC out
- C. n.c.
- D. Data RX
- E. Data GND
- F. Data TX
- G. GND 28V
- H. RC sense
- I. n.c.
- J. n.c.

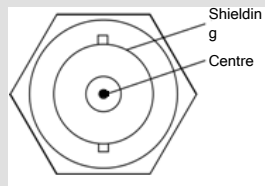

Video input (CVBS, ASI)

BMC connector, 75Ω

- Centre Signal
- Shielding GND

6.7 Connectors Control Panel

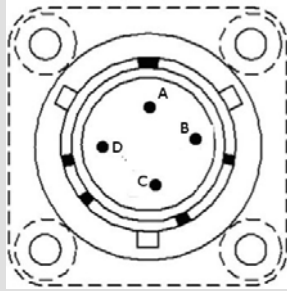

Power Input

4-pin SOURIAU (male)

- A. 28 - 32V DC
- B. Do not connect
- C. GND
- D. n.c..

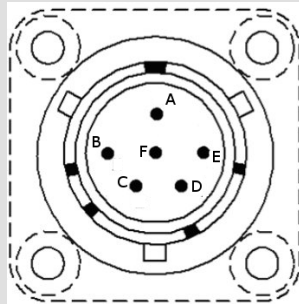

Actuator (optional)

6-pin SOURIAU (female)

- A. Actuator up indicator
- B. n.c.
- C. Actuator down command
- D. Actuator up command
- E. Actuator down indicator
- F. n.c.

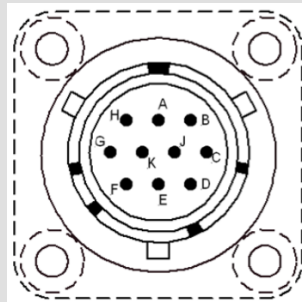

Transmitter

10-pin SOURIAU (Female)

- A. Data RX
- B. Data TX
- C. GND
- D. 5V switched
- E. - K- Do not connect

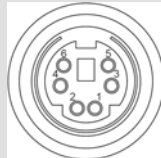

Programming

MD-60SV

1. PC Status
2. PC Command
3. GND
4. RC Busy
5. RC Sense
6. +5V DC

6.9 Cable DC for ARINC Control Panel

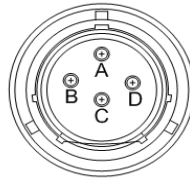

A	28-32V DC
B	N.C.*
C	GND
D	N.C.

* Please do not connect

Figure 13: DC cabling for ARINC Control Panel (PT06SE-12-4S)

6.10 Cable CT6540ARINC (CONTROL) to ARINC Control Panel

851-06RC12-10S50

PT06SE-10-98P

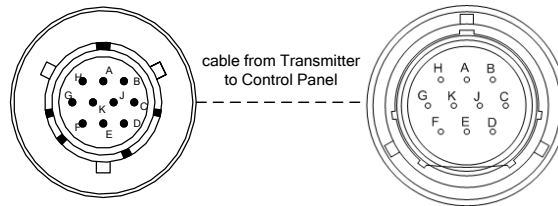

From CT6540ARINC	A	ON/OFF A (28V out)	A	To Control Panel	
	B	ON/OFF B (28V out)	B		
	C	N.C.	N.C.		C
	D	Data RX	D		
	E	Data GND	E		
	F	DataTX	F		
	G	GND 28VDC	G		
	H	RC Sense	H		
	J	N.C.	N.C.*		J
	K	N.C.	N.C.*		K

Figure 14: CT6540ARINC to ARINC Control Panel cabling

6.11 Cable Actuator to ARINC Control Panel

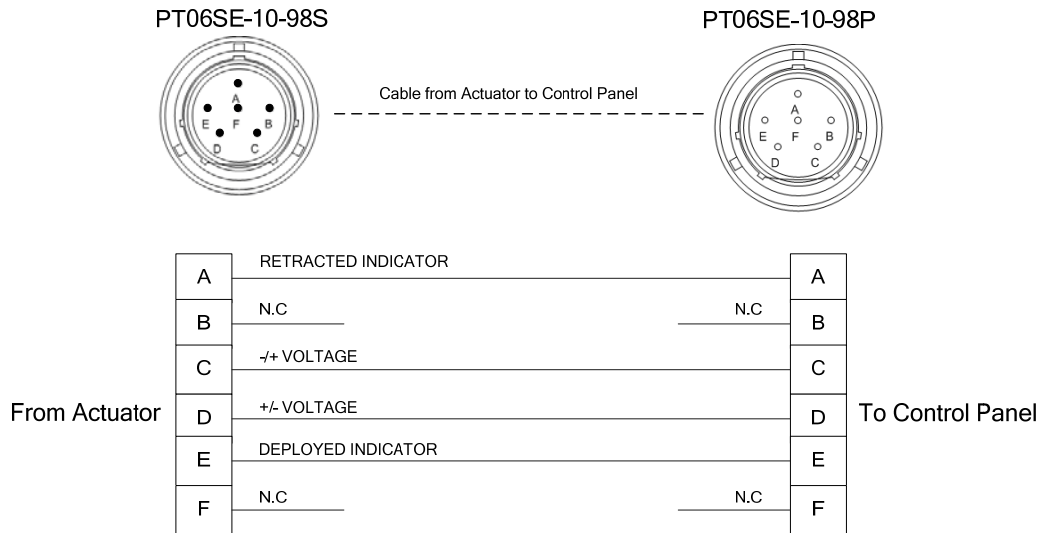

Figure 15: Actuator to Control Panel Cabling

6.12 Programming Cable for ARINC Control Panel

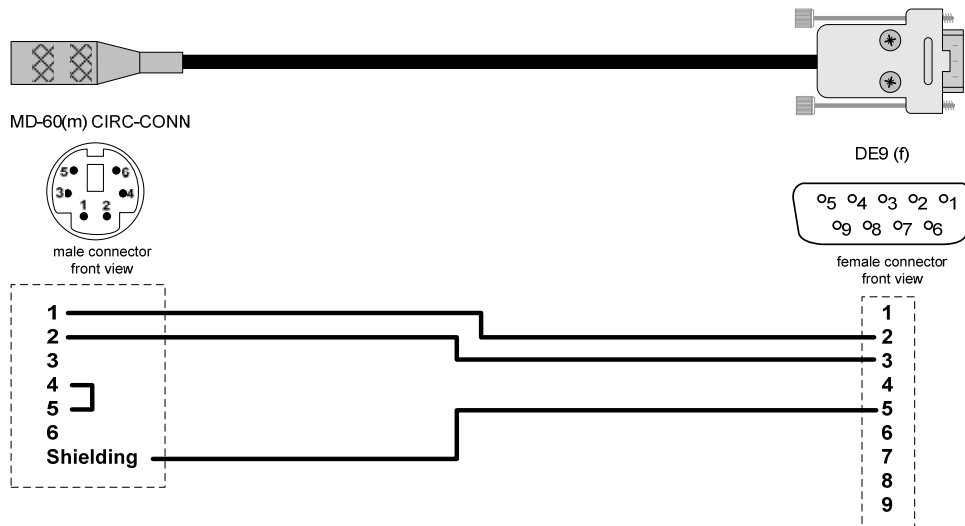

Figure 16: Programming Cable

7 Warranty

All products and systems of Broadcast Microwave Services Europe GmbH are designed and built to the highest standards and are covered under a comprehensive 12 month warranty.

The warranty period starts on the day of delivery ex works Heidenrod. Warranty is only granted to systems under conditions as supplied to the customer. We do not support any modified systems. This includes any damage caused by the use of software not certified by BMS.

8 Glossary

4:2:0

Digital video coding process.. Chrominance levels are sampled in line alternation mode with reduces bandwidth.

4:2:2

Digital video coding process.. Chrominance levels of all lines are sampled with reduces bandwidth.

A

ABS

32-bit ABS encryption standard

AES

Advanced Encryption Standard, a Federal Information Processing Standard (FIPS), is an algorithm to reduce electronic data. It processes block ciphers.

ASCII

ASCII, **American Standard Code for Information Interchange**, a character encoding scheme.

ASI

ASI, **Asynchronous Serial Interface**, is a data format used to carry MPEG data streams. An ASI stream may contain one or more video and/or audio streams.

B

BNC

Bayonet Neill-Concelman, Coaxial connector.

C

COFDM

Coded Orthogonal Frequency Division Multiplex is a standard for terrestrial digital TV transmission.

COMPOSITE

(see DVBS)

CVBS

Colour Video Baseband Signal is an analogue video signal carrying colour and luminance information within one signal.

D

D-ENG

Digital Electronic News Gathering is a standard for digital video and audio transmission in the broadcast industry..

DVB-T

Digital Video Broadcasting Terrestrial, digital TV transmission standard.

E

EMC

ElectroMagnetic Compatibility, labels that electromagnetic devices do not have a negative impact on other electromagnetic devices.

ETS

European Telecommunications Standard

F

FEC

Forward Error Correction, algorithm used to reduce error rates in digital data transmission.

FM

Frequency Modulation, analogue modulation technique.

H

HDMI

High Definition Multimedia Interface is an interface for digital video.

I

IEC

International Electrotechnical Committee

IF

Intermediate Frequency, mixes frequencies up or down to other frequencies.

ISO

International Standards Organisation

K

KBIT/S

Kilobits per seconds (1000 bits per second).

L

LINEAR POWER AMPLIFIER

A linear power amplifier amplifies the output signal of a modulator up to a level of 1W (appr. 30 dBm).

M

MBIT/S

Megabits per second (1000000 bits per second).

MP@ML

Main Profile at Main Level is a part of the MPEG-2 standards for storage or transmission of video feeds of up to 15 Mbit/s

MPEG

Motion Pictures Experts Group is a standard organisation developing video compression techniques.

N

NTSC

National Television Systems Committee is an analogue television

standard mainly used in the USA and Latin-American countries.

O

OFDM

Orthogonal Frequency Division Multiplex is bandwidth efficient modulation technique.

P

PAL

Phase Alternation Line is an analogue television standard mainly used in Europe.

PC

Personal Computer

PCM

Pulse Code Modulation is a technique used to digitize analogue signals.

Q

QAM

Quadrature Amplitude Modulation is a modulation technique used to transmit digital signals.

QPSK

Quadrature Phase Shift Keying is a modulation technique used to transmit digital signals..

R

RF

Radio Frequency

RGB

Red, Green, Blue are the primary colours used in video applications.

RS-232

RS-232 is a serial bi-directional asynchronous interface for wired data transmission.

S

SDI

Serial Digital Interface is an interface for digital video and audio transmission.

SMA

SubMiniature A is a coaxial connector used to mount antennae.

S-VIDEO

Separated Video is a video signal with different signals for luminance and chrominance.

T

TS

Transport Stream is a data stream format used by MPEG.

U

USB

Universal Serial Bus is a 4-pole connection for data transfer between devices.

V

VDE

Verband Der Elektrotechnik e.V. is a German association for electrical and electronic technologies.

X

XLR

XLR (Screen Life Return) is a connector of three or more poles.

Y

Y/C

Y (luminance) and C (chrominance), see **S-Video**.

YUV

YUV is a video signal with different signals for luminance and chrominance components

9 Index

A

About This Reference Guide	1
ABS	27
Actuator to Control Panel	25
AES	27
ARINC Mounting Plate	8
ASCII	27
ASI	27

B

BNC	27
-----------	----

C

Cabling and Connectors Overview	23
CE Marking	6, 18
Claims	33
COFDM	27
Compliance	6
COMPOSITE	27
Connectors Control Panel	22
Connectors Transmitter	20
Contact Information	33
Controlling the System	14
C-Tick Marking	6, 18
Customer Support	33
CVBS	27

D

D-ENG	27
Designation and P/N	3
Dismounting the Transmitter	12
DVB-T	27

E

EMC	27
EMC Compliance	6
ETS	27

F

FEC	27
FM	27

H

HDMI	27
------------	----

I

IEC	28
IF	28
Installing the Transmitter	7
ISO	28

K

KBIT/S	28
--------------	----

L

LINEAR POWER AMPLIFIER	28
------------------------------	----

M

MBIT/S	28
Mounting Instructions	9
MP@ML	28
MPEG	28

N

NTSC	28
------------	----

O

OFDM	28
------------	----

P

PAL	28
PC	28
PCM	28
Power Connector	24
Programming Cable	25

Q

QAM	28
QPSK	28

R

Read this first	1
Registered and General Trademarks	5
RF	28
RGB	28
RS-232	28
RTCA/DO-160	6

S

Safety	18
Safety Warnings	5
SDI	29
Signal Parameters	19
SMA	29
S-VIDEO	29

T

Technical Specifications	18
Training Courses	33
Transmitter to Control Panel	24
TS	29

U

USB	29
-----------	----

V

VDE.....	29
Versions of this Reference Guide ...	3

W

Warranty.....	26
---------------	----

X

XLR	29
-----------	----

Y

Y/C	29
YUV	29

10 Contact Information

For further information about training courses, technical publications, customer support request or any other objective please contact BMS Europe at:

Broadcast Microwave Services Europe GmbH
Schwalbacherstraße 12
65321 Heidenrod, Germany

Tel: +49 (6124) 7239 00

Fax: +49 (6124) 7239 29

E-Mail: saleseurope@bms-inc.com

Internet: www.bms-inc.com

10.1 Customer Support

Our primary objective is to provide first class customer care that is tailored to your specific business and operational requirements. All service levels are supported by one or more service performance reviews to ensure the perfect partnership between Broadcast Microwave Services and your business.

10.2 Training Courses

BMS Europe provide a wide range of training courses on the operation and maintenance of our products and on their supporting technologies. BMS can provide both regularly scheduled courses and training tailored to individual needs. Courses can be run either at your premises or at one of our dedicated training facilities.

10.3 Claims

In the unlikely event of failures on our products please get in contact with our customer service at your earliest convenience. In case that the equipment has to be repaired in our repair centre we will provide you with an RMA number.

Please fill out all required information and send the RMA form along with the failed part to the above given address.