HP Notebook PC

Reference Guide

Notice

This manual and any examples contained herein are provided “as is” and are subject to change without notice. Hewlett-Packard Company makes no warranty of any kind with regard to this manual, including, but not limited to, the implied warranties of merchantability and fitness for a particular purpose. Hewlett-Packard Co. shall not be liable for any errors or for incidental or consequential damages in connection with the furnishing, performance, or use of this manual or the examples herein.

© Copyright Hewlett-Packard Company 2003. All rights reserved.

Reproduction, adaptation, or translation of this manual is prohibited without prior written permission of Hewlett-Packard Company, except as allowed under the copyright laws.

The programs that control this product are copyrighted and all rights are reserved. Reproduction, adaptation, or translation of those programs without prior written permission of Hewlett-Packard Co. is also prohibited.

Portions of the programs that control this product may also be copyrighted by Microsoft Corporation, Phoenix Technologies, Ltd., ATI Technologies Inc., Intel Corporation, and Adobe Systems Incorporated. See the individual programs for additional copyright notices.

This product incorporates copyright protection technology that is protected by method claims of certain U.S. patents and other intellectual property rights owned by Macrovision Corporation and other rights owners. Use of this copyright protection technology must be authorized by Macrovision Corporation and is intended for home and other limited viewing uses only unless otherwise authorized by Macrovision Corporation. Reverse engineering or disassembly is prohibited.

Microsoft®, MS-DOS®, and Windows® are U.S. registered trademarks of Microsoft Corporation. Pentium® and the Intel Inside logo are U.S. registered trademarks and Celeron™ and SpeedStep™ are U.S. trademarks of Intel Corporation. Adobe® and Acrobat® are trademarks of Adobe Systems Incorporated.

Reference Guide

Second Edition (March 2003)

Part Number: 311074-002

Important Safety Information

CAUTION

To reduce the risk of fire, use only No. 26 AWG or larger telecommunications line cord to connect a modem to the telephone wall jack. In Australia, the computer must be connected to the Telecommunication Network through a line cord that meets the requirements of ACA Technical Standard TS008.

When using your notebook computer with a telephone connection, always follow basic safety precautions to reduce the risk of fire, electrical shock, and injury to persons:

- Do not use this product with a telephone connection near water (for example, near a bathtub, sink, swimming pool, or in a wet basement).
- Avoid using a telephone connection (other than a cordless type) during an electrical storm. There may be a remote risk of electrical shock from lightning.
- Do not use a telephone connection to report a gas leak in the vicinity of the leak.
- Use only the power cord and batteries indicated in this guide. Do not dispose of batteries in a fire. They may explode. Check with local codes for possible special disposal instructions.
- Disconnect the modem cable before opening the computer case or touching an uninsulated modem cable, jack, or internal component.
- Do not plug a modem cable or telephone cable into the network (LAN) receptacle.

HP Software Product License Agreement

Your HP product contains software programs. CAREFULLY READ THIS LICENSE AGREEMENT BEFORE PROCEEDING TO OPERATE THIS EQUIPMENT. RIGHTS IN THE SOFTWARE ARE OFFERED ONLY ON THE CONDITION THAT THE CUSTOMER AGREES TO ALL TERMS AND CONDITIONS OF THE LICENSE AGREEMENT. PROCEEDING TO OPERATE THE EQUIPMENT INDICATES YOUR ACCEPTANCE OF THESE TERMS AND CONDITIONS. IF YOU DO NOT AGREE WITH THE TERMS OF THE LICENSE AGREEMENT, YOU MUST NOW EITHER REMOVE THE SOFTWARE FROM YOUR HARD DRIVE AND DESTROY THE MASTER DISKETTES, OR RETURN THE COMPLETE HP PRODUCT AND SOFTWARE FOR A FULL REFUND. PROCEEDING WITH CONFIGURATION SIGNIFIES YOUR ACCEPTANCE OF THE LICENSE TERMS.

UNLESS OTHERWISE STATED BELOW, THIS HP SOFTWARE LICENSE AGREEMENT SHALL GOVERN THE USE OF ALL SOFTWARE THAT IS PROVIDED TO YOU AS PART OF THE HP PRODUCT AND SHALL SUPERSEDE ANY OTHER SOFTWARE WARRANTY STATEMENT THAT MAY BE INCLUDED IN THIS HP PRODUCT OR MAY BE FOUND ONLINE.

Operating system and software applications by Microsoft are licensed to you under the Microsoft License Agreement contained in the Microsoft documentation or displayed on your screen when Microsoft Software Products are launched.

For a PC supplied with a Microsoft operating system: When you start the PC and accept the Microsoft End-user License Agreement (“EULA”), your license rights are valid only if a Certificate of Authenticity (“COA”) label corresponding to your Microsoft operating system is provided with your PC. The COA label can usually be found on the bottom of the computer. If the COA label does not correspond to your Microsoft operating system or is missing, contact your HP reseller for details.

Other non-HP Software and Operating Systems are covered by the appropriate vendor license. The following License Terms govern the use of the HP software:

USE. Customer may use the software on any one HP product. Customer may not network the software or otherwise use it on more than one HP product. Customer may not reverse assemble or decompile the software unless authorized by law.

COPIES AND ADAPTATIONS. Customer may make copies or adaptations of the software (a) for archival purposes or (b) when copying or adaptation is an essential step in the use of the software with an HP product so long as the copies and adaptations are used in no other manner.

OWNERSHIP. Customer agrees that he/she does not have any title or ownership of the software, other than ownership of the physical media. Customer acknowledges and agrees that the software is copyrighted and protected under the copyright laws. Customer acknowledges and agrees that the software may have been developed by a third party software supplier named in the copyright notices included with the software, who shall be authorized to hold the Customer responsible for any copyright infringement or violation of this Agreement.

PRODUCT RECOVERY CD-ROM OR DVD. If your HP product was shipped with a product recovery CD-ROM or DVD: (i) The product recovery CD-ROM or DVD and/or support utility software may only be used for restoring the hard disk of the HP product with which the product recovery CD-ROM or DVD was originally provided. (ii) The use of any operating system software by Microsoft contained in any such product recovery CD-ROM or DVD shall be governed by the Microsoft License Agreement.

TRANSFER OF RIGHTS IN SOFTWARE. Customer may transfer rights in the software to a third party only as part of the transfer of all rights and only if Customer obtains the prior agreement of the third party to be bound by the terms of this License Agreement. Upon such a transfer, Customer agrees that his/her rights in the software are terminated and that he/she will either destroy his/her copies and adaptations or deliver them to the third party.

SUBLICENSING AND DISTRIBUTION. Customer may not lease, sublicense the software, or distribute copies or adaptations of the software to the public in physical media or by telecommunication without the prior written consent of Hewlett-Packard.

TERMINATION. Hewlett-Packard may terminate this software license for failure to comply with any of these terms provided Hewlett-Packard has requested Customer to cure the failure and Customer has failed to do so within thirty (30) days of such notice.

UPDATES AND UPGRADES. Customer agrees that the software does not include updates and upgrades which may be available from Hewlett-Packard under a separate support agreement.

EXPORT CLAUSE. Customer agrees not to export or re-export the software or any copy or adaptation in violation of the U.S. Export Administration regulations or other applicable regulation.

U.S. GOVERNMENT RESTRICTED RIGHTS. Use, duplication, or disclosure is subject to HP standard commercial license terms and for non-DOD Departments and Agencies of the U.S. Government, the restrictions set forth in FAR 52.227-19(c)(1-2) (June 1987) Hewlett-Packard Company, 3000 Hanover Street, Palo Alto, CA 94304 U.S.A. Copyright (c) 2000 Hewlett-Packard Company. All Rights Reserved. Customer further agrees that Software is delivered and licensed as “Commercial computer software” as defined in DFARS 252-227-7014 (June 1995) or as a “commercial item” as defined in FAR 2.101(a), or as “Restricted computer software” as defined in FAR 52.227-19 (or any equivalent agency regulation or contract clause), whichever is applicable. The Customer agrees that it has only those rights provided for such Software by the applicable FAR or DFARS clause or the HP standard software agreement for the product involved.

SUPPORT POLICY FOR MICROSOFT OPERATING SYSTEMS SERVICE PACK. HP will provide end user support for HP PCs that use Microsoft Operating Systems, including its latest service packs. This support will be available 30 days after the service pack being released by Microsoft.

Contents

Getting Started with Your Notebook	1
Identifying Parts of the Notebook	2
Front panel and right panel components.....	2
Left panel and back panel components.....	4
Bottom panel components	6
Status lights.....	8
Setting Up Your Notebook.....	10
Step 1: Insert the battery	10
Step 2: Connect AC power	11
Step 3: Connect a phone line	12
Step 4: Turn on the notebook	13
Step 5: Set up Windows.....	13
Basic Operation	15
Operating Your Notebook	16
Default power settings	16
To reset the notebook.....	17
To change the boot device	17
To use the TouchPad	18
To use the function hot keys.....	19
To use the One-Touch buttons.....	20
To use the Windows and Applications keys.....	21
To use the ALT GR key	21
Using CDs or DVDs	22
To insert or remove a CD or DVD	22
To play DVD movies.....	23
To create or copy CDs	23
Securing Your Notebook.....	24
To set up password protection	24
To lock your notebook.....	24
To attach a security cable	25
To protect against viruses	25
To lock the hard drive.....	26

Taking Care of Your Notebook.....	27
To protect your hard drive.....	27
To maintain your notebook.....	27
To safeguard your data.....	28
To extend the life of the display.....	28
To clean your notebook.....	28
Batteries and Power Management.....	29
Managing Power Consumption.....	30
How the notebook manages power automatically.....	30
Using Battery Power.....	32
To check battery status.....	32
To respond to a low-battery warning.....	33
To recharge the battery.....	33
To get the most from your batteries.....	34
Modem and Network Connections.....	35
Using the Modem.....	36
To connect the modem.....	37
To change your modem settings.....	38
Connecting to a Local Area Network (LAN).....	39
Making Wireless Network Connections (select models only).....	40
To prepare for connections.....	40
To turn wireless communication on and off.....	42
Making Wireless Bluetooth Connections (select models only).....	44
To turn Bluetooth communication on and off.....	44
To prepare for Bluetooth connections.....	45
To send or receive files using Bluetooth.....	46
Add-On Devices.....	47
Connecting PC Cards.....	48
To insert or remove a PC Card.....	48
Connecting External Devices.....	50
To connect an audio device.....	50
To use an external monitor.....	52
To connect an IEEE 1394 device (select models only).....	53
To connect an infrared device (select models only).....	54
To use a port replicator (select models only).....	55
Installing Additional RAM (Memory).....	58
To install a RAM expansion module.....	58
To remove a RAM expansion module.....	60

Replacing the Hard Drive.....	62
To replace the hard drive	62
To replace the hard drive holder.....	63
To prepare a new hard drive	64
Troubleshooting and Maintenance.....	65
Troubleshooting Your Notebook.....	66
Audio problems	66
CD-ROM and DVD problems.....	67
Display problems	68
Hard drive problems	69
Heat problems.....	70
Infrared problems.....	70
Keyboard and pointing device problems.....	71
Local area network (LAN) problems.....	72
Memory problems.....	73
Modem problems.....	73
PC Card problems.....	76
Performance problems.....	76
Power and battery problems	77
Printing problems.....	79
Serial, parallel, and USB problems	80
Startup problems.....	81
Wireless problems	82
Configuring Your Notebook	84
To run the BIOS Setup utility.....	84
To change video memory settings using BIOS Setup utility	87
Reinstalling and Updating Software.....	88
To replace a damaged <i>QuickRestore System Recovery</i> CD.....	88
Reference Information.....	89
Modem Reference Information	90
Modem Reference (Conexant).....	90
Safety Information.....	97
Power cords	97
Battery safety	98
Laser safety.....	98
LED safety	99
Mercury safety.....	99
Exposure to radio frequency radiation.....	100

Regulatory Information	101
U.S.A.	101
Canada	103
European Union	104
Japan	106
New Zealand	107
Russia	108
International	108
Index	111

Getting Started with Your Notebook

Identifying Parts of the Notebook

Components included with the notebook vary by geographical region and features selected. The following illustrations identify the standard external components included with most notebook models.

Find the illustrations that match your notebook to identify your components.

Front panel and right panel components

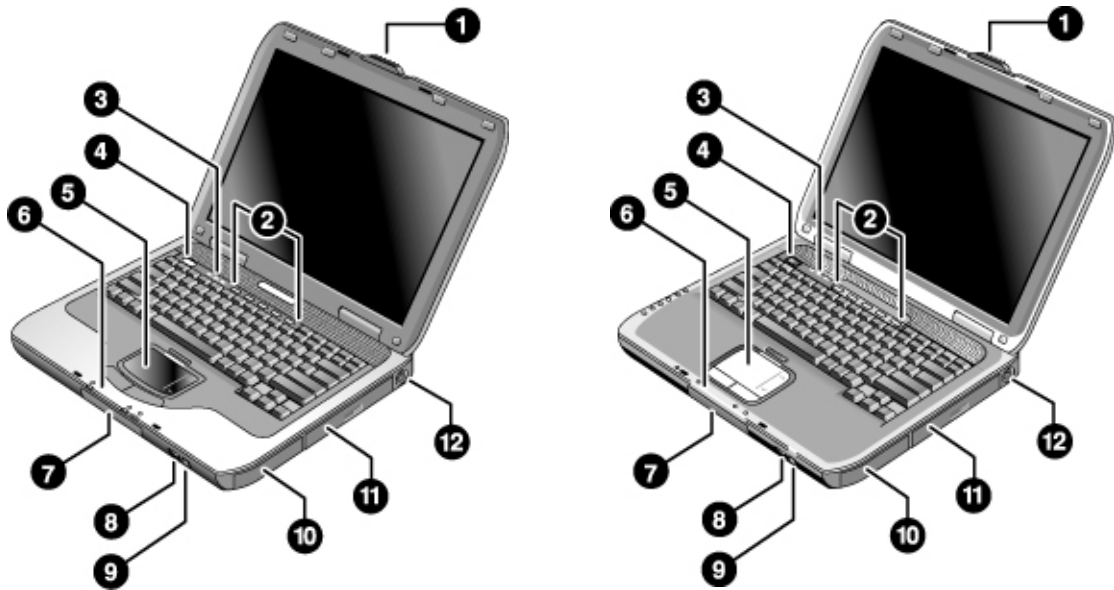

- | | |
|--|---|
| 1 Notebook open/close latch | 7 Hard drive |
| 2 One-Touch buttons | 8 Infrared port (select models only) |
| 3 Keyboard status lights | 9 Wireless on-off button and indicator light (select models only) |
| 4 Power button: turns the notebook on and off | 10 Battery |
| 5 TouchPad, scroll pad, Click buttons, and an on-off button | 11 CD-ROM, DVD, or other drive |
| 6 Main status lights (left to right): power mode, hard drive activity, and battery | 12 PS/2 port |

Getting Started with Your Notebook Identifying Parts of the Notebook

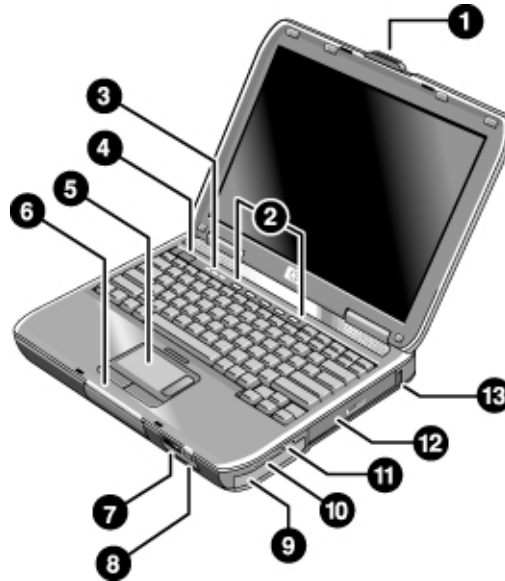

- | | | | |
|---|--|----|--|
| 1 | Notebook open/close latch | 8 | Wireless on-off button and indicator light (select models only) |
| 2 | One-Touch buttons | 9 | Battery |
| 3 | Keyboard status lights | 10 | Audio mute button, audio mute light, and volume control |
| 4 | Power button: turns the notebook on and off | 11 | Audio jacks (left to right): audio out (headphones), external microphone |
| 5 | TouchPad, scroll pad, Click buttons, plus on-off button | 12 | CD-ROM, DVD, or other drive |
| 6 | Main status lights (left to right): power mode, hard drive activity, and battery | 13 | Universal serial bus port (USB) |
| 7 | Infrared port (select models only) | | |

Left panel and back panel components

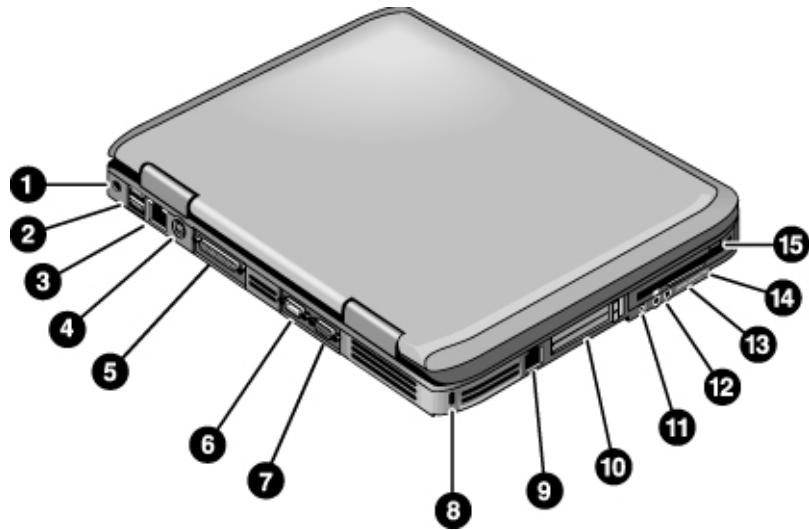

- | | | | |
|---|--|----|--|
| 1 | AC adapter jack | 8 | Cable lock slot (security connector) |
| 2 | Universal serial bus ports (USB) | 9 | RJ-11 jack: connects the modem cable |
| 3 | RJ-45 jack: connects a network cable | 10 | PC Card and CardBus slot and button |
| 4 | S-Video out jack | 11 | IEEE 1394 port (select models only) |
| 5 | Parallel port (LPT1): use this port for a parallel printer or other parallel device | 12 | Audio jacks (left to right): external microphone, audio out (headphones) |
| 6 | Serial port (COM1): use this port for a serial mouse, modem, printer, or other serial device | 13 | Volume control |
| 7 | External monitor port | 14 | Audio mute button and audio mute light |
| | | 15 | Diskette drive (select models only) |

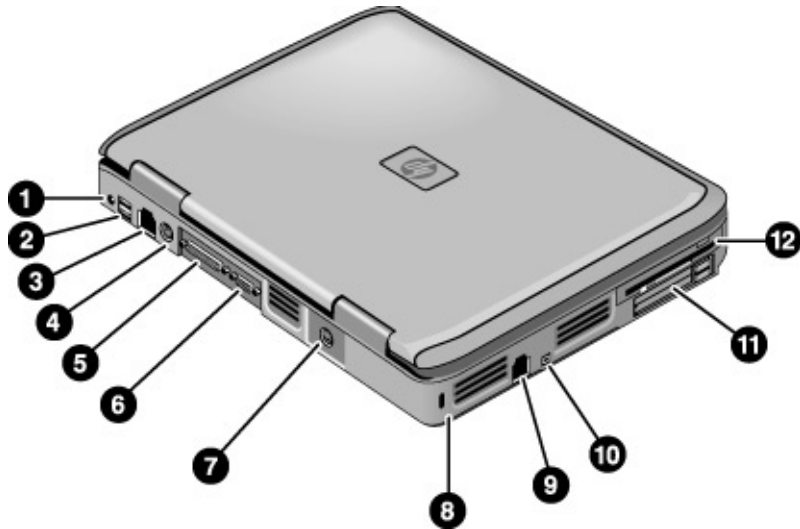

- 1 AC adapter jack
- 2 Two USB ports
- 3 RJ-45 network jack: connects a network cable
- 4 PS/2 port
- 5 Parallel port (LPT1): use this port for a parallel printer or other parallel device

- 6 External monitor port
- 7 S-Video out jack
- 8 Cable lock slot (security connector)
- 9 RJ-11 jack: connects a modem cable
- 10 IEEE 1394 port (select models only)
- 11 PC Card and CardBus slot and buttons
- 12 Diskette drive (select models only)

Bottom panel components

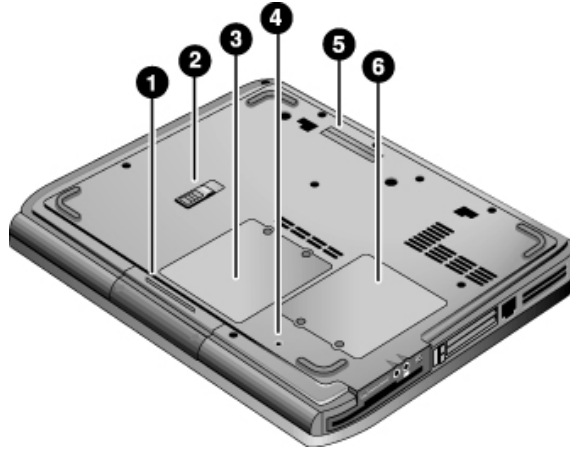

- | | | | |
|---|--------------------|---|---------------------------------------|
| 1 | Hard drive | 4 | Reset button |
| 2 | Battery latch | 5 | Docking port (select models only) |
| 3 | RAM (memory) cover | 6 | Mini PCI cover (no user parts inside) |

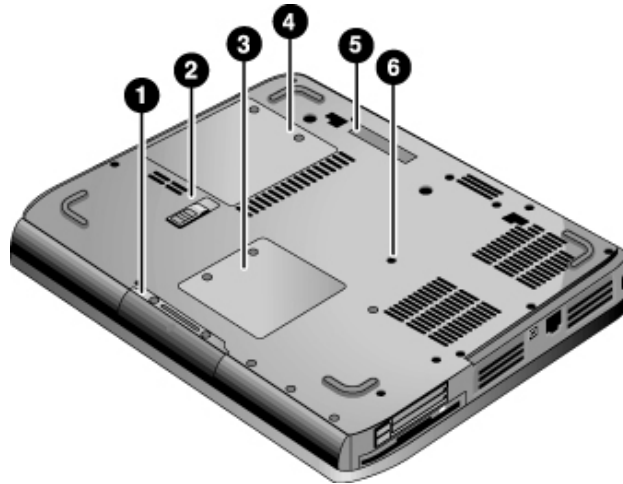

- | | | | |
|---|---------------------------------------|---|-----------------------------------|
| 1 | Hard drive | 4 | RAM (memory) cover |
| 2 | Battery latch | 5 | Docking port (select models only) |
| 3 | Mini PCI cover (no user parts inside) | 6 | Reset button |

Status lights

The notebook includes a number of status lights that report power and battery status, drive activity, and keyboard functions such as Caps Lock and Num Lock.

The following diagram shows the main status lights on the front of the notebook.

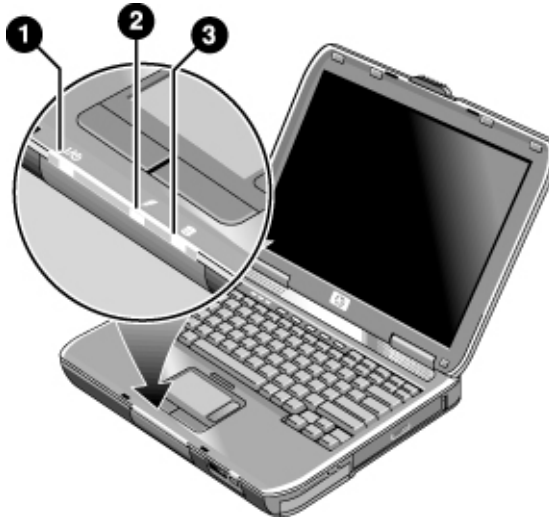

1 Power mode

- On—notebook is on (even if the display is off)
- Blinking—notebook is in Standby
- Off—notebook is off or in Hibernation

2 Hard drive activity

On—notebook is accessing the hard drive

3 Battery status

- Green—AC adapter is connected and the battery is fully charged
- Amber—AC adapter is connected and the battery is charging
- Blinking—AC adapter is connected and the battery is missing or has a fault
- Off—AC adapter is not connected

The keyboard status lights, located above the keyboard, indicate the states of the keyboard locks.

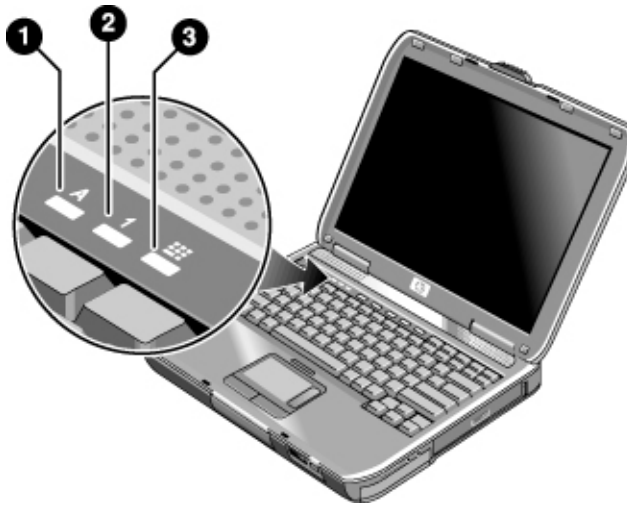

- 1 Caps Lock On.** Caps Lock is active.
- 2 Num Lock On.** Num Lock is active. (The Keypad Lock must also be on to use the embedded keypad.)
- 3 Keypad Lock On.** The embedded keypad is active (Fn+F8). Num Lock must also be for the numeric keys. Otherwise, cursor control is active (as marked on an external keyboard).

Setting Up Your Notebook

WARNING

Improper use of keyboards and other input devices has been associated with ergonomic injury.

If you are using your notebook as your primary computer, or using it for extended periods, you should use it with a full-sized keyboard, monitor, and mouse. Docking accessories offer quick, easy connections to these devices. This can reduce the risk of ergonomic injury.

For information about reducing your risk, see the *Safety & Comfort Guide* on this CD included with your notebook.

When you set up your notebook for the first time, you will charge the battery, connect the AC adapter, turn on the notebook, and run the Windows setup program.

Step 1: Insert the battery

WARNING

Do not mutilate or puncture batteries. Do not dispose of batteries in fire, or they can burst or explode, releasing hazardous chemicals. Rechargeable batteries must be recycled or disposed of properly.

Your notebook is shipped with the battery installed. If the battery has been removed, you should install it:

1. Turn the notebook upside down.
2. Insert the connector end of the battery into the battery compartment, then slide the battery in until it latches.

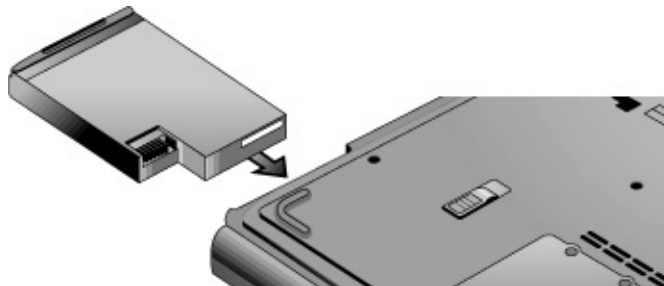

Step 2: Connect AC power

CAUTION

Use only the AC adapter included with your notebook (or other approved adapter that meets the power requirements of the notebook).

Using the wrong AC adapter could damage the notebook or adapter or cause data loss and may void your warranty.

1. Plug the AC adapter into the notebook.
2. Connect the power cord to the AC adapter.
3. Plug the power cord into a wall outlet. The notebook battery starts charging.

Important

When unplugging the power cord, unplug it from the wall outlet before unplugging it from the AC adapter.

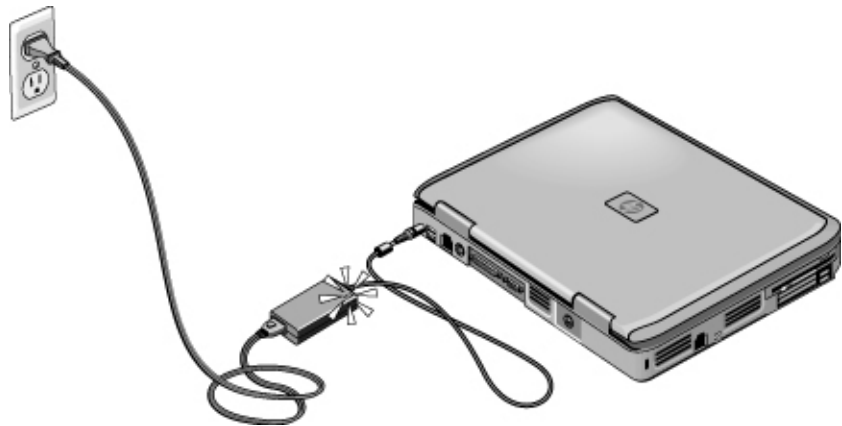

While the battery is charging, you can continue with the “Step 3: Connect a phone line” section.

Step 3: Connect a phone line

1. Make sure the telephone line is an analog line, sometimes called a data line. (Do **not** use a digital line.)
2. Connect the telephone cord (RJ-11) into a telephone jack.
3. Plug the other end of the telephone cord into the RJ-11 modem jack on the notebook.

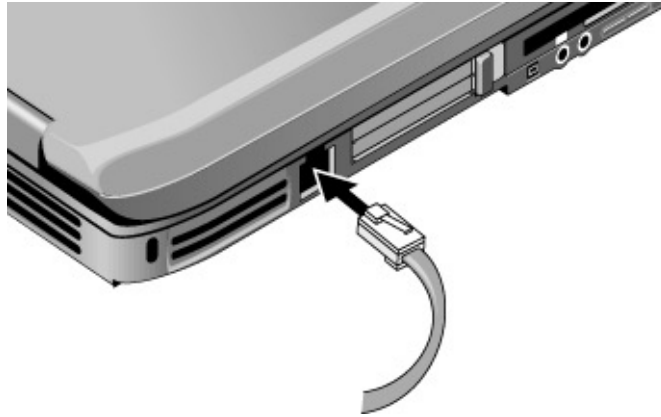

For details about using the modem, see “Using the Modem” later in this guide.

Step 4: Turn on the notebook

Press the power button above the left side of the keyboard. The notebook boots up and Windows starts automatically.



Hint

If your notebook does not turn on when operating on battery power, the battery may be out of power. Plug in the AC adapter, then press the power button again. Leave the AC adapter plugged in for several hours to fully charge the battery. Charge times will vary.

Step 5: Set up Windows

Your notebook has the Microsoft Windows operating system preinstalled on its hard drive. The first time you turn on your notebook, the Windows Setup program runs automatically so you can customize your setup.

1. Follow the Setup program instructions on the screen. If the program prompts you to enter the Product ID code, locate the code on the bottom of the notebook.
2. Check the modem country or region settings. Select Start > Control Panel > Printers and Other Hardware > Phone and Modem Options, then choose your country or region.

Basic Operation

Operating Your Notebook

You can start and stop your notebook using its power button. However, at certain times you may want to use other methods to start or stop the notebook—depending on power considerations, types of active connections, and startup time.

Default power settings

Power mode	To enter this mode	Function
ON —Power status light will turn on.	Briefly press the power button.	Powers on the notebook.
OFF —Power status light will turn off.	Select Start > Turn Off Computer > Turn Off. If the system has stopped responding and Windows shutdown procedures cannot be used, press and hold the power button for at least 4 seconds to turn off the notebook.	Powers off the notebook.
Standby —Power status light will blink.	Select Start > Turn Off Computer > Stand By. –or– Allow the system to time out.	<ul style="list-style-type: none">• Saves significant power.• Turns off the display and other components.• Maintains current session in RAM.• Restarts quickly.• Restores network connections.
Hibernation —Power status light will turn off.	If the unit is already on, briefly press the power button. –or– Press Fn+F12. –or– Allow the system to time out.	<ul style="list-style-type: none">• Saves maximum power.• Saves current session to disk, then shuts down.• Restores network connections.

You can also customize the way these power modes work. See the “Batteries and Power Management” chapter in this guide.

To reset the notebook

Occasionally, you may find that Windows or the notebook has stopped responding and will not let you turn the notebook off. If this happens, try the following procedures in this order:

- If possible, shut down Windows. Press CTRL+ALT+DEL, then select Shut Down, Restart.
- or–
- Press and hold the power button for at least 4 seconds until the display shuts down. Any unsaved data will be lost. Then press the power button again to restart.
- or–
- Insert the tip of a paper clip into the reset button on the bottom of the notebook, then press the power button to restart.

To reset the notebook while it is docked in a port replicator, you can press the reset button on the left side of the port replicator.

To change the boot device

The notebook normally boots from its internal hard drive. You can also boot the notebook from a diskette drive, a CD-ROM drive, or an internal network interface card.

1. Select Start > Turn Off Computer > Restart.
2. When the logo screen appears, press ESC to display the Boot menu.
3. Use the arrow keys to select the boot device, then press ENTER.

If you want to boot from a specific device whenever it is present, change the boot order using the BIOS Setup utility. See “Configuring Your Notebook” in the “Troubleshooting and Maintenance” chapter in this guide.

To use the TouchPad

The TouchPad includes an on-off button so you can turn off the TouchPad to avoid moving the pointer accidentally, such as by touching the pad while typing. The indicator light turns off when you turn off the TouchPad.

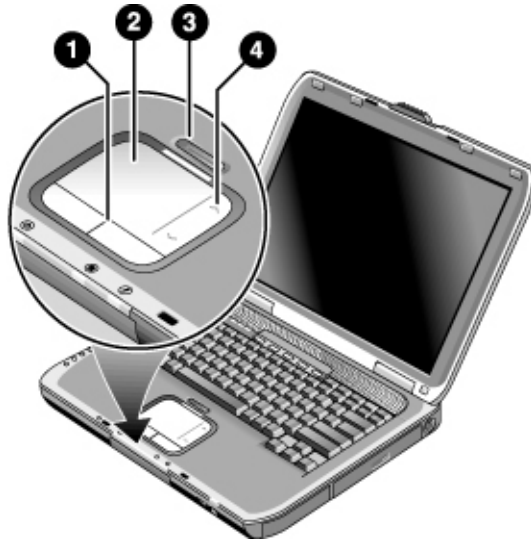

- 1 Click buttons.** The Click buttons work like the left and right buttons on a standard mouse.
- 2 TouchPad** (touch-sensitive pointing device).
- 3 TouchPad on-off button and indicator light.**
- 4 Scroll pad.** The scroll pad scrolls vertically to display the contents of the active window.

To use the function hot keys



The combination of the Fn key plus another key creates a *hot key*—a shortcut key sequence—for various system controls. To use a hot key, press *and hold* Fn, press the appropriate second key, then release both keys.

This hot key	Does this
Fn+F1	Decreases the display brightness.
Fn+F2	Increases the display brightness.
Fn+F8	Toggles the built-in keypad on and off. Does not affect an external keyboard. If Num Lock is on, then the numeric functions are active. Otherwise, cursor control is active (as marked on an external keyboard).
Fn+F12	Enters Hibernation.
Fn+NumLock	Toggles Scroll Lock on and off.
Fn+Page Up	Increases the audio volume and cancels the mute setting.
Fn+Page Down	Decreases the audio volume.
Fn+Backspace	Mutes/unmutes the audio output.

To use the One-Touch buttons

Your notebook includes five One-Touch buttons that can start any application or open a document or Web site with a single press.

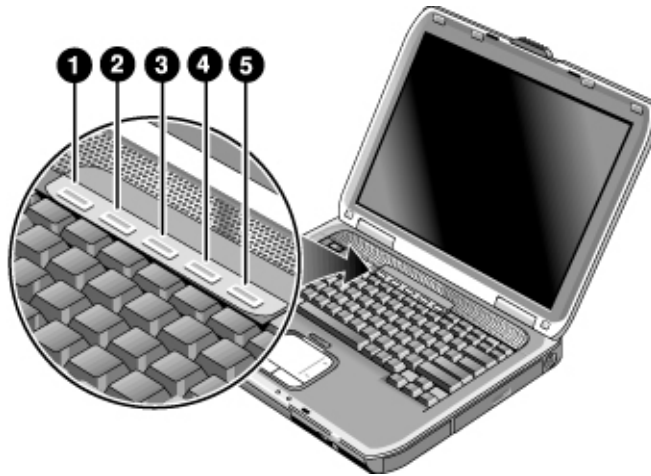

Press a One-Touch button to open the corresponding application, document, or Web site.

To program a One-Touch button

1. Select Start > All Programs > Utilities > One Touch.
2. On the One-Touch tab, select the button you want to reprogram.
3. Type a label for the button, then select the application, document, folder, or Web site you want the button to open.
4. If you want a label to appear onscreen when you press a One-Touch button, select that option on the Onscreen Display tab.

To use the Windows and Applications keys



The Windows key brings up the Windows Start menu. This is the same as selecting the Start button on the taskbar.



The Applications key brings up the shortcut menu for the selected item. This is the same menu that appears when you right-click while pointing at the selected item.

This key combination	Does this
Windows key+E	Runs Windows Explorer
Windows key+F1	Runs Windows Help
Windows key+F	Runs Windows Find: Search
Windows key+M	Minimizes all displayed windows
Shift+Windows key+M	Returns all minimized windows to original size
Windows key+R	Runs the Windows Run dialog box

To use the ALT GR key

Non-U.S. keyboards have an ALT GR key to the right of the spacebar. This is a shift key that provides access to certain special keyboard characters.

For a character in the lower-left corner of a key, press and hold ALT GR to type the character.



- 1 Shifted
- 2 Unshifted
- 3 ALT GR

Using CDs or DVDs

To insert or remove a CD or DVD

CAUTION

Do not remove a CD or DVD while the notebook is reading it. Otherwise, the notebook could stop responding and you could lose data.

Press the CD or DVD gently, but firmly, onto the spindle to avoid damage to the disk or drive.

1. Press the button on the face of the CD or DVD drive. If you are using this drive for the first time, be sure to remove the cardboard packing insert if present.
2. Place the CD or DVD into the drive (label facing up), then gently press down to seat it on the spindle.

–or–

Remove the CD or DVD.

3. Slide the tray back into the module to close it.

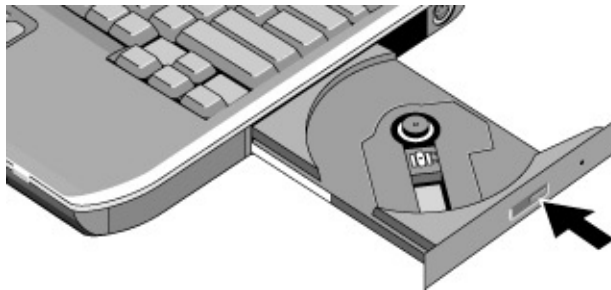

If your notebook loses power, you can manually open the drive to remove a CD. Insert a straightened paper clip into the recessed hole on the front of the drive to open it.

The location of the CD or DVD drive varies by model.

To play DVD movies

If your notebook is equipped with a DVD or other DVD readable drive, it also includes a DVD player software that lets you play DVD movies.

Select Start > All Programs > Multimedia > DVD Player > InterVideo WinDVD.

Hint

For best performance while playing movies on battery power, set the Control Panel power scheme to Portable/Laptop.

Important

DVDs can have regional codes embedded in the disc data. These codes prevent DVD movies from being played outside the region of the world in which they are sold. If you get a region code error, you are trying to play a DVD intended for a different region.

Most DVD drives let you change the region code only a limited number of times (usually no more than four). When you reach this limit, your last change to the region code will be hard-coded on the DVD drive, and will be permanent. Your warranty does not cover the expense of correcting this situation. Refer to the Help for your DVD player software for details about setting region codes.

To create or copy CDs

If your notebook is equipped with a DVD/CD-RW combo drive, it also includes software such as Roxio Easy CD Creator that lets you copy or create CDs. Follow the instructions that are included with the software. Read and write quality may vary by media.

Securing Your Notebook

To set up password protection

You can protect your notebook from access by another user when you set up password protection, which is available through Windows and through the BIOS Setup utility. See “Configuring Your Notebook” in the “Troubleshooting and Maintenance” chapter. For complete protection, set passwords in Windows as well as through BIOS Setup.

To cancel password protection, set an empty password.

Windows

1. Select Start > Control Panel > User Accounts, then select your account.
2. Select Create a Password, then set the password.
3. Select Start > Control Panel > Performance and Maintenance > Power Options.
4. On the Advanced tab, select the option to prompt for a password when the notebook leaves Standby.

To lock your notebook

To protect against unauthorized access while your notebook is running, lock the notebook before leaving it unattended, or set up a screen saver with a Windows password. You can lock the notebook these ways:

- If a One-Touch button is assigned to Quick Lock, press that button.
- or–
- Press CTRL+ALT+DEL, then select Lock Computer.

To unlock the notebook, follow your normal logon steps.

To attach a security cable

Your notebook includes a built-in connector to secure the notebook with a cable and a lock (such as the Kensington MicroSaver lock system, available at many computer stores).

- 1 Wrap the cable around a secure object, such as a table leg.
- 2 Insert the cable into the security cable slot on the notebook.
- 3 Lock it with the cable lock key, then store the key in a safe place away from the notebook.

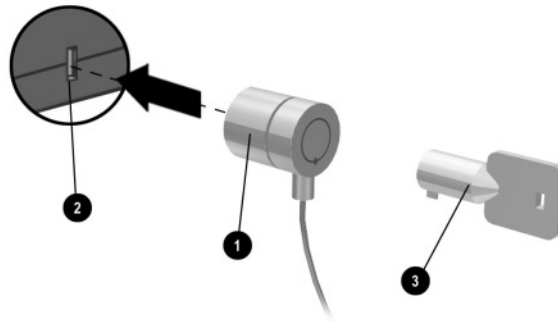

To protect against viruses

Virus-protection software can help protect the integrity of your data. This is especially important if you use the Web.

Your notebook comes equipped with the Norton AntiVirus software. You can get detailed instructions from the Norton online Help. Because new viruses appear frequently, you will also want to update the program virus definitions periodically. Norton AntiVirus updates are on the Web at www.symantec.com.

To lock the hard drive

The notebook enables you to lock its internal hard drive to help keep your information secure. *Hard drive lock does not protect a second hard drive installed in the module bay.*

CAUTION

When you enable hard drive lock, the current BIOS user password (or administrator password if that is the only password set) is encoded on the hard drive.

If you move the hard drive to another computer, you can't access the drive until you set the user (or administrator) password to match the drive password. After you match the drive password, you can change the computer (and drive) password. If you forget the password, you cannot recover your data.

1. Select Start > Turn Off Computer > Restart.
2. When the logo screen appears, press F2 to enter the BIOS Setup utility.
3. From the Security menu, enable Password Required to Boot.
4. From the Security menu, enable Internal hard drive lock.
5. Press F10 to save and exit BIOS Setup.

Taking Care of Your Notebook

Use the following recommendations to maintain your notebook during everyday use and prevent potential physical damage or data loss.

To protect your hard drive

Hard drives, as well as other internal components, are not indestructible and can be damaged by inappropriate handling and operation.

- Avoid bumps or jolts.
 - Do not operate the notebook while traveling over bumpy terrain.
 - Put the notebook in standby or shut it down before transporting it. This turns off the hard drive. A drop of a few inches onto a rigid surface while the hard drive is operating could destroy data or damage the drive.
 - Carry the notebook in a padded case to protect against bumps and jolts.
 - Set down the notebook gently.
-

To maintain your notebook

- Provide adequate ventilation around the notebook. Always set the notebook on a flat surface, so that air can flow freely around and underneath it.
- Always shut down the notebook or put it in Hibernation before putting it in a carrying case or other enclosed space.
- Do not pick up or carry the notebook by its display.
- Do not use the notebook outside in the rain or snow (inclement weather). If the notebook is cold, warm it gradually to avoid condensation.
- Maintain your battery for best performance. See the “Batteries and Power Management” chapter.

To safeguard your data

- Do not use a pointing device or activate any other device that interrupts operation while the system is starting or stopping.
 - Back up your work regularly. Copy files to diskettes, CDs, DVDs, and other media or network drives.
 - Use a virus-scanning program (such as the Norton AntiVirus program included with your notebook) to check the integrity of your files and operating system.
 - Check your disk using the Tools tab in the disk Properties window.
-

To extend the life of the display

- Set the display brightness to the lowest comfortable level (Fn+F1).
 - When working at your desk, connect an external monitor and turn off the internal display (press the TV Now! One-Touch button at the top of the keyboard).
 - If you are not using an external monitor, set the Turn off monitor timeouts (for both AC and battery operation) to the shortest comfortable interval.
 - Avoid using a screen saver or other software that prevents the notebook from changing to Display-off or Standby after a timeout period. If you use a screen saver, enable the option to shut off the display after a time delay.
 - Do not disable Display-off or Standby timeouts.
 - If you are using AC power and have no external monitor attached, put the notebook in Standby when not in use.
-

To clean your notebook

- You can clean the notebook with a soft cloth dampened with clean water or with water containing a mild detergent. Do not use an excessively wet cloth, and take care to keep water out of the case.
- Do not use abrasive cleaners, especially on the display. Do not apply any cleaner directly to the display. Instead, apply the cleaner to a soft cloth, then gently wipe the display.

Batteries and Power Management

Managing Power Consumption

When you are running your notebook on battery power, you can maximize operating time without compromising performance. Your notebook is designed to help you reduce power consumption and extend battery life.

During idle periods, the notebook automatically enters power-saving modes after specified timeout periods. You can adjust these timeouts to suit your working habits.

How the notebook manages power automatically

Your notebook enters Hibernation and Standby automatically, and turns off the hard drive and display based on values set in Windows.

When this occurs	The result is	To resume
No keyboard, pointing device, or other input activity occurs for the specified interval	Display turns off. Turns off the display to conserve battery power and extend the life of the display.	Briefly press any key or move a pointing device to turn on the display.
The hard drive is not accessed for a specified interval	Hard drive turns off. This is usually set to occur shortly after the display is turned off.	Begin using the notebook, and the hard drive turns on.
No pointing devices are used, no disk drive is accessed, and no port (serial, parallel, or infrared) is active for the specified interval	Standby is initiated. Maintains your current session in RAM, and turns off the display and other components to conserve battery power.	Briefly press the power button to return to your current session.
The notebook stays in Standby for the specified interval	Hibernation is initiated. Saves your current session to the hard drive, and turns off the notebook.	Press the power button to return to your previous session.

CAUTION

Make a habit of saving your work before allowing your notebook to enter Standby. If power is interrupted while the notebook is in Standby, any information that was not saved will be lost.

The notebook can also enter Hibernation if battery power reaches a critically low level. If this happens, you will find on resuming that all your data has been saved, but some functions may be disabled. To resume normal operation, restore power by connecting an AC adapter or installing a charged battery, then shut the notebook off and restart it.

Changing timeout settings and creating power schemes

You can adjust the length of timeouts after which your notebook automatically shuts down components or enters a power-saving mode. You can also save these settings as a power scheme.

1. Select Start > Control Panel > Performance and Maintenance > Power Options.
2. Select the Power Schemes tab, then enter the settings you want. If you do not want a particular timeout to occur, set the value to Never. See Windows Help for details.

If you want to save the settings as a power scheme, select Save As and enter a name for the scheme.

CAUTION

Do not disable Hibernate support in the Power Options settings, or you will lose any unsaved data if the notebook battery runs down completely.

Using Battery Power

To check battery status

From the battery status light

Check your notebook battery status light.

From the Windows taskbar

The Windows taskbar can display a power icon that provides detailed battery status information (see Windows Help for details). The icon resembles a battery when AC power is not connected.

- Place the pointer over the power icon to display the remaining battery charge. This value is shown as either a percentage of charge remaining, or as time remaining.
- Select the power icon to open the Battery Meter window.

From the Windows Control Panel

Select Start > Control Panel > Performance and Maintenance > Power Options, then select the Power Meter tab to see the battery status. The Alarms and Advanced tabs provide additional Windows power-information options.

On the battery

1. Remove the battery from the notebook. See the “Getting Started with Your Notebook” chapter in this guide.
2. Press the contact pad on the side of the battery. The number of lights that turn on indicates the remaining charge (each light represents 20 percent of a full charge).

To respond to a low-battery warning

The notebook automatically alerts you when the battery power drops to a critically low level. The notebook first emits a high-pitched beep or displays a warning message. Then, if you do not restore power within a short time, the notebook enters Hibernation.

After the notebook enters Hibernation in this way, you will not be able to turn it on again until you restore power by doing *one* of the following procedures:

- Replace the battery with a charged one.
- Plug in the AC adapter.

Note

If you plug in the AC adapter, you can continue to work while your battery recharges.

To recharge the battery

CAUTION

The AC adapter is normally warm whenever plugged into an AC outlet. The notebook is normally warm while recharging. Do not recharge the notebook in a briefcase or other confined space, or the battery could overheat.

Plug the AC adapter into the notebook.

To get the longest operating time, wait until the battery charge is below 50 percent before recharging, then charge it fully (100 percent). Charging can take up to several hours. If you continue working while the battery charges, the charging time may increase.

The operating time for a fully charged battery depends on the notebook model, power management settings, and level of use.

To get the most from your batteries

Follow these suggestions to make your battery power last as long as possible:

- Plug in the AC adapter, especially when using a CD-ROM or DVD drive, or any external connections such as a PC Card or a modem.
- Set the display brightness to the lowest comfortable level (Fn+F1).
- Put the notebook in Standby whenever you are not using it for a short while.
- Put the notebook in Hibernation whenever you want to save your current session, but will not be using the notebook for a day or more.
- Set the automatic timeout settings to emphasize saving power. If your notebook has a multispeed processor, use the lower speed on battery power (the default settings conserve battery power).
- If your notebook has a wireless on-off button, turn off the wireless function when you are not using it. Press the wireless on-off button so that the light turns off.
- If you have a PC Card such as a network card, remove it when you are not using it. Some PC Cards use significant power even while they are inactive.
- If you work with an application that uses the serial port or a PC Card, exit the application when you finish using it.
- Do not leave batteries unused for long periods. If you have more than one, rotate them.
- If you normally use AC power, make a practice of using the battery as your power source at least once a week.
- Unplug the AC adapter when the notebook is not in use.
- To preserve the life of a battery, be sure to charge it regularly.
- For long-term storage, the battery must be charged 20 percent to 50 percent to minimize capacity loss by self-discharge and to avoid deterioration of battery performance.
- Avoid using or charging batteries at high temperatures.

Modem and Network Connections

Using the Modem

You can connect your modem to a telephone line and communicate with other computers throughout the world. You can explore the Internet, send and receive e-mail messages, and use your notebook to send and receive faxes. Your notebook contains several software programs that work with your modem:

- Internet Explorer, for browsing the World Wide Web
- Outlook Express, for sending and receiving e-mail messages
- Windows Fax Console software for sending and receiving faxes

For best performance, you can connect to any Internet Service Provider (ISP) or modem network that has V.90 or V.92 interoperable modems. Check with your ISP for a list of telephone numbers that support V.90 or V.92. (V.92 enables modem on-hold technology that allows an Internet session to be interrupted to answer a phone call, then resumes the Internet session once the call is complete.)

The maximum speed for faxing is 14.4 Kbps, even though the modem is capable of downloading at higher speeds.

To connect the modem



CAUTION

Your built-in modem may not work with multiple phone lines or a private branch exchange (PBX), cannot be connected to a coin-operated telephone, and does not work with party lines. Some of these connections may result in excess electrical voltage and could cause a malfunction in the internal modem. Check your telephone line type prior to connecting your phone line.

Special restrictions in certain countries

- Many countries impose a blackout period after a modem repeatedly fails to connect to a service provider. The number of failed attempts and the period you must wait before trying again differ from country to country. Check with your telephone company.

For example, if you are dialing from Italy and fail to connect to your server or cancel the connection, you must wait one minute before dialing that number again. If you dial before then, you will get an error message that says “delay.” After the fourth failed connection, you must wait one hour before trying the number again. If you dial before the hour is up, you will get a message that says “black list.”

- When using a modem, an external surge protector can prevent damage to your notebook from lightning or other electrical surges. Connect any approved surge protector to the modem cable when you are using the modem.

To change your modem settings

The modem is already set up to be compatible with telephone systems and modems in most areas. However, in some situations, you may have to change modem settings to match local conditions. If you have questions about local requirements, contact your telephone company.

- **Control Panel.** Open Phone and Modem Options in Control Panel to change many modem settings. On the Modems tab, select Properties to set connection speeds, or on the Dialing Rules tab select Edit to set dialing options.
- **Communications software.** Many communications applications provide options for controlling modem settings. See the Help for your software.
- **AT commands.** You can control many aspects of modem operation using modem AT commands. AT commands are special strings of characters sent to the modem to set up specific conditions. Those command strings normally start with “AT.” For a list of AT commands for the built-in modem, see the “Reference Information” chapter.

Open Phone and Modem Options in Control Panel. On the Modems tab, select Properties. You can type AT commands on the Advanced tab in the space for extra settings.

Connecting to a Local Area Network (LAN)

LANs give you access to network resources, such as printers and file servers on your corporate network, and possibly to the Internet. To connect to a LAN:

1. Check that the existing LAN supports Ethernet 10Base-T (10 Mbps) or 100Base-TX (100 Mbps) connections.
2. Plug the LAN cable (not supplied) into the built-in LAN port. The cable must have an RJ-45 connector.
3. Windows automatically detects and sets up a LAN connection. To edit settings, open Network and Dial-up Connections in Control Panel.

See Windows Help for information about setting up and using LAN connections. Select Start > Help and Support. Contact your network administrator for network information.



Two lights next to the LAN port indicate the status of the connection:

- The yellow light indicates network activity.
- The green light indicates a 100 Mbps link.

Making Wireless Network Connections (select models only)

If your notebook includes a wireless on-off button, you can connect by radio to an 802.11 wireless local area network (LAN) and access computers and other resources on the network.

A wireless network provides all the functions of a typical “wired” network, but also provides for “roaming.” Since your notebook connects to the network by radio rather than through cables, you can move from place to place within the network—from your office to a conference room, for example—and remain on the network the entire time.



To prepare for connections

Before you can connect your notebook to a particular 802.11 wireless network, you have to configure the notebook for the specific wireless connection.

Connecting to an existing wireless network

You can connect to an access point that gives you access to a local area network, or you can connect directly to other computers in an “ad hoc” network.

1. Right-click the wireless network connection icon in the taskbar, then select View Available Wireless Networks from the pop-up menu.

Modem and Network Connections

Making Wireless Network Connections (select models only)

2. A list of available networks appears. Select the network you want, enter the encryption key if required, then select Connect.

If the network you want is not on the list, select Advanced > Configure, and enter the required network parameters. If the network is not using 802.1x authentication protocol, clear the automatic key option.
3. On the General tab, edit network settings as needed for your local network. See your network administrator. You can also display an icon in the taskbar when connected to a network.
4. On the Wireless Networks tab, view the wireless networks available within range. Each network SSID is listed. Select the network you want, then select Configure.
5. If the wireless network uses standard encrypted communication, uncheck the automatic key option, then select the following parameters:
 - Key: ASCII passphrase or hexadecimal key string.
 - Key format: ASCII for passphrase, hexadecimal for key string.
 - Key length: smaller number for 64-bit encryption, larger number for 128-bit.See your network administrator for the required settings.
6. Select OK to save the configuration. This network is added to your list of preferred networks.

The notebook automatically connects to the first preferred network within range if wireless communication is turned on.

Creating a New Computer-to-Computer Network (Ad Hoc)

You can set up a new network available to other local computers.

1. Select Start > Control Panel > Network and Internet Connections > Network Connections.
2. Select the wireless connection to show its status, then select Properties.
3. On the Wireless Networks tab, select Add to create a new network.
4. Type a name for the new network.

Making Wireless Network Connections (select models only)

5. If you want to use encrypted communication, uncheck the automatic key option, then select the following parameters:
 - Key: ASCII passphrase or hexadecimal key string
 - Key format: ASCII for passphrase, hexadecimal for key string
 - Key length: smaller number for 64-bit encryption, larger number for 128-bit
6. Mark the option to make this a computer-to-computer (ad hoc) network.
7. Select OK to save the configuration. This network is added to your list of preferred networks and becomes available to other computers.

To turn wireless communication on and off

Important

Wireless networks and cellular modems are examples of devices that use wireless communication. Such devices may be restricted in some situations or environments, such as when traveling in an airplane. If in doubt, be sure to ask for authorization *before* turning on your notebook wireless networking.

In Italy, Singapore, and possibly other countries, you may be required to purchase a license before using the wireless function.

Turning on communication and making a connection

If your notebook has both wireless 802.11 and Bluetooth capabilities, the wireless indicator light on the front of the notebook turns on when Bluetooth or 802.11 communication is turned on, but it does not show whether Bluetooth, 802.11, or both functions are active. You must use the Wireless Configuration software to control the individual wireless functions.

1. If the notebook is not on, turn it on.
2. If you normally press the wireless on-off button on the front of the notebook to turn wireless 802.11 communication on and off, press the button so the indicator light turns on. This restores your previous wireless configuration.

–or–

Select Start > Control Panel > Network and Internet Connections > Network Connections, then select the wireless network connection icon.

If you are within range of your wireless network, your notebook automatically connects. To check the status of your wireless connection, open Network Connections in Control Panel, then select the connection.

Turning off communication and ending a connection

1. **Important:** close any files that reside on other network computers.
2. To turn off the wireless 802.11 communication without turning off the notebook, press the wireless on-off button. This also turns off Bluetooth communication if it was enabled.

–or–

Right-click the wireless network connection icon in the taskbar, then select Disable.

Putting the notebook in Standby or shutting it down also turns off the wireless function.

Making Wireless Bluetooth Connections (select models only)

If your notebook includes Bluetooth wireless capabilities, you can use it to make short-range radio connections to a wireless personal area network (PAN) and access other Bluetooth-compatible devices, such as other computers, cell phones, and printers.

Since the Bluetooth function connects your notebook by radio rather than through cables, you can move around and remain connected, and you can detect new Bluetooth devices automatically when they enter your area.

To turn Bluetooth communication on and off

Important

Wireless communication may be restricted in some situations or environments, such as when traveling in an airplane. If in doubt, be sure to ask for authorization *before* turning on your notebook wireless networking.

In Italy, Singapore, and possibly other countries, you may be required to purchase a license from the responsible authority before using the wireless function.

Turning on Bluetooth communication

The wireless indicator light on the front of the notebook turns on when Bluetooth or 802.11 communication is turned on, but it doesn't show whether Bluetooth, 802.11, or both functions are active. You must use the Wireless Configuration software to control the individual wireless functions.

1. If your notebook isn't on, turn it on.
2. If you normally press the wireless on-off button on the front of the notebook to turn Bluetooth communication on and off, press the button so the indicator light turns on. This restores your previous wireless configuration.

–or–

If the Wireless Configuration icon is present in the taskbar, select the icon, then select the Bluetooth button to turn on Bluetooth communication.

Turning off Bluetooth communication

Turning off communication ends any connection you have open.

1. **Important:** close any files that reside on other network computers.
2. To turn off Bluetooth communication without turning off your notebook, press the wireless on-off button. This also turns off 802.11 communication if it was enabled.

–or–

If the Wireless Configuration icon is present in the taskbar, select the icon, then select the Bluetooth button to turn off Bluetooth communication, without affecting 802.11 communication.

Turning off the notebook or putting it into Hibernation also turns off the Bluetooth function.

To prepare for Bluetooth connections

Before you use your notebook to access other Bluetooth devices, you should configure some basic settings.

1. Make sure Bluetooth communication is turned on.
2. Select the Bluetooth icon in the taskbar.
3. In the menu bar, select Bluetooth > Device Configuration. (This menu is available only while Bluetooth folders are selected.)
4. On the General tab, check the following settings:
 - Give your notebook a unique name that will identify it to other Bluetooth users.
 - Set the computer type to Laptop.
 - Select the security mode you want to use.
5. On the Information Exchange tab, check the following settings:
 - Check the directory you want to make available to other Bluetooth users for sharing files, both sent and received.
 - Check the directory where you want to store your business card file so you can easily send it to other Bluetooth users.
 - Check the inbox directory where you want delivered files from other Bluetooth users to be stored automatically.

Detailed information about these and other advanced settings are included in the online help.

Making Wireless Bluetooth Connections (select models only)

To create your business card, you can open Microsoft Outlook, then open the address book and create a new contact. After entering your personal information, select File, Export To vCard File and store the file in your business card directory.

To send or receive files using Bluetooth

If your notebook includes Bluetooth wireless capabilities, it supports the following common protocols for transferring data. To use either protocol, *both* computers must support that protocol. Check the other computer's Bluetooth documentation.

- **FTP:** files can be copied into and out of shared directories (folders) by both computers. This service is equivalent to common network file sharing.
- **OPP (object push profile):** both computers can send certain types of Microsoft Outlook data to the other computer's Bluetooth inbox, but cannot retrieve files from the other computer.

Sharing files with another Bluetooth device (FTP)

1. Select the Bluetooth icon in the taskbar.
2. In My Bluetooth Places, select and open the other device to view files in its shared directory.
3. Use Windows Explorer or other software to copy or move files between your notebook and the other device.

Sending Outlook data to another Bluetooth device (OPP)

1. Select the Bluetooth icon in the taskbar.
2. In My Bluetooth Places, select and open the other device.
3. To send a calendar item, note, or message, select the device inbox, select the option you want, then select the file to send. The file arrives in the device inbox directory.

–or–

To send your business card, select the device inbox, then select the option to send your business card.

Add-On Devices

Connecting PC Cards

The notebook PC Card slot is available for storing data and expanding the communication capabilities of the notebook. The notebook supports standard Type II and III PC Cards (PCMCIA and CardBus).

To insert or remove a PC Card

Note

The location and number of the PC Card slots vary by model series.

Inserting a PC Card

1. Hold the PC Card label-side up with its connectors facing the card slot.
2. Slide the PC Card all the way into the bottom of the slot. Most cards are properly seated when the outer edge is flush with the casing of the notebook, but some cards are designed to protrude from the case.

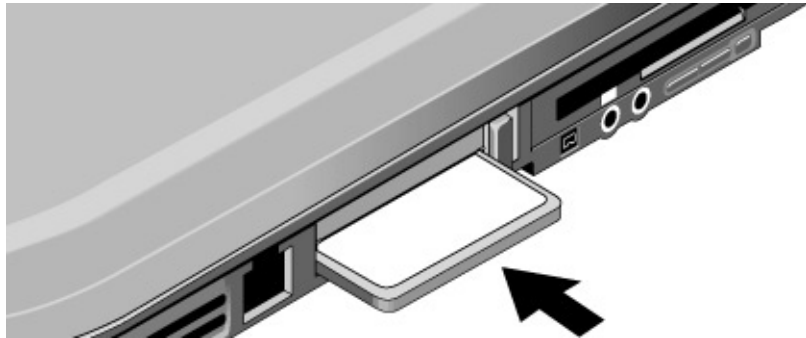

Removing a PC Card

CAUTION

Before removing a PC Card, you must use the Eject Hardware or Safely Remove Hardware icon in the taskbar, or shut down the notebook. Otherwise, you could lose data.

1. Before removing the card, select the Eject Hardware or Safely Remove Hardware icon in the taskbar, then select the card you want to remove. This protects your data and helps avoid unexpected problems.

If needed, you can restart the card by removing and then reinserting it.

2. Press the eject button to pop the button out, then press it in to eject the PC Card.

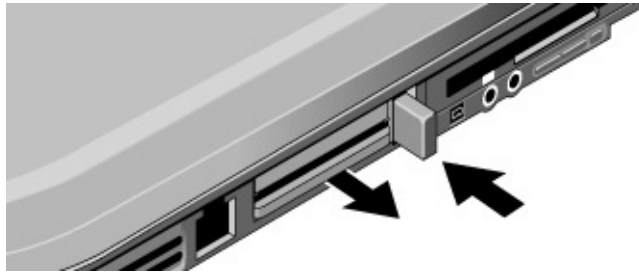

Connecting External Devices

To connect an audio device

You can plug in an external microphone, external speakers, or headphones. In addition, if you connect your notebook to the port replicator, you can plug in a stereo source (such as a CD player) or a device that accepts digital audio (such as a digital audio recorder).

CAUTION

The headphone and line-in jacks are three-terminal stereo jacks. They are not compatible with two-terminal mono plugs. Connecting a mono plug into either of these jacks may damage the notebook.

Attach the audio cable to the corresponding audio port on the notebook or port replicator. Match your notebook to one of the following illustrations to locate the audio connectors on your notebook.

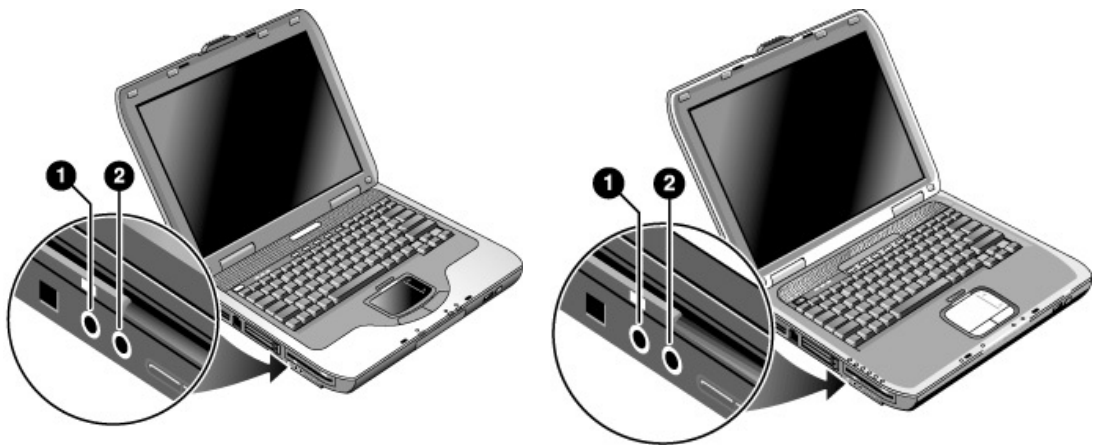

- 1 External microphone connector (pink)
- 2 Audio out (headphones) connector (green)

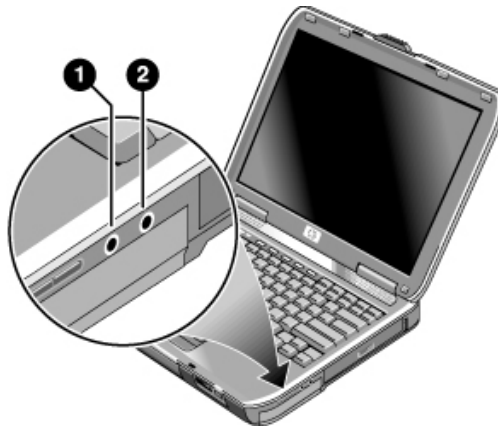

- 1 Audio out (headphones) connector (green)
- 2 External microphone connector (pink)

Note

When you plug a device into the headphone port, the built-in speakers automatically turn off. When you plug a device into either audio port on the notebook, any device connected to the corresponding port on the port replicator is ignored.

To use an external monitor

Connecting an external monitor

1. Plug a standard 4-pin S-Video cable to the S-Video out jack on your notebook (yellow connector on the back panel) to the S-Video in jack on your television. Restart your notebook.

Note

Although your notebook has a 7-pin S-Video out jack, the notebook accepts either a 7-pin or 4-pin cable connection.

2. Using your mouse, right-click in an empty area of the desktop.
3. Select Properties, select the Settings tab, then select the Advanced button.

-or-

Select Start > Control Panel > Appearance and Themes > Display. Then, select the Settings tab, select the Advanced button, and select the Displays tab.

4. To enable the TV, select the red button next to TV.

Note

If the S-Video cable is not plugged into your notebook and TV, the red button will not be displayed.

5. Select Apply to accept the changes.
6. If you are prompted to restart Windows, select Yes.

Switching the display to the external monitor

- Press the TV Now! One-Touch button at the top of your keyboard to switch the display to the external monitor.
- With the default display settings, the external monitor uses the same settings as the internal display. The external monitor displays the same image as the internal display, regardless of the screen area, colors, and other settings, and the refresh rate is the same as the internal display (60 Hz). If you use only the external monitor, you can select different settings that aren't limited by the internal display.

Adjusting monitor resolution and other settings

1. Select Start > Control Panel > Appearance and Themes > Display.
2. On the Settings tab, adjust the Screen area. Other settings are also available.

If you need to increase the refresh rate on the external monitor, you can switch to only the external monitor. An alternative is to make one display a “secondary” display so you can select independent refresh rates:

1. Select Start > Control Panel > Appearance and Themes > Display.
2. On the Settings tab, select the Advanced button, then the Displays or Monitor tab. Set the refresh rate on the Monitor tab.

Using dual display mode

You can extend your desktop by connecting an external monitor to your notebook.

1. Select Start > Control Panel > Appearance and Themes > Display.
2. Select the Settings tab.
3. Select the second display, then select the option to extend the desktop.

You can set different resolutions and numbers of colors for each display. However, using the Extended Desktop requires video memory for each display. For this reason, higher resolutions and higher numbers of colors may cause unexpected behavior on the displays. Try starting with 1024 × 768 resolution on the external display and 64 K colors (16-bit) on both displays. You can then try higher settings to see whether they work for your applications. In addition, certain operations such as playing DVDs and running 3D graphics require extra video memory, so you may have to adjust display settings.

If you’re playing a DVD movie, the movie will show only on the primary display. To change the primary display, go to the Settings tab of Display Properties (see the steps above), right-click the display you want, and select Primary.

To connect an IEEE 1394 device (select models only)

If your notebook has an IEEE 1394 port, you can use it to connect devices such as audio and video equipment, disk drives, printers, and other notebooks.

Attach the device cable to the IEEE 1394 port. Windows automatically recognizes the device.

Add-On Devices

Connecting External Devices

The IEEE 1394 port is a 4-wire port. If you want to connect a device that has a 6-wire plug, you can purchase a simple adapter if the device is unpowered, or a hub if the device requires power.

Note

If you have problems making this connection, contact the device manufacturer Web site for the latest version of the driver for the device.

To connect an infrared device (select models only)

Note

Select models include an infrared port. By default, the infrared port is not enabled, so you must first enable it before you can use it.

If your model has an infrared port (a small, rectangular lens located on the front of the notebook), then your notebook has wireless, serial communication capability. That is, your notebook and other infrared devices, such as printers or other notebooks, can communicate wirelessly using this port.

Using the infrared port

- Make sure the infrared port of your notebook and the infrared port of the device with which you want to communicate lie in a straight line facing each other. The two ports should be no more than one meter apart with no obstructions in between. Noise from nearby equipment can cause transmission errors.
 1. Select Start > Control Panel > Performance and Maintenance > System.
 2. Select the Hardware tab.
 3. Select the Device Manager button.
 4. Select the ALI fast infrared controller, then the Enable Device button.
 5. Select Next > Finish > Close. Then close all open dialog boxes.
- To check the status of communications, open Wireless Link by selecting Start > Control Panel > Printers & Other Hardware > Wireless Link.

Printing to an infrared printer

Install your printer and assign it to the notebook infrared port. You can then print from your applications as you would to any other printer.

Transferring files through an infrared connection

You can use your notebook infrared port to transfer files by using Wireless Link. See the Windows online Help for instructions on using Wireless Link.

To use a port replicator (select models only)

A port replicator provides your notebook with external connections that you can leave in place whenever you remove the notebook from your desk. Instead of disconnecting and reconnecting peripheral devices, you can simply undock and dock the notebook.

CAUTION

Use only the AC adapter included with your notebook (or other approved adapter that meets the power requirements of the notebook).

Do not use a 60-watt, 3.16-amp adapter, and do not use DC adapter accessories F1455A and F2297A.

Using the wrong AC adapter could damage the notebook or adapter and cause data loss, and may void your warranty.

You can dock or undock the notebook in any power state: on, off, Standby, or Hibernation. Make sure, however, that the notebook is not entering into or resuming from Standby or Hibernation when you dock or undock, or the notebook could lock up.

Hint

Before docking or undocking your notebook, save your data and close any applications associated with external connections that might be affected. Do this as a precaution against an unlikely docking problem.

Add-On Devices

Connecting External Devices

To dock to the port replicator

1. Plug in the AC adapter, then connect it to the back of the port replicator. You can also operate the port replicator using power from the notebook battery.
2. Remove the rubber cover from the docking connector on the bottom of the notebook.
3. Align the notebook with the locator posts on the port replicator.

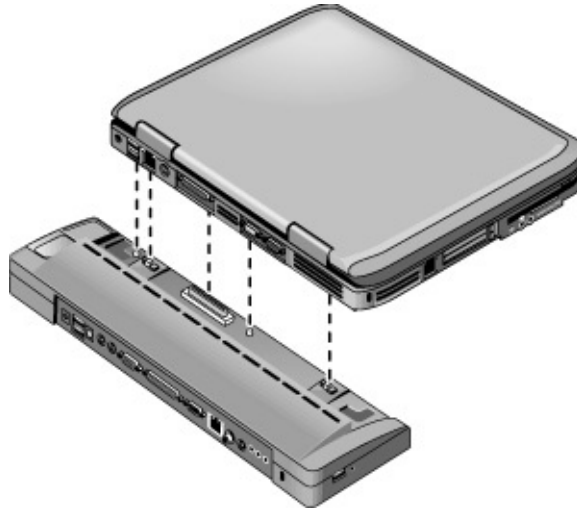

4. Press the notebook down until both sides snap into place.
5. If the notebook is off, open it and press the power button to turn it on. The lights on the port replicator turn on.

When the notebook is docked, you can use its security connector to secure it. To secure both the notebook and port replicator, install the cable lock in the security connector next to the undock button. This will also lock the undock button.

Note

If a device is connected to an audio port on the notebook, any device connected to the corresponding port on the port replicator is ignored.

To undock from the port replicator

1. Press down the undock button on the right side of the port replicator.
2. Lift the notebook out of the port replicator.

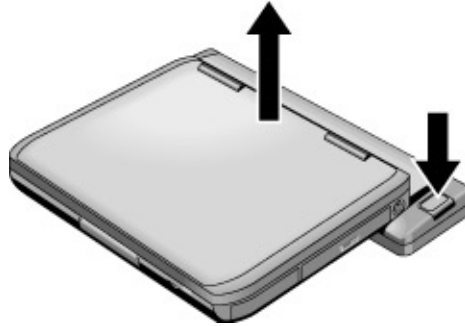

Installing Additional RAM (Memory)

The notebook has two slots that hold two RAM modules. At least one slot contains a RAM module installed at the factory. You can use both slots to expand your RAM.

To install a RAM expansion module

Use PC2100 DDR-266 MHz or higher RAM only.

You'll need a small Phillips screwdriver for these steps.

CAUTION

The internal components of your notebook are extremely sensitive to static electricity and can be permanently damaged by it. Handle the RAM module only by its edges. Before installing the memory module, discharge your body's static electricity by touching the metal shielding around the connectors on the back of the notebook.

1. Select Start > Turn Off Computer > Turn Off.
2. **Important:** unplug the AC adapter, if present, and remove the battery.
3. Turn the unit bottom-side up, loosen the screws holding the RAM cover, and remove the cover.

4. Insert the RAM board into the connector at about a 30 degree angle until it is fully inserted. Then press down at both sides until both latches snap closed. Match your notebook to one of the following illustrations.

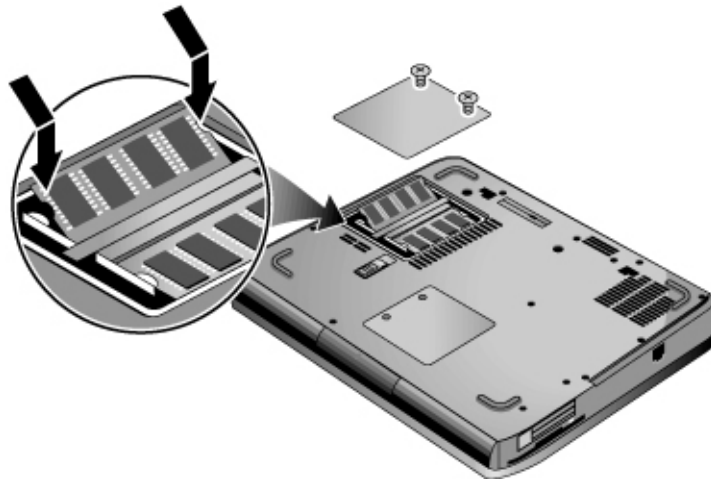
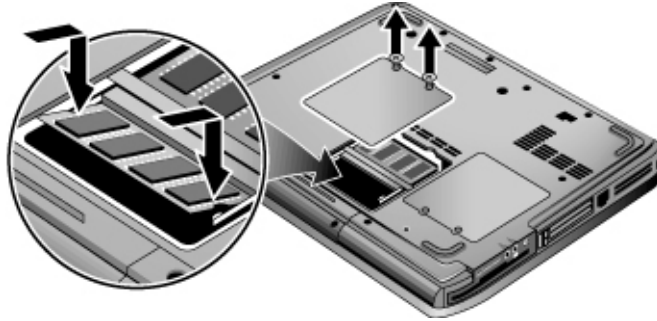

5. Replace the cover.
6. Insert the battery.

To remove the RAM module, release the two latches at the sides of the module.

To remove a RAM expansion module

You may want to remove a RAM module so you can install a larger one. You will need a small Phillips screwdriver for these steps.

CAUTION

The internal components of your notebook are extremely sensitive to static electricity and can be permanently damaged by it. Handle the RAM module only by its edges. Before installing the memory module, discharge your body's static electricity by touching the metal shielding around the connectors on the back of the notebook.

1. Select Start > Turn Off Computer > Turn Off.
2. **Important:** unplug the AC adapter, if present, and remove the battery.
3. Turn the unit bottom-side up, loosen the screws holding the RAM cover, and remove the cover.

4. Release the two latches at the sides of the RAM board, so the free edge of the board pops up. Match your notebook to one of the following illustrations.

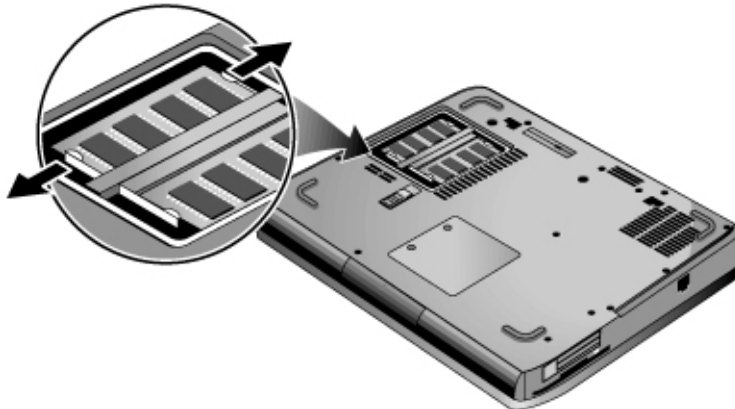
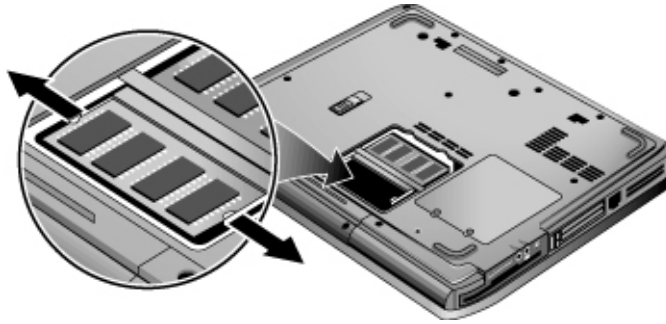

5. Pull the board out of the connector.
6. Replace the cover.
7. Insert the battery.

Replacing the Hard Drive

To replace the hard drive

You will need a small Phillips screwdriver for this procedure.

1. Unplug the AC adapter, if connected.
2. Remove the battery.
3. Turn the unit bottom side up.
4. Use a pointed tool to remove the plugs from the two screw holes, then remove the two screws.
5. Gently pull the hard drive out of the notebook.

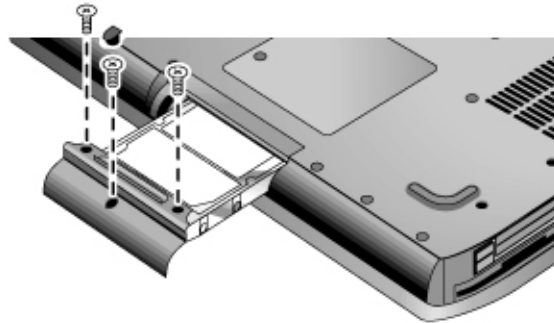

6. Gently slide the new drive into the hard drive compartment. Press firmly to make sure the connector seats properly.
7. Reinstall the hard drive screws and plugs.

Important

If you are installing a new hard drive, you should create a Utility partition on the drive before loading any software.

To replace the hard drive holder

If you are installing a new hard drive that does not have a holder, you can remove the holder parts from the old hard drive. You will need a small Phillips screwdriver for this procedure.

1. Remove the four screws from the sides of the holder and drive case, then slide the drive out of the holder.
2. Notice that the hard drive has a pin connector attachment at one end. Carefully remove this connector from the end of the drive. Work alternately at each end so that the connector slides off evenly without bending the connector pins.

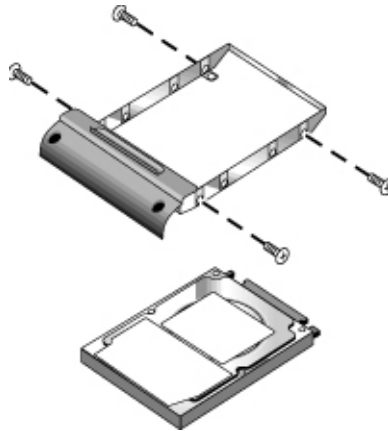

3. Carefully put the pin connector attachment back onto the pins on the end of the new hard drive. Work alternately at each end so that the connector slides on evenly without bending the connector pins.
4. Insert the drive into the holder.
5. Reinstall the screws into the holder and drive case.

To prepare a new hard drive

When you install a new hard drive, you also need to prepare it to be able to work with your notebook.

If you want to restore the Windows software and operating system that were originally installed on your notebook, use the *QuickRestore System Recovery* CD included with your notebook.

Troubleshooting and Maintenance

Troubleshooting Your Notebook

This chapter contains solutions to many types of problems you might have with your notebook. Try the solutions one at a time, in the order in which they are presented.

Here are some other sources of information for troubleshooting:

- Use the Windows troubleshooters. Select Start > Help and Support.
- See the Microsoft Windows manual shipped with the notebook.
- Select the question mark on the One-Touch key located at the top of the keyboard.
- Refer to the *Worldwide Telephone Numbers* booklet to contact a Customer Care Center for help and support.

Audio problems

If no sound is audible

- If your model has a volume control, press the + (plus) button to increase volume.
- Select the speaker icon on the taskbar (if present), then clear the Mute All checkbox if selected. If your model has an audio mute button, press it so the indicator light goes off.
- When you are operating your notebook in MS-DOS mode (for example, when running MS-DOS games), you may find that the sound does not operate properly. Use Windows applications for full use of sound capabilities.

If sound does not record

- Plug in an external microphone. The notebook does not have a built-in microphone.
- Check the software controls for recording sound. Select Start > All Programs > Accessories > Multimedia (or Entertainment) > Sound Recorder.
- In Volume Control, select Options > Properties, then make sure the microphone is enabled in the recording controls.

If you hear loud, high-pitched feedback from the speakers

- In the Volume Control, try reducing the Master volume by selecting the speaker icon in the taskbar.
- In Volume Control, select Options > Properties, then select the microphone option for the playback settings. Also in Volume Control, make sure the microphone is muted.

CD-ROM and DVD problems

If you can't boot from a CD or DVD

- Make sure the CD or DVD is bootable, such as the *QuickRestore System Recovery* CD included with your notebook.
- Make sure the CD-ROM/DVD drive is selected as the boot device. See the “Basic Operation” chapter for directions.
- Restart the notebook: select Start > Turn Off Computer > Restart.

If a DVD plays erratically

- Dirt or smudges can cause a disc to skip. Clean the disc with a soft cloth. If the disc is badly scratched, it will probably have to be replaced.
- If you are playing the DVD on battery power, try changing the power scheme.

If you get a Region Code error when playing a DVD movie

- DVDs can have regional codes embedded in the disc data. These codes prevent DVD movies from being played outside the region of the world in which they are sold. If you get a Region Code error, you are trying to play a DVD intended for a different region.

If the notebook cannot read a CD or DVD

- For a single-sided CD or DVD, make sure the disc is placed in the drive with the label facing up.
- Clean the disc.
- Wait 5 to 10 seconds after closing the tray to give the notebook time to recognize the disc.

Troubleshooting and Maintenance

Troubleshooting Your Notebook

- Restart the system. Remove the disc from the drive, then select Start > Turn Off Computer > Restart.
- If you created the CD on a CD/DVD RW combo drive, try using a different media brand. Read and write quality may vary by media.

If a DVD movie doesn't fill the screen

Each side of a double-sided DVD has a different format (standard or widescreen). In widescreen format, black bands appear at the top and bottom of the screen. To view the standard format, flip the disc over and play the other side.

If a DVD doesn't play with two displays

If you are using the Extended Desktop (dual displays), move the player window to the display selected as primary. If you're not using Extended Desktop and both displays are active, press the TV Now! One-Touch button at the top of the keyboard to switch to one display.

If the notebook can't find Wordpad.exe after inserting a CD

The system is trying to open a .doc file in WordPad, but cannot find the Wordpad.exe program file. Type C:\Program Files\Accessories in the error message box.

Display problems

If the notebook is on, but the screen is blank

- Move the mouse or tap the TouchPad. This will wake the display if it is off.
- If the notebook is cold, allow it to warm up.

If the screen is difficult to read

- Try setting the display resolution to its default setting of 1024 × 768 or higher, depending on your model: select Start > Control Panel > Appearance and Themes > Display.
- Try adjusting the size of the desktop icons and labels.

If an external display does not work

- Check the connections.
- The external monitor may not be detected. In the BIOS Setup utility, try setting Video Display Device to Both in the System Devices menu.

Hard drive problems

If the notebook hard drive doesn't spin

- Make sure the notebook has power. If necessary, connect the AC adapter, then make sure it is fully plugged into a power source and into the back of the notebook.
- Remove and reinsert the hard drive.

If the hard drive makes a buzzing or whining noise

- Back up the drive immediately.
- See whether the noise is coming from elsewhere, such as from the fan or a PC Card drive.

If files are corrupted

- Open My Computer, select the disk you want to scan, then select File > Properties. Select the Check Now box under the Error-checking section of the Tools Tab.
- Run the virus-scanning program.
- If necessary, you can format the hard disk and reinstall the original factory software using the *QuickRestore System Recovery* CD included with your notebook.

Heat problems

Your notebook normally gets warm during routine operation.

If the notebook gets abnormally hot

- Always set the notebook on a flat surface, so that air can flow freely around and underneath it.
- Make sure the air vents on the bottom and sides of the notebook are clear.
- Keep in mind that games and other programs that drive CPU usage toward 100 percent can increase the notebook temperature.

Infrared problems

By default, the infrared port is not enabled, so you must enable it before you can use it.

If you have problems with infrared communications

- Make sure the line between the two infrared ports is not blocked, and that the ports face each other as squarely as possible. (The notebook infrared port is located on the front of the notebook.) The ports should be no more than 1 meter apart.
- Check settings in the Device Manager:
 1. Select Start > Control Panel > Performance and Maintenance > System.
 2. On the Hardware tab, select Device Manager and expand the infrared devices. Select the infrared port and make sure that the device is enabled.
- Make sure only one application is using the infrared port.

Keyboard and pointing device problems

Use these suggestions for built-in or external devices.

If the pointer is difficult to control

Adjust the pointer controls. Select Start > Control Panel > Printers and Other Hardware > Mouse.

If the TouchPad doesn't work

- Press the TouchPad on-off button to turn on the light.
- Don't touch the TouchPad while the notebook is rebooting or resuming from Standby mode. If this happens, try the following: press a key on the keyboard to restore normal operation.
- If an external mouse is connected, the built-in pointing devices are normally disabled. You can change this setting with the BIOS Setup utility. See "Configuring Your Notebook" in this chapter.
- Restart the notebook. Select Start > Turn Off Computer > Restart.

If the TouchPad moves the pointer or cursor while you type

Press the TouchPad on-off button to turn off the TouchPad while you type.

If a PS/2 scroll mouse doesn't work

- The TouchPad must be disabled for the mouse scroll feature to work. In the BIOS Setup utility, make sure the External Pointing Devices option in the System Devices menu is set to Auto. See "Configuring Your Notebook" in this chapter.
- Put the notebook into Standby or shut it down before you attach the scroll mouse, so that it will be detected properly.

If you want to use the TouchPad again, you must put the notebook into Standby or shut it down before you detach the scroll mouse.

Local area network (LAN) problems

If the built-in network adapter doesn't connect to the LAN

- Check all cables and connections. Try connecting at a different network station, if available.
- If the yellow light next to the LAN port does not light, the LAN cable may not be connected to the network or the network may be down. Try connecting a different computer to the cable.
- Make sure the LAN cable is Category 3, 4, or 5 for 10Base-T operation, or Category 5 for 100Base-TX operation. Maximum cable length is 100 meters (330 feet).
- Select Start > Help and Support, then use the Networking troubleshooter.
- Open the hardware Device Manager. Select Start > Control Panel > Performance and Maintenance > System. If the network interface is disabled, try to enable it. If it has a conflict, try disabling another device.

If you can't browse the Network Neighborhood or My Network Places

Select Start > Search > Computers or People to look for a computer.

If you can't log in to Netware servers

If a Netware server is using IPX/SPX protocol, you may need to force your frame type to match the server frame type. Check with your network administrator.

If a network connection responds slowly

If your network connection uses a proxy server, try enabling the option for bypassing the proxy server for local addresses. You can do this in Control Panel under your network connection properties.

Memory problems

If a message says you are out of memory

- Make sure drive C is not running low on free space.
- If you are having memory problems while running MS-DOS programs, use the MS-DOS or Application and Software troubleshooter in Windows Help: select Start > Help and Support.
- The full amount of RAM in your notebook is not available for running applications. A certain amount of RAM is used for display memory. The amount of display memory is shown in the BIOS Setup utility.

If memory doesn't increase after adding RAM

Make sure your notebook is using only PC2100 DDR-266 or higher memory (RAM) modules.

If the notebook beeps but doesn't start after adding RAM

You installed an incompatible type of RAM. Remove the module.

Modem problems

If the modem seems slow

- Excess static or noise on a line reduces the overall transmission speed of the modem connection. If necessary, contact your telephone company about fixing this type of problem.
- If you're dialing internationally, line noise is often a problem that's difficult or impossible to eliminate.
- If you have call-waiting, disable it. Your telephone company can provide instructions. It can cause symptoms similar to static.
- Eliminate extra connections in the line. If possible, connect directly to the wall jack.
- Try another telephone line, preferably one normally used for a fax machine or modem.

Troubleshooting and Maintenance

Troubleshooting Your Notebook

If the modem doesn't dial or no dial tone is detected

- Check all cables and connections.
- Connect a standard telephone to the phone line and make sure the line is working.
- Make sure someone else isn't using the same phone line.
- Try another telephone line, preferably one normally used for a fax machine or modem.
- If you're in a foreign country, the dial tone may not be recognized by the modem. In Control Panel, open Phone and Modem Options. Try disabling the option that waits for a dial tone.

If the modem dials incorrectly

- Check the telephone number you entered, including any digits required for outside access or long distance.
- In Control Panel, open Phone and Modem Options. Check the dialing options—look for duplicate digits for outside access or long distance.
- Make sure the number you're calling isn't busy.
- If you're in a foreign country, the dial tone may not be recognized by the modem. In Control Panel, open Phone and Modem Options. Try disabling the option that waits for a dial tone.
- If you have call-waiting, disable it—your telephone company can provide instructions.

If the modem dials but doesn't connect

- Make sure you're using an analog telephone line (2, 3, or 4 wires). You must not use a digital line. In a hotel, ask for a data line.
- Try another telephone line, preferably one normally used for a fax machine or modem.
- The modem at the other end may have a problem. Try dialing to a different modem.

If the modem isn't detected

- Check the modem setup. In Control Panel, open Phone and Modem Options. Check the COM port.

- Open the hardware Device Manager: select Start > Control Panel > Performance and Maintenance > System. If the modem is disabled, try to enable it. If it has a conflict, try disabling another device.
- If you're running fax software using fax Class 2, try using Class 1.

If the modem dials but you can't hear it

- If your model has an audio mute light, make sure it is turned off. If it's on, press the audio mute button.
- Check the speaker volume setting.
- In Control Panel, open Phone and Modem Options. Select the modem and select Properties, then check the volume setting on the General tab.

If the modem connects, but transferred data is bad

- In Control Panel, open Phone and Modem Options. Make sure the parity, speed, word length, and stop bits match on sending and receiving modems.
- Try a different telephone line, or dial a different server number.

If the modem causes an ERROR message

- A string of AT commands may contain an incorrect command. If you entered commands as extra settings for the modem in Control Panel or in your communications software, check the commands.

If the modem doesn't fax

- If you're using fax Class 2 in the fax software, try using Class 1.
- Close any other communications programs.
- If you're faxing by printing from an application, make sure you've selected the fax printer.
- Try turning off power management features temporarily.

If excessive line current is detected

Make sure you're using an analog telephone line (2, 3, or 4 wires). You must not use a digital line. In a hotel, ask for a data line.

If the modem clicks repeatedly but does not connect

- Make sure you are using an analog telephone line (2, 3, or 4 wires). You must not use a digital line. In a hotel, ask for a data line.
- Check all cables and connections.

PC Card problems

If the notebook doesn't recognize a PC Card

- Remove and reinsert the PC Card.
- Restart the notebook: select Start > Turn Off Computer > Restart.
- Try the card in another computer to see whether the card functions properly.
- Zoomed Video is not supported.
- If the card requires an IRQ, make sure one is available. Open the hardware Device Manager: select Start > Control Panel > Performance and Maintenance > System.

If a network PC Card stops communicating properly

- The card may have been reset if the notebook entered Standby or shut off. Exit any applications, then remove and reinsert the card.
- Check settings in Control Panel.

If a PC Card modem is not working

Disable the internal modem:

1. Open the hardware Device Manager: select Start > Control Panel > Performance and Maintenance > System.
2. Select Modem to list the current modem devices.
3. Select the internal modem, then select the option to disable the modem.

Performance problems

For best performance, your notebook should have at least 128 MB of memory (RAM).

If the notebook pauses or runs sluggishly

- This may be normal Windows behavior. Background processing can affect response time.
- Certain background operations (such as a virus-scanning program) can affect performance.

- Press CTRL+ALT+DEL and use Task Manager to see if an application is not responding.
- Restart the notebook: select Start > Turn Off Computer > Restart.
- Some file browsers respond slowly while processing graphics or waiting for broken network connections to time out.
- If the notebook hard drive frequently runs (as indicated by the hard drive light on the front of the notebook) while the notebook appears to be paused or running slowly, Windows is likely spending excess time writing to its swap file on the notebook hard disk. If this occurs frequently, consider installing additional memory.
- Check the amount of available free disk space. Delete temporary and unneeded files.

If the notebook stops responding

- Press CTRL+ALT+DEL and use Task Manager to end the application that is not responding.
- Press and hold the power button for at least 4 seconds to turn off and reset the notebook. **Any unsaved data will be lost.** Then press the power button again to turn the notebook back on.
- If nothing happens, insert the tip of a paper clip into the reset button on the bottom of the notebook. Then press the power button to turn the notebook back on.
- To avoid lockup problems, avoid pressing the TV Now! One-Touch button to switch display devices while graphic-intensive applications are running. Also avoid turning the notebook off or putting it into Standby while such applications are running.

Power and battery problems

If the notebook turns off immediately after it turns on

Battery power is probably extremely low. Plug in the AC adapter or insert a charged battery.

If the notebook keeps beeping

The notebook beeps repeatedly or displays a warning when battery power is low. Save your work, shut down Windows immediately, and insert a charged battery or plug in the AC adapter.

Troubleshooting and Maintenance

Troubleshooting Your Notebook

If the battery doesn't charge

- Make sure the AC adapter is fully plugged into the power source and the notebook, and that the light on the Adapter is on.
- If you're using a power strip, remove the AC adapter from the power strip and plug it directly into a wall outlet.
- Make sure the battery is fully installed and locked in place.
- Make sure you're using only the AC adapter included with your notebook (or other approved adapter that meets the power requirements of the notebook). Do *not* use a 60-watt, 3.16-amp adapter.
- Move the notebook away from any nearby heat source. Unplug the AC adapter and allow the battery to cool down. If the battery gets too hot, it will not charge properly.
- If available, try another battery and AC adapter.

If the notebook has a short operating time

- Conserve power using any of the suggestions listed in the "Batteries and Power Management" chapter in this guide.
- If you are running an application that has an automatic save feature (such as MS Word), disable this feature or increase the specified save time to reduce hard drive access.
- If the operating time has gradually become shorter and the battery is more than a year or two old, you may need to replace the battery.
- Heavy modem use can affect battery operating time.
- PC Card use can affect battery operating time.
- Test and recondition the battery every 3 months.

If the Time Remaining for the battery is not correct

The Time Remaining is an estimate, not a precise value, and is based on the rate at which the notebook is using power at the moment. This value therefore depends on your current task, and assumes that you will continue using power at the same rate until the battery runs out. So, if you check the Time Remaining while the notebook is performing a task requiring a good deal of power (such as reading from a CD or DVD), the value will probably show less time remaining than you really have, since you will probably later switch to tasks that require less power.

If the notebook doesn't enter Standby as expected

- If you have a connection to another computer, the notebook won't enter Standby if the connection is active.
- If the notebook is performing an operation, it normally waits for the operation to finish before entering Standby.

If the notebook doesn't automatically enter Hibernation as expected

- Make sure Hibernation support is enabled. From Control Panel, open Power Options, then select the Hibernate tab.
- Check the Power Schemes tab. Make sure the Hibernate timeouts for both AC power and battery power are not set to Never.

Printing problems

Hint

You will usually be able to solve most printing problems by using the Print troubleshooter in Windows Help: select Start > Help and Support.

If a serial or parallel printer doesn't print

- Make sure the printer is on and has paper in it.
- Make sure you are using the correct printer cable or cable adapter, and that the cable is secure at both ends.
- Check for printer errors.

If the left edge of printed output is missing

Certain applications may not work properly with 600-dpi printers. If you're using such a printer, try selecting a compatible printer driver for a 300-dpi printer.

If an infrared printer doesn't print

- Make sure the line between the two infrared ports is not blocked, and that the ports face each other as squarely as possible. (The notebook infrared port is located on the front of the notebook.) The ports should be no more than 1 meter apart.
- Make sure the printer is on and has paper in it.
- Check for printer errors.
- Make sure Windows is running; otherwise infrared printing is not available.

Serial, parallel, and USB problems

If a serial mouse doesn't work

- Make sure you followed the manufacturer's installation instructions completely and have installed the mouse properly. If not, repeat the procedure.
- Make sure the port connection is secure.
- Press the power button to enter Standby, and again to resume.
- Restart the notebook: select Start > Turn Off Computer > Restart.
- Check mouse settings in Control Panel: select Start > Control Panel > Printers and Other Hardware > Mouse.
- Use a mouse that connects to the USB or PS/2 port. If you have a PS/2 keyboard connected, use a PS/2 Y adapter (HP accessory F1469A).
- Check the port settings in Control Panel. Open the hardware Device Manager, then select Ports (COM & LPT).

If a serial modem doesn't work properly

- Make sure the port connection is secure.
- Use the Modem troubleshooter in Windows Help: select Start > Help and Support.
- In Control Panel, open Phone and Modem Options, and check the modem settings.
- Disable the internal modem:
 1. Open the hardware Device Manager: select Start > Control Panel > Performance and Maintenance > System.
 2. Select Modem to list the current modem devices.
 3. Select the internal modem, then select the option to disable the modem.
- Check the port settings in Control Panel. Open the hardware Device Manager, then select Ports (COM & LPT).

If the serial or parallel port is not working

- Make sure the port connection is secure.
- Check the port settings in Control Panel. Open the hardware Device Manager, then select Ports (COM & LPT).

If the USB port is not working

- Contact the vendor of the peripheral device for the latest USB drivers.
- Check the port settings in Control Panel. Open the hardware Device Manager, then select Universal Serial Bus Controller.

Startup problems

If the notebook does not respond when you turn it on

- Connect the AC adapter.
- Reset the notebook by inserting the tip of a paper clip into the reset button on the bottom of the notebook. Then press the power button to turn it on.
- If the notebook still doesn't respond, remove the battery and AC adapter, remove any PC Cards, and undock the notebook if docked. Then plug in the AC adapter again, and reset the notebook using the reset button.

If the notebook won't boot from battery power

- Make sure the battery is properly inserted and fully charged. Check the battery charge by removing it and pressing the pad on the side of the battery. The lights show the charge level.
- If available, try another battery.

If the notebook will not boot from the diskette drive

- Make sure the diskette drive is selected as the boot device. See the "Basic Operation" chapter in this guide for directions.
- If you're using a USB diskette drive, use the BIOS Setup utility to make sure Legacy USB Support is enabled. If your notebook also has a built-in diskette drive, use the BIOS Setup utility Boot menu to make sure the USB diskette drive is the first device under Removable Drive.

If the notebook stops responding after booting

Check whether you are connected to a TCP/IP network with no DHCP server. This can cause a long delay at startup because DHCP is enabled. Contact your network administrator to determine the proper TCP/IP configuration.

If the notebook takes a long time to resume after entering Standby

The notebook can routinely take a minute or more to resume if it has a network card installed. While the operating system is loading drivers and checking hardware and network connections, you will see a blinking cursor on your display. As soon as the hardware has been re-initialized, the Windows desktop will appear.

Wireless problems

If you have problems with wireless 802.11 communication

- Make sure the wireless indicator light is on.
- If your notebook includes Bluetooth capabilities, make sure wireless 802.11 communication is turned on. Select Start > All Programs > Utilities > Wireless Configuration, then select the 802.11 button if it's not turned on.
- Make sure you are using the correct SSID and channel settings.
- Make sure you are in range of an access point (for an infrastructure connection) or other wireless computer (for an Ad Hoc connection).
- When you log on to an 802.11 network via an access point, yet your notebook cannot connect to network resources, your notebook may not have been assigned an IP address. If the subnet mask for your wireless connection is 255.255.000.000, the network server did not assign an IP address to your notebook, and you may have to release and renew your network IP address. If this does not fix the problem, the access point may need to be rebooted.
- If you want to change the SSID to a different value to connect to a different access point, or if you want to change from Infrastructure mode to Ad Hoc mode, you may first have to release and renew the Internet IP address.
- See "Local area network (LAN) problems" in this chapter.

If you have trouble connecting to another computer in the Network Neighborhood or My Network Places

- Wait a few minutes, then press F5 to refresh the list of computers on the network.
- Select Start > Search > Computers or People to locate the computer.

If you cannot connect to a particular computer on the network

- Make sure the computer is properly connected to the network.
- Make sure your TCP/IP setup is correct for your network: in Control Panel, open Network Connections.

If you can connect, but the network is slow

- Check whether you might be in an area served by more than one wireless LAN. If so, the LANs could be interfering with each other.
- Move closer to the access point (for an infrastructure connection) or other wireless computer (for an Ad Hoc connection). You could be too far away for high-speed communication.

If your notebook cannot detect any Bluetooth devices

- Make sure the wireless indicator light is on.
- Make sure Bluetooth communication is turned on. Select Start > All Programs > Utilities > Wireless Configuration, then select the Bluetooth button if it's not turned on. If no Bluetooth button is shown, your notebook does not support Bluetooth communication.
- Make sure the Bluetooth devices are turned on. Some Bluetooth phones must be set for detection and may be detectable by other devices for only a short time.

If your notebook cannot detect a certain Bluetooth device

- Make sure the Bluetooth device is turned on. Some Bluetooth phones must be set for detection and may be detectable by other devices for only a short time.
- Refresh the list of Bluetooth devices. Select the Bluetooth icon in the taskbar, then select Bluetooth > Search For Devices in the menu bar.

Configuring Your Notebook

The BIOS Setup utility helps you configure your notebook operation.

To run the BIOS Setup utility

The BIOS (basic input and output system) Setup utility enables you to make changes to the notebook system configuration, and to tailor the operation of your notebook to your individual work needs.

The settings made in BIOS Setup generally control the notebook hardware, and so greatly affect how the notebook operates.

1. Select Start > Turn Off Computer > Restart.
2. When the logo screen appears, press F2 to enter BIOS Setup.
3. The pointing devices are not active in BIOS Setup, so you will need to use the keyboard to navigate:
 - Press the LEFT and RIGHT arrow keys to move among menus.
 - Press the UP and DOWN arrow keys to move among parameters in a menu.
 - Press + or – to move through values for the current parameter, or press ENTER to change a setting.
4. After you select the options you want, press F10 or use the Exit menu to exit BIOS Setup.
5. If the settings cause a conflict between devices during reboot, the system prompts you to run BIOS Setup, and marks the conflicting settings.

The following tables describe BIOS settings for the BIOS version at publication. If your BIOS is a different version, some settings may differ from those shown.

Main Menu		
Setting	Description	Default
BIOS Revision	Shows the current BIOS version.	Detected automatically
System Time	Sets the time using 24-hour format. Values set take effect immediately.	
System Date	Sets the date using dd/mm/yy format (except English, which uses mm/dd/yy format).	
Language	Sets the language for BIOS Setup.	Detected automatically
Internal Hard Disk	Sets the hard drive type and various parameters.	Detected automatically
UMA Video Memory	Sets the video memory size allocated from total installed memory (RAM).	Auto
Memory	Shows the extended memory size.	Detected automatically
Serial Number	Displays the serial number as shown on the back of the unit.	Detected automatically
Service ID	Displays an identifier used for repair service.	Detected automatically
UUID	Displays the value of the 16-byte UUID (Universally Unique ID) as 32 hex characters.	Detected automatically
MAC Address	Displays the MAC network address of the internal (wired) LAN.	Detected automatically

Troubleshooting and Maintenance
Configuring Your Notebook

System Devices Menu		
Setting	Description	Default
Video Display Device	Sets whether the built-in display automatically switches to an external display, if one is detected.	Auto
External Pointing Device	Disables the internal pointing devices when an external pointing device is connected.	Auto
Legacy USB Support	Enables BIOS support for USB mouse, keyboard, and diskette disk drive during startup.	Enabled
Wake On LAN from Power Off	Lets the notebook be turned on via the LAN port. If this option is enabled, the notebook uses increased power while it is shut down.	Disabled

Security Menu		
Setting	Description	Default
User Password is	Shows if a user password is set.	Clear
Administrator Password is	Shows if an administrator password is set.	Clear
Set User Password	Press ENTER to set, change, or clear the user password. The password can have no more than 8 characters (0-9, A-Z), and cannot include special or accented characters.	Enter
Set Administrator Password	Press ENTER to set, change, or clear the administrator password, which protects BIOS Setup settings. The password can have no more than 8 characters (0-9, A-Z), and cannot include special or accented characters.	Enter
Require Password on Boot	Sets whether a user password is required when the notebook boots. Requires the administrator password for changes.	Disabled
Internal hard drive lock	Only if the Boot password option is enabled, encodes the current user password (or administrator password if that is the only password set) on the hard drive.	Disabled

Boot Menu

Setting	Description	Default
Hard Drive +Removable Devices CD-ROM Drive Built-in LAN	Shows the order of boot devices. Move the entries to change the order. If the notebook has more than one device in a + category, you can select the one scanned. Built-in LAN provides diskless boot from a network server.	1. Hard Drive 2. Removable Devices 3. CD-ROM Drive 4. Built-in LAN

Exit Menu

Setting	Description	Default
Save Changes and Exit	Saves Setup changes, then exits and reboots.	
Discard Changes and Exit	Discards any Setup changes made since last save, then exits and reboots. Does not affect password, date, or time changes.	
Get Default Values	Restores default settings, and remains in Setup. Does not affect password, date, or time changes.	

To change video memory settings using BIOS Setup utility

The notebook comes with either 32MB or 16MB of video memory.

Note

Changing your video memory to 8MB, 16MB, 32MB, or 64MB may change the performance of your notebook, depending on your selection.

To change your video memory:

1. Select Start > Turn Off Computer > Restart.
2. Press F2 when the splash screen appears.
3. Move the down arrow key until UMA Video Memory is highlighted. Press Enter to bring up a list of memory settings. Selections include 8 MB, 16MB, 64MB, or Auto.
4. Press F10 to save configuration changes and exit BIOS screen.

Reinstalling and Updating Software

Your notebook includes two features that allow you to install individual software applications or to restore the entire original contents of your hard drive:

- *QuickRestore System Recovery* CD, included with your notebook, allows you to restore your hard drive to its original factory contents.
- Application Recovery utility allows you to restore or install one or more applications. Select Start > Software Setup, then follow the installation wizard on the screen.

To replace a damaged *QuickRestore System Recovery* CD

If you lose or damage the *QuickRestore System Recovery* CD, refer to the service telephone numbers in the *Worldwide Telephone Numbers* booklet to contact a Customer Care Center for help and support.

Reference Information

Modem Reference Information

You can customize the operation of the modem using AT commands and S-registers. You can do this from Phone and Modem Options in Control Panel, from most communications software, or by using terminal mode in your software.

Note

You should have a good understanding of modems and how they operate before you change default settings.

This section contains summary information about AT commands, S-registers, and selected result codes for the built-in modem.

Modem Reference (Conexant)

All listed AT commands must be preceded by the characters “AT” (except for the command “A/”). The commands can be entered in upper or lower case. Many commands can be used as queries by entering “?” as the argument.

Conexant AT Commands (Advanced Users Only)

Command	Function (Conexant)
A	Go off-hook and attempt to answer a call.
A/	Re-execute command (not preceded by AT).
Dn	Dial modifier: 0–9, A–D =DTMF digits; L=redial last number; P=pulse dialing; T=tone dialing; W=wait for dial tone; * (“star”); # (“pound sign”); +; !=flash; @=wait for silence; \$ or &=wait for credit card dialing tone; ,=return to command state; ‘=dial pause; ^=toggle calling tone. Parentheses, hyphens, and spaces can be used to format dial string and have no other effect.
E0	Turn off command echo.
E1	Turn on command echo (default).
H0	Initiate hang-up sequence.
H1	If on-hook, go off-hook and enter command mode.
I0	Report product code.
I1	Report LSB of stored checksum.
I2	Report “OK”.
I3	Report identification codes.
I4	Report product description.
I5	Report country code parameter.
I6	Report modem data pump model and internal code revision.
I7	Report modem data pump model and internal code revision.
I8	Report “OK”.
I9	Report country.
Ln	Set speaker volume: 0=off, 1=low (default), 2=medium, 3=high.
Mn	Activate speaker: 0=off, 1=on during handshaking and off when receiving carrier (default), 2=always on, 3=off when dialing and receiving carrier, on when answering.

Conexant AT Commands (Advanced Users Only)

Command	Function (Conexant)
N0 or N1	Included for compatibility only; returns result code.
On	0=go on-line, 1=go on-line and initiate retrain sequence.
P	Force pulse dialing.
Qn	0=enable result codes to DTE (default), 1=disable.
Sn	Select S-register <i>n</i> as default.
Sn=v	Set default S-register <i>n</i> to value <i>v</i> .
T	Force DTMF dialing.
Vn	Report result codes: 0=short form (terse), 1=long form (verbose) (default).
W0	Report DTE speed (default).
W1	Report line speed, error correction protocol, and DTE speed.
W2	Report DCE speed.
W3	Report DCE speed and error correction protocol.
X0	Report CONNECT result code on connecting. Dial tone and busy detection not reported.
X1	Report CONNECT <text> result code on connecting. Dial tone and busy detection not reported.
X2	Report CONNECT <text> result code on connecting. Dial tone and busy detection not reported.
X3	Report CONNECT <text> result code on connecting. Dial tone not reported, busy signal reported if detected.
X4	Report CONNECT <text> result code on connecting. Dial tone and busy signal reported if detected (default).
Z	Reset to default configuration.
+DR: <i>a</i>	Select error control protocol: NONE=no data compression, V42B=42bis in both directions, ALT=MNP 5 compression.
+DR= <i>n</i>	0=disables extended format "+DR:" intermediate result code, 1=enables.
+DS= <i>a,b,c,d</i>	Controls V.42bis data compression function (<i>b</i> , <i>c</i> , and <i>d</i> are optional): <i>a</i> sets direction(s) of data compression function, seen by DTE: 0=negotiated, no compression; 3=both directions (default). <i>b</i> =0 specifies modem does not disconnect if V.42bis is not negotiated by remote modem as specified by <i>a</i> . <i>c</i> sets maximum number of dictionary entries (2048) that should be negotiated. <i>d</i> sets maximum string length (32 bytes) to be negotiated.
+DS44= <i>a,b,c,d,e,f,g,h,i</i>	Controls V.44 data compression function (<i>b</i> , <i>c</i> , <i>d</i> , <i>e</i> , <i>f</i> , <i>g</i> , <i>h</i> , and <i>i</i> are optional): <i>a</i> sets direction(s) of data compression function, seen by DTE: 0=negotiated, no compression; 1=transmit only; 2=receive only; 3=both directions (default). <i>b</i> specifies whether modem disconnects if V.44 not negotiated remote DCE as specified in <i>a</i> : 0=do not disconnect (default), 1=disconnect. <i>c</i> : 0=stream method (default), 1=packet method, 2=multi=packet method. <i>d</i> (256 to 2048) sets maximum codewords to be negotiated in transmit direction (default=2048). <i>e</i> (256 to 2048) sets maximum codewords to be negotiated in receive direction (default=2048). <i>f</i> (32 to 255) sets maximum string length to be negotiated in transmit direction (default=32). <i>g</i> (32 to 255) sets maximum string length to be negotiated in receive direction (default=32). <i>h</i> (2048 to 4096) sets maximum size of history buffer to be negotiated in transmit direction (default=4096). <i>i</i> (2048 to 4096) sets maximum size of history buffer to be negotiated in receive direction (default=4096).

Reference Information
Modem Reference Information

Conexant AT Commands (Advanced Users Only)

Command	Function (Conexant)
+ESA= <i>a,b,c,d,e,f,g,h</i>	Controls operation of synchronous access mode: <i>a</i> =0 specifies in transparent sub-mode, modem transmits 8-bit SYN sequence on idle. <i>b</i> =0 specified in framed sub-mode, modem transmits HDLC flags on idle (default and fixed). <i>c</i> =0 specifies in framed sub-mode, modem transmits abort on underrun in middle of frame (default); <i>c</i> =1 specifies in framed sub-mode, modem transmits flag on underrun in middle of frame, notifies DTE. <i>d</i> : not to be commanded. <i>e</i> =0 specifies CRC generation and checking disabled (default and fixed). <i>f</i> =0 specifies NZRI encoding and decoding disabled (default and fixed). <i>g</i> =255 sets the octet value used in character-oriented framing. <i>h</i> : not to be commanded.
+GCAP	Transmit text listing commands that provide additional modem capabilities.
+GCI= <i>n</i>	Set country of installation using 8-bit country code from Annex A of T.35.
+GMI	Report modem manufacturer.
+GMM	Report modem model.
+GMR	Report modem version, revision, or date.
+GOI	Transmit text identifying the device.
+GSN	Report modem model serial number.
+IFC= <i>n,m</i>	Set operation of local flow control between DTE and modem. <i>n</i> =method DTE uses to control data flow from modem: 0=none, 1=XON/XOFF on transmitted data, 2=Circuit 133 (Ready for Receiving) (default). <i>m</i> =method modem uses to control data flow from DTE: 0=none, 1=XON/XOFF on received data, 2=CTS/RTS (default).
+ILRR= <i>n</i>	Report local port rate: 0=disable, 1=enable.
+IPR= <i>n</i>	Set data rate at which the modem accepts commands when connected: 0 (allows operation only at rates automatically detectable by modem), 2400, 4800, 9600, 19200, 38400, 57600, or 115200.
+ITF= <i>a,b,c</i>	Sets transmit flow control thresholds (<i>b</i> and <i>c</i> are optional): <i>a</i> (20 to 7000) sets threshold (octets) above which modem generates flow-off signal in synchronous access mode (default=128). <i>b</i> (10 to 5000) sets threshold (octets) below which modem generates flow-on signal in synchronous access mode (default=64). <i>c</i> =0 (fixed).
+PCW= <i>n</i>	Set modem behavior with call waiting: 1=request modem-on-hold and collect caller ID information, 2=hang up, 3=ignore call waiting.
+PIG= <i>n</i>	0=enable PCM upstream negotiation, 1=disable (default).
+PMH= <i>n</i>	Set modem-on-hold: 0=enabled in V.92 mode (default), 1=disabled.
+PMHF	Initiate flash hook sequence when in modem-on-hold procedure.
+PMHR= <i>n</i>	Request modem to initiate or confirm modem-on-hold (MOH) procedure and timeout: 0=V.92 modem-on-hold request denied or unavailable, 1 to 13 grant MOH with timeout (1=10 sec, 2=20 sec, 3=30 sec, 4=40 sec, 5=1 min, 6=2 min, 7=3 min, 8=4 min, 9=6 min, 10=8 min, 11=12 min, 12=16 min, 13=indefinite).
+PMHT= <i>n</i>	Set whether modem grants modem-on-hold (MOH) request, and MOH timeout: 0=deny V.92 modem-on-hold request (default), 1 to 13=grant MOH with timeout (1=10 sec, 2=20 sec, 3=30 sec, 4=40 sec, 5=1 min, 6=2 min, 7=3 min, 8=4 min, 9=6 min, 10=8 min, 11=12 min, 12=16 min, 13=indefinite).
+PQC= <i>n</i>	Use Short Phase startup procedures: 0=enable V.92 Short Phase 1 and 2 (default), 1=enable Short Phase 1 only, 3=disable.
+PSS= <i>n</i>	0=modems decide whether to use short startup procedures, 2=use full startup procedures on all subsequent connections.
+VCID= <i>n</i>	Set caller ID reporting: 0=disable (default), 1=enable with formatted presentation, 2=enable with unformatted presentation.

Conexant AT Commands (Advanced Users Only)

Command	Function (Conexant)
+VRID= <i>n</i>	Report caller ID: 0=use formatted presentation, 1=use unformatted presentation.
-QCPC	Use full startup procedures on next connection, then select startup procedure defined by +PQC.
-QCPS= <i>n</i>	0=do not allow modem to save generated quick-connect profile, 1=allow (default).
&C <i>n</i>	Set RLSD: 0=always on, 1=follow carrier state (default).
&D <i>n</i>	0=ignore DTR; 1=upon on-to-off transition, enter online command state and issue OK result code; call remains connected; 2=upon on-to-off transition clear call, discard untransmitted data according to +ETBM.
&E <i>n</i>	0=disable line quality monitor, auto-retrain, and auto-rate renegotiation;1=enable line quality monitor, auto-retrain, and auto-rate renegotiation (default).
&F0	Restore factory configuration.
&G <i>n</i>	Included for compatibility only; no effect (returns OK).
&K <i>n</i>	Set DTE/DCE flow control: 0=disable, 3=enable RTS/CTS DTE/DCE flow control (default), 4=enable XON/XOFF DTE/DCE flow control, 5 and 6 included for compatibility only (no effect, returns OK).
&M <i>n</i>	Included for compatibility only; no effect (returns result code).
&P <i>n</i>	Set pulse dial (pps) with make/break: 0=10 pps with 39%–61% make/break (default), 1=10 pps with 33%–67% make/break, 2=20 pps with 39%–61% make/break, 3=20 pps with 33%–67% make/break.
&Q5	Select asynchronous operation in error correction mode.
&Q <i>n</i>	(<i>n</i> =0–3, 6) Select asynchronous operation in normal mode (speed buffering).
&T0	Terminate any test in progress.
&T1	Initiate local analog loopback.
&V	Display current configuration and stored profiles.
%TT <i>n</i>	PTT testing of signal level: 00–09=DTMF dial 0–9, 0A=DTMF *, 0B=DTMF #, 0C=DTMF A, 0D=DTMF B, 0E=DTMF C, 0F=DTMF D, 10=V.21 Channel 1mark symbol, 11=V.21 Channel 2mark symbol, 12=V.23 Channel 1mark symbol, 13=V.23 Channel 2mark symbol, 14=Bell103 Channel 1mark symbol, 15=Bell103 Channel 2mark symbol, 20=V22Org, 21=V22Ans, 22=Bell212Org, 23=Bell212Ans, 24=V22BisOrg, 25=V22BisAns, 26=V32@4800, 27=V32@7200, 28=V32@9600, 29=V.32Bis@12000, 2A=V32Bis@14400, 30=Silence, 31=2100Hz MISC, 33=1300Hz MISC, 34=1100Hz MISC, 40=Reserved, 41=V27@2400 FAX, 42=V27@4800 FAX, 43=V29@7200 FAX, 44=V29@9600 FAX, 45=V17@7200LT FAX, 46=V17@7200ST FAX, 47=V17@9600LT FAX, 48=V17@9600ST FAX, 49=V17@12000LT FAX, 4A=V17@12000ST FAX, 4B=V17@14400LT FAX, 4C=V17@14400ST FAX. 5 <i>abc</i> : <i>a</i> =bit rate (0=2400, D=33600), <i>b</i> =V.34 symbol rate (0=2400, 5=3429), <i>c</i> =pre-emphasis filter (0 to A).
\N0	Select normal speed buffered mode.
\N1	Select normal speed buffered mode.
\N2	Select reliable (error-correction) mode.
\N3	Select auto reliable mode.
\N4	Force LAPM mode.
\N5	Force MNP mode.
+MCR	Report carrier.
+MMR	Report transmit and receive rates.
+MR=0	Disable reporting of modulation connection.
+MR=1	Enable reporting of modulation connection (+MCR: and +MRR: are transmitted) (default).
+MR=2	Enable reporting of modulation connection (+MCR: and Receive Rate Only: are transmitted).

Reference Information
Modem Reference Information

Conexant AT Commands (Advanced Users Only)

Command	Function (Conexant)
+MS= <i>a,b,c,d,e,f</i>	Select modulation (<i>b</i> , <i>c</i> , <i>d</i> , <i>e</i> , and <i>f</i> are optional). <i>a</i> is the carrier (allowable rates in parentheses): B103 (300), B212 (1200 Rx/75 Tx or 75 Rx/1200 Tx), V21 (300), V22 (1200), V22B (1200/2400), V23C (1200), V32 (4800/9600), V32B (4800–14400), V34 (2400–33600), K56 (32000–56000), V90 (28000–56000), V92 (downstream: 28000–56000; upstream: 24000–48000). <i>b</i> is autumode: 0=disabled, 1=enabled (default). <i>c</i> is minimum transmit (Tx) rate (bps). <i>d</i> is maximum transmit rate (bps). <i>e</i> is minimum receive (Rx) rate. <i>f</i> is maximum receive rate (bps).
+WS= <i>n</i>	Set PDC mode: 1=disable (default), 20=enable.

ECC Commands

% <i>Cn</i>	Set data compression: 0=disable, 1=enable V.42 bis and MNP 5, 2=enable V.42 bis and MNP 5, 3=enable V.42 bis and MNP 5 (default).
+EB= <i>a,b,c</i>	Select break handling (<i>b</i> and <i>c</i> are optional): <i>a</i> =0 — break is ignored. <i>b</i> =0 — transmitted V.42 L-SIGNAL will not indicate break signal length. <i>c</i> =0 — break is not delivered to DTE.
+EFCS=0	Select 16-bit FCS specified in V.42.
+ER: <i>a</i>	Select error control protocol: NONE=error control not in use, LAPM=V.42 LAPM protocol, ALT=MNP.
+ER= <i>n</i>	Error control reporting: 0=disable, 1=enable.
+ES= <i>a,b,c</i>	Select error control and synchronous mode (<i>b</i> and <i>c</i> are optional). <i>a</i> is requested mode when modem is originator: 0=initiate call with direct mode, 1=initiate call with normal mode, 2=initiate V.42 without detection phase, 3=initiate V.42 with detection phase (default), 4=initiate MNP, 6=initiate V.80 synchronous access mode when connection is completed. <i>b</i> specifies fallback mode when modem is originator: 0=LAPM, MNP, or normal mode error control optional (default); 1=LAPM, MNP, or direct mode error control optional; 2=LAPM or MNP error control required; 3=LAPM error control required; 4=MNP error control required. <i>c</i> specifies fallback mode when modem is answerer or specifies V.80 synchronous access mode: 1=error control disabled, use normal mode; 2=LAPM, MNP, or normal mode error control optional (default); 3=LAPM, MNP, or direct mode error control optional; 4=LAPM or MNP error control required; 5=LAPM error control required; 6=MNP error control required; 8=initiate V.80 synchronous access mode when connection complete.
+ESR=0	Disable selective repeat option in V.42.
+ETBM= <i>a,b,c</i>	Handle data remaining in modem buffers on call termination (<i>b</i> and <i>c</i> are optional): <i>a</i> =0 — disconnect occurs immediately and buffered transmit data is discarded. <i>b</i> =0 — disconnect occurs immediately and buffered receive data is discarded. <i>c</i> =0 — modem does not attempt to deliver buffered data and discards data.

FAX Class 1

+FAE= <i>n</i>	Data/fax auto answer: 0=disable (default), 1=enable.
+FAR= <i>n</i>	0=disable adaptive reception (default), 1=enable.
+FCL= <i>n</i>	Set loss-of-carrier delay in units of 100 ms (<i>n</i> =0 to 255).
+FCLASS= <i>n</i>	Set active service class: 0=data mode (default), 1=Fax Class 1, 1.0=Fax Class 1.0 mode, 8=voice mode.
+FIT= <i>n,a</i>	Set DTE inactivity timeout <i>n</i> seconds after which modem goes on-hook (<i>a</i> =0) or DCE goes on hook (<i>a</i> =1).

Conexant AT Commands (Advanced Users Only)

Command	Function (Conexant)
+FLO= <i>a</i>	Set flow control type: 0=XON/XOFF and RTS/CTS flow control turned off; 1=XON/XOFF flow control in either direction; 2=RTS for flow control of modem by DTE, and CTS for flow control of DTE by modem.
+FMI	Report modem manufacturer.
+FMM	Report modem model.
+FMR	Report modem version, revision, or date.
+FPR= <i>n</i>	Set DTE/modem interface rate in bits/sec: 0=automatic detection (default).
+FRH= <i>n</i>	Receive data with HDLC framing.
+FRM= <i>n</i>	Receive data.
+FRS= <i>n</i>	Receive silence, <i>n</i> × 10 ms.
+FTH= <i>n</i>	Transmit data with HDLC framing.
+FTM= <i>n</i>	Transmit data.
+FTS= <i>n</i>	Stop transmission and wait, <i>n</i> × 10 ms.

Voice Commands

+FCLASS=8	Select voice mode.
+VDR= <i>a,b</i>	Set report ring cadence and timing of RING event code: <i>a</i> =0 disables ring cadence reporting, <i>a</i> =1 enables. <i>b</i> sets report content: 0=DROF and DRON messages only.
+VDT= <i>a,b</i>	Set report control tone cadence: <i>a</i> =0 disables ring cadence reporting, <i>a</i> =1 enables. <i>b</i> =0 reports CPOF and CPON messages only.
+VDX= <i>a</i>	Select speakerphone half-duplex (<i>a</i> =0) or full duplex (<i>a</i> =1).
+VGM= <i>n</i>	Set microphone gain of speakerphone function (0 to 255).
+VGR= <i>n</i>	Set gain for received voice samples (0 to 255).
+VGS= <i>n</i>	Set speaker gain of speakerphone function (0 to 255).
+VGT= <i>n</i>	Set volume (120 to 135).
+VIP	Initialize all voice parameters to defaults.
+VIT= <i>n</i>	Set initial value for DTE/modem inactivity timer (0 to 255 seconds).
+VLS= <i>n</i>	Select sources/destinations for analog data.
+VNH= <i>n</i>	Set automatic hangups: 0=enable, 1=disable, 2=disable automatic hangups in non-voice modes.
+VPR= <i>n</i>	Set DTE/modem interface rate (0=autobaud).
+VRA= <i>n</i>	Set delay between ringbacks before modem assumes remote station is off hook (0 to 255 x 0.1 sec).
+VRN= <i>n</i>	Set delay between ringbacks before modem assumes remote station is off hook (0 to 60 sec).
+VRX= <i>n</i>	Start voice reception: 0=start without periodic tone production, 1=start with periodic tone production.
+VSD= <i>a,b</i>	Set silence detection sensitivity and required period of silence before modem reports silence at end of voice receive.
+VSM= <i>a,b,c,d</i>	Set voice and silence compression methods, and voice sampling rate.
+VSP= <i>a</i>	Disable (<i>a</i> =0) or enable (<i>a</i> =1) speakerphone.
+VTD= <i>n</i>	Set beep duration (1 to 500 x 0.01 sec).
+VTR	Start voice transmission and reception.
+VTS= <i>string</i>	Send voice tones.
+VTX	Start voice transmission.

AT* Commands

*B	Display black-listed numbers.
*D	Display delayed numbers.

Reference Information
Modem Reference Information

S-Registers (Conexant)

Register	Function (Conexant)	Range/units	Default
S0	Number of rings to auto-answer.	0–255/rings	0
S1	Ring counter.	0–255/rings	0
S2	Escape character.	0–255/ASCII	43
S3	Line termination character.	0–127/ASCII	13
S4	Response formatting character.	0–127/ASCII	10 (line feed)
S5	Command line editing character.	0–32/ASCII	8 (backspace)
S6	Wait time for dial tone.	2–255/sec	2
S7	Wait time for carrier.	1–255/sec	50
S8	Pause time for dial delay modifier.	0–255/sec	2
S10	Carrier loss disconnect time.	1–255/.1 sec	14 (1.4 sec)
S11	DTMF tone duration.	50–255/.001 sec	95 (95 msec)
S12	Escape prompt delay.	0–255/.02 sec	50 (1 sec)
S18	Test timer.	0–255/sec	0
S29	Flash dial modifier time.	0–255/10 msec	70 (700 msec)
S30	Disconnect inactivity timer.	0–255/10 sec	0
S46	Data compression control.	136 (error correction w/o compression) or 138 (error correction & compression)	138
S95	Extended result code messages control.		0

Selected Result Codes (Conexant)

Code	Meaning
0	OK
1	CONNECT
2	RING
3	NO CARRIER
4	ERROR
5	CONNECT 1200
6	NO DIAL TONE
7	BUSY
8	NO ANSWER
24	DELAYED
32	BLACKLISTED
33	FAX
35	DATA
83	LINE IN USE

Safety Information

Power cords

The power cord supplied with the notebook AC adapter should match the plug and voltage requirements for your local area. Regulatory approval for the AC adapter has been obtained using the power cord for the local area. However, if you travel to a different area or need to connect to a different outlet or voltage, you should use one of the power cords listed below. To purchase a power cord (including one for an area not listed below) or a replacement AC adapter, contact your local authorized dealer or Sales and Service office. For any power cord with a fused plug, if you have to replace the fuse, be sure to install an approved fuse.

Country or Region	Rated Voltage and Current
Canada Mexico Philippines Taiwan United States	125 Vac (3 A)
East and West Europe Egypt Saudi Arabia	250 Vac (2.5 A)
Hong Kong Singapore United Kingdom	250 Vac (2.5 A)
Australia New Zealand	250 Vac (2.5 A)
Japan	125 Vac (3 A)
India	250 Vac (2.5 A)
South Africa	250 Vac (2.5 A)
Argentina	250 Vac (2.5 A)
Chile	250 Vac (2.5 A)
China	250 Vac (2.5 A)
South Korea	250 Vac (2.5 A)

Battery safety

- To avoid risk of fire, burns, or damage to your battery pack, do not allow a metal object to touch the battery contacts.
- Do not disassemble the battery. There are no serviceable parts inside. Do not dispose of the battery pack in fire or water.
- Handle a damaged or leaking battery with extreme care. If you come in contact with the electrolyte, wash the exposed area with soap and water. If it contacts the eye, flush the eye with water for 15 minutes and seek medical attention.
- Do not expose the battery pack to storage temperatures above 60 °C (140 °F).
- When discarding a battery pack, contact your local waste disposal provider regarding local restrictions on the disposal or recycling of batteries.
- To obtain a replacement battery, contact your local dealer or sales office.
- Do not charge the battery pack if the ambient temperature exceeds 45 °C (113 °F).
- Replace only with the same or equivalent type battery pack recommended by the manufacturer.
- This product contains a lithium-ion or nickel-metal-hydride battery and may require special handling at end-of-life.



Laser safety

The CD-ROM and DVD drives used with the computer are certified as a Class 1 laser devices according to the U.S. Department of Health and Human Services (DHHS) Radiation Performance Standard and International Standards IEC 825 / IEC 825-1 (EN60825 / EN60825-1). These devices are not considered harmful, but the following precautions are recommended:

- Ensure proper use by reading and following the instructions carefully.

- If the unit requires service, contact an authorized service center.
- Do not attempt to make any adjustment of the unit.
- Avoid direct exposure to the laser beam—do not open the unit.

CLASS 1 LASER PRODUCT
LASER KLASSE 1

LED safety

The infrared port located on the front of certain models is classified as a Class 1 LED (light-emitting diode) device according to International Standard IEC 825-1 (EN60825-1). This device is not considered harmful, but the following precautions are recommended:

- If the unit requires service, contact an authorized service center.
- Do not attempt to make any adjustment of the unit.
- Avoid direct eye exposure to the infrared LED beam. Be aware that the beam is invisible light and cannot be seen.
- Do not attempt to view the infrared LED beam with any type of optical device.

CLASS 1 LED PRODUCT
LEDSCHÜTZKLASSE 1 PRODUKT

Mercury safety

This product contains mercury in the fluorescent lamp of the liquid-crystal display, and may require special handling at end-of-life.

Exposure to radio frequency radiation

The radiated output power of the IEEE 802.11 and Bluetooth internal wireless radio is far below the FCC radio frequency exposure limits. Nevertheless, the wireless radio shall be used in such a manner that the potential for human contact during normal operation is minimized.

The internal wireless radio operates within guidelines found in radio frequency safety standards and recommendations, which reflect the consensus of the scientific community. We therefore believe the internal wireless radio is safe for use by consumers. The level of energy emitted is far less than the electromagnetic energy emitted by wireless devices such as mobile phones. However, the use of wireless radios may be restricted in some situations or environments, such as aboard airplanes. If you are unsure of restrictions, you are encouraged to ask for authorization before turning on the wireless radio.

Regulatory Information

This section presents information that shows how your computer complies with regulations in certain regions. Any modifications to your computer not expressly approved by the manufacturer could void the authority to operate the computer in these regions.

U.S.A.

This computer has been tested and found to comply with the limits for a Class B digital device, pursuant to Part 15 of the FCC Rules. These limits are designed to provide reasonable protection against harmful interference in a residential installation.

This computer generates, uses, and can radiate radio frequency energy. If not installed and used in accordance with the instructions, it may cause harmful interference to radio communications. However, there is no guarantee that interference will not occur in a particular installation. If this computer does cause harmful interference to radio or television reception (which can be determined by removing the unit's batteries and AC adapter), try the following:

- Reorienting or relocating the receiving antenna.
- Relocating the computer with respect to the receiver.
- Connecting the computer's AC adapter to another power outlet.

Connections to Peripheral Devices

To maintain compliance with FCC Rules and Regulations, use properly shielded cables with this device.

For more information, consult your dealer, an experienced radio/television technician, or the following booklet, prepared by the Federal Communications Commission: *How to Identify and Resolve Radio-TV Interference Problems*. This booklet is available from the U.S. Government Printing Office, Washington, DC 20402, Stock Number 004-000-00345-4. At the first printing of this manual, the telephone number was (202) 512-1800.

This equipment complies with Part 68 of the FCC rules and the requirements adopted by the ACTA. On the bottom of the computer or on the modem is a label that contains, among other information, a product identifier in the format US:AAAEQ##TXXXX. If requested, this information must be provided to the telephone company.

Reference Information

Regulatory Information

Applicable certification jack USOC = RJ11C. A plug and jack used to connect this equipment to the premises wiring and telephone network must comply with the applicable FCC Part 68 rules and requirements adopted by the ACTA. A compliant telephone cord and modular plug is provided with this product. It is designed to be connected to a compatible modular jack that is also compliant. See installation instructions for details.

The REN is used to determine the number of devices that may be connected to a telephone line. Excessive RENs on a telephone line may result in the devices not ringing in response to an incoming call. In most but not all areas, the sum of RENs should not exceed five (5.0). To be certain of the number of devices that may be connected to a line, as determined by the total RENs, contact the local telephone company. For products approved after July 23, 2001, the REN for this product is part of the product identifier that has the format US:AAAEQ##TXXXX. The digits represented by ## are the REN without a decimal point (for example, 03 means the REN is 0.3). For earlier products, the REN is separately shown on the label.

If this equipment causes harm to the telephone network, the telephone company will notify you in advance that temporary discontinuance of service may be required. But, if advance notice isn't practical, the telephone company will notify the customer as soon as possible. Also, you will also be advised of your right to file a complaint with the FCC if you believe it is necessary.

The telephone company may make changes to its facilities, equipment, operations or procedures that could affect the operation of the equipment. If this happens the telephone company will provide advance notice in order for you to make necessary modifications to maintain uninterrupted telephone service.

If trouble is experienced with this equipment, call 1-800-652-6672. If the equipment is causing harm to the telephone network, the telephone company may request that you disconnect the equipment until the problem is resolved. You should only perform repairs to the equipment specifically discussed in the troubleshooting section of the user guide.

Connection to party line service is subject to state tariffs. Contact the state public utility commission, public service commission or corporation commission for information.

If your home has specially wired alarm equipment connected to the telephone line, ensure the installation of this computer equipment does not disable your alarm equipment. If you have questions about what will disable alarm equipment, consult your telephone company or a qualified installer.

The Telephone Consumer Protection Act of 1991 makes it unlawful for any person to use a computer or other electronic device, including fax machines, to send any message unless such message clearly contains in a margin at the top or bottom of each transmitted page or on the first page of the transmission, the date and time it is sent and an identification of the business or other entity, or other individual sending the message and the telephone number of the sending machine or such business, other entity, or individual. (The telephone number provided may not be a 900 number or any other number for which charges exceed local or long-distance transmission charges.)

Declaration of Conformity (U.S.A.)

Responsible Party: Hewlett-Packard Company
Manager of Corporate Product Regulations
3000 Hanover Street
Palo Alto, CA 94304
+1 (650) 857-1501

declares that the product(s)

Trade name: Hewlett-Packard Company
Product name: Pavilion ZE4... and XT... series
Regulatory Model Number: CRVSA-02T1-75/90

Complies with Part 15 of the FCC Rules. Operation is subject to the following two conditions:

1. This device may not cause harmful interference, and
2. This device must accept any interference received, including interference that may cause undesired operation.

Canada

This digital apparatus does not exceed the Class B limits for radio noise emissions from digital apparatus as set out in the radio interference regulations of the Canadian Department of Communications. This equipment meets the applicable Industry Canada technical specifications.

The Ringer Equivalence Number, REN, is an indication of the maximum number of devices allowed to be connected to a telephone interface. The termination on an interface may consist of any combination of devices subject only to the requirement that the sum of the RENs of all devices does not exceed five. The REN for this terminal equipment is 1.0.

Reference Information

Regulatory Information

The internal wireless radio complies with RSS 210 of Industry Canada. To prevent radio interference to the licensed service, this device is intended to be operated indoors and away from windows to provide maximum shielding. Equipment (or its transmit antenna) that is installed outdoors is subject to licensing.

Le présent appareil numérique n'émet pas de bruits radioélectriques dépassant les limites applicables aux appareils numériques de Classe B prescrites dans le règlement sur le brouillage radioélectrique édicté par le Ministère des Communications du Canada. Le composant RF interne est conforme à la norme CNR-210 d'Industrie Canada. L'utilisation de ce dispositif est autorisée seulement aux conditions suivantes : (1) il ne doit pas produire de brouillage et (2) l'utilisateur du dispositif doit être prêt à accepter tout brouillage radioélectrique reçu, même si ce brouillage est susceptible de compromettre le fonctionnement du dispositif.

European Union

The equipment has been approved in accordance with Council Decision 98/482/EC for pan-European single terminal connection to the public switched telephone network (PSTN) and to a radio-frequency wireless network. However, due to differences between the individual PSTN's provided in different countries, the approval does not, of itself, give an unconditional assurance of successful operation on every PSTN network termination point.

In event of problems, you should contact your equipment supplier in the first instance.

This equipment has been designed to work in all of the countries of the European Economic Area (Public Switched Telephone Networks). Network compatibility is dependent on internal software settings. Contact your equipment supplier if it is necessary to use the equipment on a different telephone network.

Belgium: For outdoor usage only channels 10 (2457 MHz) through 13 (2472 MHz) are allowed. For private usage outside buildings across public grounds over less than 300m, no special registration with IBPT/BIPT is required. Registration to IBPT/BIPT is required for private usage outside buildings across public grounds over more than 300m. An IBPT/BIPT license is required for public usage outside building. For registration and license please contact IBPT/BIPT.

France: Restricted frequency band: only channels 10 through 13 (2457 MHz through 2472 MHz respectively) may be used in France. License required for every installation, indoor and outdoor installations. Please contact ART for the procedure to follow. Use with outdoor installations not allowed.

Germany: License required for outdoor installations. Check with reseller for procedure to follow.

Netherlands: License required for outdoor installations. Check with reseller for procedure to follow.

Italy: Indoor or outdoor use in a public area requires a user license.

Die Geräte wurden gemäß Ratsentscheidung 98/482/EC für den Anschluss an eine einzelne Telefonbuchse im europäischen Raum (Public Switched Telephone Network) und drahtlose Funknetzwerke zertifiziert. In Anbetracht der Unterschiede zwischen den einzelnen Telefonnetzen bietet die Zertifizierung für sich genommen keine absolute Sicherheit, dass die Geräte bei Anschluss an jeder beliebigen Telefonbuchse funktionieren.

Sollten Probleme auftreten, wenden Sie sich zunächst an den Gerätehersteller. Diese Geräte wurden zum Betrieb in allen Ländern der europäischen Wirtschaftsgemeinschaft entwickelt (Public Switched Telephone Networks). Die Kompatibilität zum Netz ist von internen Software-Einstellungen abhängig. Wenden Sie sich an den Gerätehersteller, wenn Sie die Geräte in einem anderen Telefonnetz einsetzen müssen.

Cet équipement a été reconnu conforme aux décisions du Conseil 98/482/EC relatives à la connexion pan-européenne de terminal simple au réseau téléphonique public commuté (RTPC) et à un réseau sans fil RF. Cependant, des différences existant entre les RTPC nationaux présents dans les différents pays, cette homologation en elle-même ne garantit pas la réussite de toutes les opérations sur tous les points de terminaison du réseau téléphonique public commuté.

En cas de problème, prenez contact avec le fournisseur auprès duquel vous vous êtes procuré votre équipement.

Cet équipement a été conçu pour fonctionner dans tous les pays membres de la zone d'échange européenne (Réseaux Téléphoniques Publics Commutés). La compatibilité entre réseaux dépend des paramètres internes du logiciel. Prenez contact avec le fournisseur auprès duquel vous vous êtes procuré votre équipement pour savoir s'il est préférable d'utiliser ce dernier sur un autre réseau téléphonique.

Questa apparecchiatura è stata approvata in conformità alla Decisione del Consiglio 98/482/EC che regola, in seno all'Unione Europea, la connessione di singoli terminali alla rete telefonica pubblica commutata (PSTN) e alla rete wireless in radio frequenza. Tuttavia, a causa delle differenze esistenti tra i singoli servizi PSTN forniti nei diversi paesi, l'approvazione in sé stessa non rappresenta una garanzia assoluta di funzionamento su ogni singolo punto di terminazione della rete PSTN.

Reference Information
Regulatory Information

In caso di problemi, per prima cosa rivolgersi al fornitore dell'apparecchiatura. Questa apparecchiatura è stata progettata per funzionare in tutti i paesi dell'Area Economica Europea (reti telefoniche pubbliche commutate). La compatibilità della rete dipende dalle impostazioni interne del software. Rivolgersi al fornitore dell'apparecchiatura qualora sia necessario utilizzare quest'ultima su una rete telefonica diversa.

Japan

この装置は、情報処理装置等電波障害自主規制協議会（VCCI）の基準に基づくクラスB情報技術装置です。この装置は、家庭環境で使用することを目的としていますが、この装置がラジオやテレビジョン受信機に近接して使用されると受信障害を引き起こすことがあります。

取り扱い説明書に従って正しい取り扱いをして下さい。

Japan Telecommunications Approval

Name of Equipment: AMC20493-001-KT5

機器に内蔵の無線LANをお使いのお客様へ。

この機器の使用周波数帯では、電子レンジ等の産業・科学・医療用機器のほか工場の製造ライン等で使用されている移動体識別用の構内無線局（免許を要する無線局）及び特定小電力無線局（免許を要しない無線局）が運用されています。

1 この機器を使用する前に、近くで移動体識別用の構内無線局及び特定小電力無線局が運用されていないことを確認して下さい。

2 万一、この機器から移動体識別用の構内無線局に対して電波干渉の事例が発生した場合には、速やかに使用周波数を変更するか又は電波の発射を停止した上、下記連絡先にご連絡頂き、混信回避のための処置等（例えば、パーティションの設置など）についてご相談して下さい。

3 その他、この機器から移動体識別用の特定小電力無線局に対して電波干渉の事例が発生した場合など何かお困りのことが起きたときは、次の連絡先へお問い合わせ下さい。

連絡先：03-5344-7181

TELEC approval number: D02-0005JP
Name of Equipment: T60H424

2.4DS1



New Zealand

Conexant AMC20493 Data Fax Modem

PTC 211/02/071

PTC200 General Warning

The grant of a Telepermit for any item of terminal equipment indicates only that Telecom has accepted that the item complies with minimum conditions for connection to its network. It indicates no endorsement of the product by Telecom, nor does it provide any sort of warranty. Above all, it provides no assurance that any item will work correctly in all respects with another item of Telepermitted equipment of a different make or model, nor does it imply that any product is compatible with all of Telecom's network services.

PTC200 2.11.1 (6) & (7) Compliance Testing (Functional tests)

This equipment is not capable, under all operating conditions, of correct operation at the higher speeds for which it is designed. Telecom will accept no responsibility should difficulties arise in such circumstances. This condition typically applies to 56 kbit/s modems.

PTC200 4.5.1 (4) Off-hook Line Impedance

This equipment does not fully meet Telecom's impedance requirements. Performance limitations may occur when used in conjunction with some parts of the network. Telecom will accept no responsibility should difficulties arise in such circumstances.

PTC200 5.6.1 (3) General Requirements (automatic dialing devices)

This equipment shall not be set up to make automatic calls to Telecom's 111 Emergency Service.

PTC200 7.5.2 (3) (4) Ringer Sensitivity

This device may be subject to ringing or bell tinkle when certain other devices are connected to the same line. If this occurs, the problem should not be referred to the Telecom Faults Service.

Associated Software Limits of Compliance

Some parameters required for compliance with Telecom's Telepermit requirements are dependent on the application software or PC equipment associated with this device. The application software shall be set to operate within the following limits for compliance with Telecom's specifications:

The S0 register must contain a value of 0 for no auto-answer or a value of 2 for auto-answer.

The S6 register must contain a value of 2, 3, 4, 5, 6, or 7. The factory default of 2 is recommended.

The S7 register must contain a value less than 90. The factory default of 72 is recommended.

The S10 register must contain a value less than 150. The factory default of 14 is recommended.

The S11 register must contain a value greater than 60. The factory default of 95 is recommended.

There shall be no more than 10 call attempts to the same number within any 30-minute period for any single manual call initiation.

The equipment shall go on-hook for a period of not less than 30 seconds between the end of one call attempt and the beginning of the next attempt to the same number.

Automatic calls to different numbers shall be not less than 2 seconds apart.

Failure to set these parameters correctly could negate the User Rights under the Telecom Terms of Service.

Russia

Продукт сертифицирован в системе ГОСТ Р
Модем сертифицирован в системе ЭЛЕКТРОСВ



International

Products sold internationally by the manufacturer and its authorized dealers meet the specifications listed on the following page.

Note

For regulatory identification purposes, your product is assigned a Regulatory Model Number. The Regulatory Model Number for your product is listed in the declaration below. This regulatory number is different from the marketing name and product number.

Declaration of Conformity (according to ISO/IEC Guide 22 and EN 45014)

Manufacturer's Name: Hewlett-Packard Company, Personal Systems Group
Manufacturer's Address: 19310 Pruneridge Ave., Cupertino, CA 95014, U.S.A.

declares that the following product

Product Name: HP Notebook PCs
Regulatory Model Number: CRVSA-02T1-75
Product Options: Includes all options for analog modems (Conexant) and 802.11b RF devices (Ambit)

conforms to the following product specifications

Safety: IEC 60950: 1991 +A1,A2,A3,A4 / EN 60950: 1992 +A1,A2,A3,A4,A11
IEC 60825-1: 1993 +A1 / EN 60825-1: 1994 +A11 Class 1 LED
GB4943-1995

EMC: EN 55022: 1994 +A1: 1995 +A2: 1997, Class B [1]
CISPR 24: 1997 / EN 55024: 1998
IEC 61000-3-2: 1995 / EN 61000-3-2:1995 +A1: 1998 +A2: 1998
IEC 61000-3-3: 1994 / EN 61000-3-3:1995
GB9254-1998
FCC Title 47 CFR, Part 15 Class B/ANSI C63.4: 1992
AS/NZS 3548: 1995 Rules and Regulations of Class B

Telecom: TBR 21: 1998, EG 201 121: 1998

Radio: EN 301 489-17: 2000 Specific conditions for wideband data HYPERLAN equipment
Equipment Class 2 EN 300 328-2: 2000 Technical requirements for Radio equipment
Notified Body Number: 0682
Notified Body Address: CETECOM ICT Services GmbH, Untertuerkheimer Str. 6-10, D-66117 Saarbruecken

Supplementary Information: The product herewith complies with the requirements of the R&TTE Directive 1999/5/EC and carries the CE marking accordingly.

[1] The product was tested in a typical configuration with Hewlett-Packard Personal Computer peripherals.

This device complies with Part 15 of the FCC Rules. Operation is subject to the following two conditions: (1) this device may not cause harmful interference, and (2) this device must accept any interference received, including interference that may cause undesired operation.

The HP F1454, F1781, F4600, F4814, F4813, F5104, 5950-4334, and 5950-4359 ac/dc adapters used with this product are designed to operate on all power systems, other than IT power systems.

Corvallis, OR, July 17,
2002



Jerry Erickson, R&D Product Execution Manager

European Contact for regulatory topics only: Hewlett Packard GmbH, HQ-TRE, Herrenberger Strasse 140, 71034 Boeblingen, Germany. Fax: +49 7031 143143.
USA Contact: Hewlett Packard Co., Corporate Product Regulations Manager, 3000 Hanover Street, Palo Alto, CA 94304, U.S.A. Phone: +1 (650) 857-1501.

Index

A

- AC adapter
 - compatibility, 11, 55
 - connecting, 11
- AC adapter jack, location, 5
- AdHoc wireless network setup, 41
- adjusting
 - brightness, 19
 - volume, 19
- airplanes, wireless
 - communication in, 42, 44
- ALT GR key, 21
- antistatic precautions, 58, 60
- Applications key, 21
- AT commands, 38
- audio
 - adjusting volume, 66
 - troubleshooting, 66
 - volume, 19
- audio jacks, 3
- audio mute button, 3

B

- battery
 - best use of, 34
 - checking status, 32
 - extending life of, 34
 - installing, 10
 - location, 2, 3
 - low power warning, 33
 - operating time, 34, 78
 - release latch, 6, 7
 - safety, 98
 - saving power, 34
 - status lights, 32
 - troubleshooting, 77
- BIOS password, 24
- BIOS Setup utility
 - Boot menu, 87
 - Exit menu, 87
 - external display settings, 86
 - Main menu, 85
 - Security menu, 86
 - using, 84
- black list (modem), 37
- blackout periods, modem, 37

Bluetooth

- business cards, 46
 - configuring, 45
 - sending files, 46
 - troubleshooting, 82
 - tuning on, 44
 - turning off, 45
 - wireless, 44
- boot device order, 17, 87
 - Boot menu (BIOS), 87
 - brightness, adjusting, 19
 - business cards, 46

C

- Cable lock, 25
- Caps Lock, 9
- Cardbus cards, 48
- cards, PCMCIA, 48
- CD-ROM drive
 - creating or copying CDs, 23
 - inserting CD, 20, 22
 - location, 2, 3
 - removing CD, 20, 22
- CDs
 - copying/creating, 23
 - recommended media, 23
- cleaning the notebook, 28
- configuring
 - BIOS settings, 84
 - modem, 38
- connecting
 - IEEE 1394 devices, 53
 - LAN, 39
 - wireless network, 40

D

- data protection, 28
- DDR-266 RAM, 58, 73
- default BIOS settings, 85
- devices
 - boot order, 87
 - temporary boot order, 17
- diskette drive
 - location, 5
 - USB, 81
- display
 - BIOS settings, 86

- brightness, 19, 28, 34
 - dual display, 53
 - dual monitor, 53
 - extending life, 28
 - memory, 85
 - port, 5
 - secondary, 53
 - troubleshooting, 68
- docking port, 6, 7
 - drives
 - hard drive holder, 63
 - replacing hard drive, 62
 - DVD drive
 - location, 2, 3
 - setting region code, 23
 - troubleshooting, 67

E

- encryption, 40
- ergonomics, 10
- Exit menu (BIOS), 87
- extended memory, 85
- external monitor port, 5

F

- Fn key
 - + Back Space (mute), 19
 - + F1 (decrease brightness), 19
 - + F12 (hibernation), 19
 - + F2 (increase brightness), 19
 - + F8 (keypad), 19
 - + NumLock (scroll lock), 19
 - + Page Down (decrease audio), 19
 - + Page Up (increase audio), 19

H

- hard drive
 - caring for, 28
 - Hibernation partition, 62, 87
 - holder, 63
 - location, 6, 7
 - protecting, 27
 - replacing, 62
 - troubleshooting, 69
- Hibernation
 - status lights, 8

Hibernation mode
 definition, 16
Hibernation partition, 62, 87
hot keys, 19
hot notebook, 70

I

IEEE 1394 port
 connecting devices, 53
 location, 5
infrared communication
 troubleshooting, 70
infrared port
 location, 2, 3
 printing, 54
 safety, 99
 troubleshooting, 70
inserting
 CD, 20, 22
 DVD, 20, 22
 PC card, 48
installing
 battery, 10
 hard drive, 62
 hard drive holder, 63
Internet Service Provider, 36

K

keyboard
 ergonomic precautions, 10
 non US, 21
 status lights, 2, 3, 9
 troubleshooting, 71
Keypad Lock, 2, 3, 9

L

LAN
 connecting to, 39
 troubleshooting, 72
 wireless, 40
LAN port
 indicator lights, 39
 location, 5
laser safety, 98
lights
 LAN port, 39
 status, 2, 3, 8, 9
locking notebook, 24
LPT1 port, 5

M

Main menu (BIOS), 85
maintenance
 notebook configuration, 84
 software installation, 88

memory

 extended, 85
 PC2100 DDR-266, 58, 73
 troubleshooting, 73
 video, 85
Mini PCI location, 6, 7
modem
 AT commands, 38
 black list, 37
 blackout periods, 37
 built-in, 12
 port location, 5
 settings, 38
 software, 36
 troubleshooting, 73

monitor

 BIOS settings, 86
 port, 5
 resolution, 53
mouse, troubleshooting, 71
mute button
 location, 3

N

network
 connecting to, 39
 LAN, *See* LAN
 wireless, *See* wireless network
Norton AntiVirus, 25

notebook

 caring for, 27
 changing BIOS settings, 84
 cleaning, 28
 opening/closing, 2, 3
 protecting, 27, 70
 resetting, 17
 timeouts, 31
 turning on, 13
Num Lock, 9

O

off
 button location, 2, 3
 status lights, 8
 turning off, 16

 on button, location, 2, 3
One-Touch buttons
 location, 2, 3
 using, 20
overheating, 70

P

parallel port
 location, 5
 troubleshooting, 80
password, 24
PC card slot, location, 5
PC cards
 installing, 48
 saving power, 34
 stopping, 49
 troubleshooting, 76
PC2100 DDR-266 RAM, 58, 73
PCMCIA cards, 48
phone cord, connecting, 12
plug requirements, 97
port locations, 5
power
 connecting AC, 11
 saving, 34
 troubleshooting, 77
power button
 location, 2, 3
 resetting with, 17
power cords, 97
power management
 automated, 30
 schemes, 31
printing
 infrared printers, 54
 troubleshooting, 79
protection
 Cable lock, 25
 Norton AntiVirus, 25
PS/2 port, 2, 5

Q

Quick Lock, 24
QuickRestore System Recovery
 CD
 using, 88

R

RAM
 location, 6, 7
 PC2100 DDR-266, 58, 73

- rebooting
 - boot device, 87
 - temporary boot device, 17
- region code, 23
- regulatory information, 101
- removing
 - CD, 20, 22
 - DVD, 20, 22
 - hard drive, 62
 - hard drive holder, 63
 - PC card, 49
- reset button, 17
- resetting, 17
- S**
- safety
 - battery use, 98
 - infrared port, 99
 - laser, 98
 - power cords, 97
 - wireless communication, 42, 44
- safety information, iii
- saving battery power, 34
- scroll pad, 3
- scroll pad, 2
- secondary display, 53
- security
 - cable lock, 5
 - Cable lock, 25
 - Norton AntiVirus, 25
- Security menu (BIOS), 86
- serial port
 - troubleshooting, 80
- setting up, 10
- Standby
 - and display life, 28
 - resuming and, 82
 - saving power, 34
 - status lights, 8
 - troubleshooting, 82
- Standby mode
 - definition, 16
 - timeout, 16
- startup, troubleshooting, 81
- static electricity, 58, 60
- status lights
 - battery charge, 32
 - keyboard, 2, 3, 9
 - location, 2, 3
 - meanings, 8
- S-Video port, 5
- T**
- temperature, overheating, 70
- 1394 devices, connecting, 53
- 1394 port, 53
- timeouts, notebook, 31
- TouchPad
 - location, 2, 3
 - troubleshooting, 71
- troubleshooting
 - audio, 66
 - battery, 77
 - CD/DVD drive, 67
 - display, 68
 - hard drive, 69
 - infrared communications, 70
 - keyboard, 71
 - LAN, 72
 - memory, 73
 - modem, 73
 - overheating, 70
 - parallel port, 80
 - PC card, 76
 - performance, 76
 - pointing devices, 71
 - power, 77
 - printing, 79
 - resuming, 82
 - serial port, 80
 - Standby, 82
 - startup, 81
- USB, 80
 - wireless communication, 82
- turning on notebook, 13
- typing special characters, 21
- U**
- USB
 - diskette drive, 81
 - port location, 5
 - third port location, 3
 - troubleshooting, 80
- V**
- ventilation, 27, 70
- video memory, 85
- virus protection, 25
- voltage requirements, 97
- volume
 - adjusting, 19
 - troubleshooting, 66
- volume control, 3
- W**
- Windows
 - key, 21
 - password, 24
 - setting up, 13
- wireless communication
 - Bluetooth, 44
 - configuring (Bluetooth), 45
 - indicator light, 2, 3, 42, 44
 - on-off button, 40
 - restrictions on use, 42, 44
 - status, 42
 - troubleshooting, 82
 - turning off (Bluetooth), 45
 - turning on, 42
 - turning on (Bluetooth), 44
 - wireless network
 - AdHoc, 41
 - connecting to, 40