

Dell™ Latitude™ D400 User's Guide

FILE LOCATION: S:\SYSTEMS\Pebble\UG\A00\English\tp.fm

DELL CONFIDENTIAL – PRELIMINARY 1/29/03 – FOR PROOF ONLY



Click the links to the left for information on the features and operation of your computer. For information on other documentation included with your computer, see "Finding Information."



CAUTION: Follow the safety instructions in the *System Information Guide* to help protect your computer from damage and ensure your own personal safety.

Notes, Notices, and Cautions



NOTE: A NOTE indicates important information that helps you make better use of your computer.



NOTICE: A NOTICE indicates either potential damage to hardware or loss of data and tells you how to avoid the problem.



CAUTION: A CAUTION indicates a potential for property damage, personal injury, or death.

Abbreviations and Acronyms

For a complete list of abbreviations and acronyms, see the Glossary.

If you purchased a Dell™ n Series computer, any references in this document to Microsoft® Windows® operating systems are not applicable.

**Information in this document is subject to change without notice.
© 2003 Dell Computer Corporation. All rights reserved.**

Reproduction in any manner whatsoever without the written permission of Dell Computer Corporation is strictly forbidden.

Trademarks used in this text: *Dell*, the *DELL* logo, *Latitude*, *Dell Precision*, *OptiPlex*, *Inspiron*, *Dimension*, *Dell TravelLite*, and *DellNet* are trademarks of Dell Computer Corporation; *Intel*, *Pentium*, and *Intel SpeedStep* are registered trademarks and *Centrino* is a trademark of Intel Corporation; *Microsoft*, *Windows*, *Windows NT*, and *MS-DOS* are registered trademarks of Microsoft Corporation; *Bluetooth* is a trademark owned by Bluetooth SIG, Inc. and is used by Dell Computer Corporation under license; *ENERGY STAR* is a registered trademark of the U.S. Environmental Protection Agency. As an ENERGY STAR Partner, Dell Computer Corporation has determined that this product meets the ENERGY STAR guidelines for energy efficiency.

Other trademarks and trade names may be used in this document to refer to either the entities claiming the marks and names or their products. Dell Computer Corporation disclaims any proprietary interest in trademarks and trade names other than its own.

Model PPT

FILE LOCATION: S:\SYSTEMS\Pebble\UG\A00\English\tp.fm

March 2003

P/N 2X468

Rev. A00

DELL CONFIDENTIAL - PRELIMINARY 1/29/03 - FOR PROOF ONLY

FILE LOCATION: S:\SYSTEMS\Pebble\UG\A00\English\tp.fm

Contents

1 Finding Information

Safety Instructions	14
Documentation Updates	14
Using Microsoft® Windows®	14
Windows Help	14
Microsoft Windows Guide	14
Using Devices	14
Device User's Guides	14
Using the Drivers and Utilities CD	15
Fixing Problems	15
Microsoft Windows Guide	15
Dell Support	15
Installing Parts	15

2 About Your Computer

Front View	18
Left View	21
Right View	23
Back View	25
Bottom View	28

3 UsingMicrosoft® Windows® XP

Help and Support Center	32
Switching to Classic View	32
Control Panel	32
Start Menu	32
Window and Button Appearance	32
Desktop Cleanup Wizard	33
Transferring Information to a New Computer	33
User Accounts and Fast User Switching	35
Adding User Accounts	35
Fast User Switching	35
Setting Up a Home and Office Network	36
Connecting to a Network Adapter	36
Network Setup Wizard	36
Internet Connection Firewall	37

4 Dell™ QuickSet Features

Clicking the QuickSet Icon	40
Double-Clicking the QuickSet Icon	40
Right-Clicking the QuickSet Icon	40

5 Using the Keyboard and Touch Pad

Numeric Keypad	44
Keyboard Shortcuts	44
System Functions	44
Battery	45
CD or DVD Tray	45

Display Functions	45
Radios (Including Wireless Networking and Bluetooth™)	45
Power Management	45
Speaker Functions	46
Microsoft® Windows® Logo Key Functions	46
Touch Pad	47
Customizing the Touch Pad and Track Stick	48
Changing the Track Stick Cap	48
6 Using the Display	
Adjusting Brightness	52
Switching the Video Image	53
Setting Display Resolution	53
Microsoft® Windows® XP	53
Windows 2000	53
7 Using the Dell™ D/Bay	
About the Dell D/Bay	56
Removing and Installing Devices When the Computer is Turned Off	56
Removing and Installing Devices While the Computer Is Running	58
Using the CD or DVD Tray	61
Adjusting the Volume	62
Adjusting the Picture	63
8 Using a Battery	
Battery Performance	66

Checking the Battery Charge	67
Dell QuickSet Battery Meter	67
Microsoft Windows Power Meter	67
Charge Gauge	68
Health Gauge	68
Low-Battery Warning	69
Charging the Battery	69
Removing a Battery	69
Installing a Battery	70
Storing a Battery	70

9 Power Management

Power Management Tips	72
Power Management Wizard	72
Setting Sleep Modes	72
Selecting a Power Scheme	73
Setting Battery Alarms and Actions	74
Completing the Power Management Wizard	74
Power Management Modes	75
Standby Mode	75
Hibernate Mode	75
Power Options Properties	76
Power Schemes Tab	77
Alarms Tab	77
Power Meter Tab	77
Advanced Tab	77
Hibernate Tab	78
Intel SpeedStep® Technology Tab	78

10 Using PC Cards

PC Card Types	82
PC Card Blanks	82
Extended PC Cards	82
Installing a PC Card	82
Removing a PC Card or Blank	83

11 Using Smart Cards

About Smart Cards	88
Installing a Smart Card	88

12 Traveling With Your Computer

Identifying Your Computer	92
Packing the Computer	92
Travel Tips	93
Traveling by Air	93
If Your Computer Is Lost or Stolen	94

13 Passwords

About Passwords	96
Using a Primary Password	96
Using an Administrator Password	97
Using a Hard Drive Password	98
Assigning an Asset Tag	99
Viewing Existing Asset and Service Tags	100

Deleting an Asset Tag	100
Assigning an Owner Tag	100
Deleting an Owner Tag	101
Asset Tag Options	101

14 Solving Problems

Power Problems	104
Error Messages	105
Video and Display Problems	111
If the display is blank	111
If the display is difficult to read	112
If only part of the display is readable	113
Sound and Speaker Problems	113
If you have a problem with the integrated speaker	113
If you have a problem with external speakers	114
Printer Problems	115
Modem and Internet Connection Problems	117
Touch Pad or Mouse Problems	119
External Keyboard Problems	120
Unexpected Characters	122
Drive Problems	122
If you cannot save a file to a floppy drive	122
If you cannot play a CD, CD-RW, DVD, or DVD+RW	123
If you cannot eject the CD, CD-RW, DVD, or DVD+RW drive tray	124
If you hear an unfamiliar scraping or grinding sound	124
If the CD-RW or DVD+RW drive stops writing	124
If you have problems with a hard drive	125
PC Card Problems	125

Smart Card Problems	126
Network Problems	126
General Program Problems	127
A program crashes	127
A program stops responding	127
A solid blue screen appears	127
Error messages appear	128
If Your Dell™ Computer Gets Wet	128
If You Drop or Damage Your Computer	129
Resolving Other Technical Problems	130

15 Using the Dell Diagnostics

When to Use the Dell Diagnostics	132
Features of the Dell Diagnostics	132
Starting the Dell Diagnostics	133

16 Cleaning Your Computer

Computer, Keyboard, and Display	138
Touch Pad	138
Floppy Drive	138
Optical Media	139

17 Reinstalling Software

Reinstalling Drivers and Utilities	142
Manually Reinstalling Drivers for Windows XP	143
Using the Windows XP Device Driver Rollback	144
Manually Reinstalling Drivers for Windows 2000	144
Resolving Software and Hardware Incompatibilities	145

Windows XP	145
Windows 2000	146
Using Microsoft® Windows® System Restore	147
Creating a Restore Point	148
Restoring the Computer to an Earlier Operating State	148
Undoing the Last System Restore	149
Reinstalling Microsoft® Windows® XP	150
Before You Reinstall	150
Reinstalling Windows XP	150
Reinstalling Drivers and Software	152
Reinstalling Windows 2000	152
Enabling Hibernate Mode	154

18 Adding and Replacing Parts

Adding Memory	156
Installing a Memory Module Under the Memory Module/Modem Cover 156	
Installing a Memory Module Under the Keyboard	159
Adding a Modem	161
Replacing the Keyboard	163
Adding a Mini PCI Card	165
Replacing the Hard Drive	168
Adding a Bluetooth™ Module	169

19 Using the System Setup Program

Overview	174
Viewing the System Setup Screens	174

System Setup Screens	175
Commonly Used Options	175
Changing the Boot Sequence	175
Changing COM Ports	176
Enabling the Infrared Sensor	177

20 Alert Standard Format (ASF)

21 Getting Help

Technical Assistance	182
Online Services	182
AutoTech Service	183
Automated Order-Status Service	184
Technical Support Service	184
Problems With Your Order	184
Product Information	184
Returning Items for Warranty Repair or Credit	184
Before You Call	185
Contacting Dell	187

22 Specifications

23 Appendix

Ergonomic Computing Habits	214
Regulatory Notices	215
FCC Notices (U.S. Only)	217
IC Notice (Canada Only)	220

CE Notice (European Union)	222
CE Mark Notice	222
New Zealand Telecom Warnings	223
ENERGY STAR® Compliance	225
Simplified Chinese Class A Warning Notice (China Only)	225
EN 55022 Compliance (Czech Republic Only)	226
VCCI Notice (Japan Only)	226
MIC Notice (Republic of Korea Only)	228
Polish Center for Testing and Certification Notice	230
BSMI Notice (Taiwan Only)	231
NOM Information (Mexico Only)	233

Warranty and Return Policy	234
---	------------

24 Glossary

SECTION 1

Finding Information

FILE LOCATION: S:\SYSTEMS\Pebble\UG\A00\English\findinfo.fm

DELL CONFIDENTIAL – PRELIMINARY 1/29/03 – FOR PROOF ONLY

Safety Instructions

 **CAUTION:** For precautions on safely handling and using your computer and preventing electrostatic discharge, see the safety instructions in the *System Information Guide*.

Documentation Updates

Documentation updates are sometimes included with your computer to describe changes to your computer or software. Always read these updates before consulting any other documentation because the updates contain the latest information.

Readme files, which may be installed on your hard drive or found on CDs such as the Dell™ *Drivers and Utilities* CD, provide last-minute updates about technical changes to your computer or advanced technical reference material intended for experienced users or technicians.

Using Microsoft® Windows®

Windows Help

The Windows XP and Windows 2000 operating systems provide complete online instructions for using them:

- *In Windows XP*, click the **Start** button and click **Help and Support**. For more information, see "[Help and Support Center](#)."
- *In Windows 2000*, click the **Start** button and click **Help**.

Microsoft Windows Guide

For more information on using the Windows operating system, see the Microsoft Windows documentation that came with your computer.

Using Devices

Device User's Guides

For help on using your computer's devices (such as a modem) and options you purchase separately from your computer, see the device user's guide.

- *In Windows XP*, click the **Start** button and click **Help and Support**. From the **Help and Support** window, click **User and system guides**.
- *In Windows 2000*, click the **Start** button, point to **Programs**, and then click **User's Guides**.

Using the Drivers and Utilities CD

The *Drivers and Utilities* CD contains drivers and utilities, the Dell Diagnostics, and user's guides for your computer and optional devices. Dell ships your computer to you with required drivers and utilities already installed—no further installation or configuration is needed. If you ever need to *reinstall* a driver or utility, run diagnostics tests on your computer, or access the user's guides, use the *Drivers and Utilities* CD. See "[Reinstalling Software](#)" and "[Using the Dell Diagnostics](#)."

Fixing Problems

For help with fixing computer problems, see "[Solving Problems](#)" and "[Using the Dell Diagnostics](#)."

Microsoft Windows Guide

For more information on troubleshooting problems, see the Microsoft Windows documentation that came with your computer.

Dell Support

For personalized online support, driver updates, and instant answers to your questions, access the Dell Support website at support.dell.com.

Installing Parts

For help with adding parts to your computer, see "[Adding and Replacing Parts](#)."

For detailed information on the computer parts and assemblies and how to remove and replace them, see the computer *Service Manual* on support.dell.com.

FILE LOCATION: S:\SYSTEMS\Pebble\UG\A00\English\findinfo.fm

DELL CONFIDENTIAL – PRELIMINARY 1/29/03 – FOR PROOF ONLY

SECTION 2

About Your Computer

FILE LOCATION: S:\SYSTEMS\Pebble\UG\A00\English\about.fm

DELL CONFIDENTIAL – PRELIMINARY 1/29/03 – FOR PROOF ONLY

Front View

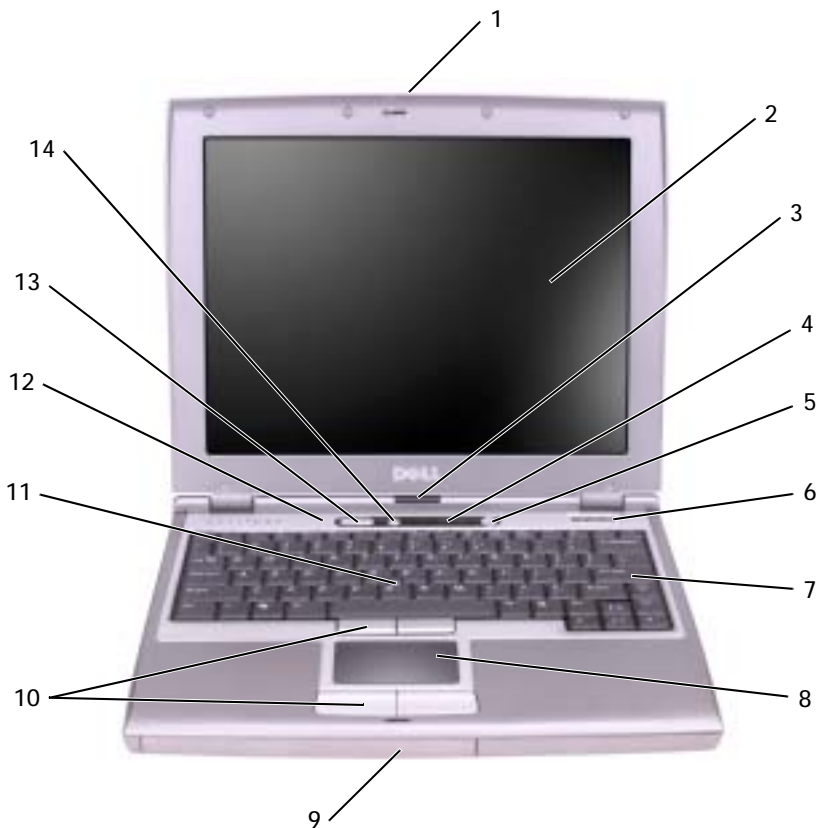

1	display latch	8	touch pad
2	display	9	battery/battery bay
3	device status lights	10	track stick/touch pad buttons
4	keyboard status lights	11	track stick
5	power button	12	microphone
6	speaker	13	volume control buttons
7	keyboard	14	mute button

DELL CONFIDENTIAL - PRELIMINARY 1/29/03 - FOR PROOF ONLY

DISPLAY LATCH — Slide the display latch to open the display.



DISPLAY — For more information about your display, see "[Using the Display.](#)"

DEVICE STATUS LIGHTS







 Turns on when you turn on the computer or blinks steadily when the computer is in standby mode.

 Turns on when the computer reads or writes data.

 **NOTICE:** To avoid loss of data, never turn off the computer while the  light is flashing.

 Indicates battery charge status.

 Turns on when the **wireless antenna** is enabled. To enable or disable the antenna, press  .

NOTE: The wireless features on your computer, including Bluetooth™ and Mini PCI Wi-Fi, are optional. The  icon turns on only if you ordered a wireless option with your computer. For more information, see the documentation that came with your wireless technology.

If the computer is connected to an electrical outlet, the  light operates as

follows:

- Solid green: The battery is charging.
- Flashing green: The battery is almost fully charged.

If the computer is running on a battery, the  light operates as follows:

- Off: The battery is adequately charged (or the computer is turned off).
- Flashing orange: The battery charge is low.
- Solid orange: The battery charge is critically low.

KEYBOARD STATUS LIGHTS



The green lights located above the keyboard indicate the following:



Turns on when the numeric keypad is enabled.



Turns on when the uppercase letter function is enabled.



Turns on when the scroll lock function is enabled.

POWER BUTTON — Press the power button to turn on the computer or to exit a [power management mode](#).



NOTICE: To avoid losing data, turn off your computer by performing an [operating system shutdown](#) rather than by pressing the power button.

DELL CONFIDENTIAL – PRELIMINARY 1/29/03 – FOR PROOF ONLY

If the computer stops responding, press and hold the power button until the computer turns off completely (which may take several seconds).

SPEAKER — To adjust the volume of the integrated speaker, press the volume control buttons or volume control keyboard shortcuts. For more information, see ["Using the Keyboard and Touch Pad."](#)

KEYBOARD — The keyboard includes a numeric keypad as well as the Microsoft® Windows® logo key . For information on supported keyboard shortcuts, see ["Using the Keyboard and Touch Pad."](#)

TOUCH PAD — Touch pad and touch pad buttons provide the functionality of a mouse. See ["Using the Keyboard and Touch Pad"](#) for more information.

BATTERY/BATTERY BAY — When a battery is installed, you can use the computer without connecting the computer to an electrical outlet. See ["Using a Battery."](#)

TRACK STICK/TOUCH PAD BUTTONS — Track stick and touch pad buttons provide the functionality of a mouse. See ["Using the Keyboard and Touch Pad"](#) for more information.

TRACK STICK — Track stick and track stick buttons provide the functionality of a mouse. See ["Using the Keyboard and Touch Pad"](#) for more information.

MICROPHONE — Allows you to record audio.

VOLUME CONTROL BUTTONS — Press these buttons to adjust the volume.

MUTE BUTTON — Press this button to turn off the volume.

Left View

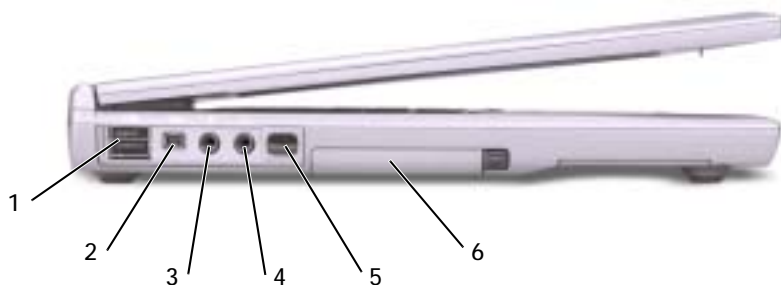

- 1 Dell™ D/Bay connector
- 2 IEEE 1394 connector
- 3 audio connectors
- 4 audio connectors
- 5 infrared sensor
- 6 PC Card slot (plastic blank installed)

DELL™ D/BAY CONNECTOR

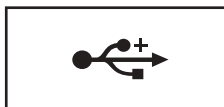



Connects the Dell™ D/Bay, which is an external media bay that accommodates an optical drive, floppy drive, or second hard drive; also connects standard USB devices

IEEE 1394 CONNECTOR — Use to attach devices supporting IEEE 1394 high-speed transfer rates, such as some digital video cameras.

AUDIO CONNECTORS



Attach a microphone to the  connector.

Attach headphones or speakers to the  connector. The  connector is a stereo output connector.

INFRARED SENSOR — Lets you transfer files from your computer to another IrDA-compatible device without using cable connections.

When you receive your computer, the sensor is disabled. You can use the [system setup program](#) to enable the sensor. For information on transferring data, see *Windows Help*, the [Windows Help and Support Center](#), or the documentation that came with your IrDA-compatible device.

PC CARD SLOT — Supports one PC Card, such as a modem or network adapter. The computer ships with a plastic blank installed in the slot. For more information, see "[Using PC Cards](#)."

Right View

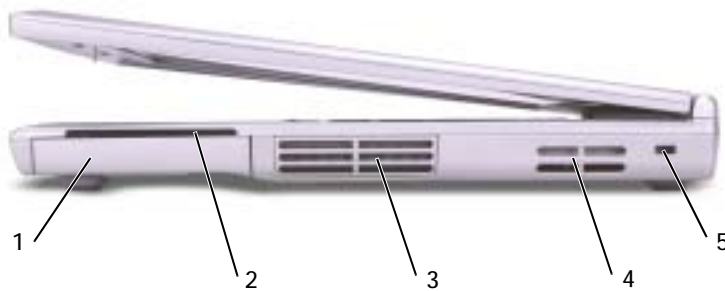



- | | |
|---|-------------------------------------|
| 1 | hard drive |
| 2 | smart card slot |
| 3 | fan exhaust |
| 4 | air intake |
| 5 | security cable slot |

HARD DRIVE — Stores software and data.

SMART CARD SLOT — Supports one smart card. For more information, see "[Using Smart Cards](#)."

FAN EXHAUST — The computer uses an internal fan to create airflow through the vents, which prevents the computer from overheating.

 **NOTE:** The computer turns on the fan when the computer gets warm. Fan noise is normal and does not indicate a problem with the fan or the computer.

 **NOTE:** The computer turns on the fan when the computer gets warm. Fan noise is normal and does not indicate a problem with the fan or the computer.

 **CAUTION:** Do not block, push objects into, or allow dust to accumulate in the air vents. Do not store your computer in a low-airflow environment, such as a closed briefcase, while it is running. Restricting the airflow can damage the computer or cause a fire.

AIR INTAKE — The computer uses an internal fan to create airflow through the vents, which prevents the computer from overheating.

 **CAUTION:** Do not block, push objects into, or allow dust to accumulate in the air vents. Do not store your computer in a low-airflow environment, such as a closed briefcase, while it is running. Restricting the airflow can damage the computer or cause a fire.

SECURITY CABLE SLOT — Allows you to attach a commercially available antitheft device to the computer. For more information, see the instructions included with the device.

 **NOTICE:** Before you buy an antitheft device, ensure that it will work with the security cable slot.



Back View

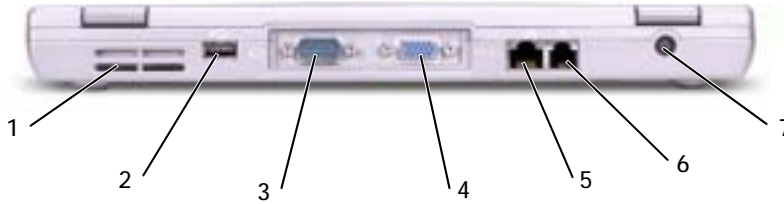

1	air intake	5	network connector (RJ-45)
2	USB connector	6	modem connector (RJ-11) (optional)
3	serial connector	7	AC Adapter connector
4	video connector		

AIR INTAKE — The computer uses an internal fan to create airflow through the vents, which prevents the computer from overheating.

CAUTION: Do not block, push objects into, or allow dust to accumulate in the air vents. Do not store your computer in a low-airflow environment, such as a closed briefcase, while it is running. Restricting the airflow can damage the computer or cause a fire.

NOTE: The computer turns on the fan when the computer gets warm. Fan noise is normal and does not indicate a problem with the fan or the computer.

USB CONNECTOR

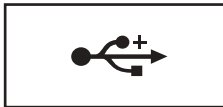

Connects USB devices, such as a mouse, keyboard, or printer. You can also connect the optional floppy drive directly to the USB connector using the optional floppy-drive cable.

SERIAL CONNECTOR



Connects serial devices, such as a mouse or handheld device.

VIDEO CONNECTOR



Connects an external monitor. For more information, see ["Using the Display."](#)

NETWORK CONNECTOR (RJ-45)



NOTICE: The network connector is slightly larger than the modem connector. To avoid damaging the computer, do not plug a telephone line in to the network connector.

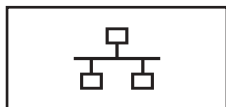

Connects the computer to a network. The green and yellow lights next to the connector indicate activity for both wired and wireless network communications.

For information on using the network adapter, see the online network-adapter documentation supplied with your computer. See ["Finding Information."](#)

MODEM CONNECTOR (RJ-11) (OPTIONAL)



If you ordered the optional internal modem, connect the telephone line to the modem connector.

For information on using the modem, see the online modem documentation supplied with your computer. See ["Finding Information."](#)

AC ADAPTER CONNECTOR — Attach an AC adapter to the computer.



The AC adapter converts AC power to the DC power required by the computer. You can connect the AC adapter with your computer turned either on or off.

⚠ CAUTION: The AC adapter works with electrical outlets worldwide. However, power connectors and power strips vary among countries. Using an incompatible cable or improperly connecting the cable to the power strip or electrical outlet may cause fire or equipment damage.

➡ NOTICE: When you disconnect the AC adapter cable from the computer, grasp the connector, not the cable itself, and pull firmly but gently to avoid damaging the cable.

Bottom View

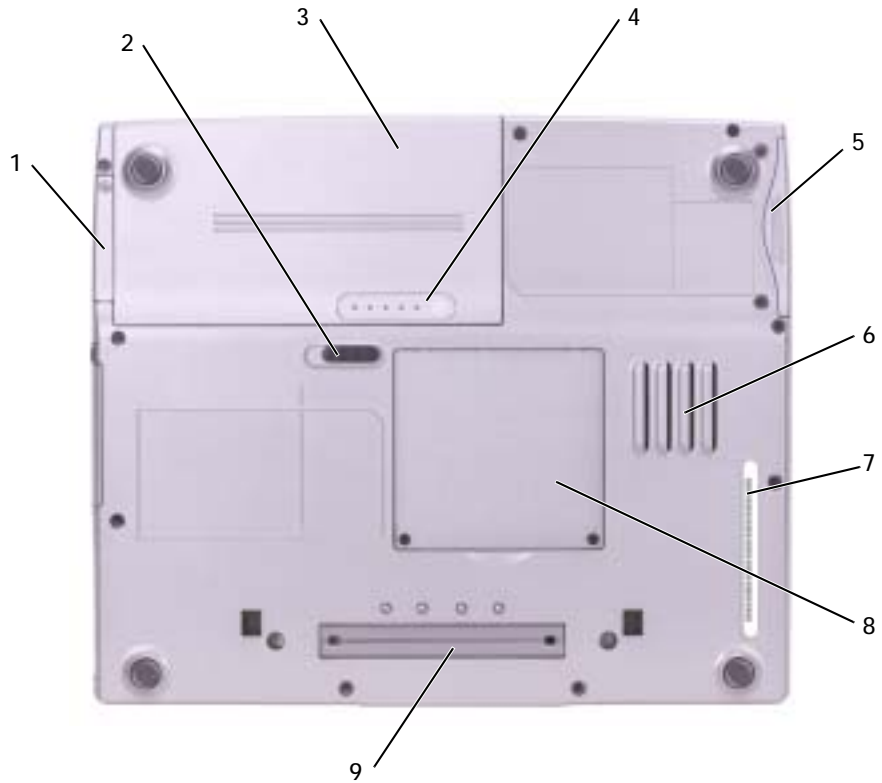

1	Bluetooth module cover	6	air intake
2	battery-bay latch release	7	Service Tag
3	battery	8	memory module/modem cover
4	battery charge gauge	9	docking device slot
5	hard drive		

BLUETOOTH MODULE COVER — Covers the compartment that contains the optional Bluetooth module.

BATTERY-BAY LATCH RELEASE — Releases the battery. See "[Removing a Battery](#)" for instructions.

DELL CONFIDENTIAL - PRELIMINARY 1/29/03 - FOR PROOF ONLY

BATTERY — When a battery is installed, you can use the computer without connecting the computer to an electrical outlet. See "[Using a Battery](#)."

BATTERY CHARGE GAUGE — Provides information on the battery charge. See "[Checking the Battery Charge](#)."

HARD DRIVE — Stores software and data.

AIR INTAKE — The computer uses an internal fan to create airflow through the vents, which prevents the computer from overheating.

 **CAUTION:** Do not block, push objects into, or allow dust to accumulate in the air vents. Do not store your computer in a low-airflow environment, such as a closed briefcase, while it is running. Restricting the airflow can damage the computer or cause a fire.

SERVICE TAG — Identifies your computer when you access Dell Support at support.dell.com or when you call Dell for customer service or technical support.

MEMORY MODULE/MODEM COVER — Covers the compartment that contains the memory module and optional modem. See "[Adding and Replacing Parts](#)."

DOCKING DEVICE SLOT — Lets you attach your computer to a docking device. See the documentation that came with your docking device for additional information.

 **NOTE:** The computer turns on the fan when the computer gets warm. Fan noise is normal and does not indicate a problem with the fans or the computer.

FILE LOCATION: S:\SYSTEMS\Pebble\UG\A00\English\about.fm

DELL CONFIDENTIAL – PRELIMINARY 1/29/03 – FOR PROOF ONLY

SECTION 3

Using Microsoft® Windows® XP

FILE LOCATION: S:\SYSTEMS\Pebble\UG\A00\English\xpfeat.fm

DELL CONFIDENTIAL – PRELIMINARY 1/29/03 – FOR PROOF ONLY

 **NOTE:** Windows XP Home Edition and Windows XP Professional offer different features and appearances. Also, options available in Windows XP Professional vary depending on whether your computer is connected to a domain.

Help and Support Center

The Help and Support Center provides help with the Microsoft® Windows® XP operating system and also offers other support and educational tools. To access the Help and Support Center, click the **Start** button and click **Help and Support**.

Switching to Classic View

You can change the appearance of the Control Panel, the **Start** menu, and the Microsoft® Windows® desktop to the *classic view* of previous Windows operating systems.

Control Panel

The Control Panel presents information as task-oriented categories. If you are accustomed to performing a particular task with the icon-oriented classic Control Panel, you can switch to the classic icon view.

- 1 Click the **Start** button and click **Control Panel**.
- 2 Click **Switch to Classic View** or **Switch to Category View** in the upper-left area of the **Control Panel** window.

Start Menu

- 1 Right-click the empty area on the taskbar.
- 2 Click **Properties** and click the **Start Menu** tab.
- 3 Click **Classic Start Menu** and click **OK**.

Window and Button Appearance

- 1 Right-click anywhere on the main desktop screen and click **Properties**.
- 2 Click the **Appearance** tab.
- 3 From the **Windows and buttons** drop-down menu, click **Windows Classic style**.
- 4 To customize color, font, and other classic desktop options, click **Advanced**.
- 5 When you have completed your appearance selections, click **OK**.

Desktop Cleanup Wizard

By default, the Desktop Cleanup Wizard moves desktop icons that are not frequently used from your desktop to a designated folder 7 days after you first start your computer and every 60 days after that. The appearance of the **Start** menu changes as desktop icons are moved.

To turn off the Desktop Cleanup Wizard:

- 1 Right-click an empty spot on the desktop and click **Properties**.
- 2 Click the **Desktop** tab and click **Customize Desktop**.
- 3 Click **Run Desktop Cleanup Wizard every 60 days** to remove the check mark.
- 4 Click **OK**.

To run the Desktop Cleanup Wizard at any time:

- 1 Right-click an empty spot on the desktop and click **Properties**.
- 2 Click the **Desktop** tab and click **Customize Desktop**.
- 3 Click **Clean Desktop Now**.
- 4 When the **Desktop Cleanup Wizard** screen appears, click **Next**.
- 5 To leave an icon on the desktop, click the icon name to remove the check mark, and then click **Next**.
- 6 Click **Finish** to remove the shortcuts and close the wizard.

Transferring Information to a New Computer

The Microsoft® Windows® XP operating system provides a Files and Settings Transfer wizard to move data from the source computer to the new computer. You can move data such as:

- E-mails
- Toolbar settings
- Window sizes
- Internet bookmarks

You can transfer the data to the new computer over a network or serial connection, or you can store it on a removable medium, such as a writable CD or floppy disk.

To prepare the new computer for the file transfer:

- 1 Click the **Start** button, point to **All Programs**→ **Accessories**→ **System Tools**, and then click **Files and Settings Transfer Wizard**.
- 2 When the **Files and Settings Transfer Wizard** welcome screen appears, click **Next**.
- 3 On the **Which computer is this?** screen, click **New Computer** and click **Next**.
- 4 On the **Do you have a Windows XP CD?** screen, click **I will use the wizard from the Windows XP CD** and click **Next**.
- 5 When the **Now go to your old computer** screen appears, go to your old or source computer. *Do not* click **Next** at this time.

To copy data from the old computer:

- 1 On the old computer, insert the Windows XP *Operating System* CD.
- 2 On the **Welcome to Microsoft Windows XP** screen, click **Perform additional tasks**.
- 3 Under **What do you want to do?**, click **Transfer files and settings**.
- 4 On the **Files and Settings Transfer Wizard** welcome screen, click **Next**.
- 5 On the **Which computer is this?** screen, click **Old Computer** and click **Next**.
- 6 On the **Select a transfer method** screen, click the transfer method you prefer.
- 7 On the **What do you want to transfer?** screen, select the items you want to transfer and click **Next**.

After the information has been copied, the **Completing the Collection Phase** screen appears.

- 8 Click **Finish**.

To transfer data to the new computer:

- 1 On the **Now go to your old computer** screen on the new computer, click **Next**.

- 2 On the **Where are the files and settings?** screen, select the method you chose for transferring your settings and files and click **Next**.

The wizard reads the collected files and settings and applies them to your new computer.

When all of the settings and files have been applied, the **Finished** screen appears.

- 3 Click **Finished** and restart the new computer.

User Accounts and Fast User Switching

Adding User Accounts

After the Microsoft® Windows® XP operating system is installed, the administrator or a user with administrator rights can create additional user accounts.

- 1 Click the **Start** button and click **Control Panel**.
- 2 In the **Control Panel** window, click **User Accounts**.
- 3 Under **Pick a task**, click **Create a new account**.
- 4 Under **Name the new account**, type the name of the new user and click **Next**.
- 5 Under **Pick an account type**, click one of the following options:
 - **Computer administrator** — You can change all computer settings.
 - **Limited** — You can change only your own personal settings, such as your password. You cannot install programs or use the Internet.
- 6 Click **Create Account**.

Fast User Switching

Fast User Switching allows multiple users to access one computer without requiring the previous user to log off.

- 1 Click the **Start** button and click **Log Off**.
- 2 In the **Log Off Windows** window, click **Switch User**

 **NOTE:** Fast User Switching is unavailable if your computer is running Windows XP Professional and is a member of a computer domain, or if your computer has less than 128 MB of memory.



When you use Fast User Switching, programs that previous users were using remain running in the background, so your computer might run slower. Also, multimedia programs, such as games and DVD software, might not work with Fast User Switching. For more information, see the [Windows Help and Support Center](#).

Setting Up a Home and Office Network

Connecting to a Network Adapter

Before you connect your computer to a network, the computer must have a network adapter installed and a **functional** network cable connected to it.

To connect a network cable:

-  **NOTE:** Insert the cable until it clicks into place, and then gently pull it to ensure that it is secure.
 -  **NOTE:** Do not use a network cable with a telephone wall jack.
- 1 Connect the network cable to the network adapter connector on the back of your computer.
 - 2 Connect the other end of the **functional** network cable to a network connection device, such as a network wall jack.

Network Setup Wizard

The Microsoft® Windows® XP operating system provides a Network Setup Wizard to guide you through the process of sharing files, printers, or an Internet connection between computers in a home or small office.

- 1 Click the **Start** button, point to **All Programs**→**Accessories**→**Communications**, and then click **Network Setup Wizard**.
 - 2 On the welcome screen, click **Next**.
 - 3 Click **Checklist for creating a network**.
 - 4 Complete the checklist and required preparations.
 - 5 Return to the Network Setup Wizard and follow the instructions on the screen.
-  **NOTE:** Selecting the connection method **This computer connects directly to the Internet** enables the integrated firewall provided with Windows XP.

Internet Connection Firewall

The Internet Connection Firewall provides basic protection from unauthorized access to the computer while the computer is connected to the Internet. The firewall is automatically enabled when you run the Network Setup Wizard. When the firewall is enabled for a network connection, the firewall icon appears with a red background in the **Network Connections** portion of the Control Panel.

Note that enabling the Internet Connection Firewall does not reduce the need for virus-checking software.

For more information, see the [Help and Support Center](#).

FILE LOCATION: S:\SYSTEMS\Pebble\UG\A00\English\xpfeat.fm

DELL CONFIDENTIAL – PRELIMINARY 1/29/03 – FOR PROOF ONLY

SECTION 4

Dell™ QuickSet Features

I *Horizontal Rule*

FILE LOCATION: S:\SYSTEMS\Pebble\UG\A00\English\quickset.fm

DELL CONFIDENTIAL – PRELIMINARY 1/29/03 – FOR PROOF ONLY

Dell QuickSet provides you with easy access to configuration settings for power management schemes, battery resources, icon and font size, display brightness, volume, and network activity. If QuickSet is installed on your computer, it runs from the  icon located in the taskbar. If QuickSet is not installed, you can download the program from support.dell.com.

QuickSet functions differently when you click, double-click, or right-click the icon.

Clicking the QuickSet Icon

Click the  icon to perform the following tasks:

- Adjust power management settings using the [Power Management Wizard](#).
- Adjust the size of icons and toolbars.
- Select a power scheme that you set in the [Power Management Wizard](#).
- Turn presentation mode on or off.

Double-Clicking the QuickSet Icon

Double-click the  icon to adjust power management settings using the [Power Management Wizard](#).

Right-Clicking the QuickSet Icon

Right-click the  icon to perform the following tasks:

- Enable or disable the [Brightness Meter](#) on the screen.
- Enable or disable the [Volume Meter](#) on the screen.
- Turn [wireless activity](#) on or off.
- View *Dell QuickSet Help*.
- View the version and copyright date of the QuickSet program installed on your computer.

FILE LOCATION: S:\SYSTEMS\Pebble\UG\A00\English\quickset.fm

For more information about QuickSet, right-click the  icon in the taskbar and click **Help**.

FILE LOCATION: S:\SYSTEMS\Pebble\UG\A00\English\quickset.fm

DELL CONFIDENTIAL – PRELIMINARY 1/29/03 – FOR PROOF ONLY

SECTION 5

Using the Keyboard and Touch Pad

FILE LOCATION: S:\SYSTEMS\Pebble\UG\A00\English\keyboard.fm





DELL CONFIDENTIAL - PRELIMINARY 1/29/03 - FOR PROOF ONLY

Numeric Keypad







The numeric keypad functions like the numeric keypad on an external keyboard. Each key on the keypad has multiple functions. The keypad numbers and symbols are marked in blue on the right of the keypad keys. To

type a number or symbol, hold down  and press the desired key.

- To enable the keypad, press  . The  light indicates that the keypad is active.
- To disable the keypad, press   again.

Keyboard Shortcuts

System Functions

  	Opens the Task Manager window
 	Enables and disables the numeric keypad



Enables and disables the scroll lock

Battery



Displays the [Dell™ QuickSet Battery Meter](#) (if [QuickSet](#) is installed)

CD or DVD Tray



Ejects the tray out of the drive (if [Dell QuickSet](#) is installed)

Display Functions



Switches the video image to the next display option. The options include the integrated display, an external monitor, and both displays simultaneously.



Increases brightness on the integrated display only (not on an external monitor).



Decreases brightness on the integrated display only (not on an external monitor).

Radios (Including Wireless Networking and Bluetooth™)



Enables and disables radios, including wireless networking and Bluetooth (both optional)

Power Management



Activates a power management mode. You can reprogram this keyboard shortcut to activate a different power management mode using the [Advanced tab](#) in the **Power Options Properties** window.

Speaker Functions



Increases the volume of the integrated **speaker** and external speakers, if attached



Decreases the volume of the integrated **speaker** and external speakers, if attached



Enables and disables the integrated **speaker** and external speakers, if attached

Microsoft® Windows® Logo Key Functions



Minimizes all open windows



Maximizes all windows



Runs Windows Explorer



Opens the **Run** dialog box



Opens the **Search Results** dialog box

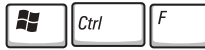

Opens the **Search Results-Computer** dialog box (if the computer is connected to a network)



Opens the **System Properties** dialog box

To adjust keyboard operation, such as the character repeat rate:

- *In Windows XP*, open the Control Panel, click **Printers and Other Hardware**, and click **Keyboard**.
- *In Windows 2000*, open the Control Panel and double-click the **Keyboard** icon.

Touch Pad

The touch pad detects the pressure and movement of your finger to allow you to move the cursor on the display. Use the touch pad and touch pad buttons as you would use a mouse.

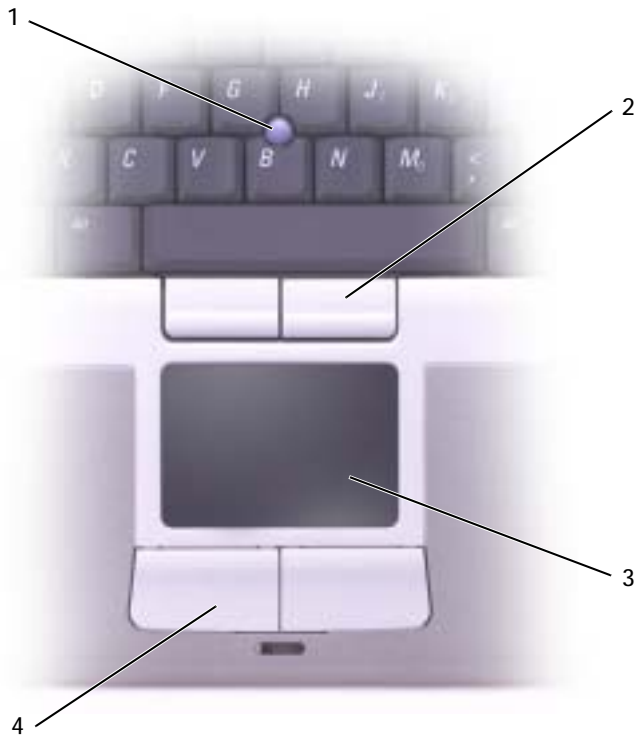

1	track stick
2	track stick buttons
3	touch pad
4	touch pad buttons

- To move the cursor, lightly slide your finger over the touch pad.
- To select an object, lightly tap once on the surface of the touch pad or use your thumb to press the left touch-pad button.

- To select and move (or drag) an object, position the cursor on the object and tap down-up-down on the touch pad. On the second down motion, leave your finger on the touch pad and move the selected object by sliding your finger over the surface.
- To double-click an object, position the cursor on the object and tap twice on the touch pad or use your thumb to press the left touch-pad button twice.

You can also use the track stick to move the cursor. Press the track stick left, right, up, or down to change the direction of the cursor on the display. Use the track stick and track stick buttons as you would use a mouse.

Customizing the Touch Pad and Track Stick

You can use the **Mouse Properties** window to disable the touch pad and track stick or adjust their settings.

- 1 *In Windows XP*, open the Control Panel, click **Printers and Other Hardware**, and click **Mouse**.
In Windows 2000, open the Control Panel and double-click the **Mouse** icon.
- 2 In the **Mouse Properties** window:
 - Click the **Device Select** tab to disable the touch pad and track stick.
 - Click the **Pointer** tab to adjust touch pad and track stick settings.
- 3 Click **OK** to save the settings and close the window.

Changing the Track Stick Cap

You can replace your track stick cap if it wears down from prolonged use or if you prefer a different color. You can purchase additional caps by visiting the Dell website at www.dell.com.



- 1 Pull the cap off the track stick.
 - 2 Align the new cap over the square track-stick post and gently press the cap down onto the post.
- ➔ **NOTICE:** The track stick can damage the display if it is not properly seated on the post.
- 3 Test the track stick to ensure that the cap is seated properly.

FILE LOCATION: S:\SYSTEMS\Pebble\UG\A00\English\keyboard.fm

DELL CONFIDENTIAL – PRELIMINARY 1/29/03 – FOR PROOF ONLY

SECTION 6

Using the Display

FILE LOCATION: S:\SYSTEMS\Pebble\UG\A00\English\display.fm

DELL CONFIDENTIAL – PRELIMINARY 1/29/03 – FOR PROOF ONLY

Adjusting Brightness

When the Dell™ computer is running on battery power, you can conserve power by setting the brightness to the lowest comfortable setting using the appropriate [keyboard shortcuts](#) for the display.

If [Dell QuickSet](#) is installed, the QuickSet Brightness Meter shows the current brightness setting for the display. Right-click the  icon in the taskbar to enable or disable the Brightness Meter on the screen.







1 Brightness Meter

NOTE: By default, the **Brightness Meter** appears in the lower-right corner of the display. You can click and drag the meter to a new location, and the meter subsequently always appears at the new location.

NOTE: Brightness keyboard shortcuts only affect the display on your portable computer, not monitors that you attach to your portable computer or docking device. If your computer is connected to an external monitor and you try to change the brightness level, the **Brightness Meter** appears, but the brightness level on the monitor does not change.



You can enable or disable the **Brightness Meter** from the **QuickSet** taskbar menu. When the meter is enabled, press the following keys to adjust brightness:

- Press   to increase brightness on the integrated display only (not on an external monitor).
- Press   to decrease brightness on the integrated display only (not on an external monitor).

For more information about **QuickSet**, right-click the  icon in the taskbar and click **Help**.

Switching the Video Image

When you start the computer with an external device (such as an external monitor or projector) attached and turned on, the image may appear on either the display or the external device.

Press   to switch the video image to the display only, the external device only, or the display and the external device simultaneously.

Setting Display Resolution

To display a program at a specific resolution, both the video controller and the display must support the program, and the necessary [video drivers must be installed](#).

Before you change any of the default display settings, make a note of the default settings for future reference.

If you choose a resolution or color palette that is higher than the display supports, the settings adjust automatically to the closest possible setting.



NOTE: Use only the Dell-installed video drivers, which are designed to offer the best performance with your Dell-installed operating system.

Microsoft® Windows® XP

- 1 Click the **Start** button and click **Control Panel**.
- 2 Under **Pick a category**, click **Appearance and Themes**.
- 3 Under **Pick a task...**, click the area you want to change, or under **or pick a Control Panel icon**, click **Display**.
- 4 Try different settings for **Color quality** and **Screen resolution**.

Windows 2000

- 1 Click the **Start** button, point to **Settings**, and then click **Control Panel**.
- 2 Double-click the **Display** icon and click the **Settings** tab.
- 3 Try different settings for **Colors** and **Screen area**.

 **NOTE:** As the resolution increases, icons and text appear smaller on the screen.

If the video resolution setting is higher than that supported by the display, the computer enters *pan mode*. In pan mode, the screen cannot be completely displayed. For example, the taskbar that usually appears at the bottom of the desktop may no longer be visible. To view the rest of the screen, use the touch pad or track stick to pan up, down, left, and right.

 **NOTICE:** You can damage an external monitor by using an unsupported refresh rate. Before adjusting the refresh rate on an external monitor, see the monitor user's guide.

SECTION 7

| Using the Dell™ D/Bay

About the Dell D/Bay

You can install **Dell Latitude™ D-Family** devices such as a floppy drive or an optical drive.

Removing and Installing Devices When the Computer is Turned Off

NOTICE: To prevent damage to devices, place them in a safe, dry place when they are not installed in the computer. Avoid pressing down on them or placing heavy objects on top of them.

- 1 Press the device latch release so that the latch release pops out.



- 2 Pull the device by the latch release to remove the device from the D/Bay.

DELL CONFIDENTIAL – PRELIMINARY 1/29/03 – FOR PROOF ONLY



- 3 Insert the new device into the bay, push the device until you feel a click, and push the device latch release in so that it is flush with the computer.
- 4 Connect the D/Bay cable to the **Dell D/Bay connector** on the computer..



Removing and Installing Devices While the Computer Is Running

Microsoft® Windows® XP

1 Double-click the **Safely Remove Hardware** icon on the taskbar.

2 Click the device you want to eject.



NOTICE: To prevent damage to devices, place them in a safe, dry place when they are not installed in the computer. Avoid pressing down on them or placing heavy objects on top of them.

3 Press the device latch release so that the latch release pops out.



4 Pull the device by the latch release to remove the device from the D/Bay.



- 5 Insert the new device into the bay, push the device until you feel a click, and push the device latch release in so that it is flush with the computer.

Windows XP automatically recognizes the new device.

- 6 If necessary, enter your password to **unlock your drive.**

Windows 2000

- 1 Click the **Unplug or Eject Hardware** icon on the taskbar.
- 2 Click the device you want to eject and click **Stop**.
- 3 Press the device latch release so that the latch release pops out.

FILE LOCATION: S:\SYSTEMS\Pebble\UG\A00\English\bay.fm



- 4 Pull the device by the latch release to remove the device from the D/Bay.



- 5 Insert the new device into the bay, push the device until you feel a click, and push the device latch release in so that it is flush with the computer.
- 6 When the operating system recognizes the new device, click **Close**.

DELL CONFIDENTIAL – PRELIMINARY 1/29/03 – FOR PROOF ONLY

Using the CD or DVD Tray

NOTICE: Do not press down on the drive tray when opening or closing it. Keep the tray closed when you are not using the drive.

NOTICE: Do not move the computer while playing CDs or DVDs.

- 1 Press the eject button on the front of the drive.
- 2 Pull the tray out.
- 3 Place the disc, label side up, in the center of the tray.
- 4 Snap the disc onto the spindle.



1 eject button

- 5 Push the tray back into the drive.

 **NOTE:** If you use a module bay that shipped with another Latitude D-Family computer, you need to install the drivers and software necessary to play DVDs or write data. For more information, see the *Drivers and Utilities* CD.

 **NOTE:** If the speaker is muted, you do not hear the CD or DVD playing.

You can play a DVD on your computer if the computer shipped with a DVD drive or a CD-RW/DVD combo drive. You can write data to a blank CD on your computer if the computer shipped with a CD-RW or CD-RW/DVD combo drive.

For more information on playing CDs or watching movies, click **Help** on the CD player or DVD player (if available).

Adjusting the Volume

- 1 Click the **Start** button, point to **All Programs**→ **Accessories**→ **Entertainment** (or **Multimedia**), and then click **Volume Control**.
- 2 In the **Volume Control** window, click and drag the bar in the **Volume Control** column and slide the bar up or down to increase or decrease the volume.





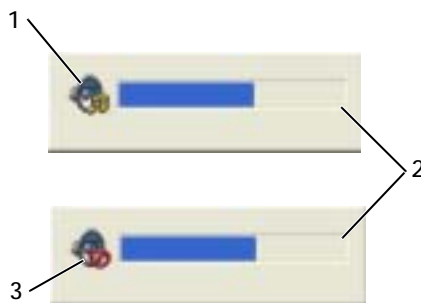

For more information on volume control options, click **Help** in the **Volume Control** window.

The Volume Meter displays the current volume level, including mute, on your computer. Either right-click the  icon in the taskbar or press the [volume control buttons](#) to enable or disable the Volume Meter on the screen (if [Dell QuickSet](#) is installed).



- | | |
|---|--------------|
| 1 | volume icon |
| 2 | Volume Meter |
| 3 | mute icon |

When the meter is enabled, adjust the volume using the volume control buttons or by pressing the following keys:

- Press   to increase volume.
- Press   to decrease volume.
- Press   to mute volume.

For more information about QuickSet, right-click the  icon in the taskbar and click **Help**.

 **NOTE:** By default, the Volume Meter appears in the lower-right corner of the display. You can click and drag the meter to a new location, and the meter subsequently always appears at the new location.

Adjusting the Picture

If an error message notifies you that the current resolution and color depth are using too much memory and preventing DVD playback, adjust the display properties.

Windows XP

- 1 Click the **Start** button and click **Control Panel**.
- 2 Under **Pick a category**, click **Appearance and Themes**.
- 3 Under **Pick a task...**, click **Change the screen resolution**.
- 4 In the **Display Properties** window, click and drag the bar in **Screen resolution** to change the setting to **1024 by 768 pixels**.
- 5 Under **Color quality**, click the drop-down menu and click **Medium (16 bit)**.
- 6 Click **OK**.

Windows 2000

- 1 Click the **Start** button, point to **Settings**, and then click **Control Panel**.
- 2 Double-click the **Display** icon and click the **Settings** tab.
- 3 Click and drag the bar in **Screen area** to change the setting to **1024 by 768 pixels**.
- 4 Under **Color quality**, click the drop-down menu and click **High Color (16 bit)**.

FILE LOCATION: S:\SYSTEMS\Pebble\UG\A00\English\bay.fm

- 5 Click **Apply**.
- 6 Click **OK** to save the settings and close the window.

SECTION 8

Using a Battery

FILE LOCATION: S:\SYSTEMS\Pebble\UG\A00\English\battery.fm

DELL CONFIDENTIAL – PRELIMINARY 1/29/03 – FOR PROOF ONLY

Battery Performance

Use a battery to power the computer when it is not connected to an electrical outlet. One battery is supplied as standard equipment in the battery bay.

Battery operating time varies depending on operating conditions. Operating time is significantly reduced when you perform operations including, but not limited to, the following:

- Using optical drives, especially DVD and CD-RW drives
- Using wireless communications devices, PC Cards, or USB devices
- Using high-brightness display settings, 3D screen savers, or other power-intensive programs such as 3D games
- Running the computer in [maximum performance mode](#)

You can [check the battery charge](#) before you [insert the battery](#) into the computer. You can also set power management options to alert you when the [battery charge is low](#).

 **CAUTION:** Using an incompatible battery may increase the risk of fire or explosion. Replace the battery only with a compatible battery purchased from Dell. The lithium-ion battery is designed to work with your Dell™ computer. Do not use batteries from other computers with your computer.



 **CAUTION:** Do not dispose of batteries with household waste. When your battery no longer holds a charge, call your local waste disposal or environmental agency for advice on disposing of a lithium-ion battery. See the battery disposal instructions in your *System Information Guide*.

 **CAUTION:** Misuse of the battery may increase the risk of fire or chemical burn. Do not puncture, incinerate, disassemble, or expose the battery to temperatures above 65°C (149°F). Keep the battery away from children. Handle damaged or leaking batteries with extreme care. Damaged batteries may leak and cause personal injury or equipment damage.

Checking the Battery Charge

The Microsoft® Windows® power meter window and  icon, the battery charge gauge and health gauge, and the low-battery warning provide information on the battery charge.

Dell QuickSet Battery Meter

If **Dell QuickSet** is installed, press   to display the QuickSet Battery Meter.

The Battery Meter screen displays status, charge level, and charge completion time for the battery in your computer.

In addition, when your computer is connected to a docking device (docked), the Battery Meter screen includes a **Dock Battery** tab, which displays the charge level and current status of the docking device battery.

The following icons appear in the Battery Meter screen:



- The computer or docking device is running on battery power.
- The battery is discharging or idle.



- The computer or docking device is connected to an electrical outlet and running on AC power.
- The battery is charging.





- The computer or docking device is connected to an electrical outlet and running on AC power.
 - The battery is discharging, idle, or charging.
-

For more information about QuickSet, right-click the  icon in the taskbar, and click **Help**.

Microsoft Windows Power Meter

The Windows power meter indicates the remaining battery charge. To check the power meter, double-click the  icon on the taskbar. For more information on the **Power Meter** tab, see "[Power Management](#)."

 **NOTE:** You can use your docking device to charge a computer battery. However, a battery in a docking device does not power the docking device or computer.

If the computer is connected to an electrical outlet, a  icon appears.

Charge Gauge

Press the status button on the battery charge gauge to illuminate the charge-level lights. Each light represents approximately 20 percent of the total battery charge. For example, if the battery has 80 percent of its charge remaining, four of the lights are on. If no lights appear, the battery has no charge.



Health Gauge

The battery operating time is largely determined by the number of times it is charged. After hundreds of charge and discharge cycles, batteries lose some charge capacity, or battery health. To check the battery health, press and hold the status button on the battery charge gauge for at least 3 seconds. If no lights appear, the battery is in good condition, and more than 80 percent of its original charge capacity remains. Each light represents incremental degradation. If five lights appear, less than 60 percent of the charge capacity remains, and you should consider replacing the battery. See "[Specifications](#)" for more information about the battery operating time.

Low-Battery Warning

- ➡ **NOTICE:** To avoid losing or corrupting data, save your work immediately after a low-battery warning. Then connect the computer to an electrical outlet, or install a second battery in the module bay. If the battery runs completely out of power, **standby mode begins automatically.**

A pop-up window warns you when the battery charge is approximately 90 percent depleted. For more information on low-battery alarms, see "[Power Management](#)."

Charging the Battery

When you connect the computer to an electrical outlet or install a battery while the computer is connected to an electrical outlet, the computer checks the battery charge and temperature. If necessary, the AC adapter then charges the battery and maintains the battery charge.

If the battery is **warm** from being used in your computer or being in a **warm** environment, the battery may not charge when you connect the computer to an electrical outlet.

The battery is too **warm** to start charging if the  light flashes alternately green and orange. Disconnect the computer from the electrical outlet and allow the computer and the battery to cool to room temperature. Then connect the computer to an electrical outlet to continue charging the battery.

For more information on resolving problems with a battery, see "[Power Problems](#)."

 **NOTE:** Charge time is longer with the computer turned on. You can leave the battery in the computer as long as you like. The battery internal circuitry prevents the battery from overcharging.

Removing a Battery

 **CAUTION:** Before performing these procedures, disconnect the modem from the telephone wall jack.

- ➡ **NOTICE:** If you choose to replace the battery with the computer in standby mode, you have up to 90 seconds to complete the battery replacement before the computer shuts down and loses any unsaved data.

- 1 Ensure that the computer is turned off, suspended in a power management mode, or connected to an electrical outlet.

FILE LOCATION: S:\SYSTEMS\Pebble\UG\A00\English\battery.fm

-
- 2 If the computer is connected to a docking device (docked), undock it. See the documentation that came with your docking device for instructions.
- 3 Slide and hold the battery-bay latch release on the bottom of the computer, and then remove the battery from the bay.



Installing a Battery

Slide the battery into the bay until the latch release clicks.

Storing a Battery

Remove the battery when you store your computer for an extended period of time. A battery discharges during prolonged storage. After a long storage period, [recharge the battery](#) fully before you use it.

DELL CONFIDENTIAL – PRELIMINARY 1/29/03 – FOR PROOF ONLY

SECTION 9

Power Management

FILE LOCATION: S:\SYSTEMS\Pebble\UG\A00\English\power.fm

DELL CONFIDENTIAL – PRELIMINARY 1/29/03 – FOR PROOF ONLY

 **NOTE:** See "Using a Battery" for more information on conserving battery power.

 **NOTE:** The power management options described in this section are for Microsoft® Windows® operating systems. Power management options may vary, depending on which operating system is installed.

 **NOTE:** The Power Management Wizard is not available if you have restricted access rights.

 **NOTE:** On the What is Power Management? screen, you can select Do not show this page again. When you select this option, the Welcome screen also does not appear again.

Power Management Tips

- Connect the computer to an electrical outlet when possible because battery life is largely determined by the number of times the battery is charged.
- Place the computer in **standby mode** or **hibernate mode** when you leave the computer unattended for long periods of time.
- To exit a power management mode, press the power button.

Power Management Wizard

If **Dell™ QuickSet** is installed, click or double-click the  icon to open the Power Management Wizard.



The first two screens of the wizard—**Welcome** and **What is Power Management?**—describe and define various power management options.

Use the following screens of the Power Management Wizard to set various power management options, including sleep modes, power schemes, and low battery-charge alarms.

Setting Sleep Modes

The screen defines standby and hibernate modes. From the screen you can:

- Set standby-mode password options.
- Enable or disable hibernate mode.
- Select how the computer will respond when you close the display:
 - Choose no action.
 - Enter standby mode.
 - Enter hibernate mode.

- Select how the computer will respond when you press the power button:
 - Choose no action.
 - Enter standby mode.
 - Enter hibernate mode.
 - Shut down the Microsoft® Windows® operating system and turn off the computer.
 - Prompt a user for an action (**Ask me what to do**).
- Select how the computer will respond when you press   :
 - Choose no action.
 - Enter standby mode.
 - Enter hibernate mode.
 - Shut down the operating system and turn off the computer.
 - Prompt a user for an action (**Ask me what to do**).

Selecting a Power Scheme

The screen allows you to select, create, and edit power scheme settings. In addition, you can delete power schemes that you create, but you cannot delete Dell™ QuickSet predefined power schemes (**Maximum Battery**, **Maximum Performance**, **Presentation**, and **Network Disabled**).



NOTE: When your computer is running on battery power, the **Network Disabled** power scheme disables your internal network and wireless activity. When your computer is connected to an electrical outlet or docking device, the **Network Disabled** power scheme disables only your wireless activity. You must set the power scheme through QuickSet (not Microsoft® Windows®) for **Network Disabled** to work.

 **NOTE:** QuickSet automatically adds the word (QuickSet) after the names of power schemes created using QuickSet.

 **NOTE:** Brightness shortcut keys only affect the display on your portable computer, not monitors that you attach to your portable computer or docking device. If your computer is in CRT only mode and you try to change the brightness level, the **Brightness Meter** appears, but the brightness level on the monitor does not change.

All QuickSet power schemes are displayed in a drop-down menu near the center of the screen. The power settings for each scheme in the menu are listed below the menu. The power settings are listed separately for when the computer is running on battery or connected to an electrical outlet.

The **Power Management Wizard** also allows you to associate the display brightness level with a power scheme. You must enable brightness-level power schemes through QuickSet in order to set the brightness level.

The display brightness, internal network-card activity, and wireless activity features are not available through the Microsoft® Windows® **Control Panel** power schemes. In order to make use of these value-added features, you must set them through QuickSet power schemes.

Setting Battery Alarms and Actions

The screen allows you to enable the low-battery and critical-battery alarms and to change settings for the alarms. For example, you can set the low-battery alarm to 20% to remind you to save work and switch to AC power, and you can set the critical-battery alarm to 10% to enter hibernate mode. From the screen, you can:

- Select whether the alarm will notify you by sound or text.
- Adjust the power level at which you want the alarm to notify you.
- Select how the computer will respond when the alarm notifies you:
 - Choose no action.
 - Enter standby mode.
 - Enter hibernate mode.
 - Shut down Windows and turn off the computer.

Completing the Power Management Wizard

The screen summarizes the QuickSet power scheme, sleep mode, and battery alarm settings for your computer. Review the settings you have selected and click **Finish**.

For more information about QuickSet, right-click the  icon in the taskbar and click **Help**.

Power Management Modes

Standby Mode

Standby mode conserves power by turning off the display and the hard drive after a predetermined period of inactivity (a time-out). When the computer exits standby mode, it returns to the same operating state it was in before entering standby mode.

 **NOTICE:** If your computer loses AC and battery power while in standby mode, it may lose data.

To enter standby mode:

• *In the Microsoft Windows XP operating system, click the **Start** button, click **Turn off computer**, and then click **Stand by**.*



• *In Windows 2000, click the **Start** button, click **Shutdown**, click **Standby**, and then click **OK**.*

or

• Depending on how you set the power management options on the [Advanced tab](#) in the **Power Options Properties** window, use one of the following methods:

– Press the power button.

– Close the display.

– Press  .

To exit standby mode, press the power button or open the display depending on how you set the options on the [Advanced tab](#). You cannot make the computer exit standby mode by pressing a key or touching the touch pad or track stick.

Hibernate Mode

Hibernate mode conserves power by copying system data to a reserved area on the hard drive and then completely turning off the computer. When the computer exits hibernate mode, it returns to the same operating state it was in before entering hibernate mode.

 **NOTICE:** You cannot remove devices or undock your computer while your computer is in hibernate mode.



Your computer enters hibernate mode if the battery charge level becomes critically low.

To manually enter hibernate mode:

- *In Windows XP*, click the **Start** button, click **Turn off computer**, press and hold , and then click **Hibernate**.

In Windows 2000, if [hibernate support is enabled](#), click the **Start** button, click **Shutdown**, click **Hibernate**, and then click **OK**.

or

- Depending on how you set the power management options on the [Advanced tab](#) in the **Power Options Properties** window, use one of the following methods to enter hibernate mode:
 - Press the power button.
 - Close the display.
 - Press  .

 **NOTE:** Some PC Cards may not operate correctly after the computer exits hibernate mode. [Remove and reinsert the card](#), or simply restart (reboot) your computer.

To exit hibernate mode, press the power button. The computer may take a short time to exit hibernate mode. You cannot make the computer exit hibernate mode by pressing a key or touching the touch pad or track stick. For more information on hibernate mode, see the documentation that came with your operating system.

Power Options Properties

The **Power Options Properties** window helps you to manage power consumption and monitor battery charge status. To access the Microsoft® Windows® **Power Options Properties** window:

- *In Windows XP*, click the **Start** button → **Control Panel** → **Performance and Maintenance** → **Power Options**.
- *In Windows 2000*, open the Control Panel, and then double-click the **Power Options** icon.

Power Schemes Tab

The **Power schemes** drop-down menu displays the selected preset power scheme. Keep the default **Portable/Laptop** power scheme to maximize battery power.

Windows XP controls the performance level of the processor depending on the power scheme you select. You do not need to make any further adjustments to set the performance level. For information on setting processor performance for other operating systems, see "Intel SpeedStep[®] Technology Tab."

Each preset power scheme has different time-out settings for entering standby mode, turning off the display, and turning off the hard drive. For more information on power management options, see the Help and Support Center (Windows *Help* in Windows 2000).

Alarms Tab

The **Low battery alarm** and **Critical battery alarm** settings alert you with a message when the battery charge falls below a certain percentage. When you receive your computer, the **Low battery alarm** and **Critical battery alarm** check boxes are selected. It is recommended that you continue to use these settings. See "[Using a Battery](#)" for more information on low-battery warnings.



NOTE: To enable audible alarms, click each **Alarm Action** button and select **Sound alarm**.

Power Meter Tab

The **Power Meter** tab displays the current power source and amount of battery charge remaining.

Advanced Tab

The **Advanced** tab allows you to:

- Set power icon and standby mode password options.
- Program the following functions (depending on your operating system):
 - Prompt a user for an action (**Ask me what to do**).
 - Enter standby mode.
 - Enter hibernate mode.

- Shut down Windows and turn off the computer.
- Choose no action (**None** or **Do nothing**).

To program these functions, click an option from the corresponding drop-down menu and then click **OK**.

Hibernate Tab

The **Hibernate** tab lets you enable hibernate mode by clicking the **Enable hibernate support** check box.

Intel SpeedStep® Technology Tab

 **NOTE:** Windows XP controls the performance level of the processor depending on the power scheme that you select. See "Power Schemes Tab."

 **NOTE:** To use Intel SpeedStep technology, a Windows operating system must be running.

Depending on your operating system and microprocessor, the **Power Options Properties** window includes the **Intel SpeedStep® technology** tab. The Intel SpeedStep technology allows you to set the performance level of the processor according to whether the computer is running on battery or AC power. Depending on your operating system, typical options are:

- **Automatic** — The processor runs at its highest possible speed (Maximum Performance mode) when the computer is running on AC power. When the computer is running on battery power, the processor runs in Battery Optimized mode.
- **Maximum Performance** — The processor is capable of running at its highest possible speed even if the computer is running on battery power.
- **Battery Optimized Performance** — Processor speed is optimized for battery power even if the computer is connected to an electrical outlet.

To change additional Intel SpeedStep options:

- 1 Click **Advanced** and then click one of the following options:
 - **Disable Intel SpeedStep technology control**
 - **Remove flag icon** (from the notification area)
 - **Disable audio notification when performance changes**

FILE LOCATION: S:\SYSTEMS\Pebble\UG\A00\English\power.fm

- 2 Click **OK** to accept any changes, and then click **OK** to close the **Intel SpeedStep® technology** window.

You can also change the Intel SpeedStep settings by right-clicking the flag icon in the notification area.

FILE LOCATION: S:\SYSTEMS\Pebble\UG\A00\English\power.fm

DELL CONFIDENTIAL – PRELIMINARY 1/29/03 – FOR PROOF ONLY

SECTION 10

Using PC Cards

FILE LOCATION: S:\SYSTEMS\Pebble\UG\A00\English\pccards.fm

DELL CONFIDENTIAL - PRELIMINARY 1/29/03 - FOR PROOF ONLY

PC Card Types

See "[Specifications](#)" for information on supported PC Cards.



NOTE: A PC Card is not a bootable device.

The PC Card slot has one connector that supports a single Type I or Type II card. The PC Card slot supports CardBus technology and extended PC Cards. "Type" of card refers to its thickness, not its functionality.

PC Card Blanks

Your computer shipped with a plastic blank installed in the PC Card slot. Blanks protect unused slots from dust and other particles. Save the blank for use when no PC Card is installed in the slot; blanks from other computers may not fit your computer.

To remove the blank, see "Removing a PC Card or Blank."

Extended PC Cards

An extended PC Card (for example, a wireless network adapter) is longer than a standard PC Card and extends outside the computer. Follow these precautions when using extended PC Cards:

- Protect the exposed end of an installed card. Striking the end of the card can damage the system board.
- Always remove an extended PC Card before you pack the computer in its carrying case.

Installing a PC Card

You can install a PC Card in the computer while the computer is running. The computer automatically detects the card.

PC Cards are generally marked with a symbol (such as a triangle or an arrow) to indicate which end to insert into the slot. The cards are keyed to prevent incorrect insertion. If card orientation is not clear, see the documentation that came with the card.

To install a PC Card:

- 1 Hold the card with its orientation symbol pointing into the slot and the top side of the card facing up. The latch may need to be in the "in" position before you insert the card.
- 2 Slide the card into the slot until the card is completely seated in its connector.

If you encounter too much resistance, do not force the card. Check the card orientation and try again.



The computer recognizes most PC Cards and automatically loads the appropriate device driver. If the configuration program tells you to load the manufacturer's drivers, use the floppy disk or CD that came with the PC Card.

Removing a PC Card or Blank

🔍 **NOTICE:** Use the PC Card configuration utility  on the taskbar to select a card and stop it from functioning before you remove it from the computer. If you do not stop the card in the configuration utility, you could lose data. Do not attempt to eject a card by pulling its cable, if one is attached.

- 1 Press the eject button.

FILE LOCATION: S:\SYSTEMS\Pebble\UG\A00\English\pccards.fm

- 2 Press the eject button a second time.
- 3 Gently remove the card.



DELL CONFIDENTIAL - PRELIMINARY 1/29/03 - FOR PROOF ONLY

FILE LOCATION: S:\SYSTEMS\Pebble\UG\A00\English\pccards.fm

Save a blank to use when no PC Card is installed in a slot. Blanks protect unused slots from dust and other particles.

DELL CONFIDENTIAL – PRELIMINARY 1/29/03 – FOR PROOF ONLY

FILE LOCATION: S:\SYSTEMS\Pebble\UG\A00\English\pccards.fm

DELL CONFIDENTIAL – PRELIMINARY 1/29/03 – FOR PROOF ONLY

SECTION 11

Using Smart Cards

FILE LOCATION: S:\SYSTEMS\Pebble\UG\A00\English\smart.fm

DELL CONFIDENTIAL – PRELIMINARY 1/29/03 – FOR PROOF ONLY

About Smart Cards

Smart cards are small portable credit-card shaped devices with internal integrated circuits. Smart cards come in two varieties: memory and microprocessor. Memory smart cards store data but cannot process information. Microprocessor smart cards can add, delete, and manipulate information in the card memory. The top surface of the microprocessor smart card contains an embedded microprocessor located under the gold contact pad. Microprocessor smart cards can be used for programs such as:

- Secure log-on and authentication of users to PCs and networks
- Secure business-to-business (B2B) and business-to-consumer (B2C) e-commerce
- Storage of digital certificates, credentials, and passwords
- Encryption of sensitive data



NOTE: To use a smart card for secure PC log-on and authentication, B2B and B2C e-commerce, local file encryption, and storage of digital certificates, additional software is required. To use a smart card for secure network log-on and authentication, file and e-mail encryption, and Virtual Private Network (VPN) log-on, you need to enable Microsoft® Windows® PKI support.

The combination of the small size and integrated circuits make smart cards valuable tools for security, data storage, and special programs. Using smart cards can improve system security by combining something a user has (the smart card) with something only the user should know (a PIN) to provide more secure user-authentication than passwords alone.

Installing a Smart Card

You can install a smart card in the computer while the computer is running. The computer automatically detects the card.

To install a smart card:

- 1 Remove the smart card blank from the smart card slot.
- 2 Hold the card face up with the gold contact pad on the top surface and pointing toward the smart card slot.

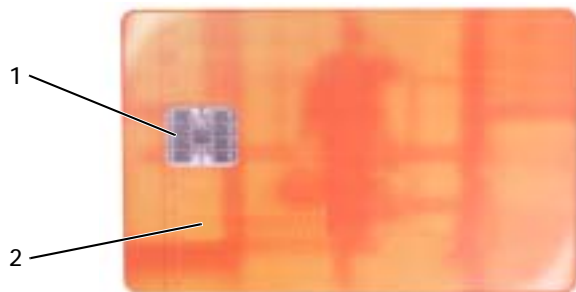

1 gold contact pad

2 smart card (top)

- 3 Slide the smart card into the smart card slot until the card is completely seated in its connector. The smart card will protrude from the slot. The smart card slot is located below the PC Card slot.

If you encounter too much resistance, do not force the card. Check the card orientation and try again.



FILE LOCATION: S:\SYSTEMS\Pebble\UG\A00\English\smart.fm

1 smart card slot

2 smart card

DELL CONFIDENTIAL – PRELIMINARY 1/29/03 – FOR PROOF ONLY

SECTION 12

Traveling With Your Computer

FILE LOCATION: S:\SYSTEMS\Pebble\UG\A00\English\travel.fm

DELL CONFIDENTIAL - PRELIMINARY 1/29/03 - FOR PROOF ONLY

Identifying Your Computer



- Attach a name tag or business card to the computer, or use a permanent marker or stencil to write a unique identifying mark (such as your driver's license number) on the computer.
- Write down your **Service Tag** and store it in a safe place away from the computer or carrying case. Use the Service Tag if you need to report a loss or theft to law enforcement officials and to Dell.
- Assign an **owner tag**, which appears in the system log-on screen and cannot be changed or deleted if the primary or administrator passwords are set.
- Contact your credit card company and ask if it offers coded identification tags.

Packing the Computer

- Remove any external devices attached to the computer and store them in a safe place. Remove any cables attached to installed PC Cards, and **remove any extended PC Cards.**
- To make the computer as light as possible, replace any devices installed in the module bay with the Dell TravelLite™ module.
- Fully charge the main battery and any spare batteries you plan to carry with you.
- Shut down the computer.
- Disconnect the AC adapter.
-  **NOTICE:** When the display is closed, extraneous items on the keyboard or palm rest could damage the display.
- Remove any extraneous items, such as paper clips, pens, and paper, from the keyboard and palm rest and close the display.
- Use the optional Dell™ carrying case to pack the computer and its accessories together safely.
- Avoid packing the computer with items such as shaving cream, colognes, perfumes, or food.

- Protect the computer, the batteries, and the hard drive from hazards such as extreme temperatures and overexposure to sunlight, dirt, dust, or liquids.
- ➡ **NOTICE:** If the computer has been exposed to extreme temperatures, allow it to acclimate to room temperature for 1 hour before turning it on.
- Pack the computer so that it does not slide around in the trunk of your car or in an overhead storage compartment.
- ➡ **NOTICE:** Do not check the computer as baggage.

Travel Tips

- ➡ **NOTICE:** Do not move the computer while using the optical drive. Doing so can result in loss of data.
- Consider disabling wireless activity on your computer to maximize battery operating time. To disable wireless activity, press  .
- Consider changing your [power management options](#) to maximize battery operating time.
- If you are traveling internationally, carry proof of ownership—or of your right to use the computer if it is company-owned—to speed your passage through customs. Investigate the customs regulations of the countries you plan to visit, and consider acquiring an international carnet (also known as a *merchandise passport*) from your government.
- Ensure that you know which electrical outlets are used in the countries you will visit, and have appropriate power adapters.
- Check with your credit card company for information about the kinds of emergency travel assistance it offers to users of portable computers.

Traveling by Air

- Ensure that you have a charged battery available in case you are asked to turn on the computer.
- ➡ **NOTICE:** Do not walk the computer through a metal detector. Send the computer through an X-ray machine or have it hand inspected.
- Before you use the computer on an airplane, verify that such usage is permitted. Some airlines forbid the use of electronic devices during the flight. All airlines forbid the use of electronic devices during takeoff and landing.

If Your Computer Is Lost or Stolen

 **NOTE:** If you know where the computer was lost or stolen, call a law enforcement agency in that area. If you do not know, call a law enforcement agency where you live.

- Call a law enforcement agency to report the lost or stolen computer. Include the Service Tag in your description of the computer. Ask that a case number be assigned and write down the number, along with the name, address, and telephone number of the law enforcement agency. If possible, obtain the name of the investigating officer.
- If the computer belongs to a company, notify the security office of the company.
- Contact Dell customer service to report the missing computer. Provide the computer Service Tag, the case number, and the name, address, and telephone number of the law enforcement agency to which you reported the missing computer. If possible, give the name of the investigating officer.

The Dell customer service representative will log your report under the computer Service Tag and flag the computer as missing or stolen. If someone calls Dell for technical assistance and gives your Service Tag, the computer is identified automatically as missing or stolen. The representative will attempt to get the phone number and address of the caller. Dell will then contact the law enforcement agency to which you made the report of the missing computer.

SECTION 13

Passwords

FILE LOCATION: S:\SYSTEMS\Pebble\UG\A00\English\password.fm

DELL CONFIDENTIAL – PRELIMINARY 1/29/03 – FOR PROOF ONLY

 **NOTE:** Passwords are disabled when you receive your computer.

 **NOTE:** Only hard drives purchased from Dell for use with the Dell™ Latitude™ D-Family computers support hard drive passwords.

About Passwords

A primary password prevents unauthorized access to the computer at start-up. You can use an administrator password instead of the primary password. A hard drive password helps prevent unauthorized access to data on the drive, even when the drive is installed in another computer.

 **NOTICE:** Passwords provide a high level of security for data in your computer or hard drive. However, they are not foolproof. If you require more security, obtain and use additional forms of protection, such as data encryption programs or PC Cards with encryption features.

If you forget any of your passwords, contact your system administrator or call Dell. For your protection, Dell technical support staff will ask you for proof of your identity to ensure that only an authorized person can use the computer.

The following table identifies types and features of passwords available on your computer.

Type of Password	Features
Primary	<ul style="list-style-type: none">• Protects the computer from unauthorized access
Administrator	<ul style="list-style-type: none">• Gives system administrators or service technicians access to computers for repair or reconfiguration• Allows you to restrict access to the system setup program in the same way a system password restricts access to the computer• Can be used instead of the primary password
Hard drive	<ul style="list-style-type: none">• Helps protect the data on your hard drive or external hard drive (if one is being used) from unauthorized access.

Using a Primary Password

The primary password allows you to protect the computer from unauthorized access.

After assigning a primary password, you must enter it each time you turn on your computer. The following message appears each time you turn on the computer:

Please type in the primary or administrator password and press  .

To continue, enter your password (maximum eight characters).

If you do not enter a password within 2 minutes, the computer returns to its previous state.

If you have assigned an administrator password, you can use it instead of the primary password. The computer does not specifically prompt you for the administrator password.

 **NOTICE:** If you disable the administrator password, the primary password is also disabled.

Using an Administrator Password

The administrator password is designed to give system administrators or service technicians access to computers for repair or reconfiguration. The administrators or technicians can assign identical administrator passwords to groups of computers, allowing you to assign the primary password.

When you set an administrator password, the **Configure Setup** option becomes available in the system setup program. The **Configure Setup** option allows you to restrict access to the system setup program in the same way a primary password restricts access to the computer.

The administrator password can be used instead of the primary password. Whenever you are prompted to enter the primary password, you can enter the administrator password.

If you forget the primary password and do not have an administrator password assigned, or if you have both a primary and an administrator password assigned but forget them both, contact your system administrator or contact Dell.

 **NOTICE:** If you disable the administrator password, the primary password is also disabled.

 **NOTE:** The administrator password provides access to the computer, but it does not provide access to the hard drive when a hard drive password is assigned.

Using a Hard Drive Password

The hard drive password helps protect the data on your hard drive from unauthorized access. You can also assign a password for an external hard drive (if one is being used) that can be the same as or different from the password for the primary hard drive.

After assigning a hard drive password, you must enter it each time you turn on the computer and each time you resume normal operation from standby mode.

If the hard drive password is enabled, the following message appears each time you turn on the computer:

Please type in the hard-disk drive password and press



To continue, enter your password (maximum eight characters). Press  to return the computer to its previous state.

If you do not enter a password within 2 minutes, the computer returns to its previous state.

If you enter the wrong password, the following message appears:

Invalid password
[Press Enter to retry]

If the correct password is not entered in three attempts, the computer tries to boot from the next device in the **Boot Order** list in the system setup program. If there are no other enabled devices in the **Boot Order** list, the computer returns to the state it was in when you turned it on.

If the hard drive password, the external hard drive password, and the primary password are the same, you are prompted only for the primary password. If the hard drive password is different from the primary password, you are prompted for both. Two different passwords provide greater security.

Assigning an Asset Tag



The Asset Tag utility allows you to enter an asset tag that you or your company assigns to the computer. After you enter an asset tag, the tag appears in the system setup screens.

You can also use the Asset Tag utility to enter an owner tag that appears in the system log-on screen and with the primary password prompt.

Use your *Drivers and Utilities* CD to create a bootable floppy disk, and then use the bootable floppy disk to assign an asset tag:

- 1 Save and close any open files and exit any open programs.
- 2 Connect the Dell™ D/Bay with a floppy drive to the powered USB connector on the computer, or connect a USB floppy drive to the USB connector on the back of the computer.
- 3 Insert the *Drivers and Utilities* CD.
- 4 When the **Welcome Dell System Owner** window appears, click **Next**.
- 5 Select **MS-DOS** from the **Operating System** drop-down menu.
- 6 Click **Dell Portables Asset Tag**, click **Extract**, and then click **Setup**.
- 7 Insert a blank floppy disk and press .

Follow the instructions on the screen to create a bootable floppy disk.

- 8 Boot the computer using the bootable floppy disk:
 - a Restart the computer.
 - b Press  immediately after the DELL™ logo appears.
If the operating system logo appears, wait until you see the Windows desktop, and then shut down the computer and try again.
 - c Press the arrow keys to select **Diskette Drive** and press .

- 9 Type `asset` and a space followed by the new asset tag, and press

.

For example, type the following command line and press .

```
asset 1234$ABCD&
```

 **NOTE:** The administrator password provides access to the computer, but it does not provide access to a hard drive that is protected by a hard drive password.

 **NOTE:** An asset tag can have up to 10 characters; any combination of characters excluding spaces is valid.

- 10 When the computer prompts you to verify the asset tag, type *y*.
The computer displays the new or modified asset tag and the Service Tag.
- 11 Restart your computer to exit the Asset Tag utility.

Viewing Existing Asset and Service Tags

- 1 Boot the computer using the bootable floppy disk you created in "[Assigning an Asset Tag](#)."
- 2 Type `asset` and press .

Deleting an Asset Tag

- 1 Boot the computer using the bootable floppy disk you created in "[Assigning an Asset Tag](#)."
- 2 Type `asset /d` and press .
- 3 When the computer prompts you to delete the asset tag, type *y*.

Assigning an Owner Tag

An owner tag can have up to 48 characters; any combination of letters, numbers, and spaces is valid.

- 1 Boot the computer using the bootable floppy disk you created in "[Assigning an Asset Tag](#)."
- 2 Type `asset /o` and a space followed by the new owner tag, and press .

For example, type the following command line and press :

```
asset /o ABC Company
```

- 3 When the computer prompts you to verify the owner tag, type *y*.
The computer displays the new owner tag.

Deleting an Owner Tag

- 1 Boot the computer using the bootable floppy disk you created in "[Assigning an Asset Tag](#)."
- 2 Type `asset /o /d` and press .
- 3 When the computer prompts you to delete the owner tag, type `y`.

 **NOTE:** For security, you cannot set, change, or delete the owner tag if the primary or administrator passwords are set.

Asset Tag Options

To use one of the asset tag options (see the following table):

- 1 Boot the computer using the bootable floppy disk you created in "[Assigning an Asset Tag](#)."
- 2 Type `asset` and a space followed by the option, and then press



Asset Tag Option	Description
<code>/d</code>	Deletes the asset tag
<code>/o owner tag</code>	Specifies a new owner tag
<code>/o /d</code>	Deletes the owner tag
<code>/?</code>	Displays the Asset Tag utility help screen

FILE LOCATION: S:\SYSTEMS\Pebble\UG\A00\English\password.fm

DELL CONFIDENTIAL – PRELIMINARY 1/29/03 – FOR PROOF ONLY

SECTION 14

Solving Problems

FILE LOCATION: S:\SYSTEMS\Pebble\UG\A00\English\problems.fm

DELL CONFIDENTIAL - PRELIMINARY 1/29/03 - FOR PROOF ONLY

Power Problems

Fill out the [Diagnostics Checklist](#) as you complete these checks.

CHECK THE POWER LIGHT — When the power light is lit or blinking, the computer has power. If the power light is blinking, the computer is in standby mode—press the power button to exit [standby mode](#). If the light is off, press the power button to turn on the computer or [to exit hibernate mode](#).

CHARGE THE BATTERY — The battery charge may be depleted.

- 1 Reinstall the battery.
- 2 Use the AC adapter to connect the computer to an electrical outlet.
- 3 Turn on the computer.

CHECK THE BATTERY STATUS LIGHT — If the battery status light flashes orange or is a steady orange the battery charge is low or depleted. Connect the computer to an electrical outlet.

If the battery status light flashes green and orange, the battery is too [warm](#) to charge. Shut down the computer, disconnect the computer from the electrical outlet, and then let the battery and computer cool to room temperature.

If the battery status light rapidly flashes orange, the battery may be defective. [Contact Dell](#).

TEST THE ELECTRICAL OUTLET — Ensure that the electrical outlet is working by testing it with another device, such as a lamp.

CHECK THE AC ADAPTER — Check the AC adapter cable connections. If the AC adapter has a light, ensure that the light is on.

CONNECT THE COMPUTER DIRECTLY TO AN ELECTRICAL OUTLET — Bypass power protection devices, power strips, and the extension cable to verify that the computer turns on.

ELIMINATE POSSIBLE INTERFERENCE — Turn off nearby fans, fluorescent lights, halogen lamps, or other appliances.

ADJUST THE POWER PROPERTIES — See "Power Management."

RESEAT THE MEMORY MODULES — If the computer power light turns on but the display remains blank, [reseat the memory modules](#).

Error Messages

If the message is not listed, see the documentation for the operating system or the program that was running at the time the message appeared.

AUXILIARY DEVICE FAILURE — The touch pad, track stick, or external mouse may be faulty. For an external mouse, check the cable connection. Enable the **Pointing Device** option in the system setup program. If the problem persists, [contact Dell](#).

BAD COMMAND OR FILE NAME — Ensure that you have spelled the command correctly, put spaces in the proper place, and used the correct pathname.

CACHE DISABLED DUE TO FAILURE — The primary cache internal to the microprocessor has failed. [Contact Dell](#).

CD DRIVE CONTROLLER FAILURE — The CD drive does not respond to commands from the computer. See "[Drive Problems](#)."

DATA ERROR — The floppy or hard drive cannot read the data. See "[Drive Problems](#)."

DECREASING AVAILABLE MEMORY — One or more memory modules may be faulty or improperly seated. [Reseat the memory modules](#) and, if necessary, replace them.

DISK C: FAILED INITIALIZATION — The hard drive failed initialization. Run the Hard-Disk Drive tests as described in "[Using the Dell Diagnostics](#)."

FLOPPY DRIVE 0 SEEK FAILURE — The system configuration information may not match the hardware configuration. Run the Diskette tests as described in "[Using the Dell Diagnostics](#)."

DISKETTE READ FAILURE — The floppy disk may be defective. If the drive access light turns on, try a different disk. See "[Drive Problems](#)."

DISKETTE SUBSYSTEM RESET FAILED — The floppy drive controller may be faulty. Run the Diskette tests as described in "[Using the Dell Diagnostics](#)."

DISKETTE WRITE-PROTECTED — Because the floppy disk is write-protected, the operation cannot be completed. Slide the write-protect notch.

DRIVE NOT READY — The operation requires a floppy disk in the drive or a hard drive in the bay before it can continue. Insert a floppy disk, or push the floppy disk all the way into the drive until the eject button pops out. Or, [install a hard drive](#) in the hard drive bay.

ERROR READING PCMCIA CARD — The computer cannot identify the PC Card. [Reinsert the card](#) or try another PC Card.

EXTENDED MEMORY SIZE HAS CHANGED — The amount of memory recorded in NVRAM does not match the memory installed in the computer. Restart the computer. If the error appears again, [contact Dell](#).

GATE A20 FAILURE — A memory module may be loose. [Reinstall the memory modules](#) and, if necessary, replace them.

GENERAL FAILURE — The operating system is unable to carry out the command. The message is usually followed by specific information—for example, `Printer out of paper`. Take the appropriate action.

HARD-DISK DRIVE CONFIGURATION ERROR — The computer cannot identify the drive type. Turn off the computer, [remove the hard drive](#), and boot the computer from a bootable floppy disk or CD. Then turn off the computer, reinstall the hard drive, and restart the computer. Run the Hard-Disk Drive tests as described in "[Using the Dell Diagnostics](#)."

HARD-DISK DRIVE CONTROLLER FAILURE 0 — The hard drive does not respond to commands from the computer. Turn off the computer, [remove the hard drive](#), and boot the computer from a bootable floppy disk or CD. Then turn off the computer, reinstall the hard drive, and restart the computer. If the problem persists, try another drive. Run the Hard-Disk Drive tests as described in "[Using the Dell Diagnostics](#)."

HARD-DISK DRIVE FAILURE — The hard drive does not respond to commands from the computer. Turn off the computer, [remove the hard drive](#), and boot the computer from a bootable floppy disk or CD. Then turn off the computer, reinstall the hard drive, and restart the computer. If the problem persists, try another drive. Run the Hard-Disk Drive tests as described in "[Using the Dell Diagnostics](#)."

HARD-DISK DRIVE READ FAILURE — The hard drive may be defective. Turn off the computer, [remove the hard drive](#), and boot the computer from a bootable floppy disk or CD. Then turn off the computer, reinstall the hard drive, and restart the computer. If the problem persists, try another drive. Run the Hard-Disk Drive tests as described in "[Using the Dell Diagnostics](#)."

INSERT BOOTABLE MEDIA — The operating system is trying to boot to a nonbootable floppy disk or CD. Insert a bootable floppy disk or CD.

INVALID CONFIGURATION INFORMATION-PLEASE RUN SYSTEM SETUP PROGRAM — The system configuration information does not match the hardware configuration. The message is most likely to occur after a memory module is installed. Correct the appropriate options in the system setup program. See "[Using the System Setup Program](#)."

KEYBOARD CLOCK LINE FAILURE — For external keyboards, check the cable connection. Run the Keyboard Controller test as described in "[Using the Dell Diagnostics](#)."

KEYBOARD CONTROLLER FAILURE — For external keyboards, check the cable connection. Restart the computer, and avoid touching the keyboard or the mouse during the boot routine. Run the Keyboard Controller test as described in "[Using the Dell Diagnostics](#)."

KEYBOARD DATA LINE FAILURE — For external keyboards, check the cable connection. Run the Keyboard Controller test as described in "[Using the Dell Diagnostics](#)."

KEYBOARD STUCK KEY FAILURE — For external keyboards or keypads, check the cable connection. Restart the computer, and avoid touching the keyboard or keys during the boot routine. Run the Stuck Key test as described in "[Using the Dell Diagnostics](#)."

MEMORY ADDRESS LINE FAILURE AT ADDRESS, READ VALUE EXPECTING VALUE — A memory module may be faulty or improperly seated. [Reinstall the memory modules](#) and, if necessary, replace them.

MEMORY ALLOCATION ERROR — The software you are attempting to run is conflicting with the operating system, another program, or a utility. Turn off the computer, wait 30 seconds, and then restart it. Try to run the program again. If the error message still appears, see the software documentation.

MEMORY DATA LINE FAILURE AT ADDRESS, READ VALUE EXPECTING VALUE — A memory module may be faulty or improperly seated. [Reinstall the memory modules](#) and, if necessary, replace them.

MEMORY DOUBLE WORD LOGIC FAILURE AT ADDRESS, READ VALUE EXPECTING VALUE — A memory module may be faulty or improperly seated. [Reinstall the memory modules](#) and, if necessary, replace them.

MEMORY ODD/EVEN LOGIC FAILURE AT ADDRESS, READ VALUE EXPECTING VALUE — A memory module may be faulty or improperly seated. [Reinstall the memory modules](#) and, if necessary, replace them.

MEMORY WRITE/READ FAILURE AT ADDRESS, READ VALUE EXPECTING VALUE — A memory module may be faulty or improperly seated. [Reinstall the memory modules](#) and, if necessary, replace them.

NO BOOT DEVICE AVAILABLE — The computer cannot find the floppy disk or hard drive. If the floppy drive is your boot device, ensure that a bootable floppy disk is in the drive. If the hard drive is your boot device, ensure that the drive is installed, properly seated, and partitioned as a boot device.

NO BOOT SECTOR ON HARD DRIVE — The operating system may be corrupted. [Contact Dell.](#)

NO TIMER TICK INTERRUPT — A chip on the system board may be malfunctioning. Run the System Set tests as described in "[Using the Dell Diagnostics.](#)"

NON-SYSTEM DISK OR DISK ERROR — A floppy disk is in the floppy drive. Remove the floppy disk and restart the computer.

NOT A BOOT DISKETTE — The operating system is trying to boot to a nonbootable floppy disk. Insert a bootable floppy disk.

OPERATING SYSTEM NOT FOUND — [Contact Dell.](#)

OPTIONAL ROM BAD CHECKSUM — The optional ROM apparently failed. [Contact Dell.](#)

A REQUIRED .DLL FILE WAS NOT FOUND — The program that you are trying to open is missing an essential file. Remove and then reinstall the program.

Microsoft® Windows® XP

- 1 Click the **Start** button and click **Control Panel**.
- 2 Click **Add or Remove Programs**.
- 3 Select the program you want to remove.
- 4 Click **Remove** or **Change/Remove** and follow the prompts on the screen.
- 5 See the program documentation for installation instructions.

Windows 2000

- 1 Click the **Start** button, point to **Settings**, and then click **Control Panel**.
- 2 Double-click the **Add/Remove Programs** icon.
- 3 Select the program that you want to remove.
- 4 Click **Change or Remove Programs**.
- 5 See the program documentation for installation instructions.

SECTOR NOT FOUND — The operating system cannot locate a sector on the floppy or hard drive. You may have a defective sector or corrupted FAT on the floppy disk or hard drive. Run the Windows error-checking utility to check the file structure on the floppy disk or hard drive. See the Windows Help and Support Center (*Help* in Windows 2000) for instructions. If a large number of sectors are defective, back up the data (if possible), and then reformat the floppy disk or hard drive.

SEEK ERROR — The operating system cannot find a specific track on the floppy disk or hard drive. If the error is on the floppy disk, try another floppy disk.

SHUTDOWN FAILURE — A chip on the system board may be malfunctioning. Run the System Set tests as described in "[Using the Dell Diagnostics](#)."

TIME-OF-DAY CLOCK LOST POWER — System configuration settings are corrupted. Connect your computer to an electrical outlet to charge the battery. If the problem persists, try to restore the data by entering the system setup program. Then immediately exit the program. See "[Using the System Setup Program](#)." If the message reappears, [contact Dell](#).

TIME-OF-DAY CLOCK STOPPED — The reserve battery that supports the system configuration settings may require recharging. Connect your computer to an electrical outlet to charge the battery. If the problem persists, [contact Dell](#).

TIME-OF-DAY NOT SET-PLEASE RUN THE SYSTEM SETUP PROGRAM — The time or date stored in the system setup program does not match the system clock. Correct the settings for the **Date** and **Time** options. See "[Using the System Setup Program](#)."

TIMER CHIP COUNTER 2 FAILED — A chip on the system board may be malfunctioning. Run the System Set tests as described in "[Using the Dell Diagnostics](#)."

UNEXPECTED INTERRUPT IN PROTECTED MODE — The keyboard controller may be malfunctioning, or a memory module may be loose. Run the System Memory tests and the Keyboard Controller test as described in "[Using the Dell Diagnostics](#)."

X:\ IS NOT ACCESSIBLE. THE DEVICE IS NOT READY — Insert a disk into the drive and try again.

WARNING: BATTERY IS CRITICALLY LOW — The **battery is running out of charge**. Replace the battery, or connect the computer to an electrical outlet. Otherwise, activate **hibernate mode** or turn off the computer.

Video and Display Problems

Fill out the [Diagnostics Checklist](#) as you complete these checks.

If the display is blank



CHECK THE BATTERY — If you are using a battery to power your computer, the battery charge may be depleted. Connect the computer to an electrical outlet using the AC adapter, and turn on the computer.

TEST THE ELECTRICAL OUTLET — Ensure that the electrical outlet is working by testing it with another device, such as a lamp.

CHECK THE AC ADAPTER — Check the AC adapter cable connections. If the AC adapter has a light, ensure that the light is on.

CONNECT THE COMPUTER DIRECTLY TO AN ELECTRICAL OUTLET — Bypass power protection devices, power strips, and the extension cable to verify that the computer turns on.

ADJUST THE POWER PROPERTIES — Search for the keyword *standby* in Windows *Help* or the Windows Help and Support Center.

SWITCH THE VIDEO IMAGE — If your computer is attached to an external monitor, press   to switch the video image to the display.

 **NOTE:** If you are using a program that requires a higher resolution than your computer supports, it is recommended that you attach an external monitor to your computer.

If the display is difficult to read

ADJUST THE BRIGHTNESS — See "[Adjusting Brightness](#)" for instructions on adjusting the brightness.

MOVE THE SUBWOOFER AWAY FROM THE COMPUTER OR MONITOR — If your external speaker system includes a subwoofer, ensure that the subwoofer is at least 60 cm (2 ft) away from the computer or external monitor.

ELIMINATE POSSIBLE INTERFERENCE — Turn off nearby fans, fluorescent lights, halogen lamps, or other appliances.

ROTATE THE COMPUTER TO FACE A DIFFERENT DIRECTION — Eliminate sunlight glare, which can cause poor picture quality.

ADJUST THE WINDOWS DISPLAY SETTINGS —

Windows XP

- 1 Click the **Start** button and then click **Control Panel**.
- 2 Click **Appearance and Themes**.
- 3 Click the area you want to change or click the **Display** icon.
- 4 Try different settings for **Color quality** and **Screen resolution**.

Windows 2000

- 1 Click the **Start** button, point to **Settings**, and then click **Control Panel**.
- 2 Double-click the **Display** icon and click the **Settings** tab.
- 3 Try different settings for **Colors**, **Screen area**, and **Advanced Settings**.

RUN THE VIDEO DIAGNOSTICS TESTS — If no error message appears and you still have a display problem, but the display is not completely blank, run the **Video** device group in the [Dell Diagnostics](#). Then [contact Dell](#).

SEE "ERROR MESSAGES" — If an error message appears, see "[Error Messages](#)."

If only part of the display is readable

CONNECT AN EXTERNAL MONITOR —

- 1 Shut down your computer and connect an external monitor to the computer.
- 2 Turn on the computer and the monitor and adjust the monitor brightness and contrast controls.

If the external monitor works, the computer display or video controller may be defective. [Contact Dell](#).

Sound and Speaker Problems

Fill out the [Diagnostics Checklist](#) as you complete these checks.

If you have a problem with **the integrated speaker**

ADJUST THE WINDOWS VOLUME CONTROL — Double-click the speaker icon in the lower-right corner of your screen. Ensure that the volume is turned up and that the sound is not muted. Adjust the volume, bass, or treble controls to eliminate distortion.

ADJUST THE VOLUME USING KEYBOARD SHORTCUTS — See "[Using the Keyboard and Touch Pad](#)." Press   to disable (mute) or reenable the **integrated speaker**.

REINSTALL THE SOUND (AUDIO) DRIVER — See "[Reinstalling Drivers and Utilities](#)."

FOR WINDOWS 2000 ONLY, ENSURE THAT DIGITAL AUDIO FOR THE CD DRIVE IS ENABLED —

- 1 Click the **Start** button, point to **Settings**, and then click **Control Panel**.
- 2 Double-click the **System** icon.
- 3 Click the **Hardware** tab.
- 4 Click **Device Manager**.
- 5 Double-click **DVD/CD-ROM drives**.
- 6 Double-click the name of the drive.
- 7 On the drive **Properties** screen, click the **Properties** tab.
- 8 Click the box near the bottom of the screen to enable digital audio for your CD or DVD drive.



NOTE: The volume control in some MP3 players overrides the Windows volume setting. If you have been listening to MP3 songs, make sure that you did not turn the player volume down or off.

If you have a problem with external speakers

CHECK THE SPEAKER CABLE CONNECTIONS — See the setup diagram supplied with the speakers.

TEST THE ELECTRICAL OUTLET — Ensure that the electrical outlet is working by testing it with another device, such as a lamp.

ENSURE THAT THE SPEAKERS ARE TURNED ON — See the setup diagram supplied with the speakers.

ADJUST THE WINDOWS VOLUME CONTROL — Double-click the speaker icon in the lower-right corner of your screen. Ensure that the volume is turned up and that the sound is not muted. Adjust the volume, bass, or treble controls to eliminate distortion.

TEST THE SPEAKERS — Plug the speaker audio cable into the  connector on the computer. Ensure that the headphone volume control is turned up. Play a music CD.

RUN THE SPEAKER SELF-TEST — Some speaker systems have a self-test button on the subwoofer. See the speaker documentation for self-test instructions.

ELIMINATE POSSIBLE INTERFERENCE — Turn off nearby fans, fluorescent lights, or halogen lamps to check for interference.

REINSTALL THE SOUND (AUDIO) DRIVER — See "[Reinstalling Drivers and Utilities](#)."

RUN THE MISC. PCI DEVICES DIAGNOSTIC TEST — See "[Using the Dell Diagnostics](#)." If the tests complete successfully, the controller is functioning properly.

If the problem persists, or if the tests do not complete successfully, [contact Dell](#).

FOR WINDOWS 2000 ONLY, ENSURE THAT DIGITAL AUDIO FOR THE CD DRIVE IS ENABLED —

- 1 Click the **Start** button, point to **Settings**, and then click **Control Panel**.
- 2 Double-click the **System** icon.
- 3 Click the **Hardware** tab.
- 4 Click **Device Manager**:
- 5 Double-click **DVD/CD-ROM drives**.
- 6 Double-click the name of the drive.
- 7 On the drive **Properties** screen, click the **Properties** tab.
- 8 Click the box near the bottom of the screen to enable digital audio for your CD or DVD drive.

Printer Problems

Fill out the [Diagnostics Checklist](#) as you perform the various checks.

CHECK THE PRINTER CABLE CONNECTIONS — Ensure that the printer cable is properly connected to the computer.

CHECK THE PRINTER CABLE —

- 1 Shut down the computer and turn off the printer.
- 2 Swap the printer cable with a cable that you know is working.
- 3 Turn on the printer and computer, and try again to print.
- 4 If you print successfully, [contact Dell](#) for assistance in obtaining a new printer cable.

TEST THE ELECTRICAL OUTLET — Ensure that the electrical outlet is working by testing it with another device, such as a lamp.

ENSURE THAT THE PRINTER IS TURNED ON — See the documentation supplied with the printer.

VERIFY THAT WINDOWS RECOGNIZES THE PRINTER —

Windows XP

- 1 Click the **Start** button and click **Control Panel**.
- 2 Click **Printers and Other Hardware**.
- 3 Click **View installed printers or fax printers**. If the printer model is listed, right-click the printer icon.
- 4 Click **Properties** and click the **Ports** tab. Ensure that the **Print to the following port(s):** setting is **LPT1 (Printer Port)**.



Windows 2000

- 1 Click the **Start** button, point to **Settings**, and then click **Printers**.
If the printer model is listed, right-click the printer icon.
- 2 Click **Properties** and click the **Ports** tab.
- 3 Ensure that the **Print to the following port:** option is set to **USB**.

REINSTALL THE PRINTER DRIVER — See "[Reinstalling Drivers and Utilities](#)."

CHECK THE PRINTER — Run the printer self-test. If the test does not complete successfully, the printer is probably defective. Contact the printer manufacturer.

Modem and Internet Connection Problems

-  **NOTICE:** Connect the modem to an analog telephone wall jack only. Connecting the modem to a digital telephone network may damage the modem.
-  **NOTICE:** Modem and network connectors look similar. Do not plug a telephone line into the network connector.

Fill out the [Diagnostics Checklist](#) as you complete these checks.

CHECK THE TELEPHONE WALL JACK — Disconnect the telephone line from the modem and connect it to a telephone. Listen for a dial tone. Ensure that you have touchtone telephone service. Try connecting the modem to a different telephone wall jack.

Slow connection speeds can be caused by telephone noise as well as by telephone line or network conditions. Contact your telephone company or network administrator for more information.

CONNECT THE MODEM DIRECTLY TO THE TELEPHONE WALL JACK —

If you have other telephone devices sharing the line, such as an answering machine, fax machine, surge protector, or line splitter, then bypass them and use the telephone line to connect the modem directly to the telephone wall jack.

CHECK THE CONNECTION — Verify that the telephone line is connected to the modem.

CHECK THE TELEPHONE LINE — Try using a different telephone line. If you are using a line that is 3 m (10 ft) or more in length, try a shorter one.

IRREGULAR DIAL TONE — If you have voice mail service, you might hear an irregular dial tone when you have messages. Contact your telephone company for instructions on restoring a dial tone.

 **NOTE:** If you can connect to your Internet service provider (ISP), your modem is functioning properly. If you are sure that your modem is working properly and you still experience problems, contact your ISP.

TURN OFF CALL WAITING (CATCH-PHONE) — See your telephone directory for instructions on deactivating this feature. Then adjust the dial-up networking connection properties.

Windows XP

- 1 Click the **Start** button and click **Control Panel**.
- 2 Click **Printers and Other Hardware**, click **Phone and Modem Options**, click the **Dialing Rules** tab, and then click **Edit...**
- 3 In the **Edit Location** window, ensure that **To disable call waiting, dial:** is checked, and then select the proper code as listed in your telephone directory.
- 4 Click **Apply** and click **OK**.
- 5 Close the **Phone and Modems Options** window.
- 6 Close the **Control Panel** window.

Windows 2000

- 1 Click the **Start** button, point to **Settings**, and then click **Control Panel**.
- 2 Click **Phone and Modem Options**.
- 3 Click the **Dialing Rules** tab and click **Edit**.
- 4 Ensure that **To disable call waiting, dial:** is checked, and then select the proper code as listed in your telephone directory.
- 5 Click **Apply** and click **OK**.
- 6 Close the **Phone and Modem Options** window.

VERIFY THAT THE MODEM IS COMMUNICATING WITH WINDOWS —

Windows XP

- 1 Click the **Start** button and click **Control Panel**.
- 2 Click **Printers and Other Hardware** and click **Phone and Modem Options**.
- 3 Click the **Modems** tab.
- 4 Click the COM port for your modem.
- 5 Click **Properties**, click the **Diagnostics** tab, and then click **Query Modem** to verify that the modem is communicating with Windows.

If all commands receive responses, the modem is operating properly.

Windows 2000

- 1 Click the **Start** button, point to **Settings**, and then click **Control Panel**.
- 2 Double-click **Phone and Modem Options**.
If multiple entries for the same modem or modems are listed but not installed, delete the entries, restart the computer, and repeat steps 1 and 2.
- 3 Click the **Diagnostics** tab.
- 4 Click the COM port for your modem.
- 5 Click **Query Modem** to verify that the modem is communicating with Windows.

If all commands receive responses, the modem is operating properly.

Touch Pad or Mouse Problems

Fill out the [Diagnostics Checklist](#) as you perform the various checks.

CHECK THE TOUCH PAD SETTINGS —

Windows XP

- 1 Click the **Start** button, click **Control Panel**, and then click **Printers and Other Hardware**.
- 2 Click **Mouse**.
- 3 Try adjusting the settings.

Windows 2000

- 1 Click the **Start** button, point to **Settings**, and then click **Control Panel**.
- 2 Double-click the **Mouse** icon.
- 3 Try adjusting the settings.

CHECK THE MOUSE CABLE — Shut down the computer. Disconnect the mouse cable, check it for damage, and firmly reconnect the cable.

If you are using a mouse extension cable, disconnect it and connect the mouse directly to the computer.

TO VERIFY THAT THE PROBLEM IS WITH THE MOUSE, CHECK THE TOUCH PAD —

- 1 Shut down the computer.
- 2 Disconnect the mouse.
- 3 Turn on the computer.
- 4 At the Windows desktop, use the touch pad to move the cursor around, select an icon, and open it.

If the touch pad operates correctly, the mouse may be defective.

CHECK THE SYSTEM SETUP PROGRAM SETTINGS — Verify that the system setup program lists the correct device for the pointing device option. (The computer automatically recognizes a USB mouse without making any setting adjustments.)

TEST THE MOUSE CONTROLLER — To test the mouse controller (which affects pointer movement) and the operation of the touch pad or mouse buttons, run the Mouse test in the **Pointing Devices** test group in the [Dell Diagnostics](#).

REINSTALL THE TOUCH PAD DRIVER — See "[Reinstalling Drivers and Utilities](#)."

External Keyboard Problems

Fill out the [Diagnostics Checklist](#) as you perform the various checks.

CHECK THE KEYBOARD CABLE — Shut down the computer. Disconnect the keyboard cable and check it for damage, and firmly reconnect the cable.

If you are using a keyboard extension cable, disconnect it and connect the keyboard directly to the computer.

CHECK THE EXTERNAL KEYBOARD —

- 1 Shut down the computer, wait 1 minute, and turn it on again.
- 2 Verify that the numbers, capitals, and scroll lock lights on the keyboard blink during the boot routine.
- 3 From the Windows desktop, click the **Start** button, point to **Programs**, point to **Accessories**, and click **Notepad**.
- 4 Type some characters on the external keyboard and verify that they appear on the display.

If you cannot verify these steps, you may have a defective external keyboard.

TO VERIFY THAT THE PROBLEM IS WITH THE EXTERNAL KEYBOARD, CHECK THE INTEGRATED KEYBOARD —

- 1 Shut down the computer.
- 2 Disconnect the external keyboard.
- 3 Turn on the computer.
- 4 From the Windows desktop, click the **Start** button, point to **Programs**, point to **Accessories**, and click **Notepad**.
- 5 Type some characters on the external keyboard and verify that they appear on the display.

If the characters appear now but did not with the external keyboard, you may have a defective external keyboard.

RUN THE KEYBOARD DIAGNOSTICS TESTS — Run the PC-AT Compatible Keyboards tests in the [Dell Diagnostics](#). If the tests indicate a defective external keyboard, [contact Dell](#).



NOTE: Use the integrated keyboard when working in MS-DOS[®] mode or when running the [Dell Diagnostics](#) or the [system setup program](#). When you attach an external keyboard, the integrated keyboard remains fully functional.

Unexpected Characters

DISABLE THE NUMERIC KEYPAD — Press to disable the numeric keypad if numbers are displayed instead of letters. Verify that the numbers lock light is not lit.

Drive Problems

Fill out the [Diagnostics Checklist](#) as you complete these checks.

If you cannot save a file to a floppy drive

ENSURE THAT AN EXTERNAL FLOPPY DRIVE IS CONNECTED TO THE COMPUTER — [Install the floppy drive in the Dell D/Bay](#) or use the optional USB cable to connect the floppy drive to the computer.

ENSURE THAT WINDOWS RECOGNIZES THE DRIVE — *In Windows XP*, click the **Start** button and click **My Computer**. *In other operating systems*, double-click **My Computer**. If the drive is not listed, perform a full scan with your antivirus software to check for and remove viruses. Viruses can sometimes prevent Windows from recognizing the drive. Insert a bootable disk and restart the computer.

ENSURE THAT THE DISK IS NOT WRITE-PROTECTED — You cannot save data to a write-protected disk.

TRY ANOTHER FLOPPY DISK — Insert another disk to eliminate the possibility that the original disk is defective.

REINSTALL THE DRIVE —

- 1 Save and close any open files, exit any open programs, and shut down the computer.
- 2 Remove the drive from the [Dell D/Bay](#).
- 3 Reinstall the drive.
- 4 Turn on the computer.

CHECK THE D/BAY CABLE — Shut down the computer. Disconnect the D/Bay cable from the computer, and firmly reconnect the cable.

CLEAN THE DRIVE — See "[Cleaning Your Computer](#)" for instructions.

CHECK THE DRIVE FOR ERRORS —

- If a drive error message appears, see "[Error Messages](#)" for an explanation.
- Run the Diskette tests as described in "[Using the Dell Diagnostics](#)."

If you cannot play a CD, CD-RW, DVD, or DVD+RW

High-speed CD drive vibration is normal and may cause noise. The noise does not indicate a defect with the drive or the CD.



NOTE: Because of different worldwide file types, not all DVD titles work in all DVD drives.

ENSURE THAT WINDOWS RECOGNIZES THE DRIVE — *In Windows XP*, click the **Start** button and click **My Computer**. *In other operating systems*, double-click **My Computer**. If the drive is not listed, perform a full scan with your antivirus software to check for and remove viruses. Viruses can sometimes prevent Windows from recognizing the drive. Insert a bootable disk and restart the computer.

TRY ANOTHER DISC — Insert another disc to eliminate the possibility that the original disc is defective.

ADJUST THE WINDOWS VOLUME CONTROL — Double-click the speaker icon in the lower-right corner of your screen. Ensure that the volume is turned up and that the sound is not muted.

REINSTALL THE DRIVE

- 1 Save and close any open files, exit any open programs, and shut down the computer.
- 2 Remove the drive. See "[Using the Dell™ D/Bay](#)" for instructions.
- 3 Reinstall the drive.
- 4 Turn on the computer.

CLEAN THE DRIVE OR DISC — See "[Cleaning Your Computer](#)" for instructions.

CHECK THE DRIVE FOR ERRORS

If a drive error message appears, see "[Error Messages](#)" for an explanation.

Run the IDE Drives tests as described in the [Dell Diagnostics](#).

If you cannot eject the CD, CD-RW, DVD, or DVD+RW drive tray

- 1 Ensure that the computer is shut down.
- 2 Straighten a paper clip and insert one end into the eject hole at the front of the drive; push firmly until the tray is partially ejected.
- 3 Gently pull out the tray until it stops.

If you hear an unfamiliar scraping or grinding sound

- Ensure that the sound is not caused by the program that is running.
- Ensure that the disk or disc is inserted properly.

If the CD-RW or DVD+RW drive stops writing

DISABLE STANDBY OR HIBERNATE MODE IN WINDOWS BEFORE WRITING TO A CD-RW — Search for the keyword *standby* or *hibernate* in Windows *Help* or the Windows Help and Support Center.

CHANGE THE WRITE SPEED TO A SLOWER RATE — See the help files for your CD or DVD creation software.

EXIT ALL OTHER OPEN PROGRAMS — Exiting all other open programs before writing to the CD-RW or DVD+RW may alleviate the problem.

If you have problems with a hard drive

ALLOW THE COMPUTER TO COOL BEFORE TURNING IT ON — A warm hard drive may prevent the operating system from starting. Try allowing the computer to return to room temperature before turning it on.

CHECK THE DRIVE FOR ERRORS —

- Run the Windows error-checking tool:
 - 1 *In Windows XP*, click the **Start** button and click **My Computer**. *In Windows 2000*, double-click **My Computer**.
 - 2 Right-click the drive letter (local disk) that you want to scan for errors, and then click **Properties**.
 - 3 Click the **Tools** tab.
 - 4 Under **Error-checking**, click **Check Now**.
 - 5 Click **Start**.
- Run the IDE Drives tests as described in the [Dell Diagnostics](#).

PC Card Problems

CHECK THE PC CARD — Ensure that the PC Card is properly inserted into the connector.

ENSURE THAT THE CARD IS RECOGNIZED BY WINDOWS — Double-click the **Unplug or Eject Hardware** icon in the Windows taskbar. Ensure that the card is listed.

RUN THE PC CARD DIAGNOSTICS TEST — See the documentation that came with the PC Card for instructions if a diagnostics test was provided with the card.

IF YOU HAVE PROBLEMS WITH A DELL-PROVIDED PC CARD — [Contact Dell](#).

IF YOU HAVE PROBLEMS WITH A PC CARD NOT PROVIDED BY DELL — Contact the PC Card manufacturer.

Smart Card Problems

CHECK THE SMART CARD — Ensure that the smart card is properly inserted into the smart card slot.

ENSURE THAT THE SMART CARD IS RECOGNIZED BY WINDOWS — Double-click the **Unplug or Eject Hardware** icon in the Windows taskbar. Ensure that the smart card is listed.

IF YOU HAVE PROBLEMS WITH A DELL-PROVIDED SMART CARD — [Contact Dell](#).

IF YOU HAVE PROBLEMS WITH A SMART CARD NOT PROVIDED BY DELL — Contact the smart card manufacturer.

Network Problems

Fill out the [Diagnostics Checklist](#) as you complete these checks.

CHECK THE NETWORK CABLE CONNECTOR — Ensure that the network cable connector is firmly connected to the connector on the computer and the network wall jack.

CHECK THE NETWORK LIGHTS ON THE NETWORK CONNECTOR — Green indicates that the network connection is active. If the status light is not green, try replacing the network cable. Amber indicates that the network adapter driver is loaded and the adapter is detecting activity.

RESTART THE COMPUTER — Try to log on to the network again.

CONTACT YOUR NETWORK ADMINISTRATOR — Verify that your network settings are correct and that the network is functioning.

General Program Problems

Fill out the [Diagnostics Checklist](#) as you complete these checks.



A program crashes

SEE THE SOFTWARE DOCUMENTATION — Many software manufacturers maintain websites with information that may help you solve the problem. Ensure that you properly installed and configured the program. Reinstall the program if necessary.

 **NOTE:** Software usually includes installation instructions in its documentation or on a floppy disk or CD.

A program stops responding

END THE PROGRAM

- 1 Simultaneously press   .
- 2 Click the **Applications** tab, and then select the program that is no longer responding.
- 3 Click **End Task**.

A solid blue screen appears

TURN THE COMPUTER OFF — If the computer does not respond to a keystroke or a proper shutdown, press the power button until the computer turns off. Press the power button again to restart the computer.

Windows XP

The computer restarts.

Windows 2000

The solid blue screen appears because you were not able to perform a proper Windows shutdown. ScanDisk automatically runs during the start-up process. Follow the instructions on the screen.

Error messages appear

REVIEW "Error Messages" — Look up the message and take the appropriate action. See the software documentation.

CONFIRM THAT THE PROBLEM IS SOFTWARE-RELATED — Run the System Board Devices tests in the [Dell Diagnostics](#). If all tests in the device group run successfully, the problem may be software-related. See the software documentation.

If Your Dell™ Computer Gets Wet



CAUTION: Perform this procedure only after you are certain that it is safe to do so. If the computer is connected to an electrical outlet, Dell recommends that you turn off AC power at the circuit breaker before attempting to remove the power cables from the electrical outlet. Use the utmost caution when removing wet cables from a live power source.

- 1 Shut down the computer, disconnect the AC adapter from the computer, and then disconnect the AC adapter from the electrical outlet.
- 2 Turn off any attached external devices, and disconnect them from their power sources and then from the computer.
- 3 Ground yourself by touching one of the metal connectors on the back of the computer.
- 4 Remove any installed PC Cards and put them in a safe place to dry.
- 5 Remove the battery.
- 6 Wipe off the battery and put it in a safe place to dry.
- 7 [Remove the hard drive.](#)
- 8 [Remove the memory modules.](#)
- 9 Open the display and place the computer right-side up across two books or similar props to let air circulate all around it. Let the computer dry for at least 24 hours in a dry area at room temperature.



NOTICE: Do not use artificial means, such as a hair dryer or a fan, to speed the drying process.

DELL CONFIDENTIAL – PRELIMINARY 1/29/03 – FOR PROOF ONLY



CAUTION: To help prevent electrical shock, verify that the computer is thoroughly dry before continuing with the rest of this procedure.

- 10 Ground yourself by touching one of the metal connectors on the back of the computer.
- 11 Replace the memory modules, the memory module cover, and the screws.
- 12 Replace the hard drive.
- 13 Connect the external module bay, and replace any PC Cards you removed.
- 14 Replace the battery.
- 15 Turn on the computer and verify that it is working properly.

If the computer does not start, or if you cannot identify the damaged components, [contact Dell](#).



NOTE: See your *System Information Guide* for information on your warranty coverage.

If You Drop or Damage Your Computer

- 1 Save and close any open files, exit any open programs, and shut down the computer.
- 2 Disconnect the AC adapter from the computer and from the electrical outlet.
- 3 Turn off any attached external devices, and disconnect them from their power sources and then from the computer.
- 4 Remove and reinstall the battery.
- 5 Turn on the computer.

If the computer does not start, or if you cannot identify the damaged components, [contact Dell](#).



NOTE: See your *System Information Guide* for information on your warranty coverage.

Resolving Other Technical Problems

GO TO THE DELL SUPPORT WEBSITE — Go to **support.dell.com** for help with general usage, installation, and troubleshooting questions. See "[Getting Help](#)" for a description of the hardware and software support provided by Dell.

E-MAIL DELL — Go to **support.dell.com** and then click **E-Mail Dell** in the **Communicate** list. Send an e-mail message to Dell about your problem; you can expect to receive an e-mail message from Dell within hours. See "[Getting Help](#)" for a description of the hardware and software support provided by Dell.

CONTACT DELL — If you cannot solve your problem using the Dell Support website (**support.dell.com**) or e-mail service, call Dell for technical assistance. See "[Getting Help](#)" for a description of the hardware and software support provided by Dell.

SECTION 15

Using the Dell Diagnostics

FILE LOCATION: S:\SYSTEMS\Pebble\UG\A00\English\diag.fm

DELL CONFIDENTIAL - PRELIMINARY 1/29/03 - FOR PROOF ONLY

When to Use the Dell Diagnostics

Whenever a major component or device in your computer does not function properly, you may have a component failure. If you are experiencing a problem with your Dell™ computer, perform the checks in "Solving Problems" and run the Dell Diagnostics *before* you call Dell for technical assistance. Running the Dell Diagnostics may help you to resolve the problem yourself quickly without having to contact Dell for assistance.

If you are experienced with computers and know what component(s) you need to test, select the appropriate diagnostic test group(s) or subtest(s). If you are unsure about how to begin diagnosing a problem, see "[Starting the Dell Diagnostics](#)."

Features of the Dell Diagnostics

The Dell Diagnostics helps you to check your computer hardware without any additional equipment and without destroying any data. By using the diagnostics, you can have confidence in the operation of your computer. If you find a problem that you cannot solve by yourself, the diagnostic tests can provide you with important information you need when talking to Dell's service and support personnel.



NOTICE: Use the Dell Diagnostics to test only your Dell computer. Using this program with other computers may cause incorrect computer responses or result in error messages.

The diagnostic test groups or subtests also have the following features:

- Options that let you perform express, extended, or custom tests on one or all devices
- An option that allows you to select tests based on a symptom of the problem you are having
- An option that allows you to choose the number of times a test group or subtest is repeated
- The ability to display test results
- Options to temporarily suspend testing if an error is detected, or to terminate testing
- Extensive online Help that describes the tests and devices

DELL CONFIDENTIAL – PRELIMINARY 1/29/03 – FOR PROOF ONLY

- Status messages that inform you whether test groups or subtests were completed successfully
- Error messages that appear if any problems are detected

Starting the Dell Diagnostics

The Dell Diagnostics is located on a hidden Diagnostic utility partition on your hard drive.

- 1 Shut down the computer.
- 2 If the computer is connected to a docking device (docked), undock it. See the documentation that came with your docking device for instructions.
- 3 Connect the computer to an electrical outlet.
- 4 Turn on the computer. When the DELL™ logo appears, press immediately. If you wait too long and the Microsoft® Windows® logo appears, continue to wait until you see the Windows desktop. Then shut down your computer and try again.
- 5 When the boot device list appears, highlight **Diagnostics** and press .

The computer begins to run the Pre-boot System Assessment, a series of embedded diagnostics that perform initial testing on your system board, keyboard, hard drive, and display.

- During the assessment, answer any questions that appear.
- If a component failure is detected, the computer stops and beeps. To stop the assessment and reboot to the operating system, press ; to continue to the next test, press ; to retest the component that failed, press .
- If failures are detected during the Pre-boot System Assessment, write down the error code(s) and [contact Dell](#) before continuing on to the Dell Diagnostics.
- If you receive a message stating that no Diagnostics utility partition has been found, follow the instructions on the screen to run the Dell Diagnostics from your *Drivers and Utilities* CD.

 **NOTE:** If your computer cannot display a screen image, [contact Dell](#).

 **NOTE:** If you cannot see anything on your display, you can hold down the mute button and press the power button (instead of) to begin the Dell Diagnostics. You do not need to highlight **Diagnostics** and press . The computer automatically runs the Pre-boot System Assessment.

If the Pre-boot System Assessment completes successfully, you receive the message `Booting Dell Diagnostic Utility Partition`. Press any key to continue.

- 6 Press any key to start the Dell Diagnostics from the Diagnostics utility partition on your hard drive.
- 7 After the Dell Diagnostics loads and the **Main Menu** screen appears, click the button for the option you want.

 **NOTE:** The Service Tag for your computer is located in the title bar of each screen.

Option	Function
Express Test	Performs a quick test of devices. The test typically takes 10 to 20 minutes and requires no interaction on your part. Run Express Test first to increase the possibility of tracing the problem quickly.
Extended Test	Performs a thorough check of devices. The test typically takes 1 hour or more and requires you to answer questions periodically.
Custom Test	Tests a specific device. You can customize the tests to be run.
Symptom Tree	Allows you to select tests based on a symptom of the problem you are experiencing. The option lists the most common symptoms.

- 8 If a problem is encountered during a test, a message appears, displaying the error code and a description of the problem. Write down the error code and problem description and follow the instructions on the screen. If you cannot resolve the error condition, [contact Dell](#).
- 9 If you run a test from the **Custom Test** or **Symptom Tree** option, click the applicable tab described in the following table for more information.

Tab	Function
Results	Displays the results of the test and any error conditions encountered.

Errors	Displays error conditions encountered, error codes, and problem description.
Help	Describes the test and may indicate requirements for running the test.
Configuration	Displays your hardware configuration for the selected device. The Dell Diagnostics obtains your configuration information for all devices from the system setup program , memory, and various internal tests and displays the information in the device list in the left pane of the screen. The device list may not display the names of all the components installed on your computer or all devices attached to your computer.
Parameters	Allows you to customize the test by changing the test settings.

- 10 When you have finished running a test, close the screen to return to the **Main Menu** screen. To exit the Dell Diagnostics and reboot the computer, close the **Main Menu** screen.

FILE LOCATION: S:\SYSTEMS\Pebble\UG\A00\English\diag.fm

DELL CONFIDENTIAL – PRELIMINARY 1/29/03 – FOR PROOF ONLY

SECTION 16

Cleaning Your Computer

FILE LOCATION: S:\SYSTEMS\Pebble\UG\A00\English\cleaning.fm

DELL CONFIDENTIAL – PRELIMINARY 1/29/03 – FOR PROOF ONLY

- 1 Shut down the computer through the **Start** menu.
- 2 Ensure that your computer and attached devices are turned off. If your computer and attached devices did not automatically turn off when you shut down your computer, turn them off now.
- 3 **Remove the battery.**

Computer, Keyboard, and Display

- Gently use a vacuum cleaner with a brush attachment to remove dust from the slots and holes on your computer and between the keys on the keyboard.
- ➡ **NOTICE:** To avoid damaging the computer or display, do not spray cleaning solution directly onto the display. Only use products specifically designed for cleaning LCDs, and follow the instructions that are included with the product.
- Moisten a soft, lint-free cloth with water or an LCD cleaner, and wipe the display until it is clean.
- Moisten a soft, lint-free cloth with water or an LCD cleaner, and wipe the computer and keyboard. Do not allow water from the cloth to seep between the touch pad and the surrounding palm rest.

Touch Pad

- 1 Shut down and turn off your computer, disconnect any attached devices, and disconnect them from their electrical outlets.
- 2 **Remove the battery.**
- 3 Moisten a soft, lint-free cloth with water, and stroke it gently across the surface of the touch pad. Do not allow water from the cloth to seep between the touch pad and the surrounding palm rest.

Floppy Drive

- ➡ **NOTICE:** Do not attempt to clean drive heads with a swab. You might accidentally misalign the heads, which prevents the drive from operating.

Clean your floppy drive using a commercially available cleaning kit. These kits contain pretreated floppy disks to remove contaminants that accumulate during normal operation.

Optical Media

- ➔ **NOTICE:** Always use compressed air to clean the lens in the drive, and follow the instructions that are included with the compressed air. Never touch the lens in the drive.

If you notice problems, such as skipping, with the playback quality of your CDs or DVDs, try cleaning the discs.

- 1 Hold the disc by its outer edge. You can also touch the inside edge of the center hole.

- ➔ **NOTICE:** To prevent damaging the surface, do not wipe in a circular motion around the disc.

- 2 With a soft, lint-free cloth, gently wipe the bottom of the disc (the unlabeled side) in a straight line from the center to the outer edge of the disc.



You can also purchase commercial products that clean discs and provide some protection from dust, fingerprints, and scratches. Cleaning products for CDs are safe to use on DVDs.

- 3 Connect your computer and devices to electrical outlets, and turn them on.

FILE LOCATION: S:\SYSTEMS\Pebble\UG\A00\English\cleaning.fm

DELL CONFIDENTIAL – PRELIMINARY 1/29/03 – FOR PROOF ONLY

SECTION 17

Reinstalling Software

FILE LOCATION: S:\SYSTEMS\Pebble\UG\A00\English\drivers.fm

DELL CONFIDENTIAL – PRELIMINARY 1/29/03 – FOR PROOF ONLY

Reinstalling Drivers and Utilities

Dell ships your computer to you with required drivers and utilities already installed—no further installation or configuration is needed.

 **NOTICE:** The *Drivers and Utilities* CD may contain drivers for operating systems that are not on your computer. Ensure that you are installing software appropriate for your operating system.

To reinstall drivers for optional devices such as wireless communications and DVD drives, you may need the CD and documentation that came with those devices.

 **NOTICE:** The Dell Support website, support.dell.com, and the *Drivers and Utilities* CD provide approved drivers for Dell™ computers. If you install drivers from other sources, your computer might not work correctly.

To reinstall a driver or utility from your *Drivers and Utilities* CD:

- 1 Save and close any open files, and exit any open programs.
- 2 Insert the *Drivers and Utilities* CD.

In most cases, the CD starts running automatically. If it does not, start Microsoft® Windows® Explorer, click your CD drive directory to display the CD contents, and then double-click the **autorcd.exe** file. The first time that you run the CD, it might prompt you to install setup files. Click **OK**, and follow the instructions on the screen to continue.

- 3 From the **Language** drop-down menu in the toolbar, select your preferred language for the driver or utility (if available).

A welcome screen appears.

- 4 Click **Next**. The CD automatically scans your hardware to detect drivers and utilities used by your computer.

After the CD completes the hardware scan, you can also detect other drivers and utilities. Under **Search Criteria**, select the appropriate categories from the **System Model**, **Operating System**, and **Topic** drop-down menus.

A link or links appear(s) for the specific drivers and utilities used by your computer.

- 5 Click the link of a specific driver or utility to display information about the driver or utility that you want to install.

DELL CONFIDENTIAL – PRELIMINARY 1/29/03 – FOR PROOF ONLY

- 6 Click the **Install** button (if present) to begin installing the driver or utility. At the welcome screen, follow the screen prompts to complete the installation.

If no **Install** button is present, automatic installation is not an option. For installation instructions, either see the appropriate instructions in the following subsections, or click **Extract**, follow the extracting instructions, and read the readme file.

If instructed to navigate to the driver files, click the CD directory on the driver information window to display the files associated with that driver.

Manually Reinstalling Drivers for Windows XP

- 1 After extracting the driver files to your hard drive as described previously, click the **Start** button, point to **Settings**, and then click **Control Panel**.
- 2 Click the **Start** button and right-click **My Computer**.
- 3 Click **Properties**.
- 4 Click the **Hardware** tab and click **Device Manager**.
- 5 Double-click the type of device for which you are installing the driver (for example, **Modems** or **Infrared devices**).
- 6 Double-click the name of the device for which you are installing the driver.
- 7 Click the **Driver** tab and click **Update Driver**.
- 8 Select **Install from a list or specific location (Advanced)** and click **Next**.
- 9 Click **Browse**, and browse to the location to which you previously extracted the driver files.
- 10 When the name of the appropriate driver appears, click **Next**.
- 11 Click **Finish** and restart your computer.



NOTE: If you are reinstalling an infrared-sensor driver, you must first enable the infrared sensor in the system setup program before continuing with the driver installation.

Using the Windows XP Device Driver Rollback

If you install a new device driver that causes system instability, you can use the Windows XP Device Driver Rollback to replace the new device driver with the previously installed version of the device driver. If you cannot reinstall your previous driver by using the Device Driver Rollback process, then use [System Restore](#) to return your operating system to its previous operating state before you installed the new device driver. To use Device Driver Rollback:

- 1 Click the **Start** button and right-click **My Computer**.
- 2 Click **Properties**.
- 3 Click the **Hardware** tab and click **Device Manager**.
- 4 In the **Device Manager** window, right-click the device for which the new driver was installed and then click **Properties**.
- 5 Click the **Drivers** tab.
- 6 Click **Roll Back Driver**.

Manually Reinstalling Drivers for Windows 2000



NOTE: If you are reinstalling an infrared driver, you must first enable the infrared sensor in the system setup program before continuing with the driver installation.

- 1 After extracting the driver files to your hard drive as described previously, click the **Start** button, point to **Settings**, and then click **Control Panel**.
- 2 Double-click the **System** icon.
- 3 Click the **Hardware** tab.
- 4 Click **Device Manager**.
- 5 Double-click the type of device for which you are installing the driver (for example, **Modems** or **Infrared devices**).
- 6 Double-click the name of the device.
- 7 Click the **Driver** tab and click **Update Driver**.
- 8 Click **Next**.
- 9 Ensure that **Search for a suitable driver for my device (recommended)** is selected, and then click **Next**.
- 10 Ensure that the **Specify a location** check box is checked and that all other check boxes are unchecked, and click **Next**.

- 11 Click **Browse** to browse to the location to which you previously extracted the driver files.
- 12 When the name of the appropriate driver appears, click **Next**.
- 13 Click **Finish** and restart your computer.

Resolving Software and Hardware Incompatibilities

In the Microsoft® Windows® XP and Windows 2000 operating systems, IRQ conflicts occur if a device either is not detected during the operating system setup or is detected but incorrectly configured. See the following subsection that corresponds to your operating system to check for IRQ conflicts on your computer.

Windows XP

- 1 Click the **Start** button and click **Control Panel**.
- 2 Click **Performance and Maintenance** and click **System**.
- 3 Click the **Hardware** tab and click **Device Manager**.
- 4 In the **Device Manager** list, check for conflicts with the other devices.
Conflicts are indicated by a yellow exclamation point (!) beside the conflicting device or a red X if the device has been disabled.
- 5 Double-click any conflicting device listed to bring up the **Properties** window so that you can determine what needs to be reconfigured or removed from the Device Manager.
- 6 Resolve these conflicts before checking specific devices.
- 7 Double-click the malfunctioning device type in the **Device Manager** list.
- 8 Double-click the icon for the specific device in the expanded list.
The **Properties** window appears.
If an IRQ conflict exists, the **Device status** area in the **Properties** window reports what other devices are sharing the device's IRQ.
- 9 Resolve any IRQ conflicts.

You can also use the Windows XP Hardware Troubleshooter. To use the troubleshooter, click the **Start** button and click **Help and Support**. Type `hardware troubleshooter` in the **Search** field, and then click the arrow to start the search. Click **Hardware Troubleshooter** in the **Search Results** list. In the **Hardware Troubleshooter** list, click **I need to resolve a hardware conflict on my computer** and click **Next**.

Windows 2000

- 1 Click the **Start** button, point to **Settings**, and then click **Control Panel**.
- 2 Double-click the **System** icon.
- 3 Click the **Hardware** tab.
- 4 Click **Device Manager**
- 5 Click **View** and click **Resources by connection**.
- 6 Double-click **Interrupt request (IRQ)** to view the IRQ assignments.
Conflicts are indicated by a yellow exclamation point (!) beside the conflicting device or a red X if the device has been disabled.
- 7 Double-click any conflicting device listed to bring up the **Properties** window so that you can determine what needs to be reconfigured or removed from the Device Manager. Resolve these conflicts before checking specific devices.
- 8 Double-click the malfunctioning device type in the **Device Manager** list.
- 9 Double-click the icon for the specific device in the expanded list.
The **Properties** window appears.
If an IRQ conflict exists, the **Device status** area in the **Properties** window reports what other devices are sharing the device's IRQ.
- 10 Resolve any IRQ conflicts.

You can also use the Windows 2000 Hardware Troubleshooter. To use the troubleshooter, click the **Start** button and click **Help**. Click **Troubleshooting and Maintenance** on the **Contents** tab, click **Windows 2000 troubleshooters**, and then click **Hardware**. In the **Hardware Troubleshooter** list, click **I need to resolve a hardware conflict on my computer**, and then click **Next**.

Using Microsoft® Windows® System Restore

The Microsoft Windows XP operating system provides a System Restore feature that allows you to return your computer to an earlier operating state if changes to the computer's hardware, software (including new hardware or program installations), or system settings have left the computer in an undesirable operating state. You can also undo the last *system restore*.

System Restore automatically creates system checkpoints. You can also manually create your own checkpoints by creating *restore points*. To limit the amount of hard disk space used, older restore points will be automatically purged.

To resolve an operating system problem, you can use System Restore from Safe Mode or Normal Mode to return your computer to an earlier operating state.

System Restore does not cause you to lose personal files stored in the **My Documents** folder, data files, or e-mail messages after restoring the computer to an earlier time. If you restore the computer to an operating state that existed before you installed a program, the program's data files are not lost, but you must reinstall the actual program again.



NOTICE: It is important to make regular backups of your data files. System Restore does not monitor changes to or recover your data files. If the original data on the hard disk is accidentally erased or overwritten, or if it becomes inaccessible because of a hard disk malfunction, use your backup files to recover the lost or damaged data.

System Restore is enabled on your new computer. However, if you reinstall Windows XP with less than 200 MB of free hard-disk space available, System Restore is automatically disabled. Before you use System Restore, confirm that it is enabled:

- 1 Click the **Start** button and click **Control Panel**.
- 2 Click the **Performance and Maintenance**.
- 3 Click **System**.
- 4 Click the **System Restore** tab.
- 5 Ensure that **Turn off System Restore** is not checked.

Creating a Restore Point

You can either use the System Restore Wizard or manually create a restore point.

Using the System Restore Wizard

To use the System Restore Wizard, click the **Start** button, click **Help and Support**, click **System Restore**, and then follow the instructions in the **System Restore Wizard** window. You can also create and name a restore point if you are logged on as the computer administrator or a user with administrator rights.

Manually Creating a Restore Point

- 1 Click the **Start** button, point to **All Programs**→ **Accessories**→ **System Tools**, and then click **System Restore**.
- 2 Click **Create a restore point**.
- 3 Click **Next**.
- 4 Type a name for the new restore point in the **Restore point description** field.

The present date and time are automatically added to the description of the new restore point.

- 5 Click **Create**.
- 6 Click **OK**.

Restoring the Computer to an Earlier Operating State

If problems occur after installing a device driver, first try using [Device Driver Rollback](#). If Device Driver Rollback does not resolve the problem, then use System Restore.



NOTICE: Before restoring the computer to an earlier operating state, save and close all open files and exit all open programs. Do not alter, open, or delete any files or programs until the system restoration is complete.

- 1 Click the **Start** button, point to **All Programs**→ **Accessories**→ **System Tools**, and then click **System Restore**.
- 2 Ensure that **Restore my computer to an earlier time** is selected and click **Next**.

- 3 Click a calendar date to which you want to restore your computer.

The **Select a Restore Point** screen provides a calendar that allows you to see and select restore points. All calendar dates with available restore points appear in bold.

- 4 Select a restore point and click **Next**.

If a calendar date has only one restore point, then that restore point is automatically selected. If two or more restore points are available, click the restore point that you want to use.

 **NOTICE:** Save and close all open files and exit all open programs. Do not alter, open, or delete any files or programs until the system restoration is complete.

- 5 Click **Next**.

The **Restoration Complete** screen appears after System Restore finishes collecting data, and then the computer automatically restarts.

- 6 After the computer restarts, click **OK**.

To change the restore point, you can either repeat the steps using a different restore point, or you can undo the restoration.

Undoing the Last System Restore

 **NOTICE:** Save and close all open files and exit all open programs. Do not alter, open, or delete any files or programs until the system restoration is complete.

- 1 Click the **Start** button, point to **All Programs**→**Accessories**→**System Tools**, and then click **System Restore**.

- 2 Select **Undo my last restoration** and click **Next**.

 **NOTICE:** Save and close all open files and exit all open programs. Do not alter, open, or delete any files or programs until the system restoration is complete.

- 3 Click **Next**.

The **System Restore** screen appears, and then the computer automatically restarts.

- 4 After the computer restarts, click **OK**.

Reinstalling Microsoft® Windows® XP

Before You Reinstall

If you are considering reinstalling the Windows XP operating system to correct a problem with a newly installed driver, first try using Windows XP [Device Driver Rollback](#). If Device Driver Rollback does not resolve the problem, then use [System Restore](#) to return your operating system to the operating state it was in before you installed the new device driver.

Reinstalling Windows XP

To reinstall Windows XP, perform all the steps in the following sections in the order in which they are listed.

The reinstallation process can take 1 to 2 hours to complete. After you reinstall the operating system, you must also reinstall the device drivers, virus protection program, and other software.



NOTICE: The *Operating System* CD provides options for reinstalling Windows XP. The options can overwrite files and possibly affect programs installed on your hard drive. Therefore, do not reinstall Windows XP unless instructed to do so by a Dell technical support representative.







NOTICE: To prevent conflicts with Windows XP, disable any virus protection software installed on your computer before you reinstall Windows XP. See the documentation that came with the software for instructions.

Booting From the Operating System CD

- 1 Save and close any open files and exit any open programs.
- 2 Insert the *Operating System* CD. If any program starts automatically, exit the program before proceeding.
- 3 Shut down the computer through the **Start** menu and restart the computer.
- 4 Press immediately after the DELL™ logo appears.
If the operating system logo appears, wait until you see the Windows desktop, and then shut down the computer and try again.
- 5 Press the arrow keys to select **CD-ROM**, and then press .

- 6 When the **Press any key to boot from CD** message appears, press any key.

Windows XP Setup

- 1 When the **Windows XP Setup** screen appears, press  to select **To set up Windows now**.
- 2 Read the information on the **Microsoft Windows Licensing Agreement** screen, and press  to accept the license agreement.
- 3 If your computer already has Windows XP installed and you want to recover your current Windows XP data, type **r** to select the repair option, and then remove the CD from the drive.
- 4 If you want to install a new copy of Windows XP, press  to select that option.
- 5 Press  to select the highlighted partition (recommended), and then follow the instructions on the screen.

The **Windows XP Setup** screen appears, and the operating system begins to copy files and install the devices. The computer automatically restarts multiple times.

 **NOTICE:** Do not press any key when the following message appears: **Press any key to boot from the CD**.

- 6 When the **Regional and Language Options** screen appears, select the settings for your location, and then click **Next**.
- 7 Enter your name and organization (optional) in the **Personalize Your Software** screen and click **Next**.
- 8 *If you are reinstalling Windows XP Home Edition*, at the **What's your computer's name** window, enter a name for your computer (or accept the name provided) and click **Next**.

If you are reinstalling Windows XP Professional, at the **Computer Name and Administrator Password** window, enter a name for your computer (or accept the one provided) and a password, and then click **Next**.

- 9 If the **Modem Dialing Information** screen appears, enter the requested information and click **Next**.

 **NOTE:** The time required to complete the setup depends on the size of the hard drive and the speed of your computer.

FILE LOCATION: S:\SYSTEMS\Pebble\UG\A00\English\drivers.fm

- 10 Enter the date, time, and time zone in the **Date and Time Settings** window and click **Next**.
- 11 If the **Networking Settings** screen appears, click **Typical** and click **Next**.
- 12 If you are reinstalling Windows XP Professional and you are prompted to provide further information regarding your network configuration, enter your selections. If you are unsure of your settings, accept the default selections.

Windows XP installs the operating system components and configures the computer. The computer automatically restarts.



NOTICE: Do not press any key when the following message appears: *Press any key to boot from the CD.*

- 13 When the **Welcome to Microsoft** screen appears, click **Next**.
- 14 When the *How will this computer connect to the Internet?* message appears, click **Skip**.
- 15 When the **Ready to register with Microsoft?** screen appears, select **No, not at this time** and click **Next**.
- 16 When the **Who will use this computer?** screen appears, you can enter up to five users. Click **Next**.
- 17 Click **Finish** to complete the setup, and remove the CD from the drive.

Reinstalling Drivers and Software

- 1 [Reinstall the appropriate drivers.](#)
- 2 Reinstall your virus protection software. See the documentation that came with the software for instructions.
- 3 Reinstall your other software programs. See the documentation that came with the software for instructions.



Reinstalling Windows 2000







NOTICE: The *Operating System* CD provides options for reinstalling the Windows 2000 operating system. The options can potentially overwrite files installed by Dell and possibly affect programs installed on your hard drive. Therefore, do not reinstall your operating system unless instructed to do so by a Dell technical support representative.

DELL CONFIDENTIAL – PRELIMINARY 1/29/03 – FOR PROOF ONLY

Booting From the Operating System CD

- 1 Save and close any open files and exit any open programs.
- 2 Insert the *Operating System* CD. If any program starts automatically, exit the program before proceeding.
- 3 Shut down the computer through the **Start** menu and restart the computer.
- 4 Press  immediately after the DELL™ logo appears.
If the operating system logo appears, wait until you see the Windows desktop, and then shut down the computer and try again.
- 5 Press the arrow keys to select **CD-ROM**, and then press .
- 6 When the **Press any key to boot from CD message appears**, press any key.

Windows 2000 Setup

- 1 When the **Windows 2000 Setup** window appears, ensure that **To setup Win2000 now, press ENTER** is highlighted. Then press .
- 2 Read the information in the **License Agreement** window and press  to continue.
- 3 When the **Windows 2000 Professional Setup** window appears, press the arrow keys to select the Windows 2000 partition option that you want. Then press the key for the partition option you chose.
- 4 When the **Windows 2000 Professional Setup** window reappears, press the arrow keys to select the type of file system that you want Windows 2000 to use, and then press .
- 5 Press  again to restart your computer.
- 6 Click **Next** when the **Welcome to the Windows 2000 Setup Wizard** window appears.
- 7 When the **Regional Settings** window appears, select your region, and then click **Next**.
- 8 Enter your name and organization in the **Personalize Your Software** window and click **Next**.
- 9 Enter the Windows product key, which is printed on the Microsoft label on your computer. Then click **Next**.

FILE LOCATION: S:\SYSTEMS\Pebble\UG\A00\English\drivers.fm

- 10 When the **Computer Name and Administrator Password** window appears, enter a name for your computer and a password, if desired. Then click **Next**.
- 11 Enter the date and time in the **Date and Time Settings** window and click **Next**.
Windows 2000 installs components and configures the computer.
- 12 When the **Completing the Windows 2000 Setup Wizard** window appears, remove the CD from the drive and click **Finish**.
The computer automatically restarts.

Enabling Hibernate Mode

- 1 Click the **Start** button, point to **Settings** and click **Control Panel**.
- 2 Double-click the **Power Management** icon.
- 3 Click the **Hibernate** tab.
- 4 Ensure that **Enable hibernate support** is selected and click **Apply**.
- 5 Click **OK** to close the Control Panel.

DELL CONFIDENTIAL – PRELIMINARY 1/29/03 – FOR PROOF ONLY

SECTION 18

Adding and Replacing Parts

FILE LOCATION: S:\SYSTEMS\Pebble\UG\A00\English\r_r.fm

DELL CONFIDENTIAL - PRELIMINARY 1/29/03 - FOR PROOF ONLY

Adding Memory

You can increase your computer memory by installing memory modules on the system board. See "[Specifications](#)" for information on the memory supported by your computer. Install only memory modules that are intended for your computer.

 **NOTE:** Memory modules purchased from Dell are covered under your computer warranty.

 **CAUTION:** Before working inside your computer, read the safety instructions in your *System Information Guide*.

- 1 Ensure that the work surface is flat and clean to prevent scratching the computer cover.
- 2 Save and close any open files, exit any open programs, and then shut down the computer.
- 3 If the computer is connected to a docking device (docked), undock it. See the documentation that came with your docking device for instructions.
- 4 Disconnect the computer from the electrical outlet.
- 5 Wait 10 to 20 seconds, and then disconnect any attached devices.
- 6 Remove any installed PC Cards and the battery.

 **NOTICE:** Handle components and cards by their edges, and avoid touching pins and contacts. Ground yourself by touching a metal connector on the back of the computer. Continue to ground yourself periodically during this procedure.

7 Continue to the appropriate section:

- "[Installing a Memory Module Under the Memory Module/Modem Cover](#)"
- "[Installing a Memory Module Under the Keyboard](#)"

Installing a Memory Module Under the Memory Module/Modem Cover

- 1 Turn the computer over, loosen the captive screws on the memory module/modem cover, and then remove the cover.

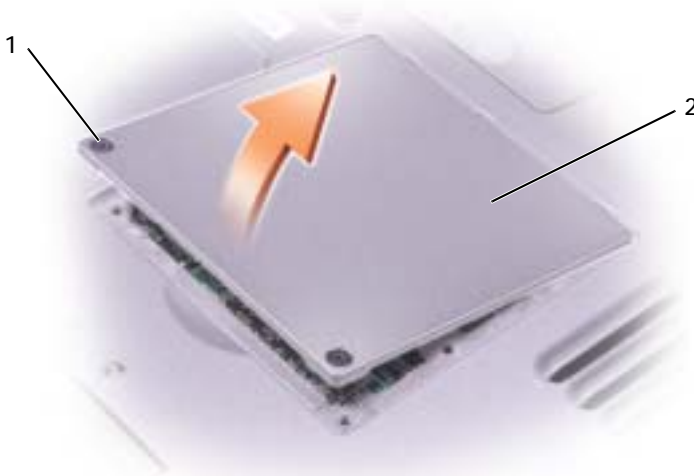

NOTICE: To prevent damage to the memory module connector, do not use tools to spread the memory-module securing clips.

- 2 If you are replacing a memory module, remove the existing module:
 - a Use your fingertips to carefully spread apart the securing clips on each end of the memory module connector until the module pops up.
 - b Remove the module from the connector.

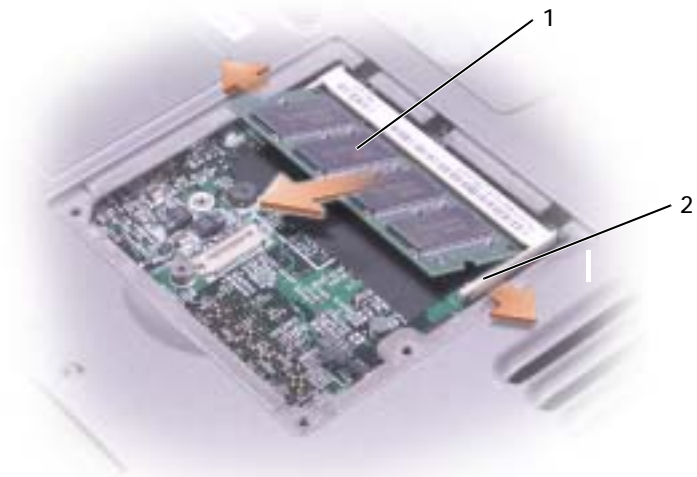

1 memory module

2 securing clips (2)

3 Ground yourself and install the new memory module:

- a Align the notch in the module edge connector with the tab in the connector slot.
- b Slide the module firmly into the slot at a 45-degree angle, and rotate the module down until it clicks into place. If you do not feel the click, remove the module and reinstall it.

 **NOTE:** If the memory module is not installed properly, the computer may not boot properly. No error message indicates this failure.



4 Replace the cover.

 **NOTICE:** If the cover is difficult to close, remove the module and reinstall it. Forcing the cover to close may damage your computer.

5 Insert the battery into the battery bay, or connect the AC adapter to your computer and an electrical outlet.

6 Turn on the computer.

As the computer boots, it detects the additional memory and automatically updates the system configuration information.

To confirm the amount of memory installed in the computer:

- *In Windows XP*, click the **Start** button, click **Help and Support**, and then click **Computer Information**.
- *In Windows 2000*, right-click the **My Computer** icon on your desktop, and then click the **General** tab.

Installing a Memory Module Under the Keyboard

1 Remove the keyboard.

2 Loosen the two captive screws in the cover labeled "DIMM1."

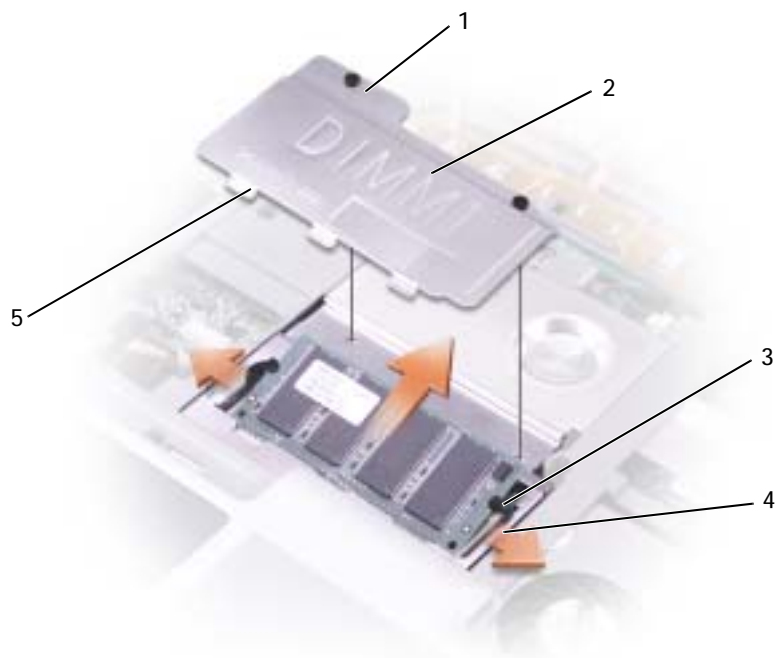

1 captive screws (2)

2 DIMM1 cover

3 memory module

4 securing clips (2)

5 securing tabs (3)

NOTICE: To prevent damage to the memory module connector, do not use tools to spread the memory-module securing clips.

3 If you are replacing a memory module, remove the existing module:

- a Use your fingertips to carefully spread apart the securing clips on each end of the memory module connector until the module pops up.
- b Remove the module from the connector.

4 Ground yourself and install the new memory module:

DELL CONFIDENTIAL – PRELIMINARY 1/29/03 – FOR PROOF ONLY

- a Align the notch in the module edge connector with the tab in the connector slot.
 - b Slide the module firmly into the slot at a 45-degree angle, and rotate the module down until it clicks into place. If you do not feel the click, remove the module and reinstall it.
- 5 Insert the 3 securing tabs on the DIMM1 cover into the notches above the memory module connector and tighten the captive screws.
-  **NOTICE:** If the DIMM1 cover is difficult to replace, remove the module and reinstall it. Forcing the cover to close may damage your computer.
- 6 [Replace the keyboard.](#)
 - 7 Insert the battery into the battery bay, or connect the AC adapter to your computer and an electrical outlet.
 - 8 Turn on the computer.

 **NOTE:** If the memory module is not installed properly, the computer may not boot properly. No error message indicates this failure.

As the computer boots, it detects the additional memory and automatically updates the system configuration information.

To confirm the amount of memory installed in the computer:

- *In Windows XP*, click the **Start** button, click **Help and Support**, and then click **Computer Information**.
- *In Windows 2000*, right-click the **My Computer** icon on your desktop, and then click the **General** tab.

Adding a Modem

If you ordered the optional modem at the same time that you ordered your computer, Dell installed the modem for you.

 **CAUTION:** Before working inside your computer, read the safety information in your *System Information Guide*.

 **NOTICE:** Handle components and cards by their edges, and avoid touching pins and contacts.

- 1 Ensure that the work surface is flat and clean to prevent scratching the computer cover.
- 2 Save and close any open files, exit any open programs, and then shut down the computer.

FILE LOCATION: S:\SYSTEMS\Pebble\UG\A00\English\lr_r.fm

- 3 If the computer is connected to a docking device (docked), undock it. See the documentation that came with your docking device for instructions.
- 4 Disconnect the computer from the electrical outlet.
- 5 Wait 10 to 20 seconds, and then disconnect any attached devices.
- 6 Remove any installed PC Cards and the battery.
- ➔ **NOTICE:** Handle components and cards by their edges, and avoid touching pins and contacts. Ground yourself by touching a metal connector on the back of the computer. Continue to ground yourself periodically during this procedure.
- 7 Turn the computer over, loosen the captive screws on the memory module/modem cover, and then remove the cover.

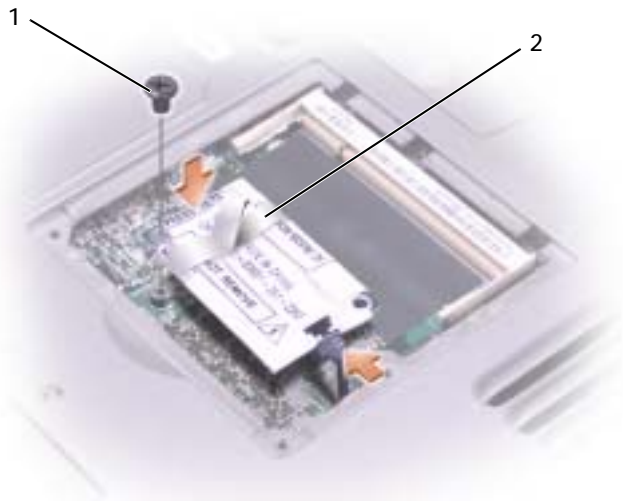

- 8 If a modem is not already installed, go to step 9. If you are replacing a modem, remove the existing modem:
 - a Remove the screw securing the modem to the system board, and set it aside.
 - b Pull straight up on the attached pull-tab to lift the modem out of its connector on the system board, and disconnect the modem cable.

DELL CONFIDENTIAL – PRELIMINARY 1/29/03 – FOR PROOF ONLY

9 Connect the modem cable to the modem.

 **NOTICE:** The cable connectors are keyed for correct insertion; do not force the connections.

10 Align the modem with the screw hole, and press the modem into the connector on the system board.

11 Install the screw to secure the modem to the system board.

12 Replace the modem cover.

Replacing the Keyboard

 **CAUTION:** Before working inside your computer, read the safety instructions in your *System Information Guide*.

1 Ensure that the work surface is flat and clean to prevent scratching the computer cover.

2 Save and close any open files, exit any open programs, and then shut down the computer.

3 If the computer is connected to a docking device (docked), undock it. See the documentation that came with your docking device for instructions.

4 Disconnect the computer from the electrical outlet.

5 Wait 10 to 20 seconds, and then disconnect any attached devices.

6 Remove any installed PC Cards and the battery.

 **NOTICE:** Handle components and cards by their edges, and avoid touching pins and contacts. Ground yourself by touching a metal connector on the back of the computer. Continue to ground yourself periodically during this procedure.

7 Open the display approximately 180 degrees.

8 Use a small flat-blade screwdriver or plastic scribe to lift the notched right edge of the center control cover, and pry the cover loose from the bottom case.

9 Remove the two screws from the top of the keyboard.

10 Use the pull tab to pull the keyboard up and out (towards the display) of the bottom case.

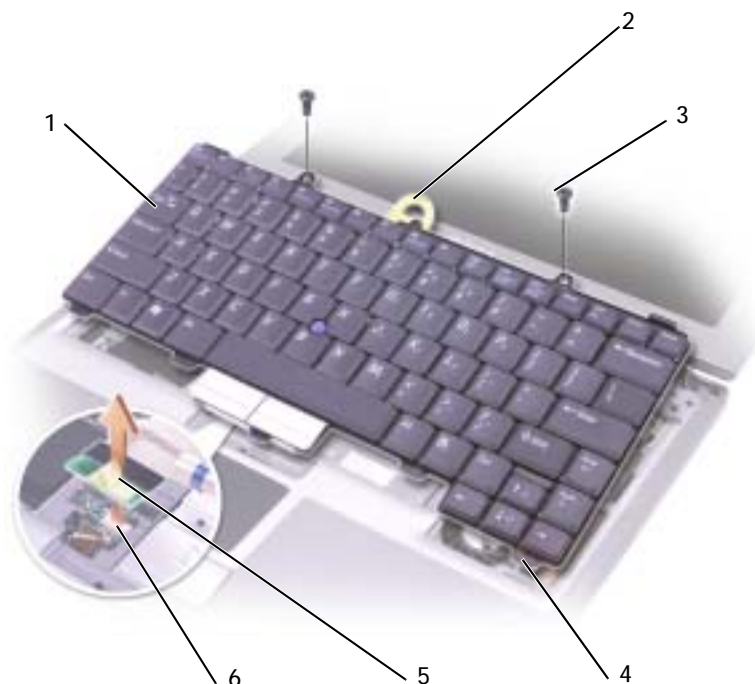

1	keyboard
2	keyboard pull tab
3	screws (2)
4	securing tabs (5)
5	keyboard-connector pull tab
6	interface connector (system board)

- 11 Rest the keyboard face down on the palm rest.
- 12 Pull straight up on the pull tab that is attached to the keyboard connector to disconnect the connector from the interface connector on the system board.

To replace the keyboard:

DELL CONFIDENTIAL – PRELIMINARY 1/29/03 – FOR PROOF ONLY

from the interface connector on the system board.

To replace the keyboard:

1. Connect the keyboard connector to the interface connector on the system board.
 2. Insert the five securing tabs on the keyboard into their respective slots in the palm rest.
 3. Replace the two screws at the top of the keyboard.
 4. Replace the center control cover and snap it down so that it is flush with the palm rest.
-

Adding a Mini PCI Card

If you ordered a Mini PCI card with your computer, the card is already installed.

 **CAUTION:** FCC rules strictly prohibit users from installing new 5 GHz Wireless LAN Mini PCI cards. Under no circumstances should the user install such a device. Only trained Dell service personnel are authorized to dispatch an individual 5 GHz Mini PCI cards to a user for replacement

If you are removing and/or installing a 2.4 GHz device, please follow the instructions noted below. Only products approved for use in your portable computer may be installed. Approved devices may be purchased only from Dell.

 **NOTE:** 2.4 GHz and 5 GHz Wireless LAN PC Cards may be removed and installed by the user.

 **CAUTION:** Before working inside your computer, read the safety instructions in your *System Information Guide*.

1. Ensure that the work surface is flat and clean to prevent scratching the computer cover.
2. Save and close any open files, exit any open programs, and then shut down the computer.
3. If the computer is connected to a docking device (docked), undock it. See the documentation that came with your docking device for instructions.
4. Disconnect the computer from the electrical outlet.
5. Wait 10 to 20 seconds, and then disconnect any attached devices.
6. Remove any installed PC Cards and the battery.

 **NOTICE:** Handle components and cards by their edges, and avoid touching pins and contacts. Ground yourself by touching a metal connector on the back of the computer. Continue to ground yourself periodically during this procedure.

7. [Remove the keyboard.](#)
8. If a Mini PCI card is not already installed, go to [step 9](#). If you are replacing a Mini PCI card, remove the existing card:
 - a. Disconnect the Mini PCI card from the attached cables.

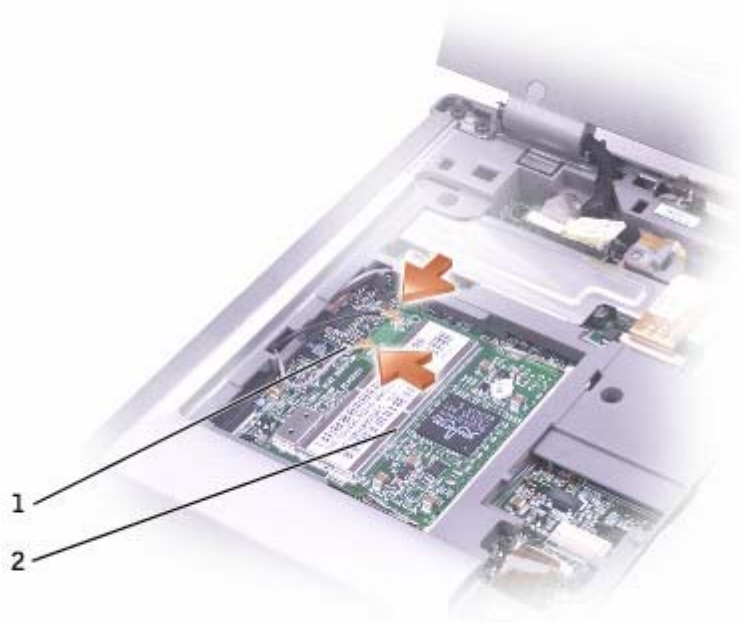

1	antenna cables (2)
2	Mini PCI card

- b. Release the Mini PCI card by spreading the metal securing tabs until the card pops up slightly.
- c. Lift the Mini PCI card out of its connector.

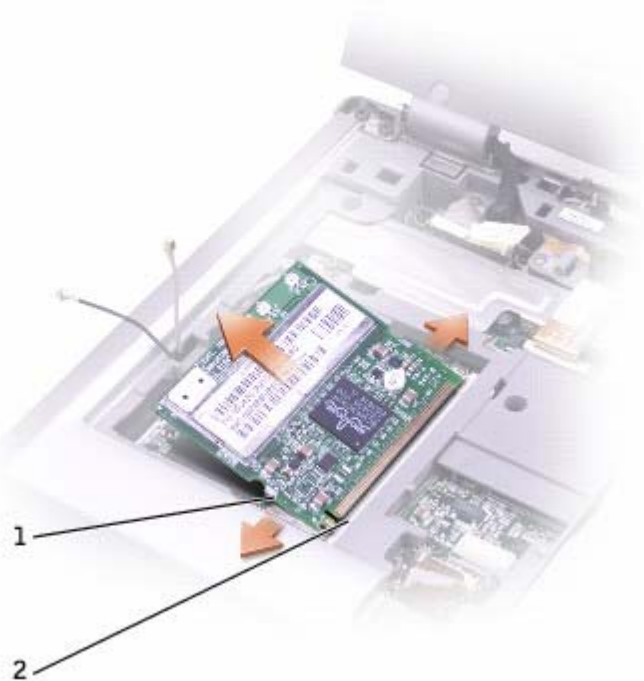

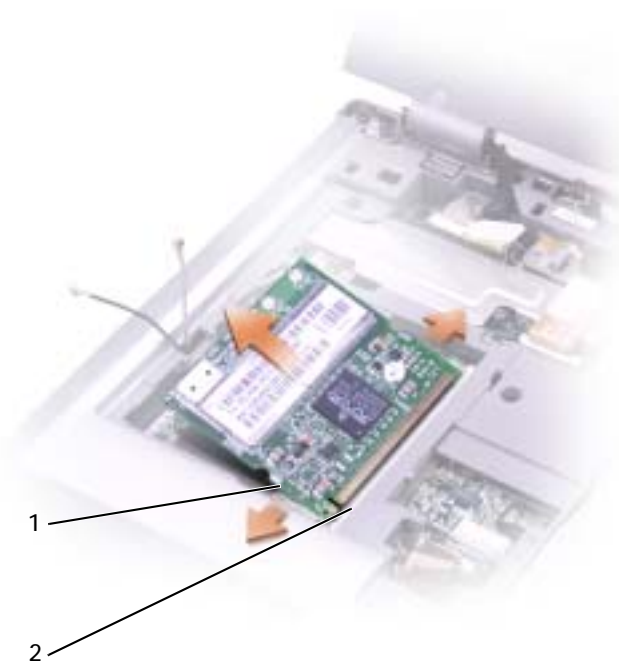

1 securing tabs(2)

2 Mini PCI card connector

➡ **NOTICE:** To avoid damaging the Mini PCI card, never place cables on top of or under the card.

➡ **NOTICE:** The connectors are keyed to ensure correct insertion. If you feel resistance, check the connectors and realign the card.

9 Align the Mini PCI card with the connector at a 45-degree angle, and press the Mini PCI card into the connector until you feel a click.

10 Connect the antenna cables to the Mini PCI card.

11 [Replace the keyboard.](#)

 **NOTE:** If a Mini PCI card was not already installed, remove the foam that secures the antenna cables before you install the card.

Replacing the Hard Drive

 **CAUTION:** If you remove the hard drive from the computer when the drive is warm, *do not touch* the metal housing of the hard drive.

 **CAUTION:** Before working inside your computer, read the safety instructions in your *System Information Guide*.

 **NOTICE:** To prevent data loss, turn off your computer before removing the hard drive. Do not remove the hard drive while the computer is on, in standby mode, or in hibernate mode.

 **NOTICE:** Hard drives are extremely fragile; even a slight bump can damage the drive.

 **NOTE:** Dell does not guarantee compatibility or provide support for hard drives from sources other than Dell.

To replace the hard drive in the hard drive bay:

- 1 Ensure that the work surface is flat and clean to prevent scratching the computer cover.
- 2 Save and close any open files, exit any open programs, and then shut down the computer.
- 3 If the computer is connected to a docking device (docked), undock it. See the documentation that came with your docking device for instructions.
- 4 Disconnect the computer from the electrical outlet.
- 5 Wait 10 to 20 seconds, and then disconnect any attached devices.
- 6 Remove any installed PC Cards and the battery.

 **NOTICE:** Handle components and cards by their edges, and avoid touching pins and contacts. Ground yourself by touching a metal connector on the back of the computer. Continue to ground yourself periodically during this procedure.

- 7 Turn the computer over, and remove the hard drive screws.

 **NOTICE:** When the hard drive is not in the computer, store it in protective antistatic packaging. See "Protecting Against Electrostatic Discharge" in your *System Information Guide*.

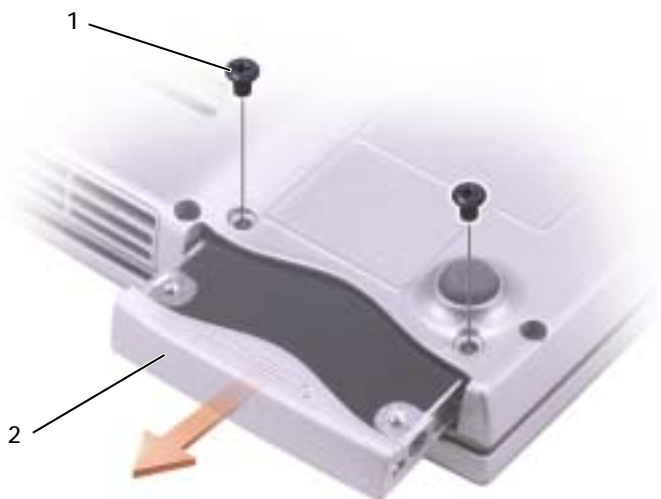

8 Slide the hard drive out of the computer.

9 Remove the new drive from its packaging.

Save the original packaging for storing or shipping the hard drive.

NOTICE: Use firm and even pressure to slide the drive into place. If you use excessive force, you may damage the connector.

10 Slide the hard drive into the bay until it is fully seated.

11 Replace and tighten the screws.

12 Use the *Operating System* CD to install the operating system for your computer.

13 Use the *Drivers and Utilities* CD to install the drivers and utilities for your computer.

Adding a Bluetooth™ Module

Changed to "Replacing a Bluetooth Module"

CAUTION: Before working inside your computer, read the safety instructions in your *System Information Guide*.

1 Ensure that the work surface is flat and clean to prevent scratching the computer cover.

FILE LOCATION: S:\SYSTEMS\Pebble\UG\A00\English\lr_r.fm

- 2 Save and close any open files, exit any open programs, and then shut down the computer.
- 3 If the computer is connected to a docking device (docked), undock it. See the documentation that came with your docking device for instructions.
- 4 Disconnect the computer from the electrical outlet.
- 5 Wait 10 to 20 seconds, and then disconnect any attached devices.
- 6 Remove any installed PC Cards and the battery.
- ➔ **NOTICE:** Handle components and cards by their edges, and avoid touching pins and contacts. Ground yourself by touching a metal connector on the back of the computer. Continue to ground yourself periodically during this procedure.
- 7 Turn the computer over, loosen the captive screw in the Bluetooth module cover, and remove the cover.

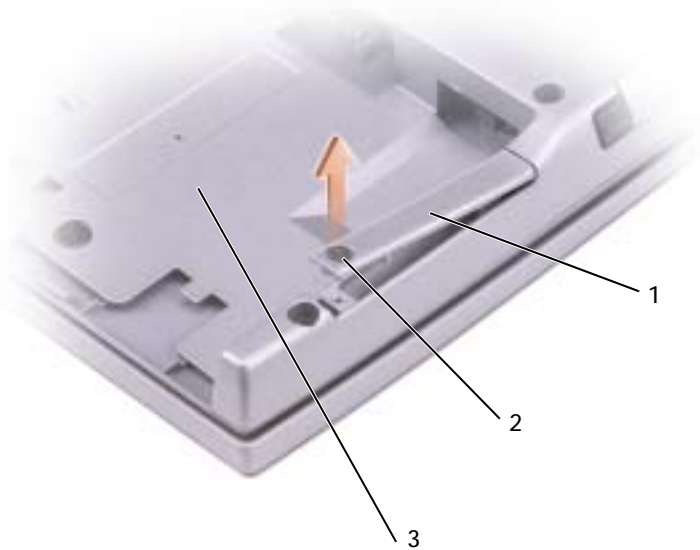

DELL CONFIDENTIAL – PRELIMINARY 1/29/03 – FOR PROOF ONLY

1 Bluetooth module cover

2 captive screw

3 battery bay

8 ~~If a Bluetooth module is not already installed, go to step 9. If you are replacing the Bluetooth module,~~ remove the existing module:

- a Pull the Bluetooth module out of the slot.
- b Disconnect the cable from the module.

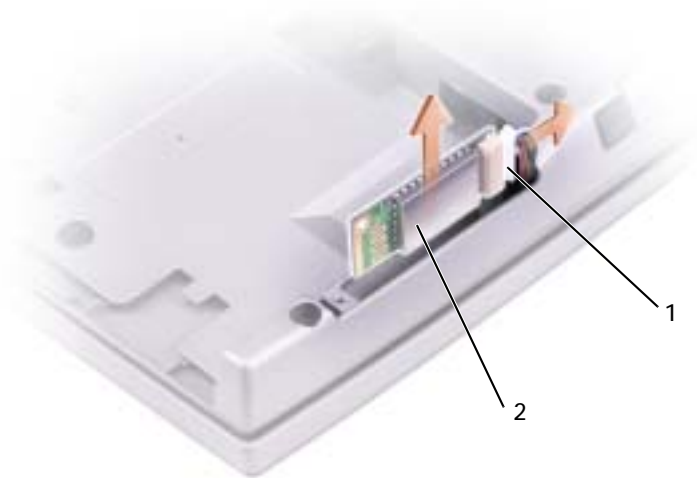

1 Bluetooth cable

2 Bluetooth module (front)

9 Ensure that the front of the Bluetooth module (silver) is facing outward, and connect the cable to the module.

10 Insert the module into the slot.

11 Replace the cover and tighten the captive screw.

FILE LOCATION: S:\SYSTEMS\Pebble\UG\A00\English\lr_r.fm

DELL CONFIDENTIAL – PRELIMINARY 1/29/03 – FOR PROOF ONLY

SECTION 19

Using the System Setup Program

FILE LOCATION: S:\SYSTEMS\Pebble\UG\A00\English\setup.fm

DELL CONFIDENTIAL – PRELIMINARY 1/29/03 – FOR PROOF ONLY

 **NOTE:** Your operating system may automatically configure most of the options available in the system setup program, thus overriding options that you set through the system setup program. (An exception is the **External Hot Key** option, which you can disable or enable only through the system setup program.) For more information on configuring features for your operating system, see your Microsoft® Windows® *Help* (Windows 2000) or the Windows Help and Support Center (Windows XP).

Overview

You can use the system setup program as follows:

- To set or change user-selectable features—for example, your computer password
- To verify information about the computer's current configuration, such as the amount of system memory

After you set up the computer, run the system setup program to familiarize yourself with your system configuration information and optional settings. You may want to write down the information for future reference.

The system setup screens display the current setup information and settings for your computer, such as:

- System configuration
- Boot order
- Boot (start-up) configuration and docking-device configuration settings
- Basic device configuration settings
- System security and hard-drive password settings



NOTICE: Unless you are an expert computer user or are directed to do so by Dell technical support, do not change the settings for the system setup program. Certain changes might make your computer work incorrectly.

Viewing the System Setup Screens

- 1 Turn on (or restart) your computer.
- 2 When the DELL™ logo appears, press  immediately. If you wait too long and the Windows logo appears, continue to wait until you see the Windows desktop. Then shut down your computer and try again.

System Setup Screens

On each screen, the system setup options are listed at the left. To the right of each option is the setting or value for that option. You can change settings that appear as white type on the screen. Options or values that you cannot change (because they are determined by the computer) appear as blue text.

The upper-right corner of the screen displays help information for the currently highlighted option; the lower-right corner displays information about the computer. System setup key functions are listed across the bottom of the screen.

Commonly Used Options

Certain options require that you reboot the computer for new settings to take effect.

Changing the Boot Sequence

The *boot sequence*, or *boot order*, tells the computer where to look to find the software needed to start the operating system. You can control the boot sequence and enable/disable devices using the **Boot Order** page of the system setup program.

The **Boot Order** page displays a general list of the bootable devices that may be installed in your computer, including but not limited to the following:

- **Diskette Drive**
- **Internal HDD**
- **CD/DVD/CD-RW drive**

During the boot routine, the computer starts at the top of the list and scans each enabled device for the operating system start-up files. When the computer finds the files, it stops searching and starts the operating system.



To control the boot devices, select (highlight) a device by pressing the



or key, and then enable or disable the device or change its order in the list.





NOTE: To change the boot sequence on a one-time-only basis, see ["Performing a One-Time Boot."](#)

- To enable or disable a device, highlight the item and press . Enabled items appear as white and display a small triangle to the left; disabled items appear blue or dimmed without a triangle.
- To reorder a device in the list, highlight the device and then press  or  (not case-sensitive) to move the highlighted device up or down.

Boot sequence changes take effect as soon as you save the changes and exit the system setup program.

Performing a One-Time Boot

You can set a one-time-only boot sequence without entering the system setup program. (You can also use this procedure to boot the Dell Diagnostics on the diagnostics utility partition on your hard drive.)

- 1 Turn off the computer.
- 2 If the computer is connected to a docking device (docked), undock it. See the documentation that came with your docking device for instructions.
- 3 Connect the computer to an electrical outlet.
- 4 Turn on the computer. When the DELL logo appears, press  immediately. If you wait too long and the Windows logo appears, continue to wait until you see the Windows desktop. Then shut down your computer and try again.
- 5 When the boot device list appears, highlight the device from which you want to boot and press .







The computer boots to the selected device.

The next time you reboot the computer, the previous boot order is restored.

Changing COM Ports

Serial Port allows you to map the serial port COM address or disable the serial port and its address, freeing computer resources for another device to use.

Enabling the Infrared Sensor

- 1 Enter the system setup program:
 - a Turn on your computer.
 - b Press  when the DELL™ logo appears.
- 2 Press   until you locate **Infrared Data Port** under **Basic Device Configuration**.
- 3 Press the down-arrow key to select the **Infrared Data Port** setting, and press the right-arrow key to change the setting to a COM port.
- 4 Press  , select **Save changes and reboot**, and press  to save the changes and exit the system setup program. If you are prompted to restart your computer, click **Yes**.
- 5 Follow the instructions on the screen.
- 6 After the infrared sensor has been enabled, click **Yes** to restart the computer.

 **NOTE:** Ensure that the COM port that you select is different from the COM port assigned to the serial connector.

After you enable the infrared sensor, you can use it to establish a link to an infrared device. To set up and use an infrared device, see the infrared device documentation and the Windows Help and Support Center (Windows *Help* in Windows 2000).

FILE LOCATION: S:\SYSTEMS\Pebble\UG\A00\English\setup.fm

DELL CONFIDENTIAL – PRELIMINARY 1/29/03 – FOR PROOF ONLY

SECTION 20

Alert Standard Format (ASF)

FILE LOCATION: S:\SYSTEMS\Pebble\UG\A00\English\asf.fm

DELL CONFIDENTIAL - PRELIMINARY 1/29/03 - FOR PROOF ONLY

Alert Standard Format (ASF) is a Distributed Management Task Force (DMTF) management standard that specifies "pre-operating system" or "operating system absent" alerting techniques. The standard is designed to generate an alert on potential security and fault conditions when the operating system is in a sleep state or the system is turned off. ASF is designed to supersede previous operating system-absent alerting technologies.

Your computer supports the following ASF alerts and remote capabilities:

Alert	Description
Chassis Intrusion - Physical Security Violation/Chassis Intrusion - Physical Security Violation Event Cleared	The docking device has been opened and the PCI slot has been compromised.
Failure to Boot to BIOS	The BIOS did not complete loading upon initiation.
System Password Violation	The system password is invalid (alert occurs after three failed attempts).
Entity Presence	Periodic heartbeats have been transmitted to verify system presence.

For more information about Dell's ASF implementation, see *ASF for Dell Portable Computers* and the *ASF Administrator's Guide for Dell Portable Computers*, which are available on the Dell Support website at support.dell.com.

SECTION 21

Getting Help

FILE LOCATION: S:\SYSTEMS\Pebble\UG\A00\English\gethelp.fm

DELL CONFIDENTIAL - PRELIMINARY 1/29/03 - FOR PROOF ONLY

Technical Assistance

If you need help with a technical problem, Dell is ready to assist you.



CAUTION: If you need to remove the computer covers, first disconnect the computer power and modem cables from all electrical outlets.

- 1 Complete the procedures in "[Solving Problems](#)."
- 2 Run the [Dell Diagnostics](#).
- 3 Make a copy of the Diagnostics Checklist and fill it out.
- 4 Use Dell's extensive suite of online services available at Dell Support (support.dell.com) for help with installation and troubleshooting procedures.
- 5 If the preceding steps have not resolved the problem, contact Dell.

NOTE: Call technical support from a telephone near or at the computer so that technical support can assist you with any necessary procedures.

NOTE: Dell's Express Service Code system may not be available in all countries.

When prompted by Dell's automated telephone system, enter your Express Service Code to route the call directly to the proper support personnel. If you do not have an Express Service Code, open the **Dell Accessories** folder, double-click the **Express Service Code** icon, and follow the directions.

For instructions on using the technical support service, see "Technical Support Service."

NOTE: Some of the following services are not always available in all locations outside the continental U.S. Call your local Dell representative for information on availability.

Online Services

You can access Dell Support at support.dell.com. Select your region on the **WELCOME TO DELL SUPPORT** page, and fill in the requested details to access help tools and information.

You can contact Dell electronically using the following addresses:

- World Wide Web
www.dell.com/
www.dell.com/ap/ (for Asian/Pacific countries only)
www.euro.dell.com (for Europe only)
www.dell.com/la/ (for Latin American countries)
- Anonymous file transfer protocol (FTP)
ftp.dell.com/
Log in as user: `anonymous`, and use your e-mail address as your password.
- Electronic Support Service
`mobile_support@us.dell.com`
`support@us.dell.com`
`apsupport@dell.com` (for Asian/Pacific countries only)
support.euro.dell.com (for Europe only)
- Electronic Quote Service
`sales@dell.com`
`apmarketing@dell.com` (for Asian/Pacific countries only)
- Electronic Information Service
`info@dell.com`

AutoTech Service

Dell's automated technical support service—AutoTech—provides recorded answers to the questions most frequently asked by Dell customers about their portable and desktop computers.

When you call AutoTech, use your touch-tone telephone to select the subjects that correspond to your questions.

The AutoTech service is available 24 hours a day, 7 days a week. You can also access this service through the technical support service. For the telephone number to call, see the [contact numbers](#) for your region.

Automated Order-Status Service

To check on the status of any Dell products that you have ordered, you can go to support.dell.com, or you can call the automated order-status service. A recording prompts you for the information needed to locate and report on your order. For the telephone number to call, see the [contact numbers](#) for your region.

Technical Support Service

Dell's technical support service is available 24 hours a day, 7 days a week, to answer your questions about Dell hardware. Our technical support staff uses computer-based diagnostics to provide fast, accurate answers.

To contact Dell's technical support service, see "Technical Assistance" and then call the number for your country as listed in "Contacting Dell."

Problems With Your Order

If you have a problem with your order, such as missing parts, wrong parts, or incorrect billing, contact Dell for customer assistance. Have your invoice or packing slip handy when you call. For the telephone number to call, see the [contact numbers](#) for your region.

Product Information

If you need information about additional products available from Dell, or if you would like to place an order, visit the Dell website at www.dell.com. For the telephone number to call to speak to a sales specialist, see the [contact numbers](#) for your region.

Returning Items for Warranty Repair or Credit

Prepare all items being returned, whether for repair or credit, as follows:

- 1 Call Dell to obtain a Return Material Authorization Number, and write it clearly and prominently on the outside of the box.

For the telephone number to call, see the [contact numbers](#) for your region.

- 2 Include a copy of the invoice and a letter describing the reason for the return.
- 3 Include a copy of the Diagnostics Checklist indicating the tests you have run and any error messages reported by the Dell Diagnostics.
- 4 Include any accessories that belong with the item(s) being returned (power cables, software floppy disks, guides, and so on) if the return is for credit.
- 5 Pack the equipment to be returned in the original (or equivalent) packing materials.

You are responsible for paying shipping expenses. You are also responsible for insuring any product returned, and you assume the risk of loss during shipment to Dell. Collect On Delivery (C.O.D.) packages are not accepted.

Returns that are missing any of the preceding requirements will be refused at Dell's receiving dock and returned to you.

Before You Call

NOTE: Have your Express Service Code ready when you call. The code helps Dell's automated-support telephone system direct your call more efficiently.

Remember to fill out the Diagnostics Checklist. If possible, turn on your computer before you call Dell for technical assistance and call from a telephone at or near the computer. You may be asked to type some commands at the keyboard, relay detailed information during operations, or try other troubleshooting steps possible only at the computer itself. Ensure that the computer documentation is available.



CAUTION: Before working inside your computer, read the safety instructions in your *System Information Guide*.

Diagnostics Checklist

Name:

Date:

Address:

Phone number:

Service Tag (bar code on the back of the computer):

Express Service Code:

Return Material Authorization Number (if provided by Dell support technician):

Operating system and version:

Devices:

Expansion cards:

Are you connected to a network? Yes No

Network, version, and network adapter:

Programs and versions:

See your operating system documentation to determine the contents of the system's start-up files. If the computer is connected to a printer, print each file. Otherwise, record the contents of each file before calling Dell.

Error message, beep code, or diagnostic code:

Description of problem and troubleshooting procedures you performed:

Contacting Dell

To contact Dell electronically, you can access the following websites:

- **www.dell.com**
- **support.dell.com** (technical support)
- **premiersupport.dell.com** (technical support for educational, government, healthcare, and medium/large business customers, including Premier, Platinum, and Gold customers)

For specific web addresses for your country, find the appropriate country section in the table below.

NOTE: Toll-free numbers are for use within the country for which they are listed.

When you need to contact Dell, use the electronic addresses, telephone numbers, and codes provided in the following table. If you need assistance in determining which codes to use, contact a local or an international operator.

Country (City) International Access Code Country Code City Code	Department Name or Service Area, Website and E-Mail Address	Area Codes, Local Numbers, and Toll-Free Numbers
Anguilla	General Support	toll-free: 800-335-0031
Antigua and Barbuda	General Support	1-800-805-5924
Argentina (Buenos Aires)	Website: www.dell.com.ar	
International Access Code: 00	Tech Support and Customer Care	toll-free: 0-800-444-0733
Country Code: 54	Sales	0-810-444-3355
City Code: 11	Tech Support Fax	11 4515 7139
	Customer Care Fax	11 4515 7138
Aruba	General Support	toll-free: 800-1578

Country (City) International Access Code Country Code City Code	Department Name or Service Area, Website and E-Mail Address	Area Codes, Local Numbers, and Toll-Free Numbers
Australia (Sydney)	E-mail (Australia): au_tech_support@dell.com	
International Access Code: 0011	E-mail (New Zealand): nz_tech_support@dell.com	
Country Code: 61	Home and Small Business	1-300-65-55-33
City Code: 2	Government and Business	toll-free: 1-800-633-559
	Preferred Accounts Division (PAD)	toll-free: 1-800-060-889
	Customer Care	toll-free: 1-800-819-339
	Corporate Sales	toll-free: 1-800-808-385
	Transaction Sales	toll-free: 1-800-808-312
	Fax	toll-free: 1-800-818-341
Austria (Vienna)	Website: support.euro.dell.com	
International Access Code: 900	E-mail: tech_support_central_europe@dell.com	
Country Code: 43	Home/Small Business Sales	01 795 67602
City Code: 1	Home/Small Business Fax	01 795 67605
	Home/Small Business Customer Care	01 795 67603
	Preferred Accounts/Corporate Customer Care	0660 8056
	Home/Small Business Technical Support	01 795 67604
	Preferred Accounts/Corporate Technical Support	0660 8779
	Switchboard	01 491 04 0
Bahamas	General Support	toll-free: 1-866-278-6818
Barbados	General Support	1-800-534-3066
Belgium (Brussels)	Website: support.euro.dell.com	
International Access Code: 00	E-mail: tech_be@dell.com	
Country Code: 32	E-mail for French Speaking Customers: support.euro.dell.com/be/fr/emaildell/	
City Code: 2	Technical Support	02 481 92 88
	Customer Care	02 481 91 19
	Home/Small Business Sales	toll-free: 0800 16884
	Corporate Sales	02 481 91 00
	Fax	02 481 92 99
	Switchboard	02 481 91 00

DELL CONFIDENTIAL – PRELIMINARY 1/29/03 – FOR PROOF ONLY

Country (City) International Access Code Country Code City Code	Department Name or Service Area, Website and E-Mail Address	Area Codes, Local Numbers, and Toll-Free Numbers
Bermuda	General Support	1-800-342-0671
Bolivia	General Support	toll-free: 800-10-0238
Brazil	Website: www.dell.com/br	
International Access Code: 00	Customer Support, Technical Support	0800 90 3355
Country Code: 55	Tech Support Fax	51 481 5470
City Code: 51	Customer Care Fax	51 481 5480
	Sales	0800 90 3390
British Virgin Islands	General Support	toll-free: 1-866-278-6820
Brunei	Customer Technical Support (Penang, Malaysia)	604 633 4966
Country Code: 673	Customer Service (Penang, Malaysia)	604 633 4949
	Transaction Sales (Penang, Malaysia)	604 633 4955
Canada (North York, Ontario)	Automated Order-Status System	toll-free: 1-800-433-9014
International Access Code: 011	AutoTech (automated technical support)	toll-free: 1-800-247-9362
	TechFax	toll-free: 1-800-950-1329
	Customer Care (home/small business)	toll-free: 1-800-847-4096
	Customer Care (med./large business, government)	toll-free: 1-800-326-9463
	Technical Support (home/small business)	toll-free: 1-800-847-4096
	Technical Support (med./large bus., government)	toll-free: 1-800-847-4096
	Sales (direct sales—from outside Toronto)	toll-free: 1-800-387-5752
	Sales (direct sales—from within Toronto)	416 758-2200
	Sales (federal government, education, and medical)	toll-free: 1-800-567-7542
Cayman Islands	General Support	1-800-805-7541
Chile (Santiago)	Sales, Customer Support, and Technical Support	toll-free: 1230-020-4823
Country Code: 56		
City Code: 2		

Country (City) International Access Code Country Code City Code	Department Name or Service Area, Website and E-Mail Address	Area Codes, Local Numbers, and Toll-Free Numbers
China (Xiamen)	Tech Support website: support.ap.dell.com/china	
Country Code: 86	Tech Support E-mail: cn_support@dell.com	
City Code: 592	Tech Support Fax	818 1350
	Home and Small Business Technical Support	toll-free: 800 858 2437
	Corporate Accounts Technical Support	toll-free: 800 858 2333
	Customer Experience	toll-free: 800 858 2060
	Home and Small Business	toll-free: 800 858 2222
	Preferred Accounts Division	toll-free: 800 858 2062
	Large Corporate Accounts GCP	toll-free: 800 858 2055
	Large Corporate Accounts Key Accounts	toll-free: 800 858 2628
	Large Corporate Accounts North	toll-free: 800 858 2999
	Large Corporate Accounts North Government and Education	toll-free: 800 858 2955
	Large Corporate Accounts East	toll-free: 800 858 2020
	Large Corporate Accounts East Government and Education	toll-free: 800 858 2669
	Large Corporate Accounts Queue Team	toll-free: 800 858 2572
	Large Corporate Accounts South	toll-free: 800 858 2355
	Large Corporate Accounts West	toll-free: 800 858 2811
	Large Corporate Accounts Spare Parts	toll-free: 800 858 2621
Colombia	General Support	980-9-15-3978
Costa Rica	General Support	0800-012-0435
Czech Republic (Prague)	Website: support.euro.dell.com	
International Access Code: 00	E-mail: czech_dell@dell.com	
Country Code: 420	Technical Support	02 22 83 27 27
City Code: 2	Customer Care	02 22 83 27 11
	Fax	02 22 83 27 14
	TechFax	02 22 83 27 28
	Switchboard	02 22 83 27 11

DELL CONFIDENTIAL – PRELIMINARY 1/29/03 – FOR PROOF ONLY

Country (City) International Access Code Country Code City Code	Department Name or Service Area, Website and E-Mail Address	Area Codes, Local Numbers, and Toll-Free Numbers
Denmark (Copenhagen) International Access Code: 00 Country Code: 45	Website: support.euro.dell.com E-mail Support (portable computers): den_nbk_support@dell.com E-mail Support (desktop computers): den_support@dell.com E-mail Support (servers): Nordic_server_support@dell.com	
	Technical Support	7023 0182
	Customer Care (Relational)	7023 0184
	Home/Small Business Customer Care	3287 5505
	Switchboard (Relational)	3287 1200
	Fax Switchboard (Relational)	3287 1201
	Switchboard (Home/Small Business)	3287 5000
	Fax Switchboard (Home/Small Business)	3287 5001
Dominica	General Support	toll-free: 1-866-278-6821
Dominican Republic	General Support	1-800-148-0530
Ecuador	General Support	toll-free: 999-119
El Salvador	General Support	01-899-753-0777
Finland (Helsinki) International Access Code: 990 Country Code: 358 City Code: 9	Website: support.euro.dell.com E-mail: fin_support@dell.com E-mail Support (servers): Nordic_support@dell.com	
	Technical Support	09 253 313 60
	Technical Support Fax	09 253 313 81
	Relational Customer Care	09 253 313 38
	Home/Small Business Customer Care	09 693 791 94
	Fax	09 253 313 99
	Switchboard	09 253 313 00

Country (City) International Access Code Country Code City Code	Department Name or Service Area, Website and E-Mail Address	Area Codes, Local Numbers, and Toll-Free Numbers
France (Paris) (Montpellier)	Website: support.euro.dell.com	
International Access Code: 00	E-mail: support.euro.dell.com/fr/fr/emaildell/	
Country Code: 33	Home and Small Business	
City Codes: (1) (4)	Technical Support	0825 387 270
	Customer Care	0825 823 833
	Switchboard	0825 004 700
	Switchboard (calls from outside of France)	04 99 75 40 00
	Sales	0825 004 700
	Fax	0825 004 701
	Fax (calls from outside of France)	04 99 75 40 01
	Corporate	
	Technical Support	0825 004 719
	Customer Care	0825 338 339
	Switchboard	01 55 94 71 00
	Sales	01 55 94 71 00
	Fax	01 55 94 71 01
Germany (Langen)	Website: support.euro.dell.com	
International Access Code: 00	E-mail: tech_support_central_europe@dell.com	
Country Code: 49	Technical Support	06103 766-7200
City Code: 6103	Home/Small Business Customer Care	0180-5-224400
	Global Segment Customer Care	06103 766-9570
	Preferred Accounts Customer Care	06103 766-9420
	Large Accounts Customer Care	06103 766-9560
	Public Accounts Customer Care	06103 766-9555
	Switchboard	06103 766-7000
Grenada	General Support	toll-free: 1-866-540-3355
Guatemala	General Support	1-800-999-0136
Guyana	General Support	toll-free: 1-877-270-4609

Country (City) International Access Code Country Code City Code	Department Name or Service Area, Website and E-Mail Address	Area Codes, Local Numbers, and Toll-Free Numbers
Hong Kong	Technical Support (Dimension™ and Inspiron™)	296 93188
International Access Code: 001 Country Code: 852	Technical Support (OptiPlex™, Latitude™, and Dell Precision™)	296 93191
	Customer Service (non-technical, post-sales issues)	800 93 8291
	Transaction Sales	toll-free: 800 96 4109
	Large Corporate Accounts HK	toll-free: 800 96 4108
	Large Corporate Accounts GCP HK	toll-free: 800 90 3708
India	Technical Support	1600 33 8045
	Sales	1600 33 8044
Ireland (Cherrywood)	Website: support.euro.dell.com	
International Access Code: 16 Country Code: 353 City Code: 1	E-mail: dell_direct_support@dell.com	
	Ireland Technical Support	1850 543 543
	U.K. Technical Support (dial within U.K. only)	0870 908 0800
	Home User Customer Care	01 204 4095
	Small Business Customer Care	01 204 4444
	U.K. Customer Care (dial within U.K. only)	0870 906 0010
	Corporate Customer Care	01 204 4003
	Ireland Sales	01 204 4444
	U.K. Sales (dial within U.K. only)	0870 907 4000
	SalesFax	01 204 0144
	Fax	01 204 5960
	Switchboard	01 204 4444

FILE LOCATION: S:\SYSTEMS\Pebble\UG\A00\English\gethelp.fm

www.dell.com | support.dell.com

Country (City) International Access Code Country Code City Code	Department Name or Service Area, Website and E-Mail Address	Area Codes, Local Numbers, and Toll-Free Numbers
Italy (Milan)	Website: support.euro.dell.com	
International Access Code: 00	E-mail: support.euro.dell.com/it/it/emaildell/	
Country Code: 39	Home and Small Business	
City Code: 02	Technical Support	02 577 826 90
	Customer Care	02 696 821 14
	Fax	02 696 821 13
	Switchboard	02 696 821 12
	Corporate	
	Technical Support	02 577 826 90
	Customer Care	02 577 825 55
	Fax	02 575 035 30
	Switchboard	02 577 821
Jamaica	General Support (dial from within Jamaica only)	1-800-682-3639

DELL CONFIDENTIAL – PRELIMINARY 1/29/03 – FOR PROOF ONLY

Country (City) International Access Code Country Code City Code	Department Name or Service Area, Website and E-Mail Address	Area Codes, Local Numbers, and Toll-Free Numbers
Japan (Kawasaki)	Website: support.jp.dell.com	
International Access Code: 001	Technical Support (servers)	toll-free: 0120-198-498
Country Code: 81	Technical Support outside of Japan (servers)	81-44-556-4162
City Code: 44	Technical Support (Dimension™ and Inspiron™)	toll-free: 0120-198-226
	Technical Support outside of Japan (Dimension and Inspiron)	81-44-520-1435
	Technical Support (Dell Precision™, OptiPlex™, and Latitude™)	toll-free:0120-198-433
	Technical Support outside of Japan (Dell Precision, OptiPlex, and Latitude)	81-44-556-3894
	24-Hour Automated Order Service	044-556-3801
	Customer Care	044-556-4240
	Business Sales Division (up to 400 employees)	044-556-1465
	Preferred Accounts Division Sales (over 400 employees)	044-556-3433
	Large Corporate Accounts Sales (over 3500 employees)	044-556-3430
	Public Sales (government agencies, educational institutions, and medical institutions)	044-556-1469
	Global Segment Japan	044-556-3469
	Individual User	044-556-1760
	Faxbox Service	044-556-3490
	Switchboard	044-556-4300
Korea (Seoul)	Technical Support	toll-free: 080-200-3800
International Access Code: 001	Sales	toll-free: 080-200-3600
Country Code: 82	Customer Service (Seoul, Korea)	toll-free: 080-200-3800
City Code: 2	Customer Service (Penang, Malaysia)	604 633 4949
	Fax	2194-6202
	Switchboard	2194-6000

Country (City) International Access Code Country Code City Code	Department Name or Service Area, Website and E-Mail Address	Area Codes, Local Numbers, and Toll-Free Numbers
Latin America	Customer Technical Support (Austin, Texas, U.S.A.)	512 728-4093
	Customer Service (Austin, Texas, U.S.A.)	512 728-3619
	Fax (Technical Support and Customer Service) (Austin, Texas, U.S.A.)	512 728-3883
	Sales (Austin, Texas, U.S.A.)	512 728-4397
	SalesFax (Austin, Texas, U.S.A.)	512 728-4600 or 512 728-3772
Luxembourg	Website: support.euro.dell.com	
International Access Code: 00	E-mail: tech_be@dell.com	
Country Code: 352	Technical Support (Brussels, Belgium)	02 481 92 88
	Home/Small Business Sales (Brussels, Belgium)	toll-free: 080016884
	Corporate Sales (Brussels, Belgium)	02 481 91 00
	Customer Care (Brussels, Belgium)	02 481 91 19
	Fax (Brussels, Belgium)	02 481 92 99
	Switchboard (Brussels, Belgium)	02 481 91 00
Macao	Technical Support	toll-free: 0800 582
Country Code: 853	Customer Service (Penang, Malaysia)	604 633 4949
	Transaction Sales	toll-free: 0800 581
Malaysia (Penang)	Technical Support	toll-free: 1 800 888 298
International Access Code: 00	Customer Service	04 633 4949
Country Code: 60	Transaction Sales	toll-free: 1 800 888 202
City Code: 4	Corporate Sales	toll-free: 1 800 888 213

Country (City) International Access Code Country Code City Code	Department Name or Service Area, Website and E-Mail Address	Area Codes, Local Numbers, and Toll-Free Numbers
Mexico	Customer Technical Support	001-877-384-8979
International Access Code: 00		or 001-877-269-3383
Country Code: 52	Sales	50-81-8800
		or 01-800-888-3355
	Customer Service	001-877-384-8979
		or 001-877-269-3383
	Main	50-81-8800
		or 01-800-888-3355
Montserrat	General Support	toll-free: 1-866-278-6822
Netherlands Antilles	General Support	001-800-882-1519
Netherlands (Amsterdam)	Website: support.euro.dell.com	
International Access Code: 00	E-mail (Technical Support):	
Country Code: 31	(Enterprise): nl_server_support@dell.com	
City Code: 20	(Latitude): nl_latitude_support@dell.com	
	(Inspiron): nl_inspiron_support@dell.com	
	(Dimension): nl_dimension_support@dell.com	
	(OptiPlex): nl_optiplex_support@dell.com	
	(Dell Precision): nl_workstation_support@dell.com	
	Technical Support	020 674 45 00
	Technical Support Fax	020 674 47 66
	Home/Small Business Customer Care	020 674 42 00
	Relational Customer Care	020 674 4325
	Home/Small Business Sales	020 674 55 00
	Relational Sales	020 674 50 00
	Home/Small Business Sales Fax	020 674 47 75
	Relational Sales Fax	020 674 47 50
	Switchboard	020 674 50 00
	Switchboard Fax	020 674 47 50

Country (City) International Access Code Country Code City Code	Department Name or Service Area, Website and E-Mail Address	Area Codes, Local Numbers, and Toll-Free Numbers
New Zealand	E-mail (New Zealand): nz_tech_support@dell.com	
International Access Code: 00	E-mail (Australia): au_tech_support@dell.com	
Country Code: 64	Home and Small Business	0800 446 255
	Government and Business	0800 444 617
	Sales	0800 441 567
	Fax	0800 441 566
Nicaragua	General Support	001-800-220-1006
Norway (Lysaker)	Website: support.euro.dell.com	
International Access Code: 00	E-mail Support (portable computers):	
Country Code: 47	nor_nbk_support@dell.com	
	E-mail Support (desktop computers):	
	nor_support@dell.com	
	E-mail Support (servers):	
	nordic_server_support@dell.com	
	Technical Support	671 16882
	Relational Customer Care	671 17514
	Home/Small Business Customer Care	23162298
	Switchboard	671 16800
	Fax Switchboard	671 16865
Panama	General Support	001-800-507-0962
Peru	General Support	0800-50-669
Poland (Warsaw)	Website: support.euro.dell.com	
International Access Code: 011	E-mail: pl_support@dell.com	
Country Code: 48	Customer Service Phone	57 95 700
City Code: 22	Customer Care	57 95 999
	Sales	57 95 999
	Customer Service Fax	57 95 806
	Reception Desk Fax	57 95 998
	Switchboard	57 95 999

DELL CONFIDENTIAL – PRELIMINARY 1/29/03 – FOR PROOF ONLY

Country (City) International Access Code Country Code City Code	Department Name or Service Area, Website and E-Mail Address	Area Codes, Local Numbers, and Toll-Free Numbers
Portugal	E-mail: support.euro.dell.com/es/es/emaiddell/	
International Access Code: 00	Technical Support	800 834 077
Country Code: 35	Customer Care	800 300 415 or 800 834 075
	Sales	800 300 410 or 800 300 411 or 800 300 412 or 121 422 07 10
	Fax	121 424 01 12
Puerto Rico	General Support	1-800-805-7545
St. Kitts and Nevis	General Support	toll-free: 1-877-441-4731
St. Lucia	General Support	1-800-882-1521
St. Vincent and the Grenadines	General Support	toll-free: 1-877-270-4609
Singapore (Singapore)	Technical Support	toll-free: 800 6011 051
International Access Code: 005	Customer Service (Penang, Malaysia)	604 633 4949
Country Code: 65	Transaction Sales	toll-free: 800 6011 054
	Corporate Sales	toll-free: 800 6011 053
South Africa (Johannesburg)	Website: support.euro.dell.com	
International Access Code:	E-mail: dell_za_support@dell.com	
09/091	Technical Support	011 709 7710
Country Code: 27	Customer Care	011 709 7707
City Code: 11	Sales	011 709 7700
	Fax	011 706 0495
	Switchboard	011 709 7700
Southeast Asian and Pacific Countries	Customer Technical Support, Customer Service, and Sales (Penang, Malaysia)	604 633 4810

Country (City) International Access Code Country Code City Code	Department Name or Service Area, Website and E-Mail Address	Area Codes, Local Numbers, and Toll-Free Numbers
Spain (Madrid)	Website: support.euro.dell.com	
International Access Code: 00	E-mail: support.euro.dell.com/es/es/emaildell/	
Country Code: 34	Home and Small Business	
City Code: 91	Technical Support	902 100 130
	Customer Care	902 118 540
	Sales	902 118 541
	Switchboard	902 118 541
	Fax	902 118 539
	Corporate	
	Technical Support	902 100 130
	Customer Care	902 118 546
	Switchboard	91 722 92 00
	Fax	91 722 95 83
Sweden (Upplands Vasby)	Website: support.euro.dell.com	
International Access Code: 00	E-mail: swe_support@dell.com	
Country Code: 46	E-mail Support for Latitude and Inspiron: Swe-nbk_kats@dell.com	
City Code: 8	E-mail Support for OptiPlex: Swe_kats@dell.com	
	E-mail Support for Servers: Nordic_server_support@dell.com	
	Technical Support	08 590 05 199
	Relational Customer Care	08 590 05 642
	Home/Small Business Customer Care	08 587 70 527
	Employee Purchase Program (EPP) Support	20 140 14 44
	Fax Technical Support	08 590 05 594
	Sales	08 590 05 185

Country (City) International Access Code Country Code City Code	Department Name or Service Area, Website and E-Mail Address	Area Codes, Local Numbers, and Toll-Free Numbers
Switzerland (Geneva) International Access Code: 00 Country Code: 41 City Code: 22	Website: support.euro.dell.com E-mail: swisstech@dell.com E-mail for French-speaking HSB and Corporate Customers: support.euro.dell.com/ch/fr/emaildell/	
	Technical Support (Home and Small Business)	0844 811 411
	Technical Support (Corporate)	0844 822 844
	Customer Care (Home and Small Business)	0848 802 202
	Customer Care (Corporate)	0848 821 721
	Fax	022 799 01 90
	Switchboard	022 799 01 01
Taiwan International Access Code: 002 Country Code: 886	Technical Support (portable and desktop computers) Technical Support (servers) Transaction Sales Corporate Sales	toll-free: 00801 86 1011 toll-free: 0080 60 1256 toll-free: 0080 651 228 or 0800 33 556 toll-free: 0080 651 227 or 0800 33 555
Thailand International Access Code: 001 Country Code: 66	Technical Support Customer Service (Penang, Malaysia) Sales	toll-free: 0880 060 07 604 633 4949 toll-free: 0880 060 09
Trinidad/Tobago	General Support	1-800-805-8035
Turks and Caicos Islands	General Support	toll-free: 1-866-540-3355

Country (City) International Access Code Country Code City Code	Department Name or Service Area, Website and E-Mail Address	Area Codes, Local Numbers, and Toll-Free Numbers
U.K. (Bracknell)	Website: support.euro.dell.com	
International Access Code: 00	Customer Care website: dell.co.uk/lca/customerservices	
Country Code: 44	E-mail: dell_direct_support@dell.com	
City Code: 1344	Technical Support (Corporate/Preferred Accounts/PAD [1000+ employees])	0870 908 0500
	Technical Support (direct/PAD and general)	0870 908 0800
	Global Accounts Customer Care	01344 373 185 or 01344 373 186
	Home and Small Business Customer Care	0870 906 0010
	Corporate Customer Care	0870 908 0500
	Preferred Accounts (500–5000 employees) Customer Care	01344 373 196
	Central Government Customer Care	01344 373 193
	Local Government & Education Customer Care	01344 373 199
	Health Customer Care	01344 373 194
	Home and Small Business Sales	0870 907 4000
	Corporate/Public Sector Sales	01344 860 456
Uruguay	General Support	toll-free: 000-413-598-2521

Country (City) International Access Code Country Code City Code	Department Name or Service Area, Website and E-Mail Address	Area Codes, Local Numbers, and Toll-Free Numbers
U.S.A. (Austin, Texas)	Automated Order-Status Service	toll-free: 1-800-433-9014
International Access Code: 011 Country Code: 1	AutoTech (portable and desktop computers) Consumer (Home and Home Office) Technical Support Customer Service DellNet™ Service and Support	toll-free: 1-800-247-9362 toll-free: 1-800-624-9896 toll-free: 1-800-624-9897 toll-free: 1-877-Dellnet (1-877-335-5638)
	Employee Purchase Program (EPP) Customers Financial Services website: www.dellfinancialservices.com Financial Services (lease/loans) Financial Services (Dell Preferred Accounts [DPA])	toll-free: 1-800-695-8133 toll-free: 1-877-577-3355 toll-free: 1-800-283-2210
	Business Customer Service and Technical Support Employee Purchase Program (EPP) Customers Projectors Technical Support	toll-free: 1-800-822-8965 toll-free: 1-800-695-8133 toll-free: 1-877-459-7298
	Public (government, education, and healthcare) Customer Service and Technical Support Employee Purchase Program (EPP) Customers Dell Sales	toll-free: 1-800-456-3355 toll-free: 1-800-234-1490 toll-free: 1-800-289-3355 or toll-free: 1-800-879-3355
	Dell Outlet Store (Dell refurbished computers) Software and Peripherals Sales Spare Parts Sales Extended Service and Warranty Sales Fax Dell Services for the Deaf, Hard-of-Hearing, or Speech-Impaired	toll-free: 1-888-798-7561 toll-free: 1-800-671-3355 toll-free: 1-800-357-3355 toll-free: 1-800-247-4618 toll-free: 1-800-727-8320 toll-free: 1-877-DELLTTY (1-877-335-5889)
U.S. Virgin Islands	General Support	1-877-673-3355
Venezuela	General Support	8001-3605

FILE LOCATION: S:\SYSTEMS\Pebble\UG\A00\English\gethelp.fm

DELL CONFIDENTIAL – PRELIMINARY 1/29/03 – FOR PROOF ONLY

SECTION 22

Specifications

Microprocessor
System Information
PC Card
Smart Card
Memory
Ports and Connectors
Communications
Video
Audio
Display
Keyboard
Touch Pad
Track Stick
Battery
AC Adapter
Physical
Environmental

FILE LOCATION: S:\SYSTEMS\Pebble\UG\A00\English\specs.fm

Microprocessor

Microprocessor type	Intel® Centrino™ Mobile Technology or Intel Pentium® M
L1 cache	32 KB instruction and 32 KB write-back data cache
L2 cache	1 MB
External bus frequency	400 MHz, source synchronous processor system bus

System Information

System chip set	Intel 855GM
Flash EPROM	1 MBit
Data bus width	64 bits
Microprocessor address bus width	32 bits
PCI bus	32 bits

PC Card

CardBus controller	TI PCI7510 Cardbus controller
PC Card connector	supports one Type I or Type II card
Cards supported	3.3 V and 5 V
PC Card connector size	68 pins
Data width (maximum)	PCMCIA 16 bits CardBus 32 bits

Smart Card

Read/write capabilities	reads and writes to all ISO 7816 1/2/3/4 microprocessor cards (T=0, T=1)
Cards supported	3V and 5V
Program technology supported	Java cards
Interface speed	9600–115,200 BPS
EMV level	level 1 certified

DELL CONFIDENTIAL – PRELIMINARY 1/29/03 – FOR PROOF ONLY

Smart Card *(continued)*

WHQL certification	PC/SC
Compatibility	compatible within a PKI environment
Insert/eject cycles	certified for up to 100,000 cycles

Memory

Memory module connector	two user-accessible DDR SDRAM sockets
Memory module capacities	128, 256, 512, and 1024 MB
Memory type	2.5 V 266 MHz DDR SDRAM
Standard memory	128 MB
Maximum memory	2048 MB

Ports and Connectors

Serial	9-pin connector; 16550C-compatible, 16-byte buffer connector
Video	15-hole connector
Audio	microphone connector, stereo headphone/speakers connector
USB	two 4-pin USB 2.0-compliant connectors (including the Dell™ D/Bay connector)
Dell™ D/Bay connector	4-pin power supply and 4-pin USB 2.0-compliant connector
Infrared	sensor compatible with IrDA Standard 1.1 (Fast IR) and IrDA Standard 1.0 (Slow IR)
Mini PCI	Type IIIA Mini PCI card slot
Modem	RJ-11 port
Network adapter	RJ-45 port
IEEE 1394	4-pin serial connector

Communications

Modem:

Communications *(continued)*

Type	v.92 56K MDC
Controller	softmodem
Interface	internal AC'97 bus
Network adapter	10/100/1000 Ethernet LAN on system board
Wireless	Internal Mini PCI Wi-Fi and Bluetooth™ wireless support (optional)

Video

Video type	Intel UMA integrated
Video controller	855GM chip set
Video memory	1 MB with Intel DVM T up to 32 MB (with 128 MB of system memory) or 64 MB (with 256 MB or more of system memory)
LCD interface	LVDS

Audio

Audio controller	AC'97 (Soft Audio)
Stereo conversion	18-bit (analog-to-digital and digital-to-analog)
Interfaces:	
Internal	AC'97
External	microphone-in connector, stereo headphones/speakers connector
Speaker	one 8-ohm speaker
Internal speaker amplifier	1.2-W channel into 8 ohms
Volume controls	keyboard shortcuts, program menus

Display

Type (active-matrix TFT)	XGA
Dimensions:	

Display *(continued)*

Height	214.3 mm (8.4 inches)
Width	285.7 mm (11.3 inches)
Diagonal	357.1 mm (14.1 inches)
Maximum resolutions	1024 x 768 at 256 K (or 262,144) colors
Response time (typical)	20-ms rise (maximum), 30-ms fall (maximum)
Refresh rate	60 Hz
Operating angle	0° (closed) to 180°
Viewing angles:	
Horizontal	± 40°
Vertical	+ 10°/-30°
Pixel pitch	0.28 x 0.28 mm
Power Consumption:	
Panel with backlight (typical)	6.5 W
Controls	brightness can be controlled through keyboard shortcuts

Keyboard

Number of keys	87 (U.S. and Canada); 88 (Europe); 89 (Brazil); 91 (Japan)
Layout	QWERTY/AZERTY/Kanji

Touch Pad

X/Y position resolution (graphics table mode)	240 cpi
Size:	
Width	64.88 mm (2.55-inch) sensor-active area
Height	48.88-mm (1.92-inch) rectangle

Track Stick

X/Y position resolution (graphics table mode)	250 count/sec @ 100 gf
Size	protrudes higher than surrounding keycaps

Battery

Type	6-cell "smart" lithium ion (42 WHr) 4-cell "smart" lithium ion (27 WHr)
------	--

Dimensions:

Depth	88.5 mm (3.48 inches)
Height	21.5 mm (0.83 inch)
Width	139.0 mm (5.47 inches)

Weight	0.32 kg (0.7 lb) (6 cell) 0.26 kg (0.57 lb) (4 cell)
--------	---

Voltage	14.8 VDC (4 cell); 11.1 VDC (6 cell)
---------	--------------------------------------

Charge time (approximate):

Computer on	2.5 hours
Computer off	1 hour

Operating time	varies depending on operating conditions; can be significantly reduced under certain power-intensive conditions See " Using a Battery " for more information on battery life.
----------------	---

Life span (approximate)	300 full discharge/charge cycles
-------------------------	----------------------------------

Temperature range:

Operating	0° to 35°C (32° to 95°F)
Storage	-40° to 65°C (-40° to 149°F)

AC Adapter

Input voltage	90–264 VAC
Input current (maximum)	1.7 A

AC Adapter (continued)

Input frequency	47–63 Hz
Output current	5.5 A (maximum at 4-second pulse); 4.5 A (continuous)
Output power	90 W or 65 W
Rated output voltage	19.5 VDC
Dimensions:	
Height	27.94 mm (1.1 inches)
Width	58.42 mm (2.3 inches)
Depth	133.85 mm (5.25 inches)
Weight (with cables)	0.4 kg (0.9 lb)
Temperature range:	
Operating	0° to 35°C (32° to 95°F)
Storage	–40° to 65°C (–40° to 149°F)

Physical

Height	29.7 mm (1.17 inches)
Width	290 mm (11.42 inches)
Depth	242.5 mm (9.55 inches)

Weight:

Computer with 4-cell battery	1.7 kg (3.7 lb)
Dell D/Bay (alone)	256 g (0.56 lb)
CD drive (alone)	215 g (0.47 lb)

Environmental

Temperature range:

Operating	0° to 35°C (32° to 95°F)
Storage	–40° to 65°C (–40° to 149°F)

Relative humidity (maximum):

Environmental (*continued*)

Operating 10% to 90% (noncondensing)

Storage 5% to 95% (noncondensing)

Maximum vibration (using a random-vibration spectrum that simulates user environment):

Operating 0.9 GRMS

Storage 1.3 GRMS

Maximum shock (measured with hard drive in head-parked position and a 2-ms half-sine pulse):

Operating 122 G

Storage 163 G

Altitude (maximum):

Operating -15.2 to 3048 m (-50 to 10,000 ft)

Storage -15.2 to 10,668 m (-50 to 35,000 ft)

SECTION 23

Appendix

FILE LOCATION: S:\SYSTEMS\Pebble\UG\A00\English\appendix.fm

DELL CONFIDENTIAL – PRELIMINARY 1/29/03 – FOR PROOF ONLY

Ergonomic Computing Habits

 CAUTION: Improper or prolonged keyboard use may result in injury.

 CAUTION: Viewing the display or external monitor screen for extended periods of time may result in eye strain.

For comfort and efficiency, observe the following ergonomic guidelines when setting up and using your computer workstation:

- Position your computer directly in front of you as you work.
- Adjust the tilt of the computer's display, its contrast and/or brightness settings, and the lighting around you (such as overhead lights, desk lamps, and the curtains or blinds on nearby windows) to minimize reflections and glare on the display.
- When using an external monitor with your computer, set the monitor at a comfortable viewing distance (usually 450 to 610 millimeters [18 to 24 inches] from your eyes). Make sure the monitor screen is at eye level or slightly lower when you are sitting in front of the monitor.
- Use a chair that provides good lower-back support.
- Keep your forearms horizontal with your wrists in a neutral, comfortable position while using the keyboard, touch pad, track stick, or external mouse.
- Always use the palm rest with the keyboard, touch pad, or track stick. Leave space to rest your hands when using an external mouse.
- Let your upper arms hang naturally at your sides.
- Ensure that your feet are resting flat on the floor.
- When sitting, make sure the weight of your legs is on your feet and not on the front of your chair seat. Adjust your chair's height or use a footrest, if necessary, to maintain proper posture.
- Vary your work activities. Try to organize your work so that you do not have to type for extended periods of time. When you stop typing, try to do things that use both hands.

For more information about ergonomic computing habits, see the BSR/HFES 100 standard, which can be purchased on the Human Factors and Ergonomics Society (HFES) website at:

www.hfes.org/publications/HFES100.htm

DELL CONFIDENTIAL – PRELIMINARY 1/29/03 – FOR PROOF ONLY

References:

1. American National Standards Institute. *ANSI/HFES 100: American National Standards for Human Factors Engineering of Visual Display Terminal Workstations*. Santa Monica, CA: Human Factors Society, Inc., 1988.
2. Human Factors and Ergonomics Society. *BSR/HFES 100 Draft standard for trial use: Human Factors Engineering of Computer Workstations*. Santa Monica, CA: Human Factors and Ergonomics Society, 2002.
3. International Organization for Standardization (ISO). *ISO 9241 Ergonomics requirements for office work with visual display terminals (VDTs)*. Geneva, Switzerland: International Organization for Standardization, 1992.

Regulatory Notices

Electromagnetic Interference (EMI) is any signal or emission, radiated in free space or conducted along power or signal leads, that endangers the functioning of a radio navigation or other safety service or seriously degrades, obstructs, or repeatedly interrupts a licensed radio communications service. Radio communications services include but are not limited to AM/FM commercial broadcast, television, cellular services, radar, air-traffic control, pager, and Personal Communication Services (PCS). These licensed services, along with unintentional radiators such as digital devices, including computers, contribute to the electromagnetic environment.

Electromagnetic Compatibility (EMC) is the ability of items of electronic equipment to function properly together in the electronic environment. While this computer has been designed and determined to be compliant with regulatory agency limits for EMI, there is no guarantee that interference will not occur in a particular installation. If this equipment does cause interference with radio communications services, which can be determined by turning the equipment off and on, you are encouraged to try to correct the interference by one or more of the following measures:

- Reorient the receiving antenna.
- Relocate the computer with respect to the receiver.

- Move the computer away from the receiver.
- Plug the computer into a different outlet so that the computer and the receiver are on different branch circuits.

If necessary, consult a Dell Technical Support representative or an experienced radio/television technician for additional suggestions.

Dell™ computers are designed, tested, and classified for their intended electromagnetic environment. These electromagnetic environment classifications generally refer to the following harmonized definitions:

- Class A is typically for business or industrial environments.
- Class B is typically for residential environments.

Information Technology Equipment (ITE), including devices, expansion cards, printers, input/output (I/O) devices, monitors, and so on, that are integrated into or connected to the computer should match the electromagnetic environment classification of the computer.

A Notice About Shielded Signal Cables: Use only shielded cables for connecting devices to any Dell device to reduce the possibility of interference with radio communications services. Using shielded cables ensures that you maintain the appropriate EMC classification for the intended environment. For parallel printers, a cable is available from Dell. If you prefer, you can order a cable from Dell on the World Wide Web at accessories.us.dell.com/sna/category.asp?category_id=4117.

Most Dell computers are classified for Class B environments. However, the inclusion of certain options can change the rating of some configurations to Class A. To determine the electromagnetic classification for your computer or device, see the following sections specific for each regulatory agency. Each section provides country-specific EMC/EMI or product safety information.

FCC Notices (U.S. Only)

Most Dell computers are classified by the Federal Communications Commission (FCC) as Class B digital devices. To determine which classification applies to your computer, examine all FCC registration labels located on the bottom, side, or back panel of your computer, on card-mounting brackets, and on the cards themselves. If any one of the labels carries a Class A rating, your entire computer is considered to be a Class A digital device. If *all* labels carry an FCC Class B rating as distinguished by either an FCC ID number or the FCC logo, (FCC), your computer is considered to be a Class B digital device.

Once you have determined your computer's FCC classification, read the appropriate FCC notice. Note that FCC regulations provide that changes or modifications not expressly approved by Dell could void your authority to operate this equipment.

This device complies with Part 15 of the FCC Rules. Operation is subject to the following two conditions:

- This device may not cause harmful interference.
- This device must accept any interference received, including interference that may cause undesired operation.

Class A

This equipment has been tested and found to comply with the limits for a Class A digital device pursuant to Part 15 of the FCC Rules. These limits are designed to provide reasonable protection against harmful interference when the equipment is operated in a commercial environment. This equipment generates, uses, and can radiate radio frequency energy and, if not installed and used in accordance with the manufacturer's instruction manual, may cause harmful interference with radio communications. Operation of this equipment in a residential area is likely to cause harmful interference, in which case you will be required to correct the interference at your own expense.

Class B

This equipment has been tested and found to comply with the limits for a Class B digital device pursuant to Part 15 of the FCC Rules. These limits are designed to provide reasonable protection against harmful interference in a residential installation. This equipment generates, uses, and can radiate radio frequency energy and, if not installed and used in accordance with the manufacturer's instruction manual, may cause interference with radio communications. However, there is no guarantee that interference will not occur in a particular installation. If this equipment does cause harmful interference to radio or television reception, which can be determined by turning the equipment off and on, you are encouraged to try to correct the interference by one or more of the following measures:

- Reorient or relocate the receiving antenna.
- Increase the separation between the equipment and the receiver.
- Connect the equipment into an outlet on a circuit different from that to which the receiver is connected.
- Consult the dealer or an experienced radio/television technician for help.

FCC Identification Information

The following information is provided on the device or devices covered in this document in compliance with FCC regulations:

- Model number: PPT
- Company name:

Dell Computer Corporation
One Dell Way
Round Rock, Texas 78682 USA
512-338-4400

Modem Regulatory Information

This equipment complies with Part 68 of the FCC Rules. On the bottom of your computer is a label that contains, among other information, the FCC registration number and ringer equivalence number (REN) for your equipment. If requested, you must provide this information to the telephone company.

The REN is used to determine the quantity of devices that may be connected to the telephone line. Excessive RENs on the telephone line may result in the devices not ringing in response to an incoming call. In most areas, the sum of all the RENs on your telephone line should be less than five to ensure proper service from the telephone company. To be certain of the number of devices that you may connect to a line, as determined by the total RENs, contact your local telephone company.

The registration jack Universal Service Order Code (USOC) used by this equipment is RJ-11C. An FCC compliant telephone cord and modular plug is provided with this equipment. This equipment is designed to be connected to the telephone network or premises wiring using a compatible modular jack that is Part 68 compliant.

This equipment cannot be used on public coin-phone service provided by the telephone company. Connection to party line service is subject to state tariffs.

There are no user serviceable parts on the modem contained in your computer.

If your telephone equipment causes harm to the telephone network, the telephone company will notify you in advance that service may be temporarily discontinued. If advance notice is not practical, the telephone company will notify you as soon as possible. Also, you will be advised of your right to file a complaint with the FCC if you believe it is necessary.

The telephone company may make changes in its facilities, equipment, operations, or procedures that could affect the operation of this equipment. If this happens, the telephone company will provide advance notice in order for you to make necessary modifications to maintain uninterrupted service.

If you experience trouble with this telephone equipment, see "[Contacting Dell](#)" to find the appropriate telephone number for obtaining customer assistance. If the equipment is causing harm to the telephone network, the telephone company may request that you disconnect the equipment until the problem is resolved.

Fax Branding

The Telephone Consumer Protection Act of 1991 makes it unlawful for any person to use a computer or other electronic device, including fax machines, to send any message unless such message clearly contains in a margin at the top or bottom of each transmitted page or on the first page of the transmission, the date and time it is sent, identification of the business, other entity, or individual sending the message, and the telephone number of the sending machine or such business, other entity, or individual. The telephone number provided may not be a 900 number or any other number for which charges exceed local or long-distance transmission charges.

IC Notice (Canada Only)

Most Dell computers (and other Dell digital apparatus) are classified by the Industry Canada (IC) Interference-Causing Equipment Standard #3 (ICES-003) as Class B digital devices. To determine which classification (Class A or B) applies to your computer (or other Dell digital apparatus), examine all registration labels located on the bottom, side, or the back panel of your computer (or other digital apparatus). A statement in the form of "IC Class A ICES-003" or "IC Class B ICES-003" will be located on one of these labels. Note that Industry Canada regulations provide that changes or modifications not expressly approved by Dell could void your authority to operate this equipment.

This Class B (or Class A, if so indicated on the registration label) digital apparatus meets the requirements of the Canadian Interference-Causing Equipment Regulations.

Cet appareil numérique de la Classe B (ou Classe A, si ainsi indiqué sur l'étiquette d'enregistrement) respecte toutes les exigences du Règlement sur le Matériel Brouilleur du Canada.

Modem Regulatory Information

The IC label identifies certified equipment. This certification means that the equipment meets telecommunications network protective, operational, and safety requirements as prescribed in the appropriate Terminal Equipment Technical Requirements document(s). The IC label does not guarantee that the equipment will operate to the user's satisfaction.

Before installing this equipment, users should ensure that it is permissible to be connected to the facilities of the local telecommunications company. The equipment must also be installed using an acceptable method of connection. The customer should be aware that compliance with the above conditions may not prevent degradation of service in some situations.

Repairs to certified equipment should be coordinated by a representative designated by the supplier. Any repairs or alteration made by a user to this equipment, or equipment malfunctions, may give the telephone communications company cause to request the user to disconnect the equipment.

Users should ensure for their own protection, that the electrical ground connections of the power utility, telephone lines, and internal metallic water-pipe system, if present, are connected together. This precaution may be particularly important in rural areas.



NOTICE: Users should not attempt to make such connections themselves. Contact the appropriate electric inspection authority, or electrician, as appropriate.

NOTE: The REN assigned to each terminal device provides an indication of the maximum number of terminals allowed to be connected to a telephone interface. The termination on an interface may consist of any combination of devices subject only to the requirement that the sum of the RENs of all the devices does not exceed the number five.

The REN for the internal modem as stated on the IC regulatory label located on the bottom of the computer is 0.6 B.

The following information is provided in compliance with IC regulations:

Dell Computer Corporation
One Dell Way
Round Rock, TX 78682 USA
512-338-4400

CE Notice (European Union)

Marking by the symbol **CE** indicates compliance of this Dell computer to the EMC Directive and the Low Voltage Directive of the European Union. Such marking is indicative that this Dell system meets the following technical standards:

- EN 55022 — "Information Technology Equipment — Radio Disturbance Characteristics — Limits and Methods of Measurement."
- EN 55024 — "Information Technology Equipment - Immunity Characteristics - Limits and Methods of Measurement."
- EN 61000-3-2 — "Electromagnetic Compatibility (EMC) - Part 3: Limits - Section 2: Limits for Harmonic Current Emissions (Equipment Input Current Up to and Including 16 A Per Phase)."
- EN 61000-3-3 — "Electromagnetic Compatibility (EMC) - Part 3: Limits - Section 3: Limitation of Voltage Fluctuations and Flicker in Low-Voltage Supply Systems for Equipment With Rated Current Up to and Including 16 A."
- EN 60950 — "Safety of Information Technology Equipment."

NOTE: EN 55022 emissions requirements provide for two classifications:

- Class A is for typical commercial areas.
- Class B is for typical domestic areas.

This Dell device is classified for use in a typical Class B domestic environment.

A "Declaration of Conformity" in accordance with the preceding directives and standards has been made and is on file at Dell Computer Corporation Products Europe BV, Limerick, Ireland.

CE Mark Notice

This equipment complies with the essential requirements of the European Union Directive 1999/5/EC.

Cet équipement est conforme aux principales caractéristiques définies dans la Directive européenne RTTE 1999/5/CE.

Die Geräte erfüllen die grundlegenden Anforderungen der RTTE-Richtlinie (1999/5/EG).

Questa apparecchiatura è conforme ai requisiti essenziali della Direttiva Europea R&TTE 1999/5/CE.

Este equipo cumple los requisitos principales de la Directiva 1999/5/CE de la UE, "Equipos de Terminales de Radio y Telecomunicaciones".

Este equipamento cumpre os requisitos essenciais da Directiva 1999/5/CE do Parlamento Europeu e do Conselho (Directiva RTT).

Ο εξοπλισμός αυτός πληροί τις βασικές απαιτήσεις της κοινής οδηγίας EU R&TTE 1999/5/EK.

Deze apparatuur voldoet aan de noodzakelijke vereisten van EU-richtlijn betreffende radioapparatuur en telecommunicatie-eindapparatuur 1999/5/EG.

Dette udstyr opfylder de væsentlige krav i EU's direktiv 1999/5/EC om Radio- og teleterminaludstyr.

Dette utstyret er i overensstemmelse med hovedkravene i R&TTE-direktivet (1999/5/EC) fra EU.

Utrustningen uppfyller kraven för EU-direktivet 1999/5/EC om ansluten teleutrustning och ömsesidigt erkännande av utrustningens överensstämmelse (R&TTE).

Tämä laite vastaa EU:n radio- ja telepäätelaitedirektiivin (EU R&TTE Directive 1999/5/EC) vaatimuksia.

New Zealand Telecom Warnings

General

"The grant of a Telepermit for any item of terminal equipment indicates only that Telecom has accepted that the item complies with minimum conditions for connection to its network. It indicates no endorsement of the product by Telecom, nor does it provide any sort of warranty. Above all, it provides no assurance that any item will work correctly in all respects with another item of Telepermitted equipment of a different make or model, nor does it imply that any product is compatible with all of Telecom's network services."

"This equipment does not fully meet Telecom impedance requirements. Performance limitations may occur when used in conjunction with some parts of the network. Telecom will accept no responsibility should difficulties arise in such circumstances."

"This equipment shall not be set up to make automatic calls to the Telecom '111' Emergence Service."

"If a charge for local calls is unacceptable, the 'Dial' button should NOT be used for local calls. Only the 7-digits of the local number should be dialed from your telephone. DO NOT dial the area code digit or the '0' prefix."

"This equipment may not provide for the effective hand-over of a call to another device connected to the same line."

Important Notice

"Under power failure conditions, this telephone may not operate. Please ensure that a separate telephone, not dependent on local power, is available for emergency use."

"Some parameters required for compliance with Telecom's Telepermit requirements are dependent on the equipment (PC) associated with this device. The associated equipment shall be set to operate within the following limits for compliance with Telecom's Specification:

- 1 There shall be no more than 10 call attempts to the same number within any 30-minute period for any single manual call initiation, and the equipment shall go on-hook for a period of not less than 30 seconds between the end of one attempt and the beginning of the next attempt.
- 2 Where automatic calls are made to different numbers, the equipment shall go on-line for a period of not less than 5 seconds between the end of one attempt and the beginning of the next attempt.
- 3 The equipment shall be set to ensure that calls are answered between 3 and 30 seconds of receipt of ringing."

"All persons using this device for recording telephone conversations shall comply with New Zealand law. This requires that at least one party to the conversation is to be aware that it is being recorded. In addition, the Principles enumerated in the Privacy Act of 1993 shall be complied with in respect to the nature of the personal information collected, the purpose for its collection, how it is used and what is disclosed to any other party."

ENERGY STAR® Compliance

Certain configurations of Dell computers comply with the requirements set forth by the Environmental Protection Agency (EPA) for energy-efficient computers. If the front panel of your computer bears the ENERGY STAR® Emblem, your original configuration complies with these requirements and all ENERGY STAR® power management features of the computer are enabled.

NOTE: Any Dell computer bearing the ENERGY STAR® Emblem is certified to comply with EPA ENERGY STAR® requirements as configured when shipped by Dell. Any changes you make to this configuration (such as installing additional expansion cards or drives) may increase the computer's power consumption beyond the limits set by the EPA's ENERGY STAR® Computers program.

ENERGY STAR® Emblem



The EPA's ENERGY STAR® Computers program is a joint effort between the EPA and computer manufacturers to reduce air pollution by promoting energy-efficient computer products. The EPA estimates that use of ENERGY STAR® computer products can save computer users up to two billion dollars annually in electricity costs. In turn, this reduction in electricity usage can reduce emissions of carbon dioxide, the gas primarily responsible for the greenhouse effect, and sulfur dioxide and nitrogen oxides, the primary causes of acid rain.

You can also help reduce electricity usage and its side effects by turning off your computer when it is not in use for extended periods of time, particularly at night and on weekends.

Simplified Chinese Class A Warning Notice (China Only)

On Class A systems, the following warning will appear near the regulatory label:

Warning: This is a Class A product. In a domestic environment this product may cause radio interference, in which case the user may be required to take adequate measures.

声明

此为 A 级产品，在生活环境中，该产品可能会造成无线电干扰。在这种情况下，可能需要用户对其干扰采取切实可行的措施。

EN 55022 Compliance (Czech Republic Only)

This device belongs to Class B devices as described in EN 55022, unless it is specifically stated that it is a Class A device on the specification label. The following applies to devices in Class A of EN 55022 (radius of protection up to 30 meters). The user of the device is obliged to take all steps necessary to remove sources of interference to telecommunication or other devices.

Pokud není na typovém štítku počítače uvedeno, že spadá do třídy A podle EN 55022, spadá automaticky do třídy B podle EN 55022. Pro zařízení zařazená do třídy A (ochranné pásmo 30m) podle EN 55022 platí následující. Dojde-li k rušení telekomunikačních nebo jiných zařízení, je uživatel povinen provést taková opatření, aby rušení odstranil.

VCCI Notice (Japan Only)

Most Dell computers are classified by the Voluntary Control Council for Interference (VCCI) as Class B information technology equipment (ITE). However, the inclusion of certain options can change the rating of some configurations to Class A. ITE, including devices, expansion cards, printers, input/output (I/O) devices, monitors, and so on, integrated into or connected to the computer should match the electromagnetic environment classification (Class A or B) of the computer.

To determine which classification applies to your computer, examine the regulatory labels/markings (see "VCCI Class A ITE Regulatory Mark" and "VCCI Class B ITE Regulatory Mark") located on the bottom, side, or back panel of your computer. Once you have determined your computer's VCCI classification, read the appropriate VCCI notice.

Class A ITE

この装置は、情報処理装置等電波障害自主規制協議会 (VCCI) の基準に基づくクラス A 情報技術装置です。この装置を家庭環境で使用すると電波妨害を引き起こすことがあります。この場合には使用者が適切な対策を講ずるよう要求されることがあります。

This is a Class A product based on the standard of the Voluntary Control Council for Interference (VCCI) for information technology equipment. If this equipment is used in a domestic environment, radio disturbance may arise. When such trouble occurs, the user may be required to take corrective actions.

VCCI Class A ITE Regulatory Mark

If the regulatory label includes the following marking, your computer is a Class A product:

VCCI

Class B ITE

この装置は、情報処理装置等電波障害自主規制協議会 (VCCI) の基準に基づくクラス B 情報技術装置です。この装置は家庭環境で使用することを目的としていますが、ラジオやテレビジョン受信機に近接して使用されると、受信障害を引き起こすことがあります。取扱説明書に従って正しい取り扱いをしてください。

This is a Class B product based on the standard of the Voluntary Control Council for Interference (VCCI) for information technology equipment. If this equipment is used near a radio or television receiver in a domestic environment, it may cause radio interference. Install and use the equipment according to the instruction manual.

VCCI Class B ITE Regulatory Mark

If the regulatory label includes the following marking, your computer is a Class B product:

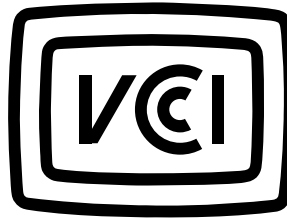

MIC Notice (Republic of Korea Only)

To determine which classification (Class A or B) applies to your computer (or other Dell digital device), examine the Republic of Korean Ministry of Information and Communications (MIC) registration labels located on your computer (or other Dell digital device). The MIC label may be located separately from the other regulatory marking applied to your product. Line two of the label identifies the emissions class for the product—"A" for Class A products or "B" for Class B products.

NOTE: MIC emissions requirements provide for two classifications:

- Class A devices are for business purposes.
- Class B devices are for nonbusiness purposes.

Class A Device

기종별	사용자안내문
A급 기기 (업무용 정보통신기기)	이 기기는 업무용으로 전자파적합등록을 한 기기이오니 판매자 또는 사용자는 이 점을 주의하시기 바라며 만약 잘못 판매 또는 구입하였을 때에는 가정용으로 교환하시기 바랍니다.

Please note that this device has been approved for business purposes with regard to electromagnetic interference. If you find that this device is not suitable for your use, you may exchange it for a nonbusiness-purpose device.

MIC Class A Regulatory Label

If the regulatory label includes the following marking, your computer is a Class A product:



1. 기기의 명칭(모델명):
2. 인증번호:(A)
3. 인증받은 자의 상호:
4. 제조년월일:
5. 제조자/제조국가:

Class B Device

기종별	사용자 안내문
B급 기기 (가정용 정보통신기기)	이 기기는 가정용으로 전자파적합등록을 한 기기로서 주거지역에서는 물론 모든 지역에서 사용할 수 있습니다.

Please note that this device has been approved for nonbusiness purposes and may be used in any environment, including residential areas.

MIC Class B Regulatory Label

If the regulatory label includes the following marking, your computer is a Class B product.



명칭/모델명: 노트북 컴퓨터/PPT (Latitude D400)
인증 번호:
인증받은 자의 상호: 델 컴퓨터(주)
제조년월일:
제조자/제조국:Dell Computer (China) Co. Ltd. / 중국

Polish Center for Testing and Certification Notice

The equipment should draw power from a socket with an attached protection circuit (a 3-prong socket). All equipment that works together (computer, monitor, printer, and so on) should have the same power supply source.

The phasing conductor of the room's electrical installation should have a reserve short-circuit protection device in the form of a fuse with a nominal value no larger than 16 amperes (A).

To completely switch off the equipment, the power supply cable must be removed from the power supply socket, which should be located near the equipment and easily accessible.

A protection mark "B" confirms that the equipment is in compliance with the protection usage requirements of standards PN-93/T-42107 and PN-EN 55022.

Wymagania Polskiego Centrum Badań i Certyfikacji

Urządzenie powinno być zasilane z gniazda z przyłączonym obwodem ochronnym (gniazdo z kołkiem). Współpracujące ze sobą urządzenia (komputer, monitor, drukarka) powinny być zasilane z tego samego źródła.

Instalacja elektryczna pomieszczenia powinna zawierać w przewodzie fazowym rezerwową ochronę przed zwarciami, w postaci bezpiecznika o wartości znamionowej nie większej niż 16A (amperów).



W celu całkowitego wyłączenia urządzenia z sieci zasilania, należy wyjąć wtyczkę kabla zasilającego z gniazdko, które powinno znajdować się w pobliżu urządzenia i być łatwo dostępne. Znak bezpieczeństwa "B" potwierdza zgodność urządzenia z wymaganiami bezpieczeństwa użytkownika zawartymi w PN-EN 60950:2000 i PN-EN 55022:2000.

Jeżeli na tabliczce znamionowej umieszczono informację, że urządzenie jest klasy A, to oznacza to, że urządzenie w środowisku mieszkalnym może powodować zakłócenia radioelektryczne. W takich przypadkach można żądać od jego użytkownika zastosowania odpowiednich środków zaradczych.

Pozostałe instrukcje bezpieczeństwa

- Nie należy używać wtyczek adapterowych lub usuwać kołka obwodu ochronnego z wtyczki. Jeżeli konieczne jest użycie przedłużacza to należy użyć przedłużacza 3-żyłowego z prawidłowo połączonym przewodem ochronnym.
- System komputerowy należy zabezpieczyć przed nagłymi, chwilowymi wzrostami lub spadkami napięcia, używając eliminatora przepięć, urządzenia dopasowującego lub bezzakłócenowego źródła zasilania.
- Należy upewnić się, aby nic nie leżało na kablach systemu komputerowego, oraz aby kable nie były umieszczone w miejscu, gdzie można byłoby na nie nadeptywać lub potykać się o nie.
- Nie należy rozlewać napojów ani innych płynów na system komputerowy.
- Nie należy wpychać żadnych przedmiotów do otworów systemu komputerowego, gdyż może to spowodować pożar lub porażenie prądem, poprzez zwarcie elementów wewnętrznych.
- System komputerowy powinien znajdować się z dala od grzejników i źródeł ciepła. Ponadto, nie należy blokować otworów wentylacyjnych. Należy unikać kładzenia luźnych papierów pod komputer oraz umieszczania komputera w ciasnym miejscu bez możliwości cyrkulacji powietrza wokół niego.

BSMI Notice (Taiwan Only)

If you find a  or  mark on the regulatory

label on the bottom, side, or back panel of your computer, the following section is applicable:

BSMI 通告 (僅限於台灣)

大多數的 Dell 電腦系統被 BSMI (經濟部標準檢驗局) 劃分為乙類數位裝置。但是，使用某些選件會使有些組態的等級變成甲類。若要確定您的電腦系統適用等級，請檢查所有位於電腦底部或背面板、擴充卡安裝托架，以及擴充卡上的 BSMI 註冊標籤。如果其中有一甲類標籤，即表示您的系統為甲類數位裝置。如果只有 BSMI 的檢磁號碼標籤，則表示您的系統為乙類數位裝置。

一旦確定了系統的 BSMI 等級，請閱讀相關的 BSMI 通告。請注意，BSMI 通告規定凡是未經 Dell Computer Corporation 明確批准的擅自變更或修改，將導致您失去此設備的使用權。

此裝置符合 BSMI (經濟部標準檢驗局) 的規定，使用時須符合以下兩項條件：

- 此裝置不會產生有害干擾。
- 此裝置必須能接受所接收到的干擾，包括可能導致無法正常作業的干擾。

甲類

此設備經測試證明符合 BSMI (經濟部標準檢驗局) 之甲類數位裝置的限制規定。這些限制的目的是為了在商業環境中使用此設備時，能提供合理的保護以防止有害的干擾。此設備會產生、使用並散發射頻能量；如果未遵照製造廠商的指導手冊來安裝和使用，可能會干擾無線電通訊。請勿在住宅區使用此設備。

警告使用者：

這是甲類的資訊產品，在居住的環境中使用時，可能會造成射頻干擾，在這種情況下，使用者會被要求採取某些適當的對策。

乙類

此設備經測試證明符合 BSM (經濟部標準檢驗局) 之乙類數位裝置的限制規定。這些限制的目的是為了在住宅區安裝時，能防止有害的干擾，提供合理的保護。此設備會產生、使用並散發射頻能量；如果未遵照製造廠商的指導手冊來安裝和使用，可能會干擾無線電通訊。但是，這並不保證在個別的安裝中不會產生干擾。您可以透過關閉和開啓此設備來判斷它是否會對廣播和電視收訊造成干擾；如果確實如此，我們建議您嘗試以下列一種或多種方法來排除干擾：

- 重新調整天線的接收方向或重新放置接收天線。
- 增加設備與接收器的距離。
- 將設備連接至不同的插座，使設備與接收器連接在不同的電路上。
- 請向經銷商或有經驗的無線電/電視技術人員查詢，以獲得幫助。

NOM Information (Mexico Only)

The following information is provided on the device(s) described in this document in compliance with the requirements of the official Mexican standards (NOM):

Exporter:	Dell Computer Corporation One Dell Way Round Rock, TX 78682
Importer:	Dell Computer de México, S.A. de C.V. Paseo de la Reforma 2620 - 11° Piso Col. Lomas Altas 11950 México, D.F.
Ship to:	Dell Computer de México, S.A. de C.V. al Cuidado de Kuehne & Nagel de México S. de R.I. Avenida Soles No. 55 Col. Peñon de los Baños 15520 México, D.F.
Model number:	PPT
Supply voltage:	100-240 VAC

Frequency:	50–60 Hz
Current Consumption:	1.5 A
Output voltage:	20 VDC
Output current:	4.6 A

Warranty and Return Policy

Dell Computer Corporation (“Dell”) manufactures its hardware products from parts and components that are new or equivalent to new in accordance with industry-standard practices. For information about the Dell warranty for your computer, see the *System Information Guide*.

SECTION 24

Glossary

FILE LOCATION: S:\SYSTEMS\Pebble\UG\A00\English\glossary.fm

DELL CONFIDENTIAL – PRELIMINARY 1/29/03 – FOR PROOF ONLY

Terms in this Glossary are provided for informational purposes only and may or may not describe features included with your particular computer.

A

AC — alternating current — The form of electricity that powers your computer when you plug the AC adapter power cable into an electrical outlet.

ACPI — advanced configuration and power interface — A power management specification that enables Microsoft® Windows® operating systems to put a computer in standby or hibernate mode to conserve the amount of electrical power allocated to each device attached to the computer.

AGP — accelerated graphics port — A dedicated graphics port that allows system memory to be used for video-related tasks. AGP delivers a smooth, true-color video image because of the faster interface between the video circuitry and the computer memory.

ANTIVIRUS SOFTWARE — A program designed to identify, quarantine, and/or delete viruses from your computer.

APR — advanced port replicator — A docking device that allows you to conveniently use a monitor, keyboard, mouse, and other devices with your portable computer.

ASF — alert standards format — A standard to define a mechanism for reporting hardware and software alerts to a management console. ASF is designed to be platform- and operating system-independent.

B

BACKUP — A copy of a program or data file on a floppy disk, CD, or hard drive. As a precaution, back up the data files from your hard drive regularly.

BATTERY — An internal power source used to operate portable computers when not connected to an AC adapter and an electrical outlet.

BATTERY LIFE SPAN — The length of time (years) during which a portable computer battery is able to be depleted and recharged.

BATTERY OPERATING TIME — The length of time (minutes or hours) that a portable computer battery holds a charge while powering the computer.

BIOS — basic input/output system — A program (or utility) that serves as an interface between the computer hardware and the operating system. Unless you understand what effect the settings have on the computer, do not change the settings for this program. Also referred to as the *system setup program*.

BIT — The smallest unit of data interpreted by your computer.

BLUETOOTH™ — A wireless technology standard for short-range (9 m [29 feet]) networking devices that allows for enabled devices to automatically recognize each other.

BOOT SEQUENCE — Specifies the order of the devices from which the computer attempts to boot.

BOOTABLE CD — A CD that you can use to start your computer. In case your hard drive is damaged or your computer has a virus, ensure that you always have a bootable CD or floppy disk available. Your *Drivers and Utilities* or Resource CD is a bootable CD.

BOOTABLE DISK — A disk that you can use to start your computer. In case your hard drive is damaged or your computer has a virus, ensure that you always have a bootable CD or floppy disk available.

BPS — bits per second — The standard unit for measuring data transmission speed.

BTU — British thermal unit — A measurement of heat output.

BUS — A communication pathway between the components in your computer.

BUS SPEED — The speed, given in MHz, that indicates how fast a bus can transfer information.

BYTE — The basic data unit used by your computer. A byte is usually equal to 8 bits.

C

C — Celsius — A temperature measurement system where 0° is the freezing point and 100° is the boiling point of water.

CACHE — A special high-speed storage mechanism which can be either a reserved section of main memory or an independent high-speed storage device. The cache enhances the efficiency of many microprocessor operations.

L1 cache — Primary cache stored inside the microprocessor.

L2 cache — Secondary cache which can either be external to the microprocessor or incorporated into the microprocessor architecture.

CARNET — An international customs document that facilitates temporary imports into foreign countries. Also known as a *merchandise passport*.

CD — compact disc — An optical form of storage media, typically used for audio and software programs.

CD DRIVE — A drive that uses optical technology to read data from CDs.

CD PLAYER — The software used to play music CDs. The CD player displays a window with buttons that you use to play a CD.

CD-R — CD recordable — A recordable version of a CD. Data can be recorded

only once onto a CD-R. Once recorded, the data cannot be erased or written over.

CD-RW — CD rewritable — A rewritable version of a CD. Data can be written to a CD-RW disc, and then erased and written over (rewritten).

CD-RW DRIVE — A drive that can read CDs and write to CD-RW (rewritable CDs) and CD-R (recordable CDs) discs. You can write to CD-RW discs multiple times, but you can write to CD-R discs only once.

CD-RW/DVD DRIVE — A drive, sometimes referred to as a combo drive, that can read CDs and DVDs and write to CD-RW (rewritable CDs) and CD-R (recordable CDs) discs. You can write to CD-RW discs multiple times, but you can write to CD-R discs only once.

CLOCK SPEED — The speed, given in MHz, that indicates how fast computer components that are connected to the system bus operate.

COA — Certificate of Authenticity — The Windows alpha-numeric code located on a sticker on your computer. You may need the COA to complete the operating system setup or reinstallation. Also referred to as the *Product Key* or *Product ID*.

CONTROL PANEL — A Windows utility that allows you to modify operating system and hardware settings, such as display settings.

CONTROLLER — A chip that controls the transfer of data between the microprocessor and memory or between the microprocessor and devices.

CRIMM — continuity rambus in-line memory module — A special module that has no memory chips and is used to fill unused RIMM slots.

CURSOR — The marker on a display or screen that shows where the next keyboard, touch pad, or mouse action will occur. It often is a blinking solid line, an underline character, or a small arrow.

D

DDR SDRAM — double-data-rate SDRAM — A type of SDRAM that doubles the data burst cycle, improving system performance.

DEVICE — Hardware such as a disk drive, printer, or keyboard that is installed in or connected to your computer.

DEVICE DRIVER — See *driver*.

DIN CONNECTOR — A round, six-pin connector that conforms to DIN (Deutsche Industrie-Norm) standards; it is typically used to connect PS/2 keyboard or mouse cable connectors.

DISK STRIPING — A technique for spreading data over multiple disk drives. Disk striping can speed up operations that retrieve data from disk storage. Computers that use disk striping generally allow the user to select the data unit size or stripe width.

DMA — direct memory access — A channel that allows certain types of data transfer between RAM and a device to bypass the microprocessor.

DOCKING DEVICE — See *APR*.

DMTF — Distributed Management Task Force — A consortium of hardware and software companies who develop management standards for distributed desktop, network, enterprise, and Internet environments.

DOMAIN — A group of computers, programs, and devices on a network that are administered as a unit with common rules and procedures for use by a specific group of users. A user logs on to the domain to gain access to the resources.

DRAM — dynamic random-access memory — Memory that stores information in integrated circuits containing capacitors.

DRIVER — Software that allows the operating system to control a device such as a printer. Many devices do not work properly if the correct driver is not installed in the computer.

DSL — Digital Subscriber Line — A technology that provides a constant, high-speed Internet connection through an analog telephone line.

DUAL DISPLAY MODE — A display setting that allows you to use a second monitor as an extension of your display. Also referred to as *extended display mode*.

DVD — digital versatile disc — A disc usually used to store movies. DVDs are double-sided, whereas CDs are single-sided. DVD drives read most CD media as well.

DVD DRIVE — A drive that uses optical technology to read data from DVDs and CDs.

DVD PLAYER — The software used to watch DVD movies. The DVD player displays a window with buttons that you use to watch a movie.

DVD+RW — DVD rewritable — A rewritable version of a DVD. Data can be written to a DVD+RW disc, and then erased and written over (rewritten). (DVD+RW technology is different from DVD-RW technology.)

DVD+RW DRIVE — A drive that can read DVDs and most CD media and write to DVD+RW (rewritable DVDs) discs.

DVI — digital video interface — A standard for digital transmission between a computer and a digital video display; the DVI adapter works through the computer's integrated graphics.

E

ECC — error checking and correction — A type of memory that includes special circuitry for testing the accuracy of data as it passes in and out of memory.

ECP — extended capabilities port — A parallel connector design that provides

improved bidirectional data transmission. Similar to EPP, ECP uses direct memory access to transfer data and often improves performance.

EIDE — enhanced integrated device electronics — An improved version of the IDE interface for hard drives and CD drives.

EMI — electromagnetic interference — Electrical interference caused by electromagnetic radiation.

ENERGY STAR® — Environmental Protection Agency requirements that decrease the overall consumption of electricity.

EPP — enhanced parallel port — A parallel connector design that provides bidirectional data transmission.

ESD — electrostatic discharge — A rapid discharge of static electricity. ESD can damage integrated circuits found in computer and communications equipment.

EXPANSION CARD — A circuit board that installs in an expansion slot on the system board in some computers, expanding the capabilities of the computer. Examples include video, modem, and sound cards.

EXPANSION SLOT — A connector on the system board (in some computers) where you insert an expansion card, connecting it to the system bus.

EXPRESS SERVICE CODE — A numeric code located on a sticker on your Dell™ computer. Use the Express Service Code when contacting Dell for assistance. Express Service Code service may not be available in some countries.

EXTENDED DISPLAY MODE — A display setting that allows you to use a second monitor as an extension of your display. Also referred to as *dual display mode*.

EXTENDED PC CARD — A PC Card that extends beyond the edge of the PC Card slot when installed.



NOTICE: Always remove an extended PC Card before packing the computer or traveling. If something strikes the exposed end of the PC Card, the system board may be damaged.



NOTE: If your computer has two PC Card connectors, always install extended PC Cards in the top connector.

F

FAHRENHEIT — A temperature measurement system where 32° is the freezing point and 212° is the boiling point of water.

FCC — Federal Communications Commission — A U.S. agency responsible for enforcing communications-related regulations that state how much radiation computers and other electronic equipment can emit.

FLOPPY DRIVE — A disk drive that can read and write to floppy disks.

FOLDER — A term used to describe space on a disk or drive where files are organized and grouped. Files in a folder can be viewed and ordered in various ways, such as alphabetically, by date, and by size.

FORMAT — The process that prepares a drive or disk for file storage. When a drive

or disk is formatted, the existing information on it is lost.

FSB — front side bus — The data path and physical interface between the microprocessor and RAM.

FTP — file transfer protocol — A standard Internet protocol used to exchange files between computers connected to the Internet.

G

G — gravity — A measurement of weight and force.

GB — gigabyte — A measurement of data storage that equals 1024 MB (1,073,741,824 bytes). When used to refer to hard drive storage, the term is often rounded to 1,000,000,000 bytes.

GHZ — gigahertz — A measurement of frequency that equals one thousand million Hz, or one thousand MHz. The speeds for computer microprocessors, buses, and interfaces are often measured in GHz.

GRAPHICS MODE — A video mode that can be defined as x horizontal pixels by y vertical pixels by z colors. Graphics modes can display an unlimited variety of shapes and fonts.

GUI — graphical user interface — Software that interacts with the user by means of menus, windows, and icons. Most programs that operate on the Windows operating systems are GUIs.

H

HARD DRIVE — A drive that reads and writes data on a hard disk. The terms hard drive and hard disk are often used interchangeably.

HEAT SINK — A metal plate on some microprocessors that helps dissipate heat.

HELP FILE — A file that contains descriptive or instructional information about a product. Some help files are associated with a particular program, such as *Help* in Microsoft Word. Other help files function as stand-alone reference sources. Help files typically have a filename extension of **.hlp** or **.chm**.

HIBERNATE MODE — A power management mode that saves everything in memory to a reserved space on the hard drive and then turns off the computer. When you restart the computer, the memory information that was saved to the hard drive is automatically restored.

HTML — hypertext markup language — A set of codes inserted into an Internet web page intended for display on an Internet browser.

HTTP — hypertext transfer protocol — A protocol for exchanging files between computers connected to the Internet.

Hz — hertz — A unit of frequency measurement that equals 1 cycle per second. Computers and electronic devices are often measured in kilohertz (kHz), megahertz (MHz), gigahertz (GHz), or terahertz (THz).

I

IC — Industry Canada — The Canadian regulatory body responsible for regulating emissions from electronic equipment, much as the FCC does in the United States.

IC — integrated circuit — A semiconductor wafer, or chip, on which thousands or millions of tiny electronic components are fabricated for use in computer, audio, and video equipment.

IDE — integrated device electronics — An interface for mass storage devices in which the controller is integrated into the hard drive or CD drive.

IEEE 1394 — Institute of Electrical and Electronics Engineers, Inc. — A high-performance serial bus used to connect IEEE 1394-compatible devices, such as digital cameras and DVD players, to the computer.

INFRARED SENSOR — A port that allows you to transfer data between the computer and infrared-compatible devices without using a cable connection.

INTEGRATED — Usually refers to components that are physically located on the computer's system board. Also referred to as *built-in*.

I/O — input/output — An operation or device that enters and extracts data from your computer. Keyboards and printers are I/O devices.

I/O ADDRESS — An address in RAM that is associated with a specific device (such as a serial connector, parallel connector, or expansion slot) and allows the microprocessor to communicate with that device.

IRDA — Infrared Data Association — The organization that creates international standards for infrared communications.

IRQ — interrupt request — An electronic pathway assigned to a specific device so that the device can communicate with the microprocessor. Each device connection must be assigned an IRQ. Although two devices can share the same IRQ assignment, you cannot operate both devices simultaneously.

ISP — Internet service provider — A company that allows you to access its host server to connect directly to the Internet, send and receive e-mail, and access websites. The ISP typically provides you with a software package, user name, and access phone numbers for a fee.

K

Kb — kilobit — A unit of data that equals 1024 bits. A measurement of the capacity of memory integrated circuits.

KB — kilobyte — A unit of data that equals 1024 bytes but is often referred to as 1000 bytes.

KEYBOARD SHORTCUT — A command requiring you to press multiple keys at the same time. Also referred to as a *key combination*.

KHZ — kilohertz — A measurement of frequency that equals 1000 Hz.

L

LAN — local area network — A computer network covering a small area. A LAN usually is confined to a building or a few nearby buildings. A LAN can be connected to another LAN over any distance through telephone lines and radio waves to form a wide area network (WAN).

LCD — liquid crystal display — The technology used by portable computer and flat-panel displays.

LED — light-emitting diode — An electronic component that emits light to indicate the status of the computer.

LOCAL BUS — A data bus that provides a fast throughput for devices to the microprocessor.

LPT — line print terminal — The designation for a parallel connection to a printer or other parallel device.

M

MB — megabit — A measurement of memory chip capacity that equals 1024 Kb.

MBPS — megabits per second — One million bits per second. This measurement is typically used for transmission speeds for networks and modems.

MB — megabyte — A measurement of data storage that equals 1,048,576 bytes. 1 MB equals 1024 KB. When used to refer to hard drive storage, the term is often rounded to 1,000,000 bytes.

MB/SEC — megabytes per second — One million bytes per second. This measurement is typically used for data transfer ratings.

MEMORY — A temporary data storage area inside your computer. Because the data in memory is not permanent, it is recommended that you frequently save your files while you are working on them, and always save your files before you shut down the computer. Your computer can contain several different forms of memory, such as RAM, ROM, and video memory. Frequently, the word memory is used as a synonym for RAM.

MEMORY ADDRESS — A specific location where data is temporarily stored in RAM.

MEMORY MAPPING — The process by which the computer assigns memory addresses to physical locations at start-up. Devices and software can then identify information that the microprocessor can access.

MEMORY MODULE — A small circuit board containing memory chips, which connects to the system board.

MHZ — megahertz — A measure of frequency that equals 1 million cycles per second. The speeds for computer microprocessors, buses, and interfaces are often measured in MHz.

MICROPROCESSOR — A computer chip that interprets and executes program instructions. Sometimes the microprocessor is referred to as the processor or the CPU (central processing unit).

MODEM — A device that allows your computer to communicate with other computers over analog telephone lines. Three types of modems include: external, PC Card, and internal. You typically use your modem to connect to the Internet and exchange e-mail.

MODULE BAY — A bay that supports devices such as optical drives, a second battery, or a Dell TravelLite™ module.

MONITOR — The high-resolution TV-like device that displays computer output.

MOUSE — A pointing device that controls the movement of the cursor on your screen. Typically you roll the mouse over a hard, flat surface to move the pointer or cursor on your screen.

MS — millisecond — A measure of time that equals one thousandth of a second. Access times of storage devices are often measured in ms.

N

NETWORK ADAPTER — A chip that provides network capabilities. A computer may include a network adapter on its system board, or it may contain a PC Card with an adapter on it. A network adapter is also referred to as a *NIC* (network interface controller).

NIC — See *network adapter*.

NOTIFICATION AREA — The section of the Windows taskbar that contains icons for providing quick access to programs and computer functions, such as the clock, volume control, and print status. Also referred to as *system tray*.

NS — nanosecond — A measure of time that equals one billionth of a second.

NVRAM — nonvolatile random access memory — A type of memory that stores data when the computer is turned off or loses its external power source. NVRAM is used for maintaining computer configuration information such as date, time, and other system setup options that you can set.

O

OPTICAL DRIVE — A drive that uses optical technology to read or write data from CDs, DVDs, or DVD+ RWs. Example of optical drives include CD drives, DVD drives, CD-RW drives, and CD-RW/DVD combo drives.

P

PARALLEL CONNECTOR — An I/O port often used to connect a parallel printer to your computer. Also referred to as an *LPT port*.

PARTITION — A physical storage area on a hard drive that is assigned to one or more logical storage areas known as logical drives. Each partition can contain multiple logical drives.

PC CARD — A removable I/O card adhering to the PCMCIA standard. Modems and network adapters are common types of PC Cards.

PCI — peripheral component interconnect — PCI is a local bus that supports 32- and 64-bit data paths, providing a high-speed data path between the microprocessor and devices such as video, drives, and networks.

PCMCIA — Personal Computer Memory Card International Association — The organization that establishes standards for PC Cards.

PIN — personal identification number — A sequence of numerals and/or letters used to restrict unauthorized access to computer networks and other secure systems.

PIO — programmed input/output — A method of transferring data between two devices through the microprocessor as part of the data path.

PIXEL — A single point on a display screen. Pixels are arranged in rows and columns to create an image. A video resolution, such as 800 x 600, is expressed as the number of pixels across by the number of pixels up and down.

PLUG-AND-PLAY — The ability of the computer to automatically configure devices. Plug and Play provides automatic installation, configuration, and compatibility with existing hardware if the BIOS, operating system, and all devices are Plug and Play compliant.

POST — power-on self-test — Diagnostics programs, loaded automatically by the BIOS, that perform basic tests on the major computer components, such as memory, hard drives, and video. If no problems are detected during POST, the computer continues the start-up.

PROGRAM — Any software that processes data for you, including spreadsheet, word processor, database, and game packages. Programs require an operating system to run.

PS/2 — personal system/2 — A type of connector for attaching a PS/2-compatible keyboard, mouse, or keypad.

PXE — pre-boot execution environment — A WfM (Wired for Management) standard that allows networked computers that do not have an operating system to be configured and started remotely.

R

RAID — redundant array of independent disks — A system of two or more drives working together for performance and fault tolerance. RAID drives are typically used on servers and high-end PCs.

The three most common RAID levels are 0, 3, and 5:

- **Level 0:** Provides data striping but no redundancy. Level 0 improves performance but does not provide fault tolerance.
- **Level 3:** Same as Level 0, but also reserves one dedicated drive for error correction data, providing good performance and some level of fault tolerance.
- **Level 5:** Provides data striping at the byte level and also stripe error correction information, resulting in excellent performance and good fault tolerance.

RAM — random-access memory — The primary temporary storage area for program instructions and data. Any information stored in RAM is lost when you shut down your computer.

README FILE — A text file included with a software package or hardware product. Typically, readme files provide installation information and describe new product enhancements or corrections that have not yet been documented.

READ-ONLY — Data and/or files you can view but cannot edit or delete. A file can have read-only status if:

- It resides on a physically write-protected floppy disk, CD, or DVD.
- It is located on a network in a directory and the system administrator has assigned rights only to specific individuals.

REFRESH RATE — The frequency, measured in Hz, at which your screen's horizontal lines are recharged (sometimes also referred to as its *vertical frequency*). The higher the refresh rate, the less video flicker can be seen by the human eye.

RESOLUTION — The sharpness and clarity of an image produced by a printer or displayed on a monitor. The higher the resolution, the sharper the image.

RFI — radio frequency interference — Interference that is generated at typical radio frequencies, in the range of 10 kHz to 100,000 MHz. Radio frequencies are at the lower end of the electromagnetic frequency spectrum and are more likely to have interference than the higher frequency radiations, such as infrared and light.

ROM — read-only memory — Memory that stores data and programs that cannot be deleted or written to by the computer. ROM, unlike RAM, retains its contents after you shut down your computer. Some programs essential to the operation of your computer reside in ROM.

RPM — revolutions per minute — The number of rotations that occur per minute. Hard drive speed is often measured in rpm.

RTC — real time clock — Battery-powered clock on the system board that keeps the date and time after you shut down the computer.

RTCST — real-time clock reset — A jumper on the system board of some computers that can often be used for troubleshooting problems.

S

SCANDISK — A Microsoft utility that checks files, folders, and the hard disk's surface for errors. ScanDisk often runs when you restart the computer after it has stopped responding.

SDRAM — synchronous dynamic random-access memory — A type of DRAM that is synchronized with the optimal clock speed of the microprocessor.

SERIAL CONNECTOR — An I/O port often used to connect devices such as a handheld digital device or digital camera to your computer.

SERVICE TAG — A bar code label on your computer that identifies your computer when you access Dell Support at **support.dell.com** or when you call Dell for customer service or technical support.

SETUP PROGRAM — A program that is used to install and configure hardware and software. The **setup.exe** or **install.exe** program comes with most Windows software packages. Setup program differs from system setup program.

SHORTCUT — An icon that provides quick access to frequently used programs, files, folders, and drives. When you place a shortcut on your Windows desktop and double-click the icon, you can open its corresponding folder or file without having to find it first. Shortcut icons do not change the location of files. If you delete a shortcut, the original file is not affected. Also, you can rename a shortcut icon.

SHUTDOWN — The process of closing windows and exiting programs, exiting the operating system, and turning off your computer. You can lose data if you turn off your computer before completing a shutdown.

SMART CARD — A card that is embedded with a microprocessor and a memory chip. Smart cards can be used to authenticate a user on computers equipped for smart cards.

SOFTWARE — Anything that can be stored electronically, such as computer files or programs.

S/PDIF — Sony/Philips Digital Interface — An audio transfer file format that allows the transfer of audio from one file to another without converting it to and from an analog format, which could degrade the quality of the file.

STANDBY MODE — A power management mode that shuts down all unnecessary computer operations to save energy.

SURGE PROTECTORS — Prevent voltage spikes, such as those that may occur during an electrical storm, from entering the computer through the electrical outlet. Surge protectors do not protect against lightning strikes or against brownouts, which occur when the voltage drops more than 20 percent below the normal AC-line voltage level.

Network connections cannot be protected by surge protectors. Always disconnect the network cable from the network connector during electrical storms.

SVGA — super-video graphics array — A video standard for video cards and controllers. Typical SVGA resolutions are 800 x 600 and 1024 x 768.

The number of colors and resolution that a program displays depends on the capabilities of the monitor, the video controller and its drivers, and the amount of video memory installed in the computer.

S-VIDEO TV-OUT — A connector used to attach a TV or digital audio device to the computer.

SXGA — super-extended graphics array — A video standard for video cards and controllers that supports resolutions up to 1280 x 1024.

SXGA+ — super-extended graphics array plus — A video standard for video cards and controllers that supports resolutions up to 1400 x 1050.

SYSTEM BOARD — The main circuit board in your computer. Also known as the *motherboard*.

SYSTEM SETUP PROGRAM — A utility that serves as an interface between the computer hardware and the operating system. System setup allows you to configure user-selectable options in the BIOS, such as date and time or system password. Unless you understand what effect the settings have on the computer, do not change the settings for this program.

SYSTEM TRAY — See *notification area*.

T

TAPI — telephony application programming interface — Enables Windows programs to operate with a wide variety of telephony devices, including voice, data, fax, and video.

TEXT EDITOR — A program used to create and edit files that contain only text; for example, Windows Notepad uses a text editor. Text editors do not usually provide word wrap or formatting functionality (the option to underline, change fonts, and so on).

TRAVEL MODULE — A plastic device designed to fit inside the module bay of a portable computer to reduce the weight of the computer.

U

UPS — uninterruptible power supply — A backup power source used when the electrical power fails or drops to an unacceptable voltage level. A UPS keeps a computer running for a limited amount of time when there is no electrical power. UPS systems typically provide surge suppression and may also provide voltage regulation. Small UPS systems provide battery power for a few minutes to enable you to shut down your computer.

USB — universal serial bus — A hardware interface for a low-speed device such as a USB-compatible keyboard, mouse, joystick, scanner, set of speakers, printer, broadband devices (DSL and cable modems), imaging devices, or storage devices. Devices are plugged directly in to a 4-pin socket on your computer or into a multi-port hub that plugs in to your computer. USB devices can be connected and disconnected while the computer is turned on, and they can also be daisy-chained together.

UTP — unshielded twisted pair — Describes a type of cable used in most telephone networks and some computer networks. Pairs of unshielded wires are twisted to protect against electromagnetic interference, rather than relying on a metal sheath around each pair of wires to protect against interference.

UXGA — ultra extended graphics array — A video standard for video cards and controllers that supports resolutions up to 1600 x 1200.

V

VIDEO CONTROLLER — The circuitry on a video card or on the system board (in computers with an integrated video controller) that provides the video capabilities—in combination with the monitor—for your computer.

VIDEO MEMORY — Memory that consists of memory chips dedicated to video functions. Video memory is usually faster than system memory. The amount of video memory installed primarily influences the number of colors that a program can display.

VIDEO MODE — A mode that describes how text and graphics are displayed on a monitor. Graphics-based software, such as Windows operating systems, displays in video modes that can be defined as x horizontal pixels by y vertical pixels by z colors. Character-based software, such as text editors, displays in video modes that can be defined as x columns by y rows of characters.

VIDEO RESOLUTION — See *resolution*.

VIRUS — A program that is designed to inconvenience you or to destroy data stored on your computer. A virus program moves from one computer to another through an infected disk, software downloaded from the Internet, or e-mail attachments. When an infected program starts, its embedded virus also starts.

A common type of virus is a boot virus, which is stored in the boot sectors of a floppy disk. If the floppy disk is left in the drive when the computer is shut down and then turned on, the computer is infected when it reads the boot sectors of the floppy disk expecting to find the operating system. If the computer is infected, the boot virus may replicate itself onto all the floppy disks that are read or written in that computer until the virus is eradicated.

V — volt — The measurement of electric potential or electromotive force. One V appears across a resistance of 1 ohm when a current of 1 ampere flows through that resistance.

W

W — watt — The measurement of electrical power. One W is 1 ampere of current flowing at 1 volt.

WHR — watt-hour — A unit of measure commonly used to indicate the approximate capacity of a battery. For example, a 66-WHr battery can supply 66 W of power for 1 hour or 33 W for 2 hours.

WALLPAPER — The background pattern or picture on the Windows desktop. Change your wallpaper through the Windows Control Panel. You can also scan in your favorite picture and make it wallpaper.

WRITE-PROTECTED — Files or media that cannot be changed. Use write-protection when you want to protect data from being changed or destroyed. To write-protect a 3.5-inch floppy disk, slide its write-protect tab to the open position.

X

XGA — extended graphics array — A video standard for video cards and controllers that supports resolutions up to 1024 x 768.

Z

ZIF — zero insertion force — A type of socket or connector that allows a computer chip to be installed or removed with no stress applied to either the chip or its socket.

ZIP — A popular data compression format. Files that have been compressed with the Zip format are called Zip files and usually have a filename extension of **.zip**. A special kind of zipped file is a self-extracting file, which has a filename extension of **.exe**. You can unzip a self-extracting file by double-clicking it.

ZIP DRIVE — A high-capacity floppy drive developed by Iomega Corporation that uses 3.5-inch removable disks called Zip disks. Zip disks are slightly larger than regular floppy disks, about twice as thick, and hold up to 100 MB of data.