

Installation Guide

WLAN Mini PCI Card

Installation Guide (GR)
Installation Guide (LA)
Installation Guide (FR)
Installation Guide (IT)
Installation Guide (JP)
Installation Guide (KR)
Installation Guide (CH)
Installation Guide (TW)

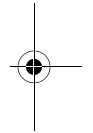
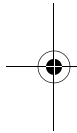

Document Part Number: 348376-B22

July 2004

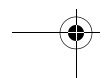
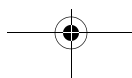

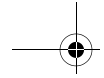

© Copyright 2003, 2004 Hewlett-Packard Development Company, L.P.

Microsoft and Windows are U.S. registered trademarks of Microsoft Corporation. Intel is a trademark or registered trademark of Intel Corporation or its subsidiaries in the United States and other countries.

The information contained herein is subject to change without notice. The only warranties for HP products and services are set forth in the express warranty statements accompanying such products and services. Nothing herein should be construed as constituting an additional warranty. HP shall not be liable for technical or editorial errors or omissions contained herein.

Installation Guide
WLAN Mini PCI Card
Second Edition July 2004
First Edition July 2004
Document Part Number: 348376-B22

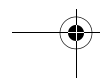
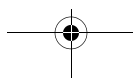
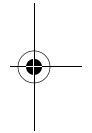
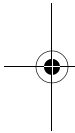

Contents

English

Before You Begin	1
Installing the WLAN Mini PCI Card.....	2
Installing the WLAN Mini PCI Card Software	5
Removing a WLAN Mini PCI Card.....	6
Information and Updates	8

German

Before You Begin	9
Installing the WLAN Mini PCI Card.....	10
Installing the WLAN Mini PCI Card Software	13
Removing a WLAN Mini PCI Card.....	14
Information and Updates	16

Spanish (Latin American)

Before You Begin	17
Installing the WLAN Mini PCI Card.....	18
Installing the WLAN Mini PCI Card Software	21
Removing a WLAN Mini PCI Card.....	22
Information and Updates	24

Contents

French

Before You Begin 25
Installing the WLAN Mini PCI Card..... 26
Installing the WLAN Mini PCI Card Software 29
Removing a WLAN Mini PCI Card..... 30
Information and Updates 32

Italian

Before You Begin 33
Installing the WLAN Mini PCI Card..... 34
Installing the WLAN Mini PCI Card Software 37
Removing a WLAN Mini PCI Card..... 38
Information and Updates 40

Japanese

Before You Begin 41
Installing the WLAN Mini PCI Card..... 42
Installing the WLAN Mini PCI Card Software 45
Removing a WLAN Mini PCI Card..... 46
Information and Updates 48

Korean

Before You Begin 49
Installing the WLAN Mini PCI Card..... 50
Installing the WLAN Mini PCI Card Software 53
Removing a WLAN Mini PCI Card..... 54
Information and Updates 56

S Chinese

Before You Begin	57
Installing the WLAN Mini PCI Card.....	58
Installing the WLAN Mini PCI Card Software	61
Removing a WLAN Mini PCI Card.....	62
Information and Updates	64

T Chinese

Before You Begin	65
Installing the WLAN Mini PCI Card.....	66
Installing the WLAN Mini PCI Card Software	69
Removing a WLAN Mini PCI Card.....	70
Information and Updates	72

Regulatory Notices

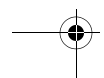
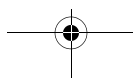
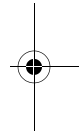
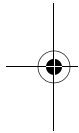
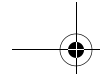

English

Before You Begin

 **CAUTION:** To prevent an unresponsive system and the display of a warning message, install only a Mini PCI device authorized for use in your computer by the governmental agency that regulates wireless devices in your country. If you install a device and then receive a warning message, remove the device to restore computer functionality. Then contact Customer Care. For information about contacting Customer Care, refer to the printed *Help and Support Guide* included with your computer.

Before you begin any installation or removal procedures:

1. Save your work, exit all applications, and shut down the computer. If you are not sure whether the computer is off or in Hibernation, turn the computer on, and then shut it down through the operating system.
2. Disconnect all external devices connected to the computer.
3. Disconnect the power cord.
4. Remove the battery pack.
5. Refer to the documentation included with your computer to
 - Identify the Mini PCI slot location.
 - Access the Mini PCI slot. The Mini PCI slot can usually be accessed via a panel on the bottom of the computer but sometimes it is located beneath the keyboard.

English

Installing the WLAN Mini PCI Card

 **CAUTION:** To prevent electrostatic discharge from damaging electronic components, discharge yourself of static electricity by touching a grounded metal object.

 If your computer has a WLAN Mini PCI card currently installed, you must remove it before installing the new card. Refer to the “Removing a WLAN Mini PCI Card” section.

1. Follow the procedures in the “Before You Begin” section.
2. Remove the plastic covers (if applicable) from the 2 antenna connector cables in the system.

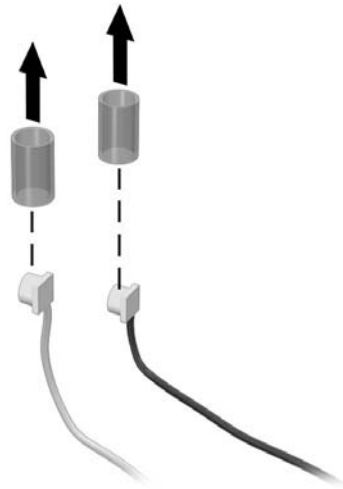

3. Insert the card into the slot at an angle ❶ and press the Mini PCI card down ❷ until the side latches snap into place.

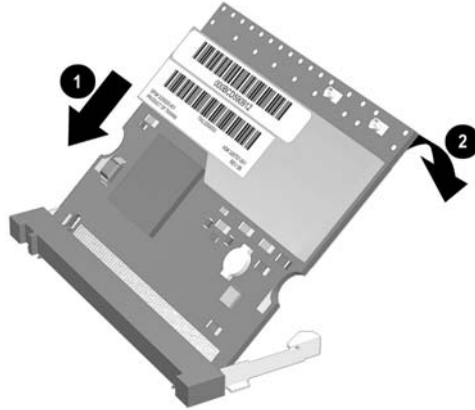

English

4. Connect the 2 antenna cables to the Mini PCI card. The gray (aux) cable connects to the antenna connector closest to the edge of the Mini PCI card, and the black (main) cable connects to the antenna connector closer to the center of the card, as shown in the following illustration.

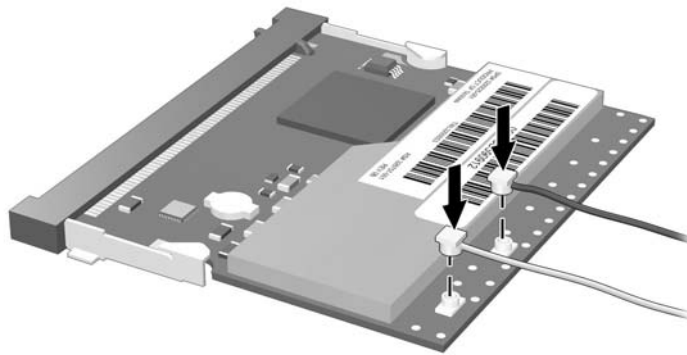

△ When connecting the antenna cables, be sure to connect the cables straight down and press firmly until they are fully seated. If antenna cable is inserted into connector at an angle, the center pin of the antenna connector could be damaged.

5. To complete the procedure, reverse the steps in the “Before You Begin” section.

✎ Be careful not to pinch the cables or damage the connectors. This could reduce wireless performance or cause the Mini PCI device to function improperly. Tuck any excess cable inside the system enclosure.

Installing the WLAN Mini PCI Card Software

The installation CD included in this option kit contains the necessary WLAN software and drivers for the Mini PCI card. To install the WLAN software:

 Updates to the software contained on the CD may be available. Refer to the “Information and Updates” section of this guide for instructions on downloading and installing the updated software.

1. Turn on the computer.
2. Log on to the system. (The Found New Hardware wizard is displayed.)
3. Insert the WLAN software CD included with this option kit into the optical drive of the computer. (The Found New Hardware wizard installs the device driver from the CD.)

 If the Found New Hardware wizard does not automatically load the driver from the CD, follow the prompts to point the wizard to the CD drive to install the device driver)

Installation of the device driver is complete.

 If you are using Microsoft® Windows® 2000, or if your wireless network requires Cisco Client Extensions (such as LEAP), you must also install the appropriate Wireless LAN utility (Atheros Client Utility or Intel® ProSET) to configure the WLAN device correctly. Both Wireless LAN utilities are located on the WLAN Software CD included with your option kit.

 If you have problems with the installation, contact your network administrator for assistance.

English

Removing a WLAN Mini PCI Card

CAUTION: To prevent electrostatic discharge from damaging electronic components, discharge yourself of static electricity by touching a grounded metal object.

1. Follow the procedures in the “Before You Begin” section.
2. Carefully disconnect the 2 antenna cables from the Mini PCI card by lifting the cable connector with a fingernail or small screwdriver.

CAUTION: Do not pull on the antenna cable to remove it. Grip and pull only on the connector itself. Pulling on the cable can damage or break off the connector.

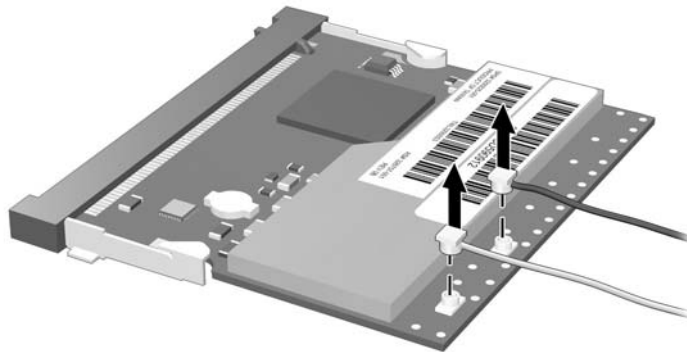

3. Pull the release latches **1** in the direction shown and pull the WLAN Mini PCI card up **2** and out **3** at an angle.

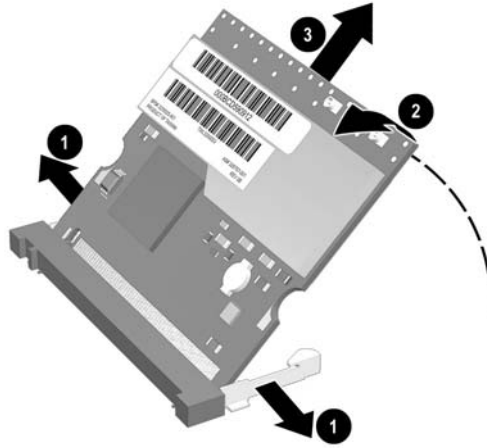

If you have problems with the removal, contact your network administrator for assistance.

English

Information and Updates

HP strongly recommends that you install any software upgrades that are available from HP for your WLAN Mini PCI card. Most software at the HP Web site is packaged in a compressed file called a Softpaq. You will download the Softpaq and save it to your hard drive.

To obtain software upgrades:

1. Visit the HP Web site at www.hp.com/support.
2. Follow the on-screen instructions to identify your country or region.
3. Select the **download drivers and software** radio button, and then enter the product information for your computer series name and device.

Refer to the *Notebook Documentation CD* or *Tablet PC Documentation CD* for further product details.

German

Before You Begin

 **CAUTION:** To prevent an unresponsive system and the display of a warning message, install only a Mini PCI device authorized for use in your computer by the governmental agency that regulates wireless devices in your country. If you install a device and then receive a warning message, remove the device to restore computer functionality. Then contact Customer Care. For information about contacting Customer Care, refer to the printed *Help and Support Guide* included with your computer.

Before you begin any installation or removal procedures:

1. Save your work, exit all applications, and shut down the computer. If you are not sure whether the computer is off or in Hibernation, turn the computer on, and then shut it down through the operating system.
2. Disconnect all external devices connected to the computer.
3. Disconnect the power cord.
4. Remove the battery pack.
5. Refer to the documentation included with your computer to
 - Identify the Mini PCI slot location.
 - Access the Mini PCI slot. The Mini PCI slot can usually be accessed via a panel on the bottom of the computer but sometimes it is located beneath the keyboard.

German

Installing the WLAN Mini PCI Card

 **CAUTION:** To prevent electrostatic discharge from damaging electronic components, discharge yourself of static electricity by touching a grounded metal object.

 If your computer has a WLAN Mini PCI card currently installed, you must remove it before installing the new card. Refer to the “Removing a WLAN Mini PCI Card” section.

1. Follow the procedures in the “Before You Begin” section.
2. Remove the plastic covers (if applicable) from the 2 antenna connector cables in the system.

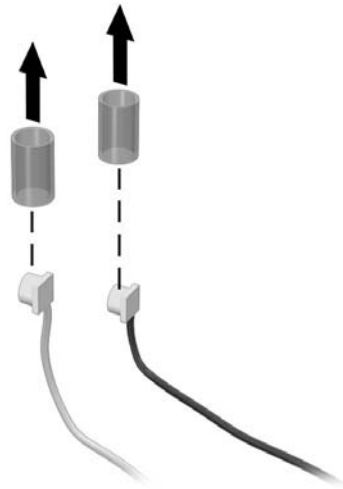

3. Insert the card into the slot at an angle ❶ and press the Mini PCI card down ❷ until the side latches snap into place.

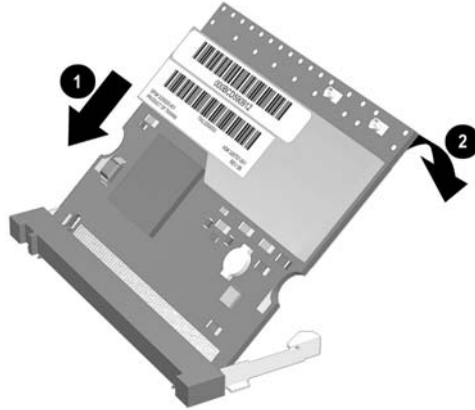

German

4. Connect the 2 antenna cables to the Mini PCI card. The gray (aux) cable connects to the antenna connector closest to the edge of the Mini PCI card, and the black (main) cable connects to the antenna connector closer to the center of the card, as shown in the following illustration.

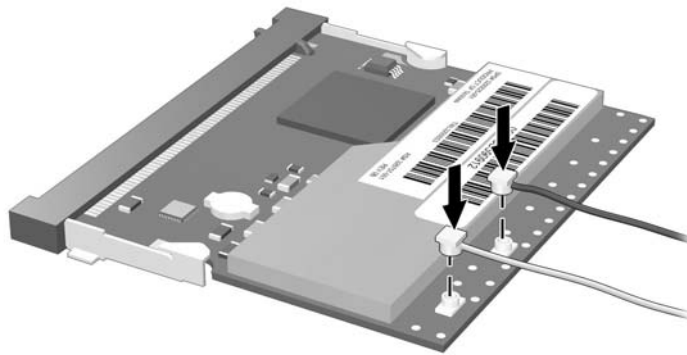

△ When connecting the antenna cables, be sure to connect the cables straight down and press firmly until they are fully seated. If antenna cable is inserted into connector at an angle, the center pin of the antenna connector could be damaged.

5. To complete the procedure, reverse the steps in the “Before You Begin” section.

✎ Be careful not to pinch the cables or damage the connectors. This could reduce wireless performance or cause the Mini PCI device to function improperly. Tuck any excess cable inside the system enclosure.

Installing the WLAN Mini PCI Card Software

The installation CD included in this option kit contains the necessary WLAN software and drivers for the Mini PCI card. To install the WLAN software:

 Updates to the software contained on the CD may be available. Refer to the “Information and Updates” section of this guide for instructions on downloading and installing the updated software.

1. Turn on the computer.
2. Log on to the system. (The Found New Hardware wizard is displayed.)
3. Insert the WLAN software CD included with this option kit into the optical drive of the computer. (The Found New Hardware wizard installs the device driver from the CD.)

 If the Found New Hardware wizard does not automatically load the driver from the CD, follow the prompts to point the wizard to the CD drive to install the device driver)

Installation of the device driver is complete.

 If you are using Microsoft® Windows® 2000, or if your wireless network requires Cisco Client Extensions (such as LEAP), you must also install the appropriate Wireless LAN utility (Atheros Client Utility or Intel® ProSET) to configure the WLAN device correctly. Both Wireless LAN utilities are located on the WLAN Software CD included with your option kit.

 If you have problems with the installation, contact your network administrator for assistance.

German

Removing a WLAN Mini PCI Card

CAUTION: To prevent electrostatic discharge from damaging electronic components, discharge yourself of static electricity by touching a grounded metal object.

1. Follow the procedures in the “Before You Begin” section.
2. Carefully disconnect the 2 antenna cables from the Mini PCI card by lifting the cable connector with a fingernail or small screwdriver.

CAUTION: Do not pull on the antenna cable to remove it. Grip and pull only on the connector itself. Pulling on the cable can damage or break off the connector.

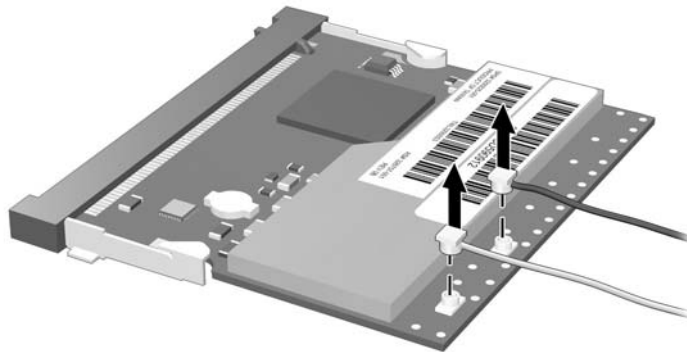

3. Pull the release latches **1** in the direction shown and pull the WLAN Mini PCI card up **2** and out **3** at an angle.

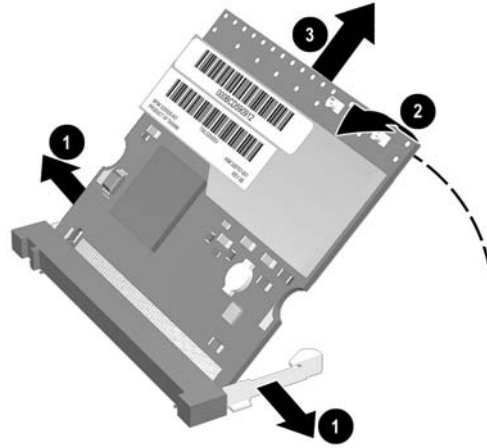

If you have problems with the removal, contact your network administrator for assistance.

German

Information and Updates

HP strongly recommends that you install any software upgrades that are available from HP for your WLAN Mini PCI card. Most software at the HP Web site is packaged in a compressed file called a Softpaq. You will download the Softpaq and save it to your hard drive.

To obtain software upgrades:

1. Visit the HP Web site at www.hp.com/support.
2. Follow the on-screen instructions to identify your country or region.
3. Select the **download drivers and software** radio button, and then enter the product information for your computer series name and device.

Refer to the *Notebook Documentation CD* or *Tablet PC Documentation CD* for further product details.

Spanish (Latin American)

Before You Begin

 **CAUTION:** To prevent an unresponsive system and the display of a warning message, install only a Mini PCI device authorized for use in your computer by the governmental agency that regulates wireless devices in your country. If you install a device and then receive a warning message, remove the device to restore computer functionality. Then contact Customer Care. For information about contacting Customer Care, refer to the printed *Help and Support Guide* included with your computer.

Before you begin any installation or removal procedures:

1. Save your work, exit all applications, and shut down the computer. If you are not sure whether the computer is off or in Hibernation, turn the computer on, and then shut it down through the operating system.
2. Disconnect all external devices connected to the computer.
3. Disconnect the power cord.
4. Remove the battery pack.
5. Refer to the documentation included with your computer to
 - Identify the Mini PCI slot location.
 - Access the Mini PCI slot. The Mini PCI slot can usually be accessed via a panel on the bottom of the computer but sometimes it is located beneath the keyboard.

Spanish (Latin American)

Installing the WLAN Mini PCI Card

 **CAUTION:** To prevent electrostatic discharge from damaging electronic components, discharge yourself of static electricity by touching a grounded metal object.

 If your computer has a WLAN Mini PCI card currently installed, you must remove it before installing the new card. Refer to the “Removing a WLAN Mini PCI Card” section.

1. Follow the procedures in the “Before You Begin” section.
2. Remove the plastic covers (if applicable) from the 2 antenna connector cables in the system.

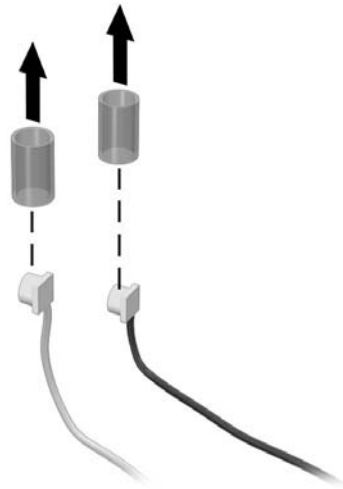

3. Insert the card into the slot at an angle ❶ and press the Mini PCI card down ❷ until the side latches snap into place.

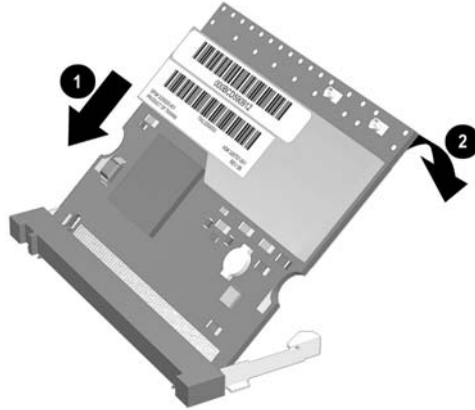

Spanish (Latin American)

4. Connect the 2 antenna cables to the Mini PCI card. The gray (aux) cable connects to the antenna connector closest to the edge of the Mini PCI card, and the black (main) cable connects to the antenna connector closer to the center of the card, as shown in the following illustration.

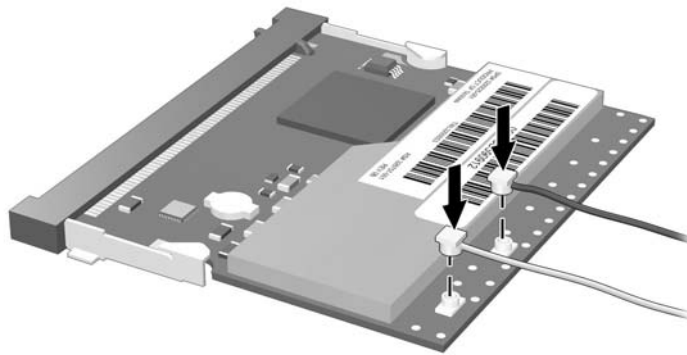

△ When connecting the antenna cables, be sure to connect the cables straight down and press firmly until they are fully seated. If antenna cable is inserted into connector at an angle, the center pin of the antenna connector could be damaged.

5. To complete the procedure, reverse the steps in the “Before You Begin” section.

✎ Be careful not to pinch the cables or damage the connectors. This could reduce wireless performance or cause the Mini PCI device to function improperly. Tuck any excess cable inside the system enclosure.

Installing the WLAN Mini PCI Card Software

The installation CD included in this option kit contains the necessary WLAN software and drivers for the Mini PCI card. To install the WLAN software:

 Updates to the software contained on the CD may be available. Refer to the “Information and Updates” section of this guide for instructions on downloading and installing the updated software.

1. Turn on the computer.
2. Log on to the system. (The Found New Hardware wizard is displayed.)
3. Insert the WLAN software CD included with this option kit into the optical drive of the computer. (The Found New Hardware wizard installs the device driver from the CD.)

 If the Found New Hardware wizard does not automatically load the driver from the CD, follow the prompts to point the wizard to the CD drive to install the device driver)

Installation of the device driver is complete.

 If you are using Microsoft® Windows® 2000, or if your wireless network requires Cisco Client Extensions (such as LEAP), you must also install the appropriate Wireless LAN utility (Atheros Client Utility or Intel® ProSET) to configure the WLAN device correctly. Both Wireless LAN utilities are located on the WLAN Software CD included with your option kit.

 If you have problems with the installation, contact your network administrator for assistance.

Spanish (Latin American)

Removing a WLAN Mini PCI Card

CAUTION: To prevent electrostatic discharge from damaging electronic components, discharge yourself of static electricity by touching a grounded metal object.

1. Follow the procedures in the “Before You Begin” section.
2. Carefully disconnect the 2 antenna cables from the Mini PCI card by lifting the cable connector with a fingernail or small screwdriver.

CAUTION: Do not pull on the antenna cable to remove it. Grip and pull only on the connector itself. Pulling on the cable can damage or break off the connector.

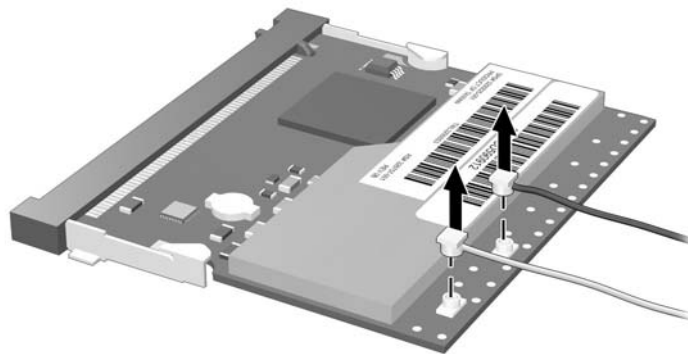

3. Pull the release latches **1** in the direction shown and pull the WLAN Mini PCI card up **2** and out **3** at an angle.

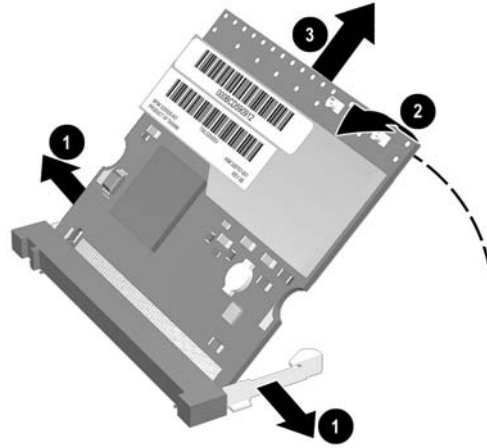

If you have problems with the removal, contact your network administrator for assistance.

Spanish (Latin American)

Information and Updates

HP strongly recommends that you install any software upgrades that are available from HP for your WLAN Mini PCI card. Most software at the HP Web site is packaged in a compressed file called a Softpaq. You will download the Softpaq and save it to your hard drive.

To obtain software upgrades:

1. Visit the HP Web site at www.hp.com/support.
2. Follow the on-screen instructions to identify your country or region.
3. Select the **download drivers and software** radio button, and then enter the product information for your computer series name and device.

Refer to the *Notebook Documentation CD* or *Tablet PC Documentation CD* for further product details.

French

Before You Begin

 **CAUTION:** To prevent an unresponsive system and the display of a warning message, install only a Mini PCI device authorized for use in your computer by the governmental agency that regulates wireless devices in your country. If you install a device and then receive a warning message, remove the device to restore computer functionality. Then contact Customer Care. For information about contacting Customer Care, refer to the printed *Help and Support Guide* included with your computer.

Before you begin any installation or removal procedures:

1. Save your work, exit all applications, and shut down the computer. If you are not sure whether the computer is off or in Hibernation, turn the computer on, and then shut it down through the operating system.
2. Disconnect all external devices connected to the computer.
3. Disconnect the power cord.
4. Remove the battery pack.
5. Refer to the documentation included with your computer to
 - Identify the Mini PCI slot location.
 - Access the Mini PCI slot. The Mini PCI slot can usually be accessed via a panel on the bottom of the computer but sometimes it is located beneath the keyboard.

French

Installing the WLAN Mini PCI Card

 **CAUTION:** To prevent electrostatic discharge from damaging electronic components, discharge yourself of static electricity by touching a grounded metal object.

 If your computer has a WLAN Mini PCI card currently installed, you must remove it before installing the new card. Refer to the “Removing a WLAN Mini PCI Card” section.

1. Follow the procedures in the “Before You Begin” section.
2. Remove the plastic covers (if applicable) from the 2 antenna connector cables in the system.

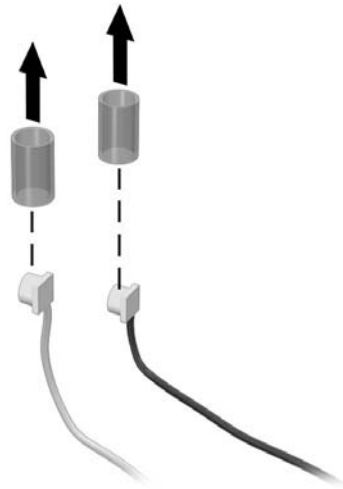

3. Insert the card into the slot at an angle ❶ and press the Mini PCI card down ❷ until the side latches snap into place.

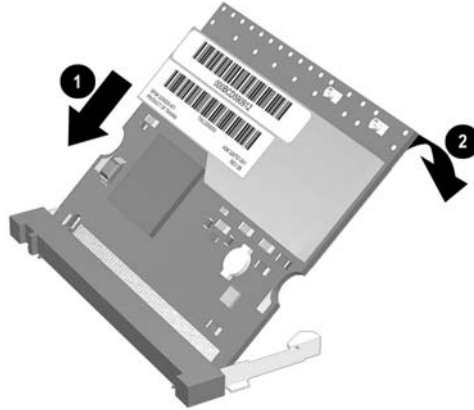

French

4. Connect the 2 antenna cables to the Mini PCI card. The gray (aux) cable connects to the antenna connector closest to the edge of the Mini PCI card, and the black (main) cable connects to the antenna connector closer to the center of the card, as shown in the following illustration.

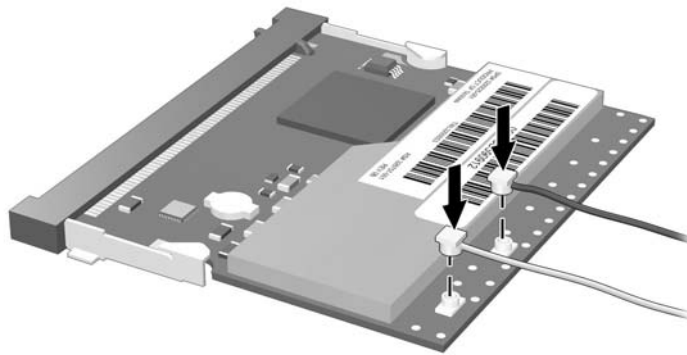

△ When connecting the antenna cables, be sure to connect the cables straight down and press firmly until they are fully seated. If antenna cable is inserted into connector at an angle, the center pin of the antenna connector could be damaged.

5. To complete the procedure, reverse the steps in the “Before You Begin” section.

✎ Be careful not to pinch the cables or damage the connectors. This could reduce wireless performance or cause the Mini PCI device to function improperly. Tuck any excess cable inside the system enclosure.

Installing the WLAN Mini PCI Card Software

The installation CD included in this option kit contains the necessary WLAN software and drivers for the Mini PCI card. To install the WLAN software:

 Updates to the software contained on the CD may be available. Refer to the “Information and Updates” section of this guide for instructions on downloading and installing the updated software.

1. Turn on the computer.
2. Log on to the system. (The Found New Hardware wizard is displayed.)
3. Insert the WLAN software CD included with this option kit into the optical drive of the computer. (The Found New Hardware wizard installs the device driver from the CD.)

 If the Found New Hardware wizard does not automatically load the driver from the CD, follow the prompts to point the wizard to the CD drive to install the device driver)

Installation of the device driver is complete.

 If you are using Microsoft® Windows® 2000, or if your wireless network requires Cisco Client Extensions (such as LEAP), you must also install the appropriate Wireless LAN utility (Atheros Client Utility or Intel® ProSET) to configure the WLAN device correctly. Both Wireless LAN utilities are located on the WLAN Software CD included with your option kit.

 If you have problems with the installation, contact your network administrator for assistance.

French

Removing a WLAN Mini PCI Card

CAUTION: To prevent electrostatic discharge from damaging electronic components, discharge yourself of static electricity by touching a grounded metal object.

1. Follow the procedures in the “Before You Begin” section.
2. Carefully disconnect the 2 antenna cables from the Mini PCI card by lifting the cable connector with a fingernail or small screwdriver.

CAUTION: Do not pull on the antenna cable to remove it. Grip and pull only on the connector itself. Pulling on the cable can damage or break off the connector.

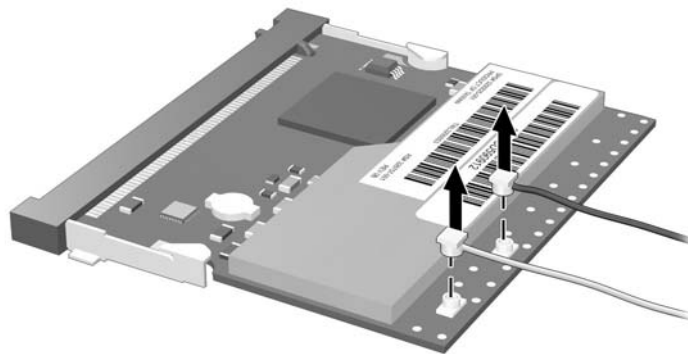

3. Pull the release latches **1** in the direction shown and pull the WLAN Mini PCI card up **2** and out **3** at an angle.

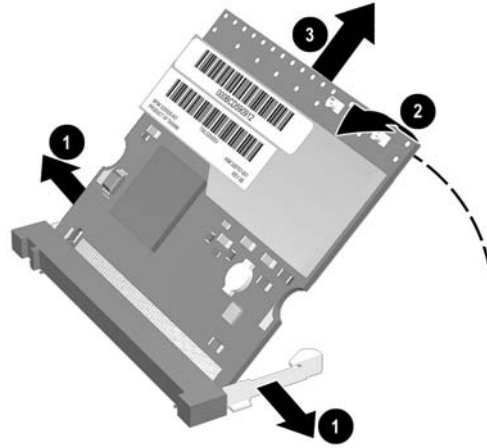

If you have problems with the removal, contact your network administrator for assistance.

French

Information and Updates

HP strongly recommends that you install any software upgrades that are available from HP for your WLAN Mini PCI card. Most software at the HP Web site is packaged in a compressed file called a Softpaq. You will download the Softpaq and save it to your hard drive.

To obtain software upgrades:

1. Visit the HP Web site at www.hp.com/support.
2. Follow the on-screen instructions to identify your country or region.
3. Select the **download drivers and software** radio button, and then enter the product information for your computer series name and device.

Refer to the *Notebook Documentation CD* or *Tablet PC Documentation CD* for further product details.

Italian

Before You Begin

 **CAUTION:** To prevent an unresponsive system and the display of a warning message, install only a Mini PCI device authorized for use in your computer by the governmental agency that regulates wireless devices in your country. If you install a device and then receive a warning message, remove the device to restore computer functionality. Then contact Customer Care. For information about contacting Customer Care, refer to the printed *Help and Support Guide* included with your computer.

Before you begin any installation or removal procedures:

1. Save your work, exit all applications, and shut down the computer. If you are not sure whether the computer is off or in Hibernation, turn the computer on, and then shut it down through the operating system.
2. Disconnect all external devices connected to the computer.
3. Disconnect the power cord.
4. Remove the battery pack.
5. Refer to the documentation included with your computer to
 - Identify the Mini PCI slot location.
 - Access the Mini PCI slot. The Mini PCI slot can usually be accessed via a panel on the bottom of the computer but sometimes it is located beneath the keyboard.

Italian

Installing the WLAN Mini PCI Card

 **CAUTION:** To prevent electrostatic discharge from damaging electronic components, discharge yourself of static electricity by touching a grounded metal object.

 If your computer has a WLAN Mini PCI card currently installed, you must remove it before installing the new card. Refer to the “Removing a WLAN Mini PCI Card” section.

1. Follow the procedures in the “Before You Begin” section.
2. Remove the plastic covers (if applicable) from the 2 antenna connector cables in the system.

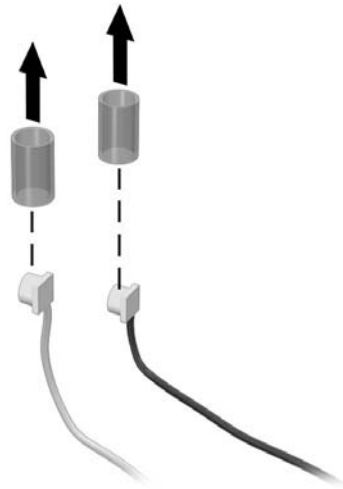

3. Insert the card into the slot at an angle ❶ and press the Mini PCI card down ❷ until the side latches snap into place.

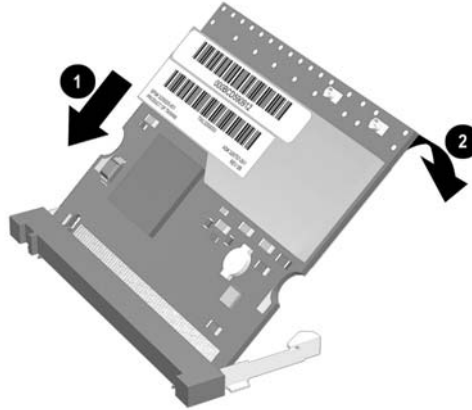

Italian

4. Connect the 2 antenna cables to the Mini PCI card. The gray (aux) cable connects to the antenna connector closest to the edge of the Mini PCI card, and the black (main) cable connects to the antenna connector closer to the center of the card, as shown in the following illustration.

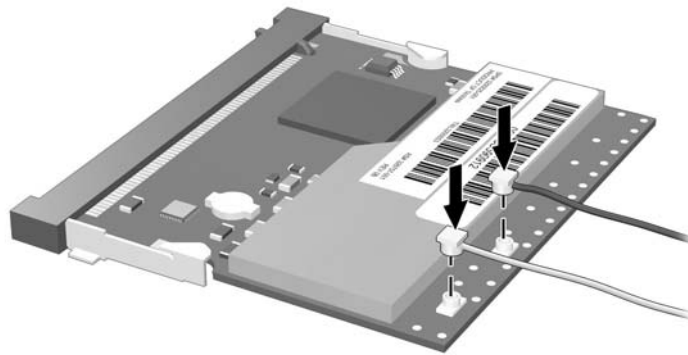

△ When connecting the antenna cables, be sure to connect the cables straight down and press firmly until they are fully seated. If antenna cable is inserted into connector at an angle, the center pin of the antenna connector could be damaged.

5. To complete the procedure, reverse the steps in the “Before You Begin” section.

✎ Be careful not to pinch the cables or damage the connectors. This could reduce wireless performance or cause the Mini PCI device to function improperly. Tuck any excess cable inside the system enclosure.

Installing the WLAN Mini PCI Card Software

The installation CD included in this option kit contains the necessary WLAN software and drivers for the Mini PCI card. To install the WLAN software:

 Updates to the software contained on the CD may be available. Refer to the “Information and Updates” section of this guide for instructions on downloading and installing the updated software.

1. Turn on the computer.
2. Log on to the system. (The Found New Hardware wizard is displayed.)
3. Insert the WLAN software CD included with this option kit into the optical drive of the computer. (The Found New Hardware wizard installs the device driver from the CD.)

 If the Found New Hardware wizard does not automatically load the driver from the CD, follow the prompts to point the wizard to the CD drive to install the device driver)

Installation of the device driver is complete.

 If you are using Microsoft® Windows® 2000, or if your wireless network requires Cisco Client Extensions (such as LEAP), you must also install the appropriate Wireless LAN utility (Atheros Client Utility or Intel® ProSET) to configure the WLAN device correctly. Both Wireless LAN utilities are located on the WLAN Software CD included with your option kit.

 If you have problems with the installation, contact your network administrator for assistance.

Italian

Removing a WLAN Mini PCI Card

CAUTION: To prevent electrostatic discharge from damaging electronic components, discharge yourself of static electricity by touching a grounded metal object.

1. Follow the procedures in the “Before You Begin” section.
2. Carefully disconnect the 2 antenna cables from the Mini PCI card by lifting the cable connector with a fingernail or small screwdriver.

CAUTION: Do not pull on the antenna cable to remove it. Grip and pull only on the connector itself. Pulling on the cable can damage or break off the connector.

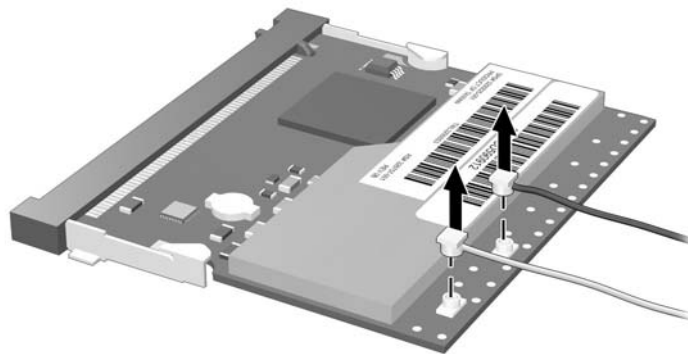

3. Pull the release latches **1** in the direction shown and pull the WLAN Mini PCI card up **2** and out **3** at an angle.

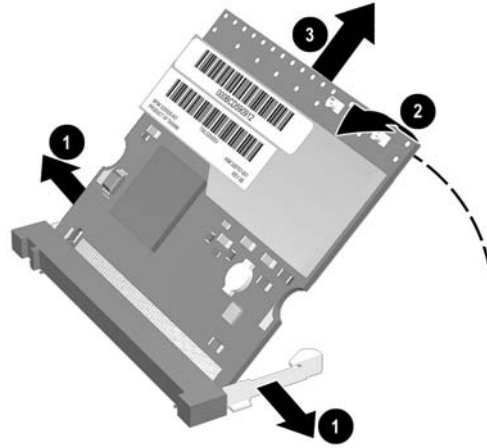

If you have problems with the removal, contact your network administrator for assistance.

Italian

Information and Updates

HP strongly recommends that you install any software upgrades that are available from HP for your WLAN Mini PCI card. Most software at the HP Web site is packaged in a compressed file called a Softpaq. You will download the Softpaq and save it to your hard drive.

To obtain software upgrades:

1. Visit the HP Web site at www.hp.com/support.
2. Follow the on-screen instructions to identify your country or region.
3. Select the **download drivers and software** radio button, and then enter the product information for your computer series name and device.

Refer to the *Notebook Documentation CD* or *Tablet PC Documentation CD* for further product details.

Japanese

Before You Begin

 **CAUTION:** To prevent an unresponsive system and the display of a warning message, install only a Mini PCI device authorized for use in your computer by the governmental agency that regulates wireless devices in your country. If you install a device and then receive a warning message, remove the device to restore computer functionality. Then contact Customer Care. For information about contacting Customer Care, refer to the printed *Help and Support Guide* included with your computer.

Before you begin any installation or removal procedures:

1. Save your work, exit all applications, and shut down the computer. If you are not sure whether the computer is off or in Hibernation, turn the computer on, and then shut it down through the operating system.
2. Disconnect all external devices connected to the computer.
3. Disconnect the power cord.
4. Remove the battery pack.
5. Refer to the documentation included with your computer to
 - Identify the Mini PCI slot location.
 - Access the Mini PCI slot. The Mini PCI slot can usually be accessed via a panel on the bottom of the computer but sometimes it is located beneath the keyboard.

Japanese

Installing the WLAN Mini PCI Card

 **CAUTION:** To prevent electrostatic discharge from damaging electronic components, discharge yourself of static electricity by touching a grounded metal object.

 If your computer has a WLAN Mini PCI card currently installed, you must remove it before installing the new card. Refer to the “Removing a WLAN Mini PCI Card” section.

1. Follow the procedures in the “Before You Begin” section.
2. Remove the plastic covers (if applicable) from the 2 antenna connector cables in the system.

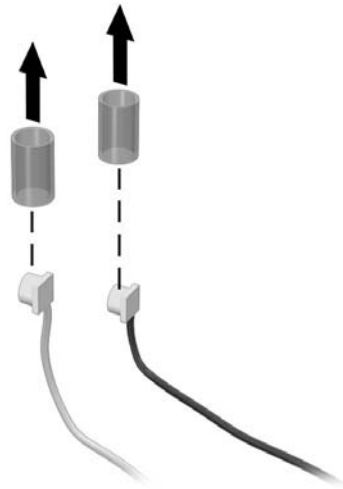

3. Insert the card into the slot at an angle ❶ and press the Mini PCI card down ❷ until the side latches snap into place.

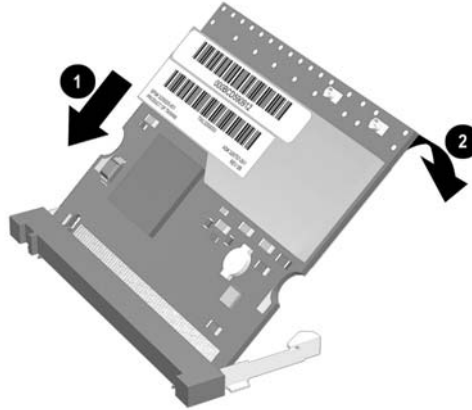

Japanese

4. Connect the 2 antenna cables to the Mini PCI card. The gray (aux) cable connects to the antenna connector closest to the edge of the Mini PCI card, and the black (main) cable connects to the antenna connector closer to the center of the card, as shown in the following illustration.

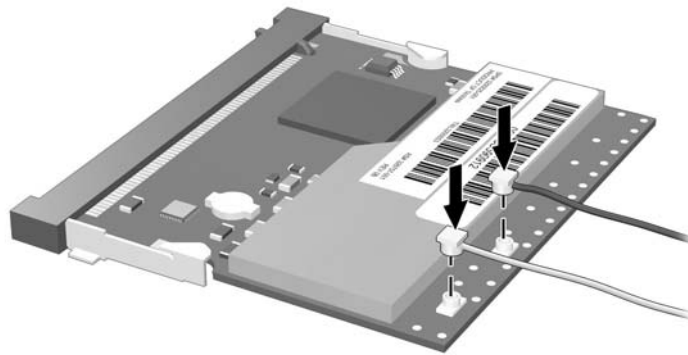

△ When connecting the antenna cables, be sure to connect the cables straight down and press firmly until they are fully seated. If antenna cable is inserted into connector at an angle, the center pin of the antenna connector could be damaged.

5. To complete the procedure, reverse the steps in the “Before You Begin” section.

✎ Be careful not to pinch the cables or damage the connectors. This could reduce wireless performance or cause the Mini PCI device to function improperly. Tuck any excess cable inside the system enclosure.

Installing the WLAN Mini PCI Card Software

The installation CD included in this option kit contains the necessary WLAN software and drivers for the Mini PCI card. To install the WLAN software:

 Updates to the software contained on the CD may be available. Refer to the “Information and Updates” section of this guide for instructions on downloading and installing the updated software.

1. Turn on the computer.
2. Log on to the system. (The Found New Hardware wizard is displayed.)
3. Insert the WLAN software CD included with this option kit into the optical drive of the computer. (The Found New Hardware wizard installs the device driver from the CD.)

 If the Found New Hardware wizard does not automatically load the driver from the CD, follow the prompts to point the wizard to the CD drive to install the device driver)

Installation of the device driver is complete.

 If you are using Microsoft® Windows® 2000, or if your wireless network requires Cisco Client Extensions (such as LEAP), you must also install the appropriate Wireless LAN utility (Atheros Client Utility or Intel® ProSET) to configure the WLAN device correctly. Both Wireless LAN utilities are located on the WLAN Software CD included with your option kit.

 If you have problems with the installation, contact your network administrator for assistance.

Japanese

Removing a WLAN Mini PCI Card

CAUTION: To prevent electrostatic discharge from damaging electronic components, discharge yourself of static electricity by touching a grounded metal object.

1. Follow the procedures in the “Before You Begin” section.
2. Carefully disconnect the 2 antenna cables from the Mini PCI card by lifting the cable connector with a fingernail or small screwdriver.

CAUTION: Do not pull on the antenna cable to remove it. Grip and pull only on the connector itself. Pulling on the cable can damage or break off the connector.

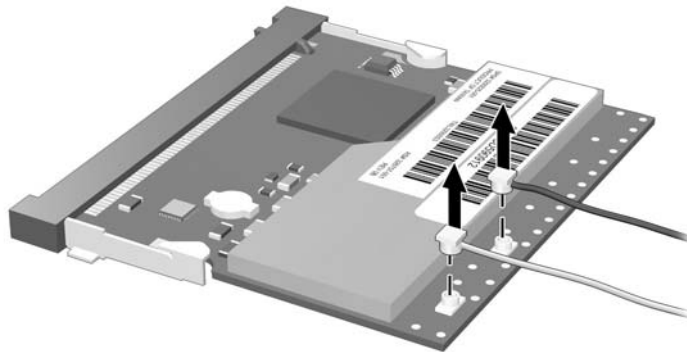

3. Pull the release latches **1** in the direction shown and pull the WLAN Mini PCI card up **2** and out **3** at an angle.

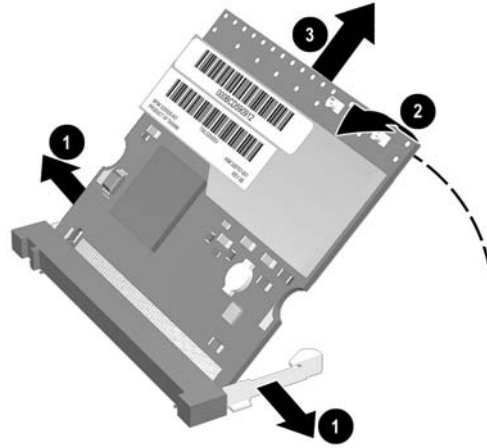

If you have problems with the removal, contact your network administrator for assistance.

Japanese

Information and Updates

HP strongly recommends that you install any software upgrades that are available from HP for your WLAN Mini PCI card. Most software at the HP Web site is packaged in a compressed file called a Softpaq. You will download the Softpaq and save it to your hard drive.

To obtain software upgrades:

1. Visit the HP Web site at www.hp.com/support.
2. Follow the on-screen instructions to identify your country or region.
3. Select the **download drivers and software** radio button, and then enter the product information for your computer series name and device.

Refer to the *Notebook Documentation CD* or *Tablet PC Documentation CD* for further product details.

Korean

Before You Begin

 **CAUTION:** To prevent an unresponsive system and the display of a warning message, install only a Mini PCI device authorized for use in your computer by the governmental agency that regulates wireless devices in your country. If you install a device and then receive a warning message, remove the device to restore computer functionality. Then contact Customer Care. For information about contacting Customer Care, refer to the printed *Help and Support Guide* included with your computer.

Before you begin any installation or removal procedures:

1. Save your work, exit all applications, and shut down the computer. If you are not sure whether the computer is off or in Hibernation, turn the computer on, and then shut it down through the operating system.
2. Disconnect all external devices connected to the computer.
3. Disconnect the power cord.
4. Remove the battery pack.
5. Refer to the documentation included with your computer to
 - Identify the Mini PCI slot location.
 - Access the Mini PCI slot. The Mini PCI slot can usually be accessed via a panel on the bottom of the computer but sometimes it is located beneath the keyboard.

Korean

Installing the WLAN Mini PCI Card

 **CAUTION:** To prevent electrostatic discharge from damaging electronic components, discharge yourself of static electricity by touching a grounded metal object.

 If your computer has a WLAN Mini PCI card currently installed, you must remove it before installing the new card. Refer to the “Removing a WLAN Mini PCI Card” section.

1. Follow the procedures in the “Before You Begin” section.
2. Remove the plastic covers (if applicable) from the 2 antenna connector cables in the system.

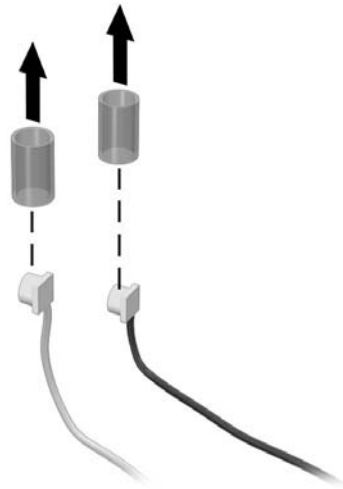

3. Insert the card into the slot at an angle ❶ and press the Mini PCI card down ❷ until the side latches snap into place.

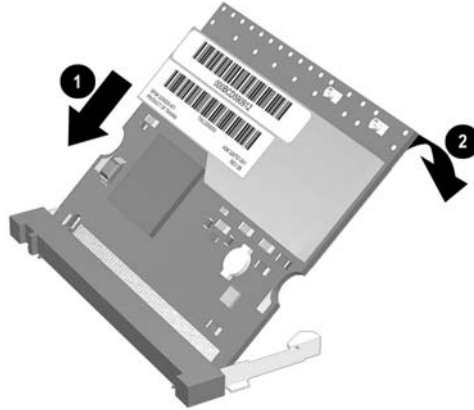

Korean

4. Connect the 2 antenna cables to the Mini PCI card. The gray (aux) cable connects to the antenna connector closest to the edge of the Mini PCI card, and the black (main) cable connects to the antenna connector closer to the center of the card, as shown in the following illustration.

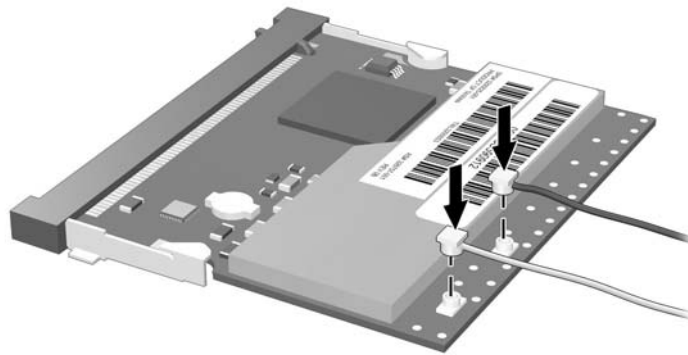

△ When connecting the antenna cables, be sure to connect the cables straight down and press firmly until they are fully seated. If antenna cable is inserted into connector at an angle, the center pin of the antenna connector could be damaged.

5. To complete the procedure, reverse the steps in the “Before You Begin” section.

✎ Be careful not to pinch the cables or damage the connectors. This could reduce wireless performance or cause the Mini PCI device to function improperly. Tuck any excess cable inside the system enclosure.

Installing the WLAN Mini PCI Card Software

The installation CD included in this option kit contains the necessary WLAN software and drivers for the Mini PCI card. To install the WLAN software:

 Updates to the software contained on the CD may be available. Refer to the “Information and Updates” section of this guide for instructions on downloading and installing the updated software.

1. Turn on the computer.
2. Log on to the system. (The Found New Hardware wizard is displayed.)
3. Insert the WLAN software CD included with this option kit into the optical drive of the computer. (The Found New Hardware wizard installs the device driver from the CD.)

 If the Found New Hardware wizard does not automatically load the driver from the CD, follow the prompts to point the wizard to the CD drive to install the device driver)

Installation of the device driver is complete.

 If you are using Microsoft® Windows® 2000, or if your wireless network requires Cisco Client Extensions (such as LEAP), you must also install the appropriate Wireless LAN utility (Atheros Client Utility or Intel® ProSET) to configure the WLAN device correctly. Both Wireless LAN utilities are located on the WLAN Software CD included with your option kit.

 If you have problems with the installation, contact your network administrator for assistance.

Korean

Removing a WLAN Mini PCI Card

CAUTION: To prevent electrostatic discharge from damaging electronic components, discharge yourself of static electricity by touching a grounded metal object.

1. Follow the procedures in the “Before You Begin” section.
2. Carefully disconnect the 2 antenna cables from the Mini PCI card by lifting the cable connector with a fingernail or small screwdriver.

CAUTION: Do not pull on the antenna cable to remove it. Grip and pull only on the connector itself. Pulling on the cable can damage or break off the connector.

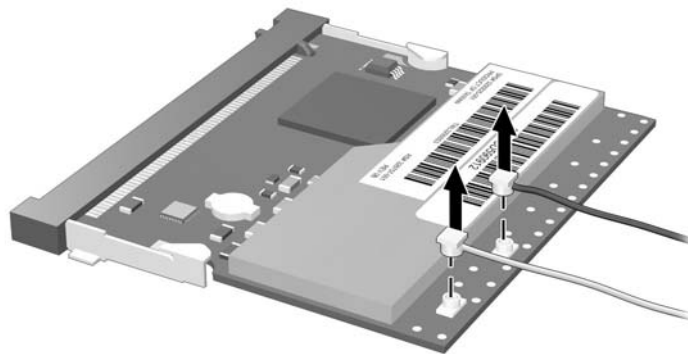

3. Pull the release latches **1** in the direction shown and pull the WLAN Mini PCI card up **2** and out **3** at an angle.

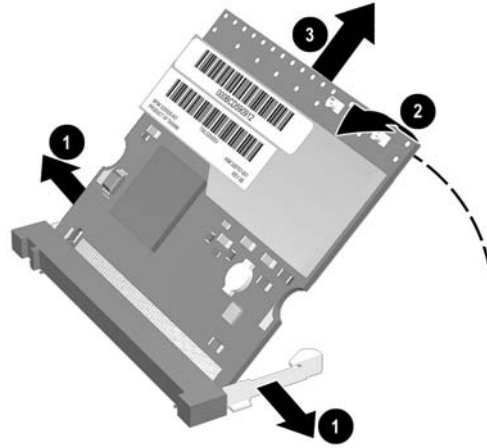

If you have problems with the removal, contact your network administrator for assistance.

Korean

Information and Updates

HP strongly recommends that you install any software upgrades that are available from HP for your WLAN Mini PCI card. Most software at the HP Web site is packaged in a compressed file called a Softpaq. You will download the Softpaq and save it to your hard drive.

To obtain software upgrades:

1. Visit the HP Web site at www.hp.com/support.
2. Follow the on-screen instructions to identify your country or region.
3. Select the **download drivers and software** radio button, and then enter the product information for your computer series name and device.

Refer to the *Notebook Documentation CD* or *Tablet PC Documentation CD* for further product details.

S Chinese

Before You Begin

 **CAUTION:** To prevent an unresponsive system and the display of a warning message, install only a Mini PCI device authorized for use in your computer by the governmental agency that regulates wireless devices in your country. If you install a device and then receive a warning message, remove the device to restore computer functionality. Then contact Customer Care. For information about contacting Customer Care, refer to the printed *Help and Support Guide* included with your computer.

Before you begin any installation or removal procedures:

1. Save your work, exit all applications, and shut down the computer. If you are not sure whether the computer is off or in Hibernation, turn the computer on, and then shut it down through the operating system.
2. Disconnect all external devices connected to the computer.
3. Disconnect the power cord.
4. Remove the battery pack.
5. Refer to the documentation included with your computer to
 - Identify the Mini PCI slot location.
 - Access the Mini PCI slot. The Mini PCI slot can usually be accessed via a panel on the bottom of the computer but sometimes it is located beneath the keyboard.

S Chinese

Installing the WLAN Mini PCI Card

 **CAUTION:** To prevent electrostatic discharge from damaging electronic components, discharge yourself of static electricity by touching a grounded metal object.

 If your computer has a WLAN Mini PCI card currently installed, you must remove it before installing the new card. Refer to the “Removing a WLAN Mini PCI Card” section.

1. Follow the procedures in the “Before You Begin” section.
2. Remove the plastic covers (if applicable) from the 2 antenna connector cables in the system.

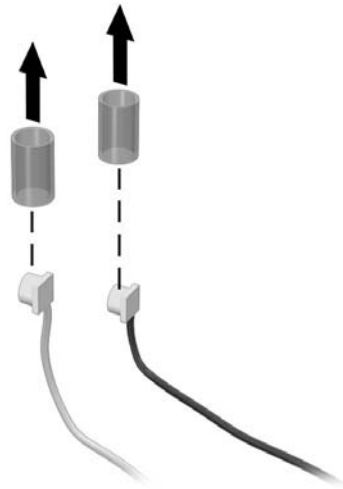

3. Insert the card into the slot at an angle ❶ and press the Mini PCI card down ❷ until the side latches snap into place.

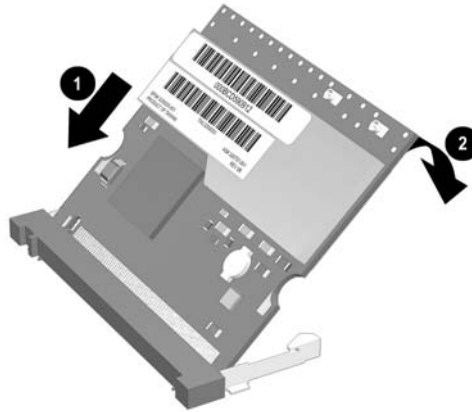

S Chinese

4. Connect the 2 antenna cables to the Mini PCI card. The gray (aux) cable connects to the antenna connector closest to the edge of the Mini PCI card, and the black (main) cable connects to the antenna connector closer to the center of the card, as shown in the following illustration.

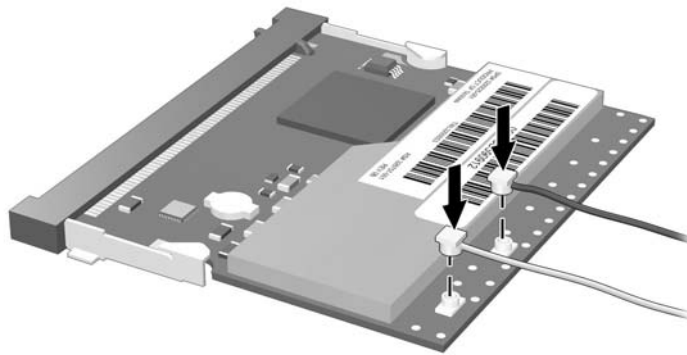

△ When connecting the antenna cables, be sure to connect the cables straight down and press firmly until they are fully seated. If antenna cable is inserted into connector at an angle, the center pin of the antenna connector could be damaged.

5. To complete the procedure, reverse the steps in the “Before You Begin” section.

✎ Be careful not to pinch the cables or damage the connectors. This could reduce wireless performance or cause the Mini PCI device to function improperly. Tuck any excess cable inside the system enclosure.

Installing the WLAN Mini PCI Card Software

The installation CD included in this option kit contains the necessary WLAN software and drivers for the Mini PCI card. To install the WLAN software:

 Updates to the software contained on the CD may be available. Refer to the “Information and Updates” section of this guide for instructions on downloading and installing the updated software.

1. Turn on the computer.
2. Log on to the system. (The Found New Hardware wizard is displayed.)
3. Insert the WLAN software CD included with this option kit into the optical drive of the computer. (The Found New Hardware wizard installs the device driver from the CD.)

 If the Found New Hardware wizard does not automatically load the driver from the CD, follow the prompts to point the wizard to the CD drive to install the device driver)

Installation of the device driver is complete.

 If you are using Microsoft® Windows® 2000, or if your wireless network requires Cisco Client Extensions (such as LEAP), you must also install the appropriate Wireless LAN utility (Atheros Client Utility or Intel® ProSET) to configure the WLAN device correctly. Both Wireless LAN utilities are located on the WLAN Software CD included with your option kit.

 If you have problems with the installation, contact your network administrator for assistance.

S Chinese

Removing a WLAN Mini PCI Card

CAUTION: To prevent electrostatic discharge from damaging electronic components, discharge yourself of static electricity by touching a grounded metal object.

1. Follow the procedures in the “Before You Begin” section.
2. Carefully disconnect the 2 antenna cables from the Mini PCI card by lifting the cable connector with a fingernail or small screwdriver.

CAUTION: Do not pull on the antenna cable to remove it. Grip and pull only on the connector itself. Pulling on the cable can damage or break off the connector.

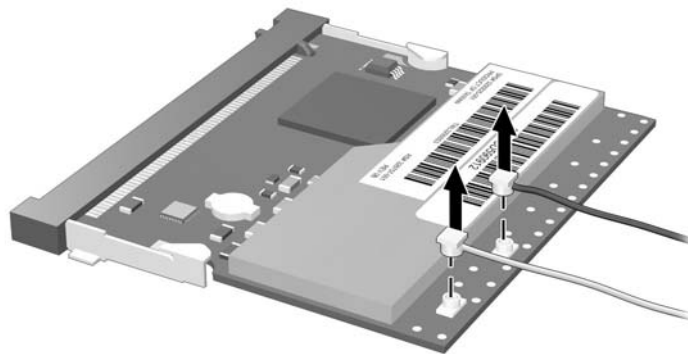

3. Pull the release latches **1** in the direction shown and pull the WLAN Mini PCI card up **2** and out **3** at an angle.

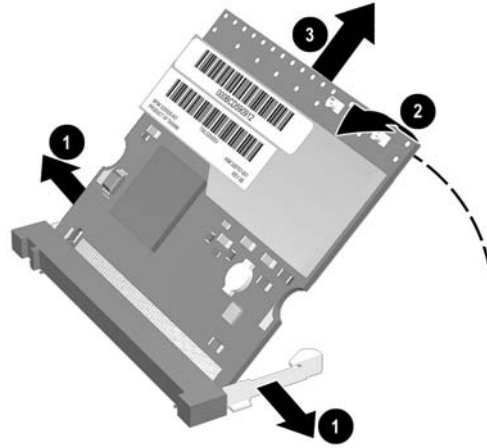

If you have problems with the removal, contact your network administrator for assistance.

S Chinese

Information and Updates

HP strongly recommends that you install any software upgrades that are available from HP for your WLAN Mini PCI card. Most software at the HP Web site is packaged in a compressed file called a Softpaq. You will download the Softpaq and save it to your hard drive.

To obtain software upgrades:

1. Visit the HP Web site at www.hp.com/support.
2. Follow the on-screen instructions to identify your country or region.
3. Select the **download drivers and software** radio button, and then enter the product information for your computer series name and device.

Refer to the *Notebook Documentation CD* or *Tablet PC Documentation CD* for further product details.

T Chinese

Before You Begin

 **CAUTION:** To prevent an unresponsive system and the display of a warning message, install only a Mini PCI device authorized for use in your computer by the governmental agency that regulates wireless devices in your country. If you install a device and then receive a warning message, remove the device to restore computer functionality. Then contact Customer Care. For information about contacting Customer Care, refer to the printed *Help and Support Guide* included with your computer.

Before you begin any installation or removal procedures:

1. Save your work, exit all applications, and shut down the computer. If you are not sure whether the computer is off or in Hibernation, turn the computer on, and then shut it down through the operating system.
2. Disconnect all external devices connected to the computer.
3. Disconnect the power cord.
4. Remove the battery pack.
5. Refer to the documentation included with your computer to
 - Identify the Mini PCI slot location.
 - Access the Mini PCI slot. The Mini PCI slot can usually be accessed via a panel on the bottom of the computer but sometimes it is located beneath the keyboard.

T Chinese

Installing the WLAN Mini PCI Card

 **CAUTION:** To prevent electrostatic discharge from damaging electronic components, discharge yourself of static electricity by touching a grounded metal object.

 If your computer has a WLAN Mini PCI card currently installed, you must remove it before installing the new card. Refer to the “Removing a WLAN Mini PCI Card” section.

1. Follow the procedures in the “Before You Begin” section.
2. Remove the plastic covers (if applicable) from the 2 antenna connector cables in the system.

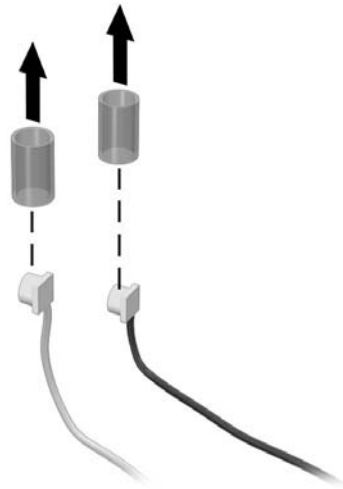

3. Insert the card into the slot at an angle ❶ and press the Mini PCI card down ❷ until the side latches snap into place.

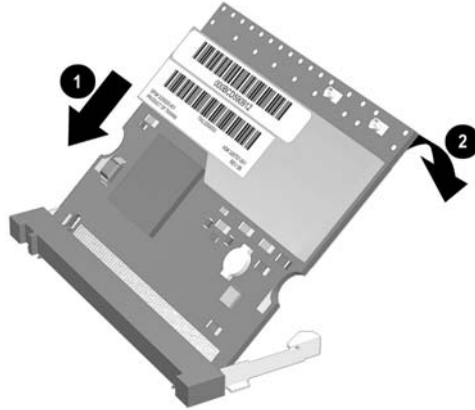

T Chinese

4. Connect the 2 antenna cables to the Mini PCI card. The gray (aux) cable connects to the antenna connector closest to the edge of the Mini PCI card, and the black (main) cable connects to the antenna connector closer to the center of the card, as shown in the following illustration.

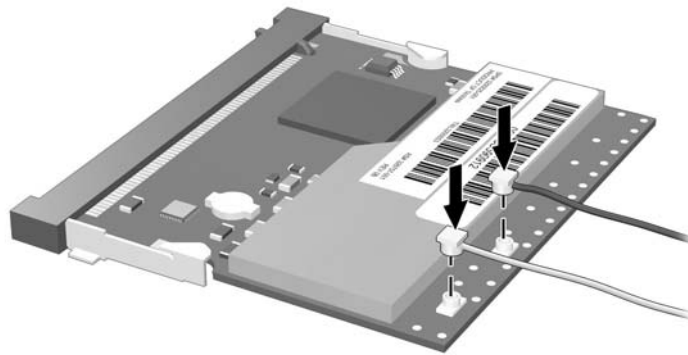

△ When connecting the antenna cables, be sure to connect the cables straight down and press firmly until they are fully seated. If antenna cable is inserted into connector at an angle, the center pin of the antenna connector could be damaged.

5. To complete the procedure, reverse the steps in the “Before You Begin” section.

✎ Be careful not to pinch the cables or damage the connectors. This could reduce wireless performance or cause the Mini PCI device to function improperly. Tuck any excess cable inside the system enclosure.

Installing the WLAN Mini PCI Card Software

The installation CD included in this option kit contains the necessary WLAN software and drivers for the Mini PCI card. To install the WLAN software:

 Updates to the software contained on the CD may be available. Refer to the “Information and Updates” section of this guide for instructions on downloading and installing the updated software.

1. Turn on the computer.
2. Log on to the system. (The Found New Hardware wizard is displayed.)
3. Insert the WLAN software CD included with this option kit into the optical drive of the computer. (The Found New Hardware wizard installs the device driver from the CD.)

 If the Found New Hardware wizard does not automatically load the driver from the CD, follow the prompts to point the wizard to the CD drive to install the device driver)

Installation of the device driver is complete.

 If you are using Microsoft® Windows® 2000, or if your wireless network requires Cisco Client Extensions (such as LEAP), you must also install the appropriate Wireless LAN utility (Atheros Client Utility or Intel® ProSET) to configure the WLAN device correctly. Both Wireless LAN utilities are located on the WLAN Software CD included with your option kit.

 If you have problems with the installation, contact your network administrator for assistance.

T Chinese

Removing a WLAN Mini PCI Card

CAUTION: To prevent electrostatic discharge from damaging electronic components, discharge yourself of static electricity by touching a grounded metal object.

1. Follow the procedures in the “Before You Begin” section.
2. Carefully disconnect the 2 antenna cables from the Mini PCI card by lifting the cable connector with a fingernail or small screwdriver.

CAUTION: Do not pull on the antenna cable to remove it. Grip and pull only on the connector itself. Pulling on the cable can damage or break off the connector.

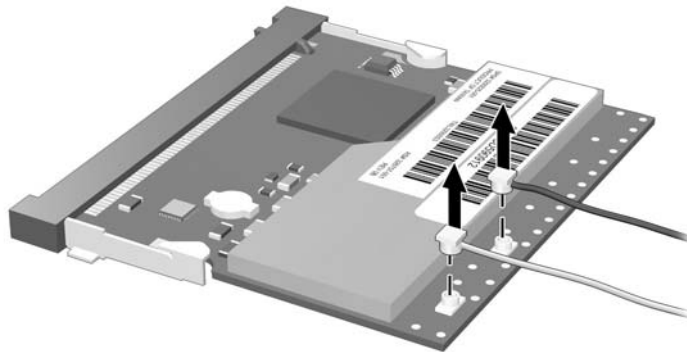

3. Pull the release latches **1** in the direction shown and pull the WLAN Mini PCI card up **2** and out **3** at an angle.

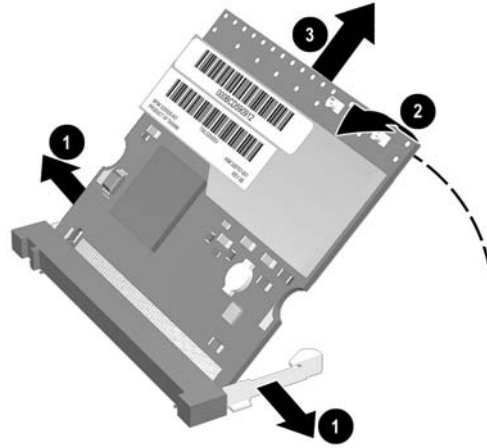

If you have problems with the removal, contact your network administrator for assistance.

T Chinese

Information and Updates

HP strongly recommends that you install any software upgrades that are available from HP for your WLAN Mini PCI card. Most software at the HP Web site is packaged in a compressed file called a Softpaq. You will download the Softpaq and save it to your hard drive.

To obtain software upgrades:

1. Visit the HP Web site at www.hp.com/support.
2. Follow the on-screen instructions to identify your country or region.
3. Select the **download drivers and software** radio button, and then enter the product information for your computer series name and device.

Refer to the *Notebook Documentation CD* or *Tablet PC Documentation CD* for further product details.

Regulatory Notices

In some environments, the use of wireless devices may be restricted. Such restrictions may apply aboard airplanes, in hospitals, near explosives, in hazardous locations, etc. If you are uncertain of the policy that applies to the use of this device, please ask for authorization to use it prior to turning it on.

U.S. Wireless Notice

**WARNING: Exposure to Radio Frequency Radiation**

The radiated output power of this device is below the FCC radio frequency exposure limits. Nevertheless, the device should be used in such a manner that the potential for human contact during normal operation is minimized. To avoid the possibility of exceeding the FCC radio frequency exposure limits, human proximity to the antenna should not be less than 20 cm (8 inches) during normal operation, including when the computer display is closed.



CAUTION: When using IEEE 802.11a wireless LAN, this product is restricted to indoor use due to its operation in the 5.15- to 5.25-GHz frequency range. The FCC requires this product to be used indoors for frequency range 5.15- to 5.25-GHz to reduce the potential for harmful interference to co-channel Mobile Satellite systems. High power radar is allocated as the primary user of the 5.25- to 5.35-GHz and 5.65- to 5.85-GHz bands. These radar stations can cause interference with and/or damage this device.

Regulatory Notices

Canadian Wireless Notice

Operation is subject to the following 2 conditions: (1) this device may not cause interference, and (2) this device must accept any interference, including interference that may cause undesired operation of the device.

European Union Wireless Notice

This notice is for wireless LAN radio products that will be used indoors, specifically in the home and office environment operating in the 2.4-GHz and 5.0-GHz band.

CE 0336 !

CE 0682 !

CE 0984 !

Declaration of Conformity

This product complies with the following EU directives:

- Low Voltage Directive (72/73/EEC)
- EMC Directive (89/336/EEC)
- R&TTE Directive (1999/5/EC)

CE compliance of this equipment is valid only if powered with a CE-marked AC adapter provided by HP.

Compliance with these directives implies conformity to the following European Norms (in parentheses are the equivalent international standards and regulations):

- EN 55022 (CISPR 22)—Electromagnetic interference
- EN 55024 (IEC 61000-4-2, 3, 4, 5, 6, 8, 11)—Electromagnetic immunity
- EN 61000-3-2 (IEC 61000-3-2)—Power line harmonics
- EN 61000-3-3 (IEC 61000-3-3)—Power line flicker
- EN 60950 (IEC 60950)—Product safety
- EN 300 328-2—Data transmission equipment operating in the 2.4-GHz ISM band and using 2.4-GHz radio equipment using spread spectrum techniques
- EN 301 489-1, -17—General EMC requirements for radio equipment
- EN 301 893—Broadband Radio Access Networks (BRAN); 5-GHz high performance RLAN

The 2.4-GHz and 5.0-GHz radio functionality of this product may be used in the following EU, EU candidate, and EFTA countries: Austria, Belgium, Cyprus, Czech Republic, Denmark, Estonia, Finland, France, Germany, Greece, Hungary, Iceland, Ireland, Italy, Latvia, Liechtenstein, Lithuania, Luxembourg, Malta, Netherlands, Norway, Poland, Portugal, Slovak Republic, Slovenia, Spain, Sweden, Switzerland, and United Kingdom.

Regulatory Notices

France

L'utilisation de cet équipement (2.4GHz Wireless LAN) est soumise à certaines restrictions : cet équipement peut être utilisé à l'intérieur d'un bâtiment en utilisant toutes les fréquences de 2400 à 2483.5MHz (Chaîne 1-13). Pour une utilisation en environnement extérieur, vous devez utiliser les fréquences comprises entre 2454 à 2483.5MHz (Chaîne 10-13). Pour les dernières restrictions, voir <http://www.art-telecom.fr>.

Italy

E' necessaria una concessione ministeriale anche per l'uso del prodotto. Verifici per favore con il proprio distributore o direttamente presso la Direzione Generale Pianificazione e Gestione Frequenze. License required for use.

Verify with your dealer or directly with General Direction for Frequency Planning and Management (Direzione Generale Pianificazione e Gestione Frequenze).

Indian Wireless Notice

The India Telegraph Act of 1885 requires that an IEEE 802.11a or IEEE 802.11g wireless LAN end user obtain a license. To obtain this license, please contact The Wireless Planning & Coordination Wing, Ministry of Communications, Sanchar Ghavan New Delhi.

Brazilian Wireless Notice

Este equipamento opera em caráter secundário, isto é, não tem direito a proteção contra interferência prejudicial, mesmo de estações do mesmo tipo, e não pode causar interferência a sistemas operando em caráter primário.

Japanese Wireless Notice

この機器の使用周波数帯では、電子レンジ等の産業・科学・医療用機器のほか工場の製造ライン等で使用されている移動体識別用の構内無線局（免許を要する無線局）及び特定小電力無線局（免許を要しない無線局）が運用されています。

- 1 この機器を使用する前に、近くで移動体識別用の構内無線局及び特定小電力無線局が運用されていないことを確認して下さい。
- 2 万一、この機器から移動体識別用の構内無線局に対して電波干渉の事例が発生した場合には、速やかに使用周波数を変更するか又は電波の発射を停止した上、下記連絡先にご連絡頂き、混信回避のための処置等（例えば、パーティションの設置など）についてご相談して下さい。
- 3 その他、この機器から移動体識別用の特定小電力無線局に対して電波干渉の事例が発生した場合など何かお困りのことが起きたときは、次の連絡先へお問い合わせ下さい。

連絡先：日本ヒューレット・パッカード株式会社 TEL：0120-014121

5 GHz帯を使用する特定無線設備（802.11a相当）は屋内使用に限られています。

2.4DS1

2.4DS4

2.4DS5

2.4OF3

2.4OF4

Federal Communications Commission Notice

This equipment has been tested and found to comply with the limits for a Class B digital device, pursuant to Part 15 of the FCC Rules. These limits are designed to provide reasonable protection against harmful interference in a residential installation. This equipment generates, uses, and can radiate radio frequency energy and, if not installed and used in accordance with the instructions, may cause harmful interference to radio communications. However, there is no guarantee that interference will not occur in a particular installation. If this equipment does cause harmful interference to radio or television reception, which can be determined by turning the equipment off and on, the user is encouraged to try to correct the interference by one or more of the following measures:

- Reorient or relocate the receiving antenna.
- Increase the separation between the equipment and receiver.
- Connect the equipment to an outlet on a circuit different from that to which the receiver is connected.
- Consult the dealer or an experienced radio or television technician for help.

Modifications

The FCC requires the user to be notified that any changes or modifications made to this device that are not expressly approved by Hewlett-Packard Company may void the user's authority to operate the equipment.

Declaration of Conformity for Products Marked with the FCC Logo (United States Only)

This device complies with Part 15 of the FCC Rules. Operation is subject to the following 2 conditions: (1) this device may not cause harmful interference, and (2) this device must accept any interference received, including interference that may cause undesired operation.

For questions regarding your product that are not related to this declaration, write to:

Hewlett-Packard Company
P. O. Box 692000, Mail Stop 530113
Houston, TX 77269-2000

For questions regarding this declaration, write to:

Hewlett-Packard Company
P.O. Box 692000, Mail Stop 510101
Houston, TX 77269-2000

Or call 281-514-3333.

To identify your product, refer to the part, series, or model number found on the product.

Canadian Notice (Avis Canadien)

This Class B digital apparatus meets all requirements of the Canadian Interference-Causing Equipment Regulations. Cet appareil numérique de la classe B respecte toutes les exigences du Règlement sur le matériel brouilleur du Canada.

