



# Getting Started

## HP Business Notebook PC

Document Part Number: 435748-001

March 2007

This guide explains how to set up your hardware and software, and begin using the computer in Windows®.

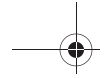

© Copyright 2007 Hewlett-Packard Development Company, L.P.

Windows is a U.S. registered trademark of Microsoft Corporation.  
Bluetooth is a trademark owned by its proprietor and used by  
Hewlett-Packard Company under license.

The information contained herein is subject to change without notice. The  
only warranties for HP products and services are set forth in the express  
warranty statements accompanying such products and services. Nothing  
herein should be construed as constituting an additional warranty. HP shall  
not be liable for technical or editorial errors or omissions contained herein.

Getting Started  
HP Business Notebook PC  
First Edition: March 2007  
Document Part Number: 435748-001

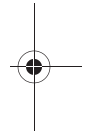

#### Product notice

This user guide describes features that are common to most models. Some  
features may not be available on your computer.

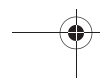

---

# Contents

## 1 First-time setup

Identifying required hardware . . . . .	1-1
Setting up the computer . . . . .	1-3
Step 1: Insert the battery . . . . .	1-4
Step 2: Connect the computer to external power. . . . .	1-5
Step 3: Turn on the computer . . . . .	1-6
Step 4: Set up the software . . . . .	1-8
Step 5: Create recovery discs (recommended) . . . . .	1-8

## 2 Quick tour

Identifying required hardware . . . . .	2-1
Top components . . . . .	2-2
Front components . . . . .	2-3
Left-side components . . . . .	2-4
Right-side components . . . . .	2-5
Rear components . . . . .	2-6
Bottom components . . . . .	2-7
Wireless antennae (select models only). . . . .	2-8

---

 Contents
 

---

### 3 Next steps

Protecting the computer . . . . .	3-1
Protecting the computer from viruses . . . . .	3-1
Protecting your system files . . . . .	3-2
Protecting your privacy . . . . .	3-2
Protecting the computer from power surges . . . . .	3-2
Using the computer safely . . . . .	3-3
Connecting to a computer network . . . . .	3-5
Installing additional hardware and software . . . . .	3-6
Identifying and installing hardware . . . . .	3-6
Locating and installing software . . . . .	3-6
Updating the software installed on the computer . . . . .	3-7
Finding the user guides . . . . .	3-8
Turning off the computer correctly . . . . .	3-8

### 4 Troubleshooting

Troubleshooting resources . . . . .	4-1
Quick troubleshooting . . . . .	4-2
The computer is unable to start up. . . . .	4-2
The computer screen is blank . . . . .	4-3
Software is functioning abnormally . . . . .	4-4
The computer is turned on but not responding . . . . .	4-4
The computer is unusually warm. . . . .	4-5
An external device is not working. . . . .	4-6
The WLAN connection is not working . . . . .	4-6
Help and Support . . . . .	4-7
Contacting technical support . . . . .	4-8

### A Connect to the Internet from your home

Choosing an ISP . . . . .	A-1
Using the New Connection Wizard . . . . .	A-2
Choosing the type of Internet connection . . . . .	A-2

## **B Backup and recovery**

Creating recovery discs . . . . .	B-1
Backing up your information . . . . .	B-2
When to back up . . . . .	B-2
Back up suggestions . . . . .	B-3
Backing up specific files or folders . . . . .	B-4
Backing up the entire hard drive . . . . .	B-4
Creating recovery points . . . . .	B-5
Scheduling backups . . . . .	B-6
Performing a recovery . . . . .	B-7
Performing a recovery from the recovery discs . . . . .	B-7
Performing a recovery from the hard drive . . . . .	B-7

## **C Specifications**

Operating environment . . . . .	C-1
Rated input power . . . . .	C-2

## **Index**

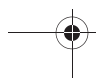
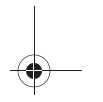
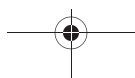
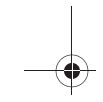
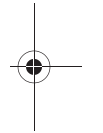
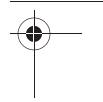
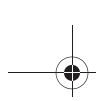
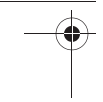

# 1

---

## First-time setup

### Identifying required hardware

To set up the computer for the first time, you will need the computer, the AC adapter, the power cord, and the primary battery.



---

Components included with the computer may vary by region and by model.

---

*First-time setup*



Component	Component
❶ Power cord	❷ Country-specific modem adapter (select models only)
❸ AC adapter	❹ Modem cable (select models only) (optional for setup)
❺ Primary battery	

 Use only the AC adapter provided with the computer or one approved for this computer.

 Unless you use dial-up networking, the modem cable is optional for setup.



## Setting up the computer

Computer setup involves the following tasks:

1. Inserting the battery into the computer
2. Connecting the computer to external power

 The battery begins to charge.

3. Turning on the computer
4. Setting up the software
5. Creating recovery discs (recommended)

 Refer to Appendix B, “Backup and recovery,” for instructions.

 **CAUTION:** Reduce the risk of file corruption by observing the following practices during the hardware and software setup procedures:

- Do not unplug the computer from external power.
- Do not shut down the computer or initiate Standby or Hibernation.

*First-time setup*

---

## Step 1: Insert the battery

To insert a primary battery:

1. Turn the computer upside down on a flat surface, with the battery bay toward you.
2. Slide the battery ❶ into the battery bay until it is seated.  
The battery release latches ❷ automatically lock the battery into place.

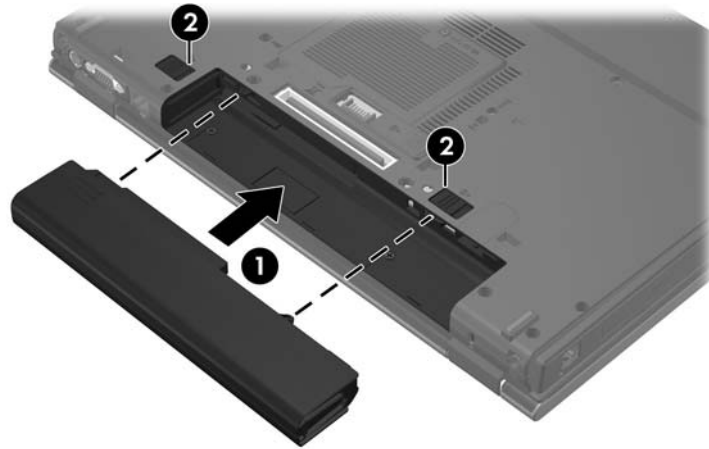

## Step 2: Connect the computer to external power

 Power cords and AC outlets vary in appearance by region and country.

To connect the computer to external AC power:

1. Plug the AC adapter into the power connector **1** on the computer.
2. Plug the power cord into the AC adapter **2**.
3. Plug the other end of the power cord into an AC outlet **3**.

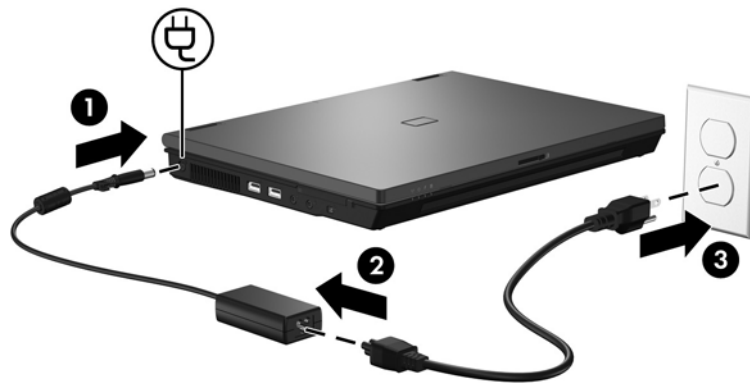

### First-time setup

---

When the computer receives AC power, the battery begins to charge and the battery light (on the front of the computer) turns on. When the battery is fully charged, the battery light turns off.

Leave the computer connected to external power until the battery is fully charged and the battery light turns off.



A partially charged new battery can run the computer after software setup is complete, but battery charge displays will not be accurate until the new battery has been fully charged.

---

## Step 3: Turn on the computer

To open the computer:

1. Slide the display release latch **1** to the right to release the display.
2. Raise the display **2**.

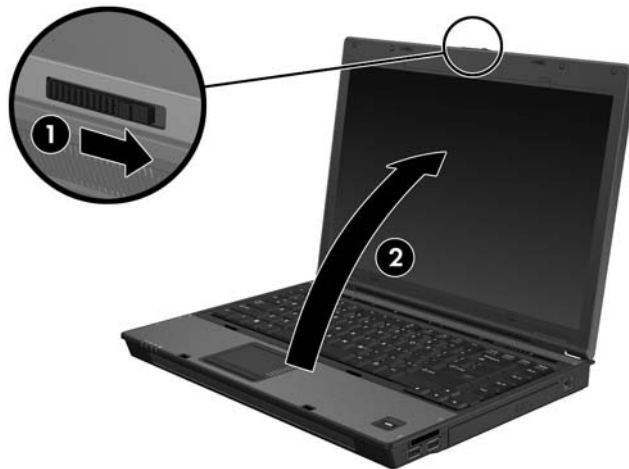

To turn on the computer:

» Press the power button **1**.

The power light on the power button **2** turns on.

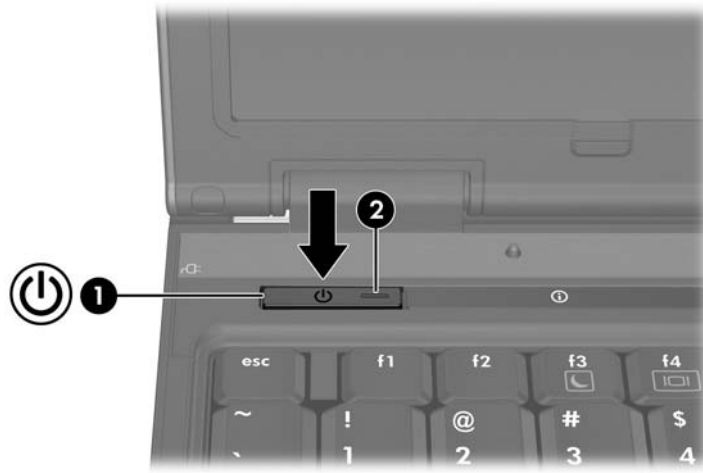

---

*First-time setup*

---

## Step 4: Set up the software

After the computer is turned on, it will go through software setup. Follow the on-screen instructions to set up the software. Note the following points:

- After you respond to the setup prompt, you must complete the entire setup process without interruption. Setup time varies.
- During software setup, the computer may pause periodically for several minutes. These normal pauses are indicated by an hourglass icon.

---

 **CAUTION:** If you are prompted to select an operating system language before the “Welcome to Windows” page is displayed, choose carefully. On some models, the languages that you do not choose are deleted from the system and cannot be restored during software setup.

---

 To register the operating system and the computer during software setup, the computer must be connected by an RJ-45 (network) cable to an existing network that has access to the Internet. If you do not register during software setup, you can do so at any time after software setup is complete. For more information about connecting to the Internet, refer to Appendix A, “Connect to the Internet from your home,” in this guide.

---

## Step 5: Create recovery discs (recommended)

You can create a set of recovery discs of your full factory image using HP Backup and Recovery Manager. You can use the recovery discs to start up (boot) the computer and restore the operating system and software programs to factory settings in case of system failure or instability.

Refer to Appendix B, “Backup and recovery,” for detailed instructions.

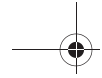

# 2

---

## Quick tour

### Identifying required hardware



---

Components included with the computer may vary by region and model. The illustrations in this chapter identify the standard features included on most computer models.

---

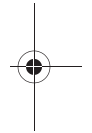

*Quick tour***Top components**

Component	Component
❶ Power button	❹ Internal microphone (select models only)
❷ Power lights (2)	❺ TouchPad scroll zone
❸ Info button (select models only)	❻ Fingerprint reader (select models only)
❹ Wireless button	❼ Right TouchPad button
❺ Wireless lights (2)	❽ Left TouchPad button
❻ Presentation button (select models only)	❿ Drive light
❼ Volume mute button	⓫ Battery light
❽ Volume scroll zone (select models only)	⓬ TouchPad



## Front components

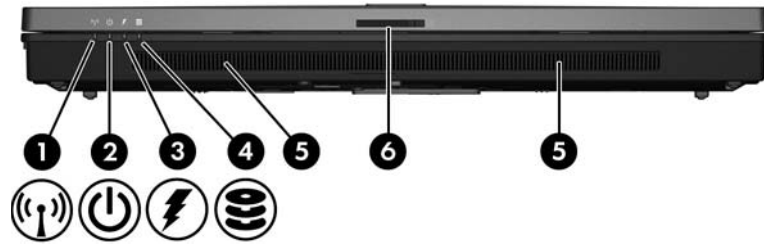

Component	Component
① Wireless light	④ Drive light
② Power light	⑤ Speakers (2)
③ Battery light	⑥ Display release latch

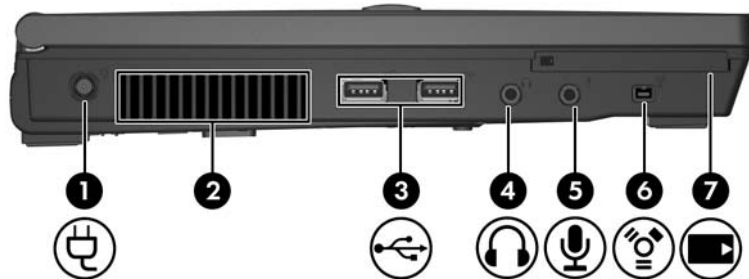
*Quick tour***Left-side components**

Component	Component
❶ Power connector	❺ Audio-in (microphone) jack
❷ Vent	❻ 1394 port (select models only)
❸ USB ports (2)	❼ PC Card slot
❹ Audio-out (headphone) jack	

## Right-side components

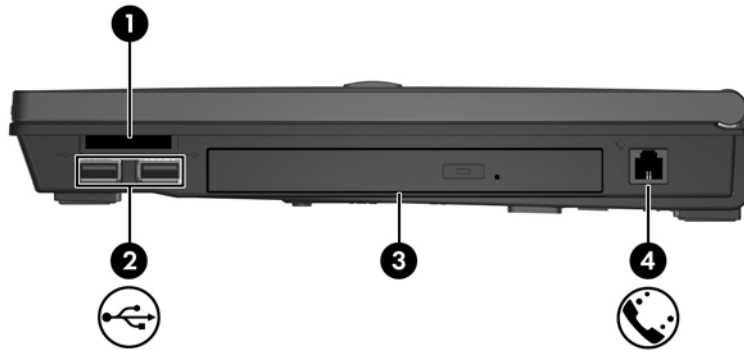

Component	Component
① Media Card Reader (select models only)	③ Optical drive
② USB ports (2) (select models only)	④ RJ-11 (modem) jack

*Quick tour*

## Rear components



Component	Component
❶ Security cable slot	❸ External monitor port
❷ RJ-45 (network) jack	❹ S-Video-out jack (select models only)

## Bottom components

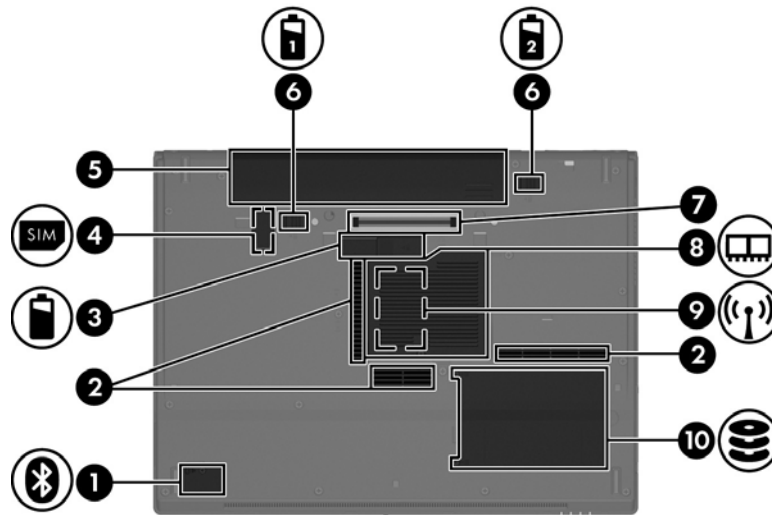

Component	Component
❶ Bluetooth® compartment (select models only)	❹ Battery release latches (2)
❷ Vents (3)	❺ Docking connector (select models only)
❸ Accessory battery connector	❻ Memory module compartment
❹ SIM slot (select models only)	❼ WLAN module compartment (select models only)
❺ Battery bay	❽ Hard drive bay

*Quick tour*

---

## Wireless antennae (select models only)

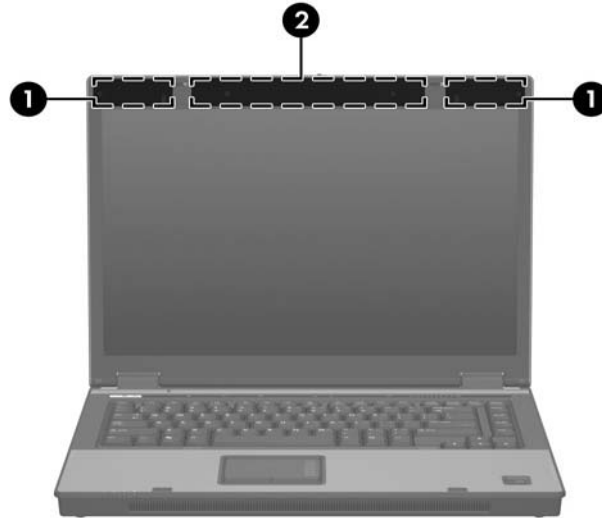

Component	Component
❶ WLAN antennae (2) (select models only)*	❷ WWAN antenna (select models only)*

\*The antennae are not visible from the outside of the computer. For optimal transmission, keep the areas immediately around the antennae free from obstructions.

# 3

## Next steps

### Protecting the computer

The information in this section explains how your computer can be protected from damage caused by a virus, a security breach, a power surge, unsafe operation, or system failure.

#### Protecting the computer from viruses

When you use the computer for e-mail, network, or Internet access, you expose it to computer viruses that can disable the operating system, applications, or utilities or cause them to function abnormally.

Antivirus software can detect most viruses, destroy them, and in most cases, repair any damage they have caused. To provide ongoing protection against newly discovered viruses, antivirus software must be kept up to date.

Norton Internet Security is preinstalled on the computer:

- Your version of Norton Internet Security includes 60 days of free updates. It is strongly recommended that you protect the computer against new viruses beyond 60 days by purchasing extended update service.
- For information about using and updating Norton Internet Security and for purchasing extended update service, select **Start > All Programs > Norton Internet Security > Help and Support**.
- To access Norton Internet Security, select **Start > All Programs > Norton Internet Security**.

*Next steps*

---

## Protecting your system files

The HP Backup and Recovery Manager provides several ways to back up the system and to recover optimal system functionality. Refer to Appendix B, “Backup and recovery,” for additional information.

## Protecting your privacy

When you use the computer for e-mail, network, or Internet access, it is possible for unauthorized persons to obtain information about you or the computer.

To optimize the computer’s privacy protection features, observe these practices:

- Keep the operating system and software updated. Many software updates contain security enhancements.
- Use a firewall. Firewall software monitors incoming traffic on the computer to block messages that do not meet specific security criteria. Some firewalls also monitor outgoing traffic.

## Protecting the computer from power surges

To protect the computer from the power surges that may be caused by an uncertain power supply or an electrical storm, observe these practices:

- Plug the computer power cord into an optional, high-quality surge protector. Surge protectors are available from most computer or electronics retailers.
- During an electrical storm, either run the computer on battery power or shut down the computer and unplug the power cord.
- If applicable to your location, provide surge protection on the modem cable that connects the modem to a telephone line. Telephone line surge protectors are available from most computer or electronic retailers in some regions.



Next steps

## Using the computer safely



**WARNING:** To reduce the risk of electric shock or damage to your equipment, observe these practices:

- Plug the power cord into an AC outlet that is easily accessible at all times.
- Disconnect power from the computer by unplugging the power cord from the AC outlet (not by unplugging the power cord from the computer).
- If provided with a 3-pin attachment plug on your power cord, plug the cord into a grounded (earthed) 3-pin outlet. Do not disable the power cord grounding pin, for example, by attaching a 2-pin adapter. The grounding pin is an important safety feature.



**WARNING:** To reduce the risk of serious injury, read the *Safety and Comfort Guide*. It describes proper workstation setup and proper posture, health, and work habits for computer users. The *Safety and Comfort Guide* also provides important electrical and mechanical safety information. This guide is available on the Web at <http://www.hp.com/ergo> and in Help and Support. To access the guide in Help and Support, select **Start > Help and Support > User Guides**.

*Next steps*

---

 **WARNING:** To avoid potential discomfort or burns, do not block the air vents or place the computer on your lap for extended periods. Also, do not allow the AC adapter to contact the skin for extended periods during operation. The computer is designed to run demanding applications at full power. As a result of increased power consumption, it is normal for the computer and the AC adapter to feel warm or hot when used continuously. The computer and the AC adapter comply with the user-accessible surface temperature limits defined by the International Standard for Safety of Information Technology Equipment (IEC 60950).

---

 **WARNING:** To reduce potential safety issues, use only the AC adapter or battery provided with the computer, a replacement AC adapter or battery provided by HP, or a compatible AC adapter or battery purchased as an accessory from HP.

---

For more safety and regulatory information, and for battery disposal information, refer to the *Regulatory, Safety and Environmental Notices* located in Help and Support. To access the notices in Help and Support, select **Start > Help and Support > User Guides**.

## Connecting to a computer network

The computer may have the following networking capabilities:

- Local area network (LAN)
- Wireless local area network (WLAN)
- Wireless wide area network (WWAN)
- Bluetooth®

If you plan to connect the computer to a home office LAN or WLAN, refer to Help and Support for information on networking. If you need assistance to connect to a company LAN or WLAN, contact your network administrator.



The computer display must be open before you can connect to a wireless network.

For information on activating broadband wireless service, refer to the mobile network operator information included with your computer.

If the computer has a Bluetooth device, you can create a personal area network (PAN) to connect to other Bluetooth-enabled devices, such as computers, telephones, printers, headsets, speakers, and cameras. For information on using a Bluetooth device, refer to Bluetooth online Help.

For information on connecting the computer to the Internet, refer to Appendix A, “Connect to the Internet from your home.”

*Next steps*

---

## Installing additional hardware and software

### Identifying and installing hardware

To see a list of hardware installed on the computer, follow these steps:

1. Select **Start > My Computer**.
2. In the left pane of the System Tasks window, click **View system information**.
3. Select **Hardware tab > Device Manager**.



You can also modify your device configurations using Device Manager.

---

To install additional hardware, such as an optional printer, follow the instructions provided by the hardware manufacturer to install the device and any required drivers.

### Locating and installing software

The computer includes software that is provided in the following forms:

- **Preinstalled on your hard drive.** To see a list of the ready-to-use software preinstalled on the computer, follow these steps:
  1. Click **Start > All Programs**.
  2. Click the program you want to open.

- **Provided on a CD or DVD.** To install a software program from a disc, follow these steps:
  1. Insert the disc into your optical drive.
  2. When the installation wizard opens, follow the on-screen instructions.
  3. Restart the computer if prompted to do so.
- **Preloaded software.** This is software provided on the hard drive but not ready to use. To locate or install preloaded software or drivers, follow these steps:
  1. Select **Start > All Programs > Software Setup**.
  2. Follow the on-screen instructions and select the check box next to the software program or driver you want to install.



For details about using software included with the computer, refer to the software manufacturer's instructions, which may be provided on disc, as online Help files, or on the manufacturer's Web site.

## Updating the software installed on the computer

Most software, including the operating system, is updated frequently by the manufacturer or provider. Important updates to the software included with the computer may have been released since the computer left the factory.

Some updates may affect the way the computer responds to optional software or external devices. Many updates provide security enhancements.

Update the operating system and other software provided on the computer as soon as the computer is connected to the Internet.

- » To access update links for the operating system and other software provided on the computer, select **Start > Help and Support**.

*Next steps*

---

## Finding the user guides

User guides, regulatory and safety notices, and other information resources about using the computer are available through Help and Support.

To access the user guides:

- » Select **Start > Help and Support > User Guides**.

## Turning off the computer correctly

Whenever possible, turn off the computer by using the standard shutdown procedure:

1. Save your work and close all open applications.
2. Shut down the computer through the operating system by selecting **Start > Turn Off Computer > Turn Off**.

 If you have been registered to a network domain, the button you click will be called Shut Down instead of Turn Off Computer.

If you are unable to turn off the computer with these procedures, try the following emergency shutdown procedures in the sequence provided:

 **CAUTION:** Using one of the following emergency shutdown procedures will result in the loss of unsaved information.

---

- Press **ctrl+alt+delete**. Then, select **Shut Down > Turn Off**.
- Press and hold the power button for at least 5 seconds.
- Disconnect the computer from external power and remove the battery.

# 4

---

## Troubleshooting

### Troubleshooting resources

If you experience computer problems, perform these troubleshooting steps in the order provided until the problem is resolved:

- Refer to “Quick troubleshooting,” the next section in this chapter.
- Access additional information about the computer and Web site links through Help and Support. Select **Start > Help and Support**.
  -  Although many checkup and repair tools require an Internet connection, other tools can help you fix a problem when the computer is offline.
- Contact technical support for further assistance.

## Quick troubleshooting

### The computer is unable to start up

To turn on the computer, press the power button. When the computer is turned on, the power light turns on.

If the computer and the power light are not turned on when you press the power button, adequate power may not be available to the computer.

The following suggestions may help you determine why the computer will not start up:

- If the computer is plugged into an AC outlet, be sure that the AC outlet is providing adequate power by plugging another electrical device into the outlet.
- If the power light on the front of the computer is blinking rapidly, replace the AC adapter with one having a higher power rating, and then plug the adapter into an AC outlet.
  -  Use only the AC adapter provided with the computer or one approved for this computer.
- If the computer is running on battery power or is plugged into an external power source other than an AC outlet, plug the computer into an AC outlet using the AC adapter. Be sure the power cord and AC adapter connections are secure.
- If the computer is running on battery power, try the following procedures in the sequence provided:
  - If the battery light on the front of the computer is blinking, the battery has reached a low battery level, which may not allow the computer to start up. Plug the computer into an AC outlet using the AC adapter, start the computer, and allow the battery to charge.
  - Remove the primary battery and optional accessory battery (if applicable) and plug the computer into an AC outlet using the AC adapter. If you can turn the computer on, one of the batteries may need to be replaced.



## The computer screen is blank

If the computer is on but the screen is blank: the computer may be in Standby or in Hibernation; the computer may not be set to display the image on the computer screen; or the display switch may not be functioning properly.

Try the following suggestions to resolve the issue:

- To exit Standby or Hibernation, briefly press the power button.

Standby and Hibernation are energy-saving features that can turn off the display. Standby and Hibernation can be initiated by the system while the computer is on but not in use, or when the computer has reached a low battery level. To change these and other power settings, select **Start > Control Panel > Performance and Maintenance > Power Options**.

- To transfer the image to the computer screen, press **fn+f4**.

On most models, when an optional external display device, such as a monitor, is connected to the computer, the image can be displayed on the computer screen or the external display, or on both devices simultaneously. When you press **fn+f4** repeatedly, the image alternates among the computer display, one or more external display devices, and simultaneous display on all devices.

- Press the display switch on the computer to be sure that it moves freely.

The display switch is normally located on the upper-left corner of the keyboard.

## Software is functioning abnormally

Follow these suggestions if the software becomes unresponsive or responds abnormally:

- Restart the computer:
  - In Windows XP Home, select **Start > Turn Off Computer > Restart**.
  - In Windows XP Professional, select **Start > Turn Off Computer > Restart > OK**. (If you have been registered to a domain, the button you click will be called Shut Down instead of Turn Off Computer.)

If you cannot restart the computer using these procedures, refer to the next section, “The computer is turned on but not responding.”

- Run a virus scan. For information about using the antivirus resources on the computer, refer to “Protecting the computer from viruses” in Chapter 3, “Next steps.”

## The computer is turned on but not responding

If the computer is turned on, but not responding to software or keyboard commands, turn off the computer by using the standard shutdown procedure:

1. Save your work and close all open applications.
2. Shut down the computer through the operating system by selecting **Start > Turn Off Computer > Turn Off**.

 If you have been registered to a network domain, the button you click will be called Shut Down instead of Turn Off Computer.

If you are unable to shut down the computer with these procedures, try the following emergency shutdown procedures in the sequence provided:

 **CAUTION:** Using one of the following emergency shutdown procedures will result in the loss of unsaved information.

- Press **ctrl+alt+delete**. Then, select **Shut Down > Turn Off**.
- Press and hold the power button for at least 5 seconds.
- Disconnect the computer from external power and remove the battery.

## The computer is unusually warm

It is normal for the computer to feel warm to the touch while it is in use. But if the computer feels *unusually* warm, it may be overheating because a vent is blocked.

If you suspect that the computer is overheating, allow the computer to cool to room temperature. Then be sure to keep all vents free from obstructions while you are using the computer.

 **CAUTION:** To prevent overheating, do not obstruct vents. Use the computer only on a hard, flat surface. Do not allow another hard surface, such as such as an adjoining printer, or a soft surface, such as pillows or thick rugs or clothing, to block airflow.

 The fan in the computer starts up automatically to cool internal components and prevent overheating. It is normal for the internal fan to cycle on and off during routine operation.

## An external device is not working

Follow these suggestions if an external device does not function as expected:

- Turn on the device as instructed in the device user guide. Some devices may not be powered by the computer, and must be turned on before the computer is turned on.
- Be sure that all device connections are secure.
- Be sure that the device is receiving electrical power.
- Be sure that the device, especially if it is an older one, is compatible with your operating system. For compatibility information, refer to the device manufacturer's Web site.
- Be sure that the correct drivers are installed and updated. Drivers may be available on a disc included with the device or on the device manufacturer's Web site. For more information about updating drivers, select **Start > Help and Support**.

## The WLAN connection is not working

If a WLAN connection is not working as expected, follow these suggestions:

- Be sure that the wireless light on the computer is on. If the light is off, press the wireless button to turn it on.
- Be sure that the computer wireless antennae are free from obstructions.
- Be sure that the cable or DSL modem and its power cord are properly connected, and the lights are on.

- If applicable, be sure that the wireless router (access point) is turned on and properly connected to the DSL or cable modem.
- Disconnect and then reconnect all cables, and turn the power off and then back on.

---

 For information on setting up a home wireless network connection, visit <http://www.hp.com/go/techcenter/wireless> (English only).

---

 For information on activating broadband wireless service, refer to the mobile network operator information included with your computer.

---

## Help and Support

If the preceding questions and solutions did not address your problem, access Help and Support by selecting **Start > Help and Support**. Help and Support provides the following assistance:

- Information about the computer, such as model and serial number, installed software, hardware components, and specifications
- Answers to questions about using the computer
- Product information to help you learn to use the computer and operating system features
- Updates for the operating system, device drivers, and software provided on the computer
- Checkups for computer functionality
- Automated and interactive troubleshooting, repair solutions, and system recovery procedures
- Links to community forums of IT experts

## Contacting technical support

If the computer is connected to the Internet, select **Start > Help and Support > Contact support** to get online help or to access the technical support telephone numbers.

For the fastest possible resolution of your problem, have the computer and the following information available when you call or e-mail:

- Product name located on the display or keyboard.
- Serial number (s/n) listed on the service tag.
  - The service tag label is on the bottom of the computer.
  - To display the service tag information on the computer screen, select **Start > Help and Support > My HP Computer**.
- Date the computer was purchased.
- Conditions under which the problem occurred.
- Error messages that have been displayed.
- The manufacturer and model of the printer or other accessories connected to the computer.
- Operating system version number and registration number.

To display the operating system version number and registration number, select **Start > Help and Support > My HP Computer**. (On some models, the registration number may be identified in the Operating System table as the *Product Id*).

# A

---

## Connect to the Internet from your home

The computer includes hardware and software that allows you to connect to the Internet. Before you can access the Internet, you must choose an Internet service provider (ISP) and choose the type of Internet connection you want, such as broadband (wired or wireless) or dial-up.



---

Internet hardware and software features vary depending on the computer model and your location.

---

### Choosing an ISP

You must set up Internet service before you can connect to the Internet. The computer includes the New Connection Wizard to help you set up a new Internet account or configure the computer to use an existing account.

*Connect to the Internet from your home*

---

## Using the New Connection Wizard

The New Connection Wizard works under the following conditions:

- You already have an account with an ISP.
  - You have a disc from an ISP.
  - You do not have an Internet account and would like to select an ISP from the list provided within the wizard.
  - You have selected an unlisted ISP and the ISP has provided you with such information as a specific IP address and POP3 and SMTP settings.
- » To access the New Connection Wizard, select **Start > Help and Support**.



---

If you are prompted within the wizard to choose between enabling or disabling the Windows Firewall, choose to enable the firewall.

---

## Choosing the type of Internet connection

There are 3 basic types of Internet connection:

- **Broadband service**—High-speed Internet access is provided by an ISP through one of the following services:
  - Cable modem
  - Digital Subscriber Line (DSL)
  - Satellite
  - Other services

Broadband service may require additional hardware and/or software provided by the ISP.



---

*Connect to the Internet from your home*

---

- **WLAN**—Internet connection through a WLAN requires broadband wired service with an ISP as well as a wireless router (purchased separately). To learn about setting up wireless access, see the HP Web site at <http://www.hp.com/go/techcenter/wireless> (English only).
- **WWAN**—This broadband wireless connection allows your computer to stay connected to the Internet over large geographic areas while the computer is in motion, such as in a car or train. WWAN capability requires an integrated HP Broadband Wireless Module (select models only) *and* service from a mobile network operator. For information on activating broadband wireless service, refer to the mobile network operator information included with your computer or see the HP Web site at <http://www.hp.com/go/broadbandwireless> (English only).
- **Dial-up**—You can access the Internet by dialing in to a service provider using a modem cable connected to the RJ-11 (modem) jack.

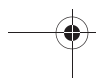
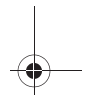
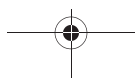
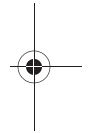
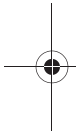
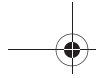

# B

---

## Backup and recovery

### Creating recovery discs

After setting up the computer for the first time, be sure to create a set of recovery discs of the full factory image. The recovery discs are used to start up (boot) the computer and recover the operating system and software to factory settings in case of system instability or failure.

Note the following guidelines before creating recovery discs:

- You will need high-quality CD-R, DVD-R, or DVD+R media (purchased separately).
  -  Formatted DVD±RW discs and DVD±RW double-layer discs are not compatible with HP Backup and Recovery Manager.
- The computer must be connected to AC power during the process.
- Only one set of recovery discs can be created per computer.
- Number each disc before inserting it into the optical drive of the computer.
- If necessary, you can cancel the disc creation before you have finished creating the recovery discs. The next time you select **Create factory software recovery CDs or DVDs to recover the system (Highly recommended)**, you will be prompted to continue the disc creation.

## Backup and recovery

---

To create a set of recovery discs, follow these steps:

1. Select **Start > All Programs > HP Backup & Recovery > HP Backup and Recovery Manager**.
2. Click **Next**.
3. Click **Create factory software recovery CDs or DVDs to recover the system (Highly recommended)**, and then click **Next**.
4. Follow the on-screen instructions.

## Backing up your information

---



You can only recover files that you have previously back up. HP recommends that you use HP Backup and Recovery Manager to create an entire drive backup as soon as you set up your computer.

---

With HP Backup and Recovery Manager, you can perform the following tasks:

- Backup up your information regularly to protect your important system files
- Creating system recovery points that allow you to reverse undesirable changes to your computer by restoring the computer to an earlier state
- Scheduling backups at specific intervals or events

## When to back up

- On a regularly scheduled basis
  -  Set reminders to back up your information periodically.
- Before the computer is repaired or restored
- Before you add or modify hardware or software

## Back up suggestions

- Create a set of recovery discs using HP Backup and Recovery Manager.
- Create system recovery points using HP Backup and Recovery Manager, and periodically copy them to disc.
- Store personal files in the My Documents folder and back up these folders periodically.
- Back up templates stored in their associated programs.
- Save customized settings in a window, toolbar, or menu bar by taking a screen shot of your settings.

The screen shot can be a time saver if you have to reset your preferences.

To copy the screen and paste it into a word-processing document:

1. Display the screen.
2. Copy the screen.

To copy only the active window, press **alt+fn+prt sc**.

To copy the entire screen, press **fn+prt sc**.

3. Open a word-processing document, and then select **Edit > Paste**.

---

 Before you can perform backup and recovery procedures, the computer must be connected to external power.

---

---

 Drivers, utilities, and applications installed by HP can be copied to a CD or to a DVD using HP Backup and Recovery Manager.

---

## Backing up specific files or folders

You can back up specific files or folders to the recovery partition on the hard drive, to an optional external hard drive, or to optical discs (CDs or DVDs).

 This process will take several minutes, depending on the file size and the speed of the computer.

---

To back up specific files or folders:

1. Select **Start > All Programs > HP Backup & Recovery > HP Backup and Recovery Manager**.
2. Click **Next**.
3. Click **Back up to protect system settings and important data files**, and then click **Next**.
4. Click **Back up individual files and folders** and then click **Next**.
5. Follow the on-screen instructions.

## Backing up the entire hard drive

When you perform a complete backup of the hard drive, you are saving the full factory image, including the Windows operating system, software applications, and all personal files and folders.

 A copy of the entire hard drive image can be stored on another hard drive, on a network drive, or on recovery discs that you create.

---

 This process may take over an hour, depending on your computer speed and the amount of data being stored.

---

To back up your entire hard drive:

1. Select **Start > All Programs > HP Backup & Recovery > HP Backup and Recovery Manager**.
2. Click **Next**.
3. Click **Back up to protect system settings and important data files**, and then click **Next**.
4. Follow the on-screen instructions.

## Creating recovery points

When you back up modifications since your last backup, you are creating system recovery points. This allows you to save a snapshot of your hard drive at a specific point in time. You can then recover back to that point if you want to reverse subsequent changes made to your system.



The first system recovery point, a snapshot of the entire image, is automatically created the first time you perform a backup. Subsequent recovery points make a copy of changes made after that time.

HP recommends that you create recovery points at the following times:

- Before you add or extensively modify software or hardware
- Periodically, whenever the system is performing optimally



Recovering to an earlier recovery point does not affect data files or e-mails created since that recovery point.

## *Backup and recovery*

---

To create a system recovery point:

1. Select **Start > All Programs > HP Backup & Recovery > HP Backup and Recovery Manager**.
2. Click **Next**.
3. Click **Back up to protect system settings and important data files**, and then click **Next**.
4. Click **Create or manage Recovery Points**, and then click **Next**.
5. Follow the on-screen instructions.

## **Scheduling backups**

Use HP Backup Scheduler to schedule backups for the entire system, for recovery points, or for specific files and folders. With this tool, you can schedule backups at specific intervals (daily, weekly, or monthly) or at specific events, such as system restart or when you dock to an optional docking station (select models only).

To schedule backups:

1. Select **Start > All Programs > HP Backup & Recovery > HP Backup Scheduler**.
2. Follow the on-screen instructions.



## Performing a recovery



You can only recover files that you have previously backed up. HP recommends that you use HP Backup and Recovery Manager to create an entire drive backup as soon as you set up your computer.

HP Backup and Recovery Manager helps you with the following tasks for safeguarding your information and restoring it in case of a system failure:

- Recovering important files—This feature helps you reinstall important files without performing a full system recovery.
- Performing a full system recovery—With HP Backup and Recovery Manager, you can recover your full factory image if you experience system failure or instability. HP Backup and Recovery Manager works from a dedicated recovery partition on the hard drive or from recovery discs you create.

## Performing a recovery from the recovery discs

To perform a recovery from the recovery discs, follow these steps:

1. Back up all personal files.
2. Insert the first recovery disc into the optical drive and restart the computer.
3. Follow the on-screen instructions.

## Performing a recovery from the hard drive

There are 2 ways to initiate a recovery from the hard drive:

- From within Windows
- From the recovery partition

## Initiating a recovery in Windows

To initiate a recovery in Windows, follow these steps:

1. Back up all personal files.
2. Select **Start > All Programs > HP Backup & Recovery > HP Backup and Recovery Manager**.
3. Click **Next**.
4. Click **Recover important files or the entire system**, and then click **Next**.
5. Follow the on-screen instructions.

## Initiating a recovery from the hard drive recovery partition

To initiate a recovery from the hard drive recovery partition, follow these steps:

1. Back up all personal files.
2. Restart the computer, and then press **f11** before the Windows operating system loads.
3. Click a recovery option, and then click **Next**.
4. Follow the on-screen instructions.

# C

## Specifications

### Operating environment

The operating environment information in the following table may be helpful if you plan to use or transport the computer in extreme environments.

Factor	Metric	U.S.
<b>Temperature</b>		
Operating (not writing to optical disc)	0°C to 35°C	32°F to 95°F
Operating (writing to optical disc)	5°C to 35°C	41°F to 95°F
Nonoperating	-20°C to 60°C	-4°F to 140°F
<b>Relative humidity (noncondensing)</b>		
Operating	10% to 90%	10% to 90%
Nonoperating	5% to 95%	5% to 95%
<b>Maximum altitude (unpressurized)</b>		
Operating (14.7 to 10.1 psia*)	-15 m to 3,048 m	-50 ft to 10,000 ft
Nonoperating (14.7 to 4.4 psia*)	-15 m to 12,192 m	-50 ft to 40,000 ft

\*Pounds per square inch absolute (psia) is a unit of measurement for altitude.

## Specifications

---

### Rated input power

The power information in this section may be helpful if you plan to travel internationally with the computer.

The computer operates on DC power, which can be supplied by an AC or a DC power source. Although the computer can be powered from a standalone DC power source, it should be powered only with an AC adapter or a DC power source supplied and approved by HP for use with this computer.

The computer is capable of accepting DC power within the following specifications.

Input power	Rating
Operating voltage	18.5 V dc @ 3.5 A - 65 W
Operating current	3.5 A

This product is designed for IT power systems in Norway with phase-to-phase voltage not exceeding 240 V rms.

---

# Index

1394 port, identifying 2-4

## A

AC adapter

- identifying 1-2
- using 1-5

accessory battery connector,  
identifying 2-7

altitude specifications C-1

antivirus software 4-4

audio-in (microphone) jack,  
identifying 2-4

audio-out (headphone) jack,  
identifying 2-4

## B

battery

- charging 1-6
- identifying 1-2
- inserting 1-4

battery bay, identifying 2-7

battery light

- behavior 1-6
- identifying 2-2, 2-3

battery release latch,  
identifying 2-7

bays

- battery 2-7
- hard drive 2-7

Bluetooth 3-5

Bluetooth compartment,  
identifying 2-7

buttons

- info 2-2
- power 1-7, 2-2
- presentation 2-2
- TouchPad 2-2
- volume mute 2-2
- wireless 2-2

## C

cables and cords, power 4-2

compartments

- Bluetooth 2-7
- memory module 2-7
- WLAN 2-7

computer

- turn off 3-8
- turn on 1-6

computer viruses 4-4

connecting the computer to  
external power 1-5

connecting to a computer  
network 3-5

---

*Index*

---

- connectors
  - accessory battery 2-7
  - docking 2-7
  - power 2-4
- country-specific modem adapter 1-2
- D**
- devices, external,
  - troubleshooting 4-6
- display release latch,
  - identifying 2-3
- display, switching image 4-3
- docking connector, identifying 2-7
- drive light, identifying 2-2, 2-3
- E**
- environmental specifications C-1
- external devices,
  - troubleshooting 4-6
- external monitor port,
  - identifying 2-6
- F**
- fingerprint reader, identifying 2-2
- firewalls 3-2
- H**
- hard drive bay, identifying 2-7
- Help and Support 4-7
- Hibernation 4-3
- humidity specifications C-1
- I**
- IEC 60950 compliance 3-4
- image, switching among
  - display devices 4-3
- info button, identifying 2-2
- inserting the battery 1-4
- internal microphone,
  - identifying 2-2
- Internet access A-2
- J**
- jacks
  - audio-in (microphone) 2-4
  - audio-out (headphone) 2-4
  - RJ-11 (modem) 2-5
  - RJ-45 (network) jack 2-6
  - S-Video-out 2-6
- L**
- labels, service tag 4-8
- LAN (local area network) 3-5
- latches
  - battery release 2-7
  - display release 2-3
- lights
  - battery 1-6, 2-2, 2-3
  - drive 2-2, 2-3
  - power 1-7, 2-2, 2-3
  - wireless 2-2, 2-3
- locating user guides 3-8
- M**
- Media Card Reader,
  - identifying 2-5
- memory module compartment,
  - identifying 2-7

- modem
  - setting up Internet service
    - A-2
  - surge protection 3-2
- modem cable 1-2
- monitor, external 4-3, 4-6
- N**
- network jack 2-6
- network, connecting computer
  - to 3-5
- New Connection Wizard A-2
- O**
- operating environment
  - specifications C-1
- operating system, version
  - number 4-8
- optical drive, identifying 2-5
- overheating, computer 3-4, 4-5
- P**
- PC Card slot, identifying 2-4
- ports
  - 1394 2-4
  - external monitor 2-6
  - USB 2-4, 2-5
- power
  - running the computer on
    - battery 1-6
  - turning on computer 1-7, 4-2
- power button, identifying 2-2
- power connector
  - identifying 2-4
  - using 1-5
- power cord
  - connecting 1-5
  - identifying 1-2
- power light 1-7, 4-2
- power lights, identifying 2-2, 2-3
- power surge 3-2
- presentation button,
  - identifying 2-2
- printer 4-6
- Product Id 4-8
- R**
- rated input power
  - specifications C-2
- registration number, operating
  - system 4-8
- regulatory information notices
  - 3-4
- Regulatory, Safety and Environmental Notices* 3-4
- RJ-11 (modem) jack,
  - identifying 2-5
- RJ-45 (network) jack 2-6
- S**
- Safety and Comfort Guide* 3-3
- scroll zone, TouchPad 2-2
- serial number, computer 4-8
- service tag 4-8
- security cable slot, identifying
  - 2-6
- SIM slot, identifying 2-7
- slot, SIM 2-7

---

 Index
 

---

- software
  - antivirus 3-1
  - setup 1-8
  - updates 3-7
- speakers, identifying 2-3
- specifications
  - operating environment C-1
  - rated input power C-2
- Standby 4-3
- S-Video-out jack, identifying 2-6
- T**
- technical support 4-8
- temperature
  - safety considerations 3-4
  - specifications C-1
  - troubleshooting 4-5
- TouchPad buttons, identifying 2-2
- TouchPad scroll zone, identifying 2-2
- TouchPad, identifying 2-2
- traveling with computer C-2
- troubleshooting
  - display problems 4-3
  - external device problems 4-6
  - Hibernation or Standby problems 4-3
  - overheating problems 4-5
  - resources 4-1
  - software problems 4-4
  - virus problems 4-4
  - wireless network problems 4-6
- turning off computer 3-8
- turning on computer 1-6, 4-2
- U**
- updates, software 3-7
- USB ports, identifying 2-4, 2-5
- user guides 3-8
- V**
- vents
  - identifying 2-4, 2-7
  - precautions 4-5
- viruses
  - antivirus software 3-1
  - computer 4-4
- volume mute button, identifying 2-2
- volume scroll zone, identifying 2-2
- W**
- wireless button, identifying 2-2
- wireless lights, identifying 2-2, 2-3
- WLAN (wireless local area network) 3-5
- WLAN antennae, identifying 2-8
- WLAN module compartment 2-7
- WWAN (wireless wide area network) 3-5
- WWAN antenna 2-8