

Template Last Updated -3/20/2007

Dell™ Latitude™ E4200

Setup and Quick Reference Guide

This guide provides a features overview, specifications, and quick setup, software, and troubleshooting information for your computer. For more information about your operating system, devices, and technologies, see the *Dell Technology Guide* at support.dell.com.

Model PP15S

Notes, Notices, and Cautions



NOTE: A NOTE indicates important information that helps you make better use of your computer.



NOTICE: A NOTICE indicates either potential damage to hardware or loss of data and tells you how to avoid the problem.



CAUTION: A CAUTION indicates a potential for property damage, personal injury, or death.

If you purchased a Dell™ n Series computer, any references in this document to Microsoft® Windows® operating systems are not applicable.

Information in this document is subject to change without notice.

© 2008 Dell Inc. All rights reserved.

Reproduction of these materials in any manner whatsoever without the written permission of Dell Inc. is strictly forbidden.

Trademarks used in this text: *Dell*, the *DELL* logo, *Latitude*, *Wi-Fi Catcher*, and *DellConnect* are trademarks of Dell Inc.; *Bluetooth* is a registered trademark owned by Bluetooth SIG, Inc., and is used by Dell under license; *Intel* is a registered trademark, and *Core* is a trademark of Intel Corporation in the U.S. and other countries; *Microsoft*, *Windows*, *Windows Vista*, and the *Windows Vista* start button logo are either trademarks or registered trademarks of Microsoft Corporation in the United States and/or other countries; *TouchStrip* is a trademark of UPEK, Inc.

Other trademarks and trade names may be used in this document to refer to either the entities claiming the marks and names or their products. Dell Inc. disclaims any proprietary interest in trademarks and trade names other than its own.

Model PP15S

July 2008 P/N H683D Rev. A00

Contents

| | | |
|----------|---|-----------|
| 1 | About Your Computer | 7 |
| | Front View | 7 |
| | Back View | 8 |
| | Battery Removal | 9 |
| | Wireless Switch and Dell™ Wi-Fi Catcher™ Network Locator | 9 |
| 2 | Setting Up Your Computer | 11 |
| | Quick Setup | 11 |
| | Connecting to the Internet | 14 |
| | Setting Up Your Internet Connection | 14 |
| | Transferring Information to a New Computer | 15 |
| | Microsoft® Windows Vista® Operating System | 15 |
| | Microsoft Windows® XP | 16 |
| 3 | Specifications | 21 |
| 4 | Troubleshooting Tips | 29 |
| | Using the Hardware Troubleshooter | 29 |
| | Tips | 29 |
| | Power Problems | 29 |

| | |
|--|-----------|
| Memory Problems | 30 |
| Lockups and Software Problems | 31 |
| Dell Technical Update Service | 32 |
| Dell Support Utility | 33 |
| Dell Diagnostics. | 33 |
| | |
| 5 Reinstalling Software | 35 |
| | |
| Drivers | 35 |
| Identifying Drivers | 35 |
| Reinstalling Drivers and Utilities | 35 |
| | |
| Restoring Your Operating System | 37 |
| Using Microsoft® Windows® System Restore | 38 |
| Using Dell Factory Image Restore | 38 |
| Using the Operating System Media. | 39 |
| | |
| 6 Finding Information | 41 |
| | |
| 7 Getting Help | 43 |
| | |
| Obtaining Assistance | 43 |
| Technical Support and Customer Service | 44 |
| DellConnect™. | 44 |
| Online Services | 44 |
| AutoTech Service. | 45 |
| Automated Order-Status Service. | 45 |
| | |
| Problems With Your Order. | 45 |
| | |
| Product Information | 46 |
| | |
| Returning Items for Warranty Repair or Credit | 46 |

**FILE LOCATION: C:\Windchill
Projects\Mini_Cooper\SORG\A00\EN\Source\bookTOC.fm**

| | |
|----------------------------------|-----------|
| Before You Call | 46 |
| Contacting Dell | 49 |
| Index | 51 |

About Your Computer

Front View

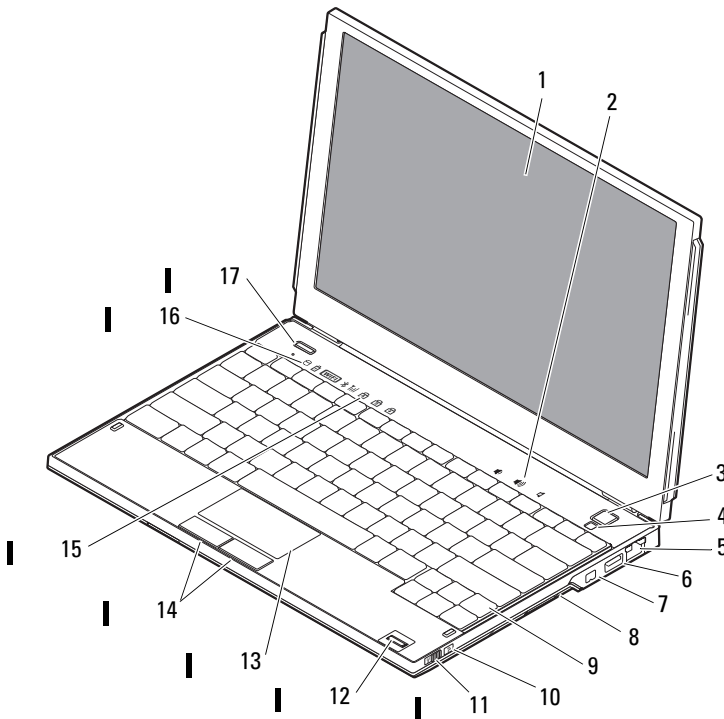

- | | | | |
|---|---------------------|---|-------------------------------|
| 1 | display | 2 | volume controls |
| 3 | power button | 4 | ambient light sensor |
| 5 | network connector | 6 | USB connector with PowerShare |
| 7 | IEEE 1394 connector | 8 | memory card reader |

DELL CONFIDENTIAL – PRELIMINARY 6/26/08 - FOR PROOF ONLY

Template Last Updated - 2/7/2007

About Your Computer |

7

- | | | | |
|----|--------------------------|----|--------------------------------|
| 9 | keyboard | 10 | Wi-Fi Catcher™ Network Locator |
| 11 | wireless switch | 12 | fingerprint reader (optional) |
| 13 | touch pad | 14 | touch pad buttons (2) |
| 15 | keyboard status lights | 16 | device status lights |
| 17 | Dell Latitude ON™ button | | |

Back View

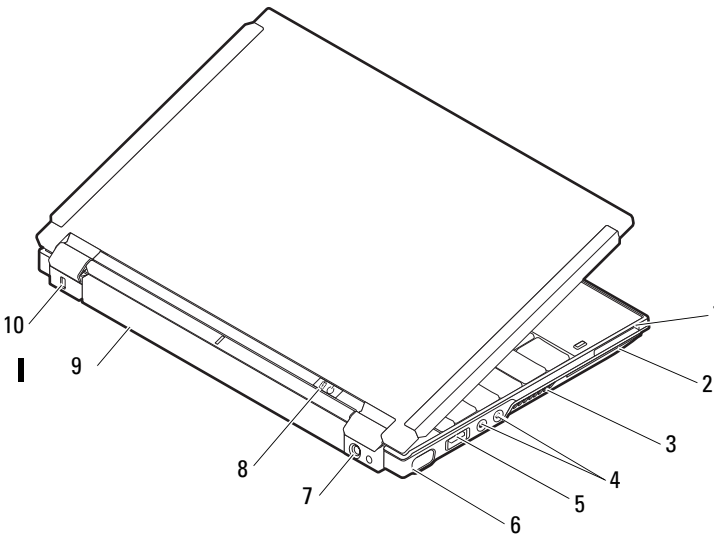

- | | | | |
|---|----------------------|----|---------------------------|
| 1 | ExpressCard slot | 2 | SmartCard slot |
| 3 | air vents | 4 | audio connectors (2) |
| 5 | USB/eSATA connector | 6 | video connector |
| 7 | AC adapter connector | 8 | power light/battery light |
| 9 | battery | 10 | security cable slot |





CAUTION: Do not block, push objects into, or allow dust to accumulate in the air vents. Do not store your Dell™ computer in a low-airflow environment, such as a closed briefcase, while it is running. Restricting the airflow can damage the

DELL CONFIDENTIAL – PRELIMINARY 6/26/08 - FOR PROOF ONLY

computer or cause a fire. The computer turns on the fan when the computer gets hot. Fan noise is normal and does not indicate a problem with the fan or the computer.

Battery Removal

-  **CAUTION:** Before you begin any of the procedures in this section, follow the safety instructions that shipped with your computer.
-  **CAUTION:** Using an incompatible battery may increase the risk of fire or explosion. Replace the battery only with a compatible battery purchased from Dell. The battery is designed to work with your Dell™ computer. Do not use a battery from other computers with your computer.
-  **CAUTION:** Before removing or replacing the battery, turn off the computer, disconnect the AC adapter from the electrical outlet and the computer, disconnect the modem from the wall connector and computer, and remove any other external cables from the computer.

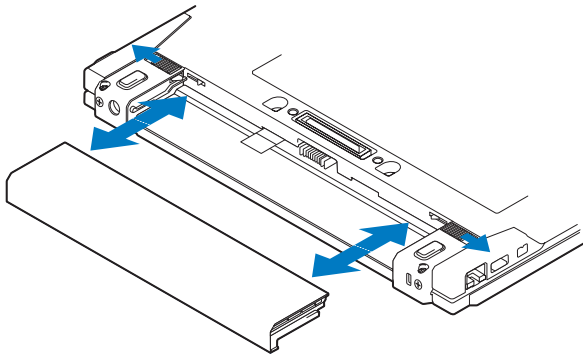

Wireless Switch and Dell™ Wi-Fi Catcher™ Network Locator



wireless switch icon



Dell Wi-Fi Catcher Network Locator icon





FILE LOCATION: C:\Windchill Projects\Mini_Cooper\SRG\A00\EN\Source\about.fm

Use the wireless switch to enable or disable wireless network devices and the Wi-Fi Catcher Network Locator to locate networks. For information about connecting to the Internet, see "Connecting to the Internet" on page 14.

DELL CONFIDENTIAL – PRELIMINARY 6/26/08 - FOR PROOF ONLY

Setting Up Your Computer

Quick Setup

-  **CAUTION:** Before you begin any of the procedures in this section, follow the safety instructions that shipped with your computer.
-  **CAUTION:** The AC adapter works with electrical outlets worldwide. However, power connectors and power strips vary among countries. Using an incompatible cable or improperly connecting the cable to the power strip or electrical outlet may cause fire or equipment damage.
-  **NOTICE:** When you disconnect the AC adapter cable from the computer, grasp the connector, not the cable itself, and pull firmly but gently to avoid damaging the cable. When you wrap the AC adapter cable, ensure that you follow the angle of the connector on the AC adapter to avoid damaging the cable.
-  **NOTE:** Some devices may not be included if you did not order them.
-  **NOTE:** Use only Dell provided power AC adapters, types PA-12 Family or PA-20 Family. Use of any other adapter may reduce system performance or damage system.
- 1 Connect the AC adapter to the AC adapter connector on the computer and to the electrical outlet.

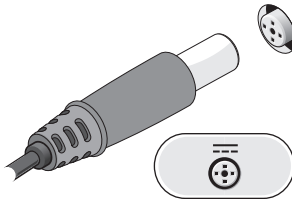

- 2 Connect the network cable.

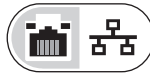
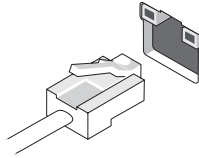

- 3 Connect USB devices, such as a mouse or keyboard.

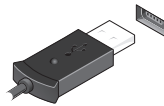

- 4 Connect IEEE 1394 devices, such as a DVD player.

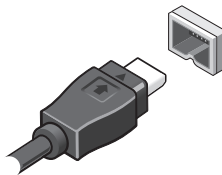

- 5 Open the computer display and press the power button to turn on the computer.

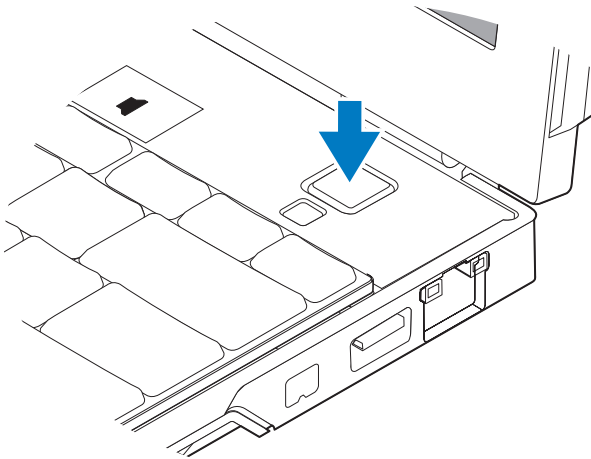

 **NOTE:** It is recommended that you turn on and shut down your computer at least once before you install any cards or connect the computer to a docking device or other external device, such as a printer.

- 6 Connect to the Internet. See "Connecting to the Internet" on page 14 for more information.

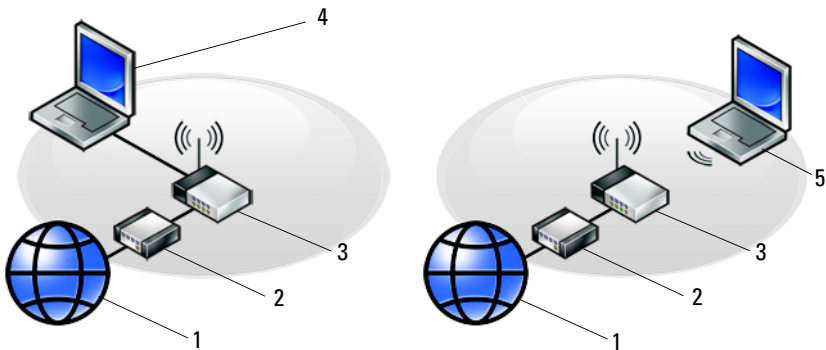

- 1 Internet service
- 3 wireless router
- 5 laptop with *wireless* connection

- 2 cable or DSL modem
- 4 laptop with *wired* connection

Connecting to the Internet

 **NOTE:** ISPs and ISP offerings vary by country.

To connect to the Internet, you need a network connection or external modem and an Internet service provider (ISP). *If you are using a DSL or cable/satellite modem*, contact your ISP or cellular phone service for setup instructions. *If you are using an external USB modem*, follow the installation instructions that came with your modem before setting up your dial-up connection.

Setting Up Your Internet Connection

To set up an Internet connection with a desktop shortcut provided by your ISP:

- 1 Save and close any open files, and exit any open programs.
- 2 Double-click the ISP icon on the Microsoft® Windows® desktop.
- 3 Follow the instructions on the screen to complete the setup.

If you do not have an ISP icon on your desktop or if you want to set up an Internet connection with a different ISP, perform the steps in the appropriate section below.

 **NOTE:** If you cannot connect to the Internet, see the *Dell Technology Guide*. If you have successfully connected in the past, the ISP might have a service outage. Contact your ISP to check the service status, or try connecting again later.

 **NOTE:** Have your ISP information ready. If you do not have an ISP, consult the **Connect to the Internet** wizard.

Microsoft® Windows Vista® Operating System

- 1 Save and close any open files, and exit any open programs.
- 2 Click the Windows Vista Start button™  → **Control Panel**
- 3 Under **Network and Internet**, click **Connect to the Internet**.
- 4 In the **Connect to the Internet** window, click either **Wireless**, **Broadband (PPPoE)** or **Dial-up**, depending on how you want to connect:
 - Choose **Broadband** if you will use a Wireless Router, DSL, satellite modem, cable TV modem, or Bluetooth® wireless technology connection.
 - Choose **Dial-up** if you will use a dial-up modem or ISDN.

DELL CONFIDENTIAL – PRELIMINARY 6/26/08 - FOR PROOF ONLY



NOTE: If you do not know which type of connection to select, click **Help me choose** or contact your ISP.

- 5 Follow the instructions on the screen and use the setup information provided by your ISP to complete the setup.

Microsoft Windows® XP

- 1 Save and close any open files, and exit any open programs.
- 2 Click **Start**→ **Internet Explorer**→ **Connect to the Internet**.
- 3 In the next window, click the appropriate option:
 - If you do not have an ISP, click **Choose from a list of Internet service providers (ISPs)**.
 - If you have already obtained setup information from your ISP but you did not receive a setup CD, click **Set up my connection manually**.
 - If you have a setup CD, click **Use the CD I got from an ISP**.
- 4 Click **Next**.

If you selected **Set up my connection manually** in step 3, continue to step 5. Otherwise, follow the instructions on the screen to complete the setup.



NOTE: If you do not know which type of connection to select, contact your ISP.

- 5 Click the appropriate option under **How do you want to connect to the Internet?**, and click **Next**.
- 6 Use the setup information provided by your ISP to complete the setup.

Transferring Information to a New Computer

Microsoft® Windows Vista® Operating System

- 1 Click the Windows Vista Start button , and then click **Transfer files and settings**→ **Start Windows Easy Transfer**.
- 2 In the User Account Control dialog box, click **Continue**.
- 3 Click **Start a new transfer** or **Continue a transfer in progress**.
- 4 Follow the instructions provided on the screen by the Windows Easy Transfer wizard.

Microsoft Windows® XP

Windows XP provides the Files and Settings Transfer Wizard to move data from a source computer to a new computer.

You can transfer the data to the new computer over a network or serial connection, or you can store it on removable media, such as a writable CD, for transfer to the new computer.



NOTE: You can transfer information from an old computer to a new computer by directly connecting a serial cable to the input/output (I/O) ports of the two computers.

For instructions on setting up a direct cable connection between two computers, see Microsoft Knowledge Base Article #305621, titled *How to Set Up a Direct Cable Connection Between Two Computers in Windows XP*. This information may not be available in certain countries.

For transferring information to a new computer, you must run the Files and Settings Transfer Wizard.

Running the Files and Settings Transfer Wizard With the Operating System Media



NOTE: This procedure requires the *Operating System* media. This media is optional and may not be included with certain computers.

To prepare a new computer for the file transfer:

- 1 Open the Files and Settings Transfer Wizard: click **Start**→ **All Programs**→ **Accessories**→ **System Tools**→ **Files and Settings Transfer Wizard**.
- 2 When the Files and Settings Transfer Wizard welcome screen appears, click **Next**.
- 3 On the **Which computer is this?** screen, click **New Computer**→ **Next**.
- 4 On the **Do you have a Windows XP CD?** screen, click **I will use the wizard from the Windows XP CD**→ **Next**.
- 5 When the **Now go to your old computer** screen appears, go to your old or source computer. Do *not* click **Next** at this time.

To copy data from the old computer:

- 1 On the old computer, insert the Windows XP *Operating System* media.
- 2 On the **Welcome to Microsoft Windows XP** screen, click **Perform additional tasks**.
- 3 Under **What do you want to do?**, click **Transfer files and settings**→ **Next**.

DELL CONFIDENTIAL – PRELIMINARY 6/26/08 - FOR PROOF ONLY

- 4 On the **Which computer is this?** screen, click **Old Computer**→ **Next**.
- 5 On the **Select a transfer method** screen, click the transfer method you prefer.
- 6 On the **What do you want to transfer?** screen, select the items you want to transfer and click **Next**.

After the information has been copied, the **Completing the Collection Phase** screen appears.

- 7 Click **Finish**.

To transfer data to the new computer:

- 1 On the **Now go to your old computer** screen on the new computer, click **Next**.
- 2 On the **Where are the files and settings?** screen, select the method you chose for transferring your settings and files and click **Next**.

The wizard applies the collected files and settings to your new computer.

- 3 On the **Finished** screen, click **Finished**, and restart the new computer.

Running the Files and Settings Transfer Wizard Without the Operating System Media

To run the Files and Settings Transfer Wizard without the *Operating System* media, you must create a wizard disk that will allow you to create a backup image file to removable media.

To create a wizard disk, use your new computer with Windows XP and perform the following steps:

- 1 Open the Files and Settings Transfer Wizard: click **Start**→ **All Programs**→ **Accessories**→ **System Tools**→ **Files and Settings Transfer Wizard**.
- 2 When the **Files and Settings Transfer Wizard** welcome screen appears, click **Next**.
- 3 On the **Which computer is this?** screen, click **New Computer**→ **Next**.
- 4 On the **Do you have a Windows XP CD?** screen, click **I want to create a Wizard Disk in the following drive**→ **Next**.
- 5 Insert the removable media, such as a writable CD, and click **OK**.

- 6 When the disk creation completes and the **Now go to your old computer** message appears, *do not* click **Next**.
- 7 Go to the old computer.

To copy data from the old computer:

- 1 On the old computer, insert the wizard disk, and click **Start**→**Run**.
- 2 In the **Open** field on the **Run** window, browse to the path for **fastwiz** (on the appropriate removable media) and click **OK**.
- 3 On the **Files and Settings Transfer Wizard** welcome screen, click **Next**.
- 4 On the **Which computer is this?** screen, click **Old Computer**→**Next**.
- 5 On the **Select a transfer method** screen, click the transfer method you prefer.
- 6 On the **What do you want to transfer?** screen, select the items you want to transfer and click **Next**.

After the information has been copied, the **Completing the Collection Phase** screen appears.

- 7 Click **Finish**.

To transfer data to the new computer:

- 1 On the **Now go to your old computer** screen on the new computer, click **Next**.
- 2 On the **Where are the files and settings?** screen, select the method you chose for transferring your settings and files and click **Next**. Follow the instructions on the screen.

The wizard reads the collected files and settings and applies them to your new computer.

When all of the settings and files have been applied, the **Finished** screen appears.

- 3 Click **Finished** and restart the new computer.



NOTE: For more information about this procedure, search support.dell.com for document #154781 (*What Are The Different Methods To Transfer Files From My Old Computer To My New Dell™ Computer Using the Microsoft® Windows® XP Operating System?*).

FILE LOCATION: C:\Windchill Projects\Mini_Cooper\SRG\A00\EN\Source\setting.fm



NOTE: Access to the Dell™ Knowledge Base document may not be available in certain countries.

FILE LOCATION: C:\Windchill Projects\Mini_Cooper\SQRG\A00\EN\Source\setting.fm

DELL CONFIDENTIAL – PRELIMINARY 6/26/08 - FOR PROOF ONLY

3

Specifications

 **NOTE:** Offerings may vary by region. For more information regarding the configuration of your computer, click **Start**→ **Help and Support** and select the option to view information about your computer.

Processor

| | |
|------------------------|--|
| Processor type | Intel® Core™2 Duo ULV processor |
| L1 cache | 32 KB per instruction, 32-KB data cache per core |
| L2 cache | 3 MB |
| External bus frequency | 800 MHz |

System Information

| | |
|-----------------------------|-------------------------------|
| Chipset | Intel SFF chipset |
| Data bus width | 64 bits |
| DRAM bus width | dual-channel (2) 64-bit buses |
| Processor address bus width | 36 bits |
| Flash EPROM | 4 MB |
| Graphics bus | internal |
| PCI bus | 32 bits |

ExpressCard

| | |
|------------------------|---|
| Express Card connector | ExpressCard slot (USB and PCI Express-based interfaces) |
| Cards supported | 34-mm ExpressCards |

Secure Digital (SD) Memory Card Reader

| | |
|-----------------|--|
| Cards supported | SD, SDIO, SD HC, Mini SD MMC, MMC+, Mini MMC |
|-----------------|--|

Memory

| | |
|--------------------------|------------------------------------|
| Memory module connector | one user-accessible SODIMM socket |
| Memory module capacities | 1 GB, 2 GB, 4 GB 5-GB capable |
| Memory type | DDR3 SODIMM |
| Minimum memory | 1 GB (onboard memory) |
| Maximum memory | 5-GB capable (Windows Vista® only) |

Smart Card

| | |
|------------------------------|--|
| Read/write capabilities | reads and writes to all ISO 7816 1/2/3/4 microprocessor cards (T=0, T=1) |
| Cards supported | 3 V and 5 V |
| Program technology supported | Java cards |
| Interface speed | 9600–115,200 bps |
| EMV level | level 1 certified |
| WHQL certification | PC/SC |
| Compatibility | compatible within a PKI environment |
| Insert/eject cycles | certified for up to 100,000 cycles |

Ports and Connectors

| | |
|-----------------|--|
| Audio | microphone/stereo line-in connector, stereo headphone/speakers connector |
| Mini-Card | one dedicated half Mini-Card slot for WLAN one dedicated full Mini-Card slot for WWAN/GPS |
| Network adapter | RJ-45 port |

Ports and Connectors *(continued)*

| | |
|------------|--|
| USB, eSATA | two 4-pin USB 2.0-compliant connectors NOTE: One USB connector can be used as an eSATA connector. The other USB connector with PowerShare can be used to charge a USB device when the computer is turned on or off. |
| Video | 15-hole VGA connector |
| IEEE 1394 | 4-pin mini |
| E-Dock | standard E-Dock connector for devices such as E-Dock advanced port replicators and expansion stations NOTE: The optional media base can be connected to the E-Dock connector. See the documentation that comes with the media base for additional information. |
| E-Port | standard E-Port connector |

Communications

| | |
|-----------------|--|
| Network adapter | 10/100/1000 Ethernet LAN on system board |
| Wireless | internal WLAN, WWAN, and Bluetooth [®] wireless support (if optional cards are purchased) |

Video

| | |
|------------------|--|
| Video type: | integrated on system board, hardware accelerated |
| Data bus | integrated video |
| Video controller | Intel Extreme Graphics |
| Video memory | up to 256 MB (shared) |

Audio

| | |
|------------------|--|
| Audio type | two-channel High Definition Audio (Azalia) |
| Audio controller | IDT 92HD71B codec |

Audio (continued)

| | |
|----------------------------|---|
| Stereo conversion | 24-bit (analog-to-digital and digital-to-analog) |
| Interfaces: | |
| Internal | High Definition Audio (Azalia) codec |
| External | microphone/stereo line-in connector, stereo headphones/speakers connector |
| Speaker | one 4-ohm speaker |
| Internal speaker amplifier | 2-W channel into 4 ohms |
| Volume controls | volume control buttons, program menus |

Display

| | |
|---|----------------------------|
| Type (active-matrix TFT) | WXGA |
| Active X/Y | 261.12 x 163.2 |
| Dimensions: | |
| Height | 261.12 mm (10.28 inches) |
| Width | 163.2 mm (6.43 inches) |
| Diagonal | 307.34 mm (12.1 inches) |
| Maximum resolution | 1280 x 800 at 262 K colors |
| Refresh rate | 60 Hz (40 Hz in ADBL mode) |
| Operating angle | 0° (closed) to 160° |
| Viewing angles: | |
| Horizontal | 40/40° |
| Vertical | 15/30° |
| Pixel pitch: | |
| WXGA | 0.204 |
| Power Consumption (panel with backlight) (typical): | |
| WXGA | 3.0 W (max) |

Keyboard

| | |
|----------------|---|
| Number of keys | 87 (U.S. and Canada); 88 (Europe); 91 (Japan) |
| Layout | QWERTY/AZERTY/Kanji |

Touch Pad

| | |
|--|---------------------------------------|
| XY position resolution (graphics table mode) | 240 cpi |
| Size: | |
| Width | 73.0-mm (2.9-inch) sensor-active area |
| Height | 42.9-mm (1.7-inch) rectangle |

Battery

| | |
|------|---|
| Type | 4-cell: 28 Whr/14.8V 6-cell: 58 Whr/11.1V Slice: 48 Whr/11.1V |
|------|---|

Dimensions:

4 cell

| | |
|--------|-----------------------|
| Depth | 210 mm (8.27 inches) |
| Height | 18 mm (0.71 inches) |
| Width | 46.5 mm (1.83 inches) |

6 cell

| | |
|--------|-----------------------|
| Depth | 210 mm (8.27 inches) |
| Height | 23.2 mm (0.91 inches) |
| Width | 68.5 mm (2.7 inches) |

Slice

| | |
|--------|-----------------------|
| Depth | 9.5 mm (0.38 inches) |
| Height | 186 mm (7.32 inches) |
| Width | 279 mm (10.98 inches) |

Battery (continued)

| | |
|----------------------------|--|
| Weight | 0.2 kg (0.44 lb) (4 cell) |
| | 0.37–0.38 kg (0.82–0.84 lb) (6 cell) |
| | 0.59–0.61 kg (1.3–1.34 lb) (slice) |
| Voltage | 11.1 VDC (6-cell, slice) |
| | 14.8 VDC (4-cell) |
| Charge time (approximate): | |
| Computer off | approximately 1 hour to 80% capacity approximately 2 hours to 100% capacity |
| Operating time | Battery operating time varies depending on operating conditions and can be significantly reduced under certain power-intensive conditions. |
| Life span (approximate) | 300 charge/discharge cycles |
| Temperature range: | |
| Operating | 0° to 35°C (32° to 95°F) |
| Storage | –40° to 60°C (–40° to 140°F) |
| Coin-cell battery | CR-2032 |

AC Adapter

| | |
|-------------------------|---|
| Input voltage | 100–240 VAC |
| Input current (maximum) | 0.8 A |
| Input frequency | 50–60 Hz |
| Output current | 3.1 A (maximum at 10ms pulse); 2.31 A (continuous) |
| Output power | 45 W or higher |
| Rated output voltage | 19.5 +/-1.0 VDC |
| Dimensions: | |
| Height | 15 mm (0.59 inches) |
| Width | 89 mm (3.5 inches) |
| Depth | 63.5 mm (2.5 inches) |

DELL CONFIDENTIAL – PRELIMINARY 6/26/08 - FOR PROOF ONLY

AC Adapter (continued)

Temperature range:

| | |
|-----------|------------------------------|
| Operating | 0° to 35°C (32° to 95°F) |
| Storage | -40° to 65°C (-40° to 149°F) |

Fingerprint Reader (Optional)

| | |
|------|---|
| Type | UPEK TCS3 TouchStrip™ strip sensor with CMOS active capacitive pixel-sensing technology |
|------|---|

Physical

| | |
|------------------------------|--|
| Height | 19.95–26.82 mm (0.79–1.06 inches) |
| Width | 290.6 mm–296.6 mm (11.44–11.68 inches) |
| Depth | 204 mm–226 mm (8.03–8.9 inches) |
| Weight (entry configuration) | 1 kg (2.2 lb) |

Environmental

Temperature range:

| | |
|-----------|------------------------------|
| Operating | 0° to 35°C (32° to 95°F) |
| Storage | -40° to 65°C (-40° to 149°F) |

Relative humidity (maximum):

| | |
|-----------|----------------------------|
| Operating | 10% to 90% (noncondensing) |
| Storage | 5% to 95% (noncondensing) |

Maximum vibration (using a random-vibration spectrum that simulates user environment):

| | |
|-----------|-----------|
| Operating | 0.66 GRMS |
| Storage | 1.3 GRMS |

Maximum shock (measured within head-parked position and a 2-ms half-sine pulse):

| | |
|-----------|-------|
| Operating | 143 G |
|-----------|-------|

Environmental (continued)

| | |
|---------------------|--------------------------------------|
| Storage | 163 G |
| Altitude (maximum): | |
| Operating | -15.2 to 3048 m (-50 to 10,000 ft) |
| Storage | -15.2 to 10,668 m (-50 to 35,000 ft) |

I

Troubleshooting Tips



CAUTION: Always unplug your computer from the electrical outlet before opening the cover.



NOTE: For detailed troubleshooting information, including responding to system messages, see your *Service Manual* on support.dell.com.

Using the Hardware Troubleshooter

- 1 Click the Windows Vista Start button™ , and click **Help and Support**.
- 2 Type `hardware troubleshooter` in the search field and press <Enter> to start the search.
- 3 In the search results, select the option that best describes the problem and follow the remaining troubleshooting steps.

Tips

- If a device does not work, ensure that the device is properly connected.
- If you added or removed a part before the problem started, review the installation procedures and ensure that the part is correctly installed.
- If an error message appears on the screen, write down the exact message. This message may help support personnel to diagnose and fix the problem(s).
- If an error message occurs in a program, see the program documentation.

Power Problems



CAUTION: Before working inside your computer, read the safety information that shipped with your computer. For additional safety best practices information, see www.dell.com/regulatory_compliance.

IF THE POWER LIGHT IS OFF — The computer is either turned off or is not receiving power.

- Reseat the power cable in the power connector on the back of the computer and the electrical outlet.

DELL CONFIDENTIAL – PRELIMINARY 6/26/08 - FOR PROOF ONLY

- Bypass power strips, power extension cables, and other power protection devices to verify that the computer turns on properly.
- Ensure that any power strips being used are plugged into an electrical outlet and are turned on.
- Ensure that the electrical outlet is working by testing it with another device, such as a lamp.
- Ensure that the main power cable and front panel cable are securely connected to the system board.

IF THE POWER LIGHT IS BLUE AND THE COMPUTER IS NOT RESPONDING —

- Ensure that the display is connected and powered on.
- If the display is connected and powered on, see in your *Service Manual* on support.dell.com.

IF THE POWER LIGHT IS BLINKING BLUE — The computer is in standby mode. Press a key on the keyboard, move the mouse, or press the power button to resume normal operation.

ELIMINATE INTERFERENCE — Some possible causes of interference are:

- Power, keyboard, and mouse extension cables
- Too many devices connected to the same power strip
- Multiple power strips connected to the same electrical outlet

CHECK THE BATTERY STATUS LIGHT — To check the battery charge, press and release the status button on the battery charge gauge to illuminate the charge-level lights. Each light represents approximately 20 percent of the total battery charge. For example, if the battery has 80 percent of its charge remaining, four of the lights are on. If no lights appear, the battery has no charge.

Memory Problems

 **CAUTION:** Before working inside your computer, read the safety information that shipped with your computer. For additional safety best practices information, see www.dell.com/regulatory_compliance.

IF YOU RECEIVE AN INSUFFICIENT MEMORY MESSAGE —

- Save and close any open files and exit any open programs you are not using to see if that resolves the problem.

- See the software documentation for minimum memory requirements. If necessary, install additional memory.
- Reseat any accessible memory modules to ensure that your computer is successfully communicating with the memory.
- Run the Dell Diagnostics (see "Dell Diagnostics" on page 33).

IF YOU EXPERIENCE OTHER MEMORY PROBLEMS —

- Reseat any accessible memory modules to ensure that your computer is successfully communicating with the memory.
- Ensure that you are following the memory installation guidelines.
- Ensure that the memory you are using is supported by your computer. For more information about the type of memory supported by your computer, see "Specifications" on page 33.
- Run the Dell Diagnostics (see "Dell Diagnostics" on page 33).

Lockups and Software Problems



NOTE: The procedures in this document were written for the Windows default view, so they may not apply if you set your Dell computer to the Windows Classic view.

The computer does not start up

ENSURE THAT THE POWER CABLE IS FIRMLY CONNECTED TO THE COMPUTER AND TO THE ELECTRICAL OUTLET

A program stops responding

END THE PROGRAM —

- 1 Press <Ctrl><Shift><Esc> simultaneously to access the Task Manager, and click the **Applications** tab.
- 2 Click to select the program that is no longer responding, and click **End Task**.

A program crashes repeatedly



NOTE: Most software includes installation instructions in its documentation or on a floppy disk, CD, or DVD.

CHECK THE SOFTWARE DOCUMENTATION — If necessary, uninstall and then reinstall the program.

A program is designed for an earlier Microsoft® Windows® operating system

RUN THE PROGRAM COMPATIBILITY WIZARD —

- 1 Click Start  → Control Panel → Programs → Use an older program with this version of Windows.
- 2 In the welcome screen, click Next.
- 3 Follow the instructions on the screen.

A solid blue screen appears

TURN THE COMPUTER OFF — If you are unable to get a response by pressing a key on your keyboard or moving your mouse, press and hold the power button for at least 6 seconds (until the computer turns off), and then restart your computer.

Other software problems

CHECK THE SOFTWARE DOCUMENTATION OR CONTACT THE SOFTWARE MANUFACTURER FOR TROUBLESHOOTING INFORMATION —

- Ensure that the program is compatible with the operating system installed on your computer.
- Ensure that your computer meets the minimum hardware requirements needed to run the software. See the software documentation for information.
- Ensure that the program is installed and configured properly.
- Verify that the device drivers do not conflict with the program.
- If necessary, uninstall and then reinstall the program.

Dell Technical Update Service

The Dell Technical Update service provides proactive e-mail notification of software and hardware updates for your computer. To enroll for the Dell Technical Update service, go to support.dell.com/technicalupdate.

Dell Support Utility

The Dell Support Utility provides self-support information, software updates, and health scans of your computing environment. Access the Dell Support Utility from the  icon on the taskbar, or from the **Start** menu.

If the Dell Support icon does not appear in your taskbar:

- 1 Click **Start**→ **All Programs**→ **Dell Support**→ **Dell Support Settings**.
- 2 Ensure that the **Show icon on the taskbar** option is checked.



NOTE: If the Dell Support Utility is not available from the **Start** menu, go to support.dell.com and download the software.

For more information about the Dell Support Utility, click the question mark (?) at the top of the **Dell™ Support** screen.

Dell Diagnostics



CAUTION: Before you begin any of the procedures in this section, follow the safety instructions that shipped with your computer.

Starting the Dell Diagnostics From Your Hard Drive

- 1 Ensure that the computer is connected to a working electrical outlet.
- 2 Turn on (or restart) your computer.
- 3 When the **DELL™** logo appears, press <F12> immediately. Select **Diagnostics** from the start menu and press <Enter>.



NOTE: If you wait too long and the operating system logo appears, continue to wait until you see the **Microsoft® Windows®** desktop, and then shut down your computer and try again.



NOTE: If you see a message stating that no diagnostics utility partition has been found, run the Dell Diagnostics from the *Drivers and Utilities* media.

- 4 Press any key to start the Dell Diagnostics from the diagnostics utility partition on your hard drive, and follow the instructions on the screen.

Starting the Dell Diagnostics From the Dell *Drivers and Utilities* Media



NOTE: The Dell *Drivers and Utilities* media is optional and may not ship with your computer.

- 1 Attach an external CD/DVD drive or the Media Slice if not already present.

DELL CONFIDENTIAL – PRELIMINARY 6/26/08 - FOR PROOF ONLY

2 Insert the *Drivers and Utilities* media.

3 Shut down and restart the computer.

When the DELL logo appears, press <F12> immediately.



NOTE: If you wait too long and the operating system logo appears, continue to wait until you see the Microsoft® Windows® desktop; then, shut down your computer and try again.



NOTE: The next steps change the boot sequence for one time only. On the next start-up, the computer starts according to the devices specified in the system setup program.

4 When the boot device list appears, highlight CD/DVD/CD-RW and press <Enter>.

5 Select the **Boot from CD-ROM** option from the menu that appears and press <Enter>.

6 Type 1 to start the CD menu and press <Enter> to proceed.

7 Select **Run the 32 Bit Dell Diagnostics** from the numbered list. If multiple versions are listed, select the version that is appropriate for your computer.

8 When the Dell Diagnostics **Main Menu** appears, select the test that you want to run, and follow the instructions on the screen.

Reinstalling Software

Drivers

Identifying Drivers

- 1 Locate the list of devices for your computer.
 - a Click the Windows Vista Start button™ , and right-click **Computer**.
 - b Click **Properties**→ **Device Manager**.
- 2 Scroll down the list to see if any device has an exclamation point (a yellow circle with a [!]) on the device icon.



NOTE: The **User Account Control** window may appear. If you are an administrator on the computer, click **Continue**; otherwise, contact your administrator to continue.

If an exclamation point is next to the device name, you may need to reinstall the driver or install a new driver (see "Reinstalling Drivers and Utilities" on page 35).

Reinstalling Drivers and Utilities



NOTICE: The Dell Support website at support.dell.com and your *Drivers and Utilities* media provide approved drivers for your computer. If you install drivers obtained from other sources, your computer might not work correctly.

Returning to a Previous Device Driver Version

- 1 Click the Windows Vista Start button , and right-click **Computer**.
- 2 Click **Properties**→ **Device Manager**.



NOTE: The **User Account Control** window may appear. If you are an administrator on the computer, click **Continue**; otherwise, contact your administrator to enter the Device Manager.

- 3 Right-click the device for which the new driver was installed and click **Properties**.
- 4 Click the **Drivers** tab → **Roll Back Driver**.

If Device Driver Rollback does not resolve the problem, use System Restore (see "Restoring Your Operating System" on page 37) to return your computer to the operating state that existed before you installed the new driver.

Using the Drivers and Utilities Media

Before using the *Drivers and Utilities* media, try the following:

- Windows Device Driver Rollback (see "Returning to a Previous Device Driver Version" on page 35)
- Microsoft System Restore (see "Using Microsoft® Windows® System Restore" on page 38)

- 1 With the Windows desktop displayed, insert your *Drivers and Utilities* media.

If this is your first time using the *Drivers and Utilities* media, go to step 2. If not, go to step 5.

- 2 When the *Drivers and Utilities* media installation program starts, follow the prompts on the screen.



NOTE: In most cases, the *Drivers and Utilities* program starts running automatically. If it does not, start Windows Explorer, click your media drive directory to display the media contents, and then double-click the **autorcd.exe** file.

- 3 When the **InstallShield Wizard Complete** window appears, remove the *Drivers and Utilities* media and click **Finish** to restart the computer.
- 4 When you see the Windows desktop, reinsert the *Drivers and Utilities* media.
- 5 At the **Welcome Dell System Owner** screen, click **Next**.

The drivers that are used by your computer are automatically displayed in the **My Drivers—The ResourceCD** has identified these components in your system window.

DELL CONFIDENTIAL – PRELIMINARY 6/26/08 - FOR PROOF ONLY

- 6 Click the driver that you want to reinstall and follow the instructions on the screen.

If a particular driver is not listed, that driver is not required by your operating system, or you must find the drivers that came with the specific device.

Manually Reinstalling Drivers

- 1 Click the Windows Vista Start button , and right-click **Computer**.
- 2 Click **Properties**→ **Device Manager**.



NOTE: The **User Account Control** window appears. If you are an administrator on the computer, click **Continue**; otherwise, contact your administrator to enter the Device Manager.

- 3 Double-click the type of device for which you are installing the driver (for example, **Audio** or **Video**).
- 4 Double-click the name of the device for which you are installing the driver.
- 5 Click the **Driver** tab→ **Update Driver**→ **Browse my computer for driver software**.
- 6 Click **Browse** and browse to the location to which you previously copied the driver files.
- 7 Click the name of the driver→ **OK**→ **Next**.
- 8 Click **Finish** and restart your computer.

Restoring Your Operating System

You can restore your operating system in the following ways:

- Microsoft Windows System Restore returns your computer to an earlier operating state without affecting data files. Use System Restore as the first solution for restoring your operating system and preserving data files.
- Dell Factory Image Restore returns your hard drive to the same operating state as when you purchased the computer. The program deletes all data on the hard drive and removes any programs installed after you received the computer.
- If you received the *Operating System* media with your computer, you can use it to restore your operating system. However, using the *Operating System* media deletes all data on the hard drive.

Using Microsoft® Windows® System Restore

 **NOTE:** The procedures in this document were written for the Windows default view, so they may not apply if you set your Dell™ computer to the Windows Classic view.

Starting System Restore

- 1 Click **Start** .
- 2 In the Start Search box, type **System Restore** and press <Enter>.

 **NOTE:** The **User Account Control** window may appear. If you are an administrator on the computer, click **Continue**; otherwise, contact your administrator to continue the desired action.

- 3 Click **Next** and follow the remaining prompts on the screen.

Undoing the Last System Restore

 **NOTICE:** Before you undo the last system restore, save and close all open files and exit any open programs. Do not alter, open, or delete any files or programs until the system restoration is complete.

- 1 Click **Start** .
- 2 In the Start Search box, type **System Restore** and press <Enter>.
- 3 Click **Undo my last restoration** and click **Next**.

Using Dell Factory Image Restore

 **NOTICE:** Use Dell Factory Image Restore only if System Restore did not resolve your operating system problem. Using Dell Factory Image Restore permanently deletes all data (for example, documents, spreadsheets, e-mail messages, digital photos, and music files) on the hard drive and removes any programs or drivers installed after you received your computer. If possible, back up the data before using Dell Factory Image Restore.

 **NOTE:** Dell Factory Image Restore may not be available in certain countries or on certain computers.

- 1 Turn on the computer.
- 2 When the Dell logo appears, press <F8> several times to access the **Vista Advanced Boot Options** window.
- 3 Select **Repair Your Computer**.

The **System Recovery Options** window appears.

- 4 Select a keyboard layout and click **Next**.
- 5 To access the recovery options, log on as a local user.
- 6 To access the command prompt, type `administrator` in the **User name** field, then click **OK**.
- 7 Click **Dell Factory Image Restore**.

 **NOTE:** Depending upon your configuration, you may need to select **Dell Factory Tools**, then **Dell Factory Image Restore**.

- 8 On the **Dell Factory Image Restore** welcome screen, click **Next**.

The **Confirm Data Deletion** screen appears.

 **NOTICE:** If you do not want to proceed with **Factory Image Restore**, click **Cancel**.

- 9 Click the checkbox to confirm that you want to continue reformatting the hard drive and restoring the system software to the factory condition, then click **Next**.

The restore process begins and may take 5 or more minutes to complete. A message appears when the operating system and factory-installed applications have been restored to factory condition.

- 10 Click **Finish** to restart the computer.

Using the Operating System Media

Before reinstalling the operating system, try the following:

- Windows Device Driver Rollback (see "Returning to a Previous Device Driver Version" on page 35)
- Microsoft System Restore (see "Using Microsoft® Windows® System Restore" on page 38)

 **NOTICE:** Before performing the installation, back up all data files from your primary hard drive to another media. For conventional hard drive configurations, the primary hard drive is the first drive detected by the computer.

To reinstall Windows, you need the Dell™ *Operating System* media and the *Dell Drivers and Utilities* media. The *Dell Drivers and Utilities* media contains drivers that were installed at the time you ordered your computer.

-  **NOTE:** Depending on the region from which you ordered your computer, or whether you requested the media, the Dell Drivers and Utilities media and Dell Operating System media may not ship with your computer.

Reinstalling Windows

-  **NOTE:** The reinstallation process can take 1 to 2 hours to complete.

- 1 Save and close any open files and exit any open programs.
- 2 Insert the *Operating System* media.
- 3 If the `Install Windows` message appears, click **Exit**.
- 4 Restart the computer, and when the DELL logo appears, press <F12> immediately.

If you wait too long and the operating system logo appears, wait until you see the Microsoft® Windows® desktop; then, restart your computer and try again.

- 5 When the boot device list appears, highlight **CD/DVD/CD-RW Drive** and press <Enter>.

This selection changes the boot sequence for one time only.

- 6 Press any key to **Boot from CD-ROM**, and follow the instructions on the screen to complete the installation.
- 7 Reinstall the device drivers, virus protection program, and other software.

6

Finding Information



NOTE: Some features or media may be optional and may not ship with your computer. Some features or media may not be available in certain countries.



NOTE: Additional information may ship with your computer.

| Document/Media/Label | Contents |
|--|--|
| <p>Service Tag/Express Service Code</p> <p>The <i>Service Tag/Express Service Code</i> is located on your computer.</p> | <ul style="list-style-type: none"> • Use the Service Tag to identify your computer when you use support.dell.com or contact support. • Enter the Express Service Code to direct your call when contacting support <p>NOTE: Your Service Tag/Express Service Code is located on your computer.</p> |
| <p>Drivers and Utilities Media</p> <p>The <i>Drivers and Utilities</i> media is a CD or DVD that may have shipped with your computer.</p> | <ul style="list-style-type: none"> • A diagnostic program for your computer • Drivers for your computer <p>NOTE: Drivers and documentation updates can be found at support.dell.com.</p> <ul style="list-style-type: none"> • Notebook System Software (NSS) |
| <p>Operating System Media</p> <p>The <i>Operating System</i> media is a CD or DVD that may have shipped with your computer.</p> | <p>Reinstall your operating system</p> |

| Document/Media/Label | Contents |
|---|---|
| <p>Safety, Regulatory, Warranty, and Support Documentation</p> <p>This type of information may have shipped with your computer. For additional regulatory information, see the Regulatory Compliance Homepage on www.dell.com at the following location: www.dell.com/regulatory_compliance.</p> | <ul style="list-style-type: none"> • Warranty information • Terms and Conditions (U.S. only) • Safety instructions • Regulatory information • Ergonomics information • End User License Agreement |
| <p>Service Manual</p> <p>The <i>Service Manual</i> for your computer can be found at support.dell.com.</p> | <ul style="list-style-type: none"> • How to remove and replace parts • How to configure system settings • How to troubleshoot and solve problems |
| <p>Dell Technology Guide</p> <p>The <i>Dell Technology Guide</i> is available at support.dell.com.</p> | <ul style="list-style-type: none"> • About your operating system • Using and maintaining devices • Understanding technologies such as RAID, Internet, Bluetooth[®] wireless technology, e-mail, networking, and more. |
| <p>Dell Latitude ON™ Reader Help File</p> <p>The <i>Dell Latitude ON Reader Help</i> file is available on your hard drive.</p> | <ul style="list-style-type: none"> • Overview of Dell Latitude ON Reader • How to set up, configure, and use the application • Frequently Asked Questions |
| <p>Dell™ Systems Management Administrator's Guide</p> <p>The <i>Dell Systems Management Administrator's Guide</i> is available at support.dell.com.</p> | <ul style="list-style-type: none"> • About Intel[®] Active Management Technology (iAMT), including overview, features, setup, and configuration information. • Location of drivers for iAMT. |
| <p>Microsoft[®] Windows[®] License Label</p> <p>Your Microsoft Windows License is located on your computer.</p> | <ul style="list-style-type: none"> • Provides your operating system product key. |

Getting Help

Obtaining Assistance

 **CAUTION:** If you need to remove the computer cover, first disconnect the computer power and modem cables from all electrical outlets. Follow the safety instructions that shipped with your computer.

If you experience a problem with your computer, you can complete the following steps to diagnose and troubleshoot the problem:

- 1 See "Troubleshooting Tips" on page 29 for information and procedures that pertain to the problem your computer is experiencing.
- 2 See "Dell Diagnostics" on page 33 for procedures on how to run Dell Diagnostics.
- 3 Fill out the "Diagnostics Checklist" on page 48.
- 4 Use Dell's extensive suite of online services available at Dell Support (support.dell.com) for help with installation and troubleshooting procedures. See "Online Services" on page 44 for a more extensive list of Dell Support online.
- 5 If the preceding steps have not resolved the problem, see "Contacting Dell" on page 49.

 **NOTE:** Call Dell Support from a telephone at or near the affected computer so that the support staff can assist you with any necessary procedures.

 **NOTE:** Dell's Express Service Code system may not be available in all countries.

When prompted by Dell's automated telephone system, enter your Express Service Code to route the call directly to the proper support personnel. If you do not have an Express Service Code, open the **Dell Accessories** folder, double-click the **Express Service Code** icon, and follow the directions.

For instructions on using the Dell Support, see "Technical Support and Customer Service" on page 44.

DELL CONFIDENTIAL – PRELIMINARY 6/26/08 - FOR PROOF ONLY



NOTE: Some of the following services are not always available in all locations outside the continental U.S. Call your local Dell representative for information on availability.

Technical Support and Customer Service

Dell's support service is available to answer your questions about Dell™ hardware. Our support staff uses computer-based diagnostics to provide fast, accurate answers.

To contact Dell's support service, see "Before You Call" on page 46, and then see the contact information for your region or go to support.dell.com.

DellConnect™

DellConnect is a simple online access tool that allows a Dell service and support associate to access your computer through a broadband connection, diagnose your problem and repair it all under your supervision. For more information, go to support.dell.com and click **DellConnect**.

Online Services

You can learn about Dell products and services at the following websites:

www.dell.com

www.dell.com/ap (Asian/Pacific countries only)

www.dell.com/jp (Japan only)

www.euro.dell.com (Europe only)

www.dell.com/la (Latin American and Caribbean countries)

www.dell.ca (Canada only)

You can access Dell Support through the following websites and e-mail addresses:

- Dell Support websites:
 - support.dell.com
 - support.jp.dell.com (Japan only)
 - support.euro.dell.com (Europe only)

- Dell Support e-mail addresses:
mobile_support@us.dell.com
support@us.dell.com
la-techsupport@dell.com (Latin America and Caribbean countries only)
apsupport@dell.com (Asian/Pacific countries only)
- Dell Marketing and Sales e-mail addresses:
apmarketing@dell.com (Asian/Pacific countries only)
sales_canada@dell.com (Canada only)
- Anonymous file transfer protocol (FTP):
ftp.dell.com – log in as user **anonymous**, and use your e-mail address as your password

AutoTech Service

Dell's automated support service—AutoTech—provides recorded answers to the questions most frequently asked by Dell customers about their laptop and desktop computers.

When you call AutoTech, use your touch-tone telephone to select the subjects that correspond to your questions. For the telephone number to call for your region, see "Contacting Dell" on page 49.

Automated Order-Status Service

To check on the status of any Dell products that you have ordered, you can go to **support.dell.com**, or you can call the automated order-status service. A recording prompts you for the information needed to locate and report on your order. For the telephone number to call for your region, see "Contacting Dell" on page 49.

Problems With Your Order

If you have a problem with your order, such as missing parts, wrong parts, or incorrect billing, contact Dell for customer assistance. Have your invoice or packing slip available when you call. For the telephone number to call for your region, see "Contacting Dell" on page 49.

Product Information

If you need information about additional products available from Dell, or if you would like to place an order, visit the Dell website at www.dell.com. For the telephone number to call for your region or to speak to a sales specialist, see "Contacting Dell" on page 49.

Returning Items for Warranty Repair or Credit

Prepare all items being returned, whether for repair or credit, as follows:

- 1 Call Dell to obtain a Return Material Authorization Number, and write it clearly and prominently on the outside of the box.
For the telephone number to call for your region, see "Contacting Dell" on page 49. Include a copy of the invoice and a letter describing the reason for the return.
- 2 Include a copy of the Diagnostics Checklist (see "Diagnostics Checklist" on page 48), indicating the tests that you have run and any error messages reported by the Dell Diagnostics (see "Contacting Dell" on page 49).
- 3 Include any accessories that belong with the item(s) being returned (power cables, software floppy disks, guides, and so on) if the return is for credit.
- 4 Pack the equipment to be returned in the original (or equivalent) packing materials.

You are responsible for paying shipping expenses. You are also responsible for insuring any product returned, and you assume the risk of loss during shipment to Dell. Collect On Delivery (C.O.D.) packages are not accepted.

Returns that are missing any of the preceding requirements will be refused at Dell's receiving dock and returned to you.

Before You Call



NOTE: Have your Express Service Code ready when you call. The code helps Dell's automated-support telephone system direct your call more efficiently. You may also be asked for your Service Tag (located on the back or bottom of your computer).

Remember to fill out the Diagnostics Checklist (see "Diagnostics Checklist" on page 48). If possible, turn on your computer before you call Dell for assistance and call from a telephone at or near the computer. You may be asked to type some commands at the keyboard, relay detailed information during operations, or try other troubleshooting steps possible only at the computer itself. Ensure that the computer documentation is available.



CAUTION: Before working inside your computer, follow the safety instructions in the documentation that shipped with your computer.

Diagnostics Checklist

Name:

Date:

Address:

Phone number:

Service Tag (bar code on the back or bottom of the computer):

Express Service Code:

Return Material Authorization Number (if provided by Dell support technician):

Operating system and version:

Devices:

Expansion cards:

Are you connected to a network? Yes No

Network, version, and network adapter:

Programs and versions:

See your operating system documentation to determine the contents of the system's start-up files. If the computer is connected to a printer, print each file. Otherwise, record the contents of each file before calling Dell.

Error message, beep code, or diagnostic code:

Description of problem and troubleshooting procedures you performed:

DELL CONFIDENTIAL – PRELIMINARY 6/26/08 - FOR PROOF ONLY

Contacting Dell

For customers in the United States, call 800-WWW-DELL (800-999-3355).



NOTE: If you do not have an active Internet connection, you can find contact information on your purchase invoice, packing slip, bill, or Dell product catalog.

Dell provides several online and telephone-based support and service options. Availability varies by country and product, and some services may not be available in your area. To contact Dell for sales, technical support, or customer service issues:

- 1 Visit support.dell.com, and verify your country or region in the **Choose A Country/Region** drop-down menu at the bottom of the page.
- 2 Click **Contact Us** on the left side of the page, and select the appropriate service or support link based on your need.
- 3 Choose the method of contacting Dell that is convenient for you.

FILE LOCATION: C:\Windchill Projects\Mini_Cooper\SQRG\A00\EN\Source\help.fm

DELL CONFIDENTIAL – PRELIMINARY 6/26/08 - FOR PROOF ONLY

Index

B

- battery
 - removal, 9

C

- connecting
 - AC adapter, 11
 - IEEE 1394 devices, 12
 - Internet, 14
 - network, 13
 - network cable, 11
 - USB devices, 12
- contacting Dell, 43, 49

D

- Dell
 - contacting, 43, 49
 - software updates, 33
 - Support Utility, 33
 - technical support and customer service, 44
 - Technical Update Service, 32
- Dell Diagnostics, 33
 - starting from the Drivers and Utilities media, 33
 - starting from your hard drive, 33
- Dell Technology Guide, 42

- Dell Wi-Fi Catcher Network Locator, 9
- DellConnect, 44
- diagnostics
 - Dell, 33
- documentation, 41
 - Dell Technology Guide, 42
 - Service Manual, 42
- drivers, 35
 - Drivers and Utilities media, 41
 - identifying, 35
 - reinstalling, 35
 - returning to a previous version, 35
- Drivers and Utilities media, 36, 41
 - Dell Diagnostics, 33

E

- End User License Agreement (EULA), 42
- ergonomics information, 42
- Express Service Code, 41

F

- Files and Settings Transfer Wizard, 15

**DELL CONFIDENTIAL – PRELIMINARY 6/26/08
FOR PROOF ONLY**

finding information, 41

I

Internet

connecting, 14

setting up, 14

Wi-Fi Catcher Network

Locator, 9

wireless switch, 9

L

license label, 42

M

media

Drivers and Utilities, 41

operating system, 41

memory

troubleshooting, 30

N

networks

connecting, 13

overview, 13

Wi-Fi Catcher Network

Locator, 9

wireless switch, 9

Notebook System Software, 41

O

operating system

Dell Factory Image Restore, 38

media, 39

reinstalling, 41

System Restore, 37

Operating System media, 41

operating system product key, 42

P

phone numbers, 49

power

power light conditions, 29

troubleshooting, 29

problems

restore to previous state, 38

R

regulatory information, 42

reinstalling

drivers and utilities, 35

software, 35

S

safety information, 42

Service Manual, 42

Service Tag, 41

setup

**DELL CONFIDENTIAL – PRELIMINARY 6/26/08
FOR PROOF ONLY**

- computer, 11
 - Internet, 14
 - quick setup, 11
- software
 - problems, 32
 - reinstalling, 35
 - troubleshooting, 31-32
 - updates, 32
- specifications
 - AC adapter, 26
 - all, 21
 - audio, 23
 - battery, 25
 - communications, 23
 - display, 24
 - environmental, 27
 - fingerprint reader, 27
 - keyboard, 24
 - memory, 22
 - physical, 27
 - ports and connectors, 22
 - processor, 21
 - smart card, 22
 - system information, 21
 - touch pad, 25
 - track stick, 25
 - video, 23
- support, 43
 - contacting Dell, 49
 - DellConnect, 44
 - online services, 44
 - regional, 44
 - technical support and customer service, 44
- support information, 44

System Restore, 37-38

T

- Terms and Conditions, 42
- transferring information to a new computer, 15
- troubleshooting, 29, 42
 - blue screen, 32
 - computer not responding, 31
 - Dell Diagnostics, 33
 - memory, 30
 - power, 29
 - power light conditions, 29
 - program crashes, 31
 - programs and Windows compatibility, 32
 - restore to previous state, 37-38
 - software, 31-32
 - tips, 29

U

- updates
 - software and hardware, 32

V

- view
 - back, 8
 - front, 7

W

warranty information, 42

Wi-Fi Catcher Network
Locator, 9

Windows License label, 42

Windows Vista

Dell Factory Image Restore, 38

Device Driver Rollback, 35

Program Compatibility wizard, 32

reinstalling, 41

returning to a previous device
driver version, 35

System Restore, 37-38

Windows XP

Files and Settings Transfer
Wizard, 15

reinstalling, 41

setting up Internet
connection, 15

System Restore, 37-38

wizards

Files and Settings Transfer
Wizard, 15

Program Compatibility wizard, 32