

HP MINI
User Guide

Antenna House XSL Formatter

Gucci 1.0 Vista User Guide 537596-001--Final Review

© Copyright 2009 Hewlett-Packard Development Company, L.P.

Product notice

Bluetooth is a trademark owned by its proprietor and used by Hewlett-Packard Company under license. Microsoft and Windows are U.S. registered trademarks of Microsoft Corporation. SD Logo is a trademark of its proprietor.

This user guide describes features that are common to most models. Some features may not be available on your computer.

The information contained herein is subject to change without notice. The only warranties for HP products and services are set forth in the express warranty statements accompanying such products and services. Nothing herein should be construed as constituting an additional warranty. HP shall not be liable for technical or editorial errors or omissions contained herein.

First Edition: July 2009

Document Part Number: 537596-001

Gucci 1.0 Vista User Guide 537596-001--Final Review

Safety warning notice

⚠ WARNING! To reduce the possibility of heat-related injuries or of overheating the computer, do not place the computer directly on your lap or obstruct the computer air vents. Use the computer only on a hard, flat surface. Do not allow another hard surface, such as an adjoining optional printer, or a soft surface, such as pillows or rugs or clothing, to block airflow. Also, do not allow the AC adapter to contact the skin or a soft surface, such as pillows or rugs or clothing, during operation. The computer and the AC adapter comply with the user-accessible surface temperature limits defined by the International Standard for Safety of Information Technology Equipment (IEC 60950).

Antenna House XSL Formatter

Table of contents

1 Features

Identifying hardware	1
Top components	1
TouchPad	1
Lights	3
Buttons	4
Keys	5
Front components	5
Right-side components	6
Left-side components	7
Display components	7
Bottom components	8
Wireless antennas	8
Additional hardware components	9
Identifying the labels	10

2 Power management

Setting power options	11
Using power-saving states	11
Initiating and exiting Sleep	11
Initiating and exiting Hibernation	12
Using the battery meter	12
Using power plans	12
Viewing the current power plan	12
Selecting a different power plan	13
Customizing power plans	13
Setting password protection on wakeup	13
Using external AC power	13
Connecting the AC adapter	14
Using battery power	15
Finding battery information in Help and Support	15
Using Battery Check	15
Displaying the remaining battery charge	16
Inserting or removing the battery	16

Gucci 1.0 Vista User Guide 537596-001--Final Review

Charging a battery	17
Maximizing battery discharge time	18
Managing low battery levels	18
Identifying low battery levels	18
Resolving a low battery level	19
Resolving a low battery level when external power is available	19
Resolving a low battery level when a charged battery is available	19
Resolving a low battery level when no power source is available	19
Resolving a low battery level when the computer cannot exit Hibernation	19
Calibrating a battery	19
Step 1: Fully charge the battery	19
Step 2: Disable Hibernation and Sleep	20
Step 3: Discharge the battery	20
Step 4: Fully recharge the battery	22
Step 5: Reenable Hibernation and Sleep	22
Conserving battery power	22
Storing a battery	22
Disposing of a used battery	23
Replacing the battery	23
Testing an AC adapter	24
Shutting down the computer	24

3 Wireless

Using wireless devices (select models only)	25
Identifying wireless and network icons	25
Using the wireless controls	26
Using the wireless switch	26
Using operating system controls	26
Using a WLAN	27
Setting up a WLAN	27
Protecting your WLAN	27
Connecting to a WLAN	29
Roaming to another network	29
Using Bluetooth wireless devices (select models only)	30
Bluetooth and Internet Connection Sharing (ICS)	30

4 Multimedia

Multimedia features	31
Identifying your multimedia components	31
Adjusting the volume	32
Multimedia software	33

Gucci 1.0 Vista User Guide 537596-001--Final Review

Using preinstalled multimedia software	34
Installing multimedia software from a disc	34
Sharing optical drives	34
Audio	35
Connecting external audio devices	35
Checking your audio functions	35
Video	37
Connecting an external monitor or projector	37
Optical drive (select models only)	38
Identifying the external optical drive	38
Using optical discs	38
Selecting the right disc	38
CD-R discs	39
CD-RW discs	39
DVD±R discs	39
DVD±RW discs	39
Playing music	39
Watching a movie	40
Changing DVD region settings	41
Creating or “burning” a CD or DVD	42
Removing an optical disc (CD or DVD)	42
Webcam	44
Adjusting webcam properties	44

5 Security

Protecting the computer	45
Using passwords	46
Setting passwords in Windows	46
Setting passwords in Computer Setup	46
Setup password	47
Managing a setup password	48
Entering a setup password	49
Power-on password	49
Managing a power-on password	50
Entering a power-on password	51
Requiring a power-on password at restart	52
Using Computer Setup DriveLock	52
Setting a DriveLock password	53
Entering a DriveLock password	54
Changing a DriveLock password	55
Removing DriveLock protection	56
Using Computer Setup security features	57
Securing system devices	57

Gucci 1.0 Vista User Guide 537596-001--Final Review

Using Computer Setup stringent security	57
Setting stringent security	58
Removing stringent security	59
Viewing Computer Setup System Information	59
Using antivirus software	60
Using firewall software	61
Installing critical updates	62
Installing a security cable	63

6 External devices

Using a USB device	64
Connecting a USB device	64
Stopping and removing a USB device	64
Using USB legacy support	65
Using external drives	66
Using optional external devices	66
Using an optional external MultiBay II	66
Using an optional external optical drive (select models only)	67
Inserting an optical disc (CD or DVD)	67
Removing an optical disc (CD or DVD)	68
When the disc tray opens	68
When the disc tray does not open	69

7 External media cards

Using SD Card Reader cards	70
Inserting a digital card	70
Stopping and removing a digital card	71

8 Pointing devices and keyboard

Using pointing devices	72
Setting pointing device preferences	72
Using the TouchPad	72
Connecting an external mouse	72
Using the keyboard	72
Using hotkeys	72
Displaying system information (fn+esc)	73
Initiating Sleep (fn+f1)	73
Switching the screen image (fn+f2)	75
Decreasing screen brightness (fn+f3)	75
Increasing screen brightness (fn+f4)	75
Initiating QuickLock (fn+f6)	75
Muting speaker sound (fn+f8)	75
Decreasing speaker sound (fn+f10)	76

Gucci 1.0 Vista User Guide 537596-001--Final Review

Increasing speaker sound (fn+f11)	76
Using keypads	76
Using the embedded numeric keypad	76
Enabling and disabling the embedded numeric keypad	76
Switching key functions on the embedded numeric keypad	77
Using an optional external numeric keypad	77
Cleaning the TouchPad and keyboard	78
9 Drives	
Identifying installed drives	79
Handling drives	79
Improving HD performance	81
Using Disk Defragmenter	81
Using Disk Cleanup	81
Using HP 3D DriveGuard (select models only)	82
Identifying HP 3D DriveGuard status	82
Using HP 3D DriveGuard software	83
Replacing a hard drive	84
10 Memory modules	
11 Computer Setup	
Starting Computer Setup	91
Using Computer Setup	91
Navigating and selecting in Computer Setup	91
Restoring factory settings in Computer Setup	92
Computer Setup menus	92
File menu	92
Security menu	93
Diagnostics menu	93
System Configuration menu	94
Index	96

Antenna House XSL Formatter

1 Features

Identifying hardware

Components included with the computer may vary by region and model. The illustrations in this chapter identify the standard features on most computer models.

To see a list of hardware installed in the computer, follow these steps:

1. Select **Start > Computer > System properties**.
2. In the left pane, click **Device Manager**.

You can also add hardware or modify device configurations using Device Manager.

 **NOTE:** Windows® includes the User Account Control feature to improve the security of your computer. You may be prompted for your permission or password for tasks such as installing applications, running utilities, or changing Windows settings. Refer to Help and Support for more information.

Top components

TouchPad

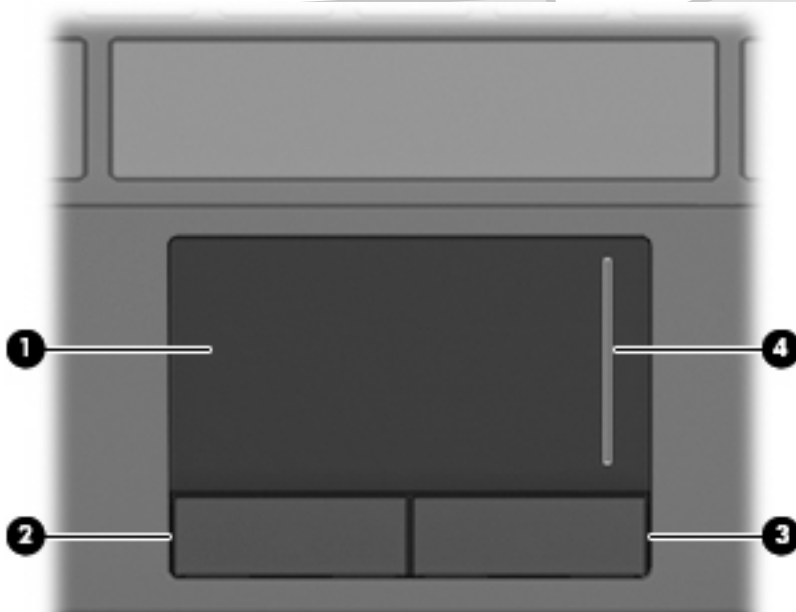

Gucci 1.0 Vista User Guide 537596-001--Final Review

Component	Description
(1) TouchPad*	Moves the pointer and selects or activates items on the screen.
(2) Left TouchPad button*	Functions like the left button on an external mouse.
(3) Right TouchPad button*	Functions like the right button on an external mouse.
(4) TouchPad scroll zone	Scrolls up or down.

*This table describes factory settings. To view or change pointing device preferences, select **Start > Control Panel > Hardware and Sound > Mouse**.

Gucci 1.0 Vista User Guide 537596-001--Final Review

Keys

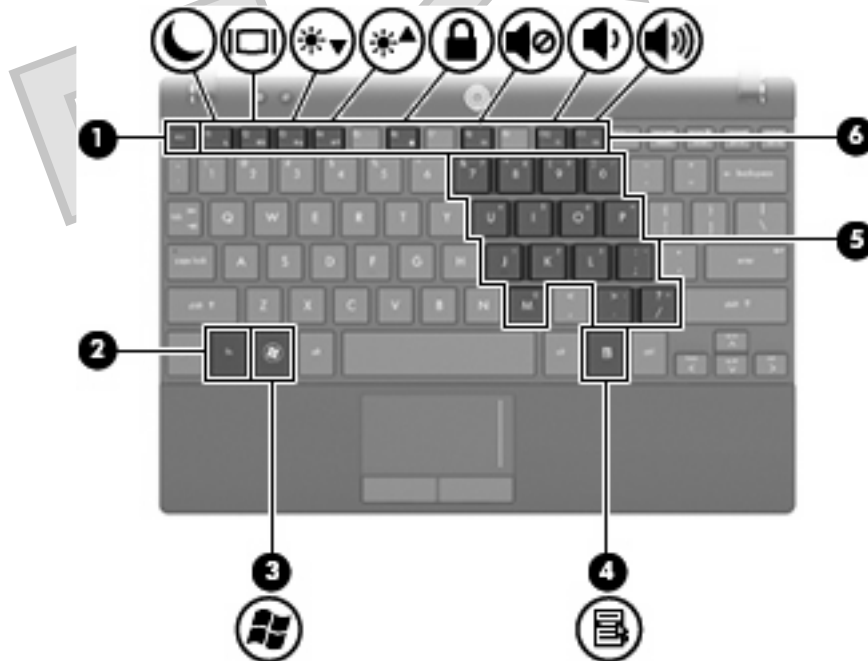

Component	Description
(1) esc key	Displays system information when pressed in combination with the fn key.
(2) fn key	Executes frequently used system functions when pressed in combination with a function key or the esc key.
(3) Windows logo key	Displays the Windows Start menu.
(4) Windows applications key	Displays a shortcut menu for items beneath the pointer.
(5) Embedded numeric keypad keys	Can be used like the keys on an external numeric keypad.
(6) Function keys	Execute frequently used system functions when pressed in combination with the fn key.

Front components



Component	Description
(1) Drive light	Blinking: The hard drive is being accessed.

Gucci 1.0 Vista User Guide 537596-001--Final Review



 **NOTE:** For optimal transmission, keep the areas immediately around the antennas free from obstructions.

To see wireless regulatory notices, refer to the section of the *Regulatory, Safety and Environmental Notices* that applies to your country or region. These notices are located in Help and Support.

Additional hardware components



Component	Description
(1) Power cord*	Connects an AC adapter to an AC outlet.
(2) AC adapter	Converts AC power to DC power.
(3) Battery*	Powers the computer when the computer is not plugged into external power.

*Batteries and power cords vary in appearance by region and country.

2 Power management

Setting power options

Using power-saving states

The computer has two power-saving states enabled at the factory: Sleep and Hibernation.

When Sleep is initiated, the power light blinks and the screen clears. Your work is saved to memory, letting you exit Sleep faster than exiting Hibernation. If the computer is in the Sleep state for an extended period or if the battery reaches a critical battery level while in the Sleep state, the computer initiates Hibernation.

When Hibernation is initiated, your work is saved to a hibernation file on the hard drive and the computer turns off.

△ **CAUTION:** To prevent possible audio and video degradation, loss of audio or video playback functionality, or loss of information, do not initiate Sleep or Hibernation while reading from or writing to a disc or an external media card.

📝 **NOTE:** You cannot initiate any type of networking connection or perform any computer functions while the computer is in the Sleep state or in Hibernation.

Initiating and exiting Sleep

The system is set at the factory to initiate Sleep after 15 minutes of inactivity when running on battery power and 30 minutes of inactivity when running on external power.

Power settings and timeouts can be changed using Power Options in Windows® Control Panel.

With the computer on, you can initiate Sleep in any of the following ways:

- Press **fn+f1**.
- Click **Start**, and then click the **Power** button.
- Click **Start**, click the arrow next to the Lock button, and then click **Sleep**.

To exit Sleep:

- Briefly slide the power switch.

When the computer exits Sleep, the power lights turn on and your work returns to the screen where you stopped working.

📝 **NOTE:** If you have set a password to be required when the computer exits Sleep, you must enter your Windows password before your work will return to the screen.

Gucci 1.0 Vista User Guide 537596-001--Final Review

Initiating and exiting Hibernation

The system is set at the factory to initiate Hibernation after 120 minutes of inactivity when running on battery power, 1080 minutes (18 hours) of inactivity when running on external power, or when the battery reaches a critical battery level.

Power settings and timeouts can be changed using Power Options in Windows Control Panel.

To initiate Hibernation:

1. Click **Start**, and then click the arrow next to the Lock button.
2. Click **Hibernate**.

To exit Hibernation:

- Briefly slide the power switch.

The power lights turn on and your work returns to the screen where you stopped working.

 **NOTE:** If you have set a password to be required when the computer exits Hibernation, you must enter your Windows password before your work will return to the screen.

Using the battery meter

The battery meter is located in the notification area, at the far right of the taskbar. The battery meter allows you to quickly access power settings, view remaining battery charge, and select a different power plan.

- To display the percentage of remaining battery charge and the current power plan, move the pointer over the battery meter icon.
- To access Power Options, or to change the power plan, click the battery meter icon and select an item from the list.

Different battery meter icons indicate whether the computer is running on battery or external power. The icon also displays a message if the battery has reached a critical battery level.

To hide or display the battery meter icon:

1. Right-click the taskbar, and then click **Properties**.
2. Click the **Notification Area** tab.
3. Under **System icons**, clear the **Power** check box to hide the battery meter icon, or select the **Power** check box to display the battery meter icon.
4. Click **OK**.

Using power plans

A power plan is a collection of system settings that manages how the computer uses power. Power plans can help you conserve power or maximize performance.

You can change power plan settings or create your own power plan.

Viewing the current power plan

- Move the pointer over the battery meter icon in the notification area, at the far right of the taskbar.

Gucci 1.0 Vista User Guide 537596-001--Final Review

– or –

Select **Start > Control Panel > System and Maintenance > Power Options**.

Selecting a different power plan

- Click the battery meter icon in the notification area, and then select a power plan from the list.

– or –

Select **Start > Control Panel > System and Maintenance > Power Options**, and then select a power plan from the list.

Customizing power plans

1. Click the battery meter icon in the notification area and then click **More power options**.

– or –

Select **Start > Control Panel > System and Maintenance > Power Options**.

2. Select a power plan, and then click **Change plan settings**.
3. Change the **Turn off the display** and **Put the computer to sleep** timeout settings, as needed.
4. To change additional settings, click **Change advanced power settings** and make your changes.

Setting password protection on wakeup

To set the computer to prompt for a password when the computer exits Sleep or Hibernation, follow these steps:

1. Select **Start > Control Panel > System and Maintenance > Power Options**.
2. In the left pane, click **Require a password on wakeup**.
3. Click **Change Settings that are currently unavailable**.
4. Click **Require a password (recommended)**.
5. Click **Save changes**.

Using external AC power

External AC power is supplied through one of the following devices:

⚠ WARNING! To reduce potential safety issues, use only the AC adapter provided with the computer, a replacement AC adapter provided by HP, or a compatible AC adapter purchased from HP.

- Approved AC adapter
- Optional docking device or optional expansion product

Connect the computer to external AC power under any of the following conditions:

Gucci 1.0 Vista User Guide 537596-001--Final Review

⚠ **WARNING!** Do not charge the computer battery while you are onboard aircraft.

- When you are charging or calibrating a battery
- When you are installing or modifying system software
- When you are writing information to a CD or DVD

When you connect the computer to external AC power, the following events occur:

- The battery begins to charge.
- If the computer is turned on, the battery meter icon in the notification area changes appearance.

When you disconnect external AC power, the following events occur:

- The computer switches to battery power.
- The display brightness is automatically decreased to save battery life. To increase display brightness, press the **fn+f4** hotkey or reconnect the AC adapter.

Connecting the AC adapter

⚠ **WARNING!** To reduce the risk of electric shock or damage to the equipment:

Plug the power cord into an AC outlet that is easily accessible at all times.

Disconnect power from the computer by unplugging the power cord from the AC outlet (not by unplugging the power cord from the computer).

If provided with a 3-pin attachment plug on the power cord, plug the cord into a grounded (earthed) 3-pin outlet. Do not disable the power cord grounding pin, for example, by attaching a 2-pin adapter. The grounding pin is an important safety feature.

To connect the computer to external AC power, follow these steps:

1. Plug the AC adapter into the power connector **(1)** on the computer.
2. Plug the power cord into the AC adapter **(2)**.
3. Plug the other end of the power cord into an AC outlet **(3)**.



Gucci 1.0 Vista User Guide 537596-001--Final Review

Using battery power

When a charged battery is in the computer and the computer is not plugged into external power, the computer runs on battery power. When the computer is plugged into external AC power, the computer runs on AC power.

If the computer contains a charged battery and is running on external AC power supplied through the AC adapter, the computer switches to battery power if the AC adapter is disconnected from the computer.

 **NOTE:** The display brightness is decreased to save battery life when you disconnect AC power. To increase display brightness, use the **fn+f4** hotkey or reconnect the AC adapter.

You can keep a battery in the computer or in storage, depending on how you work. Keeping the battery in the computer whenever the computer is plugged into AC power charges the battery and also protects your work in case of a power outage. However, a battery in the computer slowly discharges when the computer is off and unplugged from external power.

 **WARNING!** To reduce potential safety issues, use only the battery provided with the computer, a replacement battery provided by HP, or a compatible battery purchased from HP.

Computer battery life varies, depending on power management settings, programs running on the computer, display brightness, external devices connected to the computer, and other factors.

Finding battery information in Help and Support

The “Battery information” section of the Help and Support Learning Center provides the following tools and information:

- Battery Check tool to test battery performance
- Information on calibration, power management, and proper care and storage to maximize battery life
- Information on battery types, specifications, life cycles, and capacity

To access battery information:

- Select **Start > Help and Support > Learning Center > HP Power and Battery Learning Center**.

Using Battery Check

Battery Check, a part of the Total Care Advisor, provides information on the status of the battery installed in the computer.

To run Battery Check:

1. Connect the AC adapter to the computer.

 **NOTE:** The computer must be connected to external power for Battery Check to function properly.

2. Select **Start > Help and Support > Troubleshooting tools > Battery Check**.

Battery Check examines the battery and its cells to see if they are functioning properly, and then reports the results of the examination.

Gucci 1.0 Vista User Guide 537596-001--Final Review

Displaying the remaining battery charge

- Move the pointer over the battery meter icon in the notification area, at the far right of the taskbar.
- or –

View the estimated number of minutes of battery charge remaining in Windows Mobility Center:

- Click the battery meter icon, and then click **Windows Mobility Center**.
- or –

Select **Start > Control Panel > Mobile PC > Windows Mobility Center**.

The time shown indicates the approximate running time remaining on the battery *if the battery continues to provide power at the current level*. For example, the time remaining will decrease when a DVD is playing and will increase when a DVD stops playing.

Inserting or removing the battery

- △ **CAUTION:** Removing a battery that is the sole power source can cause loss of information. To prevent loss of information, initiate Hibernation or shut down the computer through Windows before removing the battery.

To insert the battery:

1. Turn the computer upside down on a flat surface, with the battery bay toward you.
2. Insert the battery into the battery bay (1) and push in until it is seated.

The battery release latches (2) automatically lock the battery into place.

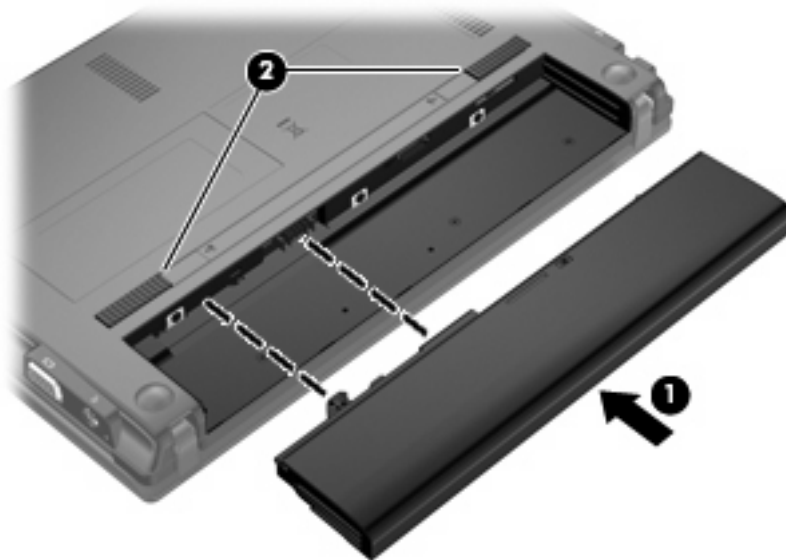

To remove the battery:

1. Turn the computer upside down on a flat surface, with the battery bay toward you.
2. Slide the battery release latches (1) to release the battery.

Gucci 1.0 Vista User Guide 537596-001--Final Review

3. Remove the battery (2) from the computer.

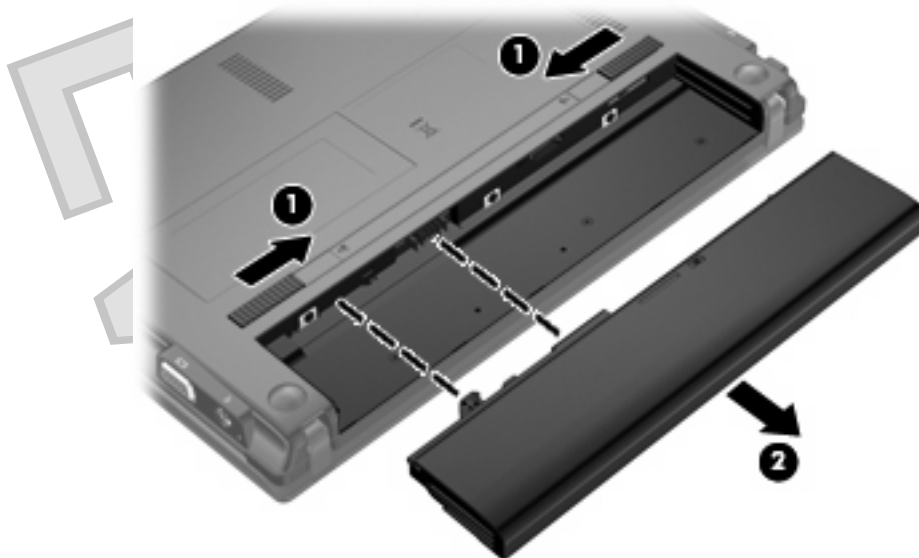

Charging a battery

⚠ WARNING! Do not charge the computer battery while you are onboard aircraft.

The battery charges whenever the computer is plugged into external power through an AC adapter, an optional power adapter, an optional expansion product, or an optional docking device.

The battery charges whether the computer is off or in use, but it charges faster when the computer is off.

Charging may take longer if a battery is new, has been unused for 2 weeks or more, or is much warmer or cooler than room temperature.

To prolong battery life and optimize the accuracy of battery charge displays, follow these recommendations:

- If you are charging a new battery, charge it fully before turning on the computer.
- Charge the battery until the battery light turns off.

📝 NOTE: If the computer is on while the battery is charging, the battery meter in the notification area may show 100 percent charge before the battery is fully charged.

- Allow the battery to discharge below 5 percent of a full charge through normal use before charging it.
- If the battery has been unused for one month or more, calibrate the battery instead of simply charging it.

The battery light displays charge status:

- On: The battery is charging.
- Blinking: The battery has reached a low battery level or critical battery level and is not charging.
- Off: The battery is fully charged, in use, or not installed.

Gucci 1.0 Vista User Guide 537596-001--Final Review

Maximizing battery discharge time

Battery discharge time varies, depending on the features you use while on battery power. Maximum discharge time gradually shortens as the battery storage capacity naturally degrades.

Tips for maximizing battery discharge time:

- Lower the brightness on the display.
- Check the **Power saver** setting in Power Options.
- Remove the battery from the computer when it is not being used or charged.
- Store the battery in a cool, dry location.

Managing low battery levels

The information in this section describes the alerts and system responses set at the factory. Some low-battery alerts and system responses can be changed using Power Options in Windows Control Panel. Preferences set using Power Options do not affect lights.

Identifying low battery levels

When a battery that is the sole power source for the computer reaches a low battery level, the battery light blinks.

If a low battery level is not resolved, the computer enters a critical battery level, and the battery light blinks rapidly.

The computer takes the following actions for a critical battery level:

- If Hibernation is enabled and the computer is on or in the Sleep state, the computer initiates Hibernation.
- If Hibernation is disabled and the computer is on or in the Sleep state, the computer remains briefly in the Sleep state, and then shuts down and loses any unsaved information.

Gucci 1.0 Vista User Guide 537596-001--Final Review

Resolving a low battery level

△ CAUTION: To reduce the risk of losing information when the computer reaches a critical battery level and has initiated Hibernation, do not restore power until the power lights turn off.

Resolving a low battery level when external power is available

- Connect one of the following devices:
 - AC adapter
 - Optional expansion product or docking device
 - Optional power adapter

Resolving a low battery level when a charged battery is available

1. Turn off the computer or initiate Hibernation.
2. Remove the discharged battery, and then insert a charged battery.
3. Turn on the computer.

Resolving a low battery level when no power source is available

- Initiate Hibernation.
– or –
Save your work and shut down the computer.

Resolving a low battery level when the computer cannot exit Hibernation

When the computer lacks sufficient power to exit Hibernation, follow these steps:

1. Insert a charged battery or plug the computer into external power.
2. Exit Hibernation by briefly sliding the power switch.

Calibrating a battery

Calibrate a battery under the following conditions:

- When battery charge displays seem inaccurate
- When you observe a significant change in battery run time

Even if a battery is heavily used, it should not need to be calibrated more than once a month. It is also not necessary to calibrate a new battery.

Step 1: Fully charge the battery

△ WARNING! Do not charge the computer battery while you are onboard aircraft.

📝 NOTE: The battery charges whether the computer is off or in use, but it charges faster when the computer is off.

Gucci 1.0 Vista User Guide 537596-001--Final Review

To fully charge the battery:

1. Insert the battery into the computer.
2. Connect the computer to an AC adapter, optional power adapter, optional expansion product, or optional docking device, and then plug the adapter or device into external power.

The battery light on the computer turns on.

3. Leave the computer plugged into external power until the battery is fully charged.

The battery light on the computer turns off.

Step 2: Disable Hibernation and Sleep

1. Click the battery meter icon in the notification area, and then click **More power options**.

– or –

Select **Start > Control Panel > System and Maintenance > Power Options**.

2. Under the current power plan, click **Change plan settings**.
3. Record the **Turn off the display** and **Put the computer to sleep** settings listed in the **On battery** column so that you can reset them after the calibration.
4. Change the **Turn off the display** and **Put the computer to sleep** settings to **Never**.
5. Click **Change advanced power settings**.
6. Click the plus sign next to **Sleep**, and then click the plus sign next to **Hibernate after**.
7. Record the **On battery** setting under **Hibernate after** so that you can reset it after the calibration.
8. Change the **On battery** setting to **Never**.
9. Click **OK**.
10. Click **Save changes**.

Step 3: Discharge the battery

The computer must remain on while the battery is being discharged. The battery can discharge whether or not you are using the computer, but the battery will discharge faster while you are using it.

- If you plan to leave the computer unattended during the discharge, save your information before beginning the discharge procedure.
- If you use the computer occasionally during the discharge procedure and have set energy-saving timeouts, expect the following performance from the system during the discharge process:
 - The monitor will not turn off automatically.
 - Hard drive speed will not decrease automatically when the computer is idle.
 - System-initiated Hibernation will not occur.

Gucci 1.0 Vista User Guide 537596-001--Final Review

To discharge a battery:

1. Unplug the computer from its external power source, but do *not* turn off the computer.
2. Run the computer on battery power until the battery is discharged. The battery light begins to blink when the battery has discharged to a low battery level. When the battery is discharged, the battery light turns off and the computer shuts down.

Gucci 1.0 Vista User Guide 537596-001--Final Review

Step 4: Fully recharge the battery

To recharge the battery:

1. Plug the computer into external power and maintain external power until the battery is fully recharged. When the battery is recharged, the battery light on the computer turns off.

You can use the computer while the battery is recharging, but the battery will charge faster if the computer is off.

2. If the computer is off, turn it on when the battery is fully charged and the battery light has turned off.

Step 5: Reenable Hibernation and Sleep

△ **CAUTION:** Failure to reenable Hibernation after calibration may result in a full battery discharge and information loss if the computer reaches a critical battery level.

1. Click the battery meter icon in the notification area, and then click **More power options**.

– or –

Select **Start > Control Panel > System and Maintenance > Power Options**.

2. Under the current power plan, click **Change plan settings**.
3. Reenter the settings that you recorded for the items in the **On battery** column.
4. Click **Change advanced power settings**.
5. Click the plus sign next to **Sleep**, and then click the plus sign next to **Hibernate after**.
6. Reenter the setting that you recorded for **On battery**.
7. Click **OK**.
8. Click **Save changes**.

Conserving battery power

- Select low power-use settings through Power Options in Windows Control Panel.
- Turn off wireless and local area network (LAN) connections and exit modem applications when you are not using them.
- Disconnect external devices that are not plugged into an external power source, when you are not using them.
- Stop, disable, or remove any external media cards that you are not using.
- Use the **fn+f3** and **fn+f4** hotkeys to adjust screen brightness as needed.
- If you leave your work, initiate Sleep or Hibernation, or shut down the computer.

Storing a battery

△ **CAUTION:** To prevent damage to a battery, do not expose it to high temperatures for extended periods of time.

Gucci 1.0 Vista User Guide 537596-001--Final Review

If a computer will be unused and unplugged from external power for more than 2 weeks, remove the battery and store it separately.

To prolong the charge of a stored battery, place it in a cool, dry place.

 **NOTE:** A stored battery should be checked every 6 months. If the capacity is less than 50 percent, recharge the battery before returning it to storage.

Calibrate a battery before using it if it has been stored for one month or more.

Disposing of a used battery

 **WARNING!** To reduce the risk of fire or burns, do not disassemble, crush, or puncture; do not short external contacts; do not dispose of in fire or water.

Refer to the *Regulatory, Safety and Environmental Notices* for battery disposal information.

Replacing the battery

Computer battery life varies, depending on the power management settings, programs running on the computer, display brightness, external devices connected to the computer, and other factors.

Battery Check notifies you to replace the battery when an internal cell is not charging properly, or when the battery storage capacity has reached a “weak” condition. A message refers you to the HP Web site for more information about ordering a replacement battery. If the battery is possibly covered by an HP warranty, instructions include a warranty ID.

 **NOTE:** To ensure that you always have battery power when you need it, HP recommends purchasing a new battery when the storage capacity indicator turns green-yellow.

Gucci 1.0 Vista User Guide 537596-001--Final Review

Testing an AC adapter

Test the AC adapter if the computer exhibits any of the following symptoms:

- The computer will not turn on when connected to the AC adapter.
- The display does not turn on when the computer is connected to the AC adapter.
- The power light is off when the computer is connected to the AC adapter.

To test the AC adapter:

1. Remove the battery from the computer.
2. Connect the AC adapter.
3. Turn on the computer.
 - If the power light turns **on**, the AC adapter is functioning properly.
 - If the power light remains **off**, the AC adapter is not functioning and should be replaced.

Contact technical support for information on obtaining a replacement AC power adapter by selecting **Start > Help and Support > Contact support**.

Shutting down the computer

△ **CAUTION:** Unsaved information will be lost when the computer is shut down.

The Shut Down command closes all open programs, including the operating system, and then turns off the display and computer.

Shut down the computer under any of the following conditions:

- When you need to replace the battery or access components inside the computer
- When you are connecting an external hardware device that does not connect to a USB port
- When the computer will be unused and disconnected from external power for an extended period

To shut down the computer, follow these steps:

📝 **NOTE:** If the computer is in the Sleep state or in Hibernation, you must first exit Sleep or Hibernation before shutdown is possible.

1. Save your work and close all open programs.
2. Click **Start**, and then click the arrow next to the Lock button.
3. Click **Shut Down**.

If the computer is unresponsive and you are unable to use the preceding shutdown procedures, try the following emergency procedures in the sequence provided:

- Press **ctrl+alt+delete**, and then slide the power switch.
- Slide and hold the power switch for at least 5 seconds.
- Disconnect the computer from external power and remove the battery.

3 Wireless

Using wireless devices (select models only)

Wireless technology transfers data across radio waves instead of wires. Your computer may be equipped with one or more of the following wireless devices:

- Wireless local area network (WLAN) device—Connects the computer to wireless local area networks (commonly referred to as Wi-Fi networks, wireless LANs, or WLANs) in corporate offices, your home, and public places such as airports, restaurants, coffee shops, hotels, and universities. In a WLAN, each mobile wireless device communicates with a wireless router or a wireless access point.
- Bluetooth® device—Creates a personal area network (PAN) to connect to other Bluetooth-enabled devices such as computers, phones, printers, headsets, speakers, and cameras. In a PAN, each device communicates directly with other devices, and devices must be relatively close together—typically within 10 meters (approximately 33 feet) of each other.

Computers with WLAN devices support one or more of the following IEEE industry standards:

- 802.11b, the first popular standard, supports data rates of up to 11 Mbps and operates at a frequency of 2.4 GHz.
- 802.11g supports data rates of up to 54 Mbps and operates at a frequency of 2.4 GHz. An 802.11g WLAN device is backward compatible with 802.11b devices, so they can operate on the same network.
- 802.11a supports data rates of up to 54 Mbps and operates at a frequency of 5 GHz.

 **NOTE:** 802.11a is not compatible with 802.11b and 802.11g.

- Wi-Fi CERTIFIED 802.11n draft 2.0 supports data rates of up to 300 Mbps and may operate at 2.4 GHz or 5 GHz, making it backward compatible with 802.11a, b, and g.

 **NOTE:** The specifications for the 802.11n WLAN are draft specifications and are not final. If the final specifications differ from the draft specifications, it may affect the ability of the computer to communicate with other 802.11n WLAN devices.

For more information on wireless technology, refer to the information and Web site links provided in Help and Support.

Identifying wireless and network icons

Icon	Name	Description
------	------	-------------

Gucci 1.0 Vista User Guide 537596-001--Final Review



Wireless (connected) Identifies the location of the wireless light and the wireless switch on the computer.



Wireless (disconnected) Indicates that all of the wireless devices are off.



Network status (connected) Indicates that one or more of your network drivers are installed and one or more network devices are connected to the network.



Network status (disconnected) Indicates that one or more of your network drivers are installed but no network devices are connected to the network.

Using the wireless controls

You can control the wireless devices in your computer using these features:

- Wireless switch
- Operating system controls

Using the wireless switch

The computer has a wireless switch, one or more wireless devices, and one or two wireless lights, depending on the model. All of the wireless devices on your computer are enabled at the factory, so the wireless light is on (blue) when you turn on the computer.

The wireless light indicates the overall power state of your wireless devices, not the status of individual devices. If the wireless light is blue, at least one wireless device is on. If the wireless light is amber, all wireless devices are off.

Because the wireless devices are enabled at the factory, you can use the wireless switch to turn on or turn off the wireless devices simultaneously. Individual wireless devices can be controlled through Computer Setup.

 **NOTE:** If the wireless devices are disabled by Computer Setup, the wireless switch will not work until you reenable your devices.

Using operating system controls

Some operating systems also offer a way to manage integrated wireless devices and the wireless connection. For more information, refer to the operating system documentation.

Gucci 1.0 Vista User Guide 537596-001--Final Review

Using a WLAN

With a WLAN device, you can access a wireless local area network (WLAN), which is composed of other computers and accessories that are linked by a wireless router or a wireless access point.

 **NOTE:** The terms *wireless router* and *wireless access point* are often used interchangeably.

- A large-scale WLAN, such as a corporate or public WLAN, typically uses wireless access points that can accommodate a large number of computers and accessories and can separate critical network functions.
- A home or small office WLAN typically uses a wireless router, which allows several wireless and wired computers to share an Internet connection, a printer, and files without requiring additional pieces of hardware or software.

 **NOTE:** To use the WLAN device in your computer, you must connect to a WLAN infrastructure (provided through a service provider or a public or corporate network).

Setting up a WLAN

To set up a WLAN and connect to the Internet, you need the following equipment:

- A broadband modem (either DSL or cable) (1) and high-speed Internet service purchased from an Internet service provider (ISP)
- A wireless router (purchased separately) (2)
- The wireless computer (3)

The illustration below shows an example of a wireless network installation that is connected to the Internet.

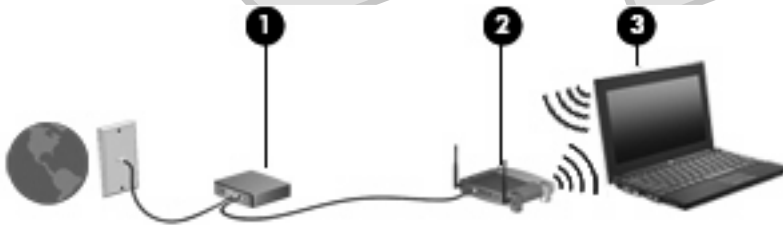

As your network grows, additional wireless and wired computers can be connected to the network to access the Internet.

For help in setting up your WLAN, refer to the information provided by your router manufacturer or your ISP.

Protecting your WLAN

Because the WLAN standard was designed with only limited security capabilities—basically to foil casual eavesdropping rather than more powerful forms of attack—it is essential to understand that WLANs are vulnerable to well-known and well-documented security weaknesses.

WLANs in public areas, or “hotspots,” like coffee shops and airports may not provide any security. New technologies are being developed by wireless manufacturers and hotspot service providers that make the public environment more secure and anonymous. If you are concerned about the security of your computer in a hotspot, limit your network activities to noncritical e-mail and basic Internet surfing.

Gucci 1.0 Vista User Guide 537596-001--Final Review

When you set up a WLAN or access an existing WLAN, always enable security features to protect your network from unauthorized access. The common security levels are Wi-Fi Protected Access (WPA) and Wired Equivalent Privacy (WEP). Because wireless radio signals travel outside the network, other WLAN devices can pick up unprotected signals and either connect to your network (uninvited) or capture information being sent across it. However, you can take precautions to protect your WLAN:

- **Use a wireless transmitter with built-in security**

Many wireless base stations, gateways, and routers provide built-in security features such as wireless security protocols and firewalls. With the correct wireless transmitter, you can protect your network from the most common wireless security risks.

- **Work behind a firewall**

A firewall is a barrier that checks both data and requests for data that are sent to your network and then discards any suspicious items. Firewalls are available in many varieties, both software and hardware. Some networks use a combination of both types.

- **Use wireless encryption**

A variety of sophisticated encryption protocols is available for your WLAN. Find the solution that works best for your network security:

- **Wired Equivalent Privacy (WEP)** is a wireless security protocol that uses a WEP key to encode or encrypt all network data before it is transmitted. Usually, you can allow the network to assign the WEP key. Alternatively, you can set up your own key, generate a different key, or choose other advanced options. Without the correct key, others will not be able to use the WLAN.
- **WPA (Wi-Fi Protected Access)**, like WEP, uses security settings to encrypt and decrypt data that is transmitted over the network. However, instead of using one static security key for encryptions as WEP does, WPA uses *temporal key integrity protocol* (TKIP) to dynamically generate a new key for every packet. It also generates different sets of keys for each computer on the network.

- **Close your network**

If possible, prevent your network name (SSID) from being broadcast by the wireless transmitter. Most networks initially broadcast the name, telling any computer nearby that your network is available. By closing the network, other computers are less likely to know that your network exists.

 **NOTE:** If your network is closed and the SSID is not broadcast, you will need to know or remember the SSID to connect new devices to the network. Write down the SSID and store it in a secure place before closing the network.

Gucci 1.0 Vista User Guide 537596-001--Final Review

Connecting to a WLAN

To connect to the WLAN, follow these steps:

1. Be sure that the WLAN device is on. If it is on, the wireless light is on. If the wireless light is amber, slide the wireless switch.
2. Select **Start > Connect To**.
3. Select your WLAN from the list, and then type the network security key, if required.
 - If the network is unsecured, meaning that anyone can access the network, a warning is displayed. Click **Connect Anyway** to accept the warning and complete the connection.
 - If the network is a security-enabled WLAN, you are prompted to enter a network security key, which is a security code. Type the code, and then click **Connect** to complete the connection.

 **NOTE:** If no WLANs are listed, you are out of range of a wireless router or access point.

NOTE: If you do not see the network you want to connect to, click **Show all connections**. A list of options will appear that includes creating a new network connection, as well as troubleshooting connection issues.

After the connection is made, place the mouse pointer over the network status icon in the notification area, at the far right of the taskbar, to verify the name and status of the connection.

 **NOTE:** The functional range (how far your wireless signals travel) depends on WLAN implementation, router manufacturer, and interference from other electronic devices or structural barriers such as walls and floors.

More information about using a WLAN is available through the following resources:

- Information from your ISP and the manufacturer's instructions included with your wireless router and other WLAN equipment
- Information and Web site links provided in Help and Support

For a list of public WLANs near you, contact your ISP or search the Web. Web sites that list public WLANs include Cisco Internet Mobile Office Wireless Locations, Hotspotlist, and Geektools. Check with each public WLAN location for cost and connection requirements.

For additional information on connecting your computer to a corporate WLAN, contact your network administrator or IT department.

Roaming to another network

When you move your computer within range of another WLAN, Windows attempts to connect to that network. If the attempt is successful, your computer is automatically connected to the new network. If Windows does not recognize the new network, follow the same procedure you used initially to connect to your WLAN.

Gucci 1.0 Vista User Guide 537596-001--Final Review

Using Bluetooth wireless devices (select models only)

A Bluetooth device provides short-range wireless communications that replace the physical cable connections that traditionally link electronic devices such as the following:

- Computers (desktop, notebook, PDA)
- Phones (cellular, cordless, smart phone)
- Imaging devices (printer, camera)
- Audio devices (headset, speakers)

Bluetooth devices provide peer-to-peer capability that allows you to set up a personal area network (PAN) of Bluetooth devices. For information on configuring and using Bluetooth devices, refer to the Bluetooth software Help.

Bluetooth and Internet Connection Sharing (ICS)

HP does **not** recommend setting up one computer with Bluetooth as a host and using it as a gateway through which other computers may connect to the Internet. When two or more computers are connected using Bluetooth, and Internet Connection Sharing (ICS) is enabled on one of the computers, the other computers may not be able to connect to the Internet using the Bluetooth network.

The strength of Bluetooth is in synchronizing information transfers between your computer and wireless devices including cellular phones, printers, cameras, and PDAs. The inability to consistently connect two or more computers to share the Internet through Bluetooth is a limitation of Bluetooth and the Windows operating system.

4 Multimedia

Multimedia features

Your computer includes multimedia features that allow you to listen to music and view pictures. Your computer may include the following multimedia components:

- Integrated speakers for listening to music
- Integrated microphones for recording your own audio
- Integrated webcam that allows you to capture and share video
- Preinstalled multimedia software that allows you to play and manage your music, movies, and pictures
- Hotkeys that provide fast access to volume control

 **NOTE:** Your computer may not include all of the components listed.

The following sections explain how to identify and use the multimedia components included with your computer.

Identifying your multimedia components

The following illustration and table describe the multimedia features of the computer.

Gucci 1.0 Vista User Guide 537596-001--Final Review

- To increase volume, press **fn+f11**.



- Windows volume control:
 - a. Click the **Volume** icon in the notification area, at the far right of the taskbar.
 - b. Increase or decrease the volume by moving the slider up or down. Click the **Mute** icon to mute the volume.– or –
 - a. Right-click the **Volume** icon in the notification area, and then click **Open Volume Mixer**.
 - b. In the Speakers column, you can increase or decrease the volume by moving the **Volume** slider up or down. You can also mute the volume by clicking the **Mute** icon.

If the Volume icon is not displayed in the notification area, follow these steps to add it:

- a. Right-click in the notification area, and then click **Properties**.
 - b. Click the **Notification Area** tab.
 - c. Under System icons, select the **Volume** check box.
 - d. Click **OK**.
- Program volume control:

Volume can also be adjusted within some programs.

Multimedia software

Your computer includes preinstalled multimedia software that allows you to play music and view pictures. The following sections provide details about preinstalled multimedia software and installing multimedia software from a disc.

Gucci 1.0 Vista User Guide 537596-001--Final Review

Audio

Your computer enables you to use a variety of audio features:

- Play music using your computer speakers and/or connected external speakers
- Record sound using the internal microphones or connect an external microphone
- Download music from the Internet
- Create multimedia presentations using audio and images
- Transmit sound and images with instant messaging programs
- Stream radio programs (select models only) or receive FM radio signals
- Create or “burn” audio CDs using an external optical drive

Connecting external audio devices

⚠ **WARNING!** To reduce the risk of personal injury, adjust the volume before putting on headphones, earbuds, or a headset. For additional safety information, refer to the *Regulatory, Safety and Environmental Notices*.

To connect external devices such as external speakers, headphone, or a microphone, refer to the information provided with the device. For best results, remember the following tips:

- Be sure that the device cable is securely connected to the correct jack on your computer. (Cable connectors are normally color-coded to match the corresponding jacks on the computer.)
- Be sure to install any drivers required by the external device.

 **NOTE:** A driver is a required program that acts like a translator between the device and the programs that use the device.

Checking your audio functions

To check the system sound on your computer, follow these steps:

1. Select **Start > Control Panel**.
2. Click **Hardware and Sound**.
3. Click **Sound**.
4. When the Sound window opens, click the **Sounds** tab. Under **Program**, select any sound event, such as a beep or alarm, and click the **Test** button.

You should hear sound through the speakers or through connected headphones.

To check the record functions of the computer, follow these steps:

1. Select **Start > All Programs > Accessories > Sound Recorder**.
2. Click **Start Recording** and speak into the microphone. Save the file to the desktop.
3. Open Windows Media Player and play back the sound.

Gucci 1.0 Vista User Guide 537596-001--Final Review

 **NOTE:** For best results when recording, speak directly into the microphone and record sound in a setting free of background noise.

- To confirm or change the audio settings on your computer, right-click the **Sound** icon on the taskbar, or select **Start > Control Panel > Audio**.

Gucci 1.0 Vista User Guide 537596-001--Final Review

Video

Your computer enables you to use a variety of video features:

- Play games over the Internet
- Edit pictures and video to create presentations
- Connect external video devices

Connecting an external monitor or projector

The external monitor port connects an external display device such as an external monitor or a projector to the computer.

- To connect a display device, connect the device cable to the external monitor port.

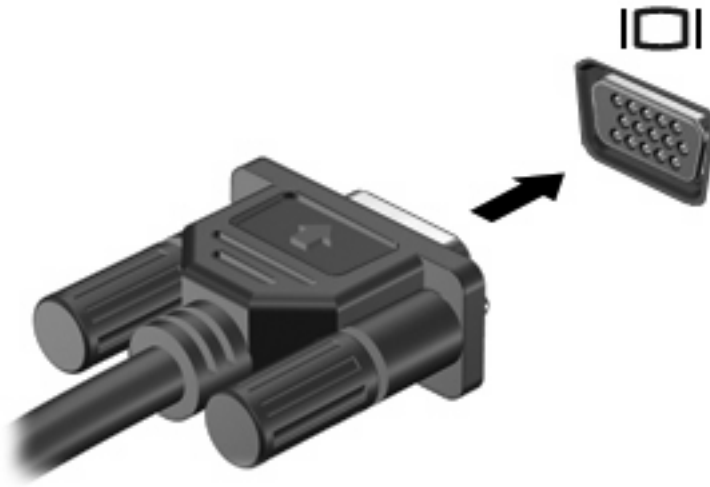

 **NOTE:** If a properly connected external display device does not display an image, press **fn+f2** to transfer the image to the device. Repeatedly pressing **fn+f2** alternates the screen image between the computer display and the device.

Gucci 1.0 Vista User Guide 537596-001--Final Review

Optical drive (select models only)

Your computer may come with an external optical drive that expands the functionality of the computer. The external optical drive allows you to read data discs, play music, and watch movies.

Identifying the external optical drive

- Select **Start > Computer**.

You will see a list of all the devices installed on your computer, including the connected external optical drive. You may have one of the following types of drives:

- DVD-ROM Drive
- DVD/CD-RW Combo Drive
- DVD±RW/CD-RW Combo Drive

 **NOTE:** Some of the drives listed above may not be supported by your computer.

Using optical discs

An optical drive, such as a DVD-ROM drive, supports optical discs (CDs and DVDs). These discs store information, such as music, photos, and movies. DVDs have a higher storage capacity than CDs.

The external optical drive can read standard CD and DVD discs.

 **NOTE:** Some of the optical drives listed may not be supported by your computer. The listed drives are not necessarily all of the supported optical drives.

Some optical drives can also write to optical discs as described in the following table.

Optical drive type	Read from CD and DVD-ROM media	Write to CD-R/RW media	Write to DVD (includes DVD+R DL, DVD±RW/R, and DVD-ROM media)	Write label to LightScribe CD or DVD
DVD-ROM Drive	Yes	No	No	No
DVD/CD-RW Combo Drive	Yes	Yes	No	No
DVD±RW/CD-RW Combo Drive	Yes	Yes	Yes	No

 **CAUTION:** To prevent possible audio and video degradation, loss of information, or loss of audio or video playback functionality, do not initiate Sleep or Hibernation while reading or writing to a CD or DVD.

Selecting the right disc

An optical drive supports optical discs (CDs and DVDs). CDs, used to store digital data, are also used for commercial audio recordings and are convenient for your personal storage needs. DVDs are used primarily for movies, software, and data backup purposes. DVDs are the same form factor as CDs but have 6 to 7 times the storage capacity.

 **NOTE:** The external optical drive connected to your computer may not support all the types of optical discs discussed in this section.

Gucci 1.0 Vista User Guide 537596-001--Final Review

5. Gently press the disc (3) down onto the tray spindle until the disc snaps into place.



6. Close the disc tray.
7. If you have not yet configured AutoPlay, the AutoPlay dialog box opens and asks how you want to use the media content. Choose Windows Media Player, which is preinstalled on your computer.

 **NOTE:** After you insert a disc, a short pause is normal.

If Sleep or Hibernation is accidentally initiated during playback of a disc:

- Your playback may be interrupted.
- You may see a warning message asking if you want to continue. If this message is displayed, click **No**.
- You may need to restart the CD or DVD to resume playback.

Watching a movie

An external optical drive allows you to watch movies from a disc.

 **NOTE:** Be sure that the external optical drive is connected to your computer before beginning these steps.

1. Turn on the computer.
2. Press the release button (1) on the external optical drive bezel to release the disc tray.
3. Pull out the tray (2).
4. Hold the disc by the edges and position the disc label-side up over the tray spindle.

 **NOTE:** If the tray is not fully accessible, tilt the disc carefully to position it over the spindle.

Gucci 1.0 Vista User Guide 537596-001--Final Review

Creating or “burning” a CD or DVD

If your external optical drive is a CD-RW, DVD-RW, or DVD±RW optical drive, you can use software such as Windows Media Player to burn data and audio files, including MP3 and WAV music files. To burn video files to a CD or DVD, use MyDVD.

Observe the following guidelines when burning a CD or DVD:

- Before burning a disc, save and close any open files and close all programs.
- A CD-R or DVD-R is usually best for burning audio files because after the information is copied, it cannot be changed.
- Because some home and car stereos will not play CD-RWs, use CD-Rs to burn music CDs.
- A CD-RW or DVD-RW is generally best for burning data files or for testing audio or video recordings before you burn them to a CD or DVD that cannot be changed.
- DVD players used in home systems usually do not support all DVD formats. Refer to the user guide that came with your DVD player for a list of supported formats.
- An MP3 file uses less space than other music file formats, and the process for creating an MP3 disc is the same as the process for creating a data file. MP3 files can be played only on MP3 players or on computers with MP3 software installed.

To burn a CD or DVD, follow these steps:

1. Download or copy the source files into a folder on your hard drive.
2. Insert a blank CD or DVD into the external optical drive.
3. Select **Start > All Programs** and the name of the software you want to use.
4. Select the kind of CD or DVD you want to create—data, audio, or video.
5. Right-click **Start**, click **Explore**, and navigate to the folder where the source files are stored.
6. Open the folder, and then drag the files to the drive that contains the blank optical disc.
7. Initiate the burning process as directed by the program you have selected.

For specific instructions, refer to the software manufacturer's instructions, which may be provided with the software, on disc, or on the manufacturer's Web site.

-
- △ **CAUTION:** Observe the copyright warning. It is a criminal offense, under applicable copyright laws, to make unauthorized copies of copyright-protected material, including computer programs, films, broadcasts, and sound recordings. Do not use this computer for such purposes.
-

Removing an optical disc (CD or DVD)

1. Press the release button **(1)** on the drive bezel to release the disc tray, and then gently pull out the tray **(2)** until it stops.

Gucci 1.0 Vista User Guide 537596-001--Final Review

2. Remove the disc (3) from the tray by gently pressing down on the spindle while lifting the outer edges of the disc. Hold the disc by the edges and avoid touching the flat surfaces.

 **NOTE:** If the tray is not fully accessible, tilt the disc carefully as you remove it.

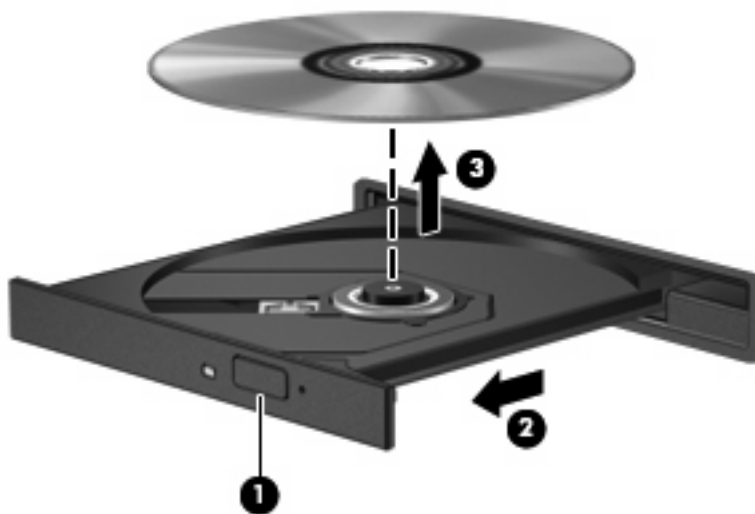

3. Close the disc tray and place the disc in a protective case.

Gucci 1.0 Vista User Guide 537596-001--Final Review

Webcam

Your computer model includes an integrated webcam, located at the top of the display. The webcam can be used with a variety of software for the following functions:

- Capturing video
- Streaming video with instant message software
- Taking still photos

 **NOTE:** For information about using software designed for use with the integrated webcam, refer to the online Help for that software.

For optimum performance, observe the following guidelines while using the integrated webcam:

- Be sure that you have the latest version of an instant message program before attempting a video conversation.
- The webcam may not work properly across some network firewalls.

 **NOTE:** If you are having trouble viewing or sending multimedia files to someone on another LAN or outside your network firewall, temporarily disable the firewall, perform the task you want to perform, and then reenables the firewall. To permanently resolve the problem, reconfigure the firewall as necessary, and adjust the policies and settings of other intrusion detection systems. For additional information, contact your network administrator or IT department.

- Whenever possible, place bright light sources behind the webcam and out of the picture area.

Adjusting webcam properties

You can adjust webcam properties using the Properties dialog box, which is accessible from various programs that use the integrated webcam, usually from a configuration, settings, or properties menu:

- **Brightness**—Controls the amount of light that is incorporated into the image. A higher brightness setting creates a brighter image; a lower brightness setting creates a darker image.
- **Contrast**—Controls the difference between lighter and darker areas on the image. A higher contrast setting intensifies the image; a lower contrast setting maintains more of the original information's dynamic range but leads to a flatter image.
- **Hue**—Controls the aspect of color that distinguishes it from another color (what makes a color red, green, or blue). Hue is distinct from saturation, which measures the intensity of the hue.
- **Saturation**—Controls the strength of color in the final image. A higher saturation setting creates a bolder image; a lower saturation setting creates a more subtle image.
- **Sharpness**—Controls the definition of edges in an image. A higher sharpness setting creates a more defined image; a lower sharpness setting creates a softer image.
- **Gamma**—Controls the contrast affecting the mid-level grays or midtones of an image. Adjusting the gamma of an image allows you to change the brightness values of the middle range of gray tones without dramatically altering the shadows and highlights. A lower gamma setting makes grays look black, and makes dark colors even darker.

For information about using the webcam, select **Start > Help and Support**.

5 Security

Protecting the computer

 **NOTE:** Security solutions are designed to act as deterrents. These deterrents may not prevent a product from being mishandled or stolen.

NOTE: In some countries or regions, the computer supports CompuTrace, which is an online-security-based tracking and recovery service. If the computer is stolen, CompuTrace can track the computer if the unauthorized user accesses the Internet. You must purchase the software and subscribe to the service in order to use CompuTrace. For information about ordering the CompuTrace software, see the HP Web site at <http://www.hpshopping.com>.

Security features provided with your computer can protect the computer, personal information, and data from a variety of risks. The way you use your computer will determine which security features you need to use.

The Windows operating system offers certain security features. Additional security features are listed in the following table. Most of these additional security features can be configured in the Computer Setup utility.

To protect against	Use this security feature
Unauthorized use of the computer	Power-on authentication using passwords or smart cards
Unauthorized access to Computer Setup (f10)	Setup password in Computer Setup*
Unauthorized access to the contents of a hard drive	DriveLock password in Computer Setup*
Unauthorized reset of Computer Setup (f10) passwords	Stringent security feature in Computer Setup*
Unauthorized startup from an optical drive, diskette drive, or internal network adapter	Boot options feature in Computer Setup*
Unauthorized access to data	<ul style="list-style-type: none">• Firewall software• Windows updates
Unauthorized access to Computer Setup settings and other system identification information	Setup password in Computer Setup*
Unauthorized removal of the computer	Security cable slot (used with an optional security cable)

*Computer Setup is a non-Windows utility accessed by pressing **f10** when the computer is turned on or restarted. When using Computer Setup, you must use the keys on your computer to navigate and make selections.

Gucci 1.0 Vista User Guide 537596-001--Final Review

Using passwords

A password is a group of characters that you choose to secure your computer information. Several types of passwords can be set, depending on how you want to control access to your information. Passwords can be set in Windows or in the non-Windows Computer Setup utility that is preinstalled on the computer.

△ **CAUTION:** To prevent being locked out of the computer, record each password you set. Because most passwords are not displayed as they are set, changed, or deleted, it is essential to record each password immediately and store it in a secure place.

You can use the same password for a Computer Setup feature and for a Windows security feature. You can also use the same password for more than one Computer Setup feature.

Use the following guidelines when setting a password in Computer Setup:

- A password can be any combination of up to 8 letters and numbers and is case sensitive.
- A password set in Computer Setup must be entered at a Computer Setup prompt. A password set in Windows must be entered at a Windows prompt.

Use the following tips for creating and saving passwords:

- When creating passwords, follow requirements set by the program.
- Write down your passwords and store them in a secure place away from the computer.
- Do not store passwords in a file on the computer.
- Do not use your name or other personal information that could be easily discovered by an outsider.

The following sections list Windows and Computer Setup passwords and describe their functions. For additional information about Windows passwords, such as screen-saver passwords, select **Start > Help and Support**.

Setting passwords in Windows

Windows passwords	Function
Administrator password*	Protects access to a Windows administrator-level account.
User password*	Protects access to a Windows user account.

*For information about setting a Windows administrator password or a Windows user password, select **Start > Help and Support**.

Setting passwords in Computer Setup

Computer Setup passwords	Function
Setup password	Protects access to Computer Setup.
Power-on password	Protects access to the computer contents when the computer turns on, restarts, or exits Hibernation.

Gucci 1.0 Vista User Guide 537596-001--Final Review

Computer Setup passwords	Function
DriveLock master password	Protects access to the internal hard drive that is protected by DriveLock. It is also used to remove DriveLock protection. This password is set under DriveLock Passwords during the enable process.
DriveLock user password	Protects access to the internal hard drive that is protected by DriveLock, and is set under DriveLock Passwords during the enable process.

Setup password

The Computer Setup setup password protects the configuration settings and system identification information in Computer Setup. After this password is set, it must be entered to access Computer Setup and to make changes using Computer Setup.

Note the following characteristics of the setup password:

- It is not interchangeable with a Windows administrator password, although both passwords can be identical.
- It is not displayed as it is set, entered, changed, or deleted.
- It must be set and entered with the same keys. For example, a setup password set with keyboard number keys will not be recognized if you enter it thereafter with embedded numeric keypad number keys.
- It can include any combination of up to 32 letters and numbers and is not case sensitive.

Gucci 1.0 Vista User Guide 537596-001--Final Review

Managing a setup password

A setup password is set, changed, and deleted in Computer Setup.

To manage, set, change, or delete this password, follow these steps:

1. Open Computer Setup by turning on or restarting the computer, and then pressing **f10** while the “F10 = ROM Based Setup” message is displayed in the lower-left corner of the screen.
2. Use the arrow keys to select **Security > Setup Password**, and then press **enter**.
 - To set a setup password, type your password in the **New password** and **Verify new password** fields, and then press **f10**.
 - To change a setup password, type your current password in the **Old password** field, type a new password in the **New password** and **Verify new password** fields, and then press **f10**.
 - To delete a setup password, type your current password in the **Old password** field, and then press **f10**.
3. To save your preferences, use the arrow keys to select **File > Save changes and exit**. Then follow the instructions on the screen.

Your preferences go into effect when the computer restarts.

Gucci 1.0 Vista User Guide 537596-001--Final Review

Entering a setup password

At the **Setup password** prompt, type your setup password (using the same kind of keys you used to set the password), and then press **enter**. After 3 unsuccessful attempts to enter the setup password, you must restart the computer and try again.

Power-on password

The Computer Setup power-on password prevents unauthorized use of the computer. After this password is set, it must be entered each time the computer is turned on.

Note the following characteristics of a power-on password:

- It is not displayed as it is set, entered, changed, or deleted.
- It must be set and entered with the same keys. For example, a power-on password set with keyboard number keys will not be recognized if you enter it thereafter with embedded numeric keypad number keys.
- It can include any combination of up to 32 letters and numbers and is not case sensitive.

Gucci 1.0 Vista User Guide 537596-001--Final Review

Managing a power-on password

A power-on password is set, changed, and deleted in Computer Setup.

To manage, set, change, or delete this password, follow these steps:

1. Open Computer Setup by turning on or restarting the computer, and then pressing **f10** while the “F10 = ROM Based Setup” message is displayed in the lower-left corner of the screen.
2. Use the arrow keys to select **Security > Power-On password**, and then press **enter**.
 - To set a power-on password, type the password in the **New password** and **Verify new password** fields, and then press **f10**.
 - To change a power-on password, type the current password in the **Old password** field, type the new password in the **New password** and **Verify new password** fields, and then press **f10**.
 - To delete a power-on password, type the current password in the **Old password** field, and then press **f10**.
3. To save your preferences, use the arrow keys to select **File > Save changes and exit**. Then follow the instructions on the screen.

Your preferences go into effect when the computer restarts.

Gucci 1.0 Vista User Guide 537596-001--Final Review

Entering a power-on password

At the **Power-on Password** prompt, type your password (using the same kind of keys you used to set the password), and then press **enter**. After 3 unsuccessful attempts to enter the password, you must turn off the computer, turn it back on, and then try again.

Gucci 1.0 Vista User Guide 537596-001--Final Review

Requiring a power-on password at restart

In addition to requiring that a power-on password be entered each time the computer is turned on, you can also require that a power-on password be entered each time the computer is restarted.

To enable and disable this feature in Computer Setup, follow these steps:

1. Open Computer Setup by turning on or restarting the computer, and then pressing **f10** while the “F10 = ROM Based Setup” message is displayed in the lower-left corner of the screen.
2. Use the arrow keys to select **Security > Password options**, and then press **enter**.
3. Use the arrow keys to select **Enable** or **Disable** in the **Require password on restart** field, and then press **f10**.
4. To save your preferences, use the arrow keys to select **File > Save changes and exit**. Then follow the instructions on the screen.

Using Computer Setup DriveLock

- △ **CAUTION:** To prevent the DriveLock-protected hard drive from becoming permanently unusable, record the DriveLock user password and the DriveLock master password in a safe place away from your computer. If you forget both DriveLock passwords, the hard drive will be permanently locked and can no longer be used.

DriveLock protection prevents unauthorized access to the contents of a hard drive. DriveLock can be applied only to the internal hard drive(s) of the computer. After DriveLock protection is applied to a drive, a password must be entered to access the drive. The drive must be inserted into the computer, not into an optional docking device or external MultiBay, in order for it to be accessed by the DriveLock passwords.

To apply DriveLock protection to an internal hard drive, a user password and a master password must be set in Computer Setup. Note the following considerations about using DriveLock protection:

- After DriveLock protection is applied to a hard drive, the hard drive can be accessed only by entering either the user password or the master password.
- The owner of the user password should be the day-to-day user of the protected hard drive. The owner of the master password may be either a system administrator or the day-to-day user.
- The user password and the master password can be identical.
- You can delete a user password or master password only by removing DriveLock protection from the drive. DriveLock protection can be removed from the drive only with the master password.

- 📄 **NOTE:** When your power-on password and DriveLock user password are identical, you will be prompted to enter only a power-on password instead of both a power-on password and a DriveLock user password.

Gucci 1.0 Vista User Guide 537596-001--Final Review

Setting a DriveLock password

To access the DriveLock settings in Computer Setup, follow these steps:

1. Open Computer Setup by turning on or restarting the computer, and then pressing **f10** while the "F10 = ROM Based Setup" message is displayed in the lower-left corner of the screen.
2. Use the arrow keys to select **Security > DriveLock passwords**, and then press **enter**.
3. Select the location of the hard drive you want to protect, and then press **f10**.
4. Use the arrow keys to select **Enable** in the **Protection** field, and then press **f10**.
5. Read the warning. To continue, press **f10**.
6. Type your user password in the **New password** and **Verify new password** fields, and then press **f10**.
7. Type your master password in the **New password** and **Verify new password** fields, and then press **f10**.
8. To confirm DriveLock protection on the drive you have selected, type **DriveLock** in the confirmation field, and then press **f10**.
9. To exit DriveLock settings, use the arrow keys to select **Esc**.
10. To save your preferences, use the arrow keys to select **File > Save changes and exit**. Then follow the instructions on the screen.

Your preferences go into effect when the computer restarts.

Gucci 1.0 Vista User Guide 537596-001--Final Review

Entering a DriveLock password

Be sure that the hard drive is inserted into the computer (not into an optional docking device or external MultiBay).

At the **DriveLock Password** prompt, type your user or master password (using the same kind of keys you used to set the password), and then press [enter](#).

After 2 incorrect attempts to enter the password, you must shut down the computer and try again.

Gucci 1.0 Vista User Guide 537596-001--Final Review

Changing a DriveLock password

To access the DriveLock settings in Computer Setup, follow these steps:

1. Open Computer Setup by turning on or restarting the computer, and then pressing **f10** while the “F10 = ROM Based Setup” message is displayed in the lower-left corner of the screen.
2. Use the arrow keys to select **Security > DriveLock passwords**, and then press **enter**.
3. Use the arrow keys to select the location of the internal hard drive, and then press **f10**.
4. Use the arrow keys to select the field for the password you want to change. Type your current password in the **Old password** field, and then type the new password in the **New password** field and in the **Verify new password** field. Then press **f10**.
5. To save your preferences, use the arrow keys to select **File > Save changes and exit**. Then follow the instructions on the screen.

Your preferences go into effect when the computer restarts.

Gucci 1.0 Vista User Guide 537596-001--Final Review

Removing DriveLock protection

To access the DriveLock settings in Computer Setup, follow these steps:

1. Open Computer Setup by turning on or restarting the computer, and then pressing **f10** while the “F10 = ROM Based Setup” message is displayed in the lower-left corner of the screen.
2. Use the arrow keys to select **Security > DriveLock passwords**, and then press **enter**.
3. Use the arrow keys to select the location of the internal hard drive, and then press **f10**.
4. Use the arrow keys to select **Disable** in the **Protection** field, and then press **f10**.
5. Type your master password in the **Old password** field. Then press **f10**.
6. To save your preferences, use the arrow keys to select **File > Save changes and exit**. Then follow the instructions on the screen.

Your preferences go into effect when the computer restarts.

Gucci 1.0 Vista User Guide 537596-001--Final Review

Using Computer Setup security features

Securing system devices

From the Boot options menu or the Port options menu in Computer Setup, you can disable or enable system devices.

To disable or reenable system devices in Computer Setup, follow these steps:

1. Open Computer Setup by turning on or restarting the computer, and then pressing **f10** while the "F10 = ROM Based Setup" message is displayed in the lower-left corner of the screen.
2. Use the arrow keys to select **System Configuration > Boot options** or **System Configuration > Port options**. Then press **enter** and use the arrow keys to select the options you want.
3. To confirm your preferences, press **f10**.
4. To save your preferences, use the arrow keys to select **File > Save changes and exit**. Then follow the instructions on the screen.

Your preferences go into effect when the computer restarts.

Using Computer Setup stringent security

- △ **CAUTION:** To prevent the computer from becoming permanently unusable, record your configured setup password, power-on password, or smart card PIN in a safe place away from your computer. Without these passwords or PIN, the computer cannot be unlocked.

The stringent security feature enhances power-on security by forcing user authentication with your configured setup password, power-on password, or smart card PIN before granting access to the system.

Gucci 1.0 Vista User Guide 537596-001--Final Review

Setting stringent security

To enable stringent security in Computer Setup, follow these steps:

1. Open Computer Setup by turning on or restarting the computer, and then pressing **f10** while the “F10 = ROM Based Setup” message is displayed in the lower-left corner of the screen.
2. Use the arrow keys to select **Security > Password options**, and then press **enter**.
3. Use the arrow keys to select **Enable** in the **Stringent security** field.
4. Read the warning. To continue, press **f10**.
5. To enable the feature each time the computer is turned on, press **f10**.
6. To save your preferences, use the arrow keys to select **File > Save changes and exit**. Then follow the instructions on the screen.

Your preferences go into effect when the computer restarts.

Gucci 1.0 Vista User Guide 537596-001--Final Review

Removing stringent security

To remove stringent security in Computer Setup, follow these steps:

1. Open Computer Setup by turning on or restarting the computer, and then pressing **f10** while the “F10 = ROM Based Setup” message is displayed in the lower-left corner of the screen.
2. Use the arrow keys to select **Security > Password options** and then press **enter**.
3. Use the arrow keys to select **Disable** in the **Stringent security** field, and then press **f10**.
4. To save your preferences, use the arrow keys to select **File > Save changes and exit**. Then follow the instructions on the screen.

Your preferences go into effect when the computer restarts.

Viewing Computer Setup System Information

The System Information feature in Computer Setup provides 2 types of system information:

- Identification information about the computer model.
- Specification information for the processor, cache and memory size, and system ROM.

To view this general system information, follow these steps:

1. Open Computer Setup by turning on or restarting the computer, and then pressing **f10** while the “F10 = ROM Based Setup” message is displayed in the lower-left corner of the screen.
2. Use the arrow keys to select **File > System Information**, and then press **enter**.

 **NOTE:** To prevent unauthorized access to this information, you must create a setup password in Computer Setup.

Gucci 1.0 Vista User Guide 537596-001--Final Review

Using antivirus software

When you use the computer to access e-mail, a network, or the Internet, you expose the computer to computer viruses. Computer viruses can disable the operating system, applications, or utilities, or cause them to function abnormally.

Antivirus software can detect most viruses, destroy them, and in most cases, repair any damage they have caused. To provide ongoing protection against newly discovered viruses, antivirus software must be updated.

Norton Internet Security is preinstalled on the computer. For information about using the Norton Internet Security software, select **Start > All Programs > Norton Internet Security > Help and Support**.

For more information about computer viruses, type `viruses` in the Search box in Help and Support.

Gucci 1.0 Vista User Guide 537596-001--Final Review

Using firewall software

When you use the computer to access e-mail, a network, or the Internet, unauthorized persons may be able to gain access to information about you, the computer, and your personal files. Use the firewall software preinstalled on the computer to protect your privacy.

Firewall features include information on logging and reporting, and automatic alarms to monitor all incoming and outgoing traffic. Refer to the firewall documentation or contact your firewall manufacturer for more information.

 **NOTE:** Under some circumstances a firewall can block access to Internet games, interfere with printer or file sharing on a network, or block authorized e-mail attachments. To temporarily solve the problem, disable the firewall, perform the task that you want to perform, and then reenable the firewall. To permanently resolve the problem, reconfigure the firewall.

Installing critical updates

△ **CAUTION:** To protect the computer from security breaches and computer viruses, install the online critical updates from Microsoft as soon as you receive an alert.

Updates to the operating system and other software may have become available *after* the computer was shipped. To be sure that all available updates are installed on the computer, observe these guidelines:

- Run Windows Update monthly to install the latest software from Microsoft.
- Obtain updates, as they are released, from the Microsoft Web site and through the updates link in Help and Support.

Gucci 1.0 Vista User Guide 537596-001--Final Review

Installing a security cable

 **NOTE:** The security cable is designed to act as a deterrent, but it may not prevent the computer from being mishandled or stolen.

1. Loop the security cable around a secured object.
2. Insert the key (1) into the cable lock (2).
3. Insert the cable lock into the security cable slot on the computer (3), and then lock the cable lock with the key.

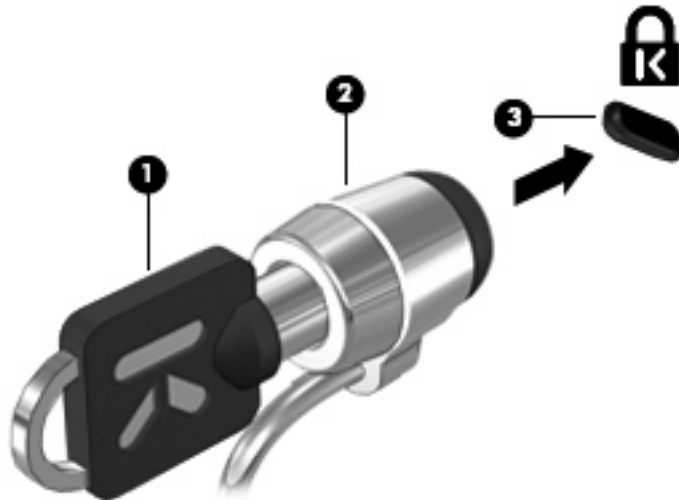

6 External devices

Using a USB device

Universal Serial Bus (USB) is a hardware interface that can be used to connect an optional external device, such as a USB keyboard, mouse, drive, printer, scanner, or hub.

Some USB devices may require additional support software, which is usually included with the device. For more information about device-specific software, refer to the manufacturer's instructions.

Your computer model has 2 USB ports, which support USB 1.0, USB 1.1, and USB 2.0 devices. A USB hub provides additional USB ports that can be used with the computer.

Connecting a USB device

△ **CAUTION:** To prevent damage to a USB connector, use minimal force to connect a USB device.

- To connect a USB device to the computer, connect the USB cable for the device to the USB port.



You will hear a sound when the device has been detected.

📄 **NOTE:** The first time you connect a USB device, a message is displayed in the notification area to let you know the device is recognized by the computer.

Stopping and removing a USB device

△ **CAUTION:** To prevent loss of information or an unresponsive system, stop a USB device before removing it.

Gucci 1.0 Vista User Guide 537596-001--Final Review

CAUTION: To prevent damage to a USB connector, do not pull on the cable to remove the USB device.

To stop and remove a USB device:

1. Double-click the **Safely Remove Hardware** icon in the notification area, at the far right of the taskbar.

 **NOTE:** To display the Safely Remove Hardware icon, click the **Show Hidden Icons** icon (< or <<) in the notification area.

2. Click the name of the device in the list.

 **NOTE:** If the USB device is not listed, you do not have to stop the device before you remove it.

3. Click **Stop**, and then click **OK**.

4. Remove the device.

Using USB legacy support

USB legacy support (enabled by default) permits the following actions:

- Using a USB keyboard, mouse, or hub connected to a USB port on the computer during startup or in an MS-DOS-based program or utility
- Starting or restarting from an optional external MultiBay or an optional USB bootable device

USB legacy support is enabled at the factory. To disable or enable USB legacy support:

1. Open Computer Setup by turning on or restarting the computer, and then pressing **f10** while the “F10 = ROM Based Setup” message is displayed in the lower-left corner of the screen.
2. Use the arrow keys to select **System Configuration > Device configurations**, and then press **enter**.
3. Use the arrow keys to enable or disable USB legacy support, and then press **f10**.
4. To save your preferences and exit Computer Setup, use the arrow keys to select **File > Save changes and exit**. Then follow the instructions on the screen.

Your preferences go into effect when the computer restarts.

Gucci 1.0 Vista User Guide 537596-001--Final Review

Using external drives

Removable external drives expand your options for storing and accessing information. A USB drive can be added by connecting the drive to a USB port on the computer.

 **NOTE:** HP external USB optical drives should be connected to the powered USB port on the left side of the computer.

USB drives include the following types:

- 1.44-megabyte diskette drive
- Hard drive module (a hard drive with an adapter attached)
- DVD-ROM Drive
- DVD/CD-RW Combo Drive
- DVD±RW/CD-RW Combo Drive
- MultiBay device

Using optional external devices

 **NOTE:** For more information about required software and drivers, or to learn which computer port to use, refer to the manufacturer's instructions.

To connect an external device to the computer:

 **CAUTION:** To reduce the risk of damage to the equipment when connecting a powered device, be sure that the device is turned off and the AC power cord is unplugged.

1. Connect the device to the computer.
2. If you are connecting a powered device, plug the device power cord into a grounded AC outlet.
3. Turn on the device.

To disconnect an unpowered external device, turn off the device, and then disconnect it from the computer. To disconnect a powered external device, turn off the device, disconnect it from the computer, and then unplug the AC power cord.

Using an optional external MultiBay II

An external MultiBay II connects to a USB port on the computer and enables you to use MultiBay II devices. The computer provides one powered USB port on the left side of the computer. This port provides power to the external MultiBay when used with a powered USB cable. An external MultiBay connected to the other USB port on the computer must be connected to AC power.

For more information about the external MultiBay II, refer to the user guide that is included with the device.

Gucci 1.0 Vista User Guide 537596-001--Final Review

Using an optional external optical drive (select models only)

An external optical drive connects to a USB port on the computer and enables you to use optical discs (CDs and DVDs). The computer provides one powered USB port on the left side of the computer. This port provides power to the external optical drive when used with a powered USB cable. An external optical drive connected to the other USB port on the computer must be connected to AC power.

An external optical drive, such as a DVD-ROM drive, supports optical discs (CDs and DVDs). These discs store or transport information and play music and movies. DVDs have a higher storage capacity than CDs.

All optical drives can read from optical discs and some drives can also write to optical discs as described in the following table.

Optical drive type	Read from CD and DVD-ROM media	Write to CD-R/RW media	Write to DVD (includes DVD+R DL, DVD±RW/R, and DVD-RAM media)	Write label to LightScribe CD or DVD
DVD-ROM Drive	Yes	No	No	No
DVD/CD-RW Combo Drive	Yes	Yes	No	No
DVD±RW/CD-RW Combo Drive	Yes	Yes	Yes	No

NOTE: Some of the optical drives listed may not be supported by your computer. The listed drives are not necessarily all of the supported optical drives.

△ **CAUTION:** To prevent possible audio and video degradation, or loss of audio or video playback functionality, do not initiate Sleep or Hibernation while reading from or writing to a CD or DVD.

To prevent loss of information, do not initiate Sleep or Hibernation when writing to a CD or DVD.

If Sleep or Hibernation is initiated during playback of a disc, you may experience the following behaviors:

- Your playback may be interrupted.
- You may see a warning message asking if you want to continue. If this message is displayed, click **No**.
- You may need to restart the CD or DVD to resume audio and video playback.

Inserting an optical disc (CD or DVD)

1. Turn on the computer.
2. Press the release button (1) on the drive bezel to release the disc tray.
3. Pull out the tray (2).
4. Hold the disc by the edges to avoid touching the flat surfaces and position the disc label-side up over the tray spindle.

 **NOTE:** If the tray is not fully accessible, tilt the disc carefully to position it over the spindle.

Gucci 1.0 Vista User Guide 537596-001--Final Review

5. Gently press the disc (3) down onto the tray spindle until the disc snaps into place.



6. Close the disc tray.

Removing an optical disc (CD or DVD)

There are 2 ways to remove a disc, depending on whether the disc tray opens normally or not.

When the disc tray opens

1. Press the release button (1) on the drive bezel to release the disc tray, and then gently pull out the tray (2) until it stops.
2. Remove the disc (3) from the tray by gently pressing down on the spindle while lifting the outer edges of the disc. Hold the disc by the edges and avoid touching the flat surfaces.

 **NOTE:** If the tray is not fully accessible, tilt the disc carefully as you remove it.



3. Close the disc tray and place the disc in a protective case.

Gucci 1.0 Vista User Guide 537596-001--Final Review

When the disc tray does not open

1. Insert the end of a paper clip (1) into the release access in the front bezel of the drive.
2. Press in gently on the paper clip until the tray is released, and then pull out the tray (2) until it stops.
3. Remove the disc (3) from the tray by gently pressing down on the spindle while lifting the outer edges of the disc. Hold the disc by the edges and avoid touching the flat surfaces.

 **NOTE:** If the tray is not fully accessible, tilt the disc carefully as you remove it.

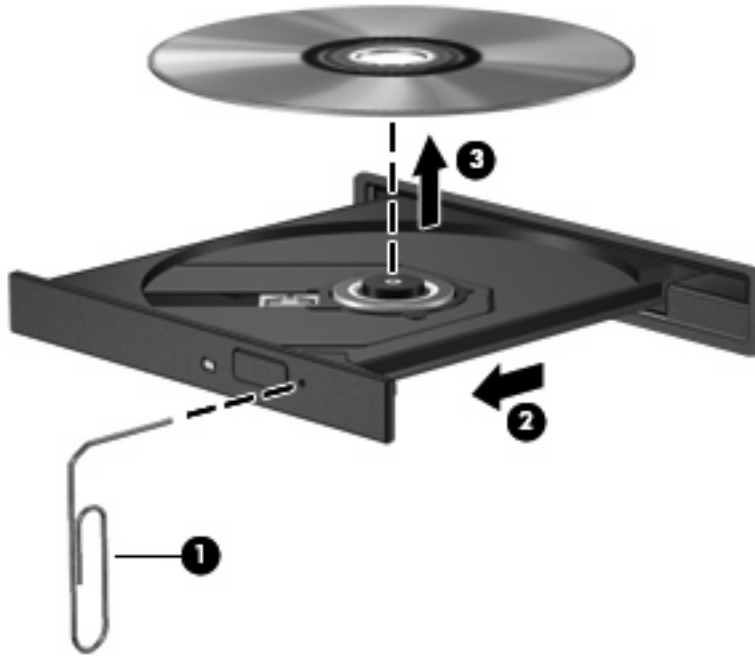

4. Close the disc tray and place the disc in a protective case.

7 External media cards

Using SD Card Reader cards

Optional digital cards provide secure data storage and convenient data sharing. These cards are often used with digital media–equipped cameras and PDAs as well as with other computers.

The SD Card Reader supports the following formats:

- MultiMediaCard (MMC)
- Secure Digital (SD) Memory Card

Inserting a digital card

△ **CAUTION:** To avoid damaging the digital card or the computer, do not insert any type of adapter into the SD Card Reader.

CAUTION: To prevent damage to the digital card connectors, use minimal force to insert a digital card.

1. Hold the digital card label-side up, with the connectors facing the computer.
2. Insert the card into the SD Card Reader, and then push in on the card until it is firmly seated.

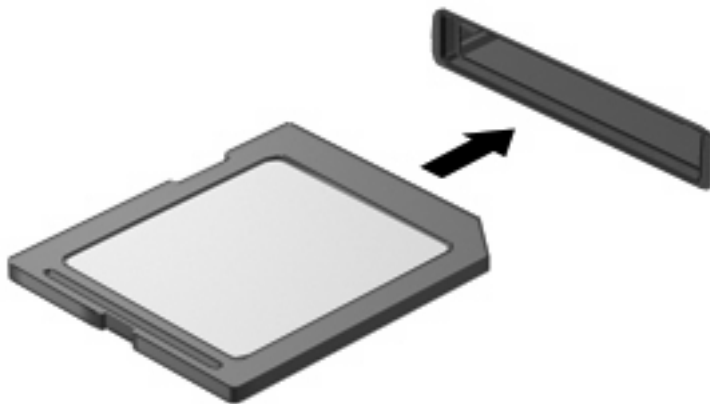

You will hear a sound when the device has been detected, and a menu of available options may be displayed.

Gucci 1.0 Vista User Guide 537596-001--Final Review

Stopping and removing a digital card

△ **CAUTION:** To prevent loss of data or an unresponsive system, stop a digital card before removing it.

1. Save your information and close all programs associated with the digital card.

📄 **NOTE:** To stop a data transfer, click **Cancel** in the operating system Copying window.

2. Stop the digital card:

- a. Double-click the **Safely Remove Hardware** icon in the notification area, at the far right of the taskbar.

📄 **NOTE:** To display the Safely Remove Hardware icon, click the **Show Hidden Icons** icon (< or <<) in the notification area.

- b. Click the name of the digital card in the list.

- c. Click **Stop**, and then click **OK**.

3. Press in on the digital card (1), and then remove the card from the slot (2).

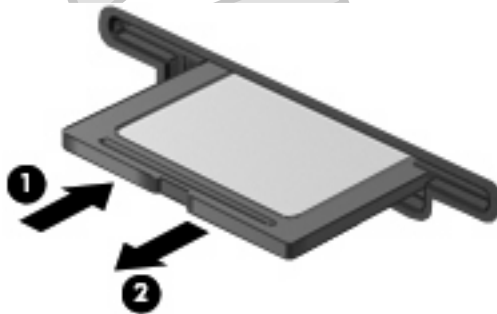

8 Pointing devices and keyboard

Using pointing devices

Setting pointing device preferences

Use Mouse Properties in Windows® to customize settings for pointing devices, such as button configuration, click speed, and pointer options.

To access Mouse Properties, select **Start > Control Panel > Hardware and Sound > Mouse**.

Using the TouchPad

To move the pointer, slide your finger across the TouchPad surface in the direction you want the pointer to go. Use the TouchPad buttons like the corresponding buttons on an external mouse. To scroll up and down using the TouchPad vertical scroll zone, slide your finger up or down over the lines.

 **NOTE:** If you are using the TouchPad to move the pointer, you must lift your finger off the TouchPad before moving it to the scroll zone. Simply sliding your finger from the TouchPad to the scroll zone will not activate the scrolling function.

Connecting an external mouse

You can connect an external USB mouse to the computer using one of the USB ports on the computer. A USB mouse can also be connected to the system using the ports on an optional docking device or expansion product.

Using the keyboard

Using hotkeys

Hotkeys are combinations of the **fn** key (1) and either the **esc** key (2) or one of the function keys (3).

The icons on the **f1** through **f4** and **f6**, **f8**, **f10**, and **f11** keys represent the hotkey functions. Hotkey functions and procedures are discussed in the following sections.

Gucci 1.0 Vista User Guide 537596-001--Final Review

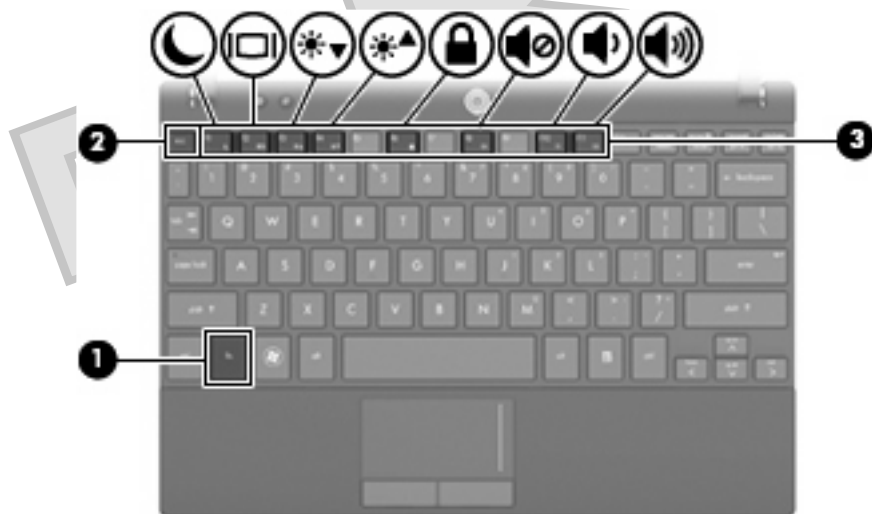

Function	Hotkey
Display system information.	fn+esc
Initiate Sleep.	fn+f1
Alternate between computer display and external display.	fn+f2
Decrease screen brightness.	fn+f3
Increase screen brightness.	fn+f4
Initiate QuickLock.	fn+f6
Mute or restore computer sound.	fn+f8
Decrease computer sound.	fn+f10
Increase computer sound.	fn+f11

To use a hotkey command on the computer keyboard, follow either of these steps:

- Briefly press the [fn](#) key, and then briefly press the second key of the hotkey command.
– or –
- Press and hold down the [fn](#) key, briefly press the second key of the hotkey command, and then release both keys at the same time.

Displaying system information ([fn+esc](#))

Press [fn+esc](#) to display information about system hardware components and the system BIOS version number.

In the Windows [fn+esc](#) display, the version of the system BIOS (basic input-output system) is displayed as the BIOS date. On some computer models, the BIOS date is displayed in decimal format. The BIOS date is sometimes called the system ROM version number.

Initiating Sleep ([fn+f1](#))

△ **CAUTION:** To reduce the risk of information loss, save your work before initiating Sleep.

Gucci 1.0 Vista User Guide 537596-001--Final Review

Press **fn+f1** to initiate Sleep.

When Sleep is initiated, your information is stored in system memory, the screen is cleared, and power is conserved. While the computer is in the Sleep state, the power lights blink.

The computer must be on before you can initiate Sleep.

 **NOTE:** If a critical battery level occurs while the computer is in the Sleep state, the computer initiates Hibernation and the information stored in memory is saved to the hard drive. The factory setting for critical battery action is Hibernate, but this setting can be changed using Power Options in Windows Control Panel.

To exit Sleep, briefly slide the power switch or press any key on the keyboard.

The function of the **fn+f1** hotkey can be changed. For example, you can set the **fn+f1** hotkey to initiate Hibernation instead of Sleep.

 **NOTE:** In all Windows operating system windows, references to the *sleep button* apply to the **fn+f1** hotkey.

Gucci 1.0 Vista User Guide 537596-001--Final Review

Switching the screen image (fn+f2)

Press **fn+f2** to switch the screen image among display devices connected to the system. For example, if a monitor is connected to the computer, pressing **fn+f2** alternates the screen image from computer display to monitor display to simultaneous display on both the computer and the monitor.

Most external monitors receive video information from the computer using the external VGA video standard. The **fn+f2** hotkey can also alternate images among other devices receiving video information from the computer.

The following video transmission types, with examples of devices that use them, are supported by the **fn+f2** hotkey:

- LCD (computer display)
- External VGA (most external monitors)
- S-Video (televisions, camcorders, DVD players, VCRs, and video capture cards with S-Video-in jacks)
- HDMI (televisions, camcorders, DVD players, VCRs, and video capture cards with HDMI ports)
- Composite video (televisions, camcorders, DVD players, VCRs, and video capture cards with composite-video-in jacks)

 **NOTE:** Composite devices and S-Video devices can be connected to the system only by using an optional docking device.

Decreasing screen brightness (fn+f3)

Press **fn+f3** to decrease screen brightness. Hold down the hotkey to decrease the brightness level incrementally.

Increasing screen brightness (fn+f4)

Press **fn+f4** to increase screen brightness. Hold down the hotkey to increase the brightness level incrementally.

Initiating QuickLock (fn+f6)

Press **fn+f6** to initiate the QuickLock security feature.

QuickLock protects your information by displaying the operating system Log On window. While the Log On window is displayed, the computer cannot be accessed until a Windows user password or a Windows administrator password is entered.

 **NOTE:** Before you can use QuickLock, you must set a Windows user password or a Windows administrator password. For instructions, refer to Help and Support.

To use QuickLock, press **fn+f6** to display the Log On window and lock the computer. Then follow the instructions on the screen to enter your Windows user password or your Windows administrator password and access the computer.

Muting speaker sound (fn+f8)

Press **fn+f8** to mute speaker sound. Press the hotkey again to restore speaker sound.

Gucci 1.0 Vista User Guide 537596-001--Final Review

Decreasing speaker sound (fn+f10)

Press **fn+f10** to decrease speaker sound. Hold down the hotkey to decrease speaker sound incrementally.

Increasing speaker sound (fn+f11)

Press **fn+f11** to increase speaker sound. Hold down the hotkey to increase speaker sound incrementally.

Using keypads

The computer has an embedded numeric keypad and also supports an optional external numeric keypad or an optional external keyboard that includes a numeric keypad.

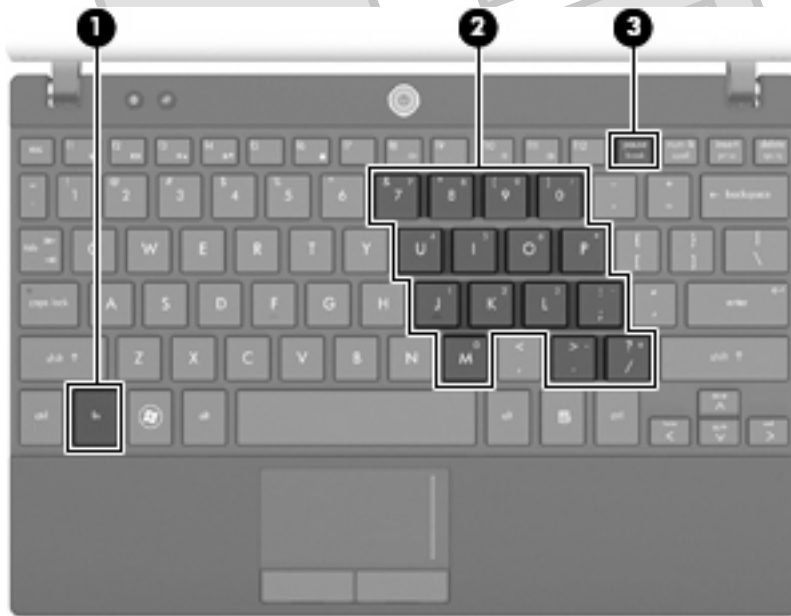

Component	Description
(1) fn key	Alternates the functions of the keys on the embedded numeric keypad when pressed in combination with a keypad key or the shift key.
(2) Embedded numeric keypad	Can be used like the keys on an external numeric keypad.
(3) num lk key	Enables the embedded numeric keypad.

Using the embedded numeric keypad

The 15 keys of the embedded numeric keypad can be used like the keys on an external keypad. When the embedded numeric keypad is turned on, each key on the keypad performs the function indicated by the icon in the upper-right corner of the key.

Enabling and disabling the embedded numeric keypad

Press **fn+num lk** to enable the embedded numeric keypad. Press **fn+num lk** again to return the keys to their standard keyboard functions.

Cleaning the TouchPad and keyboard

Dirt and grease on the TouchPad can cause the pointer to jump around on the screen. To avoid this, clean the TouchPad with a damp cloth, and wash your hands frequently when using the computer.

- ⚠ **WARNING!** To reduce the risk of electric shock or damage to internal components, do not use a vacuum cleaner attachment to clean the keyboard. A vacuum cleaner can deposit household debris on the keyboard surface.

Clean the keyboard regularly to prevent keys from sticking and to remove dust, lint, and particles that can become trapped beneath the keys. A can of compressed air with a straw extension can be used to blow air around and under the keys to loosen and remove debris.



9 Drives

Identifying installed drives

To view the drives installed on the computer, select **Start > Computer**.

On models with a secondary hard drive (drive D), the optical drive becomes drive E. The next drive added to the system, such as a new USB drive, will be assigned the next available drive letter.

 **NOTE:** Windows includes the User Account Control feature to improve the security of your computer. You may be prompted for your permission or password for tasks such as installing applications, running utilities, or changing Windows settings. Refer to Help and Support for more information.

Handling drives

Drives are fragile computer components that must be handled with care. Refer to the following cautions before handling drives. Additional cautions are included with the procedures to which they apply.

Gucci 1.0 Vista User Guide 537596-001--Final Review

△ **CAUTION:** To reduce the risk of damage to the computer, damage to a drive, or loss of information, observe these precautions:

Before you move a computer that is connected to an external hard drive, initiate Sleep and allow the screen to clear, or properly disconnect the external hard drive.

Before handling a drive, discharge static electricity by touching the unpainted metal surface of the drive.

Do not touch the connector pins on a removable drive or on the computer.

Handle a drive carefully; do not drop a drive or place items on it.

Before removing or inserting a drive, shut down the computer. If you are unsure whether the computer is off, in the Sleep state, or in Hibernation, turn the computer on and then shut it down through the operating system.

Do not use excessive force when inserting a drive into a drive bay.

Do not type on the keyboard or move the computer while an optional optical drive is writing to a disc. The write process is sensitive to vibration.

When the battery is the only source of power, be sure that the battery is sufficiently charged before writing to media.

Avoid exposing a drive to temperature or humidity extremes.

Avoid exposing a drive to liquids. Do not spray the drive with cleaning products.

Remove media from a drive before removing the drive from the drive bay, or traveling with, shipping, or storing a drive.

If a drive must be mailed, place the drive in a bubble-pack mailer or other suitable protective packaging and label the package "FRAGILE."

Avoid exposing a drive to magnetic fields. Security devices with magnetic fields include airport walk-through devices and security wands. The airport security devices that check carry-on luggage, such as conveyor belts, use X-rays instead of magnetism and will not damage a drive.

Improving HD performance

Using Disk Defragmenter

As you use the computer, files on the hard drive become fragmented. Disk Defragmenter consolidates the fragmented files and folders on the hard drive so that the system can run more efficiently.

To run Disk Defragmenter:

1. Select **Start > All Programs > Accessories > System Tools > Disk Defragmenter**.
2. Click **Defragment now**.

 **NOTE:** Windows includes the User Account Control feature to improve the security of your computer. You may be prompted for your permission or password for tasks such as installing applications, running utilities, or changing Windows settings. Refer to Help and Support for more information.

For additional information, access the Disk Defragmenter software Help.

Using Disk Cleanup

Disk Cleanup searches the hard drive for unnecessary files that you can safely delete to free up disk space and help the computer to run more efficiently.

To run Disk Cleanup:

1. Select **Start > All Programs > Accessories > System Tools > Disk Cleanup**.
2. Follow the on-screen instructions.

Gucci 1.0 Vista User Guide 537596-001--Final Review

Using HP 3D DriveGuard (select models only)

HP 3D DriveGuard protects the hard drive by parking the drive and halting I/O requests under either of the following conditions:

- You drop the computer.
- You move the computer with the display closed while the computer is running on battery power.

A short time after the end of one of these events, HP 3D DriveGuard returns the hard drive to normal operation.

 **NOTE:** Hard drives that are in an optional docking device or are connected to a USB port are not protected by HP 3D DriveGuard.

For more information, refer to the HP 3D DriveGuard software Help.

Identifying HP 3D DriveGuard status

The drive light on the computer changes to an amber color to show that the drive is parked. To determine whether drives are currently protected or whether a drive is parked, use Mobility Center:

- If the software is enabled, a green check mark is superimposed over the hard drive icon.
- If the software is disabled, a red X is superimposed over the hard drive icon.
- If the drives are parked, a yellow moon is superimposed over the hard drive icon.

 **NOTE:** The icon in the Mobility Center may not show the most up-to-date status for the drive. For immediate updates after a change in status, you need to enable the notification area icon.

To enable the notification area icon:

1. Select **Start > Control Panel > Hardware and Sound > HP 3D DriveGuard**.
2. Next to **Icon in System Tray**, click **Show**.
3. Click **OK**.

If HP 3D DriveGuard has parked the drive, the computer will behave in the following ways:

- The computer will not shut down.
- The computer will not initiate Sleep or Hibernation, except as described in the following Note.

 **NOTE:** If the computer is running on battery power and reaches a critical battery level, HP 3D DriveGuard allows the computer to initiate Hibernation.

- The computer will not activate battery alarms set on the Alarms tab in Power Options properties.

Before you move the computer, HP recommends that you either shut it down or initiate Sleep or Hibernation.

Gucci 1.0 Vista User Guide 537596-001--Final Review

Using HP 3D DriveGuard software

The HP 3D DriveGuard software enables you to perform the following tasks:

- Enable and disable HP 3D DriveGuard.

 **NOTE:** Depending on your user privileges, you may not be able to enable or disable HP 3D DriveGuard. Additionally, members of an Administrator group can change the privileges for non-Administrator users.

- Determine whether a drive in the system is supported.

To open the software and change settings, follow these steps:

1. In Mobility Center, click the hard drive icon to open the HP 3D DriveGuard window.

– or –

Select **Start > Control Panel > Hardware and Sound > HP 3D DriveGuard**.

2. Click the appropriate button to change settings.
3. Click **OK**.

Replacing a hard drive

△ **CAUTION:** To prevent information loss or an unresponsive system:

Shut down the computer before removing the hard drive from the hard drive bay. Do not remove the hard drive while the computer is on, in the Sleep state, or in Hibernation.

If you are not sure whether the computer is off or in Hibernation, turn the computer on by briefly sliding the power switch. Then shut down the computer through the operating system.

To remove a hard drive:

1. Save your work.
2. Shut down the computer and close the display.
3. Disconnect all external hardware devices connected to the computer.
4. Unplug the power cord from the AC outlet.
5. Turn the computer upside down on a flat surface, with the battery bay toward you.
6. Remove the battery from the computer.
7. Remove the 3 screws from the back edge of the computer.

new image



8. Turn the computer display-side up, with the front toward you, and open the display.

Gucci 1.0 Vista User Guide 537596-001--Final Review

6. Replace the 3 screws on the back edge of the computer.



7. Replace the battery.

Gucci 1.0 Vista User Guide 537596-001--Final Review

9. Remove the existing memory module:

- a. Pull away the retention clips (1) on each side of the memory module.

The memory module tilts up.

△ **CAUTION:** To prevent damage to the memory module, hold the memory module by the edges only. Do not touch the components on the memory module.

- b. Grasp the edge of the memory module (2), and gently pull the module out of the memory module slot.

To protect a memory module after removal, place it in an electrostatic-safe container.

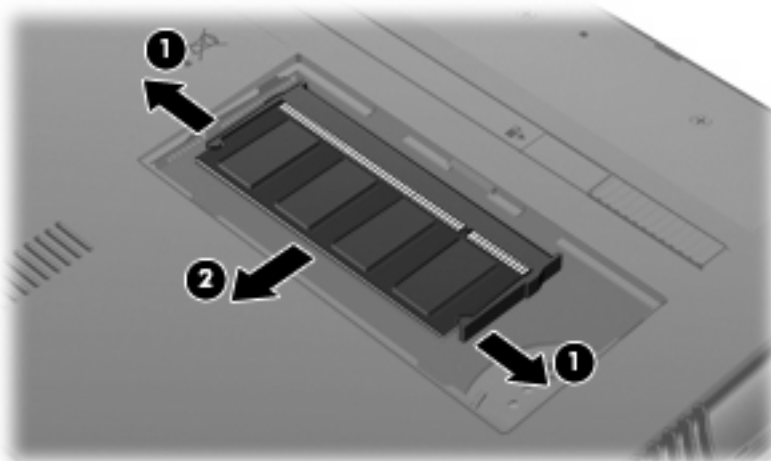

10. Insert a new memory module:

△ **CAUTION:** To prevent damage to the memory module, hold the memory module by the edges only. Do not touch the components on the memory module.

- a. Align the notched edge (1) of the memory module with the tab in the memory module slot.
- b. With the memory module at a 45-degree angle from the surface of the memory module compartment, press the module (2) into the memory module slot until it is seated.

△ **CAUTION:** To prevent damage to the memory module, do not bend the memory module.

Gucci 1.0 Vista User Guide 537596-001--Final Review

- c. Gently press the memory module (3) down, applying pressure to the left and right edges of the memory module, until the retention clips snap into place.

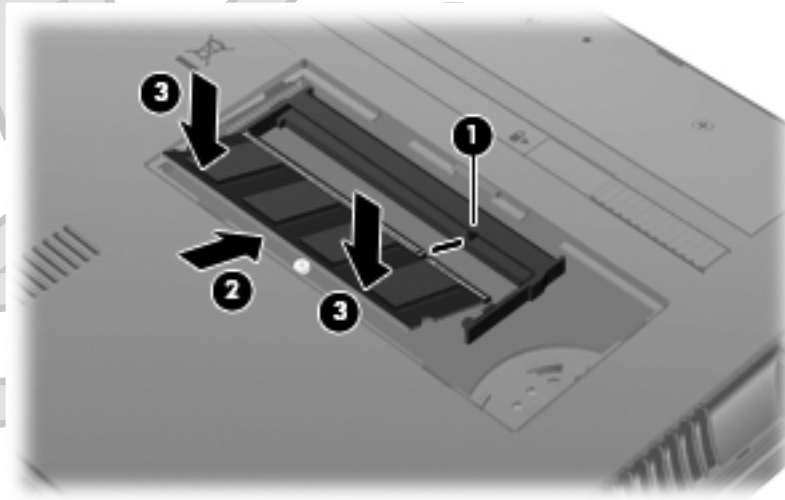

11. Align the tabs (1) on the memory module compartment cover with the notches on the computer.
12. Close the cover (2).

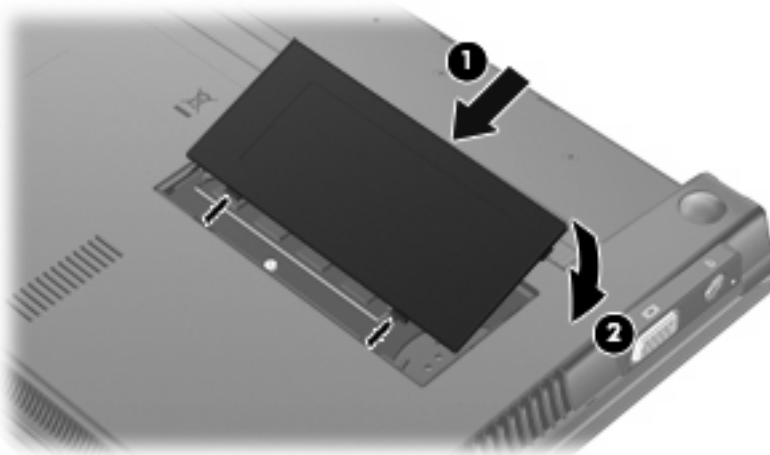

13. Replace the battery.
14. Turn the computer right-side up, and then reconnect external power and external devices.
15. Turn on the computer.

11 Computer Setup

Starting Computer Setup

Computer Setup is a preinstalled, ROM-based utility that can be used even when the operating system is not working or will not load.

 **NOTE:** Some of the Computer Setup menu items listed in this guide may not be supported by your computer.

NOTE: Pointing devices are not supported in Computer Setup. You must use the keyboard to navigate and make selections.

NOTE: An external keyboard connected by USB can be used with Computer Setup only if USB legacy support is enabled.

To start Computer Setup, follow these steps:

1. Turn on or restart the computer.
2. Before your operating system opens and while the “F10=ROM Based Setup” message is displayed in the lower-left corner of the screen, press **f10**.

Using Computer Setup

Navigating and selecting in Computer Setup

The information and settings in Computer Setup are accessed from the File, Security, Diagnostics, and System Configuration menus.

1. Open Computer Setup by turning on or restarting the computer, and then pressing **f10** while the “F10 = ROM Based Setup” message is displayed in the lower-left corner of the screen.

Because Computer Setup is not operating system based, it does not support the TouchPad. Navigation and selection are by keystroke:

- To choose a menu or a menu item, use the arrow keys.
- To select an item, press **enter**.
- To close open dialog boxes and return to the main Computer Setup screen, press **esc**.

Gucci 1.0 Vista User Guide 537596-001--Final Review

- To view navigation information, press **f1**.
 - To change the language, press **f2**.
2. Select the **File, Security, Diagnostics, or System Configuration** menu.
 3. To exit Computer Setup, choose one of the following methods:
 - To exit Computer Setup without saving your preferences, use the arrow keys to select **File > Ignore changes and exit**. Then follow the instructions on the screen.
 - To save your preferences and exit Computer Setup, use the arrow keys to select **File > Save changes and exit**. Then follow the instructions on the screen.

Your preferences go into effect when the computer restarts.

Restoring factory settings in Computer Setup

To return all settings in Computer Setup to the values that were set at the factory, follow these steps:

1. Open Computer Setup by turning on or restarting the computer, and then pressing **f10** while the "F10 = ROM Based Setup" message is displayed in the lower-left corner of the screen.
2. Use the arrow keys to select **File > Restore defaults**, and then press **enter**.
3. When the confirmation dialog box opens, press **f10**.
4. To save your preferences and exit Computer Setup, use the arrow keys to select **File > Save changes and exit**. Then follow the instructions on the screen.

Your preferences go into effect when the computer restarts.

 **NOTE:** Your password settings and security settings are not changed when you restore the factory settings.

Computer Setup menus

The menu tables in this section provide an overview of the Computer Setup options.

 **NOTE:** Some of the Computer Setup menu items listed in this chapter may not be supported by your computer.

File menu

Select	To do this
System information	<ul style="list-style-type: none">• View identification information for the computer.• View specification information for the processor, cache and memory size, and system ROM.
Restore defaults	Replace the configuration settings in Computer Setup with the original factory settings. (Password settings and security settings are not changed when you restore the factory settings.)

Gucci 1.0 Vista User Guide 537596-001--Final Review

Select	To do this
Ignore changes and exit	Cancel any changes entered during the current session. Then exit and restart the computer.
Save changes and exit	Save any changes entered during the current session. Then exit and restart the computer. Your changes go into effect when the computer restarts.

Security menu

 **NOTE:** Some of the menu items listed in this section may not be supported by your computer.

Select	To do this
Setup password	Enter, change, or delete a setup password.
Power-on password	Enter, change, or delete a power-on password.
Password options	<ul style="list-style-type: none">• Enable/disable stringent security.• Enable/disable the password requirement on computer restart.
DriveLock passwords	<ul style="list-style-type: none">• Enable, change, or disable DriveLock on any computer hard drive.• Enter, change, or disable DriveLock on an optional MultiBay hard drive. <p>NOTE: DriveLock settings are accessible only when you enter Computer Setup by turning on (not restarting) the computer.</p>
System IDs	Enter a user-defined computer asset tracking number and ownership tag.
Disk Sanitizer	Run Disk Sanitizer to destroy all existing data on the primary hard drive. The following options are available: <ul style="list-style-type: none">• Fast: Runs the Disk Sanitizer erase cycle once.• Optimum: Runs the Disk Sanitizer erase cycle 3 times.• Custom: Allows you to select the desired number of Disk Sanitizer erase cycles from a list. <p>CAUTION: If you run Disk Sanitizer, the data on the primary hard drive is destroyed permanently.</p>

Diagnostics menu

Select	To do this
HDD Self-Test Options	Run a comprehensive self-test on any hard drive in the system or on any optional MultiBay hard drive.
Memory Check	Run a comprehensive check on system memory.

Gucci 1.0 Vista User Guide 537596-001--Final Review

System Configuration menu

 **NOTE:** Some of the listed System Configuration options may not be supported by your computer.

Select	To do this
Language	Change the Computer Setup language.
Boot options	<ul style="list-style-type: none">• Set an f9, f10, and f12 delay when starting up.• Enable/disable CD-ROM boot.• Enable/disable floppy boot.• Enable/disable internal network adapter boot.• Enable/disable MultiBoot, which sets a boot order that can include most boot devices in the system.• Set the Express Boot Popup delay in seconds.• Set the boot order.<ul style="list-style-type: none">◦ 1st boot device: USB CD-ROM◦ 2nd boot device: USB floppy◦ 3rd boot device: USB SuperDisk◦ 4th boot device: Notebook hard drive◦ 5th boot device: USB hard disk◦ 6th boot device: Network controller
Device configurations	<ul style="list-style-type: none">• Swap the functions of the fn key and left ctrl key.• Enable/disable USB legacy support. When enabled, USB legacy support allows the following:<ul style="list-style-type: none">◦ Use of a USB keyboard in Computer Setup even when a your operating system is not running.◦ Startup from bootable USB devices, including a hard drive, diskette drive, or optical drive connected by a USB port to the computer.• Enable/disable BIOS DMA data transfers.• Enable/disable fan always on while connected to an AC outlet.• Enable/disable data execution prevention.• Enable/disable LAN power saving mode.• Enable/disable SATA Native Mode.• Enable/disable Dual Core CPU.• Enable/disable HDD translation mode.

Gucci 1.0 Vista User Guide 537596-001--Final Review

Select	To do this
Built-in device options	<ul style="list-style-type: none">• Enable/disable embedded WLAN Device Radio.• Enable/disable embedded Bluetooth Device Radio.• Enable/disable Network Interface Controller (NIC)• Enable/disable LAN/WLAN Switching.• Enable/disable Wake on LAN.• Enable/disable the integrated camera (webcam)
Port options	<ul style="list-style-type: none">• Enable/disable USB port.• Enable/disable ExpressCard slot.

Index

A

AC adapter
 connecting 14
 identifying 9
administrator password 46
airport security devices 80
antennas 8
applications key, Windows 5
audio devices, connecting
 external 35
audio functions, checking 35
audio-in (microphone) jack 6, 32
audio-out (headphone) jack 6,
 32

B

battery
 calibrating 19
 charging 17, 19
 conserving power 22
 disposing 23
 inserting 16
 low battery levels 18
 recharging 22
 removing 16
 replacing 23
 storing 22
battery bay 8, 10
battery charge
 maximizing 18
battery light 17, 18
battery power 15
battery release latches 16
battery release latches,
 identifying 8
battery temperature 22
battery, identifying 9
bays, battery 10
Bluetooth device 25
Bluetooth label 10

boot options 94
boot order 94
button, volume mute 32
buttons
 power 4
 QuickLook 4
 QuickWeb 4
buttons, TouchPad 2

C

cables
 USB 64
calibrating battery 19
caps lock light, identifying 3
CD
 inserting 39, 67
 removing 42, 68
CD drive 38, 66
Certificate of Authenticity label 10
charging batteries 17, 19
checking audio functions 35
components
 additional hardware 9
 bottom 8
 display 7
 front 5
 left-side 7
 right-side 6
 top 1
composite video 75
Computer Setup
 device security 57
 Diagnostics menu 93
 DriveLock password 52
 File menu 92
 navigating and selecting 91
 power-on password 49
 restoring factory settings 92
 Security menu 93
 setup password 47

stringent security 57
System Configuration
 menu 94

connecting to a WLAN 29
connection, external power 14
connector, power 7
conservation, power 22
cord, power 9
corporate WLAN connection 29
critical battery level 18

D

device security 57
Diagnostics menu 93
digital card
 inserting 70
 removing 71
 stopping 71
Disk Cleanup software 81
Disk Defragmenter software 81
diskette drive 66
display
 image, switching 75
 screen brightness hotkeys 75
display components 7
drive light 5, 82
drive media 11
DriveLock password
 changing 55
 description 52
 entering 54
 removing 56
 setting 53
drives
 diskette 66
 external 66
 hard 66, 85
 MultiBay 66
 optical 66
drives, boot order 94

Gucci 1.0 Vista User Guide 537596-001--Final Review

- drives, optical drive 38
- DVD
 - changing region setting 41
 - inserting 39, 67
 - removing 42, 68
- DVD drive 38, 66
- DVD region settings 41
- E**
- earbuds 32
- embedded numeric keypad keys, identifying 5
- encryption 28
- esc key, identifying 5
- external audio devices, connecting 35
- external drive 66
- external monitor port 37
- external monitor port, identifying 7
- F**
- File menu 92
- firewall 28
- fn key 72
- fn key, identifying 5
- function keys 72
- function keys, identifying 5
- H**
- hard disk drive
 - external 66
 - HP 3D DriveGuard 82
 - installing 85
- hard drive
 - external 66
 - HP 3D DriveGuard 82
 - installing 85
- hardware, identifying 1
- HDMI 75
- headphone (audio-out) jacks 32
- headphones 32
- Hibernation
 - exiting 12
 - initiated during critical battery level 18
 - initiating 12
- hotkeys
 - decreasing screen brightness 75
 - decreasing speaker sound 76
 - description 72
 - displaying system information 73
 - increasing screen brightness 75
 - increasing speaker volume 76
 - initiating QuickLock 75
 - initiating Sleep 74
 - muting speaker sound 75
 - switching screen image 75
 - using 73
- HP 3D DriveGuard 82
- hubs 64
- I**
- icons
 - network status 25
 - wireless 25
- internal microphone, identifying 32
- internal microphones, identifying 8
- Internet connection setup 27
- J**
- jacks
 - audio-in (microphone) 6, 32
 - audio-out (headphone) 6, 32
 - RJ-45 (network) 6
- K**
- keyboard hotkeys, identifying 72
- keypad, embedded
 - enabling and disabling 76
 - identifying 76
 - switching key functions 77
 - using 76
- keypad, external
 - num lock 77
 - using 77
- keys
 - esc 5
 - fn 5
 - function 5
 - keypad 5
 - Windows applications 5
 - Windows logo 5
- L**
- labels
 - Bluetooth 10
 - Microsoft Certificate of Authenticity 10
 - regulatory 10
 - service tag 8, 10
 - wireless certification 10
 - WLAN 10
- latches, battery release 8
- legacy support, USB 91, 94
- light, drive 82
- lights
 - caps lock 3
 - drive 5
 - power 3, 7
 - QuickLook 3
 - QuickWeb 3
 - webcam 8, 32
 - wireless 6
- low battery level 18
- M**
- maintenance
 - Disk Cleanup 81
 - Disk Defragmenter 81
- memory module
 - inserting 89
 - removing 89
- memory module compartment, identifying 8
- microphones, internal 8, 32
- Microsoft Certificate of Authenticity label 10
- monitor port, external 7
- monitor, connecting 37
- mouse, external
 - connecting 72
 - setting preferences 72
- movie, watching 40
- MultiBay 66
- multimedia components, identifying 31
- multimedia software 34
- MultiMediaCard 70
- mute button 32
- N**
- network status icon 25
- num lock, external keypad 77

Gucci 1.0 Vista User Guide 537596-001--Final Review

O

- operating system
 - Microsoft Certificate of Authenticity label 10
 - Product Key 10
- optical disc
 - inserting 39, 67
 - removing 42, 68
- optical discs, using 38
- optical drive 38, 66

P

- passwords
 - administrator 46
 - DriveLock 52
 - power-on 49
 - setup 47
 - user 46
- pointing devices
 - setting preferences 72
- ports
 - external monitor 7, 37
 - USB 6, 7, 64
- power
 - connecting 14
 - conserving 22
- power button, identifying 4
- power connector, identifying 7
- power cord, identifying 9
- power light 7
- power light, identifying 3
- power plans 12
- Product Key 10
- product name and number, computer 8, 10
- projector, connecting 37
- public WLAN connection 29

Q

- QuickLock hotkey 75
- QuickLook button, identifying 4
- QuickLook light, identifying 3
- QuickWeb button, identifying 4
- QuickWeb light, identifying 3

R

- readable media 11
- region codes, DVD 41
- regulatory information
 - regulatory label 10
 - wireless certification labels 10

- release latches, battery 8
- RJ-45 (network) jack, identifying 6

S

- S-Video 75
- screen brightness hotkeys 75
- screen image, switching 75
- scrolling regions, TouchPad 2
- SD Card 70
- SD Card Reader 6, 70
- security cable slot, identifying 6
- Security menu 93
- security, wireless 27
- serial number, computer 8, 10
- service tag 8, 10
- setup of WLAN 27
- setup utility
 - Diagnostics menu 93
 - File menu 92
 - navigating and selecting 91
 - restoring factory settings 92
 - Security menu 93
 - System Configuration menu 94
- setup, computer 1
- shut down 24
- Sleep
 - exiting 11
 - initiating 11
- Sleep hotkey 74
- slots
 - security cable 6
- software
 - Disk Cleanup 81
 - Disk Defragmenter 81
- speakers 32
- speakers, identifying 6, 8
- storing battery 22
- stringent security 57, 93
- switches
 - wireless 6
- System Configuration menu 94
- system fan 94
- system information 92
- system information hotkey 73

T

- temperature 22

- TouchPad
 - buttons 2
 - identifying 2
 - scrolling regions 2
 - using 72
- traveling with the computer 10, 22
- turning off the computer 24

U

- unresponsive system 24
- USB cable, connecting 64
- USB devices
 - connecting 64
 - description 64
 - removing 64
 - stopping 64
- USB hubs 64
- USB legacy support 65, 91, 94
- USB port, powered 66, 67
- USB ports, identifying 6, 7, 64
- user password 46

V

- vents, identifying 7, 8
- video transmission types 75
- video, recording 8
- volume hotkeys 32
- volume mute button 32
- volume, adjusting 32

W

- webcam 8, 32
- webcam light, identifying 8, 32
- webcam properties, adjusting 44
- Windows applications key, identifying 5
- Windows logo key, identifying 5
- wireless antennas 8
- wireless certification label 10
- wireless controls
 - button 26
 - operating system 26
- wireless icon 25
- wireless light 6, 26
- wireless network (WLAN)
 - connecting 29
 - corporate WLAN connection 29
 - equipment needed 27
 - functional range 29

Gucci 1.0 Vista User Guide 537596-001--Final Review

public WLAN connection	29
security	27
wireless switch	6, 26
WLAN device	10, 25, 27
WLAN label	10
writable media	11

Antenna House XSL Formatter

Antenna House XSL FORMATTER