

Getting Started

HP Notebook

© Copyright 2011 Hewlett-Packard Development Company, L.P.

Bluetooth is a trademark owned by its proprietor and used by Hewlett-Packard Company under license. Microsoft and Windows are U.S. registered trademarks of Microsoft Corporation. SD Logo is a trademark of its proprietor.

The information contained herein is subject to change without notice. The only warranties for HP products and services are set forth in the express warranty statements accompanying such products and services. Nothing herein should be construed as constituting an additional warranty. HP shall not be liable for technical or editorial errors or omissions contained herein.

First Edition: January 2011

Document Part Number: 641801-001

Product notice

This guide describes features that are common to most models. Some features may not be available on your computer.

Software terms

By installing, copying, downloading, or otherwise using any software product preinstalled on this computer, you agree to be bound by the terms of the HP End User License Agreement (EULA). If you do not accept these license terms, your sole remedy is to return the entire unused product (hardware and software) within 14 days for a refund subject to the refund policy of your place of purchase.

For any further information or for requesting a full refund of the computer, please contact your local point of sale (the seller).

Safety warning notice

- △ **WARNING!** To reduce the possibility of heat-related injuries or of overheating the computer, do not place the computer directly on your lap or obstruct the computer air vents. Use the computer only on a hard, flat surface. Do not allow another hard surface, such as an adjoining optional printer, or a soft surface, such as pillows or rugs or clothing, to block airflow. Also, do not allow the AC adapter to come into contact with the skin or a soft surface, such as pillows or rugs or clothing, during operation. The computer and the AC adapter comply with the user-accessible surface temperature limits defined by the International Standard for Safety of Information Technology Equipment (IEC 60950).

Table of contents

1 Welcome	1
What's new?	2
Finding information	3
2 Getting to know your computer	5
Top	5
TouchPad	5
Lights	6
Buttons	8
Keys	9
Front	10
Right	11
Left	12
Display	13
Rear	14
Bottom	15
3 HP QuickWeb	16
Starting HP QuickWeb	17
4 Networking	18
Using an Internet service provider (ISP)	19
Connecting to a wireless network	19
Connecting to an existing WLAN	19
Setting up a new WLAN network	20
Configuring a wireless router	21
Protecting your WLAN	21
5 Keyboard and pointing devices	22
Using the keyboard	23
Identifying the hotkeys	23
.....	24
Using keypads	24

Using the embedded numeric keypad	24
Turning the embedded numeric keypad on and off	26
Switching key functions on the embedded numeric keypad	26
Using an optional external numeric keypad	26
Rotating the display	27
Using pointing devices	28
Setting pointing device preferences	28
Using the pointing stick	28
Using the TouchPad	28
Turning the TouchPad off and on	30
Navigating	30
Selecting	31
Using TouchPad gestures	31
Scrolling	32
Pinching/Zooming	32
Rotating	33
Using the digitizer pen	33
Identifying the pen components	33
Holding the pen	33
Storing the pen	34
Using touch screen gestures	34
Tapping (or clicking)	34
Flicking	35
Dragging	35
Scrolling	36
Rotating	36
Pinching/Zooming	37
Setting touch screen preferences	37
6 Maintenance	38
Inserting or removing the battery	38
Replacing or upgrading the hard drive	40
Removing the hard drive	40
Installing a hard drive	41
Adding or replacing memory modules	42
Updating programs and drivers	46
7 Backup and recovery	47
Windows 7	47
Backing up your information	47
Performing a system recovery	48
Using the Windows recovery tools	49
Using f11 recovery tools	49

Using a Windows 7 operating system DVD (purchased separately)	50
Windows Vista	51
Backing up your information	51
Performing a recovery	52
Using the Windows recovery tools	52
Using f11 recovery tools	53
Using a Windows Vista operating system DVD (purchased separately)	53
8 Customer support	55
Contacting customer support	56
Labels	57
9 Specifications	58
Input power	59
Operating environment	60
Index	61

1 Welcome

- [What's new?](#)
- [Finding information](#)

After you set up and register the computer, it is important to take the following steps:

- **Connect to the Internet**—Set up your wired or wireless network so that you can connect to the Internet. For more information, refer to [Networking on page 18](#).
- **Update your antivirus software**—Protect your computer from damage caused by viruses. The software is preinstalled on the computer and includes a limited subscription for free updates. For more information, refer to the *HP Notebook Reference Guide*. For instructions on accessing this guide, refer to [Finding information on page 3](#).
- **Get to know your computer**—Learn about your computer features. Refer to [Getting to know your computer on page 5](#) and [Keyboard and pointing devices on page 22](#) for additional information.
- **Find installed software**—Access a list of the software preinstalled on the computer. Select **Start > All Programs**. For details about using the software included with the computer, refer to the software manufacturer's instructions, which may be provided with the software or on the manufacturer's Web site.

What's new?

Finding information

The computer comes with several resources to help you perform various tasks.

Resources	For information about
<p><i>Quick Setup</i> poster</p>	<ul style="list-style-type: none"> • How to set up the computer • Help to identify computer components
<p><i>Getting Started</i></p> <p>To access this guide:</p> <p>Select Start > Help and Support > User Guides.</p> <p>– or –</p> <p>Select Start > All Programs > HP > HP Documentation.</p>	<ul style="list-style-type: none"> • Computer features • How to connect to a wireless network specifications • How to use the keyboard and pointing devices • How to replace or upgrade the hard drive and memory modules • How to perform a backup and recovery • How to contact customer support • Computer specifications
<p><i>HP Notebook Reference Guide</i></p> <p>To access this guide:</p> <p>Select Start > Help and Support > User Guides.</p> <p>– or –</p> <p>Select Start > All Programs > HP > HP Documentation.</p>	<ul style="list-style-type: none"> • Power management features • How to maximize battery life • How to use the multimedia features of the computer • How to protect the computer • How to care for the computer • How to update the software
<p>Help and Support</p> <p>To access Help and Support, select Start > Help and Support.</p> <p>NOTE: For country- or region-specific support, go to http://www.hp.com/support, select your country or region, and follow the on-screen instructions.</p>	<ul style="list-style-type: none"> • Operating system information • Software, driver, and BIOS updates • Troubleshooting tools • How to access technical support
<p><i>Regulatory, Safety, and Environmental Notices</i></p> <p>To access this guide:</p> <p>Select Start > Help and Support > User Guides.</p> <p>– or –</p> <p>Select Start > All Programs > HP > HP Documentation.</p>	<ul style="list-style-type: none"> • Regulatory and safety information • Battery disposal information

Resources	For information about
<p><i>Safety & Comfort Guide</i></p> <p>To access this guide:</p> <p>Select Start > Help and Support > User Guides.</p> <p>– or –</p> <p>Select Start >All Programs > HP > HP Documentation.</p> <p>– or –</p> <p>Go to http://www.hp.com/ergo.</p>	<ul style="list-style-type: none"> • Proper workstation setup, posture, health, and work habits • Electrical and mechanical safety information
<p><i>Worldwide Telephone Numbers</i> booklet</p> <p>This booklet is provided with your computer.</p>	<p>HP support telephone numbers</p>
<p>HP Web site</p> <p>To access this Web site, go to http://www.hp.com/support.</p>	<ul style="list-style-type: none"> • Support information • Ordering parts and finding additional help • Accessories available for the device
<p><i>Limited Warranty*</i></p> <p>To access the warranty:</p> <p>Select Start > Help and Support > User Guides > View Warranty Information.</p> <p>– or –</p> <p>Select Start > All Programs > HP > HP Documentation > View Warranty Information.</p> <p>– or –</p> <p>Go to http://www.hp.com/go/orderdocuments.</p>	<p>Warranty information</p>
<p>*You may find the expressly provided HP Limited Warranty applicable to your product located with the electronic guides on your computer and/or on the CD/DVD provided in the box. Some countries/regions may provide a printed HP Limited Warranty in the box. In countries/regions where the warranty is not provided in printed format, you may request a printed copy at http://www.hp.com/go/orderdocuments or write to:</p>	
<ul style="list-style-type: none"> • North America: Hewlett-Packard, MS POD, 11311 Chinden Blvd, Boise, ID 83714, USA • Europe, Middle East, Africa: Hewlett-Packard, POD, Via G. Di Vittorio, 9, 20063, Cernusco s/Naviglio (MI), Italy • Asia Pacific: Hewlett-Packard, POD, P.O. Box 200, Alexandra Post Office, Singapore 911507 	
<p>Please include your product number, warranty period (found on your serial number label), name, and postal address.</p>	

2 Getting to know your computer

- [Top](#)
- [Front](#)
- [Right](#)
- [Left](#)
- [Display](#)
- [Rear](#)
- [Bottom](#)

Top

TouchPad

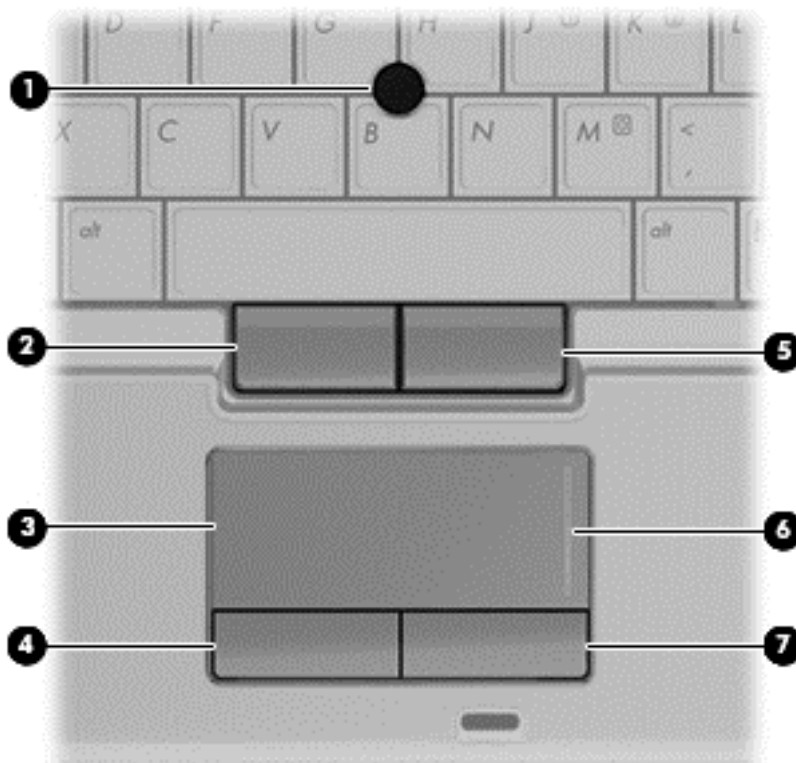

Component	Description
(1) Pointing stick	Moves the pointer and selects or activates items on the screen.
(2) Left pointing stick button	Functions like the left button on an external mouse.
(3) TouchPad	Moves the pointer and selects or activates items on the screen.
(4) Left TouchPad button	Functions like the left button on an external mouse.
(5) Right pointing stick button	Functions like the right button on an external mouse.
(6) TouchPad zone	Scrolls up or down.
(7) Right TouchPad button	Functions like the right button on an external mouse.

Lights

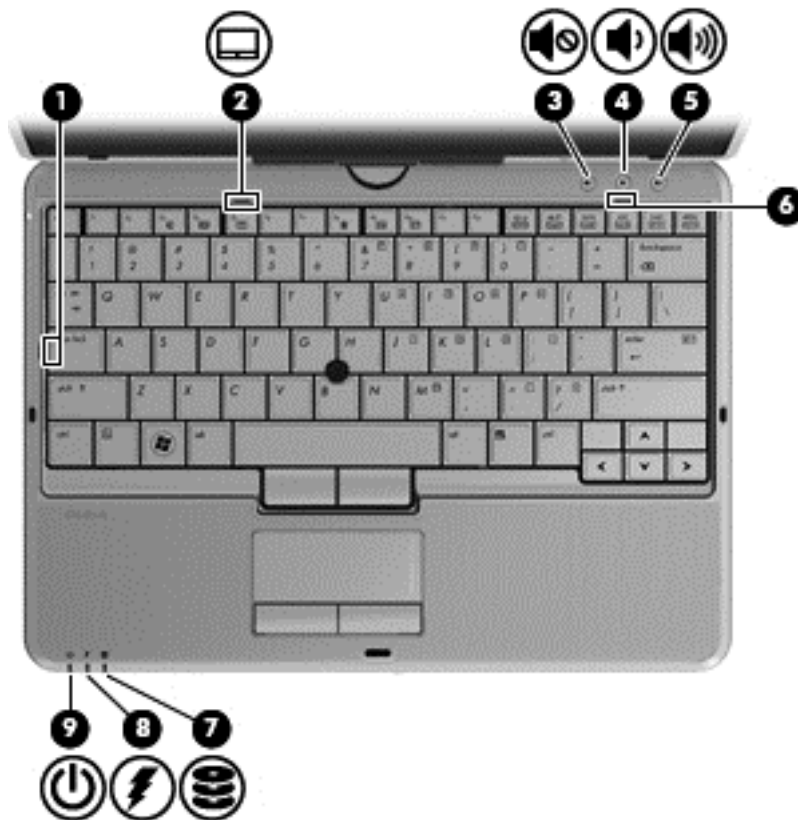

Component	Description
(1) Caps lock light	On: Caps lock is on.
(2) TouchPad light	<ul style="list-style-type: none"> Off: TouchPad is on. Amber: TouchPad is off.
(3) Mute light	<ul style="list-style-type: none"> Amber: Computer sound is off. Off: Computer sound is on.

Component	Description
(4) Volume down light	Blinking: The volume scroll zone is being used to decrease speaker volume.
(5) Volume up light	Blinking: The volume scroll zone is being used to increase speaker volume
(6) Num lock light	On: Num lock is on or the embedded numeric keypad is enabled.
(7) Drive light	<ul style="list-style-type: none"> • Blinking turquoise: The hard drive or optical drive is being accessed. • Amber: HP 3D DriveGuard has temporarily parked the hard drive.
(8) Battery light	<ul style="list-style-type: none"> • Amber: A battery is charging. • Turquoise: A battery is close to full charge capacity. • Blinking amber: A battery that is the only available power source has reached a low battery level. When the battery reaches a critical battery level, the battery light begins blinking rapidly. • Off: If the computer is plugged into an external power source, the light turns off when all batteries in the computer are fully charged. If the computer is not plugged into an external power source, the light stays off until the battery reaches a low battery level.
(9) Power light	<ul style="list-style-type: none"> • On: The computer is on. • Blinking: The computer is in the Sleep state. • Off: The computer is off or in Hibernation.

Buttons



Component	Description	
(1)	Volume mute button	Mutes and restores speaker sound.
(2)	Volume down button	Decreases computer volume.
(3)	Volume up button	Increases computer volume.

Keys

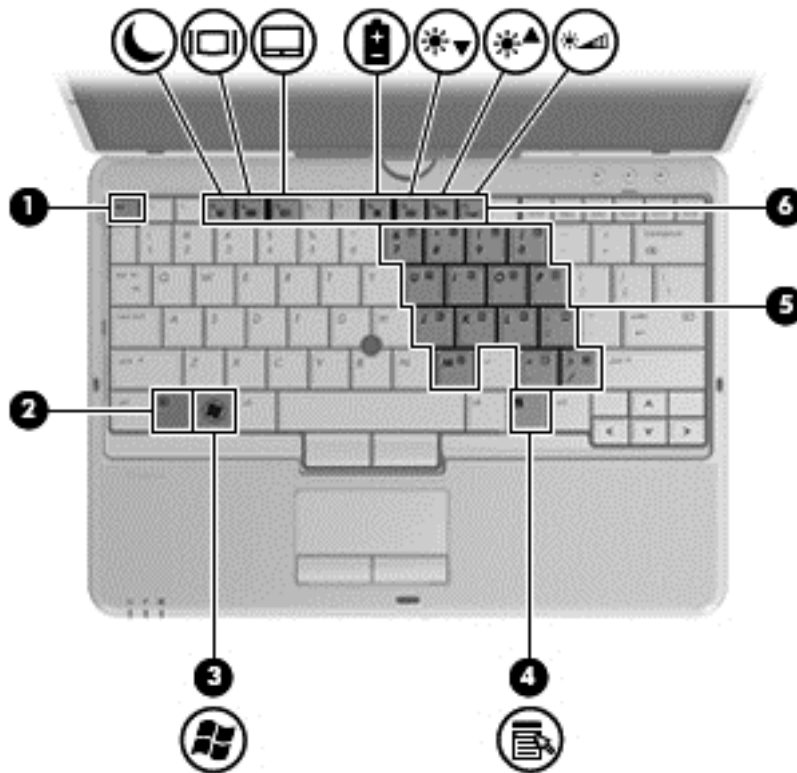

Component	Description
(1) esc key	Displays system information when pressed in combination with the fn key.
(2) fn key	Executes frequently used system functions when pressed in combination with a function key, the num lk key, or the esc key.
(3) Start key	Displays the Start menu.
(4) Menu key	Displays the active program's shortcut menu (same as right-click menu).
(5) Embedded numeric keypad keys	Can be used like the keys on an external numeric keypad when pressed in combination with the fn and num lk keys.
(6) Function keys	Execute frequently used system functions when pressed in combination with the fn key.

Front

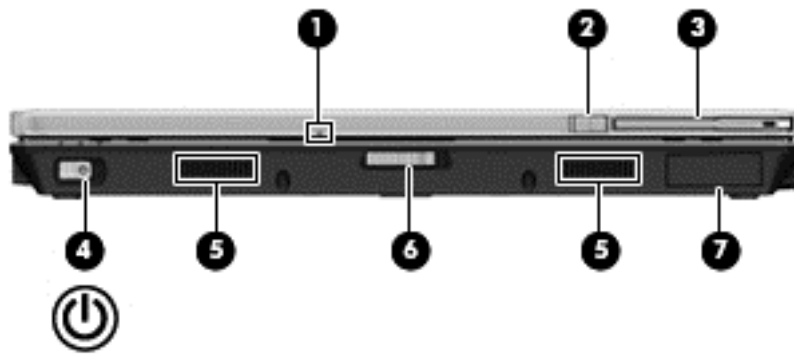

Component	Description
(1) Webcam light	On: The webcam is in use.
(2) External WWAN antenna button	Opens the external wireless wide area network (WWAN) antenna.
(3) External WWAN antenna	Sends and receives wireless signals to communicate with WWANs.
(4) Power switch	<ul style="list-style-type: none"> When the computer is off, slide the switch to the right to turn on the computer. When the computer is on, slide the switch to the right to shut down the computer. When the computer is in the Sleep state, slide the switch to the right briefly to exit Sleep. When the computer is in Hibernation, slide the switch to the right briefly to exit Hibernation. <p>If the computer has stopped responding and Windows shutdown procedures are ineffective, slide the switch to the right and hold for at least 5 seconds to turn off the computer.</p> <p>To learn more about your power settings, select Start > Control Panel > System and Security > Power Options.</p>
(5) Speakers (2)	Produce sound.
(6) Display release latch	Opens the computer.
(7) Bluetooth® compartment	Contains an optional Bluetooth device.

Right

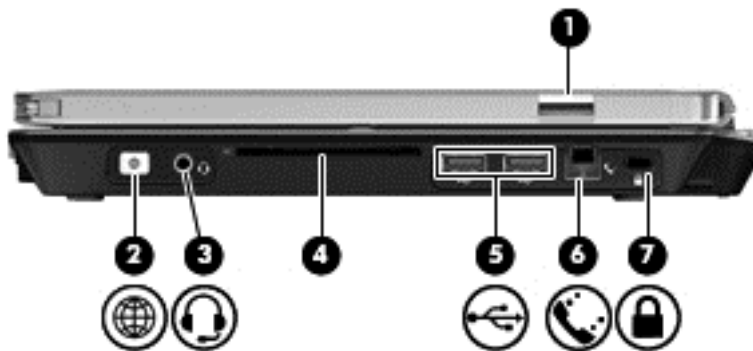

Component	Description
(1) HP Fingerprint Sensor (fingerprint reader)	Allows a fingerprint logon to Windows instead of a password logon.
(2) QuickWeb button	<ul style="list-style-type: none"> When the computer is off or in Hibernation, press the button to open HP QuickWeb. When the computer is in Microsoft Windows, press the button to open the default Web browser. When the computer is in HP QuickWeb, press the button to open the default Web browser. <p>NOTE: For more information, refer to “HP QuickWeb” in this guide and to the HP QuickWeb software Help. If your computer does not have HP QuickWeb software, the button does not perform any action or function.</p>
(3) Audio-out (headphone) jack/Audio-in (microphone) jack	<p>Connects optional powered stereo speakers, headphones, earbuds, a headset, or television audio. Also connects an optional headset microphone.</p> <p>WARNING! To reduce the risk of personal injury, adjust the volume before putting on headphones, earbuds, or a headset. For additional safety information, refer to the <i>Regulatory, Safety, and Environmental Notices</i>.</p> <p>NOTE: When a device is connected to the jack, the computer speakers are disabled.</p> <p>NOTE: A 4-conductor audio jack plug headphone with microphone is needed in order to use the microphone function.</p>
(4) Smart card reader	Supports optional smart cards and Java™ Cards.
(5) USB ports (2)	Connect optional USB devices.
(6) RJ-11 (modem) jack (select models only)	Connects a modem cable.
(7) Security cable slot	<p>Attaches an optional security cable to the computer.</p> <p>NOTE: The security cable is designed to act as a deterrent, but it may not prevent the computer from being mishandled or stolen.</p>

Left

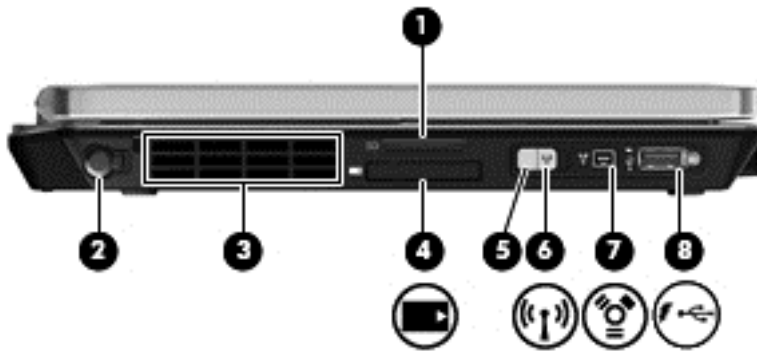

Component	Description
(1) Media Card Reader	Supports the following digital card formats: <ul style="list-style-type: none"> MultiMediaCard Secure Digital (SD) Card
(2) Pen holder	Stores the digitizer pen.
(3) Vent	Enables airflow to cool internal components. <p>NOTE: The computer fan starts up automatically to cool internal components and prevent overheating. It is normal for the internal fan to cycle on and off during routine operation.</p>
(4) Express card slot (select models only)	Supports optional ExpressCards.
(5) Wireless light	<ul style="list-style-type: none"> Blue: An integrated wireless device, such as a wireless local area network (WLAN) device, the HP Mobile Broadband Module, and/or a Bluetooth device, is on. Amber: All wireless devices are off.
(6) Wireless switch	Turns the wireless feature on or off, but does not create a wireless connection. <p>NOTE: A wireless network must be set up in order to establish a wireless connection.</p>
(7) 1394 port	Connects an optional IEEE 1394 or 1394a device, such as a camcorder.
(8) eSATA/USB port	Connects a high-performance eSATA component, such as an eSATA external hard drive, or connects an optional USB device.

Display

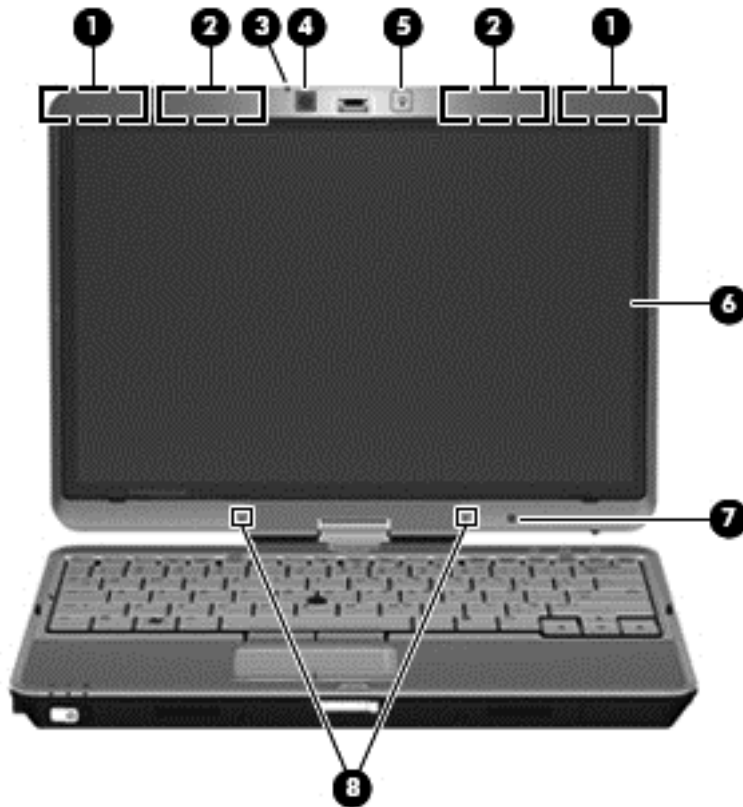

Component	Description
(1) WWAN antennas (2)* (select models only)	Send and receive wireless signals to communicate with wireless wide-area networks (WWAN).
(2) WLAN antennas (2)*	Send and receive wireless signals to communicate with wireless local area networks (WLAN).
(3) Webcam light	On: The webcam is in use.
(4) Webcam	Records video and captures still photographs. To use the webcam, select Start > All Programs > HP > HP Webcam .
(5) Keyboard light button	Opens and turns on the keyboard light.
(6) Touch screen	Allows you to perform certain actions on the touch screen using your fingers.
(7) Ambient light sensor	Automatically adjusts the display brightness based on the lighting conditions in your environment.
(8) Internal microphones (2)	Record sound.

*The antennas are not visible from the outside of the computer. For optimal transmission, keep the areas immediately around the antennas free from obstructions. To see wireless regulatory notices, refer to the section of the *Regulatory, Safety, and Environmental Notices* that applies to your country or region. These notices are located in Help and Support.

Rear

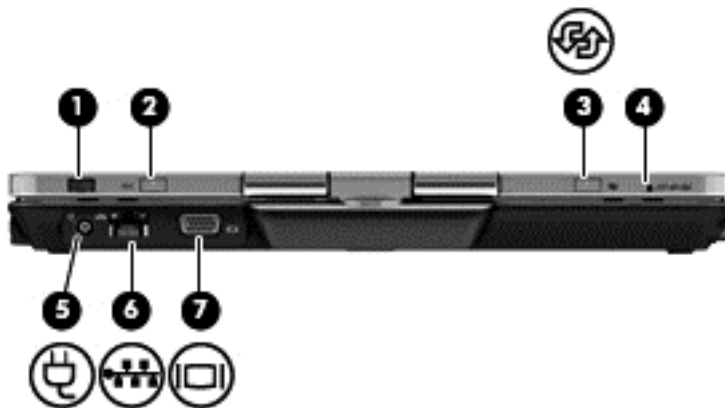

Component	Description
(1) Jog dial	<p>In tablet mode, functions like the enter key and the up and down arrows on a standard keyboard.</p> <ul style="list-style-type: none"> Press inward to enter a command. Rotate up to scroll up. Rotate down to scroll down.
(2) esc button	In tablet mode, allows you to exit or escape out of an application.
(3) Rotate button	In tablet mode, switches the image between landscape and portrait orientation.
(4) ctrl+alt+del button*	<p>In tablet mode:</p> <ul style="list-style-type: none"> While Windows is running, press the button with the pen to enter the ctrl+alt+del command.* While the Computer Setup utility is running, press the button with the pen to enter the reset command. The computer resets and all unsaved information is lost. The reset function can be used to restore functionality when the system has become unresponsive.
(5) Power connector	Connects an AC adapter.
(6) RJ-45 (network) jack	Connects a network cable.
(7) External monitor port	Connects an external VGA monitor or projector.

*To protect your work and the system, the ctrl+alt+delete command cannot be entered using the ctrl, alt, and del keys on the on-screen keyboard.

Bottom

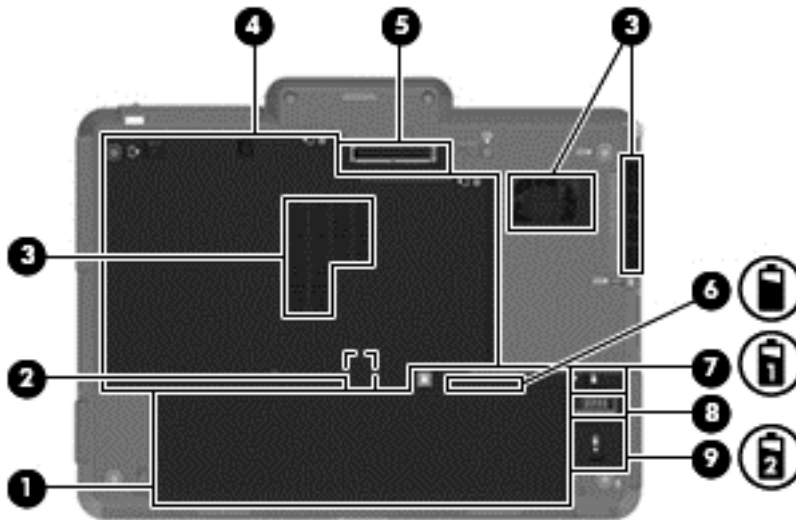

Component	Description
(1) Battery bay	Holds the battery.
(2) SIM slot	Contains a wireless subscriber identity module (SIM). The SIM slot is located inside the battery bay.
(3) Vents (3)	Enable airflow to cool internal components. NOTE: The computer fan starts up automatically to cool internal components and prevent overheating. It is normal for the internal fan to cycle on and off during routine operation.
(4) Hard drive bay	Contains the hard drive, the wireless LAN module slot, the WWAN module slot, and the memory module slot. CAUTION: To prevent an unresponsive system, replace the wireless module only with a wireless module authorized for use in the computer by the governmental agency that regulates wireless devices in your country or region. If you replace the module and then receive a warning message, remove the module to restore computer functionality, and then contact technical support through Help and Support.
(5) Docking connector	Connects an optional docking device.
(6) Charge level indicator	Displays the approximate remaining battery charge.
(7) Battery release latch	Releases the battery from the battery bay.
(8) Accessory battery connector	Connects an optional accessory battery.
(9) Accessory battery connector door	Slides open to expose the accessory battery connector.

3 HP QuickWeb

- [Starting HP QuickWeb](#)

The HP QuickWeb environment provides a fun and engaging way to perform many of your favorite activities. Your computer is ready to go within seconds of starting QuickWeb, allowing you to rapidly access the Internet, widgets, and communication programs. Simply press the QuickWeb button on your computer, and then start browsing the Internet, communicating with Skype, and exploring other HP QuickWeb programs.

Your HP QuickWeb Home screen includes the following features:

- Web browser—Search and browse the Internet, and create links to your favorite Web sites.
- Skype—Communicate using Skype, an application that uses voice over Internet protocol (VoIP). Skype lets you make conference calls or have video chats with one or more people at a time. You can also make long-distance phone calls to land lines.
- QuickWeb E-Mail—Read and send e-mail by connecting to Web-based e-mail providers, such as Gmail, or to your own mail server.
- Widgets—Start using widgets for news, weather, social networking, stocks, a calculator, sticky notes, and more. You can also use Widget Manager to add more widgets to the HP QuickWeb Home screen.

 **NOTE:** For additional information about using HP QuickWeb, refer to the [HP QuickWeb software Help](#).

Starting HP QuickWeb

- ▲ To start HP QuickWeb, press the QuickWeb button when the computer is off or in Hibernation.

The following table explains the different behaviors of the QuickWeb button.

Button	Behavior
QuickWeb button	<ul style="list-style-type: none">• When the computer is off or in Hibernation, opens HP QuickWeb.• When the computer is in Microsoft Windows, opens the default Web browser.• When the computer is in HP QuickWeb, opens the default Web browser. <p>NOTE: If your computer does not have HP QuickWeb software, the button does not perform any action or function.</p>

 **NOTE:** For more information, refer to the HP QuickWeb software Help.

4 Networking

- [Using an Internet service provider \(ISP\)](#)
- [Connecting to a wireless network](#)

 **NOTE:** Internet hardware and software features vary depending on computer model and your location.

Your computer may support one or both of the following types of Internet access:

- **Wireless**—For mobile Internet access, you can use a wireless connection. Refer to [Connecting to an existing WLAN on page 19](#) or [Setting up a new WLAN network on page 20](#).
- **Wired**—You can access the Internet by connecting to a wired network. For information on connecting to a wired network, refer to the *HP Notebook Reference Guide*.

Using an Internet service provider (ISP)

Before you can connect to the Internet, you must establish an ISP account. Contact a local ISP to purchase Internet service and a modem. The ISP will help set up the modem, install a network cable to connect your wireless computer to the modem, and test the Internet service.

 **NOTE:** Your ISP will give you a user ID and password to access the Internet. Record this information and store it in a safe place.

The following features will help you set up a new Internet account or configure the computer to use an existing account:

- **Internet Services & Offers (available in some locations)**—This utility assists with signing up for a new Internet account and configuring the computer to use an existing account. To access this utility, select **Start > All Programs > Online Services > Get Online**.
- **ISP-provided icons (available in some locations)**—These icons may be displayed either individually on the Windows desktop or grouped in a desktop folder named Online Services. To set up a new Internet account or configure the computer to use an existing account, double-click an icon, and then follow the on-screen instructions.
- **Windows Connect to the Internet Wizard**—You can use the Windows Connect to the Internet Wizard to connect to the Internet in any of these situations:
 - You already have an account with an ISP.
 - You do not have an Internet account and want to select an ISP from the list provided within the wizard. (The list of ISP providers is not available in all regions.)
 - You have selected an unlisted ISP, and the ISP has provided you with information such as a specific IP address and POP3 and SMTP settings.

To access the Windows Connect to the Internet Wizard and instructions for using it, select **Start > Control Panel > Network and Internet > Network and Sharing Center**.

 **NOTE:** If you are prompted within the wizard to choose between enabling or disabling Windows Firewall, choose to enable the firewall.

Connecting to a wireless network

Wireless technology transfers data across radio waves instead of wires. Your computer may be equipped with one or more of the following wireless devices:

- Wireless local area network (WLAN) device
- HP Mobile Broadband Module, a wireless wide area network (WWAN) device
- Bluetooth device

For more information on wireless technology and connecting to a wireless network, refer to the *HP Notebook Reference Guide* and information and Web site links provided in Help and Support.

Connecting to an existing WLAN

1. Turn on the computer.
2. Be sure that the WLAN device is on.

3. Click the network icon in the notification area, at the far right of the taskbar.
4. Select a network to connect to.
5. Click **Connect**.
6. If required, enter the security key.

Setting up a new WLAN network

Required equipment:

- A broadband modem (either DSL or cable) **(1)** and high-speed Internet service purchased from an Internet service provider (ISP)
- A wireless router (purchased separately) **(2)**
- Your new wireless computer **(3)**

 **NOTE:** Some modems have a built-in wireless router. Check with your ISP to determine what type of modem you have.

The illustration shows an example of a completed WLAN network installation that is connected to the Internet. As your network grows, additional wireless and wired computers can be connected to the network to access the Internet.

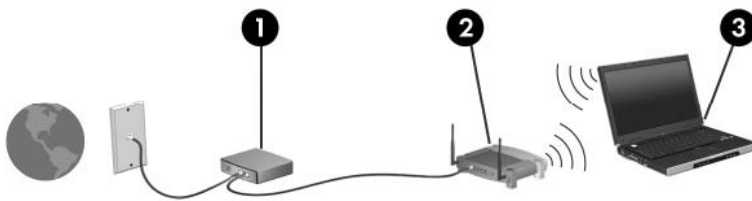

Configuring a wireless router

For help in setting up a WLAN, refer to the information provided by your router manufacturer or your ISP.

The Windows operating system also provides tools to help you set up a new wireless network. To use the Windows tools to set up your network:

- **Windows 7**—Select **Start > Control Panel > Network and Internet > Network and Sharing Center > Set up a new connection or network > Set up a network**. Then follow the on-screen instructions.
- **Windows Vista**—Select **Start > Control Panel > Network and Internet > Network and Sharing Center > Set up a connection or network > Set up a wireless router or access point**. Then follow the on-screen instructions.

 **NOTE:** It is recommended that you initially connect your new wireless computer to the router by using the network cable provided with the router. When the computer successfully connects to the Internet, you can disconnect the cable, and then access the Internet through your wireless network.

Protecting your WLAN

When you set up a WLAN or access an existing WLAN, always turn on security features to protect your network from unauthorized access.

For information on protecting your WLAN, refer to the *HP Notebook Reference Guide*.

5 Keyboard and pointing devices

- [Using the keyboard](#)
- [Rotating the display](#)
- [Using pointing devices](#)
- [Using touch screen gestures](#)

Using the keyboard



Identifying the hotkeys

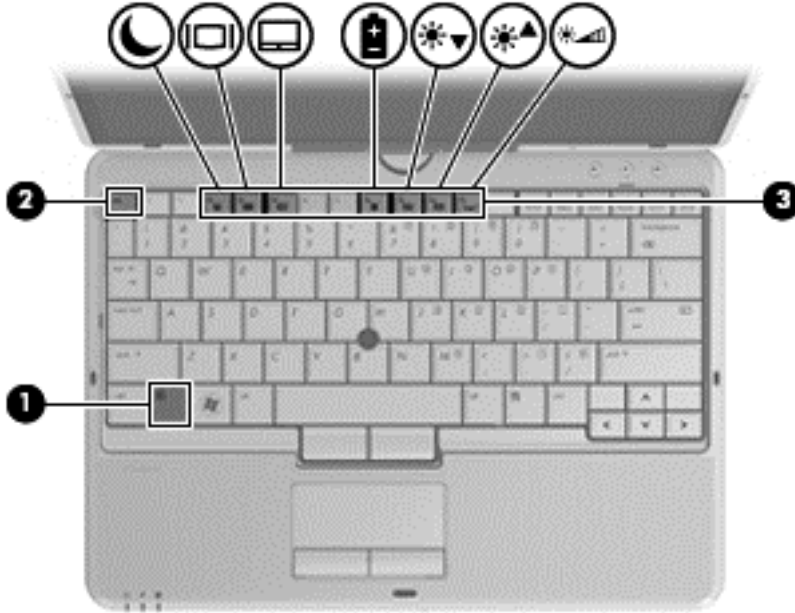

A hotkey is a combination of the **fn** key (1) and either the **esc** key (2) or one of the function keys (3).



To use a hotkey:

- ▲ Briefly press the **fn** key, and then briefly press the second key of the hotkey combination.

Hotkey combination	Description
fn+esc	Displays system information.
 fn+f3	Initiates Sleep, which saves your information in system. The display and other system components turn off and power is conserved. To exit Sleep, briefly press the power button. CAUTION: To reduce the risk of information loss, save your work before initiating Sleep. NOTE: If a critical battery level occurs while the computer is in the Sleep state, the computer initiates Hibernation and the information stored in is saved to the hard drive. The function of the fn+f3 hotkey can be changed. For example, you can set the fn+f3 hotkey to initiate Hibernation instead of Sleep. In all Windows operating system windows, references to the <i>sleep button</i> apply to the fn+f3 hotkey.
 fn+f4	Switches the screen image among display devices connected to the system. For example, if a monitor is connected to the computer, fn+f4 alternates the screen image from computer display to monitor display to simultaneous display on both the computer and the monitor. Most external monitors receive video information from the computer using the external VGA video standard. The fn+f4 hotkey can also alternate images among other devices that are receiving video information from the computer.
fn+f5	Enable/disable the TouchPad.
 fn+f8	Displays charge information for all installed batteries. The display indicates which batteries are charging and reports the amount of charge remaining in each battery.

Hotkey combination	Description
 fn+f9	Decreases the screen brightness level.
 fn+f10	Increases the screen brightness level.
fn+f11	Activates and deactivates the ambient light. When activated, the ambient light sensor automatically adjusts the display brightness based on the lighting conditions in your environment.

Using keypads

The computer includes either an embedded numeric keypad or an integrated numeric keypad. The computer also supports an optional external numeric keypad or an optional external keyboard that includes a numeric keypad.

Using the embedded numeric keypad

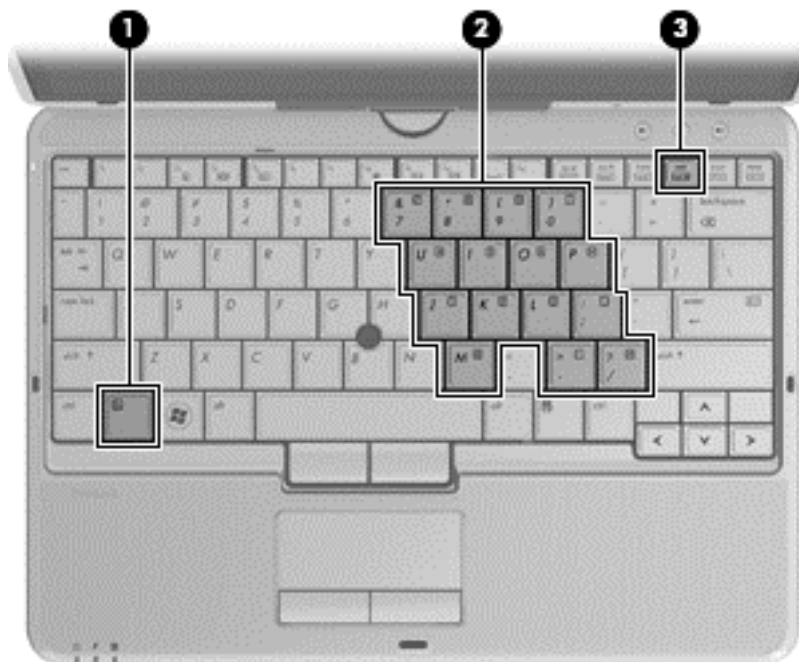

Component	Description
(1) fn key	Turns the embedded numeric keypad on and off when pressed in combination with the num lk key. NOTE: The embedded numeric keypad will not function while an external keyboard or numeric keypad is connected to the computer.

Component	Description
(2) Embedded numeric keypad	<p>When the keypad is turned on, it can be used like an external numeric keypad.</p> <p>Each key on the keypad performs the function indicated by the icon in the upper-right corner of the key.</p>
(3) num lk key	<p>Turns the embedded numeric keypad on and off when pressed in combination with the fn key.</p> <p>NOTE: The keypad function that is active when the computer is turned off is reinstated when the computer is turned back on.</p>

Turning the embedded numeric keypad on and off

Press **fn+num lk** to turn on the embedded numeric keypad. Press **fn+num lk** again to turn off the keypad.

 **NOTE:** The embedded numeric keypad is turned off while an external keyboard or numeric keypad is connected to the computer.

Switching key functions on the embedded numeric keypad

You can temporarily alternate the functions of keys on the embedded numeric keypad between their standard keyboard functions and their keypad functions:

- To use the numeric function of a keypad key while the keypad is off, press and hold the **fn** key while pressing the keypad key.
- To use the standard function of a keypad key while the keypad is on:
 - Press and hold the **fn** key to type in lowercase.
 - Press and hold **fn+shift** to type in uppercase.

Using an optional external numeric keypad

Keys on most external numeric keypads function differently according to whether num lock is on or off. (Num lock is turned off at the factory.) For example:

- When num lock is on, most keypad keys type numbers.
- When num lock is off, most keypad keys function like the arrow, page up, or page down keys.

When num lock on an external keypad is turned on, the num lock light on the computer is turned on. When num lock on an external keypad is turned off, the num lock light on the computer is turned off.

To turn num lock on or off on an external keypad as you work:

- ▲ Press the **num lk** key on the external keypad, not on the computer.

Rotating the display

To use the computer in slate mode:

1. Open the display.
2. Rotate the display 180 degrees either clockwise or counterclockwise.

△ **CAUTION:** To reduce the risk of damage to your computer, do not force the display past 180 degrees.

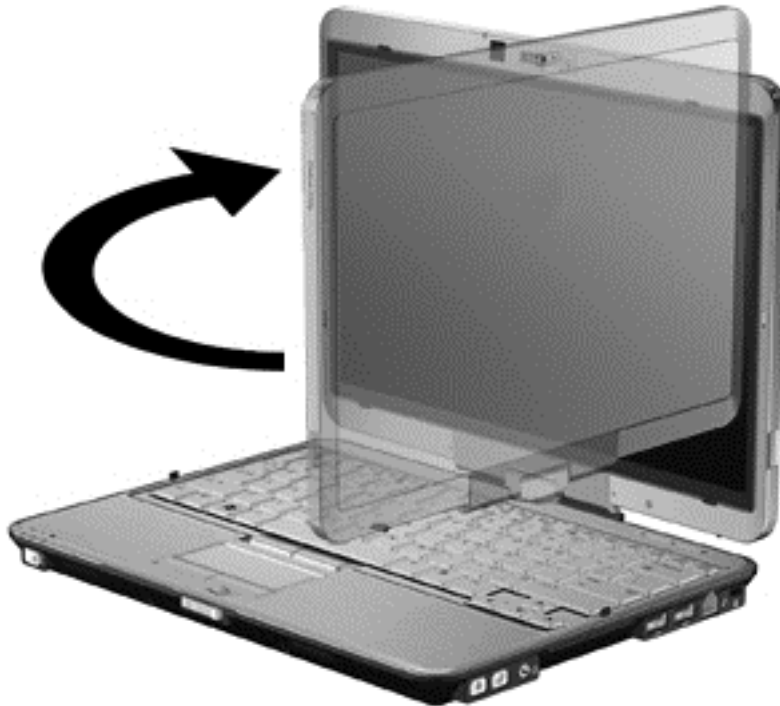

3. Lower the display over the keyboard.



△ **CAUTION:** To reduce the risk of damage to your computer, do not transport the computer while it is in slate mode.

Using pointing devices

📝 **NOTE:** In addition to the pointing devices included with your computer, you can use an external USB mouse (purchased separately) by connecting it to one of the USB ports on the computer.

Setting pointing device preferences

Use Mouse Properties in Windows to customize settings for pointing devices, such as button configuration, click speed, and pointer options.

To access Mouse Properties:

Windows 7—Select **Start > Devices and Printers**. Then right-click the device representing your computer, and select **Mouse settings**.

Windows Vista—Select **Start > Control Panel > Hardware and Sound > Mouse**.

Using the pointing stick

Press the pointing stick in the direction you want to move the pointer on the screen. Use the left and right pointing stick buttons as you would the left and right buttons on an external mouse.

Using the TouchPad

To move the pointer, slide one finger across the TouchPad in the direction you want the pointer to go. Use the left and right TouchPad buttons like the buttons on an external mouse. To scroll up and down using the TouchPad vertical scroll zone, slide your finger up or down over the lines.

 **NOTE:** If you are using the TouchPad to move the pointer, you must lift your finger off the TouchPad before moving it to the scroll zone. Simply sliding your finger from the TouchPad to the scroll zone does not activate the scrolling function.

Turning the TouchPad off and on

To turn the TouchPad off and on, quickly double-tap the TouchPad light.

 **NOTE:** The TouchPad light is off when the TouchPad is on.

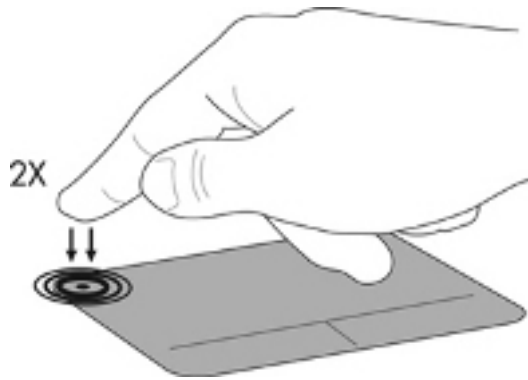

Navigating

To move the pointer, slide one finger across the TouchPad in the direction you want the pointer to go.

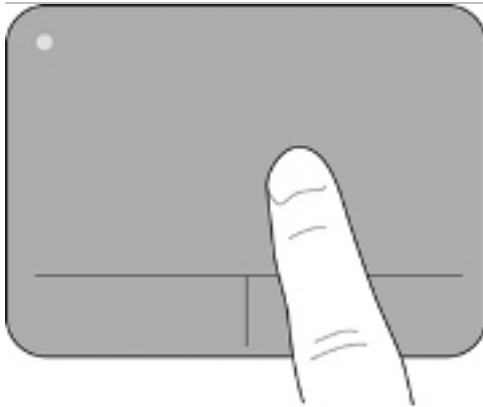

Selecting

Use the left and right TouchPad buttons like the corresponding buttons on an external mouse.

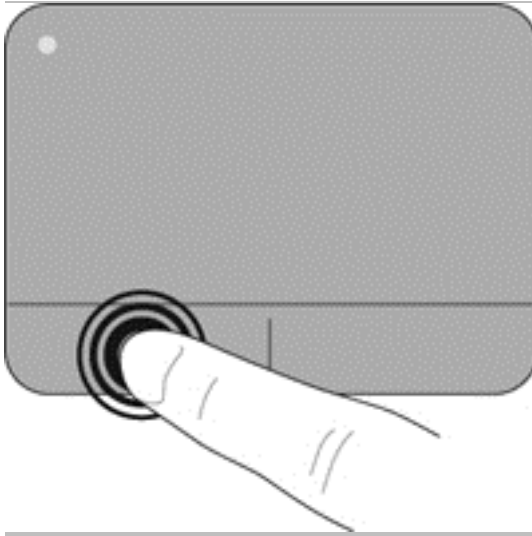

Using TouchPad gestures

The TouchPad supports a variety of gestures. To use TouchPad gestures, place two fingers on the TouchPad at the same time.

 **NOTE:** TouchPad gestures are not supported in all programs.

To view the demonstration of a gesture:

1. Right-click the Synaptics icon  in the notification area, at the far right of the taskbar, and then click **TouchPad Properties**.
2. Click a gesture to activate the demonstration.

To turn the gestures on and off:

1. Right-click the Synaptics icon  in the notification area, at the far right of the taskbar, and then click **TouchPad Properties**.
2. Select the gesture that you want to turn on or off.
3. Click **Apply**, and then click **OK**.

Scrolling

Scrolling is useful for moving up, down, or sideways on a page or image. To scroll, place two fingers slightly apart on the TouchPad, and then drag them across the TouchPad in an up, down, left, or right motion.

 **NOTE:** Scrolling speed is controlled by finger speed.

NOTE: Two-finger scrolling is enabled at the factory.

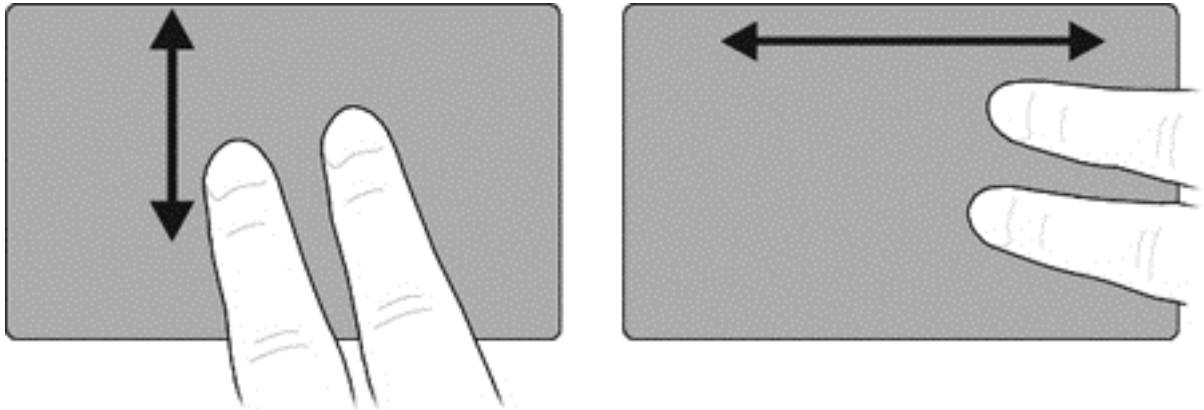

Pinching/Zooming

Pinching allows you to zoom in or out on images or text.

- Zoom in by placing two fingers together on the TouchPad, and then moving them apart.
- Zoom out by placing two fingers apart on the TouchPad, and then moving them together.

 **NOTE:** Pinching/zooming is enabled at the factory.

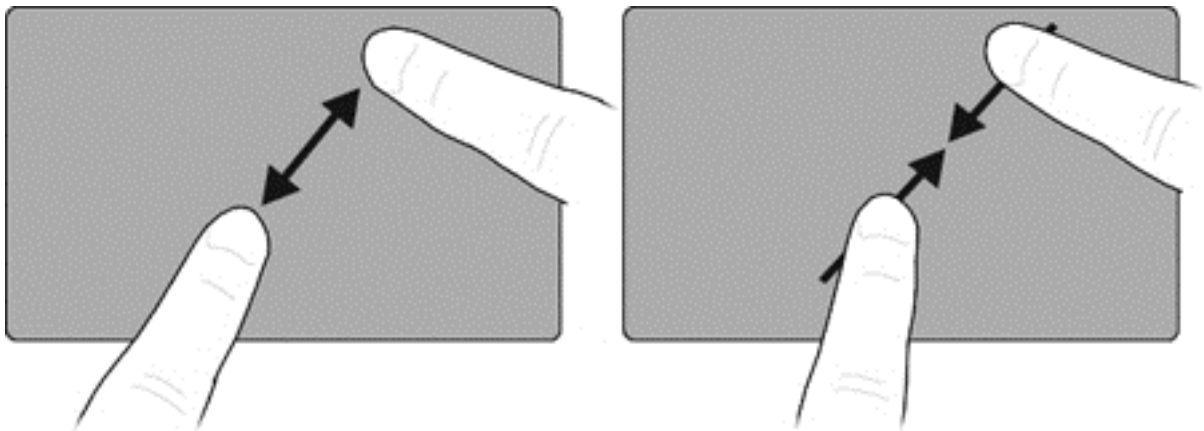

Rotating

Rotating allows you to rotate items such as photos. To rotate, anchor your left forefinger in the TouchPad zone. Move the right forefinger around the anchored finger in a sweeping motion, moving from 12 o'clock to 3 o'clock. To reverse the rotation, move your right forefinger from 3 o'clock to 12 o'clock.

 **NOTE:** Rotating must be done within the TouchPad zone.

NOTE: Rotating is disabled at the factory.

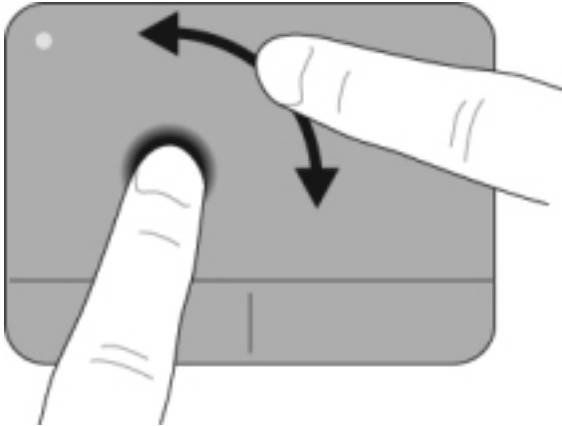

Using the digitizer pen

You can write with the pen in pen-specific programs such as Tablet PC Input Panel, in all Microsoft® Office programs, and in many other Windows programs and utilities. The information you write on the screen with the pen can be filed, searched, and shared among the programs.

Identifying the pen components

The pen interacts with the computer whenever the tip (1) or eraser (3) of the pen is pressed against the screen.

The pen tether eyelet (2) allows you to connect a tether from the pen to the pen tether hole on the computer.

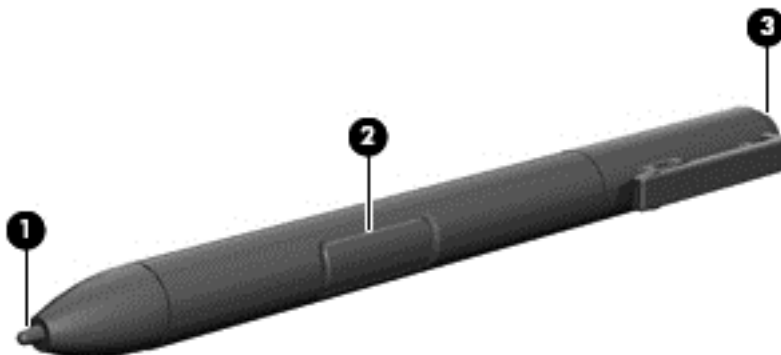

Holding the pen

Hold the pen as if you were writing with a standard pen or pencil.

Storing the pen

To store the pen when you are not using it, insert the pen, tip first, into the pen holder on the computer.

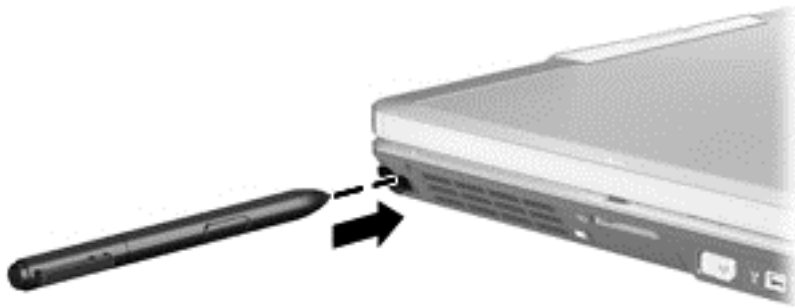

Using touch screen gestures

You can use your fingers or the digitizer pen on the touch screen.

To modify gestures on the touch screen:

▲ Select **Start > Control Panel > Hardware and Sound > Pen and Touch**.

 **NOTE:** Not all gestures are supported in all programs.

Tapping (or clicking)

Tap or double-tap an item on the screen as you would click or double-click with the TouchPad or an external mouse. Tap and hold an item to see the context menu as you would with the right TouchPad button.

 **NOTE:** You must tap and hold your finger until a circle appears around the area you are touching, and then the context menu appears.

Flicking

Touch the screen in a light, quick flicking motion up, down, left, or right to navigate through screens or quickly scroll through documents.



NOTE: For the flick movement to work, a scrollbar must be present in the active window.

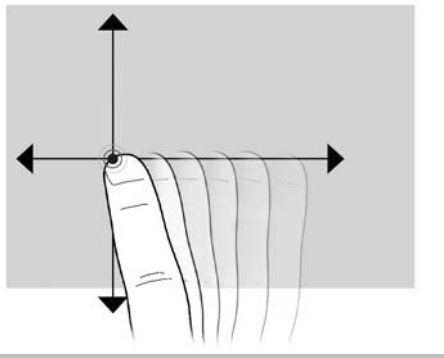

Dragging

Press your finger on an item on the screen, and then move your finger to drag the item to a new location. You can also use this motion to slowly scroll through documents.

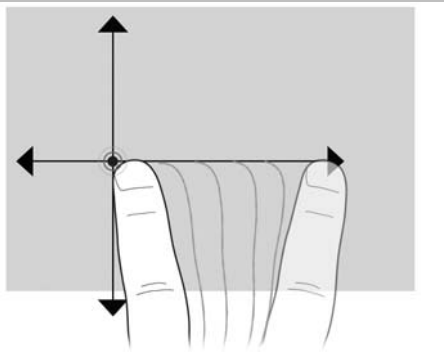

Scrolling

Scrolling is useful for moving up, down, or sideways on a page or image. To scroll, place two fingers slightly apart on the screen, and then drag them across the screen in an up, down, left, or right motion.

 **NOTE:** Scrolling speed is controlled by finger speed.

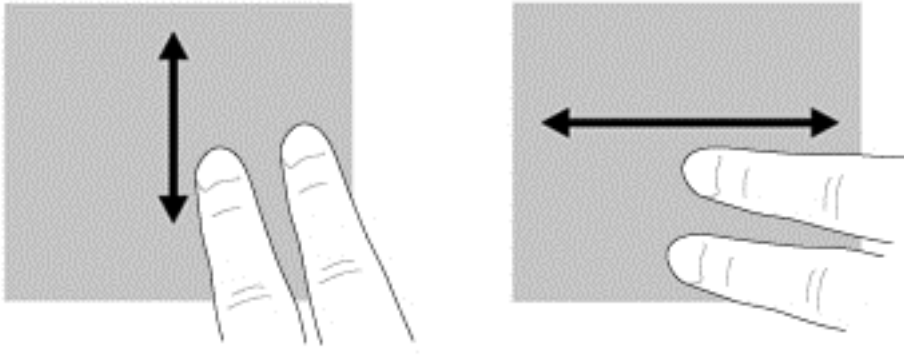

Rotating

Rotating allows you rotate items such as photos. To rotate, anchor your thumb on the screen, and then move your forefinger in a semicircular motion around your thumb.

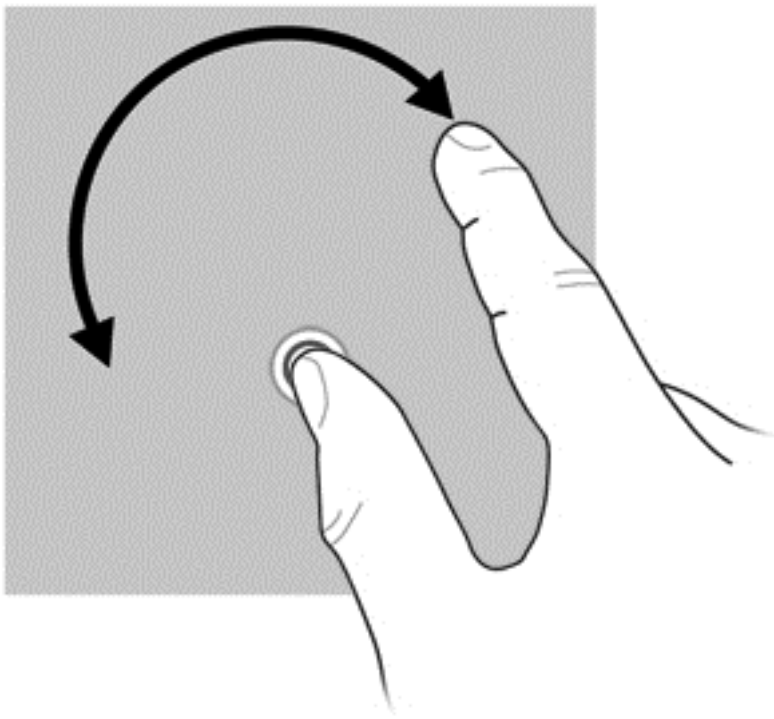

Pinching/Zooming

Pinching allows you to zoom in or out an item.

- Zoom in by holding two fingers together on the screen, and then pull the fingers apart.
- Zoom out by holding two fingers apart on the screen, and then pull the fingers together.

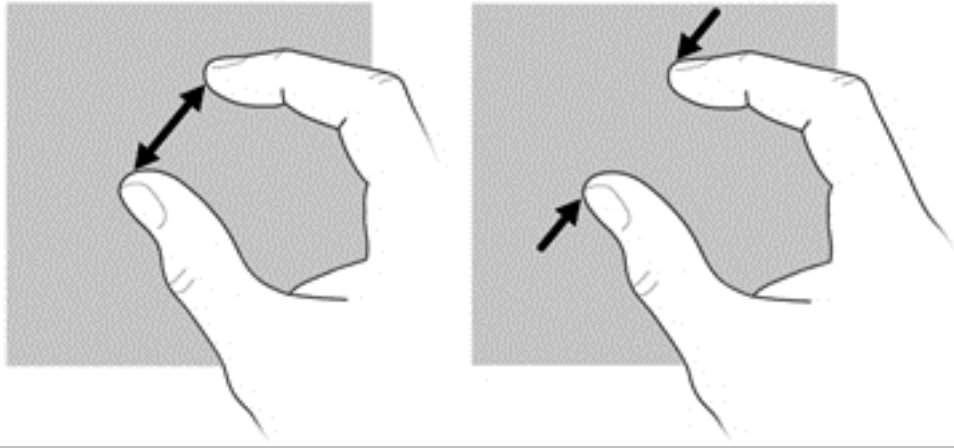

Setting touch screen preferences

- ▲ To set preferences, select **Start > Control Panel > Hardware and Sound > Pen and Touch**. These preferences are specific to the touch screen and the computer.
- ▲ To set preferences for left-handed or right-handed users, select **Start > Control Panel > Hardware and Sound > Tablet PC Settings > Other** tab. These preferences are specific to the touch screen and the computer.

To change or test click settings:

1. Select **Start > Control Panel > Hardware and Sound > Pen and Touch > Pen Options** tab.
2. Under **Pen Actions**, select the action, and then click **Settings**.
3. After making any changes or testing the settings, click **OK**.

To change or create flick assignments:

1. Select **Start > Control Panel > Hardware and Sound > Pen and Touch > Flicks** tab.
2. Click **Navigational flicks and editing flicks**, and then click **Customize**.
3. Follow the on-screen instructions to change or create a flick assignment.
4. Click **OK**.

6 Maintenance

- [Inserting or removing the battery](#)
- [Replacing or upgrading the hard drive](#)
- [Adding or replacing memory modules](#)
- [Updating programs and drivers](#)

Inserting or removing the battery

 **NOTE:** For additional information on using the battery, refer to the *HP Notebook Reference Guide*.

To insert the battery:

- ▲ Insert the battery **(1)** into the battery bay until it is seated.

The battery release latch **(2)** automatically locks the battery into place.

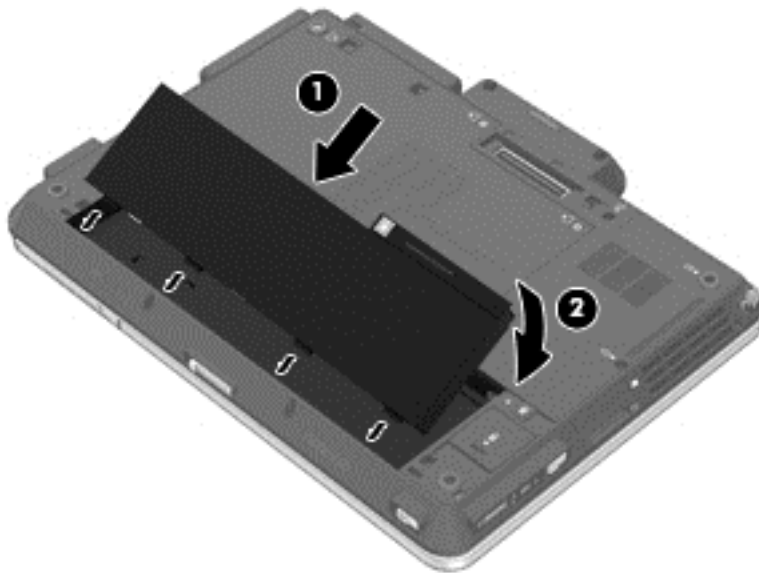

To remove the battery:

△ **CAUTION:** Removing a battery that is the sole power source for the computer can cause loss of information. To prevent loss of information, save your work and initiate Hibernation or shut down the computer through Windows before removing the battery.

1. Slide the battery release latch **(1)** to release the battery.

2. Remove the battery from the computer (2).

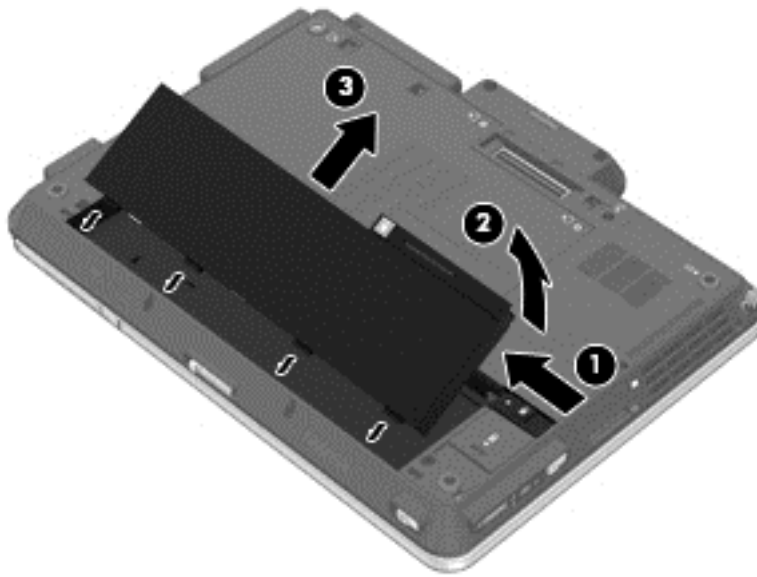

Replacing or upgrading the hard drive

△ **CAUTION:** To prevent information loss or an unresponsive system:

Shut down the computer before removing the hard drive from the hard drive bay. Do not remove the hard drive while the computer is on, in the Sleep state, or in Hibernation.

If you are not sure whether the computer is off or in Hibernation, turn the computer on by pressing the power button. Then shut down the computer through the operating system.

Removing the hard drive

1. Save your work and shut down the computer.
2. Disconnect AC power and external devices connected to the computer.
3. Remove the battery.
4. Loosen the 3 service cover screws (1).
5. Remove the service cover (2).

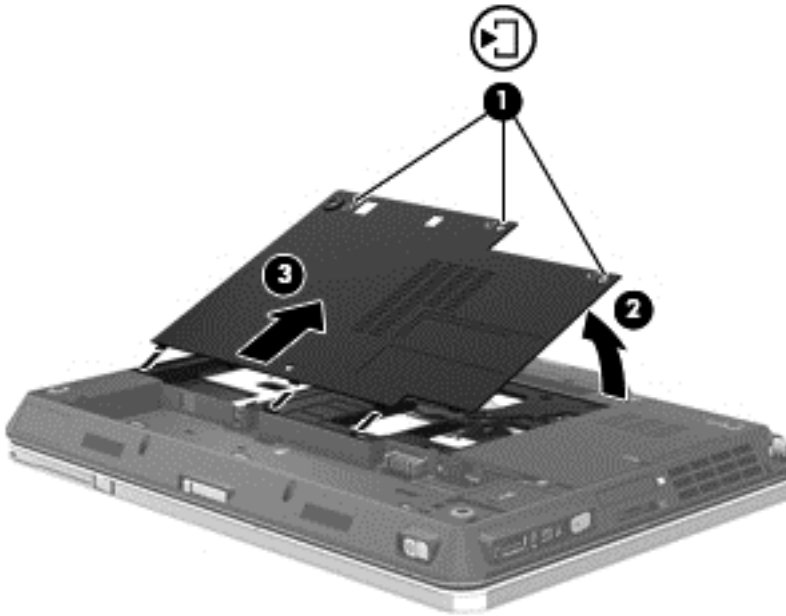

6. Grasp the tab on the hard drive (1) and pull forward (2) to disconnect the hard drive.

7. Lift the hard drive (3) out of the hard drive bay.

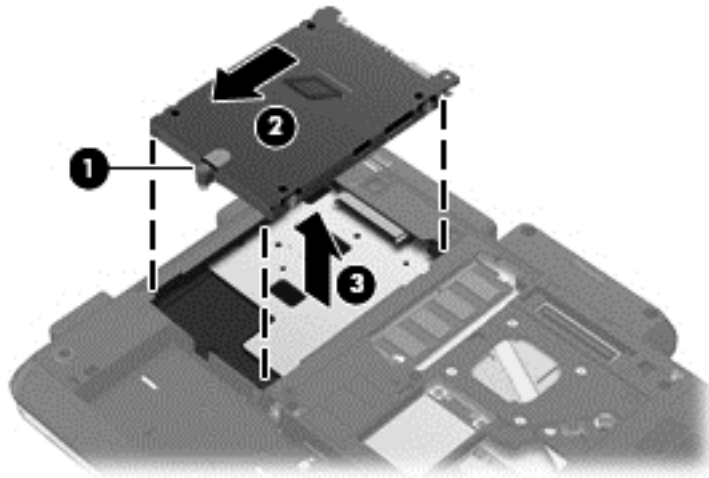

Installing a hard drive

1. Insert the hard drive into the hard drive bay (1).
2. Pull the hard drive tab (2) to the right until the hard drive snaps into place (3).

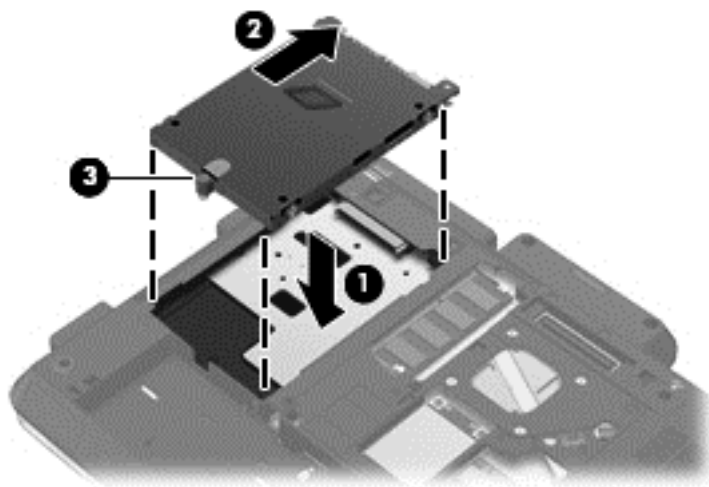

3. Align the tabs (1) on the service cover with the notches on the computer.
4. Close the cover (2).

5. Tighten the hard drive cover screws (3).

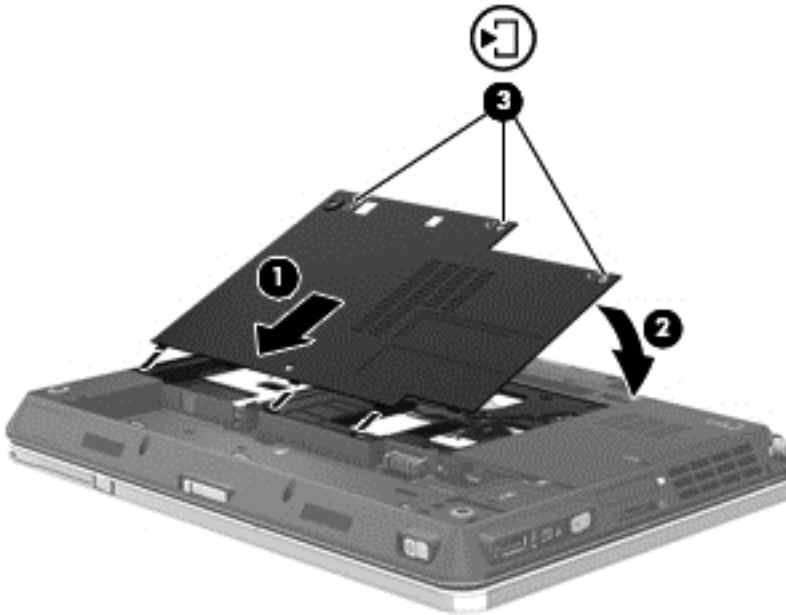

6. Replace the battery.
7. Connect AC power and external devices to the computer.
8. Turn on the computer.

Adding or replacing memory modules

The computer has two memory module compartments. The capacity of the computer can be upgraded by adding a memory module to the vacant expansion memory module slot or by upgrading the existing memory module in the primary memory module slot.

- ⚠ **WARNING!** To reduce the risk of electric shock and damage to the equipment, unplug the power cord and remove all batteries before installing a memory module.
- ⚠ **CAUTION:** Electrostatic discharge (ESD) can damage electronic components. Before beginning any procedure, ensure that you are discharged of static electricity by touching a grounded metal object.
- 📖 **NOTE:** To use a dual-channel configuration when adding a second memory module, be sure that both memory modules are identical.

To add or replace a memory module:

△ **CAUTION:** To prevent information loss or an unresponsive system:

Shut down the computer before adding or replacing memory modules. Do not remove a memory module while the computer is on, in the Sleep state, or in Hibernation.

If you are not sure whether the computer is off or in Hibernation, turn the computer on by pressing the power button. Then shut down the computer through the operating system.

1. Save your work and shut down the computer.
2. Disconnect AC power and external devices connected to the computer.
3. Remove the battery.
4. Loosen the 3 service cover screws (1).
5. Remove the service cover (2).

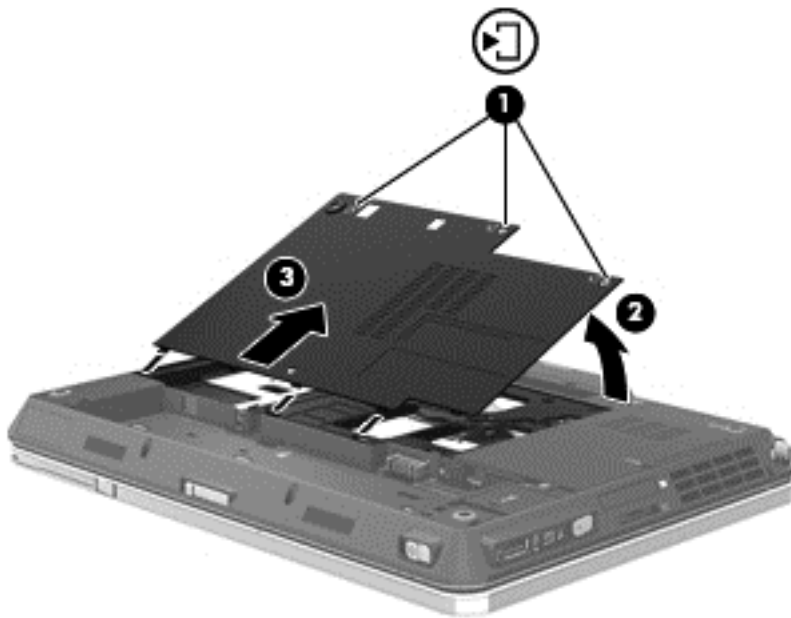

6. If you are replacing a memory module, remove the existing memory module:
 - a. Pull away the retention clips (1) on each side of the memory module.
The memory module tilts up.

- b. Grasp the edge of the memory module (2), and then gently pull the memory module out of the memory module slot.

△ **CAUTION:** To prevent damage to the memory module, hold the memory module by the edges only. Do not touch the components on the memory module.

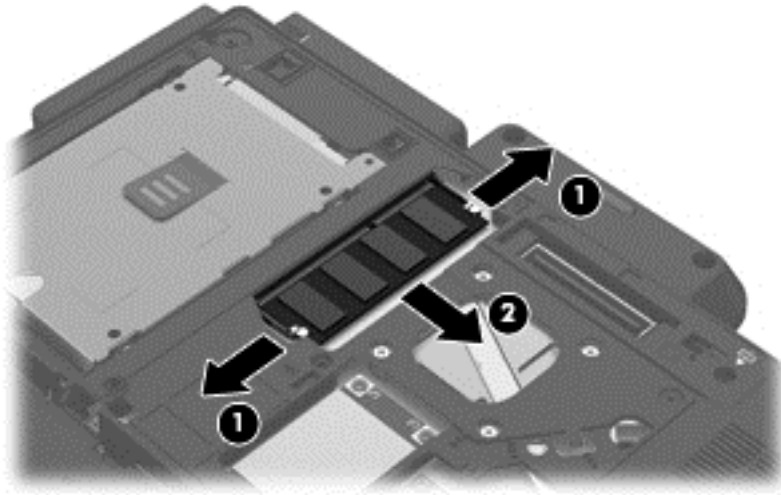

To protect a memory module after removal, place it in an electrostatic-safe container.

7. Insert a new memory module:

△ **CAUTION:** To prevent damage to the memory module, hold the memory module by the edges only. Do not touch the components on the memory module.

- a. Align the notched edge (1) of the memory module with the tab in the memory module slot.
- b. With the memory module at a 45-degree angle from the surface of the memory module compartment, press the module (2) into the memory module slot until it is seated.
- c. Gently press the memory module (3) down, applying pressure to both the left and right edges of the memory module, until the retention clips snap into place.

△ **CAUTION:** To prevent damage to the memory module, be sure that you do not bend the memory module.

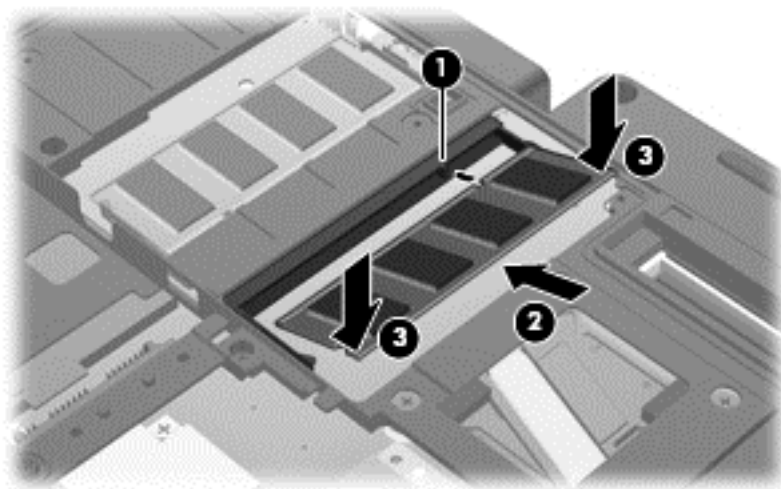

8. Align the tabs (1) on the service cover with the notches on the computer.
9. Close the cover (2).
10. Tighten the hard drive cover screws (3).

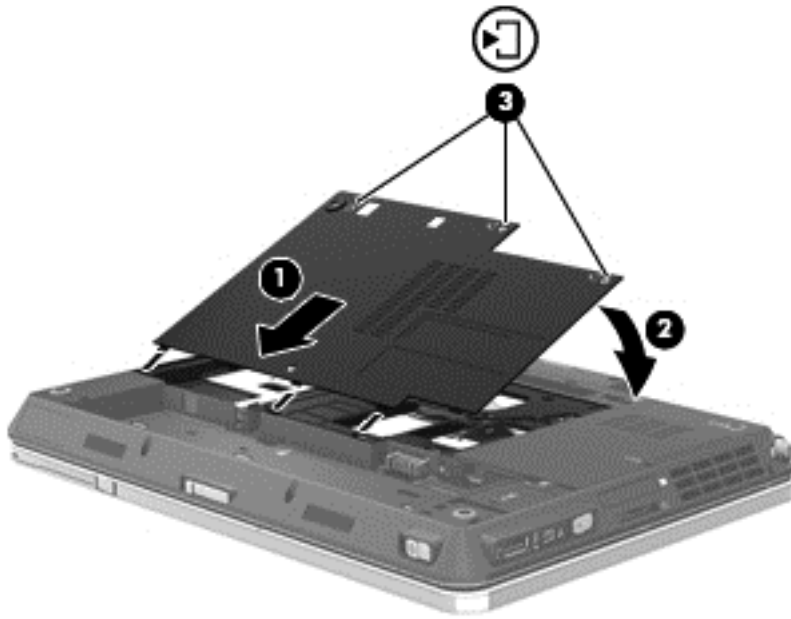

11. Replace the battery.
12. Connect AC power and external devices to the computer.
13. Turn on the computer.

Updating programs and drivers

HP recommends that you update your programs and drivers on a regular basis with the latest versions. Go to <http://www.hp.com/support> to download the latest versions. You can also register to receive automatic update notifications when they become available.

7 Backup and recovery

Windows 7

- [Backing up your information](#)
- [Performing a system recovery](#)

To protect your information, use Windows Backup and Restore to back up individual files and folders, back up your entire hard drive (select models only), create system repair discs (select models only) by using the installed optical drive (select models only) or an optional external optical drive, or create system restore points. In case of system failure, you can use the backup files to restore the contents of your computer.

Windows Backup and Restore provides the following options:

- Creating a system repair disc (select models only) by using the installed optical drive (select models only) or an optional external optical drive
- Backing up your information
- Creating a system image (select models only)
- Scheduling automatic backups (select models only)
- Creating system restore points
- Recovering individual files
- Restoring the computer to a previous state
- Recovering information using recovery tools

 **NOTE:** For detailed instructions, perform a search for these topics in Help and Support.

In case of system instability, HP recommends that you print the recovery procedures and save them for later use.

NOTE: Windows includes the User Account Control feature to improve the security of your computer. You may be prompted for your permission or password for tasks such as installing software, running utilities, or changing Windows settings. Refer to Help and Support for more information.

Backing up your information

Recovery after a system failure is as good as your most recent backup. You should create system repair discs (select models only) by using the installed optical drive (select models only) or an optional external optical drive, and your initial backup immediately after software setup. As you add

new software and data files, you should continue to back up your system on a regular basis to maintain a reasonably current backup. The system repair discs (select models only) are used to start up (boot) the computer and repair the operating system in case of system instability or failure. Your initial and subsequent backups allow you to restore your data and settings if a failure occurs.

You can back up your information to an optional external hard drive, a network drive, or discs.

Note the following when backing up:

- Store personal files in the Documents library, and back it up regularly.
- Back up templates that are stored in their associated programs.
- Save customized settings that appear in a window, toolbar, or menu bar by taking a screen shot of your settings. The screen shot can be a time-saver if you have to reset your preferences.
- When backing up to discs, use any of the following types of discs (purchased separately): CD-R, CD-RW, DVD+R, DVD+R DL, DVD-R, DVD-R DL, or DVD±RW. The discs you use will depend on the type of optical drive installed in your computer or the type of external optical drive you are using.

 **NOTE:** DVDs and DVDs with double-layer (DL) support store more information than CDs, so using them for backup reduces the number of recovery discs required.

- When backing up to discs, number each disc before inserting it into the optical drive of the computer.

To create a backup using Backup and Restore:

 **NOTE:** Be sure that the computer is connected to AC power before you start the backup process.

NOTE: The backup process may take over an hour, depending on file size and the speed of the computer.

1. Select **Start > All Programs > Maintenance > Backup and Restore**.
2. Follow the on-screen instructions to set up your backup, create a system image (select models only), or create a system repair disc (select models only).

Performing a system recovery

In case of system failure or instability, the computer provides the following tools to recover your files:

- Windows recovery tools: You can use Windows Backup and Restore to recover information you have previously backed up. You can also use Windows Startup Repair to fix problems that might prevent Windows from starting correctly.
- **f11** recovery tools: You can use the **f11** recovery tools to recover your original hard drive image. The image includes the Windows operating system and software programs installed at the factory.

 **NOTE:** If you are unable to boot (start up) your computer and you cannot use the system repair discs you previously created (select models only), you must purchase a Windows 7 operating system DVD to reboot the computer and repair the operating system. For additional information, refer to [Using a Windows 7 operating system DVD \(purchased separately\) on page 50](#).

Using the Windows recovery tools

To recover information you previously backed up:

1. Select **Start > All Programs > Maintenance > Backup and Restore**.
2. Follow the on-screen instructions to recover your system settings, your computer (select models only), or your files.

To recover your information using Startup Repair, follow these steps:

△ **CAUTION:** Using Startup Repair completely erases hard drive contents and reformats the hard drive. All files you have created and any software installed on the computer are permanently removed. When reformatting is complete, the recovery process restores the operating system, as well as the drivers, software, and utilities from the backup used for recovery.

1. If possible, back up all personal files.
2. If possible, check for the presence of the Windows partition and the HP Recovery partition.

To check for the Windows partition, select **Start > Computer**.

To check for the HP Recovery partition, click **Start**, right-click **Computer**, click **Manage**, and then click **Disk Management**.

 **NOTE:** If the Windows partition and the HP Recovery partition are not listed, you must recover your operating system and programs using the Windows 7 operating system DVD and the *Driver Recovery* disc (both purchased separately). For additional information, refer to [Using a Windows 7 operating system DVD \(purchased separately\) on page 50](#).

3. If the Windows partition and the HP Recovery partition are listed, restart the computer, and then press **f8** before the Windows operating system loads.
4. Select **Startup Repair**.
5. Follow the on-screen instructions.

 **NOTE:** For additional information on recovering information using the Windows tools, perform a search for these topics in Help and Support.

Using f11 recovery tools

△ **CAUTION:** Using **f11** completely erases hard drive contents and reformats the hard drive. All files you have created and any software installed on the computer are permanently removed. The **f11** recovery tool reinstalls the operating system and HP programs and drivers that were installed at the factory. Software not installed at the factory must be reinstalled.

To recover the original hard drive image using **f11**:

1. If possible, back up all personal files.
2. If possible, check for the presence of the HP Recovery partition: click **Start**, right-click **Computer**, click **Manage**, and then click **Disk Management**.

 **NOTE:** If the HP Recovery partition is not listed, you must recover your operating system and programs using the Windows 7 operating system DVD and the *Driver Recovery* disc (both purchased separately). For additional information, refer to [Using a Windows 7 operating system DVD \(purchased separately\) on page 50](#).

3. If the HP Recovery partition is listed, restart the computer, and then press **esc** while the “Press the ESC key for Startup Menu” message is displayed at the bottom of the screen.
4. Press **f11** while the “Press <F11> for recovery” message is displayed on the screen.
5. Follow the on-screen instructions.

Using a Windows 7 operating system DVD (purchased separately)

To order a Windows 7 operating system DVD, go to <http://www.hp.com/support>, select your country or region, and follow the on-screen instructions. You can also order the DVD by calling technical support. For contact information, refer to the *Worldwide Telephone Numbers* booklet included with the computer.

- △ **CAUTION:** Using a Windows 7 operating system DVD completely erases hard drive contents and reformats the hard drive. All files you have created and any software installed on the computer are permanently removed. When reformatting is complete, the recovery process helps you restore the operating system, as well as drivers, software, and utilities.

To initiate recovery using a Windows 7 operating system DVD:

- 📄 **NOTE:** This process takes several minutes.

1. If possible, back up all personal files.
2. Restart the computer, and then insert the Windows 7 operating system DVD into the optical drive before the Windows operating system loads.
3. When prompted, press any keyboard key.
4. Follow the on-screen instructions.
5. Click **Next**.
6. Select **Repair your computer**.
7. Follow the on-screen instructions.

Windows Vista

To protect your information, use the Backup and Restore Center to back up individual files and folders, back up your entire hard drive (select models only), or create system restore points. In case of system failure, you can use the backup files to restore the contents of your computer.

The Backup and Restore Center provides the following options:

- Backing up individual files and folders
- Backing up the entire hard drive (select models only)
- Scheduling automatic backups (select models only)
- Creating system restore points
- Recovering individual files
- Restoring the computer to a previous state
- Recovering information using recovery tools

 **NOTE:** For detailed instructions, perform a search for these topics in Help and Support.

NOTE: In case of system instability, HP recommends that you print the recovery procedures and save them for later use.

NOTE: Windows® includes the User Account Control feature to improve the security of your computer. You may be prompted for your permission or password for tasks such as installing software, running utilities, or changing Windows settings. Refer to Help and Support for more information.

Backing up your information

Recovery after a system failure is as complete as your most current backup. You should create your initial backup immediately after software setup. As you add new software and data files, you should continue to back up your system on a regular basis to maintain a reasonably current backup.

You can back up your information to an optional external hard drive, a network drive, or discs.

Note the following when backing up:

- Store personal files in the Documents folder, and back it up regularly.
- Back up templates that are stored in their associated programs.
- Save customized settings that appear in a window, toolbar, or menu bar by taking a screen shot of your settings. The screen shot can be a time-saver if you have to reset your preferences.
- When backing up to discs, use any of the following types of discs (purchased separately): CD-R, CD-RW, DVD+R, DVD+R DL, DVD-R, DVD-R DL, or DVD±RW. The discs you use will depend on the type of optical drive installed in your computer.

 **NOTE:** DVDs and DVDs with double-layer (DL) support store more information than CDs, so using them for backup reduces the number of recovery discs required.

- When backing up to discs, number each disc before inserting it into the optical drive of the computer.

To create a backup using Backup and Restore Center:

 **NOTE:** Be sure that the computer is connected to AC power before you start the backup process.

NOTE: The backup process may take over an hour, depending on file size and the speed of the computer.

1. Select **Start > All Programs > Maintenance > Backup and Restore Center**.
2. Follow the on-screen instructions to back up your entire computer (select models only) or your files.

Performing a recovery

In case of system failure or instability, the computer provides the following tools to recover your files:

- Windows recovery tools: You can use the Backup and Restore Center to recover information you have previously backed up. You can also use Windows Startup Repair to fix problems that might prevent Windows from starting correctly.
- **f11** recovery tools: You can use the **f11** recovery tools to recover your original hard drive image. The image includes the Windows operating system and software programs installed at the factory.

 **NOTE:** If you are unable to boot (start up) your computer, you must purchase a Windows Vista® operating system DVD to reboot the computer and repair the operating system. For additional information, refer to [Using a Windows Vista operating system DVD \(purchased separately\) on page 53](#).

Using the Windows recovery tools

To recover information you previously backed up:

1. Select **Start > All Programs > Maintenance > Backup and Restore Center**.
2. Follow the on-screen instructions to recover your entire computer (select models only) or your files.

To recover your information using Startup Repair, follow these steps:

 **CAUTION:** Using Startup Repair completely erases hard drive contents and reformats the hard drive. All files you have created and any software installed on the computer are permanently removed. When reformatting is complete, the recovery process restores the operating system, as well as the drivers, software, and utilities from the backup used for recovery.

1. If possible, back up all personal files.
2. If possible, check for the presence of the Windows partition and the HP Recovery partition. To find the partitions, select **Start > Computer**.

 **NOTE:** If the Windows partition and the HP Recovery partition have been deleted, you must recover your operating system and programs using the Windows Vista operating system DVD and the *Driver Recovery* disc (both purchased separately). For additional information, refer to [Using a Windows Vista operating system DVD \(purchased separately\) on page 53](#).

3. Restart the computer, and then press **f8** before the Windows operating system loads.

4. Select **Repair your computer**.

5. Follow the on-screen instructions.

 **NOTE:** For additional information on recovering information using the Windows tools, perform a search for these topics in Help and Support.

Using f11 recovery tools

△ **CAUTION:** Using **f11** completely erases hard drive contents and reformats the hard drive. All files you have created and any software installed on the computer are permanently removed. The **f11** recovery tool reinstalls the operating system and HP programs and drivers that were installed at the factory. Software not installed at the factory must be reinstalled. Personal files must be restored from a backup.

 **NOTE:** If your computer includes a solid-state drive (SSD), you may not have a recovery partition. Recovery discs have been included for computers that do not have a partition. Use these discs to recover your operating system and software. To check for the presence of a recovery partition, select **Start > Computer**. If the partition is present, an HP Recovery drive is listed in the Hard Disk Drives section of the window.

To recover the original hard drive image using **f11**, follow these steps:

1. If possible, back up all personal files.

2. If possible, check for the presence of the HP Recovery partition. To find the partition, select **Start > Computer**.

 **NOTE:** If the HP Recovery partition has been deleted, you must recover your operating system and programs using the Windows Vista operating system DVD and the *Driver Recovery* disc (both purchased separately). For additional information, refer to [Using a Windows Vista operating system DVD \(purchased separately\) on page 53](#).

3. Turn on or restart the computer, and then press **esc** while the “Press the ESC key for Startup Menu” message is displayed at the bottom of the screen.

4. Press **f11** while the “Press <F11> for recovery” message is displayed on the screen.

5. Follow the on-screen instructions.

Using a Windows Vista operating system DVD (purchased separately)

To order a Windows Vista operating system DVD, go to <http://www.hp.com/support>, select your country or region, and follow the on-screen instructions. You can also order the DVD by calling technical support. For contact information, refer to the *Worldwide Telephone Numbers* booklet included with the computer.

△ **CAUTION:** Using a Windows Vista operating system DVD completely erases hard drive contents and reformats the hard drive. All files you have created and any software installed on the computer are permanently removed. When reformatting is complete, the recovery process helps you restore the operating system, as well as drivers, software, and utilities.

To initiate recovery using a Windows Vista operating system DVD:

 **NOTE:** This process takes several minutes.

1. If possible, back up all personal files.
2. Restart the computer, and then insert the Windows Vista operating system DVD into the optical drive before the Windows operating system loads.
3. When prompted, press any keyboard key.
4. Follow the on-screen instructions.
5. Click **Next**.
6. Select **Repair your computer**.
7. Follow the on-screen instructions.

8 Customer support

- [Contacting customer support](#)
- [Labels](#)

Contacting customer support

If the information provided in this user guide, in the *HP Notebook Reference Guide*, or in Help and Support does not address your questions, you can contact HP Customer Support at:

<http://www.hp.com/go/contactHP>

 **NOTE:** For worldwide support, click **Contact HP worldwide** on the left side of the page, or go to http://welcome.hp.com/country/us/en/wwcontact_us.html.

Here you can:

- Chat online with an HP technician.

 **NOTE:** When technical support chat is not available in a particular language, it is available in English.

- E-mail HP Customer Support.
- Find HP Customer Support worldwide telephone numbers.
- Locate an HP service center.

Labels

The labels affixed to the computer provide information you may need when you troubleshoot system problems or travel internationally with the computer:

- Serial number label—Provides important information, including the following:



Component	
(1)	Product name
(2)	Serial number (s/n)
(3)	Part number/Product number (p/n)
(4)	Warranty period
(5)	Model description

Have this information available when you contact technical support. The serial number label is affixed to the bottom of the computer.

- Microsoft® Certificate of Authenticity—Contains the Windows Product Key. You may need the Product Key to update or troubleshoot the operating system. The Microsoft Certificate of Authenticity is located on the bottom of the computer.
- Regulatory label—Provides regulatory information about the computer. The regulatory label is affixed inside the battery bay.
- Wireless certification label or labels (select models only)—Provide information about optional wireless devices and the approval markings of some of the countries or regions in which the devices have been approved for use. If your computer model includes one or more wireless devices, one or more certification labels are included with your computer. You may need this information when traveling internationally. Wireless certification labels are affixed to the bottom of the computer.
- SIM (subscriber identity module) label (select models only)—Provides the ICCID (Integrated Circuit Card Identifier) of the SIM. This label is located inside the battery bay.
- HP Mobile Broadband Module serial number label (select models only)—Provides the serial number of the HP Mobile Broadband Module. This label is located inside the battery bay.

9 Specifications

- [Input power](#)
- [Operating environment](#)

Input power

The power information in this section may be helpful if you plan to travel internationally with the computer.

The computer operates on DC power, which can be supplied by an AC or a DC power source. The AC power source must be rated at 100–240 V, 50–60 Hz. Although the computer can be powered from a standalone DC power source, it should be powered only with an AC adapter or a DC power source supplied and approved by HP for use with this computer.

The computer can operate on DC power within the following specifications.

Input power	Rating
Operating voltage and current	18.5 V dc @ 3.5 A - 65W

 **NOTE:** This product is designed for IT power systems in Norway with phase-to-phase voltage not exceeding 240 V rms.

NOTE: The computer operating voltage and current can be found on the system regulatory label.

Operating environment

Factor	Metric	U.S.
Temperature		
Operating (writing to optical disc)	5°C to 35°C	41°F to 95°F
Nonoperating	-20°C to 60°C	-4°F to 140°F
Relative humidity (noncondensing)		
Operating	10% to 90%	10% to 90%
Nonoperating	5% to 95%	5% to 95%
Maximum altitude (unpressurized)		
Operating	-15 m to 3,048 m	-50 ft to 10,000 ft
Nonoperating	-15 m to 12,192 m	-50 ft to 40,000 ft

Index

Symbols/Numerics

1394 port, identifying 12

A

Accessory battery connector
identifying 15

Accessory battery connector door
identifying 15

Ambient light sensor,
identifying 13

ambient light, hotkey 24

audio-in (microphone) jack,
identifying 11

audio-out (headphone) jack,
identifying 11

B

Backup and Restore 48

Backup and Restore
Center 51, 52

battery bay 15, 57

battery light 7

battery release latch 15

battery, replacing 38

bluetooth compartment
identifying 10

Bluetooth label 57

buttons

left TouchPad 6

pointing stick 6

right TouchPad 6

volume down 8

volume mute 8

volume up 8

C

caps lock light, identifying 6

Certificate of Authenticity label 57

Charge level indicator
identifying 15

clicks

changing settings 37

testing 37

components

bottom 15

display 13

front 10

left side 12

rear 14

right side 11

top 5

connector, power 14

ctrl+alt+del button
Identifying 14

D

display image, switching 23

display release latch 10

display, rotating 27

Docking connector
identifying 15

dragging touch screen
gesture 35

drive light 7

E

embedded numeric keypad,
identifying 9, 24

eSATA port, identifying 12

esc button

Identifying 14

esc key, identifying 9

Express card slot
Identifying 12

external monitor port 14

F

f11 recovery 49, 53

fingerprint reader
Identifying 11

flicking touch screen gesture 35

flicks

changing assignments 37

creating assignments 37

fn key, identifying 9, 23, 24

function keys

identifying 9

H

hard drive

installing 41

removing 40

hard drive bay, identifying 15

hard drive recovery 49, 53

headphone (audio-out) jack 11

hotkeys

ambient light 24

battery charge 23

decrease screen

brightness 24

description 23

Enable/disable TouchPad 23

increase screen brightness 24

Sleep 23

switching screen image 23

using 23

I

input power 59

integrated webcam light,
identifying 13

internal microphones,
identifying 13

Internet connection setup 20

ISP, using 19

J

jacks

audio-in (microphone) 11

audio-out (headphone) 11

- network 14
- RJ-11 (modem) 11
- RJ-45 (network) 14
- jog dial, identifying 14

K

- keyboard hotkeys, identifying 23
- Keyboard light button
 - Identifying 13
- keypad, embedded numeric 9
- keypad, external
 - num lock 26
 - using 26
- keypads, identifying 24
- keys
 - esc 9
 - fn 9, 24
 - function 9
 - Menu 9
 - Start 9

L

- labels
 - Bluetooth 57
 - HP Mobile Broadband Module 57
 - Microsoft Certificate of Authenticity 57
 - regulatory 57
 - serial number 57
 - SIM 57
 - wireless certification 57
 - WLAN 57
- latch, battery release 15
- lights
 - battery 7
 - caps lock 6
 - drive 7
 - mute 6
 - num lock 7
 - power 7
 - TouchPad 6
 - volume down 7
 - volume up 7
 - webcam 13

M

- Media Card Reader, identifying 12
- memory module
 - inserting 44

- removing 43
- replacing 42
- Menu key, identifying 9
- microphone (audio-in) jack, identifying 11
- Microsoft Certificate of Authenticity label 57
- mouse, external
 - setting preferences 28
- mute light, identifying 6

N

- network jack, identifying 14
- num lk key, identifying 25
- num lock light 7
- num lock, external keypad 26

O

- operating environment 60
- operating system
 - Microsoft Certificate of Authenticity label 57
 - Product Key 57

P

- pen
 - identifying 33
 - storing 34
 - using 33
- pen holder
 - Identifying 12
- pen tether eyelet 33
- pinching touch screen gesture 37
- pinching TouchPad gesture 32
- pointing devices, setting preferences 28
- pointing stick 6
- pointing stick buttons 6
- ports
 - 1394 12
 - eSATA 12
 - external monitor 14
 - USB 11, 12
- power connector, identifying 14
- power lights 7
- Product Key 57
- product name and number, computer 57

Q

- QuickWeb
 - Home Screen 17
 - starting 17
- QuickWeb button
 - Identifying 11
- QuickWeb software 16

R

- recovery partition 49, 53
- regulatory information
 - regulatory label 57
 - wireless certification labels 57
- restoring the hard drive 49, 53
- RJ-11 (modem) jack, identifying 11
- RJ-45 (network) jack, identifying 14
- Rotate button
 - Identifying 14
- rotating touch screen gesture 36
- rotating TouchPad gesture 33

S

- screen brightness keys 24
- screen image, switching 23
- scrolling touch screen gesture 36
- scrolling TouchPad gesture 32
- security cable slot, identifying 11
- serial number 57
- serial number, computer 57
- setup of WLAN 20
- SIM slot, identifying 15
- slots
 - security cable 11
- smart card reader
 - Identifying 11
- speakers, identifying 10
- Start key, identifying 9
- system repair disc 47
- system restore points 47

T

- tapping touch screen gesture 34
- Touch screen
 - Identifying 13
- touch screen
 - performing screen actions 34
 - preferences 37
- touch screen gestures
 - dragging 35

- flicking 35
- pinching 37
- rotating 36
- scrolling 36
- tapping 34
- zooming 37
- TouchPad
 - buttons 6
 - using 28
- TouchPad gestures
 - pinching 32
 - rotating 33
 - scrolling 32
 - zooming 32
- TouchPad light, identifying 6
- TouchPad zone, identifying 6
- TouchPad, identifying 6
- traveling with the computer 57

U

- USB port, identifying 12
- USB ports, identifying 11

V

- vents, identifying 12, 15
- volume down button,
 - identifying 8
- volume down light 7
- volume mute button, identifying 8
- volume up button, identifying 8
- volume up light 7

W

- webcam 13
- webcam light
 - identifying 10
- webcam light, identifying 13
- webcam, identifying 13
- Windows 7 operating system
 - DVD 50
- Windows Backup and Restore 47
- Windows Vista operating system
 - DVD 53
- wireless antennas, identifying 13
- wireless certification label 57
- Wireless light
 - Identifying 12
- wireless network (WLAN),
 - equipment needed 20
- wireless network, connecting 19
- wireless router, configuring 21

- wireless set up 20
- Wireless switch
 - Identifying 12
- WLAN
 - connecting 19
 - protecting 21
- WLAN antennas, identifying 13
- WLAN device 57
- WLAN label 57
- WWAN antennas, identifying 13

Z

- zooming screen gesture 37
- zooming TouchPad gesture 32