

Conditions on using BRCM regulatory approvals:

- A. Customer must ensure that its product (the “CUSTOMER Product”) is electrically identical to Broadcom’s reference designs. Customer acknowledges that any modifications to Broadcom’s reference designs may invalidate regulatory approvals in relation to the CUSTOMER Product, or may necessitate notifications to the relevant regulatory authorities.
- B. Customer is responsible for ensuring that antennas used with the product are of the same type, with same or lower gains as approved and providing antenna reports to Broadcom.
- C. Customer is responsible for regression testing to accommodate changes to Broadcom’s reference designs, new antennas, and portable RF exposure safety testing/approvals.
- D. Appropriate labels must be affixed to the CUSTOMER Product that comply with applicable regulations in all respects.
- E. A user’s manual or instruction manual must be included with the customer product that contains the text as required by applicable law. Without limitation of the foregoing, an example (for illustration purposes only) of possible text to include is set forth below:

Antenna Host Platform Location Information. (Refer also to “FCC Radio-Frequency Exposure & Approval Conditions” below)

Antenna Dimensional Information for Netbook/notebook/laptop Mode.

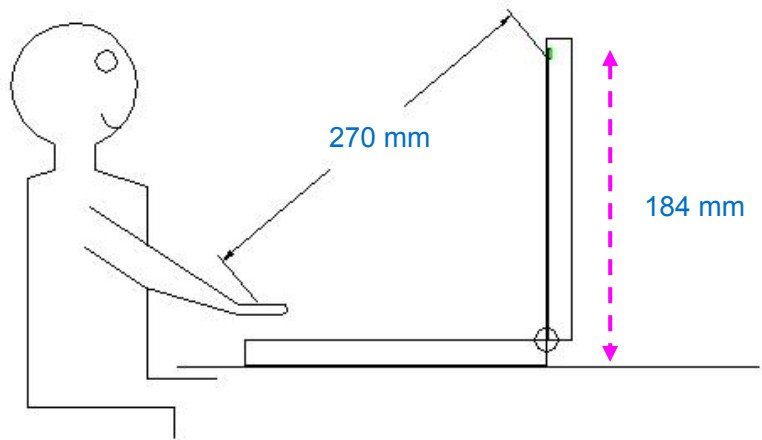
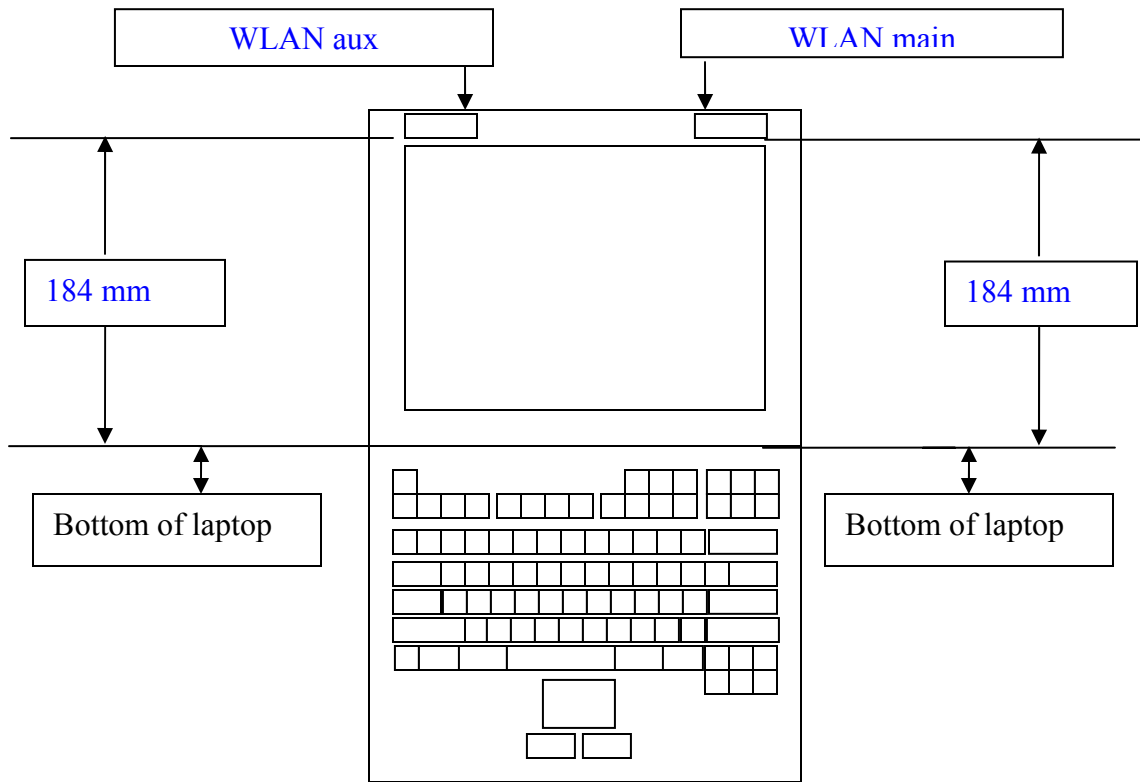

Antenna Dimensional Information for Tablet Mode.

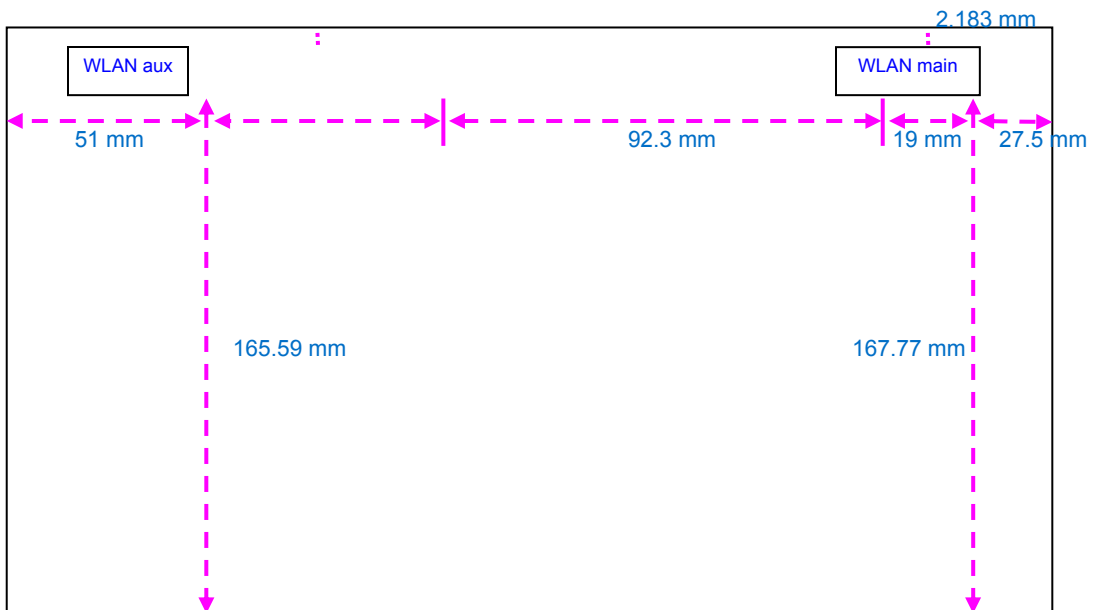
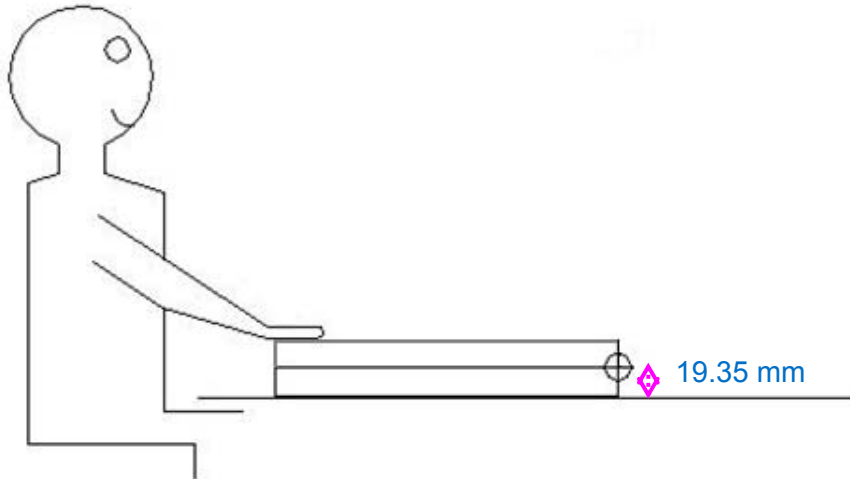

1. USA—Federal Communications Commission (FCC)

FCC COMPLIANCE STATEMENT:

This device complies with part 15 of the FCC Rules. Operation is subject to the following two conditions:

(1) This device may not cause harmful interference, and (2) this device must accept any interference received, including interference that may cause undesired operation.

INFORMATION TO USER:

This equipment has been tested and found to comply with the limits for a Class B digital device, pursuant to Part 15 of FCC Rules. These limits are designed to provide reasonable protection against harmful interference in a residential installation. This equipment generates, uses, and can radiate radio frequency energy. If not installed and used in accordance with the instructions, it may cause harmful interference to radio communications. However, there is no guarantee that interference will not occur in a particular installation. If this equipment does cause harmful interference to radio or television reception, which can be determined by tuning the equipment off and on, the user is encouraged to try and correct the interference by one or more of the following measures:

- Reorient or relocate the receiving antenna
- Increase the distance between the equipment and the receiver.
- Connect the equipment to outlet on a circuit different from that to which the receiver is connected.
- Consult the dealer or an experienced radio/TV technician for help.

FCC Caution: Any changes or modifications not expressly approved by the party responsible for compliance could void the user's authority to operate this equipment.

CAUTION: (this only applicable to 5GHz device)

This device is restricted to indoor use due to its operation in the 5.15 to 5.25 GHz frequency range. FCC requires this product to be used indoors for frequency range 5.15 to 5.25 GHz to reduce the potential for harmful interference to co-channel Mobile Satellite systems.

High power radars are allocated as primary users of the 5.25 to 5.35 GHz and 5.65 to 5.85 GHz bands. These radar stations can cause interference with and/or damage this device.

System integrators must include the FCC ID on the end product.

FCC Radio-Frequency Exposure & Approval Conditions:

1. Antennas must be installed in the display section of Netbook/notebook/laptop and tablet computer to provide separation distances as shown in the preceding drawings from the transmitting antenna to the body of user during normal operating condition.
2. Transmitting antenna(s) can only be installed at the display section of computer. When this device is installed other than notebook computers, at least 20 cm separation distance shall be maintained between the transmitting antenna(s) to the body of user or nearby person.

OEM Installation Guidance Document
For BCM WLAN Module, BCM94313HMG2L
FCC ID: QDS-BRCM1050; IC: 4324A-BRCM1050

3. The antenna(s) used for this transmitter must not be collocated or operating in conjunction with any other antenna or transmitter within a host device, except in accordance with FCC multi-transmitter product procedures.

When incorporated in a host with other transmitters, co-location considerations must also be evaluated per FCCKDB 447498, KDB 616217, and FCC KDB 616217 D03 as applicable.

- The output power of co-located Bluetooth device is far below the limit ($\leq 60/f$ (GHz)) and the antenna-to-antenna distance is ≥ 5 cm, so the Bluetooth device is not required simultaneous RF exposure evaluation in accordance with Table-2 of KDB 616217.
- Customers must conduct the required regulatory evaluation for simultaneous RF exposure with WWAN modules as “dominant transmitter”, if the platforms incorporate WWAN modules

4. Only those antennas with same type and lesser gain filed under this FCC ID number can be used with this device.

5. The regulatory label on the final system must include the statement:

“Contains FCCID: QDS-BRCM1050 and/or IC: 4324A-BRCM1050” or using electronic labeling method as documented in KDB 784748.

6. The final system integrator must ensure there is no instruction provided in the user manual or customer documentation indicating how to install or remove the transmitter module except such device has implemented two-ways authentication between module and the host system.

8. The final host manual shall include the following regulatory statement:

This equipment has been tested and found to comply with the limits for a Class B digital device, pursuant to Part 15 of FCC Rules. These limits are designed to provide reasonable protection against harmful interference in a residential installation. This equipment generates, uses, and can radiate radio frequency energy. If not installed and used in accordance with the instructions, it may cause harmful interference to radio communications. However, there is no guarantee that interference will not occur in a particular installation. If this equipment does cause harmful interference to radio or television reception, which can be determined by tuning the equipment off and on, the user is encouraged to try and correct the interference by one or more of the following measures:

- Reorient or relocate the receiving antenna
- Increase the distance between the equipment and the receiver.
- Connect the equipment to outlet on a circuit different from that to which the receiver is connected.
- Consult the dealer or an experienced radio/TV technician for help.

This device complies with Part 15 of the FCC Rules. Operation is subject to the following two conditions: (1) This device may not cause harmful interference, and (2) this device must accept any interference received, including interference that may cause undesired operation.

2. Canada - Industry Canada (IC)

Operation is subject to the following two conditions: (1) this device may not cause interference, and (2) this device must accept any interference, including interference that may cause undesired operation of this device.”

L ‘ utilisation de ce dispositif est autorisée seulement aux conditions suivantes : (1) il ne doit pas produire de brouillage et (2) l’ utilisateur du dispositif doit être prêt à accepter tout brouillage radioélectrique reçu, même si ce brouillage est susceptible de compromettre le fonctionnement du dispositif.

To reduce potential radio interference to other users, the antenna type and its gain should be so chosen that the equivalent isotropically radiated power (EIRP) is not more than that required for successful communication.

Caution: (this only applicable to UNII device)

This device is restricted to indoor use due to its operation in the 5.15 to 5.25 GHz frequency range. Industry Canada requires this product to be used indoors for frequency range 5.15 to 5.25 GHz to reduce the potential for harmful interference to co-channel Mobile Satellite systems.

High power radars are allocated as primary users of the 5.25 to 5.35 GHz and 5.65 to 5.85 GHz bands. These radar stations can cause interference with and/or damage this device.

Caution: Exposure to Radio Frequency Radiation.

To comply with RSS 102 RF exposure compliance requirements, for mobile configurations, a separation distance of at least 20 cm must be maintained between the antenna of this device and all persons. This device must not be co-located or operating in conjunction with any other antenna or transmitter.

System integrators must include the IC ID on the end product.

3. Europe - EU Restrictions

This equipment needs to be marked with the **CE 0984**  symbol and can be used throughout the European community.

Marking by the symbol  indicates that usage restrictions apply.

Information to be supplied to the users:

802.11a Restrictions:

- This product is for indoor use only when using channels 36, 40, 44, 48, 52, 56, 60, or 64 (5150–5350 MHz).

OEM Installation Guidance Document
 For BCM WLAN Module, BCM94313HMG2L
 FCC ID: QDS-BRCM1050; IC: 4324A-BRCM1050

- DFS and TPC must remain enabled to ensure product compliance with EC regulations.
- To ensure compliance with local regulations, be sure to select the country in which the access point is installed.
- This product can be used as shown in the table below:

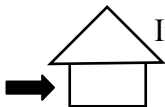
5 GHz wireless LAN IEEE 802.11a	 Indoor Use Only	A, AND, B, CH, D, CY, CZ, DK, ES, EST, F, FIN, FL, FR, GB, GR, H, I, IRL, IS, L, LT, M, MC, N, NL, P, PL, RSM, S, SK, SLO, V
------------------------------------	---	--

Caution: Exposure to Radio Frequency Radiation.

To comply with RF exposure compliance requirements, for mobile configurations, a separation distance of at least 20 cm must be maintained between the antenna of this device and all persons.

Czech:

User's Manual in Czech language and a statement of conformity with Directive 1999/5/EC in Czech language must be enclosed to each product.

France:

2.4GHz for Metropolitan France:

In all Metropolitan départements, wireless LAN frequencies can be used under the following conditions, either for public or private use:

- Indoor use: maximum power (EIRP*) of 100 mW for the entire 2400-2483.5 MHz frequency band
- Outdoor use: maximum power (EIRP*) of 100 mW for the 2400-2454 MHz band and with maximum power (EIRP*) of 10 mW for the 2454-2483 MHz band

Note for system integrators:

- The module is tested to comply with the requirement of the R&TTE Directive. System integrators are responsible for compliance of the final device with the R&TTE Directive.
- Packaging: CE Marking must also be on the outer packaging of the product. The outer packaging must also provide an indication as to where the device is intended to be used and OR conversely, where there may be restrictions for use.

4. Taiwan - NCC Statement to be included in the user guide

Statement- For general products

低功率電波輻射性電機管理辦法

第十二條經型式認證合格之低功率射頻電機，非經許可，公司、商號或使用者均不得擅自變更頻率、加大功率或變更原設計之特性及功能。

第十四條低功率射頻電機之使用不得影響飛航安全及干擾合法通信；經發現有干擾現象時，應立即停用，並改善至無干擾時方得繼續使用。前項合法通信，指依電信規定作業之無線電信。低功率射頻電機須忍受合法通信或工業、科學及醫療用電波輻射性電機設備之干擾。

Additional Statement - For 5G Band products

在5.25G ~5.35G頻帶內操作之無線資訊傳輸設備僅適於室內使用

Translation:

Article 12

Without permission, any company, firm or user shall not alter the frequency, increase the power, or change the characteristics and functions of the original design of the certified lower power frequency electric machinery.

Article 14

The application of low power frequency electric machineries shall not affect the navigation safety nor interfere a legal communication, if an interference is found, the service will be suspended until improvement is made and the interference no longer exists.

The foregoing legal communication refers to the wireless telecommunication operated according to the telecommunications laws and regulations.

The low power frequency electric machinery should be able to tolerate the interference of the electric wave radiation electric machineries and equipments for legal communications or industrial and scientific applications.

Radio devices using 5.25-5.35GHz bands are restricted to indoor use only.

Appendix:

模組認證合格標籤 (ID):

“ CCXXxxLPyyyZz ”

如果使用本模組之平台，無法在外部看見審驗合格標籤時，應在該

平台的外部明顯標示

“內含射頻模組  CCXXxxLPyyyZz” .

5. Korea

Include the following statement either on the label or in the User Guide.

"당해 무선설비가 전파혼신 가능성이 있으므로 인명안전과 관련된 서비스는 할 수 없음"

6. Argentina

The current approval is in the name of Broadcom's local representative. It may be necessary to obtain regulatory approval in the name of the local distributor or importer. We suggest manufacturers check with their local distributors and importers in Argentina.

7. Brazil - Anatel

Before using Broadcom Anatel approvals,

1. PC- OEM must make arrangement for its local offices or distributors to provide maintenance, technical assistance or replace any faulty products sold in Brazil.
2. All warranty services will be provided by the distributors or PC-OEM sales support in Brazil. An official agreement stating warranty responsibilities must be signed and made available to Broadcom.

Interference statement to be included in the Users Guide

"Este equipamento opera em caráter secundário, isto é, não tem direito a proteção contra interferência prejudicial, mesmo de estações do mesmo tipo, e não pode causar interferência a sistemas operando em caráter primário."

Translation:

"This equipment operates in secondary character. It can be affected by harmful interference. However, it cannot cause interference to systems operating in primary character."

8. South Africa – ICASA

PC-OEMs must make arrangement for importers to supply spare parts and carry out repairs in South Africa.

9. Indonesia - POSTEL

OEM Installation Guidance Document
For BRCM WLAN Module, BCM94313HMG2L
FCC ID: QDS-BRCM1050; IC: 4324A-BRCM1050

PC-OEMs must make arrangement for importers to provide product warranty and after sales services.

10. Japan – MIC

Radio devices using 5.25-5.35GHz bands are restricted to indoor use only.