

Eye Position

Keep the monitor or LCD away from your eyes by at least 50cm.



- Adjust the height of the monitor and the LCD screen so that its top height is equal to or lower than your eyes.
- Avoid setting the monitor and LCD excessively bright.
- Keep the monitor and LCD screen clean.
- If you wear glasses, clean them before using the computer.
- When entering contents printed on a paper into the computer, use a static paper holder so that the height of the paper is almost equal to that of the monitor.

Hand Position

Keep your arm at a right angle as shown by the figure.



- Keep the line from your elbow to your hand straight.
- Do not place your palm over the keyboard while typing.
- Do not hold the mouse with excessive force.
- Do not press the keyboard, touchpad or mouse with excessive force.
- It is recommended connecting an external keyboard and mouse when using the computer for long periods of time.

Volume Control (Headphones and Speakers)

Check your volume first to listen to music.



- Check if the volume is too loud before using headphones.
- It is not recommended using headphones for long periods of time.
- Any deviation from the equalizer default setting could cause hearing impairment.
- The default setting can be changed through software and driver updates without your intervention. Please check the equalizer default setting before first usage.

Use Time (Break Time)

- Take a break for 10 minutes or more after a 50-minute period when working for more than one hour.

Illumination

- Do not use the computer in dark locations. The illumination level for computer use must be as bright so for reading a book.
- Indirect illumination is recommended. Use a curtain to prevent reflection on the LCD screen.

Operation Condition



- Do not use the computer in hot and humid locations.
- Use the computer within the allowed temperature and humidity range specified in the User Guide.

Front View



- The pictures used for the cover and the main body in the User Manual are those of the representative model of each series. Therefore the colors and appearance of the pictures may differ from the actual appearance of the product depending on the model.
- The actual color and appearance of the computer may differ from the pictures used in this guide.



1	Camera Lens (Optional)	Using this lens, you can take still pictures and record video.
2	LCD	The screen images are displayed here.
3	Keyboard	A device to enter data by pressing the keys.
4	Touchpad/ Touchpad Buttons	The touchpad and touchpad buttons provide functions similar to the mouse ball and buttons.
5	Power Switch 	Turns the computer on or off.
6	Multi Card Slot  (Optional)	A card slot that supports SD Card, SDHC and MMC.
7	Microphone  (Optional)	You can use the built-in microphone.
8	Status Indicators	Shows the operating status of the computer. The corresponding operating LED is lit when the corresponding function operates.



Using the camera lens, web cam

Using the Cyberlink YouCam program (optional), you can take pictures or record video by using the computer's built-in camera by adding the balloon talk or frame effect.

Status Indicators

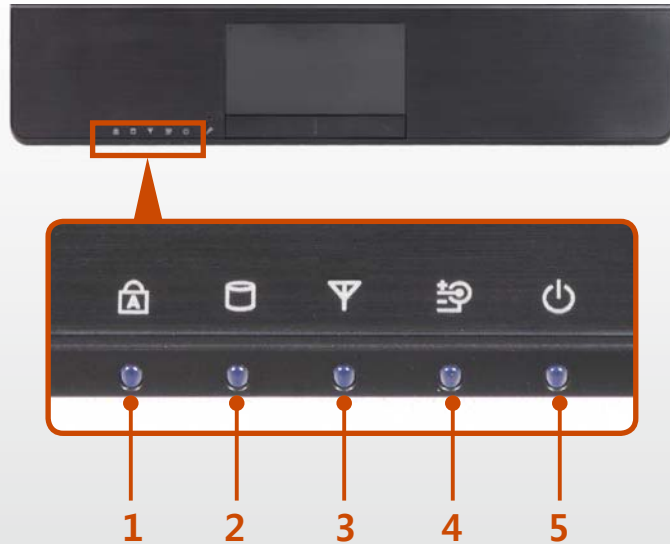

1 Caps Lock

This turns on when the Caps Lock key is pressed allowing capital letters to be typed without holding the Shift button down.

On: Upper-case alphabetic input

Off: Lower-case alphabetic input

2 HDD/ODD

This turns on when the hard disk is or ODD being accessed.

3 Wireless LAN

This turns on when the wireless LAN is operating.

4 Charge Status

This shows the power source and the battery charge status.

 **Green:** When the battery is fully charged or the battery is not installed.

 **Orange:** When the battery is being charged.

 **Off:** When the computer is running on battery power without being connected to AC adapter.

5 Power

This shows the computer operating status.

On: When the computer is operating.

Blinks: When the computer is in Sleep mode.

Right View

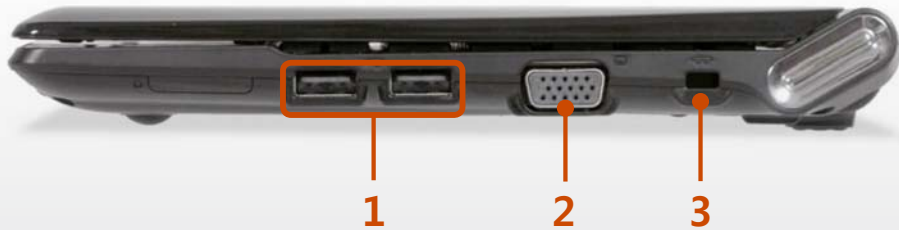

1 USB Port 

You can connect USB devices to the USB port such as a keyboard/mouse, digital camera, etc.

2 Monitor Port 

A port used to connect a monitor, TV or projector supporting a 15pin D-SUB interface.

3 Security Lock Port 





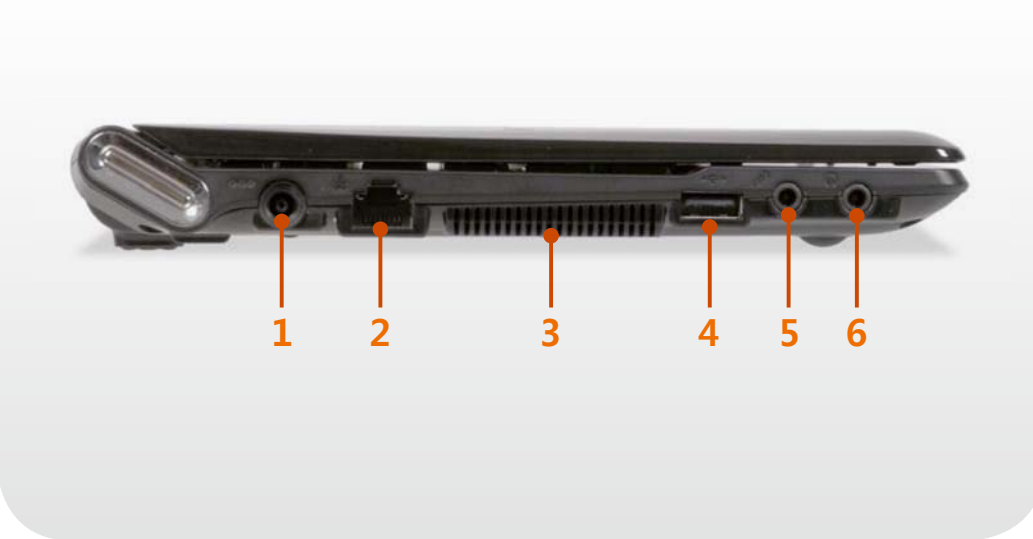





You can connect a Kensington lock to the Security Lock Port to prevent the computer from being stolen.

Left View



What is a chargeable USB port?

- USB device accessing and charging functions are supported.
- The USB charging function is supported regardless of whether the power is turned on or off.
- To use a USB port as a chargeable USB port, click **Start > All Programs > Samsung > Chargeable USB** and turn it **On**.
- Charging a device through a chargeable USB port may take longer than general charging.

1 DC Jack 	A jack to connect the AC adapter that supplies power to the computer.
2 Wired LAN Port 	Connect the Ethernet cable to this port.
3 Fan Vents	The internal heat of the computer is emitted through these holes.  If the vents are blocked the computer may overheat. Avoid blocking the vents as this may be dangerous.
USB Port  or 4 Chargeable USB Port (Optional) 	USB ports to which you can connect USB devices as well as a chargeable USB port are provided. Using a chargeable USB port, you can access or charge a USB device.  The port can be distinguished by the figure ( or ) printed on the port of the product.
5 Microphone Jack 	A jack used to connect the microphone.
6 Headphone Jack 	A jack used to connect the headphones.

Back View



1 Battery

This is a Lithium-Ion rechargeable battery that supplies power to the computer.

Bottom View

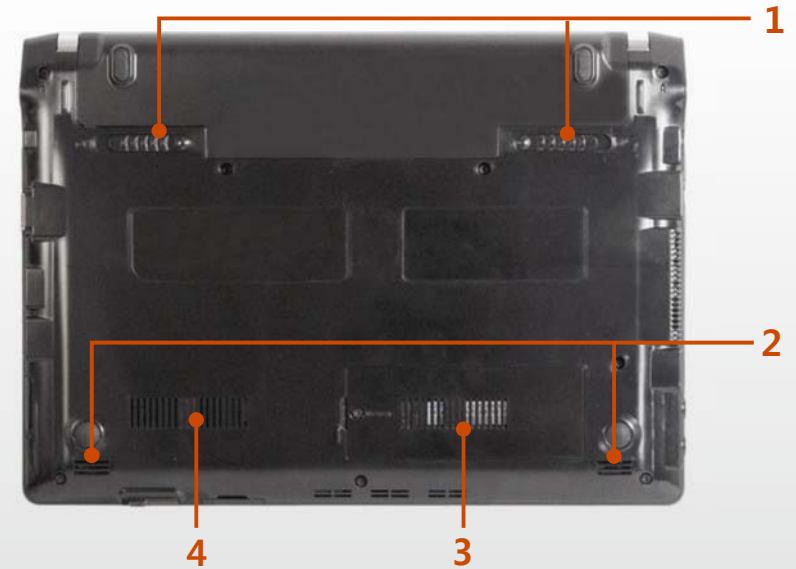

1 Battery Latches

The latch used to remove or install the battery.

2 Speaker

A device used to generate sound.

3 Memory Compartment Cover

The main memory is installed inside the cover.

4 Fan Vents

The internal heat of the computer is emitted through these holes.

! If the vents are blocked the computer may overheat. Avoid blocking the vents as this may be dangerous.

Turning the computer on

- 1 Install the **battery** and connect the **AC adapter**.
- 2 Lift the LCD panel up.
- 3 Slide the **Power Switch** to turn the computer on.



About Windows Activation

When you turn the computer on for the first time, the Windows activation screen appears.

Follow the activation procedures according to the instructions on the screen to use the computer.

Entering Sleep mode

When the computer is turned on, press the computer's power button once briefly.

Adjusting the screen brightness

When the computer runs on battery power, the LCD brightness is automatically set to low.

Press the **Fn** +  key combination to increase the screen brightness.

Turning the computer off



- Since the procedures to turn the computer off may differ depending on the installed operating system, please turn the computer off according to the procedures for the purchased operating system.
- Save all your data before clicking on **Shut down**.

► For Windows 7

Click **Start**  > **Shut down mode**  to shutdown the computer.

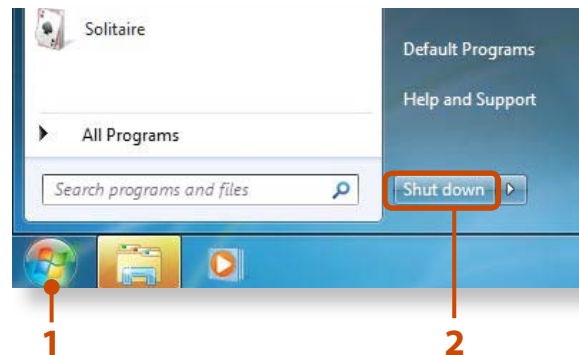

► For Windows XP

- 1 Click the **Start**  button on the taskbar. Click **Turn Off Computer**.

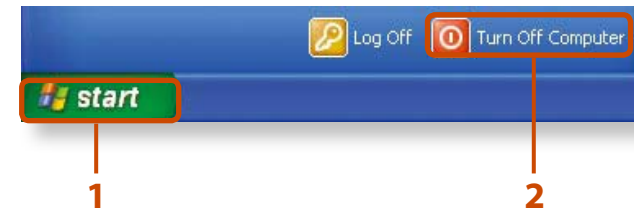

- 2 Click **Turn Off**.

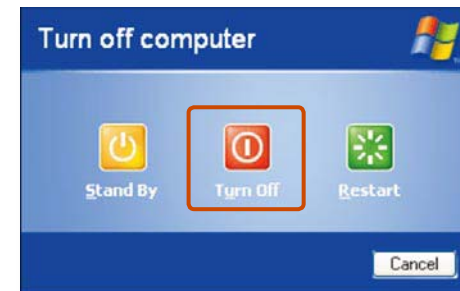



If the system cannot be shut down due to a system error, turn it off by pressing and holding the Power Button for a minimum of 4 seconds.

Please note that turning the computer off by this method may cause a system problem. Thereafter, when turning the computer back on, the disk checking program may launch to check for and correct any disk errors.

Turning the Computer On and Off

Samsung Fast Booting

If you are using the system very often while on the move, use **Fast Booting** to reduce the booting time.

With Fast Booting active, the system will switch to hybrid power saving mode if you close the LCD panel, slide the **Power Switch**  into the on position, or press the  +  key.

In hybrid saving mode, the data you are working on will be saved to memory and the HDD, in the event of a sudden power failure, ensuring the safety of your data.

However, as unexpected accidents can always occur, it is recommended backing up any important data beforehand.

Using Fast Booting

- 1 From your desktop, double-click the **Fast Booting** icon . (If the program icon does not exist on the Windows Desktop, select the corresponding program from **Start > All Programs > Samsung**.)
- 2 Select **ON** or **OFF** depending on your requirements, and click **OK**.

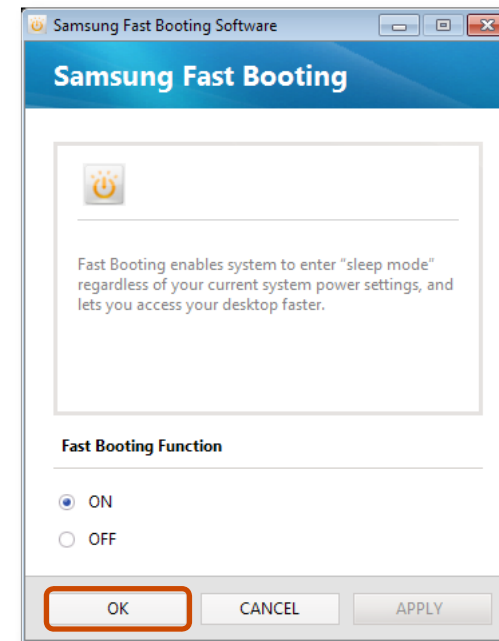

- 3 The Fast Booting function will be turned on or off according to your selection.



While the Fast Booting function is enabled

- You cannot change some power options in the Control Panel. To change these, first disable the Fast Booting function.
- The existing power saving mode and maximum power saving mode functions have been replaced by this function.

The LCD may flicker once if the Fast Booting function is turned ON or OFF.



Chapter 2. Using the computer

Keyboard	32
Touchpad	36
External-type CD drive (To be purchased)	40
Multi Card Slot (Optional)	42
Connecting an External Display Device (Optional)	45
Connecting an External Digital Device	47
Adjusting the Volume	48
Wired Network	52
Wireless Network (Optional)	56
Sharing Content in a Home Network (Easy Content Share) (Optional)	59

Shortcut key functions and procedures are discussed in the following sections.

















- The keyboard image may differ from the actual keyboard.
- The keyboard may differ depending on your country. The following mainly describes the shortcut keys.





Shortcut Keys

You can use the following functions by pressing the keys below with the **Fn** key.



Shortcut Keys	Name	Function
 + 	REST (Sleep Mode)	Switches to Sleep mode. To wake the computer up, press the Power button.
 + 	Gauge	Shows the remaining battery charge. You can only use this function when the Easy Display Manager program is installed.
 + 	Euro	Enters the Euro monetary unit symbol. This key may not be provided depending on the keyboard type.
 + 	CRT/LCD	Switches the screen output to the LCD or external monitor when an external monitor (or TV) is connected to the computer.

Shortcut Keys	Name	Function
	Backlight	Turns the LCD backlight on or off.
	Mute	Mutes or cancels mute.
	Samsung Support Center	<p>System diagnosis, recovery and Internet consultation program, Samsung Support Center, will be launched. (Optional)</p> <p> For some models, Samsung Magic Doctor is launched.</p>
 + 	Easy SpeedUp Manager	<p>You can select operation mode when you need maximum system performance or low-noise/low power consumption with one-click.</p> <ul style="list-style-type: none"> • Silent: Low-noise and low power consumption mode • Normal: Normal Mode • Speed: Maximum performance mode. The system operates in its maximum performance, and system resources are allocated to the currently active program with priority for maximum performance. • Speed Boot: Quick booting mode. This mode enables quick booting when the booting process has slowed down because multiple programs have been installed. You can boot up the computer more quickly by setting the time to execute the S/W in the Advanced menu. <p> If you don't want fan noise turning ON and OFF in the Silent mode, select the Advanced menu > Fan Silent Mode > Low in the BIOS Setup. The fan keeps turning ON and works in Low noise mode.</p> <ul style="list-style-type: none"> • You can only use this function when the Easy SpeedUp Manager program is installed.

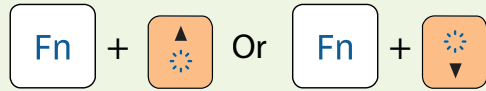

Shortcut Keys		Name	Function
Fn +		Wireless network	Turns on or off wireless network device in a model equipped with wireless network device.
		Touchpad	Turns the Touchpad function on or off. When using an external mouse only, you can turn the Touchpad off.
		Num Lock	Turns the numeric keyboard on or off.
		Scroll Lock	If you turn the Scroll Lock on, you can scroll the screen up or down without changing the cursor location in some applications.

Screen Brightness Control



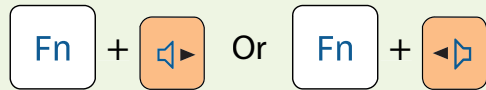

Volume Control



Alternatively, press the  +  key combination to turn the volume on or off.

Numeric Key

The numbers are printed in blue on the numeric keys.

If Num Lock is turned on by pressing the  +  key combination, you can use the numeric keys to enter digits.

Other Function Keys

Performs the right-click mouse function (touchpad).



When the shortcut key function does not work properly, you have to install the following program.

- **Windows 7:** Easy Display Manager
- **Windows XP:** Easy Display Manager, Easy SpeedUp Manager

When the programs are not installed, select **Samsung Recovery Solution > System Software** to install the programs.

(Only for models supplied with Samsung Recovery Solution.)

The touchpad provides the same function as a mouse and the left and right buttons of the touchpad plays the role of the left and right buttons of a mouse.



- Use the Touchpad with your fingers. Using a sharp object may damage the Touchpad.
- If you touch the Touchpad or press the Touchpad buttons while booting up, the Windows boot time may be extended.

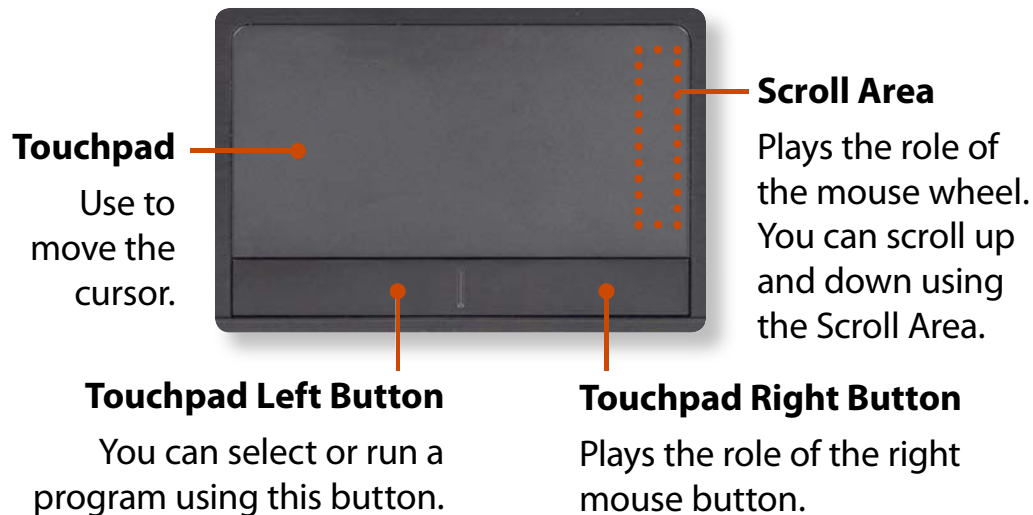

Basic Touchpad Functions

Moving the cursor on the screen

Place your finger on the touchpad slightly and move your finger. The mouse cursor will move accordingly. Move your finger in the direction you wish to move the cursor.

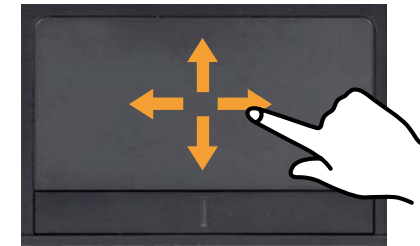

Click Function

Place a finger on the touchpad and click on an item once. Alternatively, press the left button once quickly and release it.

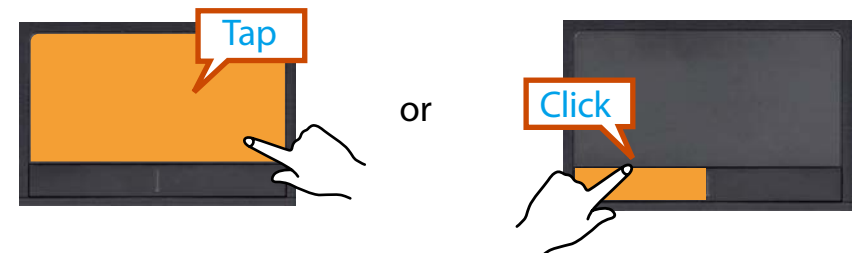

Double-Click Function

Put your finger on the touchpad and quickly tap twice with your finger on an item you want.

Alternatively, press the left touchpad button twice quickly.

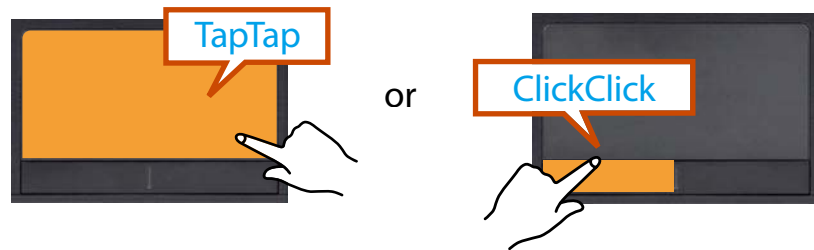

Right Button Function

This corresponds to clicking the right mouse button.

Press the right touchpad button once. The corresponding pop-up menu appears.

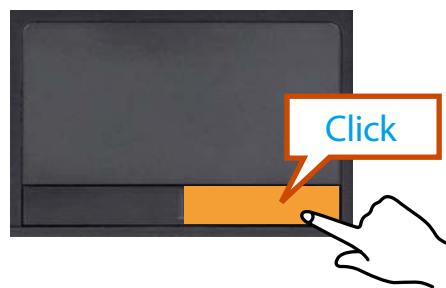

Drag Function

Dragging refers to moving an item to another place after selecting it.

Press and hold down the left touchpad button over an item you want to drag and move the item to the new location.

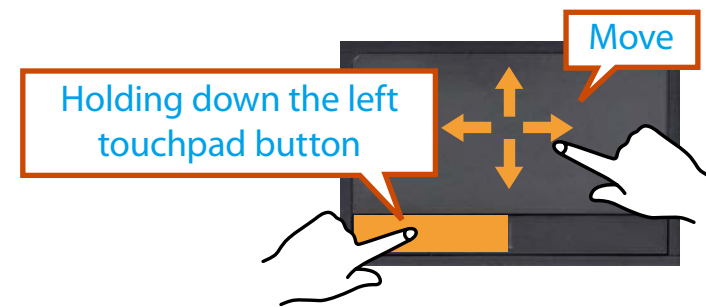

Touchpad Scroll Function

The touchpad scroll area provides the mouse wheel function (scroll function).

Place your finger on the touchpad's right edge for vertical scrolling or the bottom edge for horizontal scrolling and then move your finger along the edge to scroll the screen vertically or horizontally.



The Gesture Function of the Touchpad (Optional)



- The Touchpad Gesture function may not be provided and the version of the function may differ depending on the model. Some usage procedures may differ depending on the version.
- For detailed usage procedures, refer to the description in the Touchpad Settings window.
- Since these descriptions are written on the basis of the latest operating system, Windows 7, some of the content and the figures of the descriptions may differ depending on the operating system. Since the procedures for other Windows operating systems are similar, use the computer referring to these descriptions.

Using the Touchpad, you can use the following additional Gesture functions.

- **Scroll function**
- **Zoom functions**
- **Rotation function**
- **Move function**

The Scroll Function

This function is the same as the scroll area of the Touchpad.

If you place two fingers over the Touchpad and move them up or down, the screen is scrolled up or down.

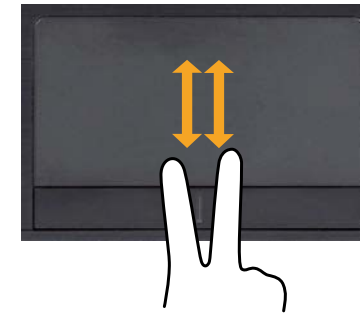

Zoom Functions

If you place two fingers over the Touchpad together or apart, the current image or text is zoomed in or out.

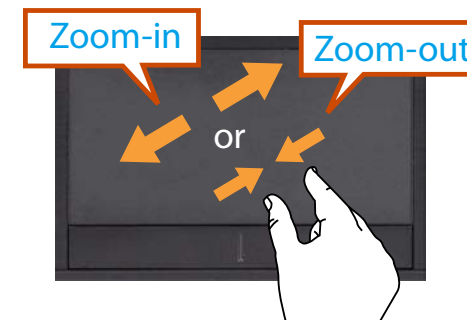

Rotation function

Place two fingers over the touchpad and move the fingers as follows to rotate the photo or image.

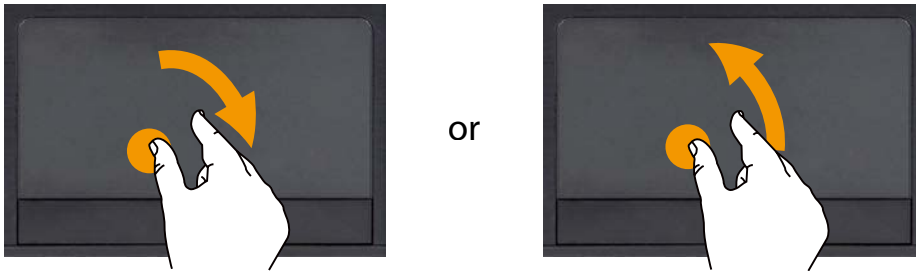

Move function

You can move to the previous or next page when you are looking at a photo or surfing the Internet.

For example, if you lightly brush three fingers to the left while you are looking at a web site, you will return to the previous page.

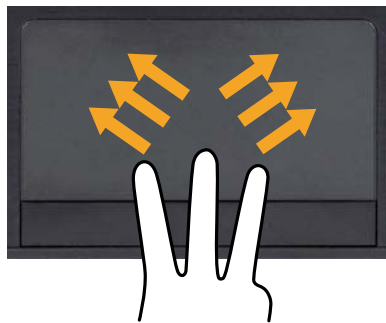

Configuring the Gesture Function

If the Gesture function is not activated, you can activate it according to the following procedures.

- 1 Click the **Start > Control Panel > Hardware and Sound > Mouse > Device Settings** tab > **Settings** button.
Alternatively, click the **Start > Control Panel > Hardware and Sound > Mouse > ELAN > Options** button.
- 2 The Touchpad Settings window appears. Click over the corresponding item to select the item in the **Select an item** and click **OK**.



To cancel the Gesture function, unselect the corresponding item in the Touchpad Settings window and click **OK**.

Touchpad On/Off Function

If you want to use the mouse only without using the touchpad, you can turn the touchpad off.

To lock the touchpad function, press the **Fn** + **F10** keys.



You can set the touchpad and touchpad button settings in the tabs that appear when clicking **Start > Control Panel > Hardware and Sound > Mouse**.

This computer supports an external USB CD-ROM drive (can be additionally purchased).

Check if the interface type of the external CD-ROM drive is a USB type. For detailed specifications, refer to the catalog.



- Do not insert a cracked or scratched CD. Otherwise, the CD may break and damage the optical disk drive when the CD rotates at a high speed.
- When you clean a CD or DVD title, wipe with a soft cloth from inside to outside.
- Do not eject a CD when the CD operating LED is on.
- The figures used for the description are of a representative model. Therefore the figures may differ from the real ones.
- Using a CD that is not in the shape of a circle is not recommended.

Connecting the CD Drive

Connect the CD drive to the **USB port**.



Inserting and Ejecting a CD

- 1 Press the **Eject** button of the CD drive.

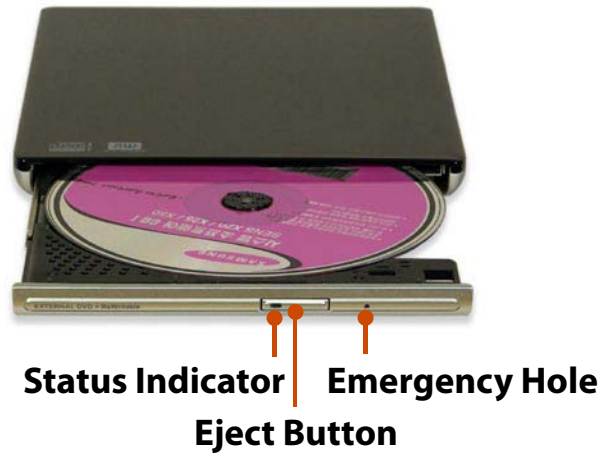

- 2 When the CD tray opens, insert a CD or DVD and push the tray in until it clicks.
- 3 Push the CD tray inward until it clicks.
The CD drive status indicator is turned on.



- A CD drive's reading and writing speed may differ depending on the condition and type of the media.
- To eject a CD when the CD drive does not work or the computer is off, place the end of a paper clip () into the Emergency Hole until the CD tray is ejected.

Using the multi card slot, you can read and write data to a SD card, SDHC card, MMC card.

You can use a card as a removable disk and conveniently exchange data with digital devices such as a digital camera, digital camcorder, MP3, etc..



- Supported Cards : SD Card, SDHC card, MMC
- You have to additionally purchase a multi card with the necessary capacity depending on your requirements.
- You can use a multi card just like any data storage device. A copyright protection function is not supported.
- Since you can lose a card when moving the computer, keep the card separately.
- The figures used for the description are of a representative model. Therefore the figures may differ from the real ones.
- If a slot protection dummy card is inserted into your computer, remove the dummy card before using the computer.
- These descriptions are written based on Windows 7, the latest operating system. Therefore, some descriptions and figures may differ from your operating system. But as the usage is similar to other Windows operating systems, you can use these descriptions for reference.

Using the card

- 1 Insert a card into the slot according to the directions printed on the slot.



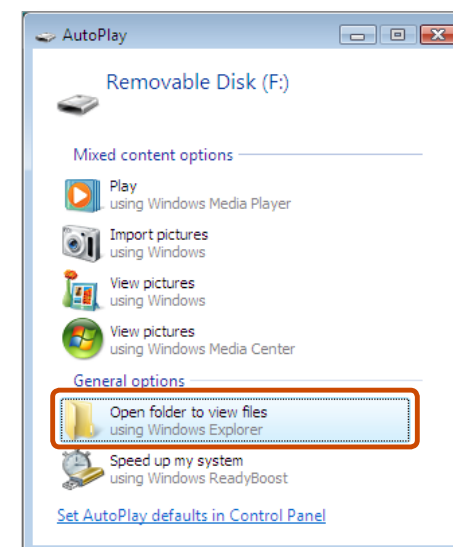

- 2 The card drive appears. Click **Open folder and view files**. If the window does not appear, click **Start > Computer**.

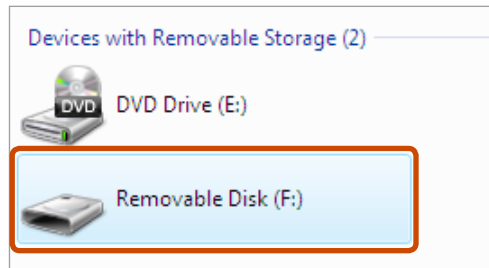

 If a window asking to scan and change appears, click **Continue Without Scanning**. This will proceed to Step 2 above.

3 You can save, move and delete data by double-clicking the corresponding drive.



 The device name of the card drive may differ depending on your computer model.

You can only use the card after formatting it.

Using a Mini SD and RS-MMC

Since the above cards are too small, you cannot insert the cards into the slot directly.

Insert the card into the dedicated adapter (available from most electronic retailers) and then insert the adapter into the multi card slot.

However, depending on the adapter's body material, some RS-MMC cards may not be recognized properly. Samsung recommend that you check the card is recognized correctly prior to purchasing.

To remove a memory card

Take hold of the end of the card and remove the card.

To format a memory card

When using the memory card for the first time, you must format the card before using it.

 Formatting a card deletes all data saved on the card. If the card includes data, backup the data before formatting it.

- 1 Click **Start** > **Computer**.
- 2 Right-click over a card drive with the touchpad and select **Format**.
- 3 Click **Start** to the formatting.



- To use a card to exchange data with a digital device such as a digital camera, formatting the data using the digital device is recommended.
- When you try to use a card, which is formatted in the computer, in another digital device, you may have to format the card again in the device.
- You cannot format, write or delete data from a SD, or SDHC card with a write protection tab when it is in the Lock position.
- Inserting and removing a memory card repeatedly may damage the memory card.

If you connect an external display device such as a monitor, TV, projector, etc., you can view the picture on the wider screen of the external device when you give a presentation or watch a video or movie.

The computer provides an analog monitor port (RGB) and a digital video/audio port (HDMI).

The visual quality is sharper when a display device is connected through the HDMI port rather than the analog monitor port (RGB) port. Therefore, when multiple ports are supported, connect a display device to a port that provides the better visual quality.



- Before you start, check the port and cable of the external display device and then connect the display device to the computer.
- Due to restrictions of the operating system the DualView function is not supported for Windows 7 Starter.

About the connection cable

Users should additionally purchase the necessary connection cables.

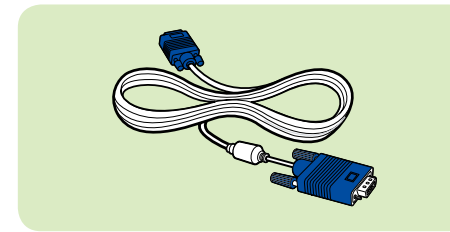

Analog Monitor (RGB) Cable

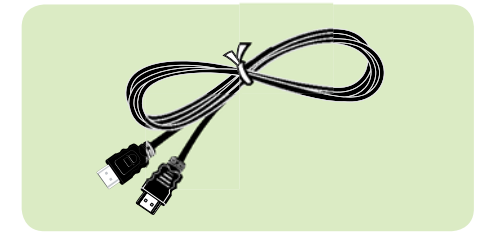

HDMI Cable

Connecting to the monitor port



You can experience a wider screen by connecting the computer to a monitor, TV or projector with a monitor port.

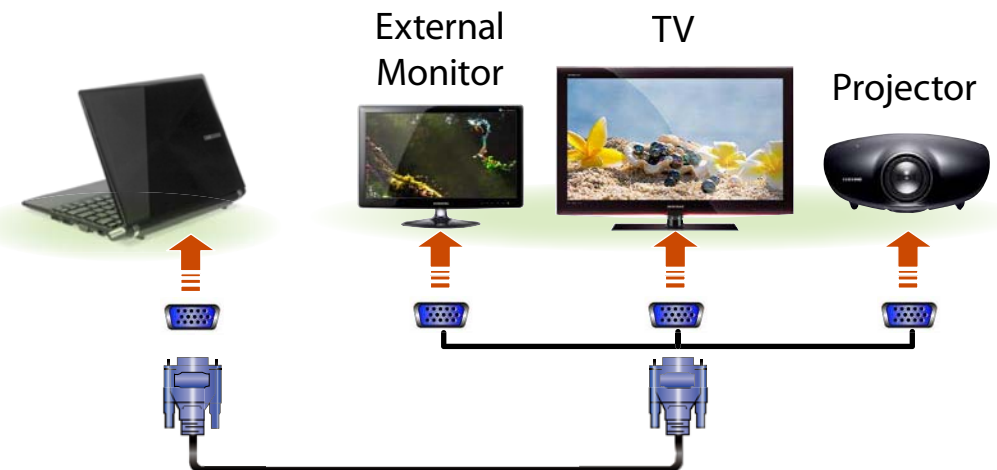

You can give better presentations by connecting the computer to a projector.

- 1 Connect the RGB port of the computer and the port of the monitor or TV with the monitor cable (15 pin).





2 Connect the power cord of the connected monitor, TV or projector and turn the power on.

3 Press the  +  key combination once. Then the Easy Display Manager screen appears where you can select a display device.

Since pressing the  key while holding down the  key changes the selection, select a display device.

LCD		
CRT		
LCD + CRT Clone		
LCD + CRT DualView		



If you cannot select a display device by pressing the  +  key combination, you have to install the following programs depending on your Windows version.

- **Windows 7/XP:** Easy Display Manager

Install the programs by downloading them from the website or using the Install **System Software menu** of the Samsung Recovery Solution.

• **Alternatively, to set up dual view:**

Open the **Display Settings** window in the Control Panel, select **Monitor 2** and select the **Expand to fit to this monitor** checkbox to set dual view. For more detailed information, refer to the Windows online help.

You can save a file stored on a device onto the computer by connecting a digital device such as a camera, camcorder or mobile phone to the computer and using the file management functions.

Connecting and using a camera or camcorder

If a digital device such as a camera or camcorder is connected with the computer, it is recognized as a removable disk so that you can copy or move the files on the device.

1 Connect the USB port of the notebook computer and the USB port of the digital device such as a camera using the USB cable.



- Both the computer and the digital device must be turned on.
- You have to additionally purchase the USB cable necessary to connect the computer and the device.



2 The **Auto run** window appears. Click **Open folder and view files**.

If the window does not appear, click **Start > Computer**.

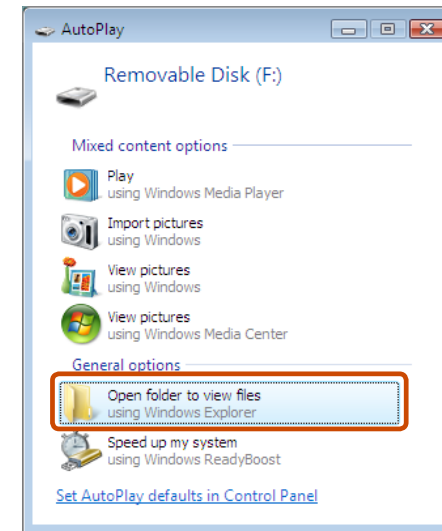

3 Double-click the corresponding drive. You can then save, move or delete data.



The device name of the card drive may differ depending on the model.

You can adjust the volume using the keyboard and the volume control program.



Since these descriptions are written on the basis of the latest operating system, Windows 7, some of the content and the figures of the descriptions may differ depending on the operating system.

Since the procedures for other Windows operating systems are similar, use the computer referring to these descriptions.

Adjusting the Volume using the Keyboard

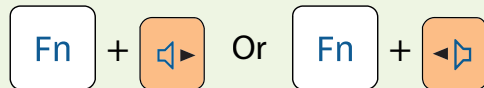

Alternatively, press the **Fn** + **F6** key combination to turn the volume on or off.

Adjusting the Volume using the Volume Adjustment Program

Click the Volume icon  on the taskbar and slide the volume control bar to adjust the volume.

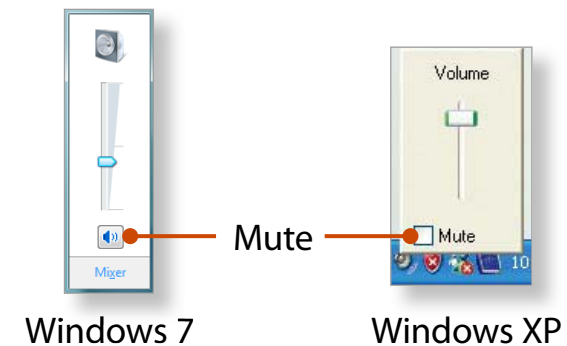

Using the Sound Recorder

The procedures to record sound using the Windows Recorder are described below.

► For Windows 7

- 1 Connect a microphone to the microphone jack.
You can also use the internal MIC.
- 2 Right-click over the **Volume** icon  on the taskbar and select **Recording Device**.

- 3 Check if the microphone is set as the default recording device.

If this is the case, it is already set as the default device. If not, right-click over the microphone and select **Set default**.

- 4 Click **Start > All Programs > Accessories > Sound Recorder** and click **Start recording** to start a recording.

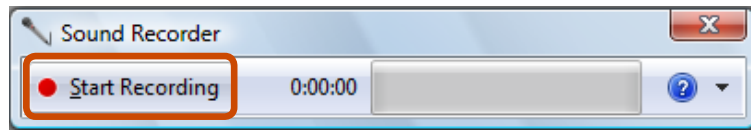

► For Windows XP

- 1 Connect a microphone to the microphone jack.
You can also use the internal MIC.
- 2 Click **Start > Control Panel > Sounds, Speech, and Audio Devices > Sounds and Audio Devices**.
- 3 Click **Advanced** from Volume and then, click **Options > Properties**.

- 4 Select **Realtek HD Audio input** from the mixer device to select **Recording** from **Adjust Volume for**.

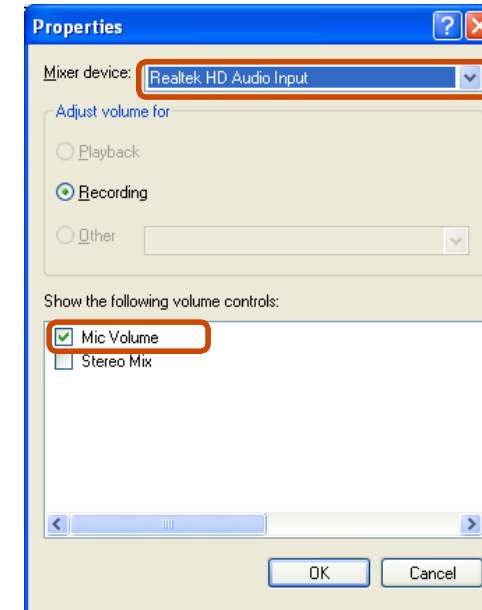

- 5 Select **Mic Volume** from **Show the following volume controls** and click **OK**.
- 6 When **Recording Control** window appears, check the **Select** checkbox.
Increase the **recording** volume to increase the recording sensitivity and close the window.
- 7 Click **Start > All Programs > Accessories > Entertainment > Sound Recorder**.

- 8 Click the **Record** button to perform recording.



The default recording duration of Windows XP is 60 seconds. Download a dedicated recording program from the Internet to record audio data for a long time.

Using SRS

The SRS function enables you to experience more stereophonic sound using stereo speakers.



- The software programs provider may vary, depending on your computer model.
- In addition, some pictures may differ from actual product depending on the computer model and software version.

► For Windows 7

- 1 Right-click over the **Volume** icon  in the Taskbar and select **Playback Devices (P)**.
- 2 Select **Speakers** in the **Playback** tab and click **Properties**.
- 3 Select the **SRS** tab in the **Speaker Properties** window. Select a mode and click the **Use** checkbox on the left. Click **OK**. You will be able to experience a more stereophonic sound in the selected mode.

