



INSTRUCTIONS

Congratulations on your choice of the Zenza Bronica GS-1, a lens shutter type single lens reflex camera in the 6x7 format.

The GS-1 provides the professional user with a lightweight and compact 6x7 format single lens reflex of extremely useful versatility and multi-functional performance, which is based on the history and experience gained in the development of the Zenza Bronica ETRS and SQ-A single lens reflexes, as well as the latest technological advances in the electronic field.

The GS-1 has been developed as a full-scale system camera, with a wide range of versatile accessories and especially with complete film back interchangeability which gives it multi-format capability for use in a wide field of applications, including commercial photography, news photography, scientific photography, etc., as well as giving this 6x7 format single lens reflex versatility equal to the 35mm single lens reflex camera.

Although instructions following are based on the GS-1 camera main body, the Zenzanon-PG 100mm lens and the Film Back GS 120, the choice of finder is left to the discretion of the photographer who should also read the instructions for the finder chosen. The choice of lens, film back and finder should be based on the type of assignment contemplated by the user.

To obtain best results from the Zenza Bronica GS-1, may we suggest that you read this instruction manual through carefully, before you even touch the camera, as your pleasure in using the camera will be even greater if you thoroughly familiarize yourself with its working parts before loading your first roll of film.

# CONTENTS

Specifications of the Zenza Bronica GS-1 . . . . .	2	18. Setting the Aperture Ring . . . . .	23
Parts of the Zenza Bronica GS-1 . . . . .	4	19. Focusing Adjustments . . . . .	24
1. Loading the Battery . . . . .	7	20. Distance Scale and Depth of Field Scale . .	25
2. Main Switch . . . . .	8	21. Infrared Photography . . . . .	25
3. Finder Display and Battery Checking . . . . .	8	22. Flash Photography . . . . .	26
4. Attachment and Removal of Film Backs . .	9	23. Multiple Exposures . . . . .	27
5. Construction of Film Back . . . . .	11	24. Mirror Lock-Up . . . . .	28
6. Film Loading . . . . .	11	25. Remote Control Operations . . . . .	30
7. Film Speed Dial . . . . .	15	26. Interchanging Focusing Screens . . . . .	30
8. Exposure Compensation Dial . . . . .	15	27. Removal and Attachment of the Film Winding Crank Assembly . . . . .	32
9. Film Type Indicator Frame . . . . .	16	28. Attachment of the Neck Strap . . . . .	33
10. Exposure Counter . . . . .	16	29. Facts about the Battery . . . . .	34
11. Film Winding/Shutter Cocking . . . . .	17	30. Pointers on Shooting . . . . .	35
12. Film Unloading . . . . .	17	31. Care of the Zenza Bronica GS-1 . . . . .	35
13. Setting the Shutter Speed Dial . . . . .	18	32. Depth of Field Tables . . . . .	37
14. Shutter Release Button . . . . .	20	33. Specifications of Zenzanon-PG Lenses . . .	38
15. Time (T) Exposure . . . . .	21		
16. Exchanging Lenses . . . . .	22		
17. Interchanging Finders . . . . .	23		

## Specifications of the Zenza Bronica GS-1

Type	6 x 7 cm format lens shutter single lens reflex camera, with interchangeable lens, film back, finder and focusing screen systems.
Frame size	55.6 x 69.0 mm (4:5 ratio matching the size of the photographic paper).
Film	120 roll film; 220 roll film; 135 roll film in film cartridges; and Polaroid Land Pack films (with exclusive film backs required for each film type).
Standard lens	Zenzanon-PG 100mm F3.5; interchangeable type; six elements in four groups; multi-layer anti-reflection coated; 48° angle of view; F22 minimum aperture; and minimum 0.75m focusing distance.
Filter size	72mm diameter on 100mm F3.5 standard lens.
Lens mount	Bronica GS mount (exclusive four-claw bayonet).
Focusing adjustment	Helical focusing system built into each lens.
Lens diaphragm	Fully automatic instant reopening lens diaphragm; 1/2 stop increments; equal-distant aperture scale graduations.
Shutter	Electronic control SEIKO #0 between-lens leaf shutter; shutter speeds from 16 sec. to 1/500 sec., without intermediate settings, plus T (time exposure), B (bulb) and A (automatic exposure).
Shutter release	Electro-magnetic shutter release system; also has electro-magnetic cable release system.
Film winding	Film winding crank, with one full forward revolution or ratcheted winding action.
Multiple exposure	Multiple exposure possible with multiple exposure lever on camera body.
Mirror lock-up	Continuous mirror lock-up possible with mirror lock-up lever on camera body.
Film back	Daylight loading interchangeable type; exclusive film backs for 120 and 220 roll films (6x7, 6x6 and 6x4.5 formats), 135 roll film (24x36 and 24x69 formats) and Polaroid Land Pack film; with ASA/ISO film speed dial and exposure compensation dial (coupling to finders with built-in exposure meter).
Finder	Interchangeable type; shows 94% of the actual field of view (which does not change upon exchanging finders).

<b>Focusing screen</b>	Interchangeable type; standard type, supplied with camera, has full-area matte screen.
<b>Finder indications</b>	Shutter speed, etc., is shown at the top of the finder area, outside the screen area; 5 digits, 7 segments and dot indication, depending on finder attached.
<b>Flash synchronization</b>	X-setting (for all speeds up to 1/500 sec.); automatic flash control, with direct exposure metering of film surface is possible (with exclusive dedicated electronic flash unit).
<b>Battery checking</b>	Steady illumination or flickering of shutter speed display in finder, with half-stroke of the shutter release button.
<b>Battery</b>	Single 6 volt silver oxide or alkaline-manganese battery.
<b>Dimensions</b>	106.5 (wide) x 99 (high) x 80 (long) mm – GS-1 main body only. 106.5 (wide) x 116 (high) x 196.5 (long) mm – GS-1, with standard 100mm lens, Film Back GS 120 and Waist-level Finder G.
<b>Weight</b>	630 grams (GS-1 main body only, without battery). 1,830 grams (GS-1, with standard 100mm lens, Film Back GS 120 and Waist-level Finder G but without battery).

The above specifications are subject to changes without prior notice when necessary for the purpose of improving performance.

# Parts of the Zenza Bronica GS-1

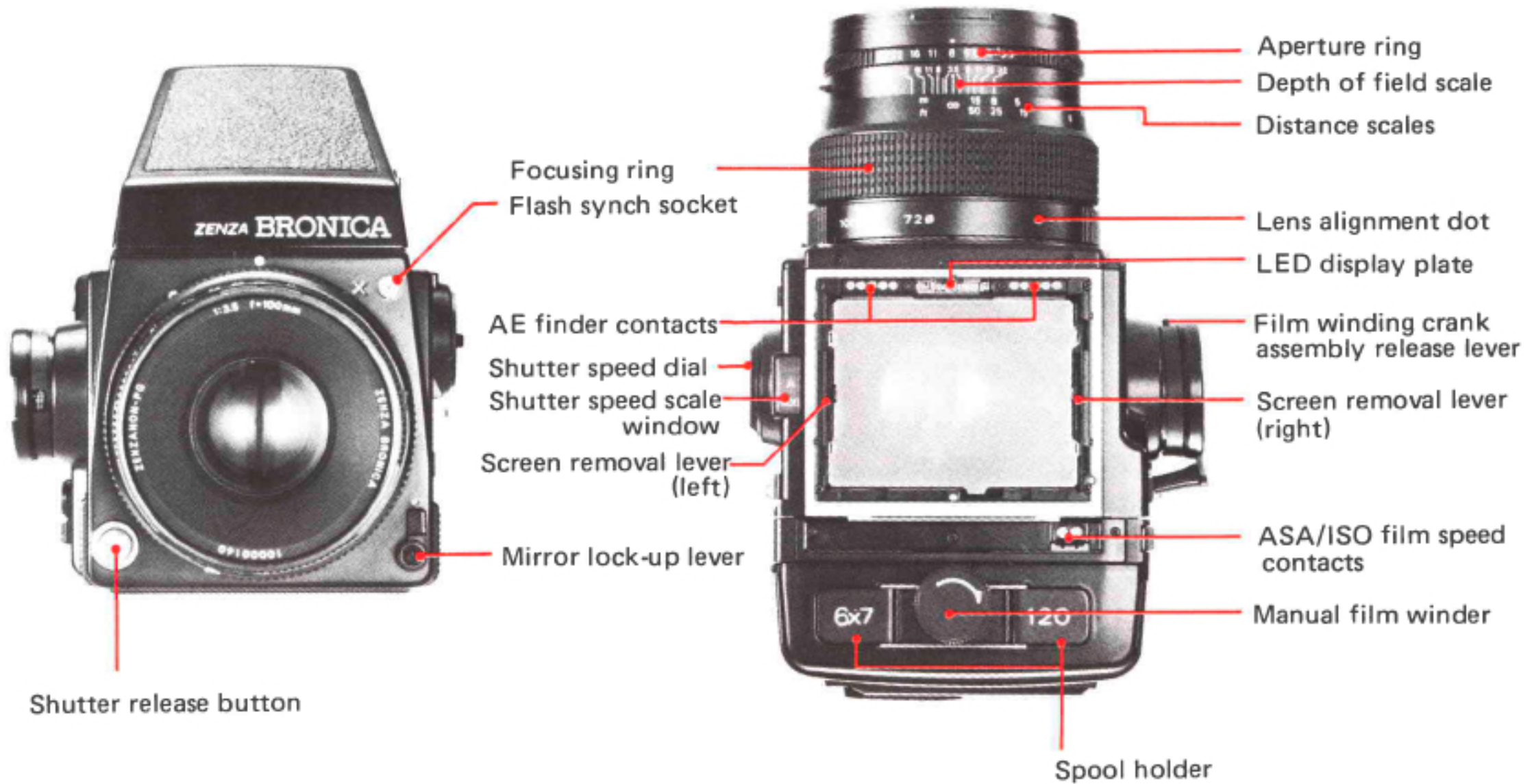

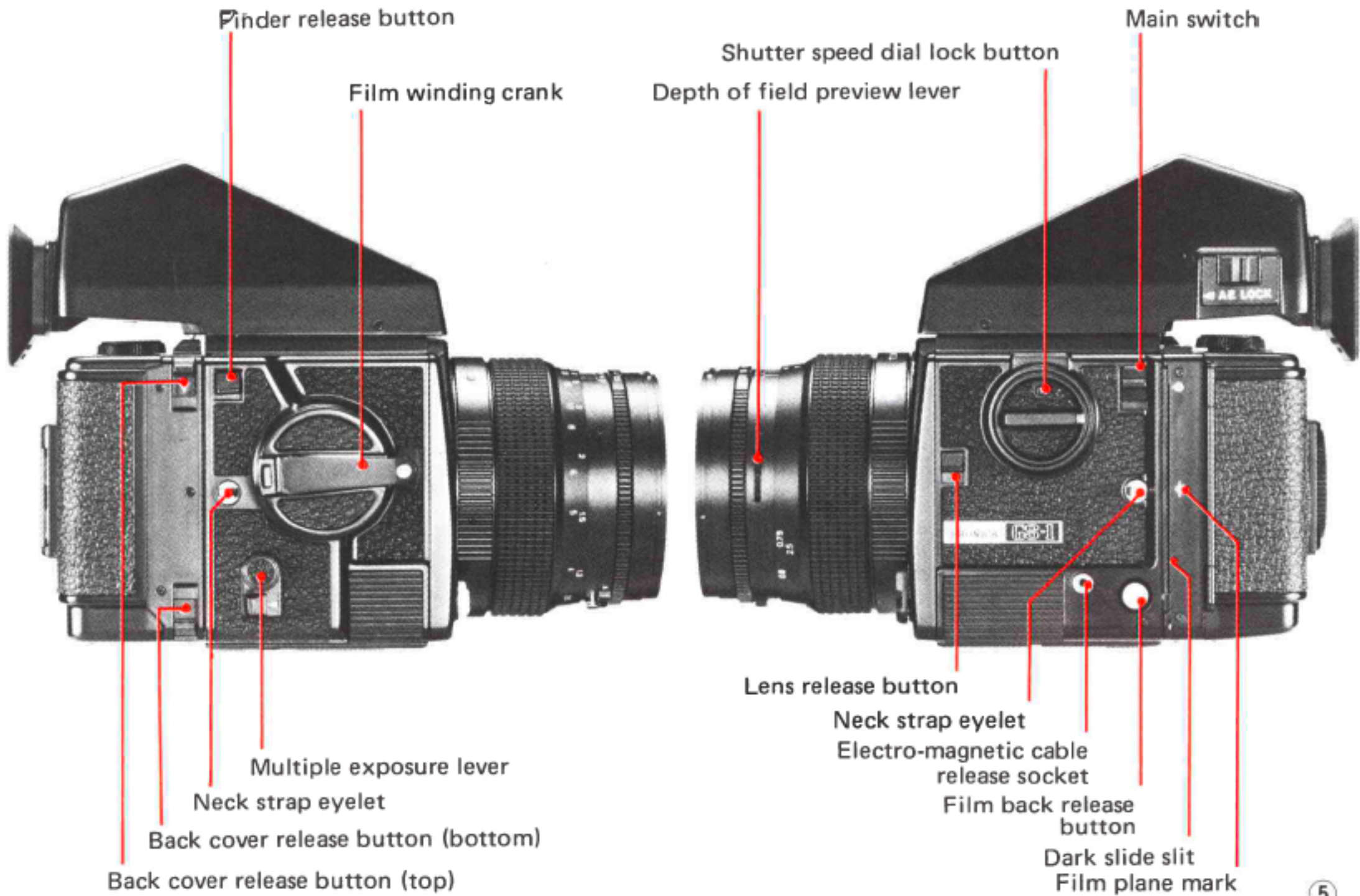

Finder release button

Film winding crank

Shutter speed dial lock button

Depth of field preview lever

Main switch

Multiple exposure lever

Neck strap eyelet

Back cover release button (bottom)

Back cover release button (top)

Lens release button

Neck strap eyelet

Electro-magnetic cable  
release socket

Film back release  
button

Dark slide slit

Film plane mark

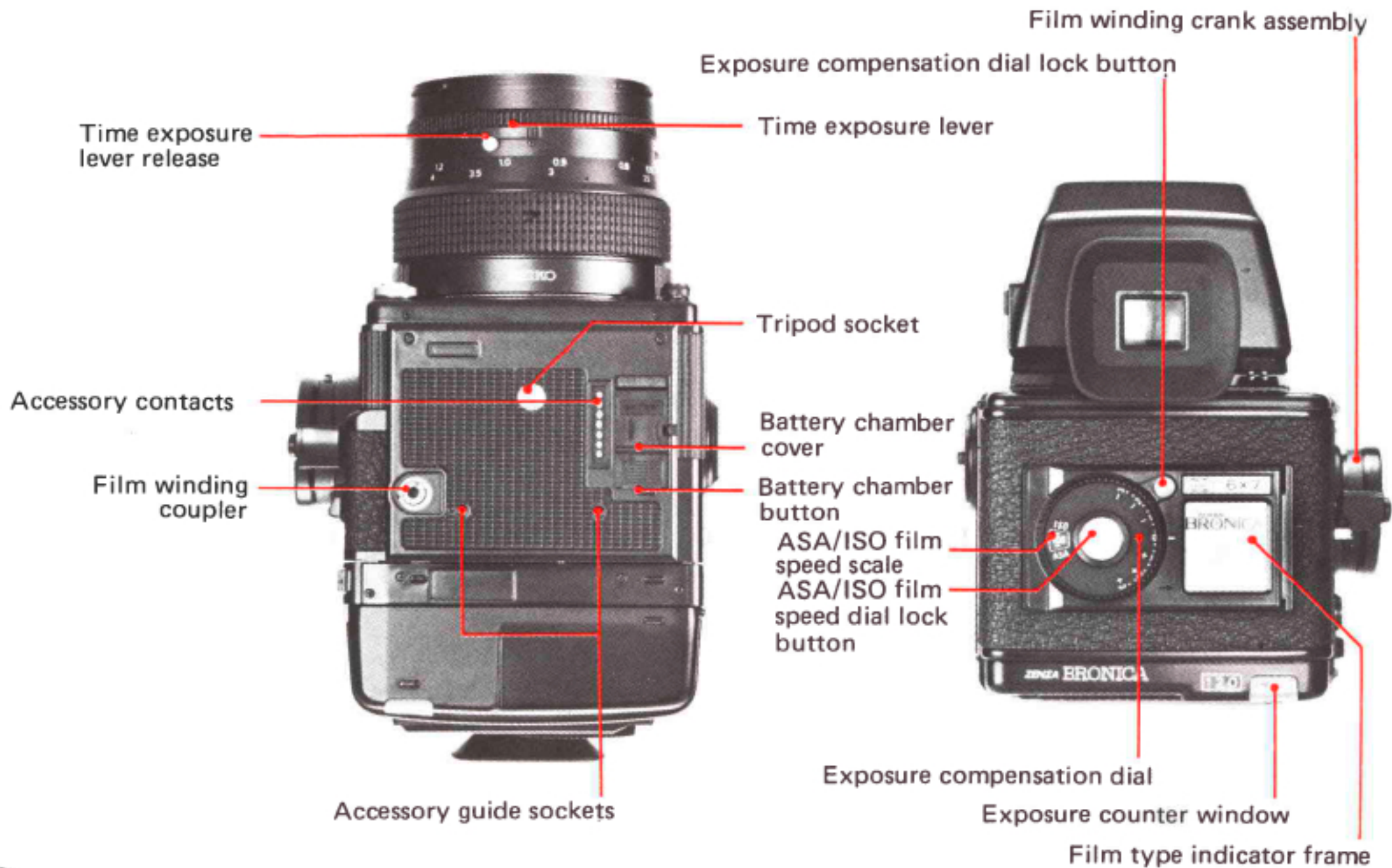

## 1 Loading the Battery

The electronically-controlled shutter and, of course, the electro-magnetic shutter release system, will not work without loading the battery. Use one 6 volt silver oxide battery or alkaline-manganese battery.

\* The battery may be obtained at any photographic equipment or electrical appliance shop.

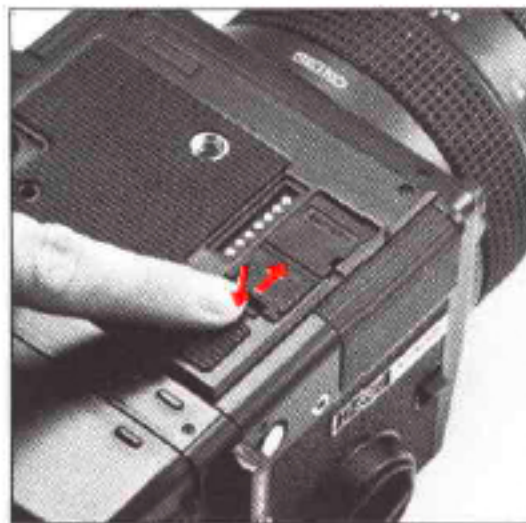

A. Depress the battery chamber button with your finger and, at the same time, move the battery chamber cover in the arrow-indicated direction. The cover will come off quite easily.

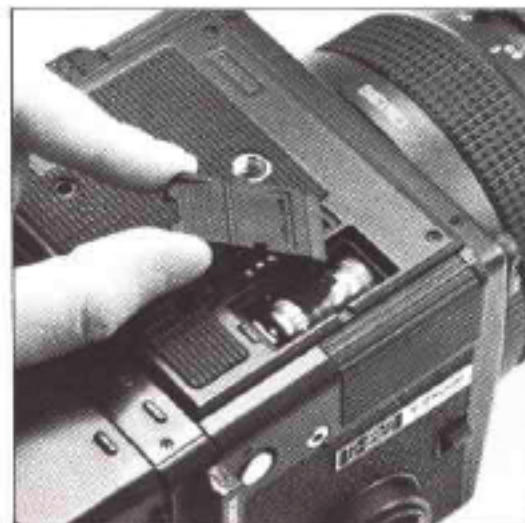

B. Coincide the plus (+) and minus (-) marks on the battery with similar polarity indications in the battery chamber. Then, push in the battery. Insert the battery chamber cover into the BATTERY end first and then move the cover in the other direction until it locks.

\* The shutter will not operate when the battery is loaded with polarity marks reversed.

## 2 Main Switch



The main switch is located on the upper left side of the main body. There will be no operations unless the main switch is pushed down (i.e., switched ON).

\* There is no power consumption, even with the main switch ON. However, the battery-life will be shortened when the shutter release is stroked halfway and the shutter speed display lights up steadily or flickers. Therefore, switch OFF (push up) the main switch when it is not planned to use the camera for some times.

## 3 Finder Display and Battery Checking



A. An LED display located over the top center of the focusing screen shows the shutter speed, etc., which is viewed laterally reversed with the waist-level finder.

Since the LED display differs with the finder in use, please read the instructions supplied with the finder for correct usage and reading.

B. Turn ON the main switch and then stroke the shutter release button halfway. If the LED display in the finder lights up steadily or flickers, as the case may be, the battery is loaded properly and there is sufficient power for operations.

\* If the LED display does not light up steadily or does not flicker, as the case may be, (1) the battery is not loaded properly or (2) the battery is completely drained and should be exchanged.

The film back is a film chamber that can be attached or detached freely from the main body, thus permitting free exchange of film types, at all times. Since the main body and film back are always fully coupled, upon connection, always turn the film winding crank completely one time, upon attaching the film back. If winding is not possible, all preparations for taking the picture have been completed. If winding is possible, however, rotating the film winding crank until it stops automatically takes care of the incompleting action, whether uncocked shutter or film not advanced. This means, of course, that it's possible to choose the film type most suited for the shot, even midway in a roll.

An ASA/ISO film speed dial and an exposure compensation dial are available on the film backs. When used for setting the film speed of the film loaded in the film back, there is automatic coupling when finders

with built-in exposure meters are attached on the main body. This will, of course, be very convenient when using films of different sensitivities in the film backs.

\* Make full use of film back interchangeability, in the following manner:—

1. Take full advantage of the multi-format superiority of the GS-1 and use film backs in many different formats, which will not only give you different effects but will economize on film.
2. Take your pictures in color and black-and-white, and in different film speeds, as required.
3. Keep a sufficient quantity of preloaded film backs on hand and speedy, continuous shooting will be possible.
4. Don't waste unsuitable film used in a previous session but simply load up a new film back with the required film type.
5. The Polaroid Film Back can be used for instant color or black-and-white pictures, when

in a rush, or used for checking composition or lighting effect, before taking the actual picture.

\* Film backs are available optionally and the type meeting the requirements of the photographer should be chosen.



A. To attach the film back to the main body, simply insert the latches at the upper end of the film back into attachment openings at the upper end of the main body. Then, press the lower end of the film back against the main body until it locks securely.

\* The dark slide must be withdrawn from its slit, upon attachment of the film back to the main body, as otherwise the shutter cannot be released.

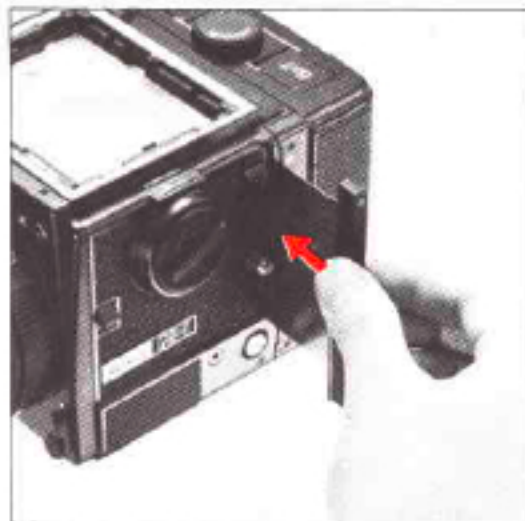

B. The dark slide must be inserted into the dark slide slit, for removing the film back from the main body. Insert, with the  $\odot$  mark at the top, as illustrated, and then push in all the way.

\* There is danger of the film back becoming detached from the main body, if the dark slide is left in its slit while the camera is being carried. Therefore, make it a rule to withdraw the dark slide whenever the film back is attached to the main body.



C. Depress the film back release button and the lower end of the film back can be removed, as illustrated. Simply shift the film back up slightly and pull it away.

\* The dark slide cannot be withdrawn from the film back, when the film back is detached from the main body.

## 5 Construction of the Film Back

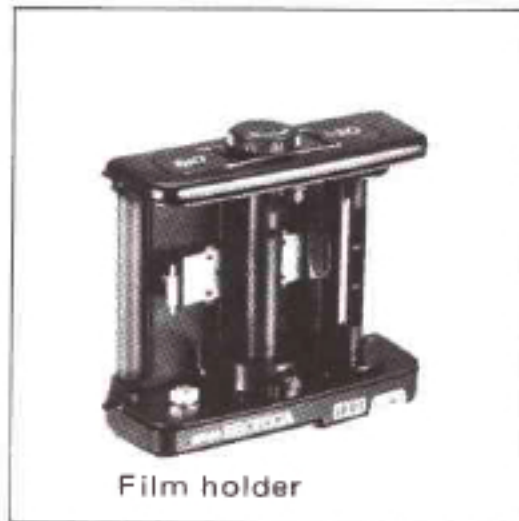

A. The film back consists of a film holder and film back frame, with exclusive film backs available for 120 and 220 roll films. The film holder is not only detachable from the film back but also has a built-in film winding mechanism.

\* Read instructions supplied with the Film Back GS 135 for loading 135 roll film.



B. The film back frame has a base with a dark slide slit and a back cover with an ASA/ISO film speed dial, an exposure compensation dial and a film type indicator frame. The film back frame completely encloses the film holder and shields it from outside light, as well as connecting it to the main body and also coupling with finders with built-in exposure meters.

## 6 Film Loading

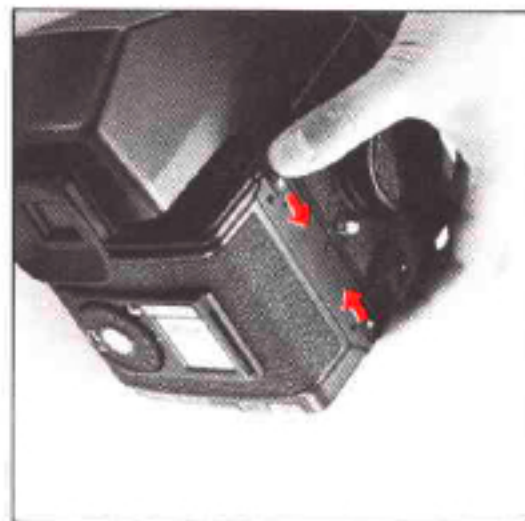

A. To open the back cover, squeeze the top and bottom back cover release buttons, in the arrow-indicated directions, at the same time and the back cover will open.

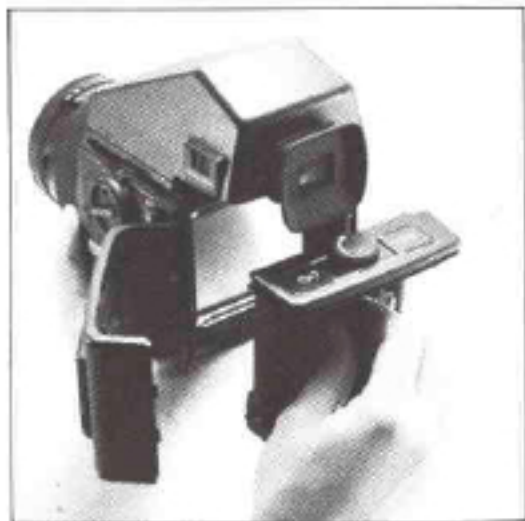

B. It will be possible to take out the film holder, upon opening the back cover.

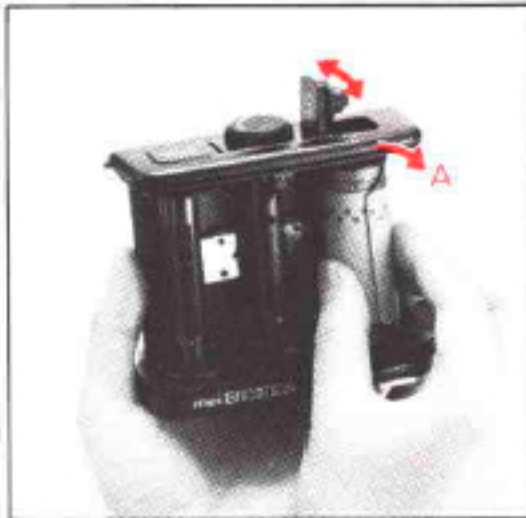

C. The film holder has two spool holders, with the right one for the fresh film spool while the left one is for the empty take-up spool. The top spool holder is opened, as illustrated, by sliding the film (spool) in the arrow-indicated A direction. The new film spool should be coincided on the right-side bottom shaft, which is fixed, after which the top spool holder should be closed to engage the spool.

\* The spool holders on the top will be locked securely, when the back cover is closed.

Black surface of leader must face out

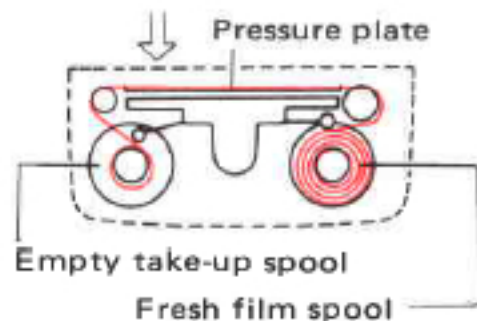

D. After loading the fresh film spool properly, draw out the leading end of the film and turn it across the film pressure plate (as illustrated). Run it across and turn it over to the take-up spool. Insert the leading end into the slit of the take-up spool and wind slightly until securely engaged.

\* The inside black surface of the leader must face out when running across the pressure plate, in this case.

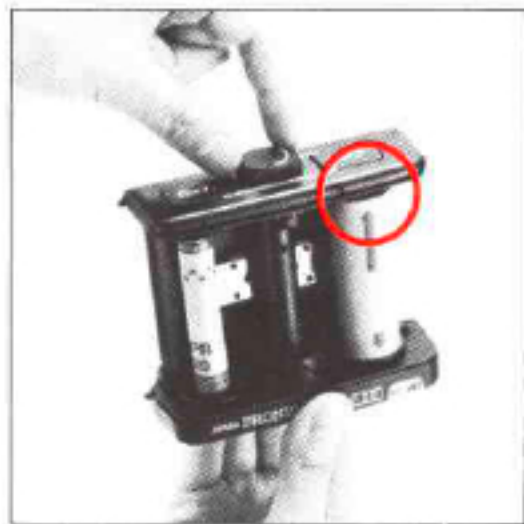

E. Rotate the manual film winder on top of the film holder in the arrow-indicated direction and wind up the film leader. When the starting point, or arrow mark, appears, align it with the triangular ▼ start-mark on the right top side of the film holder. Then, stop rotation.

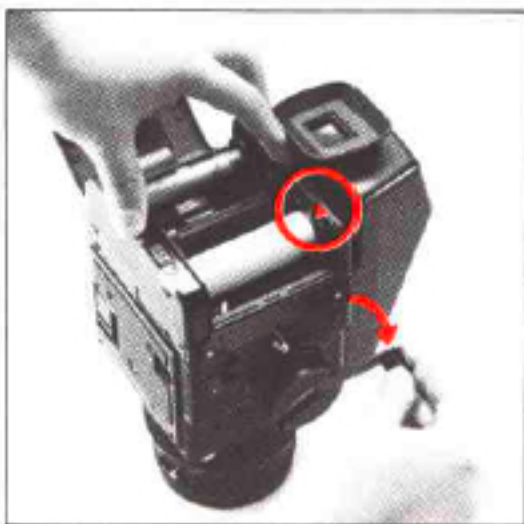

F. The starting point can also be aligned with the start-mark, with the film holder loaded in the film back. In this case, simply rotate the film winding crank of the main body to align the start-mark. This method is preferable since there will be coupling with the camera body mechanism, from the beginning.

\* If the film is not advanced when the film winding crank is rotated, however, the film holder is not loaded properly in the film back and/or the camera main body may be set for multiple exposures. In the latter case, return the multiple exposure lever to an upright or vertical position. (See "Multiple Exposures" on page 27.)

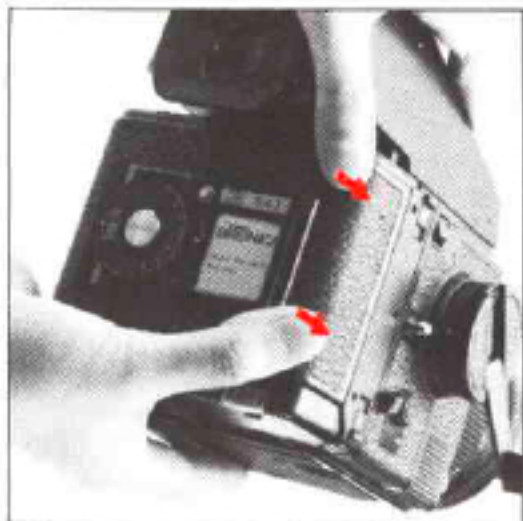

G. Close the back cover, by pressing it firmly against the right side of the film back base, as illustrated. The back cover will automatically lock and close. The same operation will close the back cover when the film back is detached from the main body.

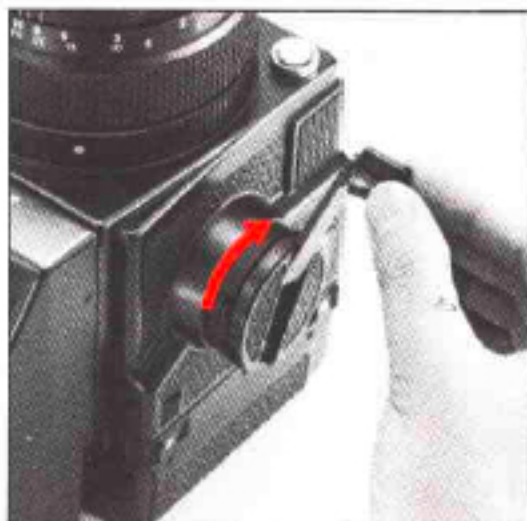

H. Upon loading the film, rotate the film winding crank until it stops to place the first frame into place for taking the picture. The exposure counter will also change from "S" to "1", with the film advanced and the shutter cocked.



I. The manual film winder is used to place the first frame into position, when the film back is detached from the main body. The manual film winder will not stop rotating, even when the film is in place for the first frame, but should be rotated 2 or 3 times more, in order to take up slack in the loaded film.

## 7 Film Speed Dial

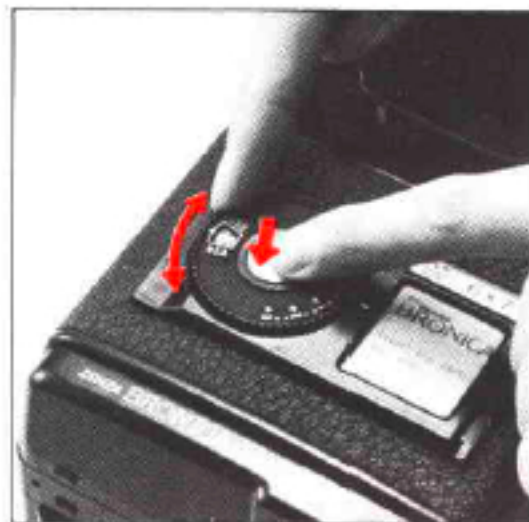

Set the film sensitivity of the film loaded in the film back, when using finders with a built-in exposure meter. To set the film speed, depress the ASA/ISO film speed dial lock button and, at the same time, rotate the ASA/ISO film speed dial and set the required film speed to the index. The dial has click-stops at 1/3rd increments.

## 8 Exposure Compensation Dial

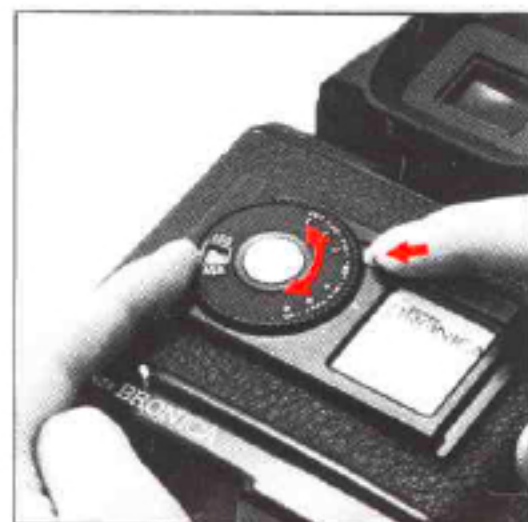

Exposure compensation up to  $\pm 3$  stops is possible at 1/3rd increments. To set the required compensation, slide the exposure compensation dial lock button, in the arrow-indicated direction, then rotate the exposure compensation dial, as required.

When compensation is not needed, simply set to "0", where it is locked.

\* There will be no effect on the exposure, no matter where the ASA/ISO film speed dial and exposure compensation dial are set, when a finder with a built-in exposure meter is not used.

120 roll film



Starting mark

220 roll film

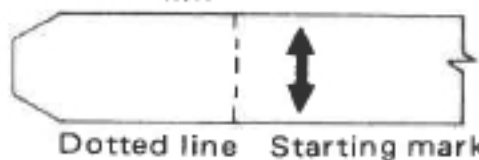

Dotted line Starting mark

\* When loading 220 roll film in the Film Back GS 220, do not mistake the dotted line before the arrow mark for the start-mark.

\* For the use of film backs other than the 6x7 format, read the instructions supplied with the film back.

## 9

## Film Type Indicator Frame



Upon loading the film, tear off the end flap from the empty film package and insert it in the film type indicator frame. This will help you keep track of the film loaded in the film back, even when two or more film backs are used with different types of films.

## 10

## Exposure Counter

The exposure counter is an additive type which shows the number of frames exposed. Starting from "S", the counter on Film Back GS 120 (6x7) shows numbers from 1 to 10, while Film Back GS 220 (6x7) shows numbers from 1 to 20. "S", "10" and "20" are orange-colored, in the above case, and all other numbers are white.

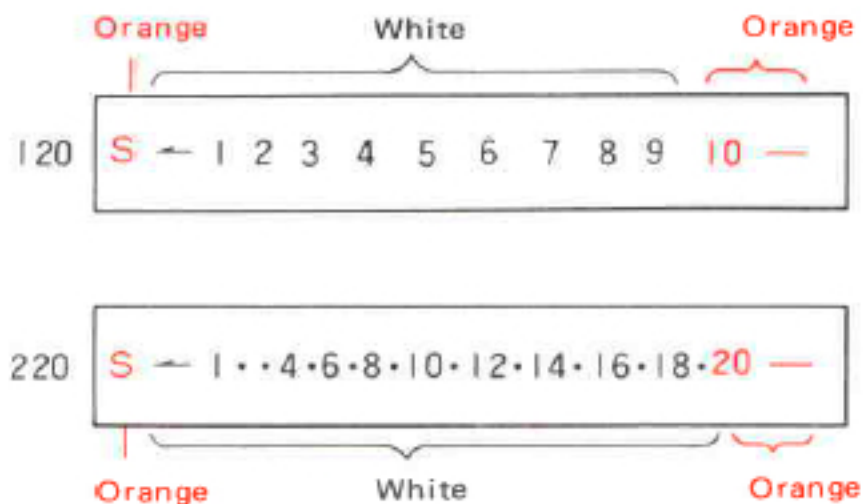

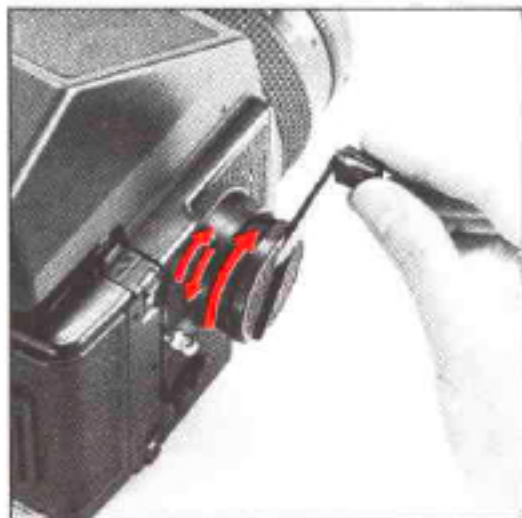

The film winding crank automatically stops, when rotated completely one time in the forward direction, with film advanced one frame and shutter cocked, at the same time.

Or, short, rapid strokes, up to an accumulated full rotation, will also do the same job because of a ratcheted mechanism.

\* The mirror lock-up lever must be vertical at all times, except when shooting with the mirror locked up.

(See "Mirror Lock-Up" on page 28.)

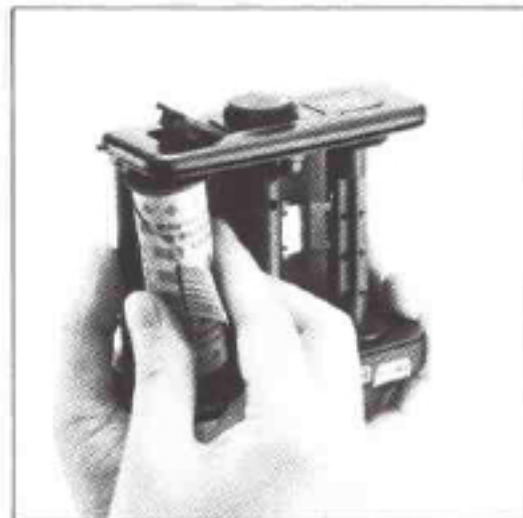

A. After the 10th exposure of the 120 roll film (20th exposure of the 220 roll film), continue rotating the film winding crank and the film only will be advanced until the remaining film and leader paper are wound up on the take-up spool.

Open the back cover when there is no resistance in the winding action.

B. Remove the film holder and, while preventing the loose film from unwinding, take out the take-up spool. Seal the exposed film and return it to its original box until development.

\* Load and unload film away from direct sunlight and/or strong illumination.

### 13 Setting the Shutter Speed Dial



A. The shutter speed scale is viewed in its window over the shutter speed dial. The numbers on the scale are shutter speed settings, with numbers 1 to 16S full numbers and numbers 2 to 500 fractions of a second. For example, "16S" is 16 seconds, "2" is 1/2 sec. and "500" is 1/500 sec.

A is the setting for aperture-priority AE (automatic exposure) when a finder with a built-in exposure meter is attached. B (bulb) is the setting used to keep the shutter opened, as long as the shutter button is depressed. However, since power

B The numbers on the scale are color-coded in red and white. Red-colored numbers are full number settings of 1 second and longer while white-colored numbers are settings from 1/2 to 1/500 second, as well as the letters "A" and "B".

The shutter speed can be set before or after film winding. (For "Time (T) Exposure", see page 21.)

is consumed during this time, the use of T (time) exposure is recommended for exposures longer than one minute.

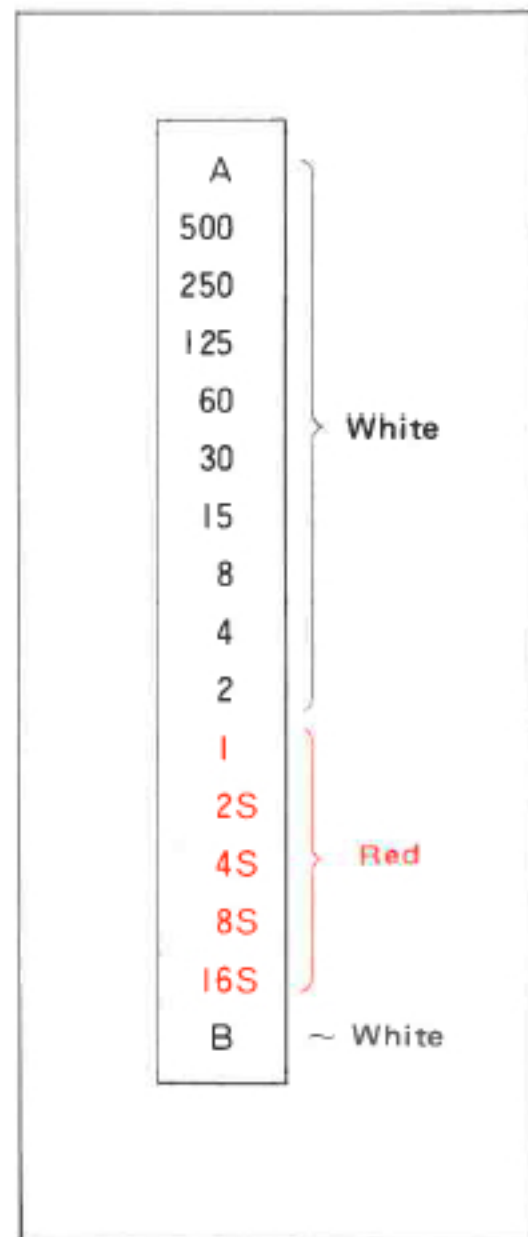



C. The shutter speed dial is set to A, for aperture-priority AE photography when a finder with a built-in exposure meter is attached. To set A, press the shutter speed dial lock button and rotate the shutter speed dial, at the same time. To change from A to another setting, for manual photography, press the lock button and rotate the shutter speed dial to the required setting. However, the shutter speed dial cannot be moved directly from A to B, in this case, or from B to A, too.

\* The shutter speed, when the shutter speed dial is set to A, is 1/6 seconds, when a finder with a built-in meter is not attached.



An electro-magnetic shutter release button is incorporated in the Zenza Bronica GS-1. Stroking the release button halfway illuminates the shutter speed, as digits and dots, etc., in the display panel in the top center of the finder, outside the screen area.

The display will go out when the release button is stroked all the way and a shutter release warning LED will light up momentarily, when the exposure is completed and the shutter blades are closed, which should be checked when using a slow shutter speed.



In the following cases, the shutter will not be released and the shutter release warning LED will light up, except in the first instance:—

1. Main switch is OFF.
2. Dark slide is inserted.
3. Film is not advanced. (Same when exposure counter is between "S" and "1".)
4. Shutter is not cocked.
5. Lens is not attached properly. (Same with automatic extension tubes, too.)

6. Lens release button is depressed.

7. All frames (i.e., 10 frames for 120 roll film and 20 for 220 roll film) have been exposed.

\* There will be under-exposure if the film winding crank is accidentally rotated before conclusion of the exposure, on a slow shutter speed setting. Furthermore, the shutter will not be released on the following shot until the remaining time for the previous exposure has elapsed.

## 15 Time (T) Exposure

Time exposures are made with the time exposure lever on the lens, regardless of the setting on the shutter speed scale.

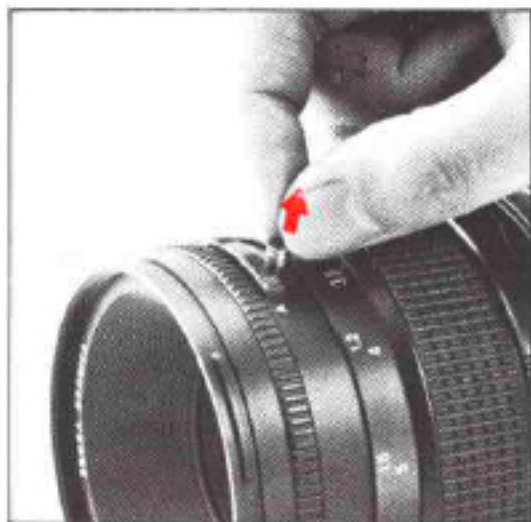

A. First, cock the shutter with the film winding crank and then pull up the time exposure lever release.



B. Slide the time exposure lever and release the shutter, when a red-colored "T" is exposed on the lens barrel. The shutter will stay open until the time exposure lever is moved in the opposite direction, exposing the letter "A", which will close the shutter.

\* Except for time exposures, always shift the time exposure lever so that the letter "A" is visible on the lens barrel and keep the time exposure lever release pushed in all the way.

## 16 Exchanging Lenses

The lens cannot be attached or detached unless the shutter is cocked. Therefore, first, rotate the film winding crank and cock the lens shutter.



A. To attach the lens, align the white dot on the main body and the red dot on the lens, and then insert the lens fully into its mount. Rotate counter-clockwise (in the arrow-indicated direction) until it stops, with an audible click, which will indicate that it is securely locked.

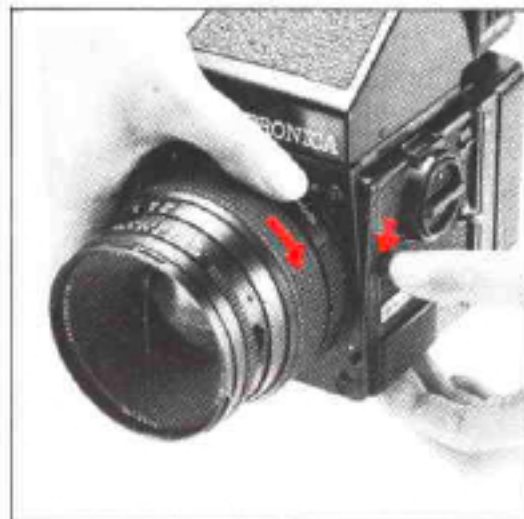

B. To detach the lens, press the lens release button down and, at the same time, rotate the lens clockwise (as arrow indicated) until it makes a full stop, at which point it will be possible to detach the lens.

## 17 Interchanging Finders



A. Various types of optional finders can be interchanged to match shooting conditions to photographic conditions. To attach the finder, align the front end of the finder with the front end of the finder frame on top of the main body, as shown. Then, gently lower the finder and, when well seated, slide forward until it locks.

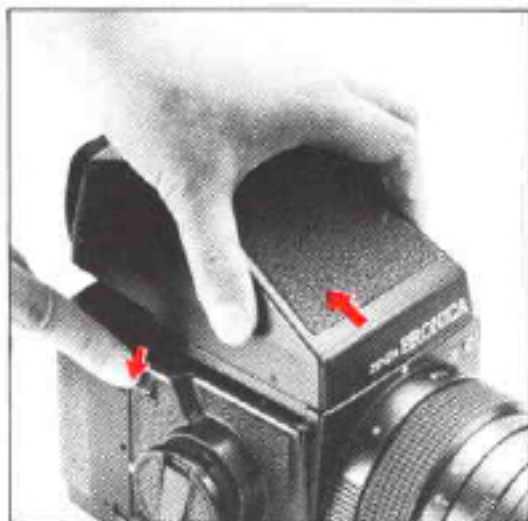

B. To detach the finder, simply depress the finder release button and, at the same time, slide the finder backwards where it can be detached.  
\* Read instructions supplied with the optional finders on their use.

## 18 Setting the Aperture Ring



A. The aperture ring is rotated, in either direction, to set the required F/number opposite the white index dot. The aperture ring click-stops at the numbered settings, as well as intermediate 1/2 stop settings. The aperture ring may also be set midway between the 1/2 stop click-stops, too.

\* The intermediate 1/4 stop settings cannot be used when finders with a built-in exposure meter are used. Click-stop settings only can be used, in this case.

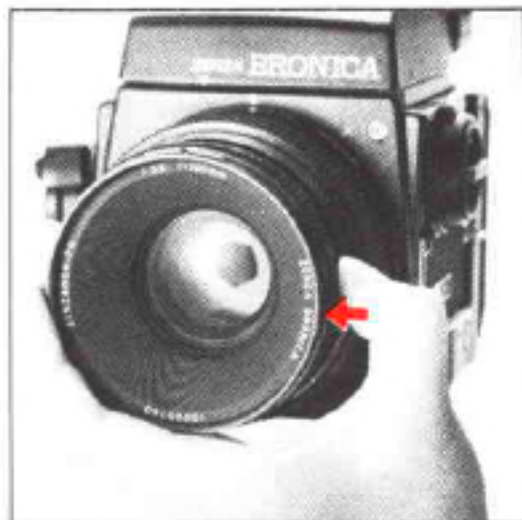

B. The Zenzanon-PG Series interchangeable lenses have fully automatic lens diaphragms which means that the focusing screen is always viewed at the full aperture, with the brightest possible image. Depressing the depth of field preview lever stops the lens diaphragm down to a pre-selected lens opening and permits checking of the depth of field effect on the focusing screen.

\* The aperture ring must not be adjusted while the depth of field preview lever is being depressed.

\* When using finders with a built-in exposure meter, exposure measurements should not be taken with the depth of field preview lever depressed, as the shutter speed indicated will cause over-exposure. This is because proper exposures are obtained with exposure measurements made at the full aperture.



The lens is focused on the subject, by rotating the focusing ring in either direction, while checking the effect on the central matte surface area of the focusing screen (standard type).

## 20 Distance Scale and Depth of Field Scale

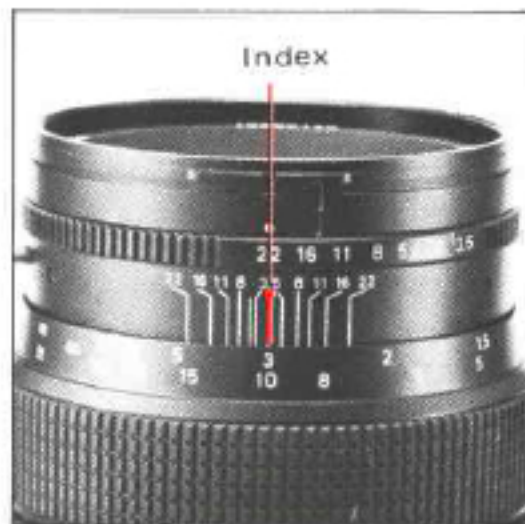

A. To adjust the lens to the required distance, without use of the finder, simply rotate the focusing ring and set the distance opposite the orange-colored index.

When the lens is focused, there is an apparent zone of sharpness, both in front and back of the focused plane, which is known as the depth of field.

\* See the depth of field table for the Zenzanon-PG 100mm lens on page 37.

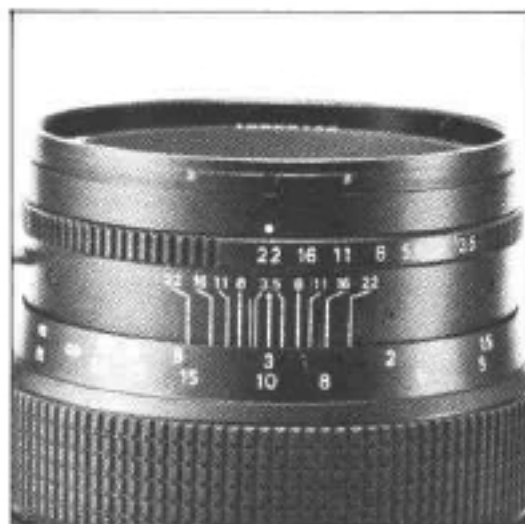

B. The depth of field scale, next to the distance scales, shows the zone of apparent sharpness at any lens opening or distance and is made up of identical pairs of apertures on both sides of the distance index. These identical pairs of apertures indicate the distance that will be in focus at these apertures. For example, if the 100 mm lens is focused at a distance of 3 meters, it can be seen from the depth of field scale that the zone will extend from 2.2 to 4.8 meters, when a lens opening of F22 is used.

## 21 Infrared Photography



In infrared photography, some adjustment is required in the focus in order to retain sharpness on the film, because the invisible infrared rays are longer in wave length than the visible rays used for focusing.

For infrared photography:—

1. Use an R filter or equivalent with an infrared (black-and-white) film.
2. The red-colored line, next to the orange-colored distance index, is the infrared index.
3. After focusing in the normal manner, re-set the distance indicated by the orange-colored



A. Always use flash cords with a standard PC type plug, which should be connected to the flash synch socket on the front of the main body.

\* When detaching the flash cord, grip the plug firmly and pull it out straight, instead of using a twisting action.

index to the infrared index, by shifting the distance ring.

For example, if the distance indicated by the orange-colored index is 3m, when the lens is focused on the subject, re-set 3m to the red-colored infrared index, by shifting the distance ring which will focus the lens properly at 3 meters for the infrared film loaded in the camera.

\* Follow instructions enclosed with the film and filter and, to be on the safe side, make several bracketing shots. In general, it seems safer to give more exposure than less, in this case.

B. The Zenzanon-PG lenses have a between-lens leaf shutter with X-setting for flash synchronization.

This means that electronic flash units can be used and will synchronize at all shutter speed settings, up to 1/500 second. Flash fill-in for daylight shots are also made very easily, too.

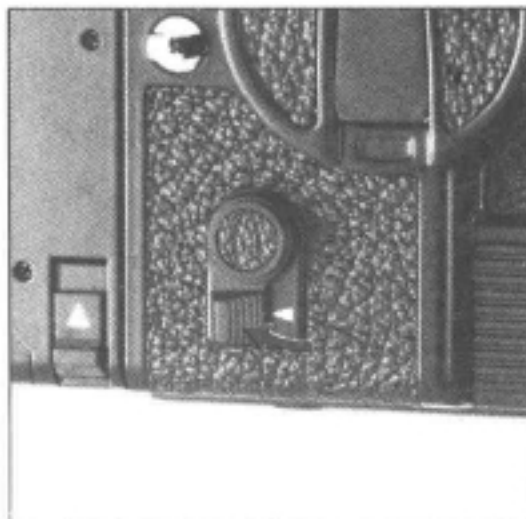

A. To make multiple exposures, rotate the film winding crank to advance the film and cock the shutter. Then, turn the multiple exposure lever in the arrow-indicated direction. When the shutter release button is depressed, in this condition, the shutter will be released any number of times without advancing the film.

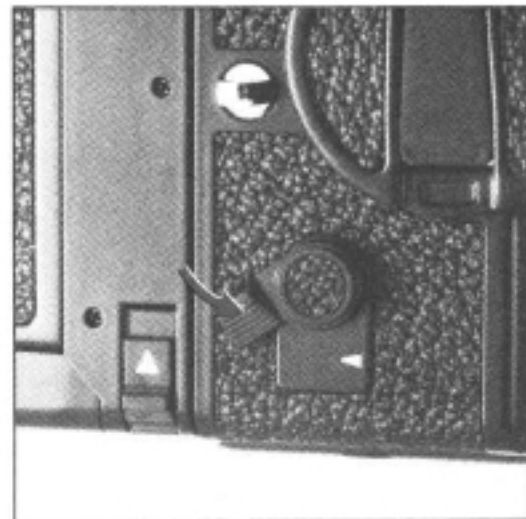

B. Upon taking the multiple-exposed picture, be sure to return the multiple exposure lever back to its vertical position. Otherwise, there will be additional multiple exposures on the same frame.

C. When the dedicated Speed-Light G1 for the Zenza Bronica GS-1 is used in combination with the Speed Grip G, it will be possible to control the flash exposure by directly metering the flash illumination at the film plane.

\* See instructions for the dedicated Speed-Light G1 for use of the equipment.



A. For shooting with the mirror locked up, first, rotate the film winding crank and advance the film and cock the shutter. Then, turn the mirror lock-up lever in the arrow-indicated direction, which will close the lens shutter down completely and swing up the reflex mirror and film safety plate.

\* Read instructions supplied with the finder with built-in exposure meter for AE (automatic exposure) photography with the mirror locked up.



B. The shutter will be released when the shutter release button or Electro-Magnet Cable Release is pressed.

\* When suspending further shooting with the mirror locked up, reverse the mirror lock-up lever before rotating the film winding crank.

The shutter will be released any number of times, with mirror locked up and advancing the film (leader paper), when the film winding crank is rotated after taking the final exposure.↗

When the mirror lock-up lever is reversed, upon suspension of shooting with the mirror locked up, the shutter will be released. Therefore, shooting should be continued, in this case, by the following methods.

↗ Therefore, reverse the mirror lock-up lever before rotating the film winding crank.



C. Reverse the mirror lock-up lever. One frame will be exposed and, therefore, wasted.



D. Cover the lens with its lens cap and then reverse the mirror lock-up lever. Then, take the next exposure, with the multiple exposure lever turned. Reverse the multiple exposure lever, upon taking the picture. (See "Multiple Exposures" on page 27.)



E. Utilize film back interchangeability and detach the film back before reversing the mirror lock-up lever. Then, attach the film back and continue shooting in the normal manner. (See "Attachment and Removal of Film Backs" on page 9.)

## 25 Remote Control Operations

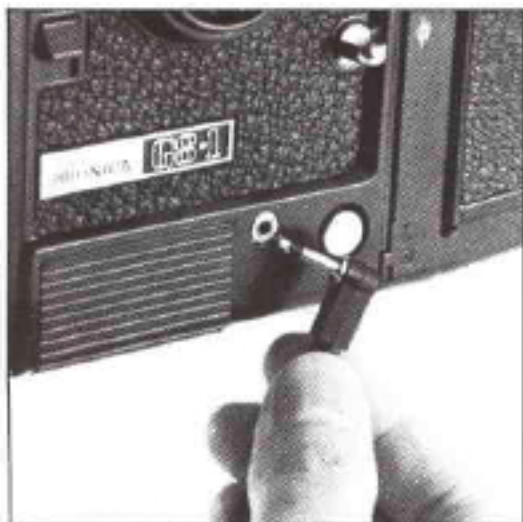

The Zenza Bronica GS-1 has an electro-magnetic shutter release system which means that the usual cable release cannot be used.

A Zenza Bronica Electro-Magnet Cable Release is available for this purpose, although it is also possible to use any cable release with a 2.5mm mini-plug, such as those available in photographic equipment stores.

\* Always check operations before actually using such cable releases.

## 26 Interchanging Focusing Screens

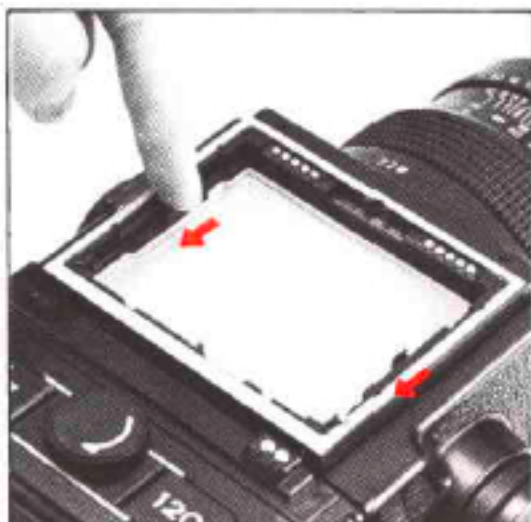

A. The focusing screen can be exchanged, depending on the type of photographic work being undertaken.

First, remove the finder attached to the camera main body. Then, move the screen removal levers on both sides in the arrow-indicated directions, as illustrated. Then, using a pincer or similar tool, lift up the screen with the protrusion at the rear end.



B. To install the focusing screen, nest the protrusion at the rear end of the screen in a corresponding groove on the camera main body. Then, slide both screen removal levers forward to secure the focusing screen.

\* It will not be possible to attach the finder, if the screen removal levers are not in their forward positions.

\* There are seven interchangeable focusing screens for the Zenza Bronica GS-1.

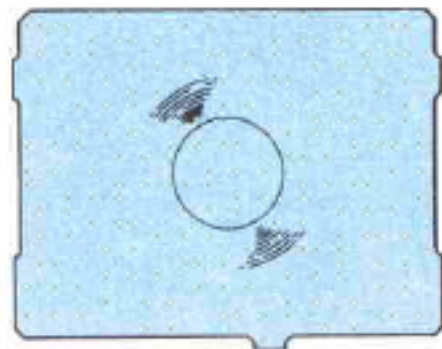

Matte (Standard type)

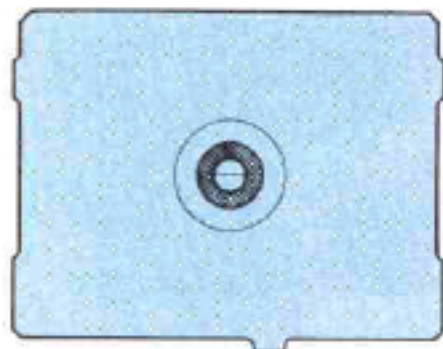

Microprism/Split-image

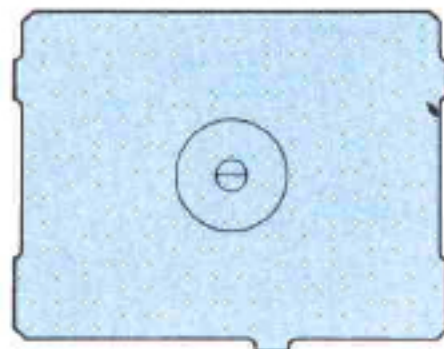

Split-image



Microprism

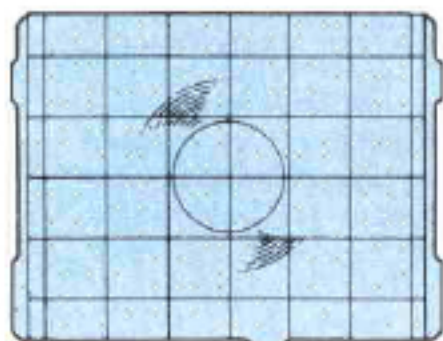

Grid-lines

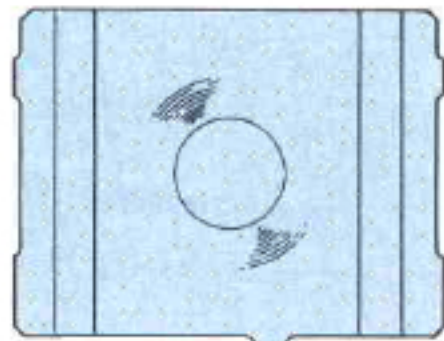

Matte (for 6x6 & 6x4.5 formats)

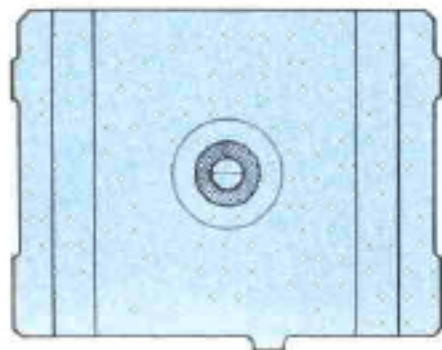

## 27 Removal and Attachment of the Film Winding Crank Assembly

The film winding crank assembly must be removed when attaching the Speed Grip G to the Zenza Bronica GS-1.

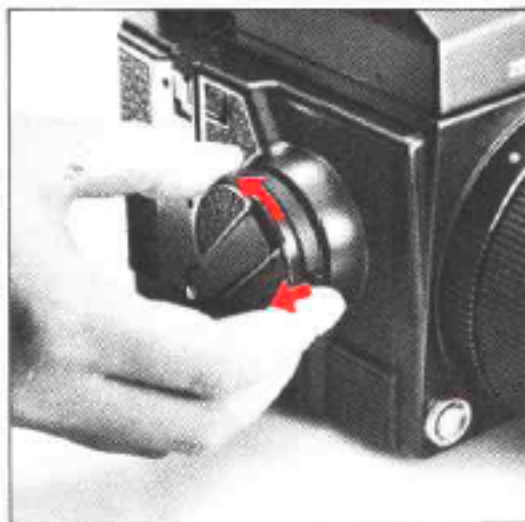

A. Pull the release lever on the base of the film winding crank assembly outwards and, at the same time, rotate the base in the counter-clockwise direction and the film winding crank assembly will become detached.

\* Upon detaching the film winding crank assembly from the main body, place the cover, which is supplied with the Speed Grip G, over the exposed bayonet mount to protect it from dust and foreign matters.



B. To attach the film winding crank assembly to the main body, first, remove the cover from the bayonet mount. Then, align the base of the film winding crank assembly to the bayonet, insert and then rotate in the clockwise direction until securely attached.

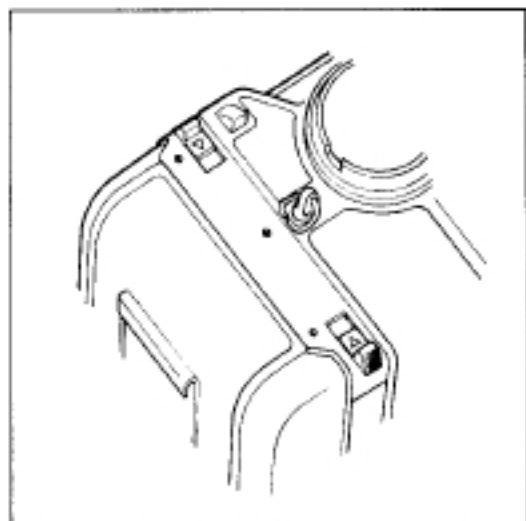

A. First, insert the U-shaped ring into the neck strap eyelet, as illustrated.

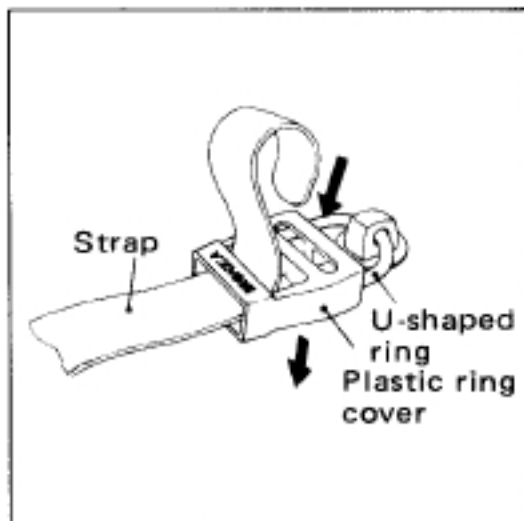

B. Next, place the plastic ring cover over the U-shaped ring, as illustrated.

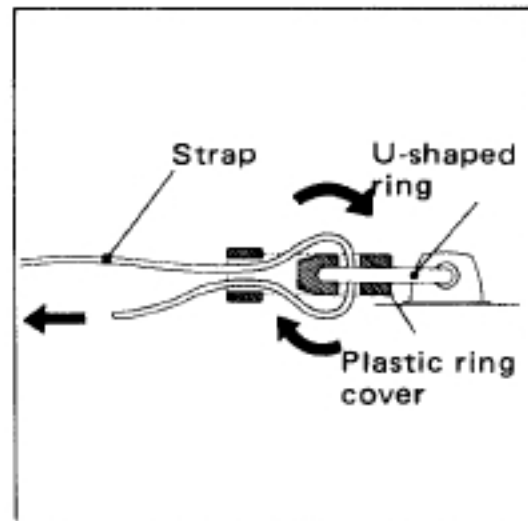

C. Next, thread the neck strap through the plastic ring cover (and the U-shaped ring) and pull it out, as illustrated.

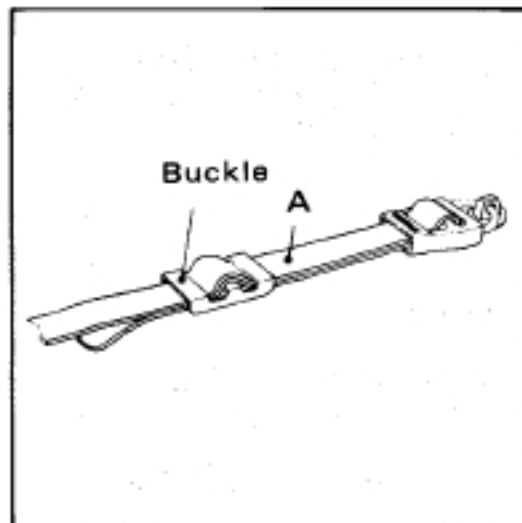

D. After adjusting the length of the neck strap, pass the leading end of the strap through the buckle, as illustrated, which will fix it securely.

\* There should be no slack in the strap between the buckle and the plastic ring cover, or in "A" section, which means that both straps must be of the same length at this point.

The battery supplies power for the various electronic control mechanisms incorporated in the Zenza Bronica GS-1. When used incorrectly, there is possibility of the wrong exposure being set to the camera and/or the camera not operating.

Be sure to use and store the battery correctly for obtaining optimum performance from it at all times.

\* Take the battery out of the battery chamber when storing the camera.

\* Leaving the battery in the camera for a long time, without using it, can lead to leakage problems and result in poor contact.

Discard a battery with leakage or corrosion and thoroughly clean out the battery chamber, before inserting a new battery.

\* Clean the contacts of the battery chamber and battery with a soft cloth. Don't use sandpaper or emery cloth.

\* Don't throw the battery into a fire, or hit it strongly, as there is danger of explosion.

\* Either a silver oxide battery (No. 544/PX28/4G13) or an alkaline manganese battery (A544/4LR44) is used with the Zenza Bronica GS-1. Both have very good cold weather resistance. However, there is a tendency for performance to drop when the temperature falls below 0°C (32°F). Therefore, make it a rule to use a new battery and/or keep replacement batteries on hand for shooting outdoors in freezing weather. Keep the battery (and camera) under cover, next to the body, and load just before beginning the session and/or, preferably, use the optional Remote Camera Battery Pack E.

\* The shutter cannot be cocked when film is not loaded in the film back. The use of the multiple exposure lever will, however, permit you to cock the shutter, in such instances. This feature is, of course, very convenient for familiarizing yourself with the camera and for testing the shutter in flash photography. (See "Multiple Exposures" on page 27.)

\* Battery power is not consumed when time (T) exposures are made.

\* The lens shutter remains open while the shutter release button is depressed on B (bulb) setting and, of course, battery power is also consumed. Therefore the use of time exposure is recommended when exposures are longer than one minute on B (bulb).

\* The focusing screen is interchangeable. However, do not place trimming masks or tapes on the bottom surface of the screens, as this will lead to inaccurate focusing.

\* A shutter release warning LED will flash above the focus-

ing screen, in the top center of the finder, and signal closing of the shutter when the shutter release button is pressed. Wait for this signal, especially at slow shutter speeds, before rotating the film winding crank.

\* There will be no shutter release action when there is no battery power. However, it will be possible to release the shutter at a mechanically-controlled 1/500 sec. by reversing the mirror lock-up lever, after locking up the mirror first.

\* When taking pictures, remember that the final print will be cut down somewhat, especially when printed in the economy size, because of the masking used in commercial photofinishing equipment. Therefore, leave space on all sides when taking the picture.

\* When using a finder with a built-in exposure meter, always remember to adjust the ASA/ISO film speed dial of the film back for the film loaded.

\* Restrict cleaning of the reflex mirror to blowing or brushing with the blower brush or a soft camel hair brush. Don't touch the surface with your fingers or a cloth.

\* Use lens cleaning tissue and liquid to clean the surface of the lens. Do not use silicon-coated cloth for this purpose, as it will prove detrimental to the lens coating.

\* Clean the plastic focusing screen in the same manner. Don't touch the surface as you may leave fingerprints.

\* Do not wipe the lacquered exterior of the main body, etc., with a lens cleaner, alcohol, thinner, etc., but limit cleaning to wiping with a silicon-coated cloth or a clean soft cloth.

\* Protect your camera from temperature changes which can result in moisture condensation, frost, etc., inside the body, leading to rusting of metallic parts and troubles.

\* Protect your camera from impact and vibrations, too.

\* Upon attaching the film back, always pull out the dark slide

from its slit.

\* Always protect the lens with its cover, when carrying the camera.

\* Clean the camera and lens very carefully after using it outdoors in wet weather or at the seashore.

\* Wipe the camera carefully with a well-wrung damp cloth, using fresh water, if the exterior is effected by salty air. Then, wipe it dry with a soft, dry cloth. If necessary, send it out for a quick inspection at an authorized repair station.

\* If the equipment is not being used for a long period, store everything in tin-lined containers, with plenty of desiccant, such as silica gel. Finally, store the equipment in a cool, dry and well-ventilated (but not windy) place.

\* Do not thread too strongly, when using a longer-than-standard tripod screw, as you may damage the body.

\* Both camera main body and lens must be in the "cocked" condition to attach or remove the lens. In other words, the cocking pin of the lens must be

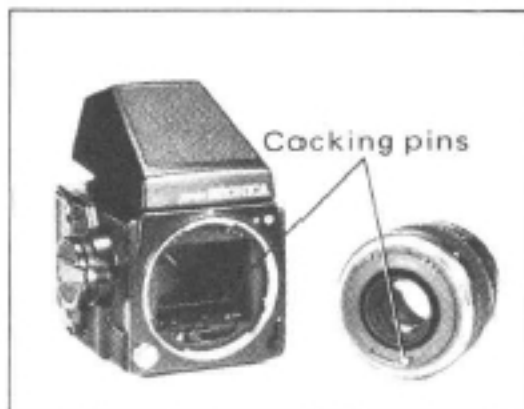

set between the red band and green dot, in this case, while the cocking pin of the body mount must be set to the green-colored dot.

When not set as above, move the cocking pin of the lens manually to the green-colored dot and rotate the film winding crank to set the cocking pin of the main body mount.

\* A brown-colored flexible printed wiring will be seen, at the hinge section, when the back cover is opened. Do not pull, cut or otherwise damage it, as it is used for transmitting the ASA/ISO data.

# 32 Depth of Field Tables

## Zenzanon-PG 100mm F3.5

Distance F	Meter												Distance F	Feet											
	∞	15	8	5	3	2	1.5	1.2	1.0	0.9	0.8	0.75		∞	50	25	15	10	8	6	5	4	3.5	3	2.5
3.5	∞	21.9	9.58	5.56	3.18	2.08	1.54	1.22	1.02	0.91	0.81	0.76	∞	73.4	29.6	16.5	10.6	8.39	6.20	5.14	4.08	3.56	3.40	2.53	
	46.9	11.4	6.87	4.54	2.84	1.93	1.46	1.18	0.99	0.89	0.79	0.74	154	37.9	21.6	13.7	9.45	7.65	5.81	4.87	3.92	3.44	2.96	2.48	
4	∞	23.2	9.82	5.64	3.21	2.09	1.55	1.23	1.02	0.91	0.81	0.76	∞	78.1	30.4	16.7	10.7	8.44	6.23	5.15	4.09	3.57	3.05	2.53	
	41.8	11.1	6.75	4.49	2.82	1.92	1.46	1.17	0.98	0.89	0.79	0.74	137	36.8	21.3	13.6	9.38	7.61	5.79	4.86	3.91	3.44	2.96	2.47	
5.6	∞	30.1	10.9	5.96	3.31	2.12	1.56	1.24	1.02	0.92	0.81	0.76	∞	102	33.3	17.6	11.0	8.63	6.33	5.22	4.13	3.60	3.07	2.54	
	29.6	10.0	6.34	4.31	2.75	1.89	1.44	1.16	0.98	0.88	0.79	0.74	97.0	33.2	20.0	13.1	9.15	7.46	5.70	4.80	3.88	3.41	2.94	2.46	
8	∞	51.7	12.7	6.47	3.45	2.18	1.59	1.26	1.04	0.93	0.82	0.77	∞	179	38.7	18.9	11.5	8.93	6.48	5.32	4.19	3.64	3.09	2.56	
	20.9	8.81	5.84	4.06	2.66	1.85	1.42	1.15	0.97	0.87	0.78	0.73	68.7	29.2	18.5	12.4	8.83	7.25	5.59	4.72	3.83	3.37	2.91	2.44	
11	∞	∞	16.9	7.38	3.68	2.27	1.64	1.28	1.05	0.94	0.83	0.77	∞	∞	50.1	21.2	12.3	9.38	6.71	5.46	4.27	3.70	3.13	2.58	
	14.8	7.53	5.26	3.79	2.54	1.79	1.39	1.13	0.95	0.86	0.77	0.73	48.7	24.9	16.7	11.6	8.43	6.99	5.43	4.61	3.76	3.33	2.88	2.42	
16	∞	∞	31.7	9.20	4.07	2.40	1.70	1.32	1.07	0.96	0.84	0.78	∞	∞	86.4	25.7	13.7	10.1	7.05	5.68	4.40	3.79	3.19	2.62	
	10.5	6.25	4.61	3.45	2.38	1.72	1.34	1.10	0.94	0.85	0.76	0.72	34.5	20.6	14.7	10.7	7.92	6.64	5.23	4.47	3.67	3.26	2.83	2.39	
22	∞	∞	∞	14.2	4.79	2.62	1.80	1.37	1.11	0.98	0.86	0.80	∞	∞	∞	36.5	16.1	11.4	7.61	6.02	4.59	3.92	3.28	2.67	
	7.47	5.04	3.93	3.06	2.20	1.63	1.29	1.07	0.91	0.83	0.75	0.71	24.5	16.6	12.6	9.52	7.30	6.21	4.97	4.29	3.56	3.17	2.77	2.35	



Zenzanon-PG	50mm F4.5	65mm F4	100mm F3.5
No. of group-element	8-11	7-9	4-6
Angle of view	83°	68.5°	48°
Apertures	4.5~22 (w/half click)	4~22 (w/half click)	3.5~22 (w/half click)
Minimum focusing distance (m)	0.5	0.6	0.75
Filter size (mm)	95	72	72
Overall length, Weight (mm·g)		71.0xφ87, 715	67.5xφ87, 630
Equivalent focal length in 35mm format camera (mm)	25	33	50
Shutter	Seiko #0 (Electronic control) T·B·16 ~ 1/500 sec.·A		

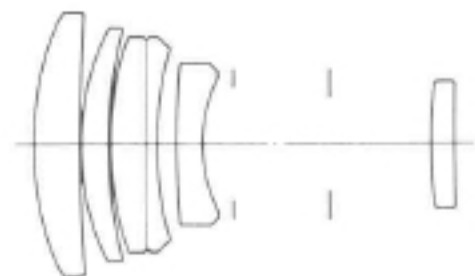
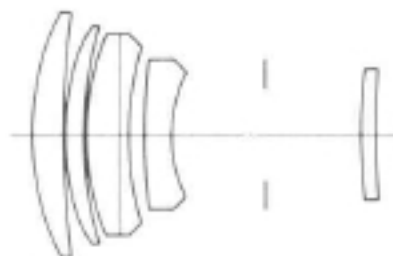
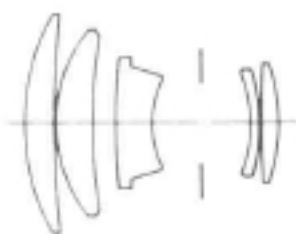

Zenzanon-PG	150mm F4	200mm F4.5	250mm F5.6
No. of group-element	5-5	5-6	5-6
Angle of view	33°	25.5°	20.5°
Apertures	4~22 (w/half click)	4.5~32 (w/half click)	5.6~32 (w/half click)
Minimum focusing distance (m)	1.5	2	3
Filter size (mm)	72	82	82
Overall length, Weight (mm·g)	62.0×φ87, 650		
Equivalent focal length in 35mm format camera (mm)	75	100	125
Shutter	Seiko #0 (Electronic control) T·B·16~1/500 sec.·A		



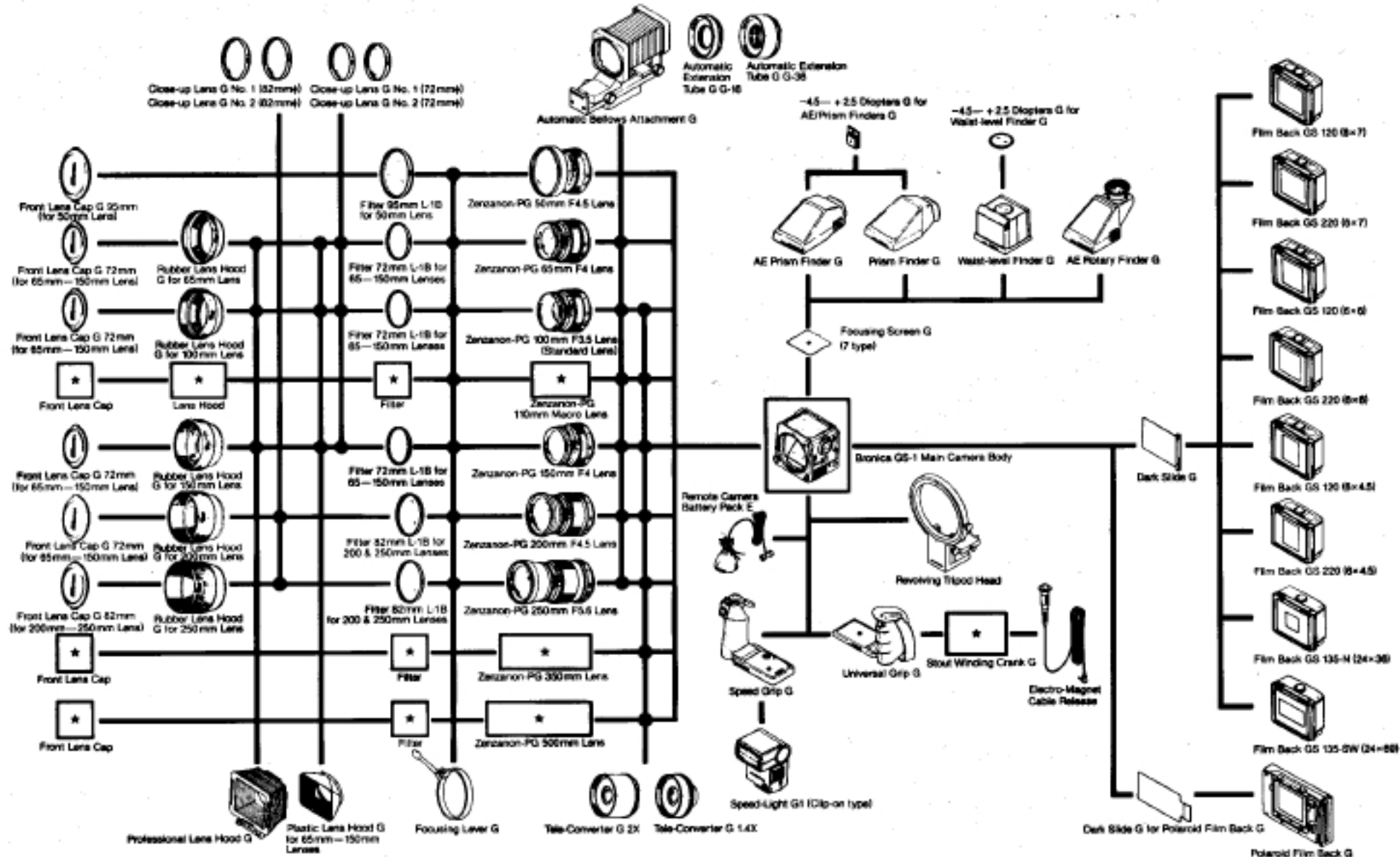

\*Specifications are subject to change without prior notice.