

brother®

USER'S GUIDE

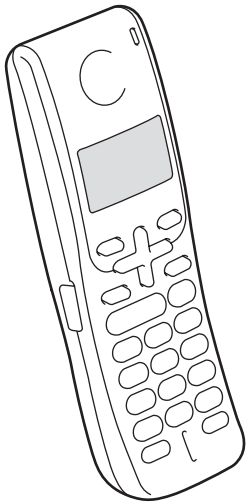

Digital
Cordless
Handset
BCL-D10

Brother numbers

IMPORTANT

For technical help, you must call the country where you bought the machine/cordless handset. Calls must be made **from within** that country.

FAQs (frequently asked questions)

The Brother Solutions Center is our one-stop resource for all your Fax Machine/Multi-Function Center needs. You can download the latest software documents and utilities, read FAQs and troubleshooting tips, and learn how to get the most from your Brother product.

<http://solutions.brother.com>

For Customer Service

In USA:

- 1-800-284-4329 (voice)
- 1-901-379-1215 (fax)
- 1-800-284-3238 (TTY service for the hearing-impaired)

Service Center Locator (USA only)

For the location of a Brother authorized service center, call 1-800-284-4357.

Ordering accessories and supplies

For best quality results use only genuine Brother accessories, which are available at most Brother retailers. If you cannot find the accessory you need and you have a Visa, MasterCard, Discover, or American Express credit card, you can order accessories directly from Brother. (In the USA, you can visit us online for a complete selection of the Brother accessories and supplies that are available for purchase.)

In USA: 1-888-879-3232 (voice)
1-800-947-1445 (fax)

<http://www.brothermall.com>

Description	Item
Cordless Handset	BCL-D10
Battery	BCL-BT10
User's Guide	LP5403001

Compilation and Publication Notice

Under the supervision of Brother Industries Ltd., this manual has been compiled and published, covering the latest product descriptions and specifications.

The contents of this manual and the specifications of this product are subject to change without notice.

Brother reserves the right to make changes without notice in the specifications and materials contained herein and shall not be responsible for any damages (including consequential) caused by reliance on the materials presented, including but not limited to typographical and other errors relating to the publication.

Brother® One Year Limited Warranty and Replacement Service (USA only)

Who is covered:

- This limited warranty (“warranty”) is given only to the original end-use/retail purchaser (referred to in this warranty as “Original Purchaser”) of the accompanying product, consumables and accessories (collectively referred to in this warranty as “this Product”).
- If you purchased a product from someone other than an authorized Brother reseller in the United States or if the product was used (including but not limited to floor models or refurbished product), prior to your purchase you are not the Original Purchaser and the product that you purchased is not covered by this warranty.

What is covered:

- This Product includes a battery,
- Except as otherwise provided herein, Brother warrants that the Product and battery will be free from defects in materials and workmanship, when used under normal conditions.
- This warranty applies only to products purchased and used in the United States. For products purchased in, but used outside, the United States, this warranty covers only warranty service within the United States (and does not include shipping outside the United States).

What is the length of the Warranty Periods:

- Product: one year from the original purchase date.
- Battery: 90 days from the original purchase date or the rated life, whichever comes first.

What is NOT covered:

This warranty does not cover:

- 1 Physical damage or normal wear and tear to this Product;
- 2 Damage caused by improper installation, improper or abnormal use, misuse, neglect or accident (including but not limited to transporting this Product without the proper preparation and/or packaging);
- 3 Damage caused by another device, power surges or lightning;

- 4 Conditions beyond the control of Brother, such as common carrier provided services, and
- 5 Problems arising from other than defects in materials or workmanship.

This limited warranty is VOID if this Product has been altered or modified in any way (including but not limited to attempted warranty repair without authorization from Brother and/or alteration/removal of the serial number).

What to do if you think your Product is eligible for warranty service:

Report your issue to our Customer Service Hotline at 1-800-284-4329 Supply Brother with a copy of your dated bill of sale showing that this Product was purchased within the U.S

What Brother will ask you to do:

After contacting Brother you may be required to deliver (by hand if you prefer) or send the Product properly packaged, freight prepaid, to the Brother Service Center together with a photocopy of your bill of sale. **You are responsible for the cost of shipping, packing product, and insurance (if you desire). You are also responsible for loss or damage to this Product in shipping.**

What Brother will do:

If the problem reported concerning your Product is covered by this warranty and if you first reported the problem to Brother within the applicable warranty period, Brother will repair or replace the Product at no charge to you for parts or labor. The decision as to whether to repair or replace the Product is made by Brother in its sole discretion. Brother reserves the right to supply a refurbished or remanufactured replacement Product and use refurbished parts provided such replacement products conform to the manufacturer’s specifications for new product/parts. The repaired or replacement Product will be returned to you freight prepaid or made available for you to pick up at the Brother Service Center.

Brother® One Year Limited Warranty and Replacement Service (USA only)

If the Product is not covered by this warranty (either stage), you will be charged for shipping the Product back to you and charged for any service and/or replacement parts/products at Brother's then current published rates.

The foregoing are your sole (i.e., only) and exclusive remedies under this warranty.

What happens when Brother elects to replace your Product:

When a replacement Product is authorized by Brother, and you have delivered the Product to the Brother Service Center, the Brother Service Center will provide you with a replacement Product or Brother will send to you a replacement Product with the understanding that you will, after receipt of the replacement Product, supply the required proof of purchase information, together with the Product that Brother agreed to replace. You are then expected to pack the Product that Brother agreed to replace in the package from the replacement Product and return it to Brother using the pre-paid freight bill supplied by Brother in accordance with the instructions provided by Brother. Since you will be in possession of two Products, Brother will require that you provide a valid major credit card number. Brother will issue a hold against the credit card account number that you provide until Brother receives your original Product and determine that your original Product is entitled to warranty coverage. Your credit card will be charged up to the cost of a new Product only if: (i) you do not return your original Product to Brother within five (5) business days; (ii) the problems with your original Product are not covered by the limited warranty; (iii) the proper packaging instructions are not followed and has caused damage to the product; or (iv) the warranty period on your original Product has expired or has not been sufficiently validated with a copy of the proof of purchase (bill of sale). The replacement Product you receive (even if refurbished or remanufactured) will be covered by the balance of the limited warranty period remaining on the original Product, plus an additional thirty (30) days. You will keep the replacement Product that is sent to you and your original Product shall become the property of Brother. **Retain your original Accessory Items and a copy of the return freight bill, signed by the courier.**

Limitations:

Brother is not responsible for damage to or loss of any equipment, media, programs or data related to the use of this Product. Except for that repair or replacement as described above, Brother shall not be liable for any direct, indirect, incidental or consequential damages or specific relief. Because some states do not allow the exclusion or limitation of consequential or incidental damages, the above limitation may not apply to you.

THIS WARRANTY IS GIVEN IN LIEU OF ALL OTHER WARRANTIES, WRITTEN OR ORAL, WHETHER EXPRESSED BY AFFIRMATION, PROMISE, DESCRIPTION, DRAWING, MODEL OR SAMPLE. ANY AND ALL WARRANTIES OTHER THAN THIS ONE, WHETHER EXPRESS OR IMPLIED, INCLUDING IMPLIED WARRANTIES OF MERCHANTABILITY AND FITNESS FOR A PARTICULAR PURPOSE, ARE HEREBY DISCLAIMED.

- This Limited Warranty is the only warranty that Brother is giving for this Product. It is the *final expression and the exclusive and only statement* of Brother's obligations to you. It replaces all other agreements and understandings that you may have with Brother or its representatives.
- This warranty gives you certain rights and you may also have other rights that may vary from state to state.
- This Limited Warranty (and Brother's obligation to you) may not be changed in any way unless you and Brother sign the same piece of paper in which we (1) refer to this Product and your bill of sale date, (2) describe the change to this warranty and (3) agree to make that change.

Important: We recommend that you keep all original packing materials, in the event that you ship this Product.

Important Information

Federal Communications Commission (FCC) Compliance Notice (USA only)

This equipment is hearing-aid compatible.

Responsible Party: Brother International Corporation
100 Somerset Corporate Boulevard
Bridgewater, NJ 08807-0911
USA
TEL: (908) 704-1700

declares, that the products

Product Name: BCL-D10

comply with Part 15 of the FCC Rules. Operation is subject to the following two conditions: (1) This device may not cause harmful interference, and (2) this device must accept any interference received, including interference that may cause undesired operation.

This equipment has been tested and found to comply with the limits for a Class B digital device, pursuant to Part 15 of the FCC Rules. These limits are designed to provide reasonable protection against harmful interference in a residential installation. This equipment generates, uses, and can radiate radio frequency energy and, if not installed and used in accordance with the instructions, may cause harmful interference to radio communications. However, there is no guarantee that interference will not occur in a particular installation. If this equipment does cause harmful interference to radio or television reception, which can be determined by turning the equipment off and on, the user is encouraged to try to correct the interference by one or more of the following measures:

- Reorient or relocate the receiving antenna.
- Increase the separation between the equipment and receiver.
- Connect the equipment into an outlet on a circuit different from that to which the receiver is connected.
- Call the dealer or an experienced radio/TV technician for help.
- This transmitter must not be co-located or operated in conjunction with any other antenna or transmitter.

- The available scientific evidence does not show that any health problems are associated with using low power wireless devices. There is no proof, however, that these low power wireless devices are absolutely safe. Low power Wireless devices emit low levels of radio frequency energy (RF) in the microwave range while being used. Whereas high levels of RF can produce health effects (by heating tissue), exposure to low-level RF that does not produce heating effects causes no known adverse health effects. Many studies of low-level RF exposures have not found any biological effects. Some studies have suggested that some biological effects might occur, but such findings have not been confirmed by additional research. This equipment has been tested and found to comply with FCC radiation exposure limits set forth for an uncontrolled equipment and meets the FCC radio frequency (RF) Exposure Guidelines in Supplement C to OET65.

IMPORTANT

Changes or modifications not expressly approved by Brother Industries, Ltd. could void the user's authority to operate the equipment.

Industry Canada Compliance Statement (Canada only)

This class B digital apparatus complies with Canadian ICES-003.

Cet appareil numérique de la classe B est conforme à la norme NMB-003 du Canada.

Operation is subject to the following two conditions: (1) This device may not cause interference, and (2) this device must accept any interference, including interference that may cause undesired operation.

The available scientific evidence does not show that any health problems are associated with using low power wireless devices. There is no proof, however, that these low power wireless devices are absolutely safe. Low power Wireless devices emit low levels of radio frequency energy (RF) in the microwave range while being used. Whereas high levels of RF can produce health effects (by heating tissue), exposure to low-level RF that does not produce heating effects causes no known adverse health effects. Many studies of low-level RF exposures have not found any biological effects. Some studies have suggested that some biological effects might occur, but such findings have not been confirmed by additional research. This equipment has been tested and found to comply with IC radiation exposure limits set forth for an uncontrolled equipment and meets RSS-102 of the IC radio frequency (RF) Exposure rules.

Trademark

The Brother logo is a registered trademark of Brother Industries, Ltd.

Brother is a registered trademark of Brother Industries, Ltd.

© 2006 Brother Industries, Ltd. All rights reserved.

All other brand and product names mentioned in this User's Guide are registered trademarks of their respective companies.

1 General Information

Using the documentation	1
Symbols and conventions used in the documentation	1
Introduction	1
Optional Cordless Handset	2
Carton Components	2
Connecting the power cord to the cradle	2
Installing the battery	2
Registering additional cordless handsets	3
Deregistering cordless handsets	4
Choosing a location	5
Important safety instructions	5
Control panel overview	6
LCD display screen	7

2 Telephone

Basic operation	8
Making a telephone call	8
Answering calls	8
Hold	8
Search	8
Call History/Redial	9
Caller ID history	10
Pause	11
Storing numbers for easy dialing	11
Storing numbers	11
Storing numbers from the Call History	12
Storing Tel-Index numbers from the Caller ID history	12
Changing numbers	13
Advanced operation	13
Transferring a call at the end of a conversation	13
Intercom calling	14
Three-way calling	14

3 Menu and Features

On-screen programming	15
Menu keys	15
Memory storage	15
Menu Table	16
Entering Text	17
General setup	18
Ring Volume	18
Beeper Volume	18
Speaker Volume	18
Handset Volume	18
Handset Volume (For Volume Amplify)	18
Ring Pattern	19
Automatic Daylight Savings Time	19

LCD Contrast.....	19
Date and Time	20
Voice Enhance	20
Echo Control.....	20

4 Troubleshooting and Routine Maintenance

Troubleshooting	21
If you are having difficulty with your cordless handset	21
Error messages	22
Routine maintenance.....	23
Charging the battery	23
Cleaning	23
Replacing the battery.....	24

5 Specifications

General	25
Cordless handset.....	25
Battery	25
Battery cradle	26
AC adapter	26
Basic Feature.....	26

Using the documentation

Thank you for buying a Brother machine! Reading the documentation will help you make the most of your cordless handset.

Symbols and conventions used in the documentation

The following symbols and conventions are used throughout the documentation.

Bold Bold typeface identifies specific keys on the control panel of the cordless handset or the machine (base unit).

Italics Italicized typeface emphasizes an important point or refers you to a related topic.

`Courier New` Text in the Courier New font identifies messages on the LCD of the cordless handset.



Warnings tell you what to do to prevent possible personal injury.



Cautions specify procedures you must follow or avoid to prevent possible damage to the cordless handset or other objects.



Notes tell you how you should respond to a situation that may arise or give tips about how the operation works with other features.

Introduction

The cordless handset offers several functions that can be used to enhance the calling features of your Brother machine.

■ Redial:

Allows you to choose one of the last 10 numbers dialed for redialing.

■ Store numbers:

You can store up to 100 names with each having a number available for Tel-Index.

■ Transfer:

Transfer calls between the cordless handset and the machine (base unit). If you have additional optional cordless handsets (4 max.) you can also transfer a call to another cordless handset.

■ Intercom:

Use the intercom feature to make internal calls between the cordless handset and the machine (base unit). If you have additional optional cordless handsets (4 max.) you can also make an intercom call to another cordless handset.

■ Three-way calling:

Three-way calling allows two users to speak with a third party from the machine (base unit) and the cordless handset at the same time.

■ Caller ID:

If you have the Caller ID subscriber service from your telephone company the incoming caller will be identified on the LCD display of the cordless handset. You can also store this number as a Tel-Index number.

Optional Cordless Handset

Your brother machine can support 3 additional cordless handsets for a total of 4 cordless handsets. If you have purchased an optional cordless handset please follow the steps below to setup and register your optional cordless handset with the machine (base unit). For the cordless handset that was included with your machine please follow the setup steps in the Quick Setup Guide.

Carton Components

Make sure you have all the components below.

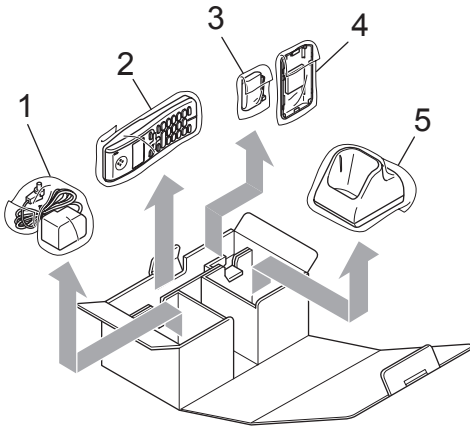

- 1 AC adapter
- 2 Cordless Handset
- 3 Battery
- 4 Battery Cover
- 5 Cradle

Connecting the power cord to the cradle

- 1 Plug the connector into the jack (1) and route the cable through the hook (2) as shown below.

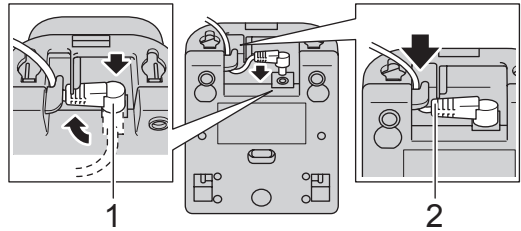

- 2 Plug the adapter into the AC power outlet.

Installing the battery

- 1 Insert the connector (1) of the new battery (2) in the direction shown below.

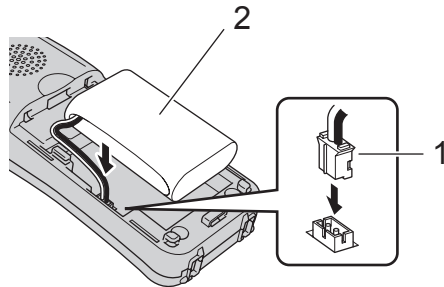

- 2 Place the battery in the correct position as shown below.

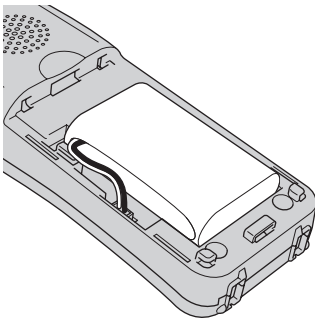

- 3 Slide the battery cover back on.

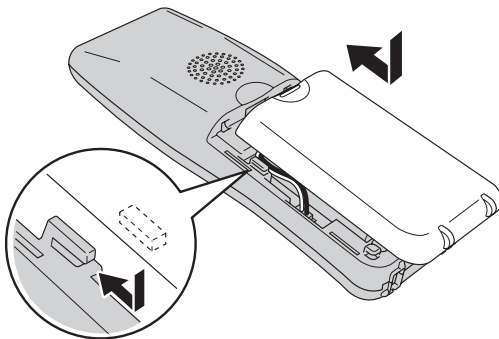

Note

- Be careful that you do not catch the battery connector cord.
- After replacement, you should set the date and time.
(See *Date and Time* on page 20.)

- 4 Charge the battery for 12 hours. (See *Charging the battery* on page 23)

Registering additional cordless handsets

You can register 3 additional cordless handsets for a total of 4 cordless handsets to the machine (base unit). The cordless handset that was included with your machine is already registered with the machine (base unit).

For non-Color LCD models

- 1 Press **Menu/OK** on the cordless handset.



Note

If you see `Enter Register HS mode on Base Unit` on the LCD of the cordless handset, go to step 3.

- 2 Press **▲** or **▼** to choose `Register HS`. Press **Menu/OK**.
- 3 Press **Menu, 0, 6** on the control panel of the machine (base unit).
- 4 Press **OK** on the control panel of the machine (base unit).
You will hear one long beep when the cordless handset is registered correctly.



Note

- If you hear three short beeps, the cordless handset did not register. Repeat steps 2 and 4.
- If you want to install another cordless handset, repeat steps 1 through 4.

- 5 Press **Stop/Exit** on the control panel of the machine (base unit).

For Color LCD model

- 1 Press **Menu/OK** on the cordless handset.



Note

If you see `Enter Register HS mode` on `Base Unit` on the LCD of the cordless handset, go to step 3.

- 2 Press **▲** or **▼** to choose `Register HS`. Press **Menu/OK**.
- 3 Press **Menu** on the control panel of the machine (base unit).
- 4 Press **▲** or **▼** to choose `Initial Setup`. Press **OK**.
- 5 Press **▲** or **▼** to choose `Register Handset`. Press **OK**.
- 6 Press **▲** or **▼** to choose `Register`. Press **OK**.
You will hear one long beep when the cordless handset is registered correctly.



Note

- If you hear three short beeps, the cordless handset did not register. Repeat step 2 and 6.
- If you want to install another cordless handset, repeat steps 1 through 6.

- 7 Press **Stop/Exit** on the control panel of the machine (base unit).

Deregistering cordless handsets

If you want to register a handset that has already been registered, with another machine (base unit), you should deregister it first, and then register it with the other machine (base unit). (See *Registering additional cordless handsets* on page 3.) If you are using more than one cordless handset, deregistration will remove all handsets registered with the machine (base unit).

For non-Color LCD model

- 1 Press **Menu**, **0**, **6** on the control panel of the machine (base unit).
- 2 Press **Erase**.
Then, confirm the Delete by pressing 1.
- 3 Press **Stop/Exit**.

For Color LCD model

- 1 Press **Menu** on the control panel of the machine (base unit).
- 2 Press **▲** or **▼** to choose `Initial Setup`. Press **OK**.
- 3 Press **▲** or **▼** to choose `Register Handset`. Press **OK**.
- 4 Press **▲** or **▼** to choose `Terminate`. Press **OK**.
Then, confirm the Delete by pressing 1.
- 5 Press **Stop/Exit**.

Choosing a location

- Choose a location where the temperature remains between 50° F and 95° F (10° and 35° C).
- DO NOT put the cordless handset and cradle near heaters, air conditioners, water or chemicals.
- DO NOT expose the cordless handset and cradle to direct sunlight, excessive heat, moisture, or dust.
- DO NOT use the cordless handset near electro-medical equipment.
- We recommend at least 9.8 ft (3 m) between the machine (base unit) or cordless handset and other electronic devices.

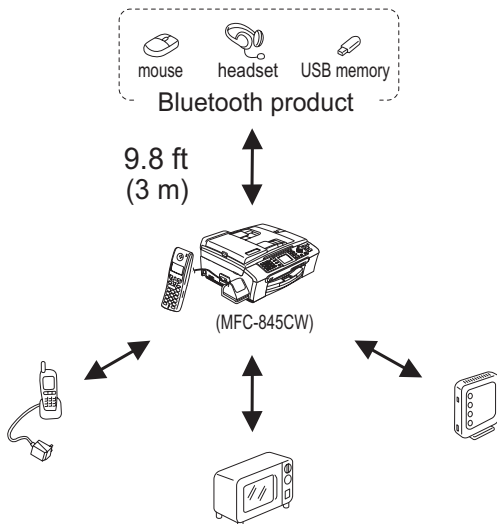

Important safety instructions

! WARNING

Use only the AC adapter and the cradle supplied with this cordless handset.

This product must be installed near an AC power outlet that is easily accessible.

Use only a genuine Brother rechargeable battery.

DO NOT dispose of a used battery in a fire. It may explode.

Corrosive fluid rarely leaks out. If it gets in your eyes wash them with water at once. Call a doctor if you are concerned.

Do not allow the battery to touch any conductive materials. It can cause a short circuit of the battery.

! CAUTION

DO NOT take off the white plastic that covers the battery.

Control panel overview

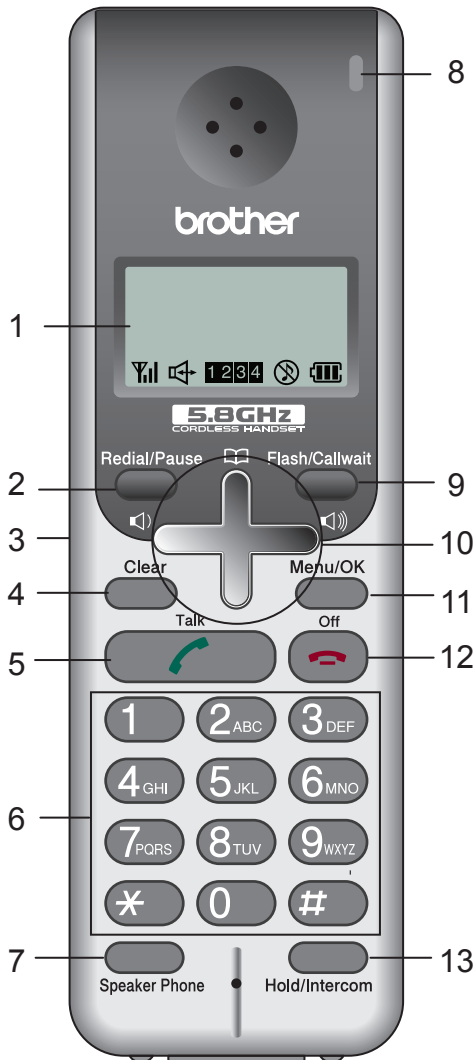

1 LCD (liquid crystal display)

Displays messages on the screen to help you set up and use your cordless handset.

2 Redial/Pause

Redials any of the last 10 numbers you called. It also puts a pause in Quick-Dial numbers.

3 Headphone jack

You can connect an external headphone with microphone (not included) to the cordless handset. To access the headphone jack fold open the headphone jack cover located on the left side of the cordless handset. You can connect any standard headphones that use a 2.5 mm mini style plug.

4 Clear

Press to back up the cursor and delete a letter.

5 Talk

Press to make or receive a phone call.

6 Dial Pad

Use these keys to dial a telephone number and as a keyboard for entering information into the cordless handset.

7 Speaker Phone

Turns the speaker phone on or off.

8 Charging LED

Turns green when the cordless handset is being charged.

9 Flash/Callwait

Use this key to answer another phone call when you hear beeps during the conversation. This feature requires the Call Waiting subscriber service offered by many local telephone companies.

(Canada only) You can make a call from the Caller ID history in combination with a prefix number by pressing this key.

10 Menu keys:

■ Volume keys



You can press these keys to adjust the ring, speaker or handset volume of the cordless handset.

■ ▲ ☰

Lets you look up numbers that are stored in the cordless handset's dialing memory.

- ▲ or ▼

Press to scroll through the menus and options.

11 Menu/OK

Lets you access the Menu to program or store your settings in the cordless handset.

12 Off

Press to hang up or cancel the current operation.

13 Hold/Intercom

Lets you place telephone calls on hold. Also, press this key to speak on the intercom or to transfer an incoming call to the cordless handset.

LCD display screen

The LCD shows the current cordless handset status.

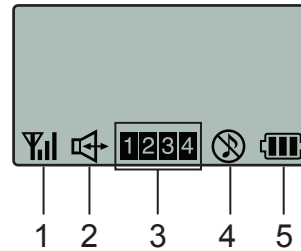

1 Cordless status

A four level indicator shows the current cordless handset signal strength.



2 Speaker Phone

Lets you see when you are speaking with the Speaker Phone.

3 Cordless handset number

Lets you see the cordless handset numbers that have been registered with the machine (base unit).

4 Ring volume status

Lets you see when the ring volume is set to off.

5 Battery status

A four level indicator shows the available battery.

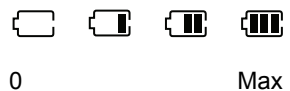

2



Telephone

Basic operation

Making a telephone call

- 1 Pick up the cordless handset.
- 2 Enter a number using the dial pad or choose a number stored in the dialing memory.





- 3 Press  (**Talk**).
- 4 Speak clearly toward the microphone.
- 5 Press  (**Off**) to hang up.
- 6 Replace the cordless handset.

Note

If you want to make a telephone call without lifting the cordless handset, press **Speaker Phone** and enter the number using the dial pad.

Answering calls

- 1 Pick up the cordless handset from the cradle to answer the call. If your cordless handset is not in the cradle you must press  (**Talk**) to answer the call.
- 2 To end the call, press  (**Off**).

- 3 Replace the cordless handset.

When the machine (base unit) or the cordless handset rings, instead of lifting the cordless

handset, and pressing  (**Talk**) you

can also press **Speaker Phone** on the cordless handset. Speak clearly toward the cordless handset. To end the call, press

 (**Off**).

If you have a bad connection, your caller might hear your voice echoed during the call. If you experience this problem, pick up the cordless handset and press **Speaker Phone** to use the handset.

Note

Even if you answer a fax call, the machine (base unit) will receive the fax automatically. (See *Easy Receive* in the User's Guide.)

Hold

If you want to put a call on hold, press the **Hold/Intercom** key. To release the call from hold press **Hold/Intercom** again. You can also transfer a call to the machine (base unit) or to another cordless handset if you have an additional optional cordless handset. (See *Transferring a call at the end of a conversation* on page 13.)

Search

You can search for names you have stored in the Tel-Index memories.

- 1 Pick up the cordless handset.
- 2 Press **▲** and do one of the following:
 - Press **▲** or **▼** to choose the name you want to call.

- Use the dial pad to enter the first letter of the name, press **Menu/OK**, and then press ▲ or ▼ to choose the name you want to call.

Call History/Redial

The last 10 numbers you called will be stored in the call history. You can choose one of these numbers to make a call, add it to Tel-Index, or delete it from the history.

- 1 Pick up the cordless handset.
- 2 Press **Redial/Pause**.
You can also choose Call History by pressing **Menu/OK**.
- 3 Press ▲ or ▼ to choose a number and do one of the following:
 - To make a call, press  (**Talk**).
 - To store or delete the number, press **Menu/OK** and go to step 4.
- 4 Do one of the following:
 - If you want to store the number, press ▲ or ▼ to choose Set Tel-Index. Press **Menu/OK**.
(See *Storing numbers from the Call History* on page 12.)
 - If you want to delete the number, press ▲ or ▼ to choose Delete. Press **Menu/OK**.
Then, confirm the Delete by pressing **1**.
 - If you want to delete all the stored numbers, press ▲ or ▼ to choose All Delete. Press **Menu/OK**.
Then, confirm the Delete by pressing **1**.

Caller ID history

This feature requires the Caller ID subscriber service offered by many local telephone companies. (See *Caller ID in the machine's User's Guide*.)

The last 30 numbers you received will be stored in the Caller ID history. You can choose one of these numbers to make a call, add it to Tel-Index, or delete it from the history.

- 1 Pick up the cordless handset.
- 2 Press **Menu/OK**.
- 3 Press **▲** or **▼** to choose Caller ID hist..
Press **Menu/OK**.
- 4 Press **▲** or **▼** to choose a number and do one of the following:
 - To make a call, press  (**Talk**).
 - To store or delete the number, press **Menu/OK** and go to step 5.
- 5 Do one of the following:
 - If you want to store the number, press **▲** or **▼** to choose Set Tel-Index.
Press **Menu/OK**.
(See *Storing numbers from the Call History* on page 12.)
 - If you want to delete the number, press **▲** or **▼** to choose Delete.
Press **Menu/OK**.
Then, confirm the Delete by pressing **1**.
 - If you want to delete all the stored numbers, press **▲** or **▼** to choose All Delete.
Press **Menu/OK**.
Then, confirm the Delete by pressing **1**.

Note

- This feature may not be available in certain areas of the USA and Canada.
- (USA only) If you redial from the Caller ID history outside your area code you must set up your AREA CODE in advance. (See Setting up your area code on page 10.)
- (Canada only) You can make a call from the Caller ID history in combination with a prefix number. After you enter a prefix number manually, press **Flash/Callwait**. Press **▲** or **▼** to choose a number and press  (**Talk**).

Setting up your area code (USA only)

Your cordless handset will automatically dial "1" plus the area code for any number that does not originate in your area code. The cordless handset can identify local calls from your area code by entering your area code in the Area Code setting. With this setting, calls returned from the caller ID history to your area code will be dialed using only 7-digits. If you must dial the area code to call within your area code, do not enter this setting. If your dialing plan does not follow the standard 1 + area code + 7-digit number dialing system for calling outside your area code, you may experience problems returning calls automatically from the caller ID history. If this is not the procedure followed by your dialing plan you will not be able to return calls automatically.

- 1 Press **Menu/OK**.
- 2 Press **▲** or **▼** to choose Area Code.
Press **Menu/OK**.
- 3 Use the dial pad to enter your area code.
Press **Menu/OK**.
- 4 Press  (**Off**).

Pause

Press **Redial/Pause** to put a 3.5-second pause between numbers. If you are dialing overseas, you can press **Redial/Pause** as many times as needed to increase the length of the pause.

Storing numbers for easy dialing

You can set up your cordless handset for easy dialing. When you dial a Tel-Index number, the LCD shows the name, if you stored it, or the number.





Note

If you lose electrical power, the Tel-Index numbers that are in the memory will not be lost.

Storing numbers

You can store up to 100 locations with a name and a number. When you dial you will only have to press a few keys (for example:

▲ , ▲ or ▼ and  (**Talk**)).

- 1 Pick up the cordless handset.
- 2 Press ▲ .
- 3 Press ▲ or ▼ to choose **Set Tel-Index**. Press **Menu/OK**.
- 4 Do one of the following:
 - Enter the name (up to 14 characters) using the dial pad. Press **Menu/OK**. (To help you enter letters, see *Entering Text* on page 17.)
 - To store the number without a name, press **Menu/OK**.
- 5 Enter the telephone number (up to 20 digits). Press **Menu/OK**.
- 6 Do one of the following:
 - To store another number, go to step 3.
 - To finish the setting, press  (**Off**).

Storing numbers from the Call History

You can also store numbers from the call history.

- 1 Pick up the cordless handset.
- 2 Press **Menu/OK**.
- 3 Press ▲ or ▼ to choose Call History.
Press **Menu/OK**.
- 4 Press ▲ or ▼ to choose the number you want to store.
Press **Menu/OK**.
- 5 Press ▲ or ▼ to choose Set Tel-Index.
Press **Menu/OK**.
- 6 Do one of the following:
 - Enter the name (up to 14 characters) using the dial pad.
Press **Menu/OK**.
(To help you enter letters, see *Entering Text* on page 17.)
 - To store the number without a name, press **Menu/OK**.
- 7 Press **Menu/OK** to confirm the number.

Storing Tel-Index numbers from the Caller ID history

If you have the Caller ID subscriber service from your telephone company you can also store Tel-Index numbers from incoming calls in the Caller ID history. (See *Caller ID* in the User's Guide.)

- 1 Pick up the cordless handset.
- 2 Press **Menu/OK**.
- 3 Press ▲ or ▼ to choose Caller ID hist..
Press **Menu/OK**.
- 4 Press ▲ or ▼ to choose Set Tel-Index.
Press **Menu/OK**.
- 5 Do one of the following:
 - Enter the name (up to 14 characters) using the dial pad.
Press **Menu/OK**.
(To help you enter letters, see *Entering Text* on page 17.)
 - To store the number without a name, press **Menu/OK**.
- 6 Press **Menu/OK** to confirm the number.

Changing numbers

You can change or delete a name or number that has already been stored.

- 1 Pick up the cordless handset.
- 2 Press ▲ □□.
- 3 Press ▲ or ▼ to choose the location you want to change.
Press **Menu/OK**.
- 4 Do one of the following:
 - Press ▲ or ▼ to choose *Change*.
Press **Menu/OK** and go to step 5.
 - Press ▲ or ▼ to choose *Delete*.
Press **Menu/OK**.
Then, confirm the Delete by pressing 1 and  (**Off**).
- 5 Do one of the following:
 - Enter the name (up to 14 characters) using the dial pad.
Press **Menu/OK**.
(See *Entering Text* on page 17.)
 - If you do not want to change the name, press **Menu/OK**.



Note

If you want to change a character, press ◀ or ▶ to position the cursor under the incorrect character and press **Clear**.
Re-enter the correct letter.

- 6 Do one of the following:
 - Enter the new number.
Press **Menu/OK**.
 - If you do not want to change the number, press **Menu/OK**.
- 7 Press  (**Off**).

Advanced operation

You can transfer a call, make an intercom call or use three-way calling. If you have optional cordless handsets you must register the handset with the machine (base unit). See *Registering additional cordless handsets* on page 3. The cordless handset that was included with your machine (base unit) is already registered as Handset 1.

Base Unit	machine
Handset#1	cordless handset 1 included with the machine
Handset#2	optional cordless handset 1
Handset#3	optional cordless handset 2
Handset#4	optional cordless handset 3

Transferring a call at the end of a conversation

You can transfer a call after you speak.

From the machine (base unit)

- 1 When you have finished speaking, press **Hold/Intercom**.
- 2 Press the number of the cordless handset you want to transfer to.
- 3 After you confirm the other person is on the line, hang up.



Note

If no one is on the line, press **Hold/Intercom** to release the call from hold.

From the cordless handset

- 1 Press **Hold/Intercom** when you have finished speaking.
- 2 Press ▲ or ▼ to choose **Base Unit**. Press **Menu/OK**.
- 3 After you confirm the other person is on the line, hang up.



Note

- If no one is on the line, press **Hold/Intercom** to release the call from hold.
- If you have the optional cordless handset, you can choose another cordless handset in step 2.

Intercom calling

The intercom feature allows you to make internal calls between the cordless handset and the machine (base unit). If you have additional optional cordless handsets (4 max.) you can also make an intercom call to another cordless handset.

Making a call from the machine (base unit)

- 1 Press **Hold/Intercom**.
- 2 Press the number of the cordless handset you want to speak with.
- 3 After you have finished speaking, hang up.

Making a call from the cordless handset

- 1 Pick up the cordless handset.
- 2 Press **Hold/Intercom**.

- 3 Press ▲ or ▼ to choose **Base Unit**. Press **Menu/OK**.

- 4 After you have finished speaking, hang up.



Note

If you have the optional cordless handset, you can choose another cordless handset in step 3.

Three-way calling

You can speak with another person on the other handset and a third party in a three-way call. After you speak with the third party, you can make a call to the other handset.

Calling the cordless handset from the machine (base unit)

- 1 Press **Hold/Intercom** when you have finished speaking.
- 2 Press the number of the cordless handset you want to speak with.
- 3 After you confirm the other person is on the line, press **Hold/Intercom**.

Calling the machine (base unit) from the cordless handset

- 1 Press **Hold/Intercom** when you have finished speaking.
- 2 Press ▲ or ▼ to choose **Base Unit**. Press **Menu/OK**.
- 3 After you confirm the other person is on the line, press **Hold/Intercom**.



Note

If you have the optional cordless handset, you can choose other options in step 2.

3





Menu and Features

On-screen programming

Your cordless handset is designed to be easy to use with LCD on-screen programming using the menu keys. User-friendly programming helps you take full advantage of all the menu selections your cordless handset has to offer.

Since your programming is done on the LCD, we have created step-by-step on-screen instructions to help you program your cordless handset. All you need to do is follow the instructions as they guide you through the menu selections and programming options.

Menu keys

 Menu/OK	Access the menu. Go to the next menu level. Accept an option.
 Clear	Delete an incorrect letter when you need to enter text into the cordless handset. Go back to the previous menu level.
	Scroll through the current menu level.
	Exit the menu.

To access the menu mode:

- 1 Press **Menu/OK**.
- 2 Press ▲ or ▼ to choose an option.
- 3 Press **Menu/OK** when that option appears on the LCD.
The LCD will then show the next option.
- 4 Press ▲ or ▼ to choose the option.
- 5 Press **Menu/OK**.
When you have finished setting an option, the LCD shows *Accepted*.

Memory storage

Even if there is a battery power failure, you will not lose your menu settings because they are stored permanently. You may have to reset the date and time.

Menu Table

The menu table will help you understand the menu selections and options that are found in the cordless handset's programs. The factory settings are shown in Bold with an asterisk.

Level1	Level2	Options	Descriptions	Page
Setup Volume	Beeper	On* Off	Adjusts the volume level of the beeper.	18
	Volume Amplify	On Off*	For the hearing-impaired, you can set the volume to the On setting.	18
Ringer Pattern	—	Signal 1* Signal 2 Signal 3 Signal 4 Signal 5 Melody 1 Melody 2	You can choose a ring pattern.	19
Call History	—	Delete All Delete Set Tel-Index	You can choose a number from the call history and then make a phone call to it, add it to Tel-Index, or delete it.	9
Caller ID hist.	—	Delete All Delete Set Tel-Index	You can choose a number from the Caller ID history and then make a phone call to it, add it to Tel-Index, or delete it.	10
Auto Daylight	—	On Off*	Changes for Daylight Savings Time automatically.	19
LCD Contrast	—	1 2 3 4* 5 6 7	Adjusts the contrast of the LCD.	19
Date&Time	—	—	Puts the date and time on the LCD.	20
Register HS	—	—	Registers the cordless handset into the machine (base unit).	3
Voice Enhance	—	On* Off	Changing this setting to Off will increase the battery life but may reduce voice quality.	20

Entering Text

When you are storing a name or a number in the Tel-Index memory, you may need to enter text into the cordless handset. Most dial pad keys have three or four letters printed on keys. The keys for **0**, **#** and ***** do not have printed letters because they are used for special characters.

By pressing the proper dial pad key repeatedly, you can access the character you want.

Press Key	one time	two times	three times	four times
2	A	B	C	2
3	D	E	F	3
4	G	H	I	4
5	J	K	L	5
6	M	N	O	6
7	P	Q	R	S
8	T	U	V	8
9	W	X	Y	Z

Putting spaces

To enter a space in a telephone number, press **►** once between numbers. To enter a space in a name, press **►** twice between characters.

Making corrections

If you entered an incorrect letter and want to change it, press **◀** to move the cursor under the incorrect character. Then press **Clear**. Re-enter the correct character. You can also back up and insert letters.

Repeating letters

If you need to enter a letter that is on the same key as the letter before, press **►** to move the cursor to the right before you press the key again.

Special characters and symbols

Press *****, **#** or **0**, repeatedly until you see the special character or symbol you want.

Press *	for	(space) ! " # \$ % & ' () * + , - . / €
Press #	for	:: ; < = > ? @ [] ^ _
Press 0	for	É À È Ê Î Ç Ë Ö 0

General setup

Ring Volume

You can choose a range of ring volume levels, from High to Off.

- 1 Press or to adjust the volume level.
This setting will stay until you change it again.



Note

- If you choose Off, will appear on the LCD.
- Even if you choose Off, the cordless handset will ring in the lowest volume level when you receive a transferred call.

Beeper Volume

When the beeper is on, the cordless handset will beep when you press a key or make a mistake.

- 1 Press **Menu/OK**.
- 2 Press or to choose **Setup Volume**.
Press **Menu/OK**.
- 3 Press or to choose **Beeper**.
Press **Menu/OK**.
- 4 Press or to **On** or **Off**.
Press **Menu/OK**.
- 5 Press (**Off**).

Speaker Volume

You can choose a range of speaker volume levels, from High to Low.

- 1 Press **Speaker Phone**.

- 2 Press or .
This setting will stay until you change it again.

- 3 Press (**Off**).

Handset Volume

You can adjust the cordless handset volume any time you are talking on the telephone.

- 1 Press or .
This setting will stay until you change it again.

Handset Volume (For Volume Amplify)

Before you begin to use the cordless handset, you must decide if you need to set the cordless handset volume to **Volume Amplify:On** for a user who is hearing-impaired. The AMPLIFY volume level complies with FCC standards. Before you use this setting, see *Choosing the Handset Volume (For Volume Amplify)* in the machine's User's Guide.

- 1 Press **Menu/OK**.
- 2 Press or to choose **Setup Volume**.
Press **Menu/OK**.
- 3 Press or to choose **Volume Amplify**.
Press **Menu/OK**.
- 4 Do one of the following:
 - If *none* of the users are hearing-impaired, press or to choose **Off**, and then press **Menu/OK** and go to step 6.
 - If *some* or *all* of the users are hearing-impaired, press or to choose **On**, and then press **Menu/OK**.

- 5 Do one of the following:
 - If *all* the users are hearing-impaired, press ▲ or ▼ to choose **Permanent**, and then press **Menu/OK**.
 - If only *some* of the users are hearing-impaired, press ▲ or ▼ to choose **Temporary**, and then press **Menu/OK**.
- 6 Press  (Off).

WARNING

It is important that you do **NOT** choose **Permanent** unless **ALL** the users are **hearing-impaired**. Otherwise, the default setting of **Volume Amplify** may damage the hearing of some users.

Ring Pattern

You can choose a ring pattern from five signal (regular ring patterns) or two types of melodies.

- 1 Press **Menu/OK**.
- 2 Press ▲ or ▼ to choose **Ringer Pattern**. Press **Menu/OK**.
- 3 Press ▲ or ▼ to choose **Signal 1**, **Signal 2**, **Signal 3**, **Signal 4**, **Signal 5**, **Melody 1** or **Melody 2**. Press **Menu/OK**.
- 4 Press  (Off).

Melody name

Melody 1	Grandfather's clock
Melody 2	The four seasons concerto "Spring" 1

Automatic Daylight Savings Time

You can set the cordless handset to change automatically for daylight savings time. It will reset itself forward one hour in the Spring and backward one hour in the Fall. Make sure you have set the correct date and time in the **Date&Time** setting.

- 1 Press **Menu/OK**.
- 2 Press ▲ or ▼ to choose **Auto Daylight**. Press **Menu/OK**.
- 3 Press ▲ or ▼ to choose **On** or **Off**. Press **Menu/OK**.
- 4 Press  (Off).

LCD Contrast

You can adjust the LCD contrast for a sharper and more vivid display. If you are having difficulty reading the LCD, try changing the contrast setting.

- 1 Press **Menu/OK**.
- 2 Press ▲ or ▼ to choose **LCD Contrast**. Press **Menu/OK**.
- 3 Press ◀ or ▶ to adjust the contrast. Press **Menu/OK**.
- 4 Press  (Off).

Date and Time

The cordless handset displays the date and time.

- 1 Press **Menu/OK**.
- 2 Press **▲** or **▼** to choose *Date&Time*. Press **Menu/OK**.
- 3 Enter the two digits for the month on the dial pad.
(e.g. Enter **0 3** for March.)
- 4 Enter the last two digits for the day on the dial pad.
(e.g. Enter **0 1** for the first day of the month.)
- 5 Enter the last two digits of the year on the dial pad.
Press **Menu/OK**.
(e.g. Enter **0 6** for 2006.)
- 6 Enter the time in 24-hour format on the dial pad.
Press **Menu/OK**.
(e.g. Enter **1 5 2 5** for 3:25 P.M.)
- 7 Press  (**Off**).

Voice Enhance

The voice enhance setting offers the best reception quality under all conditions. This setting is On as factory default. If you normally use the cordless handset in close proximity to the machine (base unit) then you can set voice enhance Off to increase the battery life. With this setting Off you may experience reduced reception quality.

- 1 Press **Menu/OK**.
- 2 Press **▲** or **▼** to choose *Voice Enhance*. Press **Menu/OK**.
- 3 Press **▲** or **▼** to choose *Off* (or *On*). Press **Menu/OK**.
- 4 Press  (**Off**).

Echo Control

Under some conditions you may experience an echo when using the cordless handset. You can reduce or remove the echo by choosing a level in the echo control setting from the control panel of the machine (base unit). It will take about one minute for the level setting to change. During this time you can not answer a call.

For non-color LCD model

- 1 Press **Menu, 1, 8** on the control panel of the machine (base unit).
- 2 Press **▲** or **▼** to choose *level1*, *level2*, *level3* or *level4*. Press **OK**.
- 3 Press **Stop/Exit**.

For color LCD model

- 1 Press **Menu** on the control panel of the machine (base unit).
- 2 Press **▲** or **▼** to choose *General Setup*. Press **OK**.
- 3 Press **▲** or **▼** to choose *Echo Control*. Press **OK**.
- 4 Press **▲** or **▼** to choose *level1*, *level2*, *level3* or *level4*. Press **OK**.
- 5 Press **Stop/Exit**.

4

Troubleshooting and Routine Maintenance

Troubleshooting

IMPORTANT

For technical help, you must call the country where you bought the cordless handset. Calls must be made **from within** that country.

If you think there is a problem with your cordless handset, check the chart below and follow the troubleshooting tips.

Most problems can be easily resolved by yourself. If you need additional help, the Brother Solutions Center offers the latest FAQs and troubleshooting tips. Visit us at <http://solutions.brother.com>.

If you are having difficulty with your cordless handset

Difficulties	Suggestions
The cordless handset does not operate.	Check that the battery is charged properly. (See <i>Charging the battery</i> on page 23.)
Dialing or receiving does not work.	Check that the phone line connection of the machine (base unit).
	Check that the machine (base unit) is plugged in and the On/Off key on the machine (base unit) is on.
	Check that the battery is charged properly. (See <i>Charging the battery</i> on page 23.)
	Come closer to the machine (base unit). The cordless handset may be too far from the machine (base unit).
Bad phone line connection	Check that there are no electronic devices between the machine (base unit) and the cordless handset.
	Come closer to the machine (base unit). The cordless handset may be too far from the machine (base unit).
	During the conversation, try to adjust the angle of the antenna to improve reception.
	Move away from walls.
	Try to change the Echo Control setting. (See <i>Echo Control</i> on page 20.)
The battery does not charge.	Check that the battery is installed properly in the cordless handset. (See <i>Replacing the battery</i> on page 24.)
	Check that the cordless handset is placed properly in the cradle and LED turns green. (See <i>Charging the battery</i> on page 23.)
	Clean the charger contacts for both cordless handset and the cradle. (See <i>Cleaning</i> on page 23.)
The battery performance is still poor after recharging.	It is time to replace the battery. (See <i>Replacing the battery</i> on page 24.)

Difficulties	Suggestions
The cordless handset beeps during a call.	Come closer to the machine (base unit). The cordless handset may be too far from the machine (base unit).
	Your battery may be low. If you want to continue the call, transfer the call to the machine (base unit) and use the Speaker Phone key to answer. (See <i>Transferring a call at the end of a conversation</i> on page 13.) And then, charge the battery. (See <i>Charging the battery</i> on page 23.)
You cannot make an internal call.	The cordless handset or the machine you want to call to may be on an internal call or an outside call. Wait until the line is free.
You cannot register the optional cordless handset.	Check that both the cordless handset and the machine (base unit) are in standby mode.

Error messages

As with any sophisticated office product, errors may occur. If this happens, your cordless handset identifies the error and shows an error message. The most common error messages are shown below.

You can correct most errors by yourself. If you need more help, the Brother Solutions Center offers latest FAQs and troubleshooting tips.

Visit us at <http://solutions.brother.com>.

Error Message	Cause	Action
Base Unit in use	The machine (base unit) is being used for intercom calling.	Wait until the line is free.
	The machine (base unit) is being set up for cordless handset registration.	Wait until the registration is finished.
	The machine (base unit) is being used for Message Center functions such as OGM recording or ICM playing.	Wait until machine (base unit) is back in standby mode.
Cannot register handset	You failed to register the cordless handset.	Try to register the cordless handset again. (See <i>Registering additional cordless handsets</i> on page 3.)
Line in use	Another person is on the phone line using the machine's (base unit) speaker phone or another cordless handset.	Wait until the line is free.
	The machine (base unit) is receiving faxes.	Wait until the line is free.
<Low battery> Put handset on cradle	The battery of the cordless handset is low.	Charge the battery. (See <i>Charging the battery</i> on page 23.)
No Caller ID	You have not subscribed to the Caller ID service from your telephone company.	If you want to use the Caller ID feature call your telephone company. (See <i>Caller ID</i> in the User's Guide.)

Error Message	Cause	Action
Searching for Base Unit (Base Unit not detected)	The cordless handset is too far from the machine (base unit).	Bring the cordless handset closer to the machine (base unit).
	The On/Off key on the machine (base unit) is off.	Check that the machine (base unit) is plugged in and the On/Off key on the machine (base unit) is on.
	You have not registered the cordless handset.	Register the cordless handset. (See <i>Registering additional cordless handsets</i> on page 3.)

Routine maintenance

Charging the battery

If your battery is getting low, you should charge the battery. You can see the battery strength at the bottom right of the LCD.

- 1 Plug the AC adapter into the AC power outlet.
- 2 Place the cordless handset in the cradle with the dial pad facing forward.

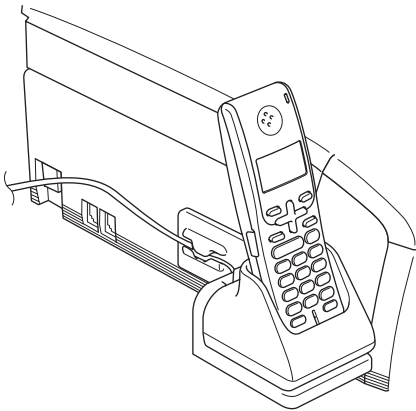

Cleaning

Clean the outside of the cordless handset with a soft cloth. You should also clean the charger contacts. If the charger contacts are not clean, the battery may not be charged.

! CAUTION

Use neutral detergents. Cleaning with volatile liquids such as thinner or benzine will damage the outside surface of the cordless handset.

DO NOT use cleaning materials that contain ammonia.

DO NOT use isopropyl alcohol to remove dirt from the control panel. It may crack the panel.

Clean the charger contacts as follows:

- 1 Unplug the cradle from the AC power outlet.
- 2 Clean the charger contacts (1) for both the cordless handset and the cradle with a cotton swab.

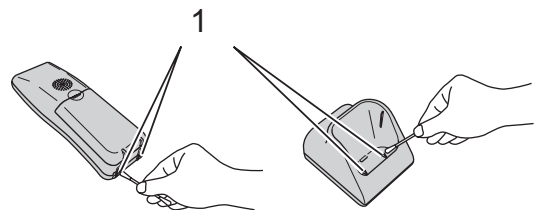

Replacing the battery

If your battery performance is getting worse, make sure that you have charged the battery correctly. If the battery performance is still poor, it is time to replace it.



WARNING

Use a genuine Brother rechargeable battery (BCL-BT10). If not, it may cause damage or personal injury.



CAUTION

DO NOT take off the white plastic that covers the battery.

- 1 Press the area indicated (1) on the battery cover (2) and slide it off the cordless handset.

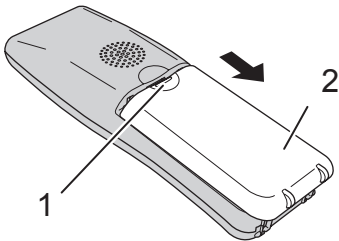

- 2 Remove the old battery and pull out the connector.
- 3 Insert the connector (1) of the new battery (2) in the direction shown below.

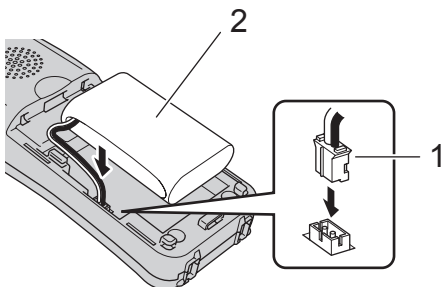

- 4 Place the battery in the correct position.

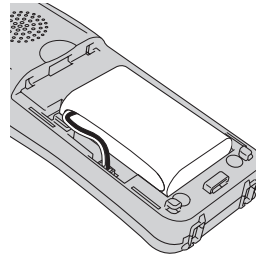

- 5 Slide the battery cover back on.

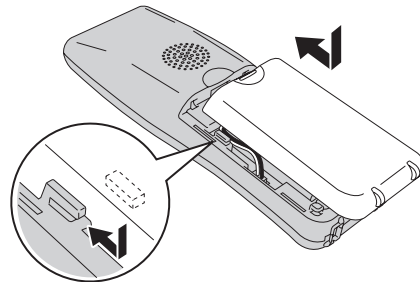

Note

- Be careful that you do not catch the battery connector cord.
- After replacement, you should set the date and time. (See *Date and Time* on page 20.)

- 6 Charge the battery for 12 hours. (See *Charging the battery* on page 23)



CAUTION



ATTENTION:

The product you have purchased is powered by Nickel Metal Hydride battery which is recyclable. At the end of their useful lives, under various state and local laws, it is illegal to dispose of this battery into your municipal waste stream. Please call 1-800-8-BATTERY or visit www.rbc.com for information on how to recycle this battery.

5

Specifications

General

Cordless handset

Frequency	5.8 GHz
Technology	FHSS (Frequency Hopping Spread Spectrum)
Multi Handset Capability	Up to 4 handsets
Dimensions	

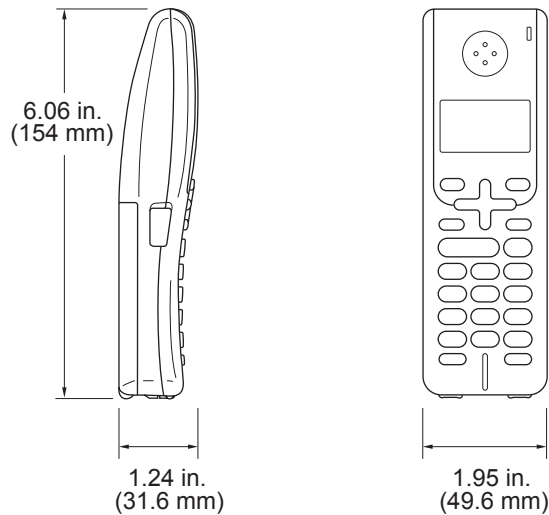

Weight (including battery)	5.43 oz (154 g)
LCD (liquid crystal display)	16-Digit, 3-Line (+1-Line for Pict), Backlit (Orange)
Charge Indicator	Yes (LED)
Full Charge Time	12 hours
While in Use (TALK)	4 hours ¹ 6 hours ²
While Not in Use (Standby)	200 hours

¹ When Voice Enhance is set to On.

² When Voice Enhance is set to Off.

Battery

Type	BCL-BT10
Rating	Ni-MH 3.6 V 730 mAh

Battery cradle

Dimensions

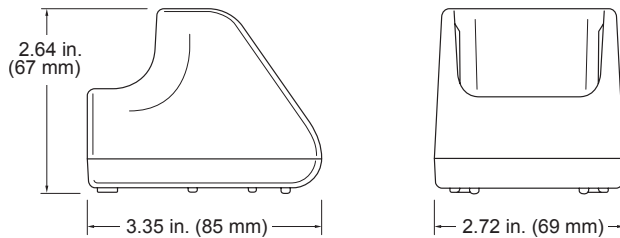

Weight

2.53 oz (71.6 g)

Power Consumption (during charge)

Charging: Average 2 W

AC adapter

Type

BCL-ADA

Input

AC 100 to 240 V 50/60 Hz

Output

DC 11.0 V

Basic Feature

Tel-Index

Up to 100 names × 1 numbers

Redial

Yes

Melody ringer patterns

Yes (2 melodies, 5 signals)

2 Way Intercom

Handset-to-Handset and Handset-to-Base Unit

Talk Time display

Yes

6

Index

A	
Accessories and supplies	ii
B	
Battery	
charging	23
installing	2
power failure	15
recycling	24
replacing	24
Brother	
accessories and supplies	ii
Brother numbers	i
Customer Service	i
FAQs (frequently asked questions)	i
product support	i
Warranties	iii
C	
Cleaning	23
Control panel overview	6
D	
Date and time	20
Daylight saving time	19
Dialing	
call history	9
caller ID history	10
pause	11
tel-index	8
E	
Echo Control	20
Error messages on LCD	22
H	
HELP	
LCD messages	15
using menu keys	15
menu table	15
L	
LCD (liquid crystal display)	7, 15
contrast	19
M	
Maintenance, routine	23
Memory storage	15
Menu table	16
O	
Optional cordless handset	2
deregistering	4
registering	3
P	
Programming your cordless handset	15
R	
Redial/Pause	9
Ring pattern	19
S	
Safety instructions	5
T	
Telephone	8
call history	9
caller ID history	10
hold	8
intercom	1, 14
three-way calling	1, 14
transferring	13
Tel-Index	
changing	13
deleting	13
storing	11
from call history	12
from caller ID history	12
Text, entering	17
special characters	17

Troubleshooting	21
error messages on LCD	22
if you are having difficulty	21

V

Voice enhance	20
Volume, setting	
beeper	18
handset	18
volume amplify	18
ring	18
speaker	18

W

Warranties	
USA	iii
World Wide Web	i

Brother International Corporation
100 Somerset Corporate Boulevard
P.O. Box 6911
Bridgewater, NJ 08807-0911 USA

brother[®]

**Visit us on the World Wide Web
<http://www.brother.com>**

These machines are made for use in the USA only. We cannot recommend using them overseas because it may violate the Telecommunications Regulations of that country and the power requirements of your cordless handset AC adapter may not be compatible with the power available in foreign countries. **Using USA models overseas is at your own risk and may void your warranty.**



LP5403001
USA
Printed in China