

OWNER'S
MANUAL

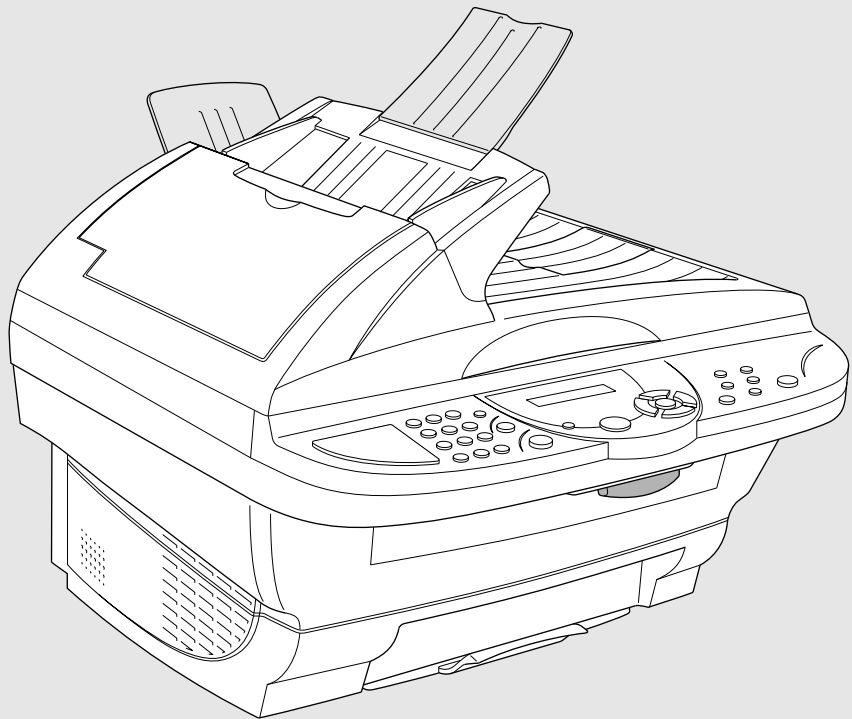

DCP-1000

brother.

If You Need to Call Customer Service

Please complete the following information for future reference:

Model Number: DCP-1000

Serial Number*: _____

Date of Purchase: _____

Place of Purchase: _____

*** The serial number is on the back of the unit. Retain this Owner's Manual with your sales receipt as a permanent record of your purchase, in the event of theft, fire or warranty service.**

Brother Numbers

IMPORTANT

For technical and operational assistance, you must call the country where you purchased the machine. Calls must be made *from within* that country.

Brother fax-back system

Brother Customer Service has installed an easy-to-use fax-back system, so you can get instant answers to common technical questions and product information for all Brother products. This system is available 24 hours a day, 7 days a week. You can use the system to send faxes to any fax machine.

If you can't resolve a difficulty with your Brother Digital Copier/Printer using this manual, call our fax-back system and follow the voice prompts to receive faxed instructions about using the system and an index of fax-back subjects.

In USA: 1-800-521-2846

In Canada: 1-800-681-9838
1-514-685-5381 (in Montreal)

Frequently Asked Questions (FAQs)

The Brother Solutions Center is our one-stop resource for all your Digital Copier/Printer needs. You can download the latest software and utilities, read FAQs and troubleshooting tips, and go to the "Solutions" section to learn how to get the most from your Brother product.

<http://solutions.brother.com>



You can check here for Brother Printer Driver updates.

For Customer Service

In USA: 1-800-284-4329 (voice)
1-908-575-8790 (fax)
1-800-284-3238 (TTY service for the hearing-impaired)

In Canada: 1-800-853-6660 (voice)
1-514-685-4898 (fax)
1-514-685-6464 (voice) (in Montreal)

Dealers/Service Centers (USA Only)

For the name of a Brother authorized dealer or service center, call 1-800-284-4357.

Service Centers (Canada Only)

For service center addresses in Canada, call 1-800-853-6660.

Ordering Accessories and Supplies

IMPORTANT

For technical and operational assistance, you must call the country where you purchased the machine. Calls must be made *from within* that country.

For best quality results use only genuine Brother accessories, available at most Brother retailers. If you cannot find the accessory you need and you have a Visa, MasterCard, Discover or American Express credit card, you can order accessories directly from Brother. (In the USA, you can visit us online for a complete selection of Brother accessories and supplies available for purchase.)

In USA: 1-888-879-3232 (voice)
1-800-947-1445 (fax)
<http://www.brothermall.com>

In Canada: 1-800-668-2768 (voice)

Description	Item
Laser Fax Toner	TN-250
Laser Fax Drum	DR-250
Paper Support	LE1931008
Power Protector for A/C Power and Phone Line Surges and Voltage Spikes	QPD120
Power Protector for A/C Power and Phone Line Surges and Voltage Spikes (8 Outlets)	FX 120
Owner's Manual	LE7008001
IEEE-1284 Bi-directional Parallel Cable	F2A046-10

** Multi-Function Link[®] Pro Suite is NOT available on floppy disks.

Product Registration (For USA Only)

To Complete Your DCP-1000 Registration On-Line:

- 1 Insert the MFL Pro Suite CD-ROM into your CD-ROM drive.
- 2 Click **On-Line Registration** to register your product from the main menu.

Notice – Disclaimer of Warranties (For USA and Canada)

BROTHER'S LICENSOR(S), AND THEIR DIRECTORS, OFFICERS, EMPLOYEES OR AGENTS (COLLECTIVELY BROTHER'S LICENSOR) MAKE NO WARRANTIES, EXPRESS OR IMPLIED, INCLUDING WITHOUT LIMITATION THE IMPLIED WARRANTIES OF MERCHANTABILITY AND FITNESS FOR A PARTICULAR PURPOSE, REGARDING THE SOFTWARE. BROTHER'S LICENSOR(S) DOES NOT WARRANT, GUARANTEE OR MAKE ANY REPRESENTATIONS REGARDING THE USE OR THE RESULTS OF THE USE OF THE SOFTWARE IN TERMS OF ITS CORRECTNESS, ACCURACY, RELIABILITY, CURRENTNESS OR OTHERWISE. THE ENTIRE RISK AS TO THE RESULTS AND PERFORMANCE OF THE SOFTWARE IS ASSUMED BY YOU. THE EXCLUSION OF IMPLIED WARRANTIES IS NOT PERMITTED BY SOME STATES IN THE USA AND SOME PROVINCES IN CANADA. THE ABOVE EXCLUSION MAY NOT APPLY TO YOU.

IN NO EVENT WILL BROTHER'S LICENSOR(S) BE LIABLE TO YOU FOR ANY CONSEQUENTIAL, INCIDENTAL OR INDIRECT DAMAGES (INCLUDING DAMAGES FOR LOSS OF BUSINESS PROFITS, BUSINESS INTERRUPTION, LOSS OF BUSINESS INFORMATION, AND THE LIKE) ARISING OUT OF THE USE OR INABILITY TO USE THE SOFTWARE EVEN IF BROTHER'S LICENSOR HAS BEEN ADVISED OF THE POSSIBILITY OF SUCH DAMAGES. BECAUSE SOME STATES IN THE USA AND SOME PROVINCES IN CANADA DO NOT ALLOW THE EXCLUSION OR LIMITATION OF LIABILITY FOR CONSEQUENTIAL OR INCIDENTAL DAMAGES, THE ABOVE LIMITATIONS MAY NOT APPLY TO YOU. IN ANY EVENT BROTHER'S LICENSOR'S LIABILITY TO YOU FOR ACTUAL DAMAGES FROM ANY CAUSE WHATSOEVER, AND REGARDLESS OF THE FORM OF THE ACTION (WHETHER IN CONTRACT, TORT (INCLUDING NEGLIGENCE), PRODUCT LIABILITY OR OTHERWISE), WILL BE LIMITED TO \$50.

Compilation and Publication Notice

Under the supervision of Brother Industries Ltd., this manual has been compiled and published, covering the latest product descriptions and specifications.

The contents of this manual and the specifications of this product are subject to change without notice.

Brother reserves the right to make changes without notice in the specifications and materials contained herein and shall not be responsible for any damages (including consequential) caused by reliance on the materials presented, including but not limited to typographical and other errors relating to the publication.

BROTHER ONE YEAR LIMITED WARRANTY and EXCHANGE SERVICE (USA Only)

This warranty gives you certain rights and you may also have other rights that may vary from state to state.

This warranty is given only to the first end-use purchaser of the accompanying product (referred to in this warranty as “this Product”).

What is covered: Brother warrants to you for the Warranty Period that there are no defects in the materials, workmanship or Year 2000 compliance of this Product. The “Warranty Period” is 1 year from the date you purchased this product. The “Warranty Period” for consumable items, such as Print Heads, Toner, Drums, Ink Cartridges, Print Cartridges, Refill Ribbons, Therma PLUS Paper and Thermal Paper, etc. is 90 days from the date of purchase, or the rated life of the Consumable item, whichever is shorter.

What is NOT covered: This warranty is VOID — that is, this Product has no warranty — if: (1) you did not purchase this Product from an authorized Brother reseller within the United States, (2) this Product has been serviced, modified or tampered with by anyone other than an Authorized Service Representative of Brother, (3) the serial number has been modified, defaced or removed from this Product, (4) this Product has been abused or damaged, or, the recommended monthly volume has been exceeded, (5) non Brother®-brand or non Brother approved parts, supplies, power supplies or other accessories have been used with this Product, or (6) this Product has been transported without the proper preparation and packaging.

What to do if you think your Product is defective: Call our Customer Service Hotline at 1-800-284-4329, or if you suspect a defect in materials or workmanship in this Product, you can report it to a Brother Authorized Service Center. During the Warranty Period, supply Brother’s representative with a copy of your dated bill of sale showing that this Product was purchased within the United States. For the name of your Brother Authorized Service Center, call 1-800-521-2846. After contacting the

Brother Authorized Service Center, you may be required to deliver or send the Product properly packaged, freight prepaid, to the Authorized Service Center together with a photocopy of your bill of sale.

What Brother will do: Brother (or its Authorized Service Center) will evaluate your report of a possible defect to determine whether a defect exists, and if it does exist, Brother (or its Authorized Service Center) will repair or (at Brother’s option) replace the Product with a product that performs the same functions and performs as well as the original Product. Brother reserves the right to supply refurbished or remanufactured replacement parts provided that the replacement parts conform to the manufacturer’s specifications for new products. The repaired or replacement product will be returned to you at no cost.

Exchange Service: When an exchange is authorized, Brother will exchange your non-working product with a refurbished or remanufactured product that conforms to the manufacturer’s specifications for new products. The refurbished or remanufactured Product you receive will be covered by the balance of the limited warranty period remaining on the original Product, plus an additional thirty (30) days. You will keep the replacement Product that is sent to you and must return (or be billed up to the cost of a new product) your original non-working product, which shall become the property of Brother. You must call Brother Customer Service and if the representative cannot correct the product’s malfunction over the telephone and you elect the exchange service, you must provide information pertaining to this Product and you must also provide a valid major credit card number. Your credit card will be charged up to the cost of a new Product if: (i) you do not return your original Product to Brother within five (5) business days; (ii) the malfunctions of your original Product are not covered by the limited warranty;

BROTHER ONE YEAR LIMITED WARRANTY and EXCHANGE SERVICE (USA Only)

(iii) the proper packaging instructions are not followed and has caused damage to the product; or (iv) the warranty period on your original Product has expired or has not been sufficiently validated with a copy of the proof of purchase (bill of sale). The Brother Customer Service Representative will ship the exchange Product via next business day delivery courier service, with return instructions and prepaid return air bill. Follow the return instructions. You must return the original Product in the same shipping carton in which the exchanged Product was received and include a copy of proof of purchase (bill of sale). Retain your original accessory items and a copy of the return air bill, signed by the courier.

Limitations: Repair or replacement as described above is your sole and exclusive (that is, your only) remedy if this Product is defective. Brother is not responsible for damage to or loss of any equipment, media, programs or data related to the use of this Product. Except for that repair or replacement, *Brother shall not be liable for any direct, indirect, incidental or consequential damages or specific relief. Because some states do not allow the exclusion or limitation of consequential or incidental damages, the above limitation may not apply to you.*

THIS WARRANTY IS GIVEN IN LIEU OF ALL OTHER WARRANTIES, WRITTEN OR ORAL, WHETHER EXPRESSED BY AFFIRMATION, PROMISE, DESCRIPTION, DRAWING, MODEL OR SAMPLE. ANY AND ALL WARRANTIES OTHER THAN THIS ONE, WHETHER EXPRESS OR IMPLIED, INCLUDING IMPLIED WARRANTIES OF MERCHANTABILITY AND FITNESS FOR A PARTICULAR PURPOSE, ARE HEREBY DISCLAIMED.

This Limited Warranty is the only warranty that Brother is giving for this Product. It is the *final expression and the exclusive and only statement* of Brother's obligations to you. It replaces all other agreements and under-

standings that you may have with Brother or its representatives.

This Limited Warranty (and Brother's obligation to you) may not be changed in any way unless you and Brother sign the same piece of paper in which we (1) refer to this Product and your bill of sale date, (2) describe the change to this warranty and (3) agree to make that change.

Product Support: Toll-free customer service and technical support is available for hardware operational assistance at 1-800-284-4329. At any time, free technical support in the form of Frequently Asked Questions, troubleshooting tips and service center locator is available through our fax-back system at 1-800-521-2846 or Brother's Internet Web Site (www.brother.com). Now you can visit us on-line (www.brothermall.com), your complete source for genuine Brother Accessories and Supplies.

**BROTHER INTERNATIONAL CORPORATION
100 SOMERSET CORPORATE BLVD.**

BRIDGEWATER, NEW JERSEY 08807-0911

Please record your model and serial numbers and your date and location of Purchase below for your records. Keep this information with your proof of purchase (bill of sale) in case your Product is lost, stolen or requires service.

Model # _____

Serial # _____

Date of purchase: _____

Store where purchased: _____

Location of store: _____

Important: *We recommend that you keep all original packing materials, in the event that you ship this product.*

BROTHER DIGITAL COPIER/PRINTER MACHINE LIMITED WARRANTY (For Canada Only)

Pursuant to this limited warranty of 1 year from the date of purchase for labour and parts, Brother International Corporation (Canada) Ltd. ("Brother"), or its Authorized Service Centers, will repair this Copier/Printer free of charge if defective in material or workmanship. This Limited Warranty does not include cleaning, consumables (including, without limitation, print cartridges, print head, toner, and drum) or damage caused by accident, neglect, misuse or improper installation or operation, any damage caused from service, maintenance, modifications, or tampering by anyone other than a Brother Authorized Service Representative, or from the use of supplies or consumable items that are non-Brother products. Operation of the Copier/Printer in excess of the specifications or with the Serial Number or Rating Label removed shall be deemed abuse and all repairs thereafter shall be the sole liability of the end-user/purchaser. In order to obtain warranty service, the Copier/Printer must be delivered or shipped freight prepaid by the end user/purchaser to a "Brother" Authorized Service Center, together with your Proof of Purchase in the form of a Sales Receipt.

For laser products: Failure to remove the Toner Cartridge (and Toner Drum Unit on applicable models) during shipping will cause severe damage to the Copier/Printer and will VOID the Warranty. (Refer to your Operation Manual for proper packaging.)

For ink-jet products: Do not remove the ink cartridges during shipping. Damage to your print head resulting from packing without the ink cartridges will VOID your warranty. (Refer to your Operation Manual for proper packaging.)

BROTHER DISCLAIMS ALL OTHER WARRANTIES EXPRESSED OR IMPLIED INCLUDING, WITHOUT LIMITATION, ANY IMPLIED WARRANTIES OF MERCHANTABILITY OR FITNESS FOR A PARTICULAR PURPOSE, EXCEPT TO THE EXTENT THAT ANY WARRANTIES IMPLIED BY LAW CANNOT BE VALIDLY WAIVED.

No oral or written information, advice or representation provided by Brother, its Authorized Service Centers, Distributors, Dealers, Agents or employees, shall create another warranty or modify this warranty. This warranty states Brother's entire liability and your exclusive remedy against Brother for any failure of the Copier/Printer to operate properly.

Neither Brother nor anyone else involved in the development, production, or delivery of this Copier/Printer shall be liable for any indirect, incidental, special, consequential, exemplary, or punitive damages, including lost profits, arising from the use of or inability to use the product, even if advised by the end user/purchaser of the possibility of such damages. Since some Provinces do not allow the above limitation of liability, such limitation may not apply to you.

This Limited Warranty gives you specific legal rights and you may also have other rights which vary from Province to Province.

Warranty Service is available at Brother Authorized Service Centers throughout Canada. For Technical Support or for the name and location of your nearest Authorized Service Center call 1-800-853-6660. Within Montreal, please call 685-6464. Internet support: support@brother.ca or browse Brother's Web Site: www.brother.com

Brother International Corporation (Canada) Ltd.
1 Rue Hôtel de Ville
Dollard-Des-Ormeaux, QC H9B 3H6

We're at your side.
brother®

Table of Contents

1

Getting to Know Your Digital Copier/Printer	1-1
Using This Manual	1-1
Finding Information.....	1-1
Conventions Used in this Manual.....	1-1
DCP-1000 Control Panel Overview	1-2
Inserting Originals for Copying (and Scanning).....	1-4
Using the ADF (Automatic Document Feeder).....	1-4
Recommended Environment	1-4
Setting the Special Media Lever.....	1-5
Using the Scanner Glass	1-5

2

Assembly	2-1
Packing List.....	2-1
Choosing a Location.....	2-2
Assembly.....	2-3
Installing the Drum Unit Assembly (with Toner Cartridge).....	2-3
Setting Up the DCP	2-5
Loading Paper.....	2-7
Acceptable Paper	2-7
Paper Capacity of Multi-purpose Sheet Feeder.....	2-8

3

On-Screen Programming	3-1
User-Friendly Programming	3-1
Menu Selection Table.....	3-1
Navigation Keys.....	3-2
Menu Table.....	3-3
Key Operations Table.....	3-4

4

Custom Settings.....	4-1
Custom Settings.....	4-1
Toner Save.....	4-1
Setting the Beeper Volume.....	4-1
Sleep Mode.....	4-2
Setting the Print Density.....	4-2
Using the Reports Key.....	4-3
To Print a Report.....	4-3

Making Copies	5-1
Using the Machine as a Copier.....	5-1
Making a Single Copy (Using the ADF).....	5-1
Making Multiple Copies (Using the ADF).....	5-2
Single or Multiple Copies (Using the Scanner Glass).....	5-2
Out of Memory Message	5-2
Temporary Copy Settings.....	5-3
Copying Using Multiple Settings	5-3
Using Enlarge or Reduce Keys	5-4
Sorting Multiple Copies (Using the ADF)	5-5
Copy Mode (Type of Original).....	5-5
Paper Size	5-5
Copy Contrast.....	5-6
Using the Options Key	5-6
Special Copy Options (Using the ADF).....	5-6
Special Copy Options (Using the Scanner Glass)	5-6
2 in 1	5-7
4 in 1	5-7
Poster.....	5-7
Paper Type.....	5-8
Changing Default Copy Settings.....	5-9
Copy Mode (Type of Original).....	5-9
Copy Contrast.....	5-10
Paper Type.....	5-10
Paper Size	5-10

Using Brother DCP as a Printer	6-1
Special Printing Features.....	6-1
Windows® Printing.....	6-1
Bi-directional Parallel Interface.....	6-1
Printing from Your PC	6-1
Multi-purpose Sheet Feeder	6-1
Two-Sided Printing (Manual Duplex).....	6-2
Loading Envelopes in Multi-purpose Sheet Feeder	6-2
Paper Tray	6-3
Simultaneous Printing/Copying	6-3
Choosing Acceptable Paper.....	6-4
Printer Operations.....	6-4
Reset Key.....	6-4

Printer Driver Settings (For Windows® Only)	7-1
Using the Brother DCP-1000 Printer Driver.....	7-1
Features in the Printer Driver (For Windows® Users Only).....	7-1
Basic Tab.....	7-2
Paper Size.....	7-3
Multiple Page.....	7-3
Border Line.....	7-3
Orientation.....	7-3
Copies.....	7-3
Collate.....	7-4
Media Type.....	7-4
Advanced Tab.....	7-5
Print Quality (*1).....	7-5
Resolution.....	7-5
Toner Save.....	7-5
Print Setting (For Windows® 95/98/98SE/Me Users Only).....	7-6
Duplex Printing (*2).....	7-6
Manual Duplex.....	7-6
Binding Offset.....	7-6
Watermark (*3).....	7-7
Print Watermark.....	7-7
In Background.....	7-7
Watermark Text.....	7-8
Watermark Bitmap.....	7-8
Position.....	7-8
Page Setting (*4).....	7-9
Device Options (*5).....	7-10
Quick Print Setup.....	7-11
Administrator (For Windows® 95/98/98SE/Me Users Only).....	7-11
Print Date & Time.....	7-12
Support.....	7-13
Brother Solutions Center.....	7-13
Web Update.....	7-13
Check Setting.....	7-13

Using the Windows®-Based Brother MFL-Pro Control Center (For Windows® Only)	8-1
Brother MFL Pro Control Center	8-1
AutoLoad the Brother Control Center	8-1
How to Turn Off AutoLoad	8-2
Using the Scan Key	8-2
Using the Control Panel Keys	8-2
Scan Image	8-3
Scan/OCR	8-3
Scan to E-mail	8-3
Brother Control Center Features	8-4
Auto Configuration	8-4
Scanning Operations	8-4
Copy Operations	8-5
Scanner Settings for Scan and Copy Buttons	8-5
Global Settings	8-5
Setting Up the Scanner Configurations	8-6
To Access the Scanner Configurations Screen	8-6
Perform an Operation from the Control Center Screen	8-7
Scan to File	8-7
Scanner Settings	8-7
Destination Folder	8-8
Scan to E-mail	8-8
Scanner Settings	8-9
E-mail Application	8-9
File Attachments	8-9
Conversion Options	8-10
Format	8-10
Show QuickSend Menu	8-10
QuickSend List	8-10
Scan to Word Processor	8-11
Scanner Settings	8-11
Word Processor	8-12
User-Defined Button	8-13
Scanner Settings	8-13
Target Application	8-13
Copy	8-14
Scanner Settings	8-14
Copy Settings	8-14

9

Using ScanSoft™ PaperPort® for Brother and ScanSoft™ TextBridge®	9-1
Using ScanSoft™ PaperPort® and TextBridge®	9-1
Viewing Items	9-2
Organizing Your Items in Folders	9-2
Links to Many Other Applications	9-3
Using ScanSoft™ TextBridge® OCR (Converting Image Text to Text You Can Edit)	9-3
Importing Items from Other Applications	9-3
Exporting Items in Other Formats	9-4
Exporting an Image File	9-4
Accessing the Scanner	9-4
Scanning an Image into Your PC	9-5
Settings in the Scanner Window	9-5
Image	9-5
Contrast	9-6
Custom	9-6
PreScanning an Image	9-7

10

Using Automatic E-Mail Printing	10-1
For Windows® 95, 98, 98SE, Me Only	10-1
Main Features	10-1
To Access the On-Line Documentation	10-1
To Install Automatic E-mail Printing (Optional Application)	10-1

11

Using the Brother machine with a New Power Macintosh® G3, G4 or iMac™/iBook	11-1
Set up Your USB Equipped Apple® Macintosh® G3,G4, iMac™ or iBook with Mac OS 8.5/8.51/8.6/9.0/9.0.4/9.1	11-1
Using Brother Printer Driver with Your Apple® Macintosh®	11-1
Using Brother TWAIN Scanner Driver with Your Apple® Macintosh®	11-3
Accessing the Scanner	11-4
Scanning an Image into Your Macintosh G3, G4 or iMac	11-4
Settings in the Scanner Window	11-5
Image	11-5
Scanning Area	11-6
Business Card Size	11-6
Adjust Image	11-7
PreScanning an Image	11-8

Important Information	12-1
Standard FCC Notices	12-1
Laser Safety.....	12-1
FDA Regulations.....	12-1
Federal Communications Commission (FCC)	
Declaration of Conformity (For USA Only)	12-2
Important.....	12-2
Industry Canada Compliance Statement.....	12-3
Important—About the Interface Cable	12-3
Warranty.....	12-3
International ENERGY STAR® Compliance Statement...	12-3
Important Safety Instructions	12-4
Trademarks	12-6

Troubleshooting and Routine Maintenance	13-1
Troubleshooting.....	13-1
Error Messages	13-1
Original Jams and Paper Jams.....	13-4
Original is Jammed in the Top of the ADF Unit.....	13-4
Original is Jammed Inside the ADF Unit.....	13-4
Paper Jam.....	13-5
Paper is Jammed in the Multi-purpose Sheet Feeder....	13-5
Paper is Jammed near the Drum Unit	13-6
If You Are Having Difficulty with Your Machine.....	13-7
Packing and Shipping the DCP	13-11
Routine Maintenance.....	13-13
Cleaning the Scanner	13-13
Cleaning the Printer.....	13-14
Cleaning the Drum Unit	13-15
Replacing the Toner Cartridge	13-15
Toner Empty Indicator	13-16
Replacing the Drum Unit.....	13-20
Glossary.....	G-1
Specifications	S-1
Product Description	S-1
Scanner	S-1
Printer	S-1
Consumable Items	S-2
Computer Requirements	S-2
Electrical and Environment	S-3
Parallel Interface.....	S-4
USB (Universal Serial Bus) Interface	S-4
Index.....	I-1

1 Getting to Know Your Digital Copier/Printer

Using This Manual

Thank you for purchasing a Brother Digital Copier/Printer (DCP). This machine has been designed to be simple to use, with LCD screen prompts to guide you through programming your machine. However, you can use your machine to its fullest potential by taking a few minutes to read this manual.



Additionally, your machine has a **Reports** key. Press **Reports** and **1** to print a list of basic step instructions and explanations.

Finding Information

All chapter headings and subheadings are listed in the Table of Contents. You will be able to find information about a specific feature or operation by checking the Index in the back of this manual.

Conventions Used in this Manual

Throughout this manual you'll see special symbols alerting you to important information, warnings, and actions to perform. For clarification, and to help you choose the correct key presses, we've added illustrations of some LCD messages.

boldface	Bold typeface identifies a specific key on the machine control panel.
<i>italics</i>	Italics typeface emphasize an important point, or refer you to related topic.
bubble dot	Bubble Dot typeface identifies the messages on the LCD of the machine.



Warnings detail precautions you must take to avoid possible personal injury.



Cautions specify procedures you must follow or avoid to prevent possible damage to the machine.



Notes tell you the proper response for a situation that may occur.



FYI tips provide details about how the current operation interacts with other features.



Improper Setup alerts you to devices and procedures that are not compatible with the machine.

DCP-1000 Control Panel Overview

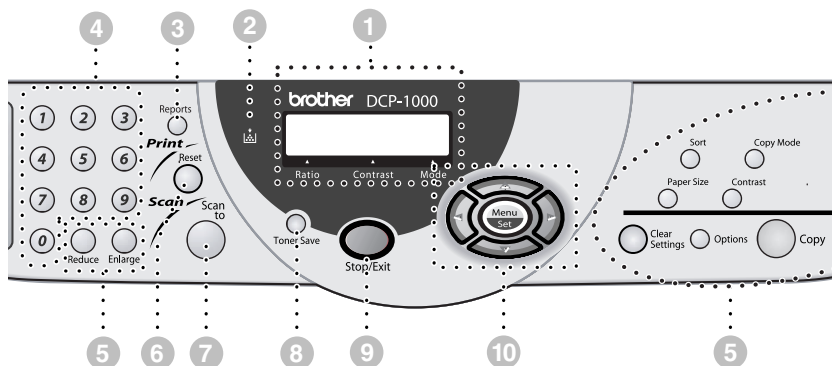

1 Liquid Crystal Display (LCD):

The LCD displays messages to help you set up and operate your machine.

Ratio

Enlargement and reduction percentages will be displayed.

Contrast

This area shows the degree of contrast you selected by pressing the Contrast key.

Mode

This area shows the type of original you selected by pressing the Copy Mode key.

2 Toner Empty Indicator

Blinks when the toner cartridge is low and stays lit when toner is empty.

3 Reports

Accesses the Reports menu so you can select a report to print: Help List and User Settings.

4 Numeric Keys

Use the numeric keys to enter the number of multiple copies (99 maximum).

5 Copy Keys (Temporary Settings):

Reduce

Lets you reduce copies depending upon the ratio you select.

Enlarge

Lets you enlarge copies depending upon the ratio you select.

Sort

Press this key to sort multiple copies.

Copy Mode

Press to select the resolution that suits the type of original.

AUTO — Select when the original contains both text and photographs.

TEXT — Select when the original contains only text.

PHOTO — Select when the original is a picture.

Paper Size

Press this key to select the size of print media.

Contrast

Lets you make a copy that is lighter or darker than the original.

Options

You can change the layout of copies on the print media.

4IN1—Save paper by copying four pages onto one page.

2IN1—Save paper or create a booklet by copying two pages onto one page.

POSTER—This option copies a different portion of the original on each of nine sheets of print media. Tape the sheets together to get a copy that is nine times the size of the original.

—OR—

You can change the type of media that you are using.

Clear Settings

Resets your temporary copy settings back to the user default settings. Use this key when you do not want to wait 45 seconds for the temporary settings to clear automatically.

Copy

Makes copy.

6 Print Key:

Reset

Clears data from the printer memory.

7 Scan Key:

Scan to

Lets you scan the next original into your computer and select the type of destination: word processing, graphics or E-mail application.

8 Toner Save

You can conserve toner using this key.

9 Stop/Exit

Cancels a copy operation, or exits from Menu mode.

10 Navigation Keys:

Menu/Set

Lets you access the Menu and Programming mode and stores your settings in the DCP.



Press to scroll forward or backward to set a menu selection.



Press to scroll through the menus and options.

Inserting Originals for Copying (and Scanning)

You can copy and scan from the ADF (Automatic Document Feeder) or from the scanner glass.

Using the ADF (Automatic Document Feeder)

The ADF can hold up to 30 pages, feeding each one individually through the machine. Use standard (20 lb/75g/m²) paper when using the ADF. Always fan the pages well before placing them in the ADF.

Recommended Environment

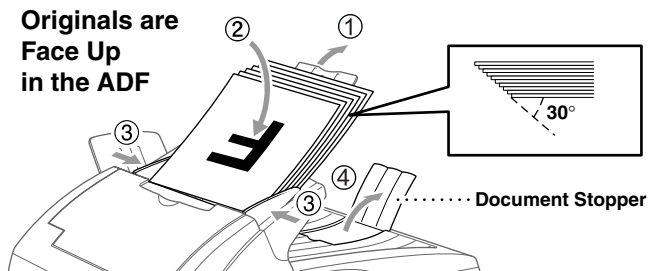

- Temperature: 68°F – 86°F (20°C – 30°C)
Humidity: 50% – 70%
Paper: Xerox 4200 or equivalent (20LB/LTR)

- ⊘ **DO NOT** use curled, wrinkled, folded, ripped paper, or paper with staples, paper clips, paste or tape attached. **DO NOT** use cardboard, newspaper, or fabric. (To fax this kind of document, see *Using the Scanner Glass*, page 1-5.)
 - Make sure documents written with ink are completely dry.
 - Originals must be from 5.8 to 8.5 inches wide, and 5.8 to 14 inches long.
- 1 Pull up the Document Extension.
 - 2 Fan the pages and stagger them at a 30 degree angle. Insert the pages **face up**, **top edge first** in the ADF until you feel them touch the feed roller.
 - 3 Adjust the paper guides to fit the width of your original.





- 4 Unfold the document stopper.

Setting the Special Media Lever

You can use the special media lever to select the Regular position () or Special position. ()

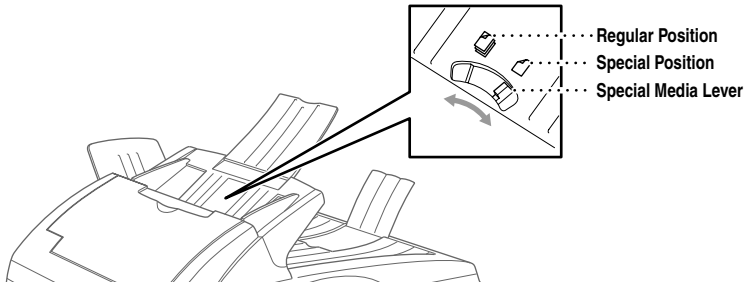
To feed special types of originals (such as coated paper or glossy paper), move the special media lever to the Special position (). It will allow the original to feed through the ADF without slipping or jamming.



 If the original “double-feeds,” try again by inserting a single sheet of the original in the ADF or use the scanner glass.

Using the Scanner Glass

You can use the scanner glass to copy (or scan) one page at a time or pages of a book. Originals can be letter or A4 size (8.5 inches to 11.7 inches).

 To use the scanner glass, the ADF must be empty.

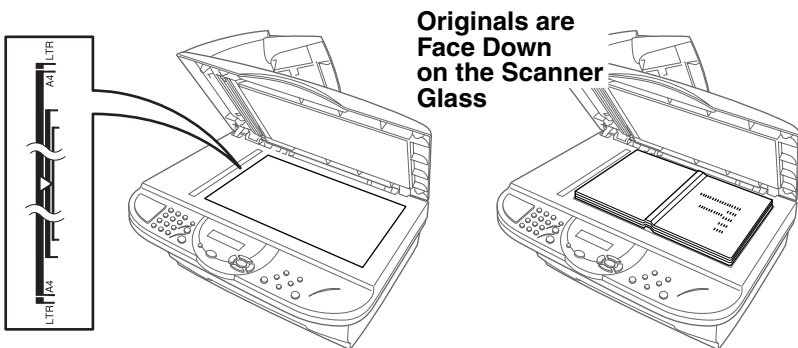

- 1 Lift the document cover.
- 2 Using the document guidelines on the left, center the original face down on the scanner glass.
- 3 Close the document cover.

 If the original is a book or is thick, do not slam the cover or press on it.

4 Press **Copy** to begin copying.

—OR—

Press **Scan to** to begin scanning.

5 Repeat Steps 1 to 4 for each page of your original.



Press **Stop/Exit** to cancel.

2 Assembly

Packing List

Make sure you have the following items:

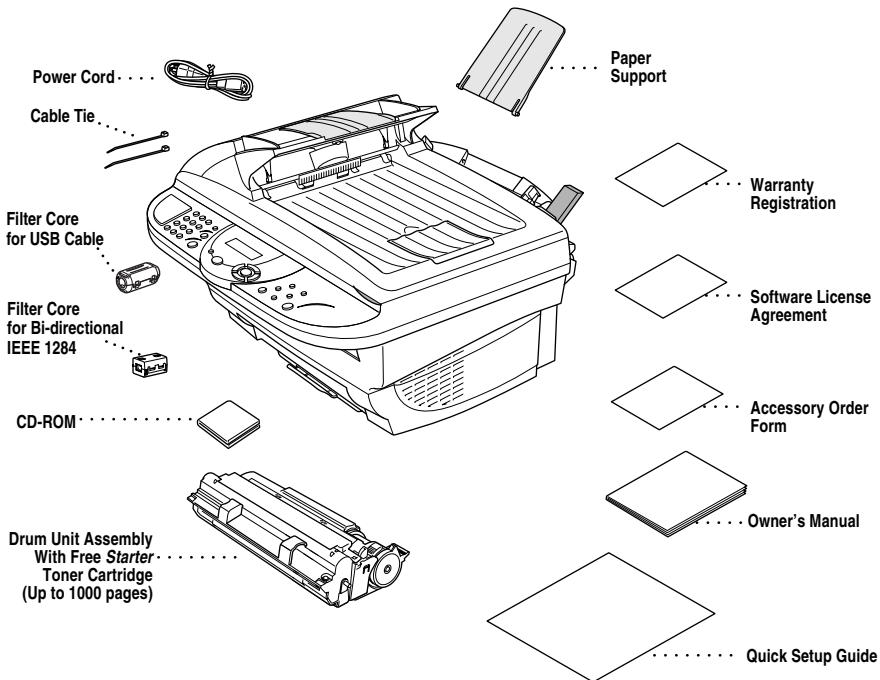

! Caution

Do NOT throw away the filter cores and cable ties by accident. You will need them to meet FCC Emission Requirements when you connect the DCP to your computer using a USB cable or a bi-directional IEEE-1284 compliant parallel cable.



If an item is missing, call Brother Customer Service at 1-800-284-4329 (**in USA**), 1-800-853-6660 (**in Canada**) or 1-514-685-6464 (**in Montreal**). See *Ordering Accessories and Supplies* on page ii for the correct item numbers.



Whenever you transport the DCP, use the packing materials that came with the machine. If you do not pack the machine properly, you may void your warranty.

Choosing a Location

Place your DCP on a flat stable surface, such as a desk. Select a place that is free of vibration and shocks. Place the machine near a standard, grounded power outlet. Choose a location where the temperature remains between 50°F and 95°F (10°–35°C).

- ⊘ Avoid placing your machine in a high-traffic area. Do not place near heaters, air conditioners, water, chemicals, or refrigerators. Do not expose the machine to direct sunlight, excessive heat, moisture, or dust. Do not connect your machine to electrical outlets controlled by wall switches or automatic timers. Disruption of power can wipe out information in the machine's memory. Do not connect your machine to electrical outlets on the same circuit as large appliances or other equipment that might disrupt the power supply. Avoid interference sources, such as speakers or the base units of cordless phones.

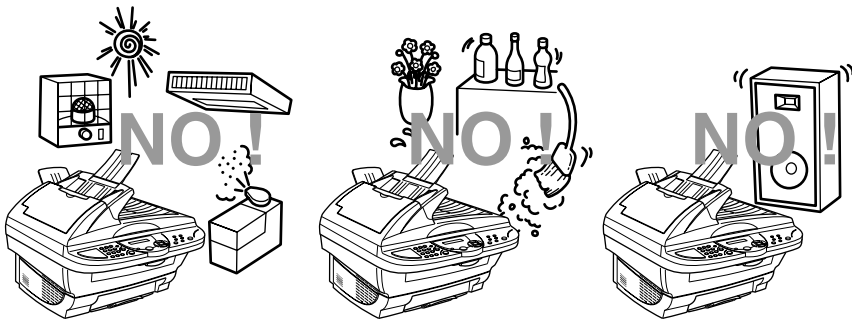

⚠ WARNING

- Lightning and power surges can damage this product! We recommend that you use a quality surge protection device on the AC power line, or unplug the lines during a lightning storm.
- For PLUGGABLE EQUIPMENT, the socket-outlet should be installed near the equipment and should be easily accessible.

Assembly

Installing the Drum Unit Assembly (with Toner Cartridge)

- 1 Unpack the drum unit assembly, including the toner cartridge, and gently rock it from side to side five or six times to distribute the toner evenly inside the cartridge.

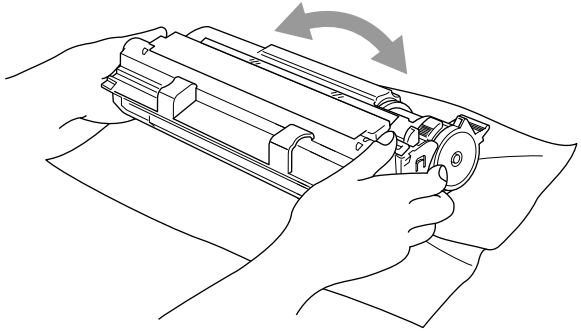

To prevent damage to the drum, do NOT expose it to light for longer than a few minutes.

Do NOT remove the starter sheet—this will be ejected while the machine is warming up.

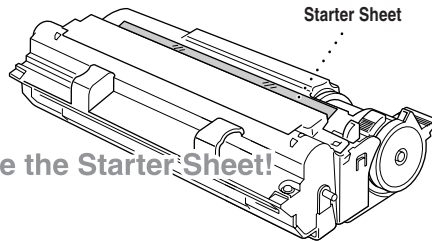

Do NOT remove the Starter Sheet!

- 2 Open the scanner cover of the DCP by pulling the lever toward you and lifting the cover.

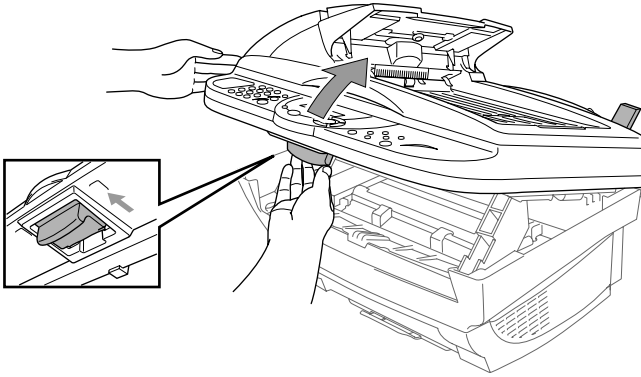

- 3 Holding the drum unit by its handles, insert it into the machine.

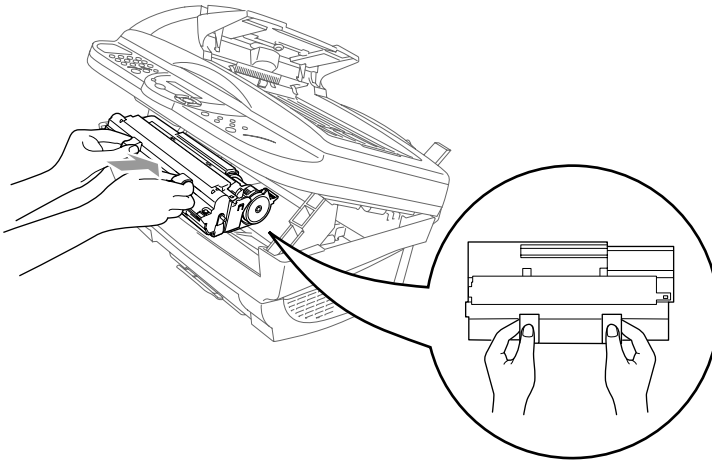

- 4 Close the scanner cover.

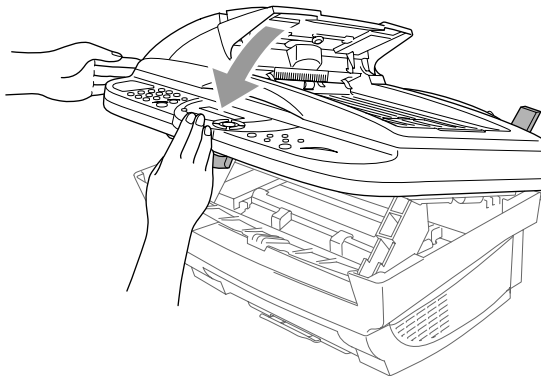

Setting Up the DCP

Follow the instructions below to connect the power cord.

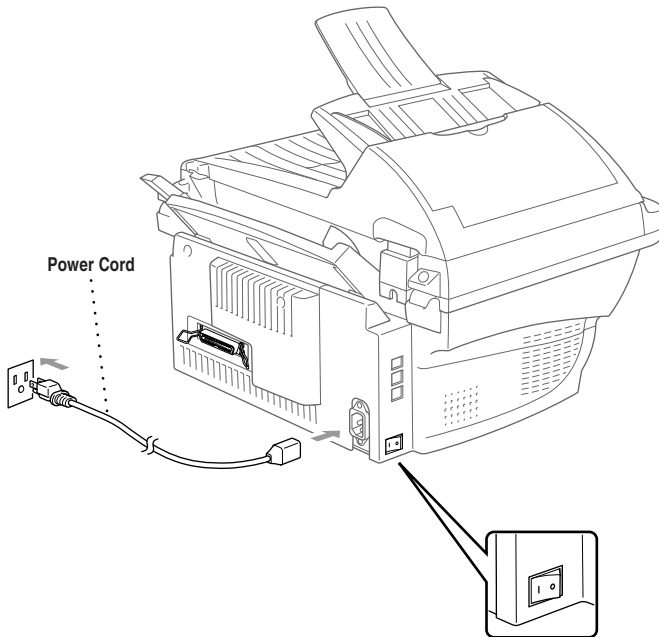

- 1 Connect the power cord.
- 2 Turn on the power switch.

WARNING

- This machine must be grounded using a three-prong plug.
- Lightning and power surges can damage this product! We recommend that you use a quality surge protection device on the AC power line, or unplug the power cord during a lightning storm.
- Do not touch the rollers at the paper exit.

3 Attach the plastic paper support to the multi-purpose sheet feeder.

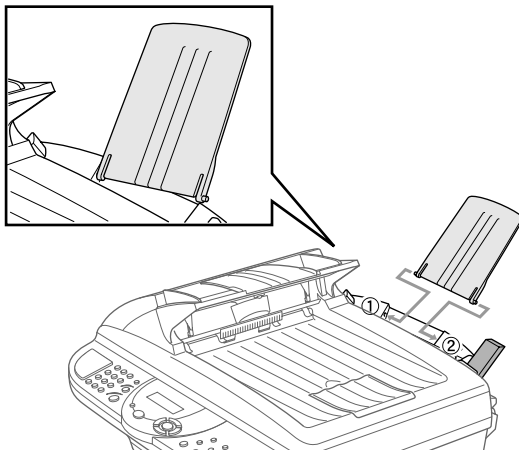

4 Pull out the paper tray and the extension.

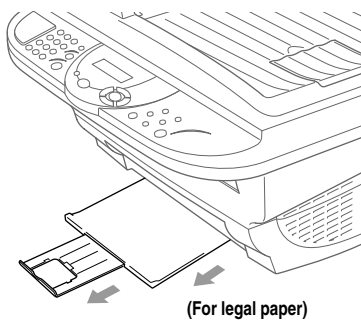

5 If your paper size is Letter or A4, unfold the paper stopper.

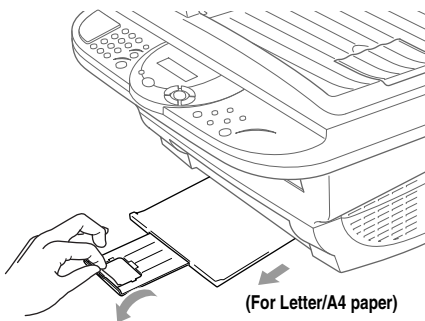

Loading Paper

- 1 Adjust the guides to fit the paper (to help prevent paper jams).

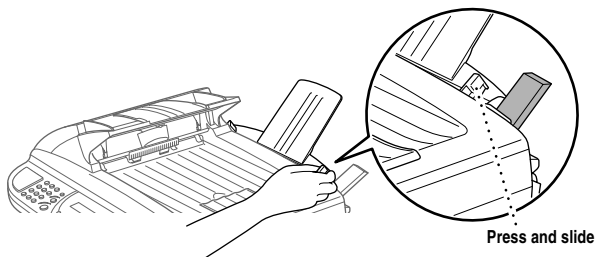

- 2 Fan the paper well. Push down the paper lever. Load the paper with the lever down. Make sure the print side is toward the DCP and the paper level is stacked below the paper mark. The feeder can hold up to 200 sheets of paper or up to 10 envelopes.

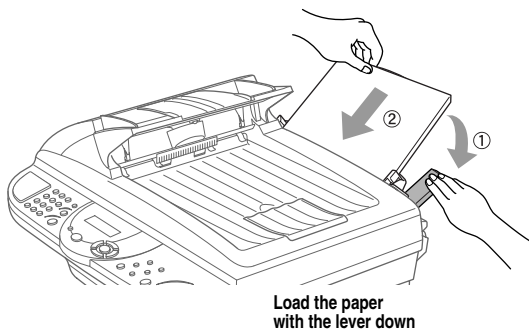

Acceptable Paper

The DCP can handle paper that has the following specifications.

Paper Type	Paper Size
Cut sheet	Letter, A4, Legal, B5, A5, Executive, Custom size 2.75-8.5 × 5-14 inches (70-216 × 127-356 mm)
Envelopes	DL, C5, COM-10, Monarch
Post Card	2.75-8.5 × 5-11 inches (70-216 × 127-279 mm)
Organizer	Day-Timer® J, K, L, M 2.75-8.5 × 5-11 inches (70-216 × 127-279 mm)
Labels and Transparencies	2.75-8.5 × 5-14 inches (70-216 × 127-356 mm)

Paper Capacity of Multi-purpose Sheet Feeder

Multi-purpose Sheet Feeder:

Up to 0.87 inch (22 mm) in height (up to the mark) Approx. 200 sheets of 20 lb. (75 g/m²) or 50 sheets of 42 lb. (158 g/m²) Letter/A4 paper, or 10 envelopes

Output Tray:

Approx. 50 sheets of 20 lb. (75 g/m²) Letter/A4 paper

	Cut Sheet	Envelopes
Basis Weight	17 to 42 lb. (64 to 158 g/m ²)	20 to 24 lb. (75 to 90 g/m ²) single thickness
Caliper	±0.003 to ±0.008 in. (0.08 to 0.2 mm)	0.0033 to 0.0058 in. (0.084 to 0.14 mm) single thickness
Moisture Content	4% to 6% by weight	4% to 6% by weight
Smoothness	100 to 250 (Sheffield)	100 to 250 (Sheffield)



Recommended Paper Types:

Cut Sheet: Xerox 4200 or equivalent

Label: Avery *laser* label or equivalent

Transparency: 3M CG3300 for *laser* printers or equivalent

3

On-Screen Programming

User-Friendly Programming

We have designed your DCP with on-screen programming using navigation keys. User-friendly programming helps you take full advantage of all the menu selections your DCP has to offer.

Since your programming is done on the LCD, we created step-by-step on-screen prompts to help you program your machine. All you need to do is follow the prompts as they guide you through the menu selections and programming options. You can program settings even more quickly by pressing **Menu/Set** and the menu number using the numeric keys.

Menu Selection Table





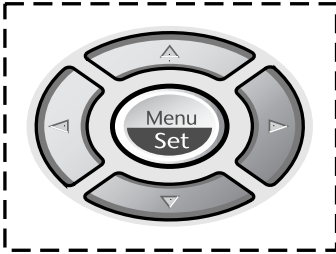

You can probably perform most of these programming operations without the Owner's Manual. To help you understand the menu selections and options that are found in the DCP operations, use the Menu Selection Table on page 3-3.

You can program your DCP by pressing **Menu/Set** followed by the menu number. For example: to set **COPY MODE** to **PHOTO**, press **Menu/Set, 2, 1**

and  to select **PHOTO**, and then press **Menu/Set**.

Navigation Keys



-  * Access the Menu
-  * Go to next menu level
-  * Accept an option
-  * Scroll through the current menu level
-  * Back to previous menu level
-  * Forward to next menu level
-  * Exit the Menu

You can access the menu mode by pressing **Menu/Set**. When you enter the Menu, the LCD scrolls:

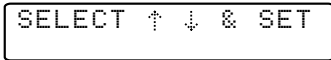

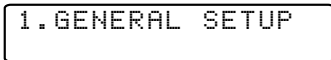

Press **1** for General Setup Menu—**OR**—

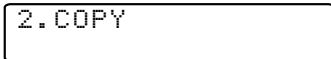

Press **2** for Copy Menu



—**OR**—

You can scroll more quickly through the each menu level by pressing  **OR**  and then set an option by pressing **Menu/Set** when that option appears on the LCD. Then the LCD shows next menu level. Press  to scroll to your next menu selection, and then press **Menu/Set**.

When you finish setting an option, the LCD shows **ACCEPTED**.

Note

Use  to scroll backward if you passed your choices or to save keystrokes.

Menu Table

To access the menu, press  **Menu/Set**.

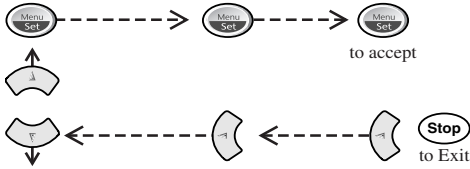

Main Menu	Submenu	Options	Descriptions	Page
1. GENERAL SETUP	1. BEEPER	HIGH ↑ LOW ↙ OFF ↓	Adjusts beeper volume.	4-1
	2. SLEEP MODE	—	Conserves power.	4-2
	3. PRINT DENSITY	- ■ ■ ■ □ □ +	Makes prints darker or lighter.	4-2
	0. LOCAL LANGUAGE (Canada Only)	ENGLISH ↑ FRENCH ↓	Allows you to change the LCD Language to French.	See French Manual
2. COPY	1. COPY MODE	AUTO ↑ TEXT ↙ PHOTO ↓	Selects the Copy resolution for your type of original.	5-5
	2. CONTRAST	- ■ ■ ■ □ □ +	Adjusts the contrast.	5-6
	3. PAPER TYPE	THIN ↑ PLAIN ↙ THICK ↓ THICKER	Identify the type of paper in the multi-purpose sheet feeder.	5-8
	4. PAPER SIZE	LETTER ↑ LEGAL ↙ A4 ↓	Selects size of paper.	5-5

 The factory setting (option) is shown in bold.

Key Operations Table

You can use the temporary keys on the control panel to conveniently choose temporary copy settings and access the scanning operations. The Key Operations Table below shows the options they provide.

Press the temporary key repeatedly until you see the option you want; some keys require pressing **Menu/Set** to select it. For the **Options** key, press  to scroll through the next level of options, and then select the one you want by pressing **Menu/Set** again.

Temporary Keys	Options		Descriptions	Page
Copy Mode	AUTO TXT PH		Select the Copy resolution for your type of original.	5-5
Contrast	- ■■■■ □ □ +		Adjust the contrast.	5-6
Paper Size	LETTER, LEGAL, A4, A5, A6, B5, B6, EXECUTIVE		Select the size of paper.	5-5
Sort	STACK SORT		Sort multiple copies.	5-5
Options	OPT:SPECIAL	2 IN 1 4 IN 1 POSTER OFF	You can change the layout of copies on the print media.	5-6
	OPT:PAPER TYPE	THIN PLAIN THICK THICKER TRANSPARENCY	Identify the type of paper in the multi-purpose sheet feeder.	5-8
Reduce	25%, 50%, 78% LGL>LTR, 94% A4>LTR, AUTO, 100%		Reduce the size of copies.	5-4
Enlarge	104% EXE>LTR, 150%, 200%, 400%, ZOOM, AUTO, 100%		Enlarge the size of copies.	5-4
Clear Settings	—		Reset your temporary copy settings back to the user default settings.	5-3
Reset	—		Clear data from the printer memory.	6-4
Scan to	SCAN TO E-MAIL SCAN/IMAGE SCAN/OCR		Scan the next original into your computer and select the type of destination: word processing, graphics or E-mail application.	8-2

 The factory setting (option) is shown in bold.

4

Custom Settings

Custom Settings

Toner Save

You can conserve toner using this feature. When you set Toner Save to **ON**, print appears somewhat lighter. The default setting is **OFF**.

- 1 Press **Toner Save**.
- 2 Press  to select **ON** (or **OFF**), and then press **Menu/Set**.

Setting the Beeper Volume

You can set the beeper to **LOW**, **HIGH** or **OFF**. The default setting is **LOW**. When the beeper is set to **LOW** or **HIGH**, the machine beeps every time you press a key or make an error.

- 1 Press **Menu/Set**, **1**, **1**.
- 2 Press  to select your option.
- 3 When the LCD shows the option you want, press **Menu/Set**.
- 4 Press **Stop/Exit**.



1. BEEPER

Sleep Mode

Setting the Sleep Mode reduces power consumption while the machine is idle. You can choose how long the machine is idle (from 00 to 99 minutes) before it drops into sleep mode. The timer automatically resets itself after the machine receives a PC data, or makes a copy. The default setting is 0 minutes.



- 1 Press **Menu/Set**, **1**, **2**.
- 2 Use the numeric keys to enter the length of time the machine is idle before it drops into sleep mode (00 to 99 minutes), and then press **Menu/Set**.
- 3 Press **Stop/Exit**.



2.SLEEP MODE

Setting the Print Density

You can adjust print density, making your printed documents darker or lighter. The new setting will remain until you change it again.

- 1 Press **Menu/Set**, **1**, **3**.
- 2 Press  to make print darker or  to make print lighter, and then press **Menu/Set**.
- 3 Press **Stop/Exit**.



3.PRINT DENSITY

Using the Reports Key



Two reports are available:

1.HELP LIST

Prints the Menu Table so you can see at-a-glance how to quickly program every menu selection.

2.USER SETTINGS

Lists your latest default settings for **GENERAL SETUP**.

To Print a Report

- 1 Press **Reports**.
- 2 Press  to select the report you want, and then press **Menu/Set**.

—OR—

Enter the number of the report you want to print.
For example, press **1** to print the Help List.

5 Making Copies

Using the Machine as a Copier

You can copy from either the ADF (Automatic Document Feeder) or from the scanner glass. (See pages 1-4 to 1-6 for details.)

You can use the DCP as a copy machine, making up to 99 copies at a time.

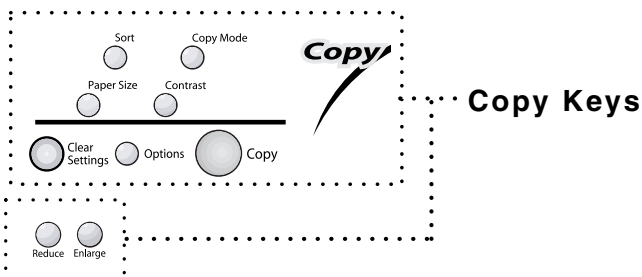

The scannable area of your machine begins at approximately one-sixth inch (4mm) from the edge of the paper.

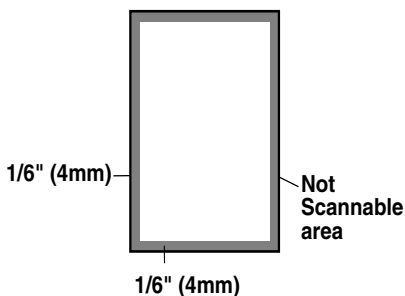

Making a Single Copy (Using the ADF)

- 1 Place the original face up in the ADF.
- 2 Press **Copy**.
Do **NOT** pull on the paper while copying is in progress.

Note: To stop the copy process and release the original, press **Stop/Exit**.

Making Multiple Copies (Using the ADF)

- 1 Place the original face up in the ADF.
- 2 Use the numeric keys to enter the number of copies you want (up to 99).
- 3 Press **Copy**.



To sort the copies, use **Sort** key. (See *Sorting Multiple Copies (Using the ADF)*, page 5-5.)

Single or Multiple Copies (Using the Scanner Glass)

If you want to sort multiple copies, use the ADF.

- 1 Lift the Document Cover.

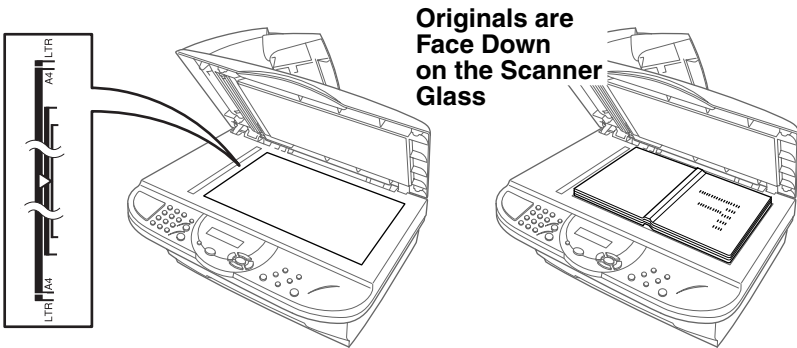

- 2 Using the document guide on the left, center the original *face down* on the scanner glass and close the Document cover.
- 3 Using the numeric keys, enter the number of copies you want (up to 99).
- 4 Press **Copy**.

Out of Memory Message

If the memory becomes full while you are making copies, the LCD shows:

OUT OF MEMORY

If the **OUT OF MEMORY** message appears while you are scanning, press **Stop/Exit** to cancel.



To gain extra memory, print fax messages in memory.

Temporary Copy Settings

The Copy keys on the control panel enable you to combine multiple settings quickly and easily. The keys **Sort**,

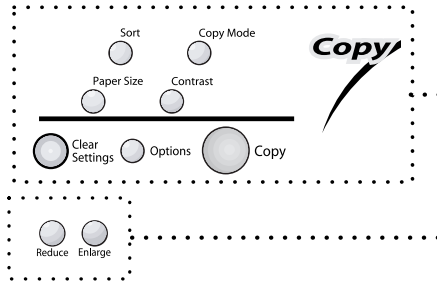

Copy Keys

Copy Mode, **Paper Size**, **Contrast** and **Options** allow you to adjust copy settings temporarily. And the DCP returns to its default settings 45 seconds after it finishes copying. If you want to use these temporary settings again, place the next original in the ADF or on the scanner glass before the 45 seconds expire.

Copying Using Multiple Settings

You can try different combinations of settings for the best results.



To clear your settings and start over, press **Clear Settings**.



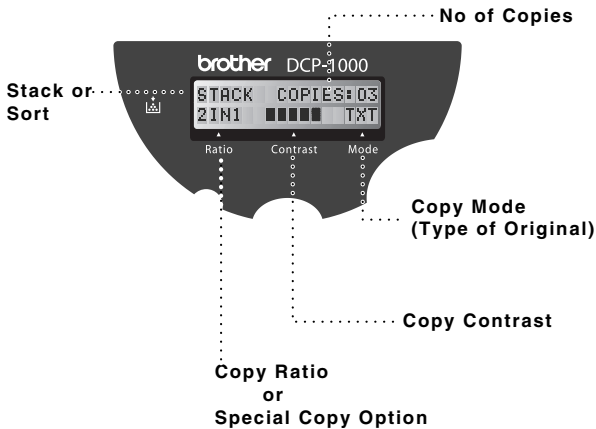

As you select multiple settings, the LCD displays them:



Using Enlarge or Reduce Keys

AUTO sets the machine to calculate automatically the reduction ratio that fits the size of your paper. **ZOOM** allows you to type a ratio from 25% to 400% in 1% increments.

Press Reduce and 	100%	Press Enlarge and 	ZOOM
	AUTO		400%
	94% A4>LTR		200%
	78% LGL>LTR		150%
	50%		104% EXE>LTR
	25%		100%
	ZOOM		

- 1 Place the original face up in the ADF, or face down on the scanner glass.
- 2 Use the numeric keys to enter the number of copies you want (up to 99).
- 3 Press **Enlarge** or **Reduce**. (Enlargement or reduction ratios appear.)
- 4 Press  to select the ratio you want, and then press **Menu/Set**.

—OR—

For more choices select **ZOOM**, use the numeric keys to enter any percentage between **25%** and **400%**, and then press **Menu/Set**.

- 5 Press **Copy**.



Special Copy Options (2in1, 4in1 or Poster copy) are *not* available with **Enlarge/Reduce**.

When selecting an enlargement or reduction ratio, you need to know the size of the paper you registered in Menu 1-1.

Selecting a Fixed Ratio:

Original is the size of...	Paper size is...	Recommended ratio is...
LEGAL	LETTER	78%
A4	LETTER	94%
EXECUTIVE	LETTER	104%

Sorting Multiple Copies (Using the ADF)

- 1 Place the original face up in the ADF.
- 2 Use the numeric keys to enter the number of copies you want (up to 99).
- 3 Press **Sort**.
- 4 Press **Copy**.

Copy Mode (Type of Original)

You can select the Copy resolution for your type of original. The default setting is **AUTO**, which is used for originals that contain both text and photographs. **TEXT** is used for originals containing only text. **PHOTO** is used for copying photographs.

- 1 Place the original face up in the ADF, or face down on the scanner glass.
- 2 Use the numeric keys to enter the number of copies you want (up to 99).
- 3 Press **Copy Mode** continuously to choose the type of original (**AUTO**, **TEXT** or **PHOTO**).
- 4 Press **Copy**.

Paper Size

Use **Paper Size** to temporarily identify the size of the paper in the multi-purpose sheet feeder.

You can select **LETTER**, **LEGAL**, **A4**, **A5**, **A6**, **B5**, **B6** and **EXECUTIVE** size paper.



- 1 Press **Paper Size** and  until the LCD shows the size of paper you loaded in the multi-purpose sheet feeder, and then press **Menu/Set**.
- 2 Press **Copy**.



A6 size original requires using the scanner glass.

Copy Contrast

You can adjust the copy contrast to make copies darker or lighter.

- 1 Place the original face up in the ADF, or face down on the scanner glass.
- 2 Use the numeric keys to enter the number of copies you want (up to 99).
- 3 Press **Contrast**.
- 4 Press  to make a copy lighter, or  to make a copy darker.
- 5 Press **Copy**.



Using the Options Key

Use the **Options** key to set the paper type or special copy options. See the explanations below the table.

Press Options	Menu Selections	Options	Factory Setting
 Options	OPT:SPECIAL	2 IN 1/4 IN 1/POSTER/ OFF	OFF
	OPT:PAPER TYPE	THIN/PLAIN/THICK/ THICKER/TRANSPARENCY	PLAIN

Special Copy Options (Using the ADF)

You can save paper by copying either two or four pages onto one page.

- 1 Place the originals face up in the ADF.
- 2 Use the dial pad to enter the number of copies you want.
- 3 Press **Options** and  to select **OPT:SPECIAL**, and then press **Menu/Set**.
- 4 Press  to select **2 IN 1**, **4 IN 1** or **OFF**, and then press **Menu/Set**.
- 5 Press **Copy**.

Special Copy Options (Using the Scanner Glass)

You can save paper by copying either two or four pages onto one page, or you can create poster size copy.

- 1 Place the original face down on the scanner glass.
- 2 Use the dial pad to enter the number of copies you want.
- 3 Press **Options** and  to select **OPT:SPECIAL**, and then press **Menu/Set**.

4 Press  to select **2 IN 1**, **4 IN 1**, **POSTER** or **OFF**, and then press

Menu/Set.

5 Press **Copy.**



If you selected **2 IN 1** or **4 IN 1** in Step 4, place the next original on the scanner glass, and then press **Menu/Set.** After all originals have been scanned, press **Copy.**

NEXT:PRESS SET
END:PRESS COPY

2 in 1



4 in 1

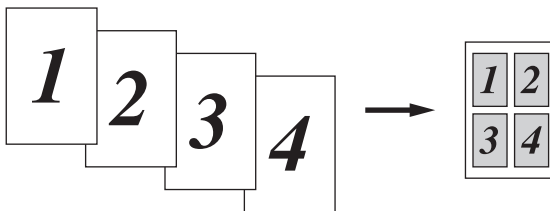

Poster

You can create a poster size copy of a photograph.

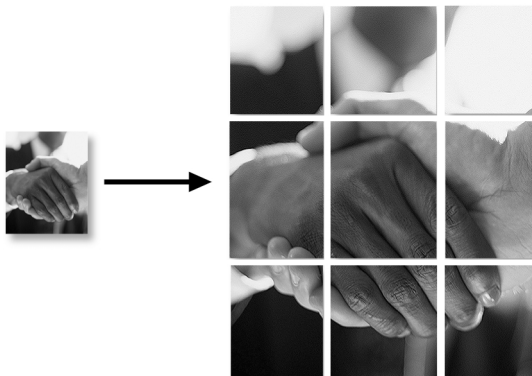

Special Copy Options (2 in 1, 4 in 1 or Poster) are not available with **Enlarge/Reduce.**





Poster is not available for multiple copies and requires using the scanner glass.

Paper Type



You can use the following types of paper for copying. For the best print quality, select the type of media that you are using.

- THIN** (17lb - 18.4lb) - For thin paper
- PLAIN** (18.7lb - 25.3lb) - For ordinary plain paper
- THICK** (25.6lb - 32lb) - For heavy weight paper or rough paper
- THICKER** (32.3lb - 42.1lb) - For heavier weight paper, rough paper or bond paper.
- TRANSPARENCY** - For transparency (OHP)

- 1** Press **Options** and  to select **OPT:PAPER TYPE**, and then press **Menu/Set**.
- 2** Press  to select your type of paper, and then press **Menu/Set**.
- 3** Press **Copy**.

Changing Default Copy Settings

Press **Menu/Set, 2** to change default settings for Paper Size, Copy Mode and Contrast. These settings will remain until you change them again by pressing **Menu/Set**.

By pressing a number, you can adjust copy settings as shown in the following chart. Press  to scroll through the options for each setting. Press **Menu/Set** to save your selection. Press **Stop/Exit—OR—**Press  to select the next setting you want to change.

Press **Menu/Set, and 2.**

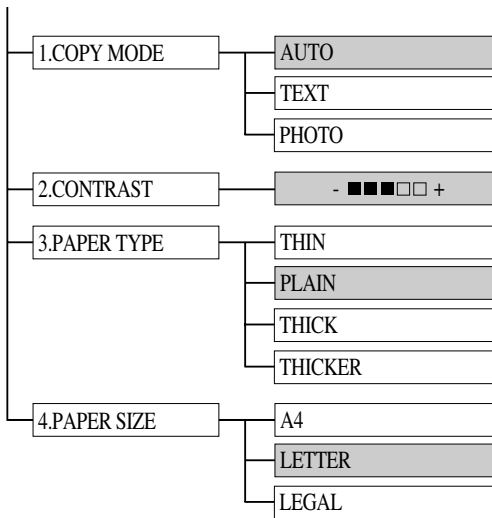

 is default

Copy Mode (Type of Original)

You can select the Copy resolution for your type of original. The default setting is **AUTO**, which is used for originals that contain both text and photographs. **TEXT** is used for originals containing only text. **PHOTO** is used for copying photographs.

1 Press **Menu/Set, 2, 1.**

1. COPY MODE

2 Press  to choose the type of original

(**AUTO, TEXT or PHOTO**), and then press **Menu/Set**.

3 Press **Stop/Exit**.

Copy Contrast

You can adjust copy contrast to make copies darker or lighter.

- 1 Press **Menu/Set, 2, 2.**

2. CONTRAST

- 2 Press  to make a copy lighter

—OR— Press  to make a copy darker, and then press **Menu/Set.**

- 3 Press **Stop/Exit.**

Paper Type

You can use the following types of paper for copying. For the best print quality, select the type of media that you use most often.

- THIN** (17lb - 18.4lb) - For thin paper
- PLAIN** (18.7lb - 25.3lb) - For ordinary plain paper
- THICK** (25.6lb - 32lb) - For heavy weight paper or rough paper
- THICKER** (32.3lb - 42.1lb) - For heavier weight paper, rough paper or bond paper.

- 1 Press **Menu/Set, 2, 3.**

- 2 Press  to select your type of paper, and then press **Menu/Set.**

- 3 Press **Stop/Exit.**

Paper Size

Use **Paper Size** to identify the size of paper in the multi-purpose sheet feeder.

- 1 Press **Menu/Set, 2, 4.**

- 2 Press  to select **LETTER, A4** or **LEGAL**, and then press **Menu/Set.**

- 3 Press **Stop/Exit.**

6 Using Brother DCP as a Printer

Special Printing Features

Windows® Printing

The dedicated printer driver and TrueType™ compatible fonts for Microsoft® Windows® 95/98/98SE/Me/2000 Professional and Windows NT® Workstation Version 4.0 are available on the CD-ROM supplied with your machine. You can install them easily into your Windows® system using our installer program. The driver supports our unique compression mode to enhance print speed in Windows® applications; it allows you to set various printer settings, including economy print mode and custom paper size.

Bi-directional Parallel Interface

The Brother DCP's parallel interface enables it to send memory and printer setup information to the computer.

Printing from Your PC

Multi-purpose Sheet Feeder

The DCP's multi-purpose sheet feeder can feed plain paper, envelopes, and organizer paper. When the machine receives data from your computer, it begins the print process by loading paper from the multi-purpose sheet feeder.

- Select the print command from your PC.

Your PC sends a print command and data to the DCP. If there are more pages, the DCP begins to print the next page automatically.



You may select the paper source, paper size, and orientation in your application software.

If your application software does not support your custom paper size, select the next larger paper size. Then adjust the print area by changing the left and right margins in your application software. (See *Acceptable Paper*, page 2-7.)

Two-Sided Printing (Manual Duplex)

The supplied printer drivers for Windows® 95/98/98SE, Windows NT® Workstation Version 4.0 support manual duplex printing. (For more information, see the Help screen for the printer driver.)

Please select LPT1 port in the printer driver. The machine prints all the even-numbered pages on one side of the paper first. Then, the Windows® driver instructs you (with a pop-up message) to reinsert the paper. Before reinserting the paper, straighten it well or you may get a paper jam. Very thin or very thick paper is not recommended. If the paper “double-feeds” (sends two sheets at once), hold the stack of paper except for the front sheet while the paper is feeding.

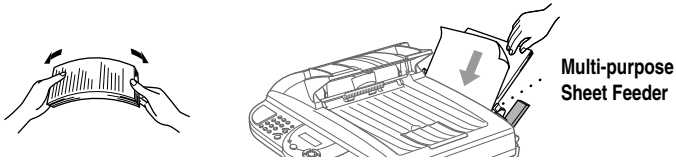

! When you use manual duplexing, it is possible that a paper jam may occur or the printer quality might not be satisfactory.

Loading Envelopes in Multi-purpose Sheet Feeder

You can load up to 10 envelopes into the multi-purpose sheet feeder. Press and hold the blue lever on the right as you load the envelopes and slide the paper guides to fit. Make sure envelopes are inserted in the direction shown below.

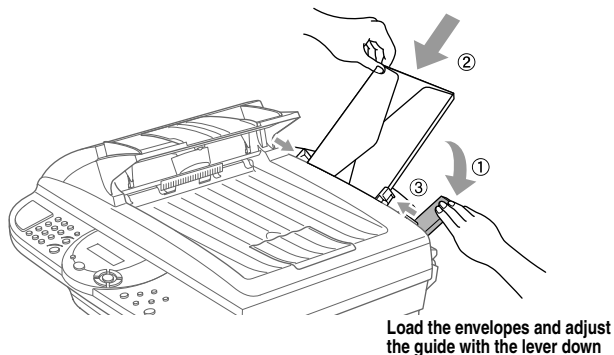

Paper Tray

The DCP ejects paper with printed surfaces *face down* into the paper tray at the front of the machine. When you use transparencies, remove each sheet immediately after printing, to prevent a paper jam or curled sheets.

Simultaneous Printing/Copying

Your DCP can print data from your computer while scanning information into the computer. However, when the DCP is copying on paper, it pauses the PC printing operation and then resumes when copying is complete.

Choosing Acceptable Paper

We recommend that you test paper, especially special sizes and types, on the DCP before purchasing large quantities. See *Acceptable Paper*, page 2-7.

- Avoid feeding labels with carrier sheets exposed, or your machine will be damaged.
- Avoid using coated paper, such as vinyl coated paper.
- Avoid using preprinted or highly textured paper.
- For optimum printing use a recommended type of paper, especially plain paper and transparencies. For more information on paper specifications, consult your nearest authorized sales representative or the place where you purchased your machine.
- Use labels or transparencies that are designed for use in laser printers.
- For the best print quality we recommend that you use long-grained paper.
- You can use recycled paper.

Printer Operations

Reset Key

Press this key to clear data from the memory.

7 Printer Driver Settings (For Windows® Only)

Using the Brother DCP-1000 Printer Driver

A Printer Driver is software that translates data from the format used by a computer into the format required by a particular printer, using a printer command language or page description language.

The printer drivers are on the supplied CD-ROM. The latest printer driver can also be downloaded from the Brother Solutions Center at

<http://solutions.brother.com>

Features in the Printer Driver (For Windows® Users Only)



The screens shown in this section are from Windows® 98. The screens on your PC may vary depending on your Windows® Operating System.

For more detailed information, please see the on-line Help in the printer driver.

Basic Tab

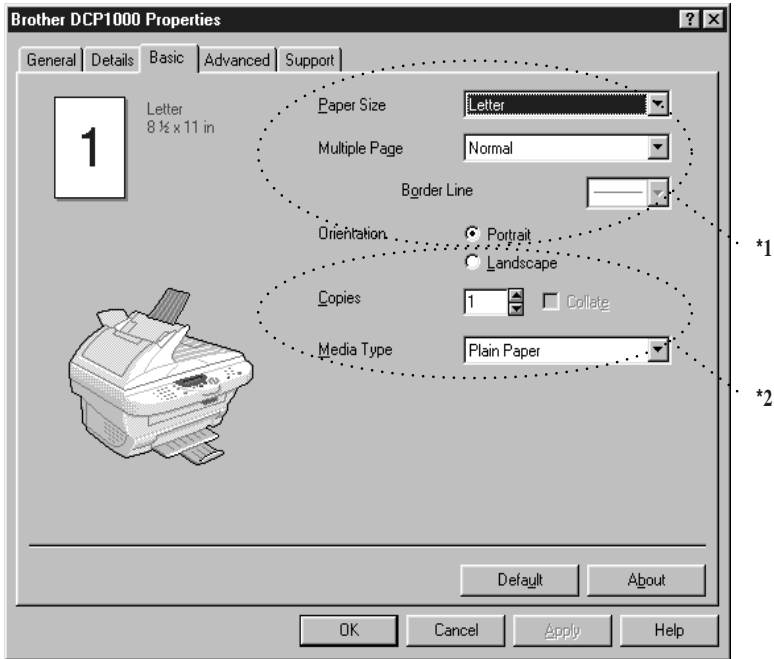

- *1 Select the Paper size, Multiple Page and Orientation.
- *2 Select number of Copies and Media Type.

Paper Size

From the drop-down box select the Paper Size you are using.

Multiple Page

The Multiple Page selection can reduce the image size of a page allowing multiple pages to be printed on one sheet of paper or enlarging the image size for printing on page on multiple sheets of paper.

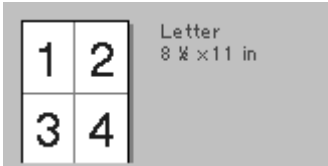

Ex. 4 in 1



Ex. 1 in 2 x 2 pages

Border Line

When printing multiple pages on one sheet with the Multiple Page feature you can select to have a solid border, dash border or no border around each page on the sheet.

Orientation

Orientation selects the position of how your document will be printed (Portrait or Landscape).

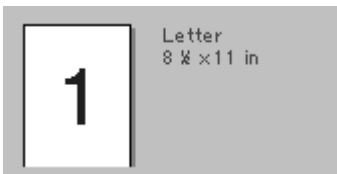

Portrait

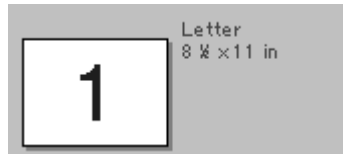

Landscape

Copies

The copies selection sets the number of copies that will be printed.

Collate

The collate selection is active if more than one copy is selected. With the collate check box selected, one complete copy of your document will be printed and then repeated for the number of copies you selected. If the collate check box is not selected then each page will be printed for all the copies selected before the next page in the document is printed.

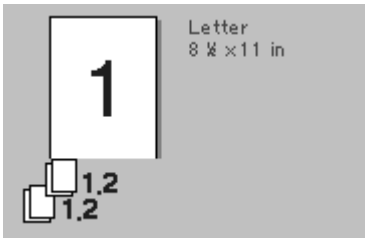

Collate box checked

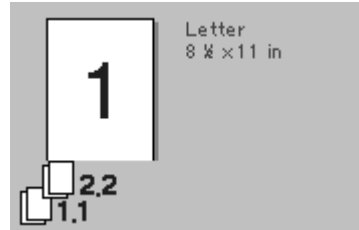

Collate box not checked

Media Type

You can use the following types of media in your printer. For the best print quality, select the type of media that you wish to use.

Plain Paper

Thin Paper

Thick Paper

Thicker Paper

Bond Paper

Transparencies

When using ordinary plain paper, select **Plain Paper**. When using heavier weight paper, envelopes or rough paper select **Thick Paper** or **Thicker Paper**. For bond paper, select **Bond Paper** and for OHP transparencies, select **Transparencies**.

Advanced Tab

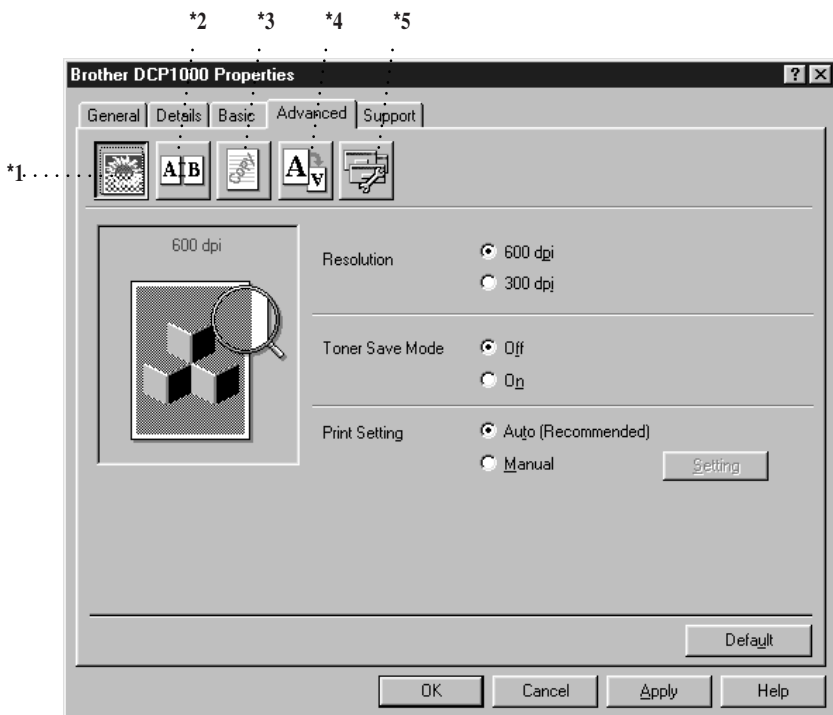

Change the tab settings by selecting one of the following icons:

- *1 Print Quality
- *2 Duplex Printing
- *3 Watermark
- *4 Page Setting
- *5 Device Option

Print Quality (*1)

Resolution

You can change the resolution as follows:

- 300 dpi
- 600 dpi

Toner Save

You can save running costs by turning on the Toner Save Mode, which reduces the print density.

Print Setting (For Windows® 95/98/98SE/Me Users Only)

Print Setting is used for optimizing your print quality for the type of document being printed (Photos, Graphics or Scanned Images). When you choose **Auto (Recommended)**, the printer automatically prints with the most suitable print settings.

With the Print Setting set to Manual, you can change the Brightness, Contrast and Graphics Quality options manually.

Duplex Printing (*2)

Choosing the Duplex Printing icon displays the Manual Duplex features available.

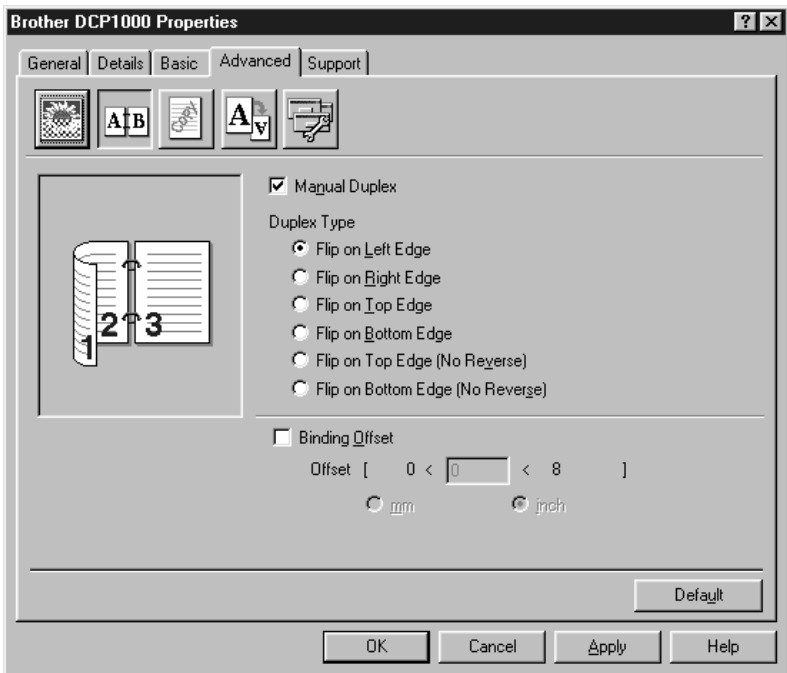

Manual Duplex

Check the Manual Duplex box and there are six types of duplex directions available for each orientation. In this mode, the DCP prints all the even numbered pages first. Then the printer driver stops and shows the instructions required to re-install the paper. When you click OK the odd numbered pages are printed.

Binding Offset

Check the Binding Offset option, you can specify the offset value of the binding side in inches or millimeters (0 - 8 inches) [0 - 203.2 mm].

Watermark (*3)

You can place a logo or text into your document as a Watermark by using a bitmap file as your source file or select one of the preset Watermarks.

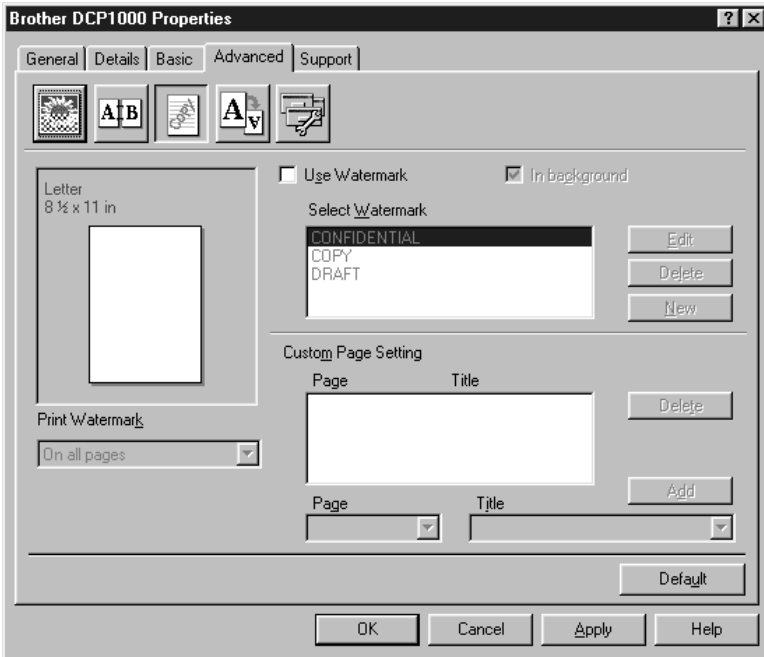

Print Watermark

The Print Watermark feature offers printing choices of:

On all pages

On first page only

From second page

Custom

In Background

With the In background feature checked the Watermark will print behind your document on the page. If this feature is not checked then the Watermark will print on top of your document.

You can change the size and the position of the Watermark on the page by selecting the Watermark and clicking the Edit button. If you want to add a new Watermark, click the New button and select Text or Bitmap from the Watermark Style.

Watermark Text

Enter your Watermark text into the Text Box and select the Font, Size, Darkness and Style.

Watermark Bitmap

Enter the file name and location of your bitmap image in the File box or Browse for the file location. You can also set the scaling size of the image.

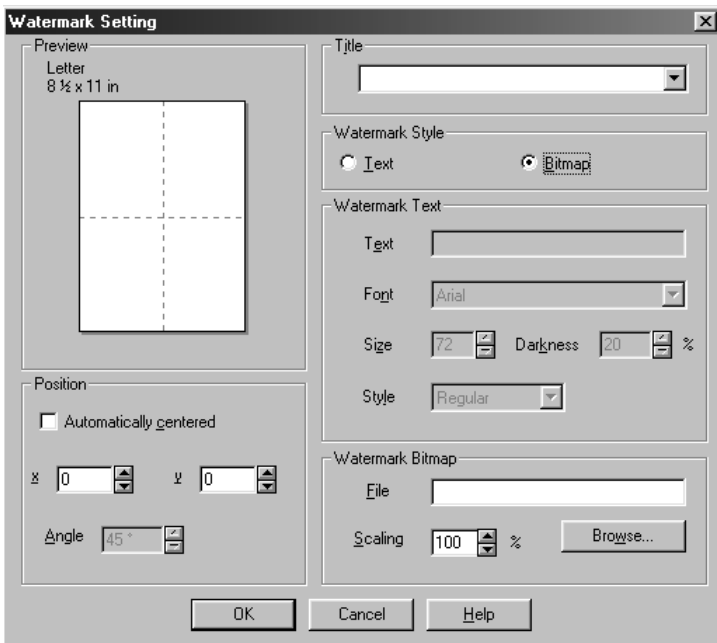

Position

The position settings offer controls on where the Watermark can be positioned on the page.

Page Setting (*4)

You can change the print size of your document with the Scaling feature.

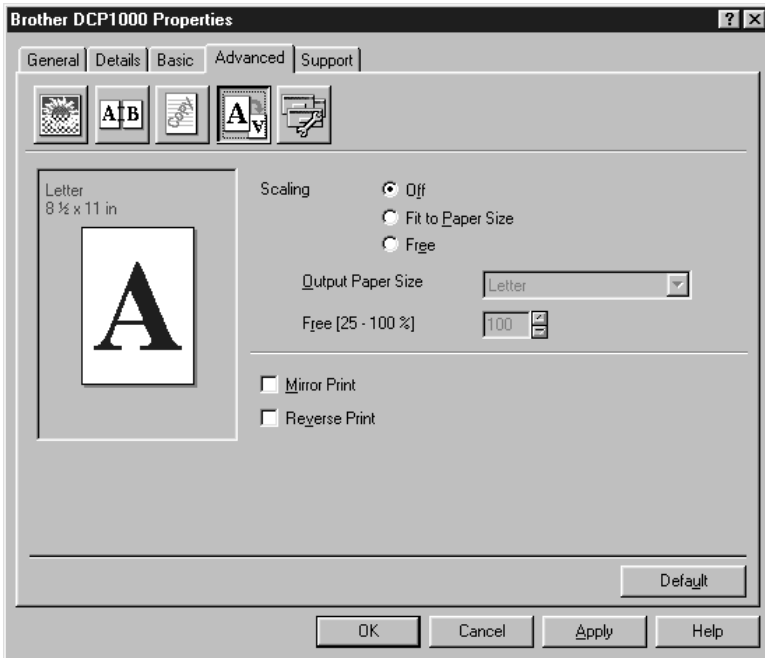

- 1 Check Off if you want to print the document as it appears on your screen.
- 2 Check Fit to Paper Size, if your document has an unusual size, or if you have only the standard size paper.
- 3 Check the Free box if you want to reduce or enlarge the output.

You can also use the Mirror or Reverse Print feature for your page setting.

Device Options (*5)

Set one of the following Printer Functions:

- Quick Print Setup
- Administrator (For Windows® 95/98/98SE/Me Users Only)
- Print Date & Time

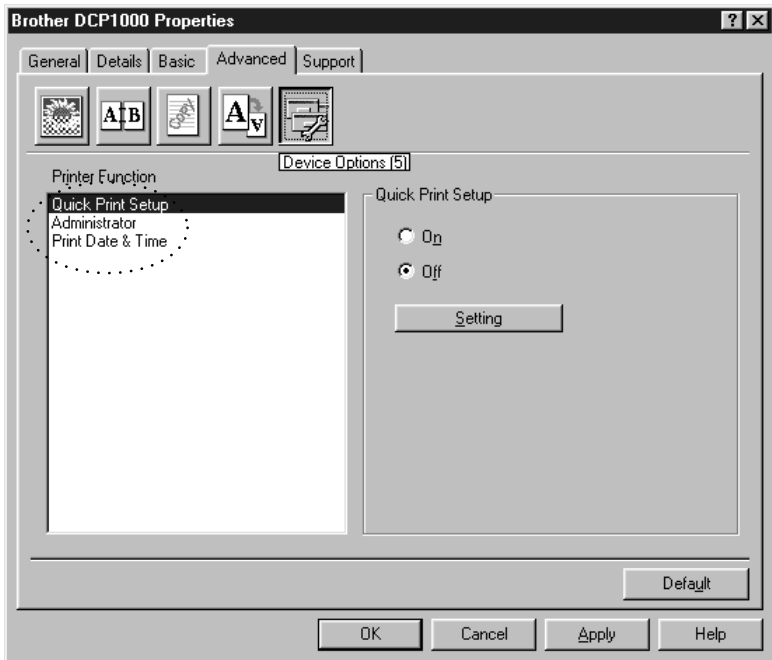

Quick Print Setup

The Quick Print Setup feature allows you to quickly select driver settings. To view settings, simply click your mouse button on the task tray  icon. This feature can be set to ON or OFF from the Device Options section.

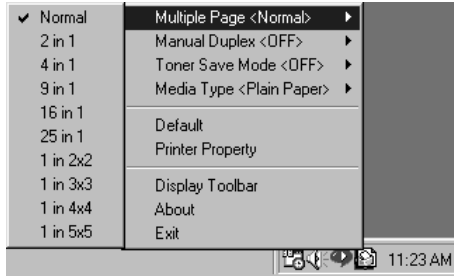

Administrator (For Windows® 95/98/98SE/Me Users Only)

The administrator selection permits the Copy, Scaling and Watermark features to be locked and password protected.

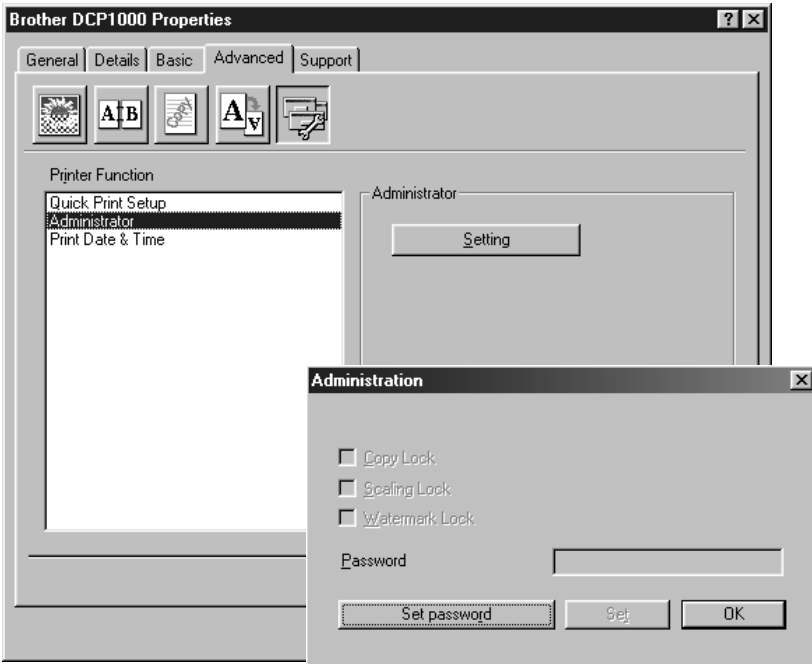

Note Record your password and keep it in a safe place for future reference. If you forget your password these settings can not be accessed.

Print Date & Time

When enabled the Print Date and Time feature will automatically print the date and time on your document from your computers system clock.

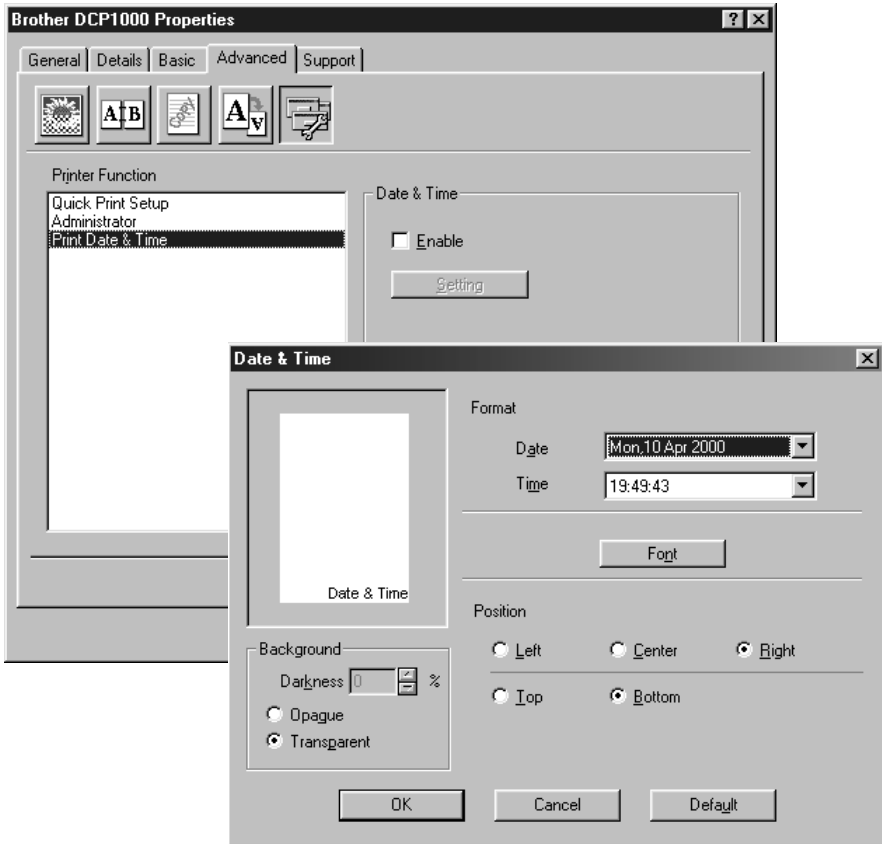

Click the Setting button to change the Date and Time Format, Position and Font. To include a background with the Date and Time select Opaque. When Opaque is selected you can set the Darkness of the Date and Time background by changing the percentage.



The Date and Time indicated in the selection box represents the format that will be printed. The actual Date and Time printed on your document is automatically retrieved from the settings of your computer.

Support

The Support tab provides driver version information and setting information. In addition there are links to the Brother Solution Center and Driver Update Web sites.

Brother Solutions Center

The Brother Solutions Center is a Web site offering information about your Brother product including FAQ's , User Guides, Driver updates and Tips for using your DCP.

Web Update

Web Update checks the brother web site for updated driver and automatically downloads and updates the driver on your computer.

Check Setting

The Check Setting selection displays a list of your current drivers settings.

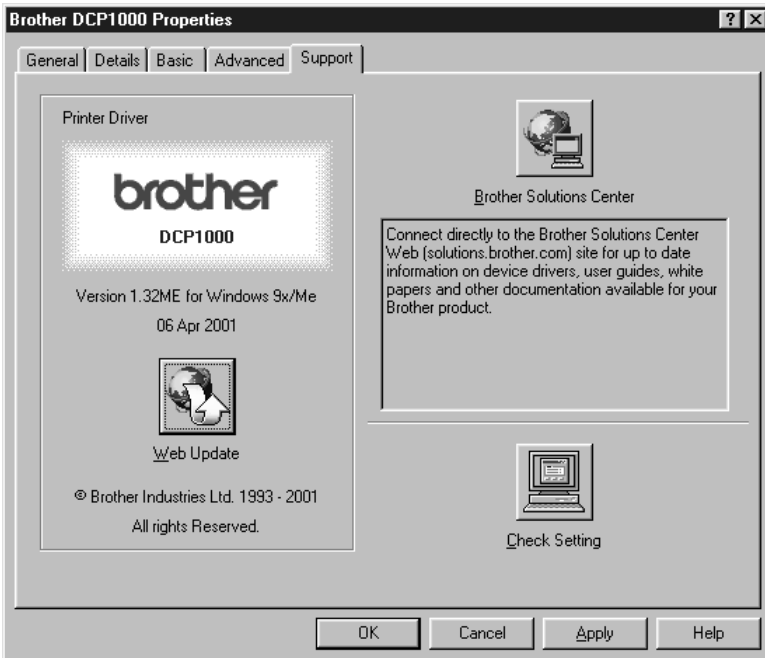

8

Using the Windows®-Based Brother MFL-Pro Control Center (For Windows® Only)

Brother MFL Pro Control Center

The Brother Control Center is a software utility that pops up on the PC screen whenever paper is placed in the automatic document feeder (not on the scanner glass). This allows you to quite easily, with very few mouse clicks, access the most frequently used scanner applications. Using the Control Center eliminates the need to manually launch the specific applications.

The Brother Control Center provides two categories of operations:

- 1 Scanning directly to a file, E-mail, word processor or graphic application of choice
- 2 Copying

DCP-1000

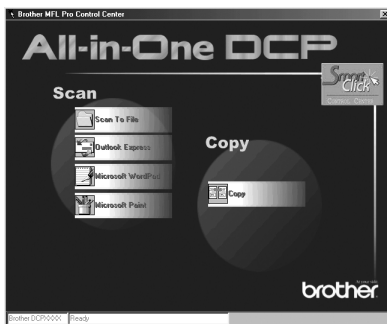

AutoLoad the Brother Control Center

The Control Center is initially configured to automatically load each time Windows® is started. When the Control Center is loaded, the Control



Center  icon will appear in the task bar. If you don't want the Control Center to load automatically, you can turn off AutoLoad.



If the Control Center  icon does not appear in your task bar, you will have to launch this software.

From the **Start** menu, select **Programs, PaperPort**, and then double-click **Brother SmartUI POPUP**.

How to Turn Off AutoLoad

- 1 Left click the Control Center  icon and click **Show**.
- 2 When the Control Center main screen appears, left click the Smart Click  Control Center button. A dialogue box with a check box labeled “AutoLoad Pop-up” will appear:

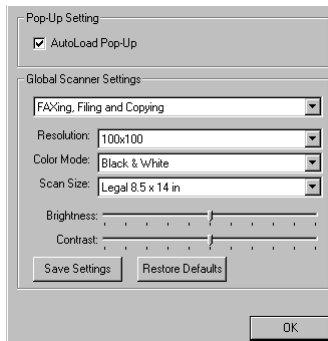

- 3 Uncheck the AutoLoad Pop-Up option.

Using the Scan Key

You can use the Scan key on the control panel to scan originals into your word processing, graphics or E-mail applications.

The advantage of using the **Scan to** key is that you avoid the mouse clicks required to scan from your PC.

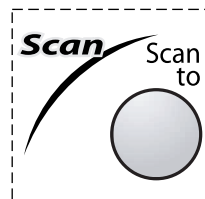

Using the Control Panel Keys

-  If you have connected a Macintosh, the control panel keys will not work with your computer. Please see page 11-1.

Before you can use the **Scan to** key on the control panel, you must have connected the DCP to your Windows®-based PC and loaded the appropriate Brother Drivers for your version of Windows®. When you are ready to use the Scan key, make sure the Brother Control Center application is running on your PC.

Scan Image

You can scan a color picture into your graphics application for viewing and editing.

- 1 Place the original face up in the ADF.
- 2 Press **Scan to**.
- 3 Press  to select **SCAN IMAGE**, and then press **Menu/Set**.

The machine will scan the original and send an image to your graphics application.

Scan/OCR

If your original is text, you can have it automatically converted by ScanSoft™ TextBridge® to an editable text file and then displayed in your word processing application for further editing.

- 1 Place the original face up in the ADF.
- 2 Press **Scan to**.
- 3 Press  to select **SCAN/OCR**, and then press **Menu/Set**.

The machine will scan the original, perform OCR in ScanSoft™ TextBridge®, and then display the result in your word processing application for viewing and editing.

Scan to E-mail

You can scan a color original into your E-mail application as a file attachment. Although the Brother Control Center can be configured to send file attachments at one time, you can easily change this setting.

- 1 Place the original face up in the ADF.
- 2 Press **Scan to**.
- 3 Press  to select **SCAN TO E-MAIL**, and then press **Menu/Set**.



The machine will scan the original, create a file attachment, and launch your E-mail application, displaying the new message waiting to be addressed.

Brother Control Center Features

Auto Configuration

During the installation process the Control Center checks your system to determine the default applications for E-mail, word processing and graphics viewer/editor. For example, if you are using Outlook as your default E-mail application, the Control Center automatically will create a link and a scanning application button for Outlook.

You can change a default application by right clicking on any of the scan buttons in the Control Center and selecting a different application. For example,

you can change a scan button from MS Word  to MS Word Pad  by changing the application that is listed for the Word Processor.



Scanning Operations

Scan to File—allows you to scan directly to a disk file with two mouse clicks. You can change the file type, destination directory and file name, as needed.

Scan to E-mail—enables you, with just two mouse clicks, to scan a picture or text document directly into an E-mail application as a standard attachment. You have the option of selecting the file type and resolution for the attachment.

Scan to Word Processor—enables you to scan a text document, run ScanSoft TextBridge OCR and insert the text original (not graphic image) into a word processing file with just two mouse clicks. You have the option of selecting the destination word processing program, such as Word Pad, MS Word, Word Perfect, etc.

Scan to Graphic Application—allows you to scan an image directly into any graphic viewer/editor application. You can select the destination application, such as MS Paint or Corel PhotoPaint.

Copy Operations

Copy—allows you to use the PC and any Windows® printer driver for enhanced copy functions. You can scan the page on the Brother machine and print the copies using any of the features of the Brother machine printer driver—**OR**—you can direct the copy output to any standard Windows® printer driver installed on the PC.

Scanner Settings for Scan and Copy Buttons

When the Pop-Up window appears, you can access the Scanner Settings window.

Click the Smart Click  icon at the top right of the Brother Control Center screen—**OR**—Click **Modify Settings...** on any of the Configuration screens.

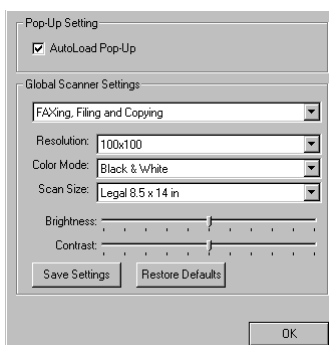

Global Settings

AutoLoad Pop-Up—Click this checkbox if you want Brother MFL Control Center to load when you boot your computer.

Setting Up the Scanner Configurations

The Pop-Up application stores eight different scanning modes. Each time you scan an original, you will choose the most appropriate scanning mode from the following:

Filing and Copying

Text for OCR

Photos

Photos (High Quality)

Photos (Quick Scan)

Custom

Draft Copy

Fine Copy

Each mode has its own set of stored settings. You can keep the factory default settings or change them at any time:

Resolution—Select the scanning resolution you most frequently use.

Color Mode—From the pull-down list, select

Scan Size—From the pull-down list, select

Brightness—Slide the adjuster from 0% to 100%

Contrast—Slide the adjuster from 0% to 100%

Click **OK** to save your changes. If you make a mistake or later decide to return to the original default setting, just click **Restore Defaults** when the scanning mode is displayed.

To Access the Scanner Configurations Screen

- 1 Place the original face up in the ADF. Then the Brother Control Center screen pops up.
- 2 Right-click the appropriate Control Center button to display *Configurations...*, then click it. The configuration screen for that **Control Center** button will appear.
- 3 To save your settings, click **OK** —**OR**—To return to the factory default settings, click **Restore Defaults**.



You can not access the Scanner Configuration screen by placing the document on the scanner glass.

Perform an Operation from the Control Center Screen

If you see this screen it means you left-clicked a button in the Control Center window without first placing an original in the ADF.

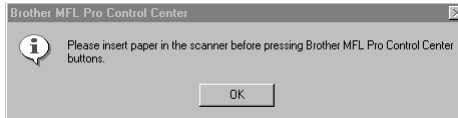

Place the original in the Brother machine's ADF, then click **OK** to return to the Control Center screen.



If you want to scan the document from the scanner glass, please use the **Scan to** key on the control panel. (See *Using the Control Panel Keys*, page 8-2.)

Scan to File

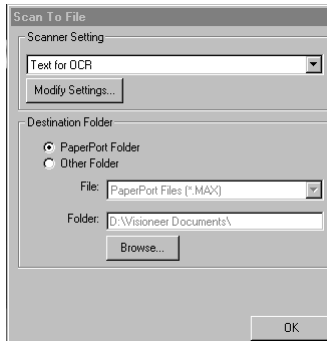

Scanner Settings

From the pull-down list, select the scanning mode that is appropriate for the type of file: Filing and Copying; Text for OCR; Photos; Photos (High Quality); Photos (Quick Scan); Custom; Draft Copy or Fine Copy.

To change any of the settings for that mode, click **Modify Settings**.

Destination Folder

PaperPort Folder—Select this checkbox to scan the original into your PaperPort folder.

Other Folder—Select this checkbox, to scan the original as another file type and/or into another directory/folder.

File—If you selected Other Folder, from the pull-down list select the type of file:

- PaperPort Files (*.MAX)
- Self Viewing Files (*.EXE)
- PaperPort 5.0 Files (*.MAX)
- PaperPort 4.0 Files (*.MAX)
- PaperPort 3.0 Files (*.MAX)
- Windows Bitmap (*.BMP)
- PC Paintbrush (*.PCX)
- Multi-page PCX (*.DCX)
- JPEG Image Files (*.JPG)
- TIFF-Uncompressed (*.TIF)
- TIFF Group 4 (*.TIF)
- TIFF Class F (*.TIF)
- Multi-Page TIFF-Uncompressed (*.TIF)
- Multi-Page TIFF Group 4 (*.TIF)
- Multi-Page TIFF Class F (*.TIF)
- PDF Files (*.PDF)
- Portable Network Graphics (*.PNG)
- FlashPix (*.FPX)
- HFX Fax Files (*.HFX)

To Search your system for the directory and folder you want, click **Browse...**. Click **OK** to save your settings.

Scan to E-mail

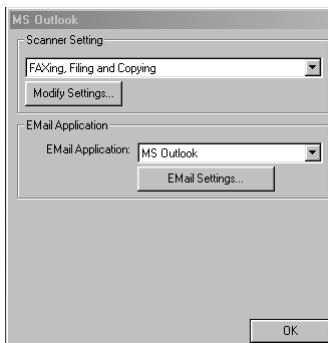

Scanner Settings

From the pull-down list, select the scanning mode that is appropriate for the type of file: Filing and Copying; Text for OCR; Photos; Photos (High Quality); Photos (Quick Scan); Custom; Draft Copy or Fine Copy.

To change any of the settings for that mode, click **Modify Settings....**

E-mail Application

E-mail Application—From the pull-down list, select your E-mail application.

E-mail Settings—Click **E Mail Settings...** to set up links.

The Links Preferences window will appear:

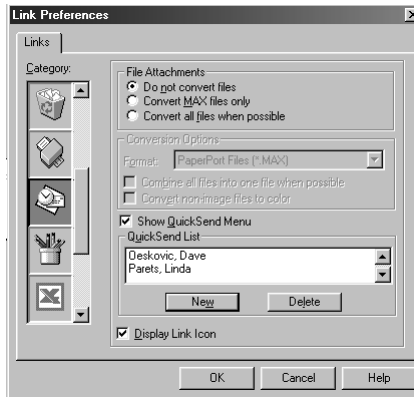

File Attachments

Do not convert files—Click this checkbox if you do not want to change the file type of attachments. The Conversion Options will not be available (grayed).

Convert MAX files only—Click this checkbox if you want to convert only attachments that are PaperPort files.

Convert all files when possible—Click this checkbox if you want to change the file type of all attachments.

Conversion Options

Format

Combine all files into one file when possible—Click this checkbox to combine all files of the same type into one file.

(For Brother Color Models Only) *Convert non-image files to color*—Click this checkbox to convert all files that have been processed through OCR to color.

Show QuickSend Menu

Click this checkbox if you want the Select QuickSend Recipient window to be displayed when you choose Scan to E-mail. This feature works only with MAPI type E-mail applications, such as Microsoft Exchange, Microsoft Outlook and Eudora.

QuickSend List

You can create a list of Email names and addresses for quick selection.

Click the **New** button to add a name(s) to your QuickSend list, Your Email phone book listing will be displayed, so you can select stored names or create new ones:



Highlight the name(s) you want to add to your list, and then click **User**. Click **OK** to return to the Link Preference window.

To remove a name from the QuickSend list in the Link Preference window, highlight the name and click **Delete**.

Scan to Word Processor

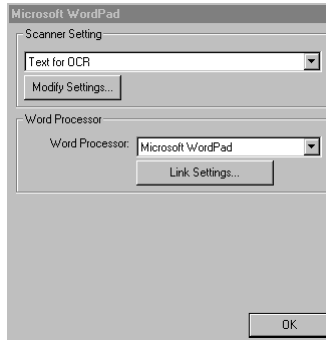

Scanner Settings

From the pull-down list, select the scanning mode that is appropriate for the type of file: Filing and Copying; Text for OCR; Photos; Photos (High Quality); Photos (Quick Scan); Custom; Draft Copy or Fine Copy.

To change any of the settings for that mode, click **Modify Settings...**

Word Processor

Word Processor—From the pull-down list, select the word processor you want to use.

Click **Link Settings...** to display a screen to set up a link to the version of OCR and document format that you want to use:

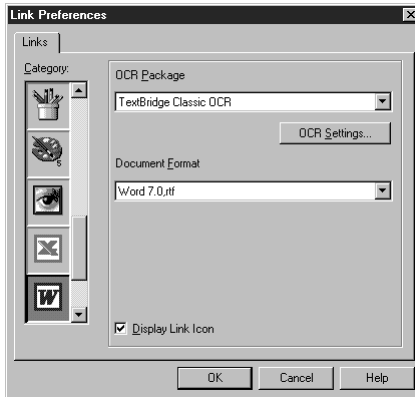

OCR Package—From the pull-down list, select *TextBridge Classic OCR* if you want to use the OCR package that was installed with the Brother software.

Click **OCR Settings...** to choose how the OCR application will read the pages you scan into your word processor application.

The Preferences window will appear:

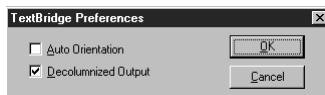

Select your setting, and then click **OK**.

- *Auto Orientation*—Check this checkbox if you want your word processor application to read the page as it is set up.
- *Decolumnized Output*—Check this checkbox if you want your word processor application to read across the entire page from left to right.

Document Format—From the pull-down list, select the file format you want to use for your word processor or text documents.

User-Defined Button

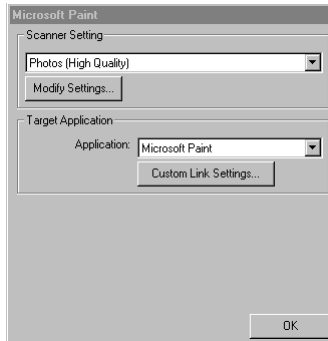

Scanner Settings

From the pull-down list, select the scanning mode that is appropriate for the type of file: Filing and Copying; Text for OCR; Photos; Photos (High Quality); Photos (Quick Scan); Custom; Draft Copy or Fine Copy.

To change any of the settings for that mode, click **Modify Settings...**

Target Application

Application—From the pull-down list, select the application you want to add to this Pop-Up screen.

Click **Custom Link Settings...** to set up links for your user-defined application.

Copy

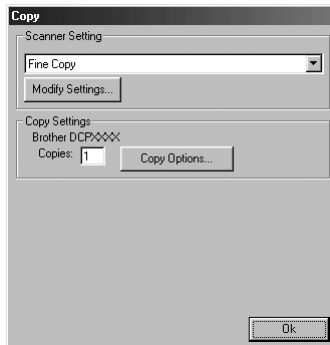

Scanner Settings

From the pull-down list, select the scanning mode that is appropriate for the type of file: Filing and Copying; Text for OCR; Photos; Photos (High Quality); Photos (Quick Scan); Custom; Draft Copy or Fine Copy.

To change any of the settings for that mode, click **Modify Settings...**

Copy Settings

Brother DCP-1000

Copies—Enter the number of copies you want to print.

To change the copy options, click **Copy Options...**

Click **OK** to save your Copy settings.

9 Using ScanSoft™ PaperPort® for Brother and ScanSoft™ TextBridge®

Using ScanSoft™ PaperPort® and TextBridge®

ScanSoft™ PaperPort® for Brother is a document management application. You will use PaperPort® to view scanned documents. PaperPort® has a sophisticated, yet easy-to-use, filing system that will help you organize your documents. It allows you to combine or “stack” documents of different formats for printing or filing. PaperPort® can be accessed through the PaperPort® program group. See *On-Line Documentation for Multi-Function Link® Pro* on the CD-ROM.

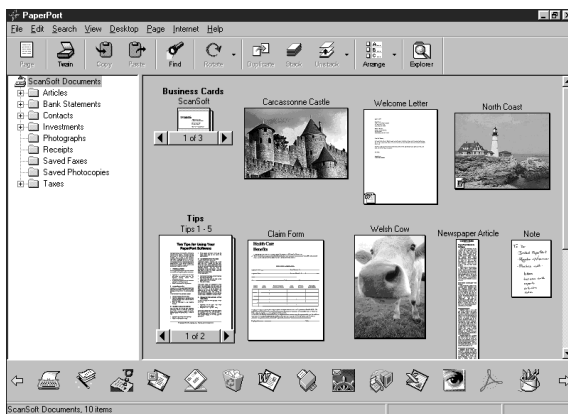

The complete ScanSoft™ PaperPort® Owner’s Manual, including ScanSoft™ TextBridge® OCR, is in the On-Line Documentation on the CD-ROM. This chapter is only an introduction to the basic operations.

When you install Multi-Function Link® Pro Suite, ScanSoft™ PaperPort® for Brother and ScanSoft™ TextBridge® OCR are installed with it automatically.



To Uninstall PaperPort® and ScanSoft™ TextBridge

For Windows® 95/98/98SE, and Windows NT® Workstation 4.0, Windows® ME and Windows® 2000 Professional:

Select **Start, Settings, Control Panel, Add/Remove Programs** and the **Install/Uninstall** tab. Select **PaperPort®** from the list and click the **Add/Remove** button.

Viewing Items

PaperPort® provides several ways to view items: **Desktop View** displays a **thumbnail**, a small graphic that represents each item in a Desktop or folder. Items in the selected folder appear on the PaperPort® Desktop. You can see PaperPort® items (MAX files) and non-PaperPort® items (files created using other applications).

Non-PaperPort® items include an icon that indicates the application that was used to create the item; a non-PaperPort® item is represented by a small rectangular thumbnail and not an actual image.

Page View displays a close-up of a single page and you can open a PaperPort® item by double-clicking on it. As long as you have the appropriate application on your computer to display it, you can also double-click a non-PaperPort® item to open it.

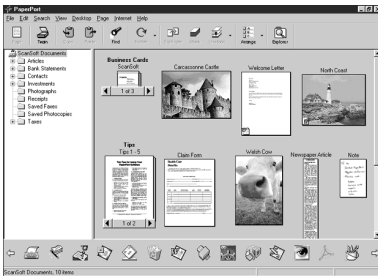

Desktop View displays items as thumbnails



Page View displays each item as a full page

Organizing Your Items in Folders

PaperPort® has an easy-to-use filing system for organizing your items. The filing system consists of folders and items that you select to view in Desktop View. An item can be a PaperPort® item or a non-PaperPort® item:

- Folders are arranged in a “tree” structure in the Folder View. You use this pane to select folders and view their items in Desktop View.
- You can simply drag and drop an item onto a folder. When the folder is highlighted, release the mouse button and the item is stored in that folder.
- Folders can be “nested”—that is, stored in other folders.
- When you double-click a folder, its items (both PaperPort® MAX files and other files) appear on the Desktop.
- You can also use Windows® Explorer to manage the folders and items shown in Desktop View.

Links to Many Other Applications

PaperPort® automatically recognizes many other applications on your computer and creates a “working link” to them. The Link Bar at the bottom of Desktop view shows icons of those linked applications. To use a link, drag an item onto one of the icons to start the application represented by the icon.

This sample Link Bar shows several applications with links to PaperPort®.



If PaperPort® does not automatically recognize one of the applications on your computer, you can manually create a link using the **Create New Link** command. (See *PaperPort® Help* for more information about creating new links.)

Using ScanSoft™ TextBridge® OCR (Converting Image Text to Text You Can Edit)

Software by: 

ScanSoft™ TextBridge® OCR is automatically installed with PaperPort® when you install Multi-Function Link® Pro Suite on your computer.

PaperPort® can quickly convert the text on a PaperPort® item (which is really just a picture of the text) into text that you can edit with a word processing application. PaperPort® uses the optical character recognition application ScanSoft™ TextBridge, which comes with PaperPort®—**OR**—PaperPort® uses your application if it is already on your computer. You can convert the entire item, or by using the **Copy As Text** command, you can select only a portion of the text to convert.

Dragging an item onto a word-processing link icon starts PaperPort®’s built-in OCR application, or you can use your own OCR application.



Importing Items from Other Applications

In addition to scanning items, you can bring items into PaperPort® in a variety of ways and convert them to PaperPort® (MAX) files in several different ways:

- Print to the Desktop View from another application, such as Microsoft Excel.
- Import files saved in other file formats, such as Windows® Bitmap (BMP) or Tag Image File Format (TIFF).

Exporting Items in Other Formats

You can export or save PaperPort® items in several popular file formats. For Windows® 95/98/98SE, and Windows NT® Workstation Version 4.0, Windows® 2000 Professional and Windows® Me, you can export formats BMP, PCX, DCX, JPG, TIF, PDF, PNG, FFX, HFX, or self-viewing. For example, you could create a file for an Internet Web site and export it as a JPEG file. Web pages often use JPEG files for displaying images.

Exporting an Image File

- 1 Select the Export command from the File pull-down menu in the PaperPort® window. The Export ‘XXXXX’ As dialog box will be displayed.
- 2 Select the drive and directory where you want to store the file.
- 3 Enter the new file name and choose the file type or select a name from the File Name text box. (You can scroll through the Directories and File Name listing for prompting.)
- 4 Select **OK** to save your file, or **Cancel** to return to the PaperPort® without saving it.

Accessing the Scanner

To choose the TWAIN_32 Brother MFL Pro Color as your scanner driver, select it under the “Select scanner”—**OR**—“Select source” option in your software.

From the PaperPort® window, select **Acquire** from the File drop-down menu or select the **TWAIN** or **Scan** button. The Multi-Function Link® Pro Color Setup dialog box will appear:

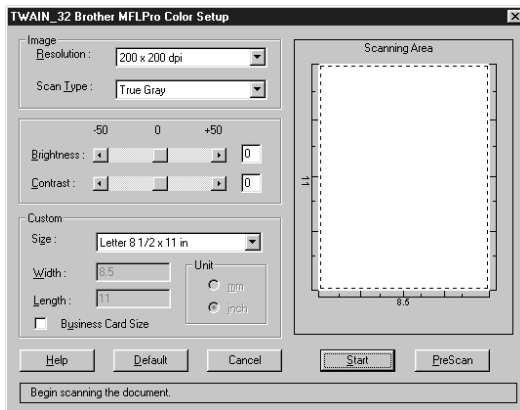

Scanning an Image into Your PC

- 1 Place the original face up in the ADF, or face down on the scanner glass.
- 2 Adjust the following settings, if needed, in the Scanner Setup window:
 - Resolution
 - Scan Type (Black & White, Gray [Error Diffusion], True Gray, 256 color, 24 bit color, 24 bit color (Fast))
 - Brightness
 - Contrast
 - Size
- 3 Select the **Start** button from the Scanner window.

When scanning is completed, close the scanner window. The PaperPort® screen will appear showing the image you scanned highlighted in red.

Settings in the Scanner Window

Image

Resolution

Select the scanning resolution from the Resolution drop down list. Higher resolutions take more memory and transfer time, but can achieve a finer scanned image.

Scan Type

Black & White: Set the Color Type to Black & White for text or line art.

Gray Scale: For photographic images, set the Color Type to Gray (Error Diffusion) or True Gray.

Colors: Choose either 256 Color, which scans up to 256 colors, 24-bit color which scans up to 16.8 million colors. Although using 24-bit color creates an image with the most accurate colors, the image file will be approximately three times larger than a file created with 256 Color.

Brightness

Brightness: Adjusting the brightness settings to obtain the best image. Brother Multi-Function Link® Pro Suite offers 100 brightness settings (-50 to 50). The default value is 0, representing an “average” setting.

You can set the brightness level by dragging the slider to the right to lighten the image or to the left to darken the image. You can also type a value in the box to set the settings.

If the scanned image is too light, set a lower brightness value and scan the document again.

If the image is too dark, set a higher brightness value and scan the document again.

Contrast

The contrast setting is adjustable only when you have selected one of the gray scale settings, but it is not available when Black & White is selected as the gray Scale.

Increasing the contrast level (by dragging the slider to the right) emphasizes dark and light areas of the Image, while decreasing the contrast level (by dragging the slider to the left) reveals more detail in gray areas. Instead of using the slider, you can type a value in the box to set the contrast.

Custom

Size

Set the Size to one of the following:

- Letter (8 1/2 × 11 in.)
- A4 (210 × 297 mm.)
- Legal (8 1/2 × 14 in.)
- A5 (148 × 210 mm.)
- B5 (182 × 257 mm.)
- Executive (7 1/4 × 10 1/2 in.)
- Business Card (60 × 90 mm.)
- Custom (User adjustable from 0.35 × 0.35 in. to 8.5 × 14 in.)

After you select a custom size, you can adjust the scanning area further by using the left mouse button to drag the dotted outline of the scanning area. This is required when you want to crop an image when scanning.

Business Card Size

To scan business cards, select the Business Card (60 × 90 mm.) size setting and place the business card at the center of the scanner glass.



Carrier sheets are available from your Dealer.

When scanning photographs or other images for use in a word processor or other graphics application, you should try different settings for the contrast, mode and resolution to see which settings best suit your needs.

PreScanning an Image

PreScanning allows you to scan an image quickly at a low resolution. A thumbnail version of the image will appear in the Scanning Area. This is only a preview of the image so you can see how it will look. The PreScan button is used to preview an image for cropping any unwanted portions from the image. When you are satisfied with the preview, click **Start** to scan the image.

- 1 Place the original face up in the ADF, or face down on the scanner glass.
- 2 Click **PreScan**:

The entire original will be scanned into the PC and will appear in the Scanning Area of the Scanner window.

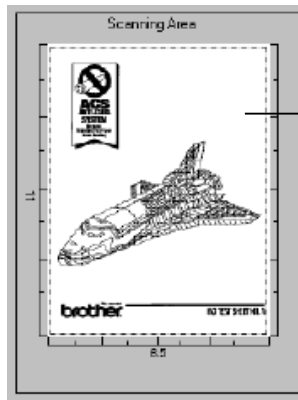

- 3 To crop a portion of the document to be scanned, drag any side or corner of the dotted outline in the Scanning Area with the left mouse button. Adjust the dotted outline until it surrounds only the portion of the original you wish to scan.
- 4 Place the original face up in the ADF again, if you used the ADF in Step 1.
- 5 Adjust the settings for Resolution, Scan Type, Brightness, Contrast, and Size in the Scanner Setup window, as needed.
- 6 Click **Start**.
This time only the selected area of the document will appear in the PaperPort® window.
- 7 In the PaperPort® window, use the options available in the Markups pull-down menu and the Crop option in the Options pull-down menu to refine the image.

10 Using Automatic E-Mail Printing

For Windows® 95, 98, 98SE, Me Only

Main Features

- You can use Automatic E-Mail Printing with other E-mail software: Brother Automatic E-Mail Printing has some extra functions that other E-mail software, such as Netscape Navigator™ or MS Internet Mail, do not support.
- Automatic E-Mail Printing can be configured for a multiple user account: In Brother Automatic E-Mail Printing you can set up more than one e-mail account on a single PC so you can print e-mail in each account automatically.
- Automatic access to your specified POP3 server at the specified time: You can specify the time when the Brother Automatic E-Mail Printing automatically accesses the server to check for new mail.
- Provides an “In Memory” printer driver: You can receive and print e-mail data at the same time, by searching for a specified character string in the mail header. It allows you to see the sender, subject and relevant part of the mail content.

Before You Use this Software

Please read *Using Automatic E-Mail Printing* in the **On-Line Documentation** on the CD-ROM. Check the online README.WRI file in the root directory of the CD-ROM for last-minute important information and troubleshooting tips not included in the On-Line Documentation.

To Access the On-Line Documentation



After you have installed the Brother driver(s) for your model and operating system, click **View On-Line Documentation** for operating instructions.

To Install Automatic E-mail Printing (Optional Application)

- 1 Insert the MFL Pro CD-ROM into your CD-ROM drive.
- 2 Click **Install Software** from the main CD-ROM screen.
- 3 Click **Automatic E-mail Printing**.



This is optional software and will not be required for printing and scanning operations.

The “Automatic E-mail Printing” option is NOT available for Windows NT® 4.0 and Windows® 2000 Professional.

11 Using the Brother machine with a New Power Macintosh® G3, G4 or iMac™ /iBook

Set up Your USB Equipped Apple® Macintosh® G3, G4, iMac™ or iBook with Mac OS 8.5/8.51/8.6/9.0/9.0.4/9.1

Note Before you can connect the machine to your Macintosh®, you must purchase a USB cable that is no longer than 6 feet (1.8 meters).

To work with your DCP your USB Equipped Apple® Macintosh® must be set up with Mac OS 8.5/8.51/8.6/9.0/9.0.4/9.1 (The Brother Scanner Driver works only with Mac OS 8.6/9.0/9.0.4/9.1)

Please check both www.brother.com and www.solutions.brother.com for the OS X drivers and all driver updates.

Using Brother Printer Driver with Your Apple® Macintosh®

To select the Printer:

- 1 From the Apple menu, open the **Chooser**.

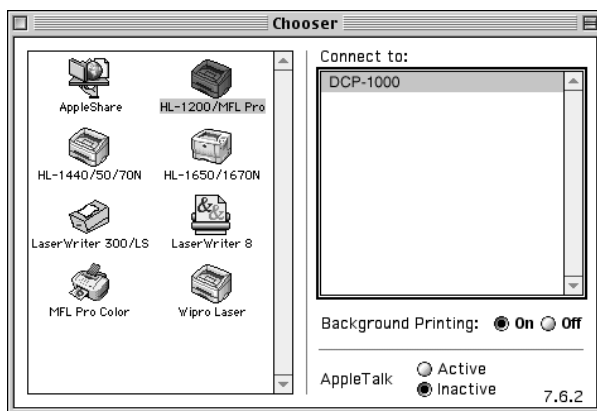

- 2 Click the **HL-1200/MFL Pro** icon. On the right side of the Chooser, click the printer to which you want to print. Close the Chooser.

To print the document:

- From application software such as PaperPort®, click *File menu* and select *Page Setup*. You can change the settings for **Paper Size**, **Orientation** and **Scaling**, and then click **OK**.

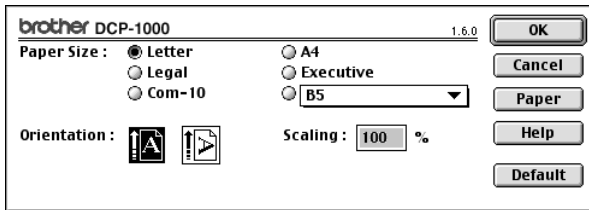

- From application software such as PaperPort, click *File menu* and select *Print*. Click **Print** to start printing.

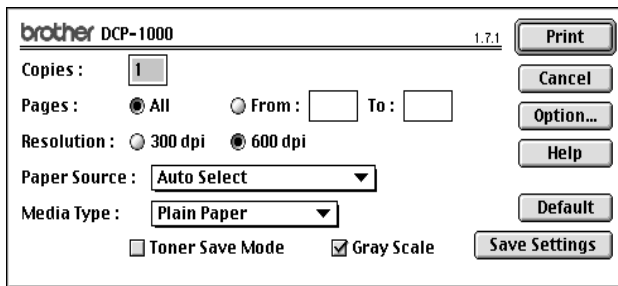

If you want to change **Copies**, **Pages**, **Resolution**, **Paper Source** and **Media Type**, select your settings before clicking **Print**.

Option Setup allows you to change **Duplex**.

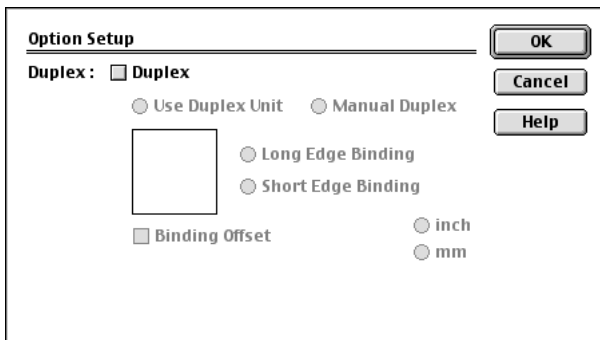

Using Brother TWAIN Scanner Driver with Your Apple® Macintosh®

The Brother software includes a TWAIN Scanner driver for Macintosh®. This Macintosh® TWAIN Scanner driver can be used with applications that support the TWAIN specification. You can use PaperPort® for scanning.

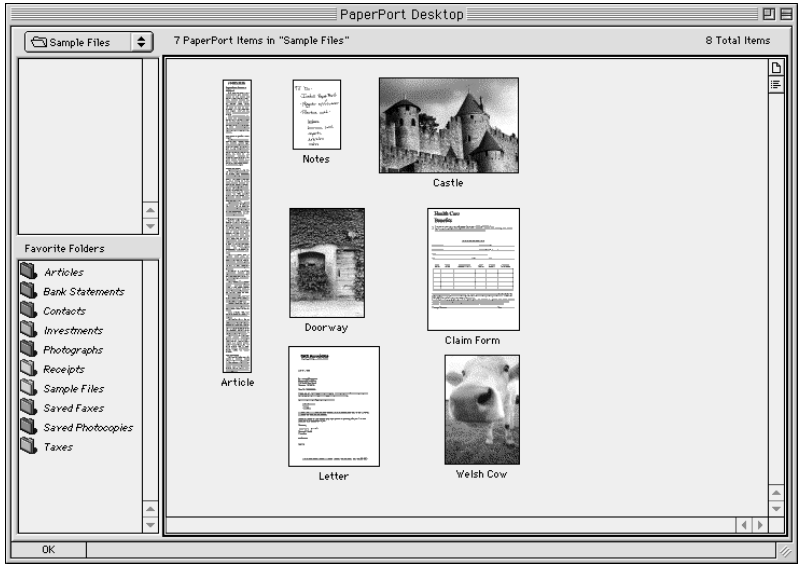

Accessing the Scanner

Run your PaperPort® software. You will see the **PaperPort® icon** in the upper right corner of your screen. The first time you use the Brother TWAIN driver, set it as the default by choosing *Select Source* and clicking the *PaperPort® icon*. Afterward, for each original you scan, choose *Acquire Image* by clicking the *PaperPort® icon*. The Scanner setup dialog box will appear.

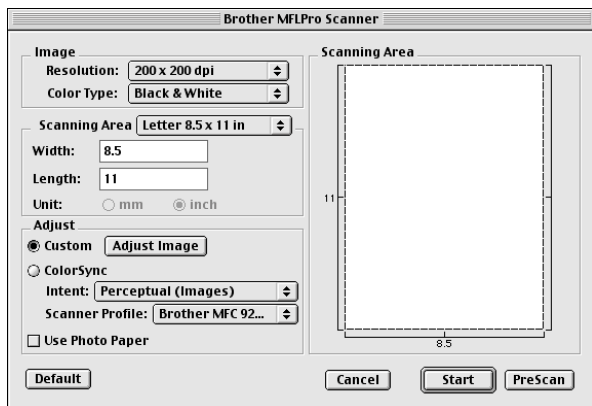

Scanning an Image into Your Macintosh G3, G4 or iMac

- 1 Place the original face up in the ADF, or face down on the scanner glass.
- 2 Adjust the following settings, if needed, in the Scanner setup dialog box:
 - Resolution*
 - Color Type*
 - Brightness*
 - Contrast*
 - Scanning Area*
- 3 Click **Start**.

When scanning is finished, the image will appear in your graphics application.

Settings in the Scanner Window

Image

Resolution

Choose the scanning resolution from the Resolution pop-up menu. Higher resolutions take more memory and transfer time, but can achieve a finer scanned image.

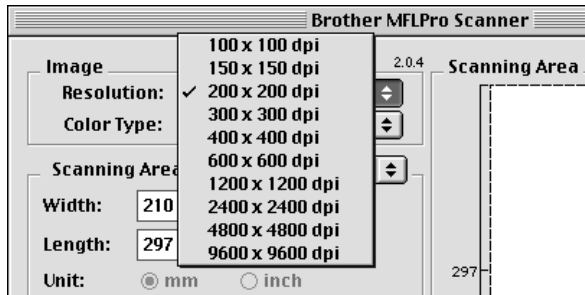

Color Type

Black & White—Set the image Type to Black&White for text or line art. For photographic images, set the image type to Gray (Error diffusion) or True Gray.

Gray (Error Diffusion)—is used for documents that contain photographic images or graphics. (Error Diffusion is a method for creating simulated gray images by placing black dots in a specific matrix instead of true gray dots.)

True Gray—also is used for documents containing photographic images or graphics. This mode is more exact because it uses up to 256 shades of gray. It requires the most memory and longest transfer time.

Colors—Choose either 256 Color, which scans up to 256 colors, 24-bit color which scans up to 16.8 million colors. Although using 24-bit color creates an image with the most accurate colors, the image file will be approximately three times larger than a file created with 256 Color.

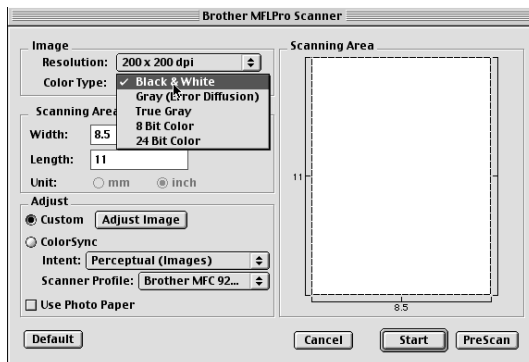

Scanning Area

Set the **Size** to one of the following:

- *Letter* (8.5 × 11 inches)
- *A4* (210 × 297 mm)
- *Legal* (8.5 × 14 inches)
- *A5* (148 × 210 mm)
- *B5* (182 × 257 mm)
- *Executive* (7.25 × 10.5 inches)
- *Business Card* (90 × 60 mm)
- *Custom* (User adjustable from 0.35 × 0.35 inches to 8.5 × 14 inches)

After you choose a custom size, you can adjust the scanning area. Click and hold the mouse button as you drag the mouse to crop the image.

Width: Enter the width of the custom size.

Length: Enter the length of the custom size.

Business Card Size

To scan business cards, select the Business Card size setting (90 × 60 mm), and then place the business card at the center of scanner glass.



Carrier sheets are available from your Dealer.

When scanning photographs or other images for use in a word processor or other graphics application, it is a good idea to try different settings for the Contrast, Mode and Resolution to determine which settings look best.

Adjust Image

Brightness

Adjust the Brightness settings to obtain the best image. The Brother TWAIN Scanner driver offers 100 Brightness settings (-50 to 50). The default value is 0, representing an “average” setting.

You can set the Brightness level by dragging the slider to the right to lighten the image or to the left to darken the image. You can also type a value in the box to set the setting. Click **OK**.

If the scanned image is too light, set a lower Brightness value and scan the document again.

If the image is too dark, set a higher Brightness value and scan the document again.

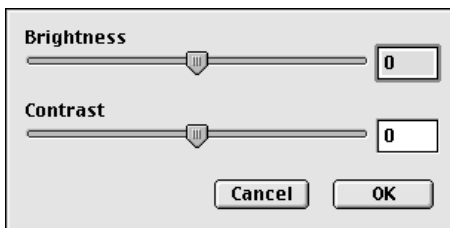

Contrast

The Contrast setting is adjustable only when you have selected one of the gray scale settings, but it is not available when Black & White is selected as the Gray Scale.

Increasing the Contrast level (by dragging the slider to the right) emphasizes dark and light areas of the image, while decreasing the Contrast level (by dragging the slider to the left) reveals more detail in gray areas. Instead of using the slider, you can type a value in the box to set the Contrast. Click **OK**.

PreScanning an Image

PreScanning allows you to scan an image quickly at a low resolution. A thumbnail version will appear in the Scanning Area. This is only a preview of the image, so you can see how it will look. The PreScan button is used to preview an image for any unwanted portions. When you are satisfied with the preview, click Start to scan the image.

- 1 Insert the original face up in the ADF, or face down on the scanner glass.
- 2 Click **PreScan**.
The entire original will be scanned into your Macintosh G3 or iMac and will appear in the Scanning Area of the Scanner dialog box:
- 3 To scan a portion of the prescanned image, click and drag the mouse to crop it.

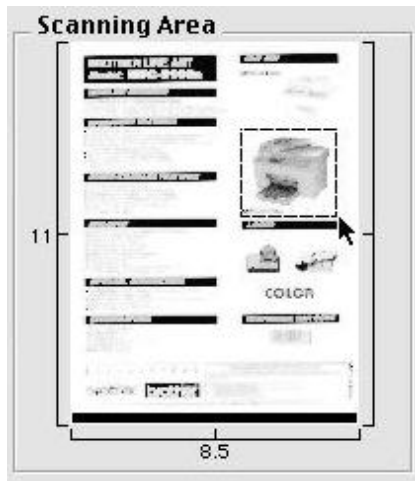

- 4 Insert the original face up in the ADF, if you use the ADF in Step 1.
- 5 Adjust the settings for Resolution, Color Type (Gray Scale), Brightness, Contrast, and Size in the Scanner Setup dialog box, as needed.
- 6 Click **Start**.
This time only the selected area of the original will appear in the Scanning Area.
- 7 Use your application, software for editing and refining the image.

12 Important Information

Standard FCC Notices

These notices are in effect on models sold and used in the United States only.

If you experience trouble with your DCP-1000, please contact a Brother Authorized Service Center for information on obtaining service or repair.

If you are not able to solve a problem with your DCP, contact Brother Customer Service. (See *Brother Numbers*, page i.)

WARNING

For protection against the risk of electrical shock, always disconnect all cables from the wall outlet before servicing, modifying or installing the equipment.

Brother cannot accept any financial or other responsibilities that may be the result of your use of this information, including direct, special or consequential damages. There are no warranties extended or granted by this document.

Laser Safety

This equipment is certified as a Class I laser product under the U.S. Department of Health and Human Services (DHHS) Radiation Performance Standard according to the Radiation Control for Health and Safety Act of 1968. This means that the equipment does not produce hazardous laser radiation.

Since radiation emitted inside the equipment is completely confined within protective housings and external covers, the laser beam cannot escape from the machine during any phase of user operation.

FDA Regulations

U.S. Food and Drug Administration (FDA) has implemented regulations for laser products manufactured on and after August 2, 1976. Compliance is mandatory for products marketed in the United States. One of the following labels on the back of the machine indicates compliance with the FDA regulations and must be attached to laser products marketed in the United States.

Manufactured

BROTHER CORP. (ASIA) LTD.

BROTHER BUJI NAN LING FACTORY

Gold Garden Industry, Nan Ling Village, Buji, Rong, Gang, Shenzhen, China.

This product complies with FDA radiation performance standards, 21 CFR Subchapter J.

WARNING

Use of controls, adjustments or performance of procedures other than those specified in this manual may result in hazardous invisible radiation exposure.

Caution

Changes or modifications not expressly approved by Brother Industries, Ltd. may void the user's authority to operate the equipment.

Federal Communications Commission (FCC) Declaration of Conformity (For USA Only)

Responsible Party:	Brother International Corporation 100 Somerset Corporate Boulevard Bridgewater, NJ 08807-0911 USA TEL: (908) 704-1700
--------------------	--------------------------------------------------------------------------------------------------------------------------------

declares, that the products

Product Name: DCP-1000

comply with Part 15 of the FCC Rules. Operation is subject to the following two conditions: (1) This device may not cause harmful interference, and (2) this device must accept any interference received, including interference that may cause undesired operation.

This equipment has been tested and found to comply with the limits for a Class B digital device, pursuant to Part 15 of the FCC Rules. These limits are designed to provide reasonable protection against harmful interference in a residential installation. This equipment generates, uses, and can radiate radio frequency energy and, if not installed and used in accordance with the instructions, may cause harmful interference to radio communications. However, there is no guarantee that interference will not occur in a particular installation. If this equipment does cause harmful interference to radio or television reception, which can be determined by turning the equipment off and on, the user is encouraged to try to correct the interference by one or more of the following measures:

- Reorient or relocate the receiving antenna.
- Increase the separation between the equipment and receiver.
- Connect the equipment into an outlet on a circuit different from that to which the receiver is connected.
- Consult the dealer or an experienced radio/TV technician for help.

Important

Changes or modifications not expressly approved by Brother Industries, Ltd. could void the user's authority to operate the equipment.

Industry Canada Compliance Statement

This Class B digital apparatus complies with Canadian ICES-003.

Cet appareil numérique de la classe B est conforme à la norme NMB-003 du Canada.

Important—About the Interface Cable

A shielded interface cable should be used in order to ensure compliance with the limits for a Class B digital device.

Warranty

You must use the IEEE-1284 shielded parallel cable provided by Brother Industries, Ltd. (See *Ordering Accessories and Supplies*, page ii)

International ENERGY STAR® Compliance Statement

AS an ENERGY STAR® Partner, Brother Industries, Ltd. has determined that product meets the ENERGY STAR® guidelines for energy efficiency.



Important Safety Instructions

- 1** Read all of these instructions.
- 2** Save them for later reference.
- 3** Follow all warnings and instructions marked on the product.
- 4** Unplug this product from the wall outlet before cleaning. Do not use liquid or aerosol cleaners. Use a damp cloth for cleaning.
- 5** Do not place this product on an unstable cart, stand, or table. The product may fall, causing serious damage to the product.
- 6** Slots and openings in the cabinet and the back or bottom are provided for ventilation; to ensure reliable operation of the product and to protect it from overheating, these openings must not be blocked or covered. The openings should never be blocked by placing the product on a bed, sofa, rug, or other similar surface. This product should never be placed near or over a radiator or heater. This product should never be placed in a built-in installation unless proper ventilation is provided.
- 7** This product should be operated from the type of power source indicated on the label. If you are not sure of the type of power available, consult your dealer or local power company.
- 8** This product is equipped with a 3-wire grounding type plug, a plug having a third (grounding) pin. This plug will fit into only a grounding-type power outlet. This is a safety feature. If you are unable to insert the plug into the outlet, contact your electrician to replace your obsolete outlet. Do not defeat the purpose of the grounding-type plug by using an adapter.
- 9** Do not allow anything to rest on the power cord. Do not place this product where people can walk on the cord.
- 10** If an extension cord is used with this product, make sure that the total ampere ratings on the products plugged into the extension cord do not exceed the extension cord ampere rating. Also, make sure that the total of all products plugged into the wall outlet does not exceed 15 amperes (USA only).
- 11** Never push objects of any kind into this product through cabinet slots, since they may touch dangerous voltage points or short out parts resulting in the risk of fire or electric shock. Never spill liquid of any kind on the product.
- 12** This product must be installed near a power outlet that is easily accessible. In case of emergencies, you must disconnect the power cord from the power outlet in order to shut off power completely.

- 13** Unplug this product from the wall outlet and refer servicing to Authorized Service Personnel under the following conditions:
- A When the power cord is damaged or frayed.
 - B If liquid has been spilled into the product.
 - C If the product has been exposed to rain or water.
 - D If the product does not operate normally when the operating instructions are followed. Adjust only those controls that are covered by the operating instructions. Improper adjustment of other controls may result in damage and will often require extensive work by a qualified technician to restore the product to normal operation.
 - E If the product has been dropped or the cabinet has been damaged.
 - F If the product exhibits a distinct change in performance, indicating a need for service.
- 14** Do not attempt to service this product yourself, as opening or removing covers may expose you to dangerous voltage points and/or other risks, and may void your warranty. Refer all servicing to Authorized Service Personnel. A list of Authorized Service Centers has been included for your convenience, or you may contact Customer Service for your nearest Brother Authorized Service Center. (See *Brother Numbers*, page i.)
- 15** To protect your product against power surges, we recommend the use of a power protection device (Surge Protector).
- 16** When using your DCP, basic safety precautions should always be followed to reduce the risk of fire, electric shock and injury to persons, including the following:
- Do not use this product near water (for example, near a bathtub, sink, swimming pool or in a wet basement).
 - Use only the power cord indicated in this manual.

Trademarks

The Brother logo is a registered trademark of Brother Industries, Ltd.

Brother is a registered trademark of Brother Industries, Ltd.

© Copyright 2000 Brother Industries, Ltd. All rights reserved.

Windows, Windows NT, Microsoft, MS-DOS, Excel and Word are registered trademarks of Microsoft in the U.S. and other countries.

NT is a trademark of Northern Telecom Limited.

Macintosh and Quick Draw are registered trademarks and iMac and iBook are trademarks of Apple Computer, Inc.

PaperPort and TextBridge are registered trademarks of ScanSoft, Inc.

Each company whose software title is mentioned in this manual has a Software License Agreement specific to its proprietary programs.

IBM, IBM PC and Proprinter are registered trademarks of International Business Machines Corporation.

Hammermill copyplus white is a registered trademark of International Paper.

All other brand and product names mentioned in this manual are registered trademarks of their respective companies.

13 Troubleshooting and Routine Maintenance

Troubleshooting

IMPORTANT

For technical and operational assistance, you must call the country where you purchased the machine. Calls must be made *from within* that country.

Error Messages

You may occasionally encounter a difficulty with your DCP. If this happens, your machine often identifies the problem and displays an error message. The list below explains the most common error messages. You can correct most problems yourself. If you need additional help, call the Brother fax-back system at

In USA: 1-800-521-2846

In Canada: 1-800-681-9838

1-514-685-5381 (**In Montreal**)

ERROR MESSAGE	CAUSE	ACTION
CHANGE DRUM SOON	The drum unit is near the end of its life.	Use the drum unit until you have a print quality problem, then replace the drum unit with a new one.
CHECK PAPER	The DCP is out of paper or paper is not properly loaded in the multi-purpose sheet feeder.	Refill the paper or remove the paper and load it again and then press Copy .
CHECK PAPER SIZE	Your Paper Size setting may not be set correctly for the paper you are using (see 5-5).	Change either paper in the multi-purpose sheet feeder or change paper size setting, and then press Copy .

ERROR MESSAGE	CAUSE	ACTION
COOLING DOWN WAIT FOR A WHILE	The temperature of the drum unit or toner cartridge is too hot. The machine will pause its current print job and go into cooling down mode. During the cooling down mode, you will hear the cooling fan running while the LCD shows COOLING DOWN and WAIT FOR A WHILE .	You must wait and allow the DCP to resume printing when it is ready.
COVER OPEN PLS CLOSE COVER	The scanner cover was not completely closed.	Open, then close the cover.
CHECK ORIGINAL	Originals were not inserted or fed properly or original was too long.	Do not pull out the jammed original until you see page 13-4.
DOC. COVER OPEN	The document cover is open.	Remove any paper from the ADF and close the document cover.
MACHINE ERROR XX	The DCP has a mechanical problem.	Turn off the power. Then call Brother Customer Service: In USA: 1-800-284-4329 In Canada: 1-800-853-6660 In Montreal: 1-514-685-6464
OUT OF MEMORY (May occur when the DCP is used as a printer.)	DCP memory capacity has been exceeded.	Turn off the power, and then turn it back on. Data remaining in the memory of the DCP will be deleted. <ul style="list-style-type: none">• If you have installed the Windows® driver, try again after setting the True Type mode to “Print as Graphics” in the PRINT menu of your application software.• Reduce the print resolution or reduce the complexity of your document.

ERROR MESSAGE	CAUSE	ACTION
PLS OPEN COVER	A page, piece of paper or paper clip, etc. may be jammed inside the DCP.	Open the scanner cover. If you see any jammed paper or other item, gently pull it out, then close the scanner cover. If the error message remains, open and close the scanner cover again. If the DCP cannot reset itself and return to the date and time prompt, it will display MACHINE ERROR XX . Please call Brother Customer Service and tell them the Machine Error number at: In USA: 1-800-284-4329 In Canada: 1-800-853-6660 In Montreal: 1-514-685-6464
PAPER JAM	The paper is jammed in the DCP.	Do not pull the paper out until you see pages 13-4 to 13-5.
CHECK DRUM UNIT	Drum unit is not installed.	Reinstall the drum unit.
TONER EMPTY	Toner is used up and printing is not possible, or the toner cartridge is not installed into the drum unit.	Replace the toner cartridge with a new one, or install the cartridge into the drum unit (See pages 13-15 to 13-19).
TONER LOW	If the LCD shows TONER LOW , you can still print. But the toner is depleted and the DCP is telling you that the toner will soon run out.	Order a new toner cartridge now.

Original Jams and Paper Jams

Based upon where the original or printed sheet is jammed, follow the appropriate set of instructions to remove it.

Original is Jammed in the Top of the ADF Unit

- 1 Remove any paper from the ADF that is not jammed.
- 2 Lift the ADF cover.
- 3 Pull the jammed original out to the right.
- 4 Close the ADF cover.
- 5 Press **Stop/Exit**.

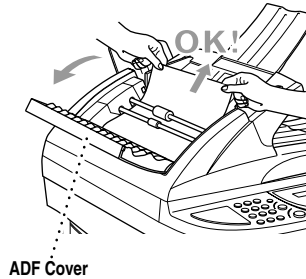

Original is Jammed Inside the ADF Unit

- 1 Remove any paper from the ADF that is not jammed.
- 2 Lift the document cover.
- 3 Pull the jammed original out to the right.
- 4 Press **Stop/Exit**.

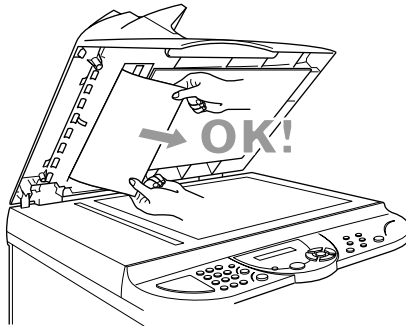

Paper Jam

Before you can clear a paper jam error, you must find out where the paper is stuck. Review the following two types of printer jams and follow the instructions.

WARNING

Do not force the jammed paper from the paper tray because you may damage the DCP and cause toner to scatter on the next printed pages.

After you have used the DCP, some internal parts of the machine are extremely **HOT!** When you open the scanner cover of the machine, never touch the internal parts shown in the following picture.

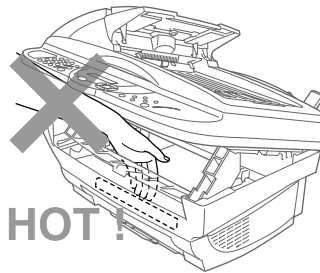

Paper is Jammed in the Multi-purpose Sheet Feeder

- 1 Push down the paper lever, and then pull the jammed paper upward and out of the feeder.
- 2 Open the scanner cover and check that a torn piece of paper does not remain inside the machine.

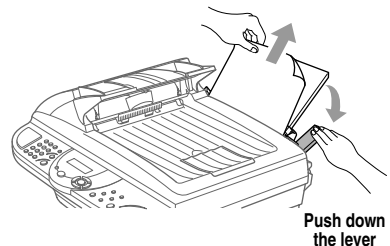

Paper is Jammed near the Drum Unit

- 1 Open the scanner cover.
- 2 Remove the drum unit.
- 3 Gently pull out the jammed paper.
- 4 Reinstall the drum unit.
- 5 Close the scanner cover.

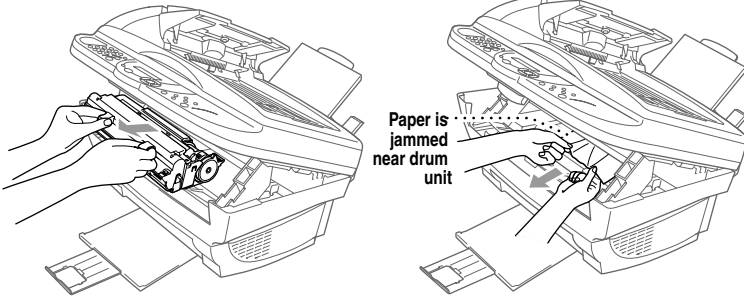







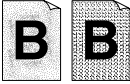

If You Are Having Difficulty with Your Machine

If you think there is a problem with your machine, *make a copy first*. If the copy looks good, the problem is probably not your machine. Check the table below and follow the troubleshooting tips.

DIFFICULTY	SUGGESTIONS
General Printing Difficulties	
The DCP does not print.	Check the following: <ul style="list-style-type: none"> • The DCP is turned on. • The toner cartridge and drum unit are installed properly. • The interface cable is securely connected between the DCP and computer. • Check to see if LCD is showing an error message. (See pages 13-1 to 13-3.)
The DCP prints unexpectedly or it prints garbage.	Reset the DCP. Check the primary settings in your application software to make sure it is set up to work with your DCP.
The DCP prints the first couple of pages correctly, then some pages have text missing.	Your computer is not recognizing the printer input buffer's full signal. Please make sure to connect the printer cable correctly.
The DCP cannot print full pages of a document; OUT OF MEMORY error message occurs.	Reduce the printer resolution. Reduce the complexity of your document and try again. Reduce the graphic quality or the number of font sizes within your application software.
My headers or footers appear when I view my document on the screen, but do not appear when I print them.	Most laser printers have a restricted area that will not accept print. Usually these are the first two lines and last two lines, leaves 62 printable lines. Adjust the top and bottom margins in your document to allow for this.
Software Difficulties	
MFC Connect Failure	If the DCP is not connected to your PC and you have loaded the Brother software, the PC will show "MFC Connect Failure" each time you restart Windows®. You can ignore this message or you can turn it off by deselecting the AutoLoad PopUp check box. (See <i>How to Turn Off AutoLoad</i> , page 8-2, in On-Line Documentation (Owner's Manual) on the CD-ROM.)

DIFFICULTY	SUGGESTIONS
Windows® Setup Printing Difficulties	
I cannot print from my application software.	Make sure the Windows® printer driver is installed and that you selected it in your application software.
Sometimes I get the error message OUT OF MEMORY when printing certain documents from Windows®.	If you are using the supplied Windows® driver, turn the error recover operation on in the Setup dialog box and try again. Reduce the print resolution or reduce the complexity of your document and try again.
The DCP does not load paper. The LCD shows CHECK PAPER or PAPER JAM .	Check to see if the CHECK PAPER or PAPER JAM message appears on the LCD. If so, the multi-purpose sheet feeder may be out of paper or not properly installed. If it is empty, load a new stack of paper into the feeder and then press Copy . If there is paper in the multi-purpose sheet feeder, make sure it is straight. If the paper is curled, you should straighten it. Sometimes it is helpful to remove the paper, turn the stack over and place it back into the multi-purpose sheet feeder. Reduce the amount of paper in the multi-purpose sheet feeder, and then try again.
How can I load envelopes?	You can load envelopes from the multi-purpose sheet feeder. Your application software must be set up to print the envelope size you are using. This is usually done in the Page Setup or Document Setup menu of your software. Refer to your application manual.
What paper can I use?	You can use plain paper, envelopes, organizer paper, transparencies and labels for <i>laser</i> machines. For information on paper you can use, (See <i>Acceptable Paper</i> on pages 2-7.)
How can I clear paper jams?	(See <i>Paper Jam</i> on pages 13-5 to 13-6.)
Copy Quality Difficulties	
Vertical streaks appear in copies.	Sometimes you may see vertical streaks on your copies. Either the scanner or the primary corona wire for printing is dirty. Clean them both. (See pages 13-13 to 13-15.)

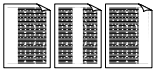
DIFFICULTY	SUGGESTIONS
Print Quality Difficulties	
Printouts are too dark or too light.	Adjust the print conditions by changing the Print Density setting. It has been factory set to the middle position. (See <i>Setting the Print Density</i> , page 4-2.)
Printed pages are curled.	Thin Paper (17lb-18.4lb) can cause this problem. Make sure you select the Paper Type that suits the paper in your multi-purpose sheet feeder. (See <i>Paper Type</i> , page 5-8 and 5-10 and <i>Media Type</i> , page 7-4.)
Printed pages are smeared.	Rough surfaces or thick media can cause “smeared pages”— OR —“the toner to smear”. Make sure you select the correct Paper Type that suits the paper in your multi-purpose sheet feeder. (See <i>Paper Type</i> , page 5-8 and 5-10 and <i>Media Type</i> , page 7-4.)
Printed pages contain white stripes.  White Stripes or Faint Images	You may fix this by wiping the scanner windows with a clean soft cloth. (See <i>Cleaning the Scanner</i> , page 13-13 and <i>Replacing the Drum Unit</i> , page 13-20.) If you still see white stripes or faint images and the LCD shows CHANGE DRUM SOON , replace the drum unit with a new one.
Printed pages are stained with toner or have vertical stripes.  Dark Stripes or Toner Stains	Clean the machine’s interior and the primary corona wire of the toner cartridge. (See <i>Routine Maintenance</i> , page 13-13 and <i>Cleaning the Drum Unit</i> , page 13-15.) Make sure that the tab of the corona wire is at the Home position (▼). If after cleaning, you still see dark stripes or toner stains and the LCD shows CHANGE DRUM SOON , replace the drum unit with a new one.
Printed pages have white in black text and graphic areas.  White Spots	Make sure that you use paper that meets the specifications. Rough surface or thick media can cause the problem. If you still see white spots and the LCD shows CHANGE DRUM SOON , replace the drum unit with a new one.
Toner scatters and stains the printed page.  Scattering Toner	Adjust the print conditions by changing the Print Density setting. Remove the drum unit and clean the DCP’s interior. (See <i>Routine Maintenance</i> , page 13-13, <i>Cleaning the Printer</i> , page 13-14 and <i>Cleaning the Drum Unit</i> , page 13-15.) Make sure that you use paper that meets specifications. (See page 2-7.) If you still have scattered toner and the LCD shows CHANGE DRUM SOON , replace the drum unit with a new one.

DIFFICULTY	SUGGESTIONS
Print Quality Difficulties (CONTINUED)	
<p>The whole page is printed black.</p>  <p style="text-align: center;">Black Page</p>	<p>Wipe the electric terminals referring to See page 13-14. Also, do not use heat-sensitive paper as it will cause this problem. After cleaning, if the printed pages are still black and the LCD shows CHANGE DRUM SOON, replace the drum unit with a new one.</p>
<p>Nothing is printed on the page.</p>  <p style="text-align: center;">White page</p>	<p>Make sure that the toner cartridge is not empty. Wipe the electric terminals. (See <i>Routine Maintenance</i>, page 13-13, <i>Cleaning the Printer</i>, page 13-14 and <i>Cleaning the Drum Unit</i>, page 13-15.) Make sure that a torn piece of paper does not remain on the scanner window.</p>
<p>Printed pages are marked at regular intervals.</p>  <p style="text-align: center;">Example of Regular Mark</p>	<p>Marks may disappear by themselves. Try copying multiple pages to clear this problem. Marks may occur if the machine has not been used for a long time. A possible cause is that the surface of the drum is scratched. You must then replace the drum unit with a new one. If the Marks do not disappear, it may be that the drum was marked or damaged by excessive exposure to light. In this case, replace the drum unit with a new one.</p>
<p>Printed pages are blurred at the center or at either edge.</p>  <p style="text-align: center;">Blurred Page</p>	<p>Certain environmental conditions such as humidity, high temperatures, etc. may cause this condition to occur. Make sure the machine is placed on a flat, horizontal surface. Remove the drum unit with the toner cartridge installed. Try rocking them from side to side. You may clear a blurred page by wiping the scanner windows with a clean soft cloth. (See <i>Routine Maintenance</i>, page 13-13, <i>Cleaning the Printer</i>, page 13-14 and <i>Cleaning the Drum Unit</i>, page 13-15.) If a blurred page occurs after cleaning and the LCD shows CHANGE DRUM SOON, replace the drum unit with a new one.</p>
<p>Ghost images appear on printed pages.</p>  <p style="text-align: center;">Ghost Images</p>	<p>Adjust the print conditions by changing the Print Density setting, page 4-2.—OR— Rough surfaces or thick media can cause a ghost image. Make sure you select the Paper Type that suits the paper in your multi-purpose sheet feeder. (See <i>Paper Type</i>, page 5-8 and 5-10 and <i>Media Type</i>, page 7-4.)</p>



The drum unit is a consumable item and it is necessary to replace it periodically.

Packing and Shipping the DCP

Whenever you transport the DCP, use the packing materials that came with your machine. If you do not pack the machine correctly, you could void your warranty.

- 1 Unplug the machine from the AC outlet.

WARNING

Do not unplug the DCP after a print job until you hear the final click.

- 2 Open the scanner cover.
- 3 Remove the drum unit.

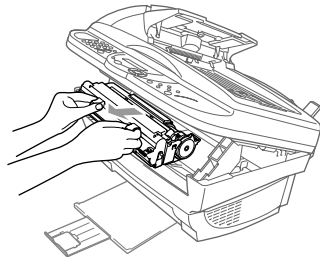

Caution

Remove the drum unit and toner cartridge assembly. Leave the toner cartridge installed in the drum unit.

- 4 Place the drum unit and toner cartridge assembly into the plastic bag and seal the bag completely.

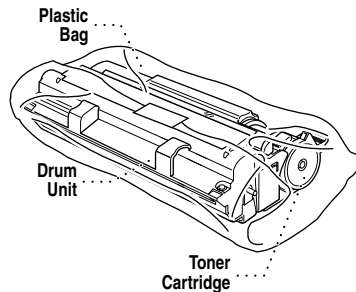

- 5 Close the scanner cover. Remove the paper support and close the paper tray and extension.

- 6 Wrap the machine in the plastic bag and place it in the original carton with the original packing material.

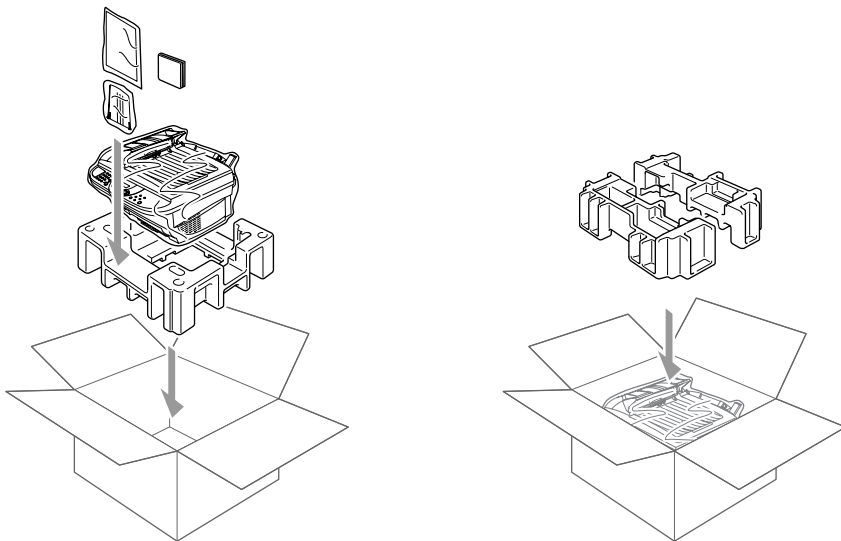

- 7 Pack the drum unit and toner cartridge assembly in the original carton as shown below:

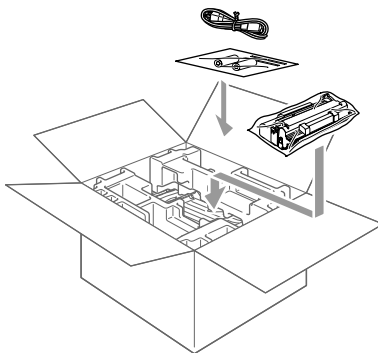

Note If you are returning the machine to Brother as part of the Exchange Service, pack *only* the machine. Keep all separate parts to use with your “Exchange” machine.

- 8 Close the carton and tape it shut.

Routine Maintenance

Cleaning the Scanner

Turn the machine power switch OFF and lift the document cover. Clean the scanner glass and the white film with isopropyl alcohol on a lint free cloth.

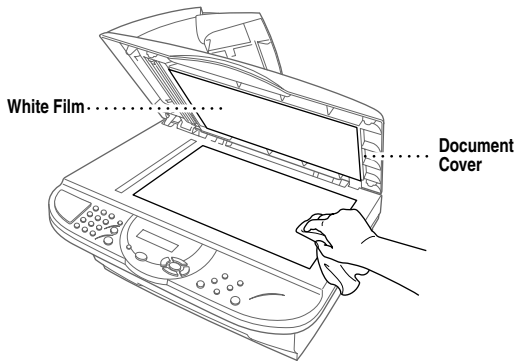

Lift the ADF unit. Clean the white bar and the glass strip with isopropyl alcohol on a lint-free cloth.

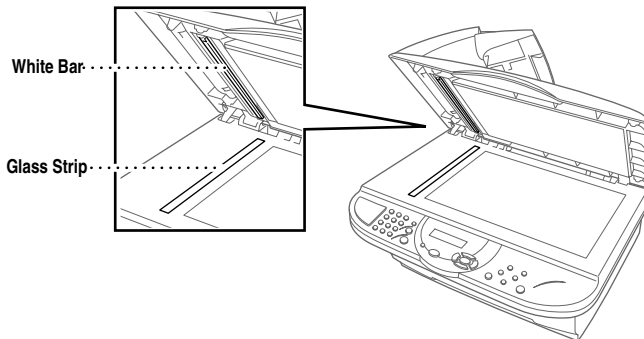

Cleaning the Printer

! Caution

- Do not use isopropyl alcohol to remove dirt from the control panel. It may cause a crack on the panel.
- Do not use isopropyl alcohol to clean the scanner window or the toner sensor.
- Do not touch the scanner window with your finger.
- Handle the drum unit carefully because it contains toner. If toner scatters and your hands or clothes get dirty, immediately wipe or wash it off with cold water.

- 1 Open the scanner cover.
- 2 Remove the drum unit assembly.

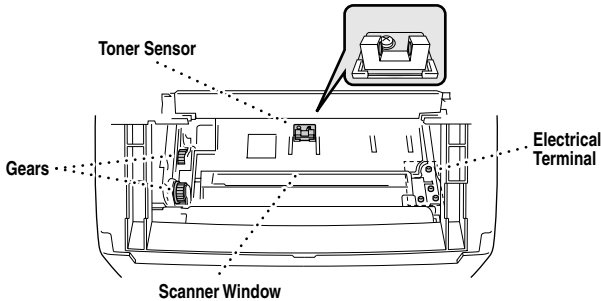

! WARNING

Just after you have used the DCP, some internal parts of the machine are extremely **HOT!** When you open the scanner cover, never touch the internal part shown in the following picture.

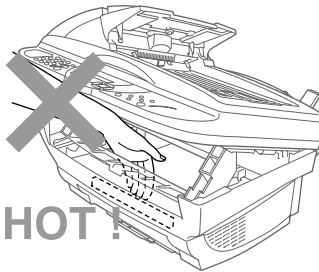

- 3 Wipe the electric terminals with isopropyl alcohol on a cotton swab.
- 4 Wipe the gears with a clean dry cloth.
- 5 Gently wipe the scanner window and the toner sensor with a clean soft dry cloth. Do NOT use isopropyl alcohol to clean the scanner window or the toner sensor.

Cleaning the Drum Unit

We recommend you place the drum unit on a drop cloth or large piece of disposable paper to avoid spilling and scattering toner.

- 1 Carefully turn the drum unit upside down.
- 2 Clean the primary corona wire inside the drum unit by gently sliding the tab from right to left several times.
- 3 Return the tab to the Home position (▼) before reinstalling the drum unit.

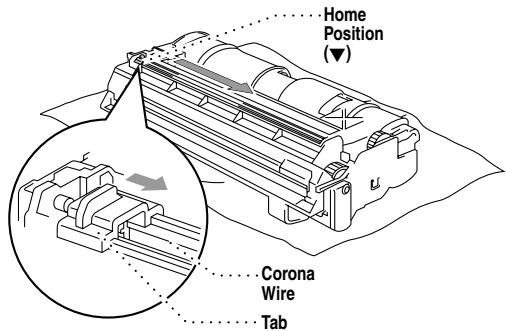

! Caution

If you do not position the tab at the Home position (▼), printed pages may have vertical stripes.

- 4 Re-install the drum unit into the DCP.
(See *Replacing the Drum Unit*, page 13-20.)
- 5 Close the scanner cover.

Replacing the Toner Cartridge

The DCP can print approximately 2,200 pages with one toner cartridge. When the toner cartridge is running low, the LCD shows **TONER LOW**. The machine is supplied with a *starter* toner cartridge that must be replaced after 1,000 pages. Actual page count will vary depending on your average document type (i.e. standard letter, detailed graphics).

It is a good idea to keep a new toner cartridge ready for use when you see the **TONER LOW** warning.

Discard the used toner cartridge according to local regulations. If you are not sure of them, call your local Sanitation Department. Be sure to seal the toner cartridge tightly so toner powder does not spill out of the cartridge. When discarding used toner cartridges, keep them separate from domestic garbage.



We recommend that you clean the DCP when you replace the toner cartridge.

Toner Empty Indicator

When the toner cartridge is running low, the LCD shows **TONER LOW** and the Toner Empty LED on the control panel flashes on and off to indicate the toner is low.

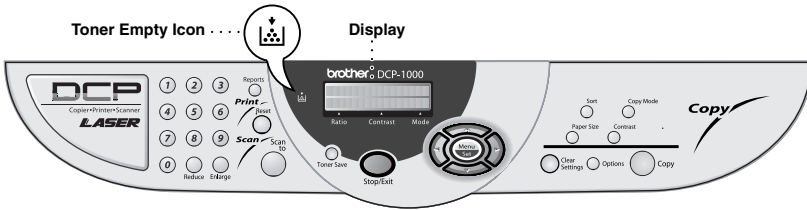

The Toner Empty LED light stays on and the LCD shows **TONER EMPTY** to indicate that the toner is empty. Once this indication appears, the DCP will not resume printing until you have installed a new toner cartridge.

WARNING

Just after you have used the DCP, some internal parts of the machine will be extremely **HOT!** So, please be careful.

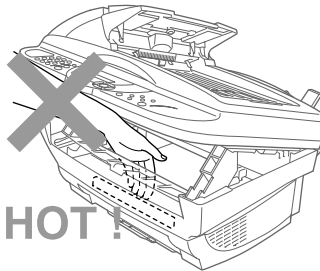

- 1 Turn off the power switch.
- 2 Open the scanner cover by pulling the lever toward you and lifting the cover. Make sure the scanner cover is completely open.
- 3 Remove the drum unit by holding each side of the drum by its handles and gently lifting the drum forward toward you.

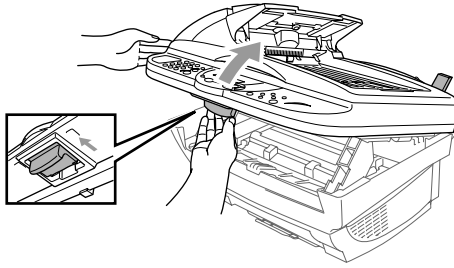

Note Place the drum unit on a drop cloth or large piece of disposable paper to avoid spilling and scattering the toner.

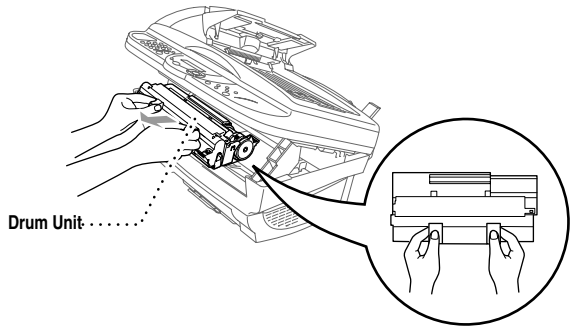

- 4 Gently turn the lever on the toner cartridge counterclockwise until it stops. The used toner cartridge cannot be removed unless the shutter is closed by turning the lever completely to the front.

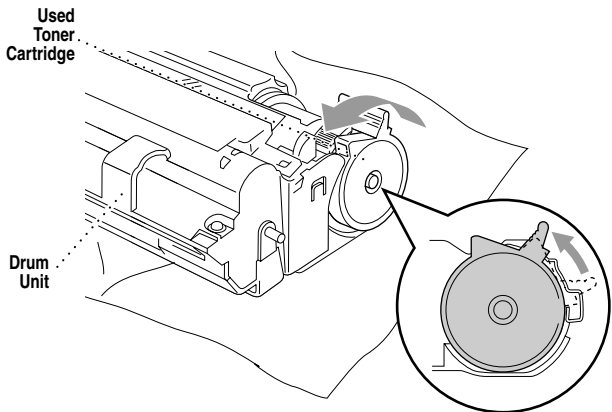

- 5 Remove the used toner cartridge from the drum unit by gently pulling it out.

Note Handle the toner cartridge carefully. If toner scatters on your hands or clothes, immediately wipe it off or wash it with cold water.

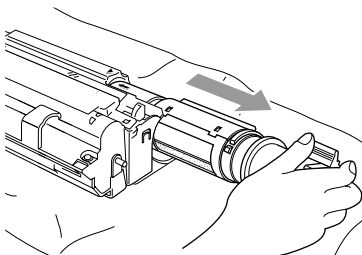

- 6 Unpack the new toner cartridge. Place the used toner cartridge into the aluminum bag and discard it according to local regulations.

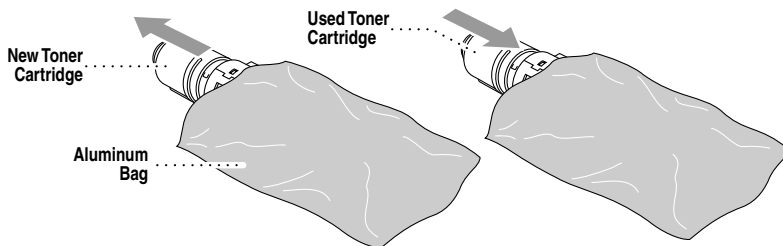

! Caution

- Wait to unpack the new toner cartridge until immediately before you install it in the DCP. If a toner cartridge is left unpacked for a long period of time, the toner life is shortened.
- You can use only a genuine Brother toner cartridge (TN-250 series), which is specially formulated to ensure top print quality. Using another brand of toner cartridge may void your DCP's warranty.

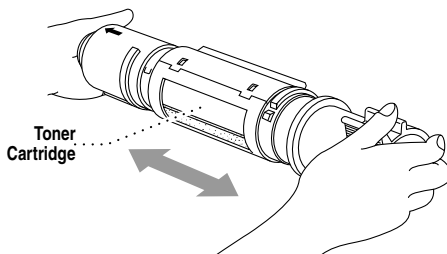

! **Warranty coverage does not apply to problems caused by the use of 3rd party Toner, 3rd party Toner Cartridge or 3rd party Drum unit.**

- 7 Gently rock the new toner cartridge from side to side five or six times, and then remove the protective seal.

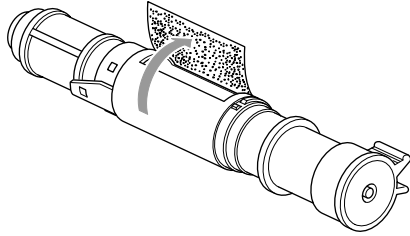

- 8 Slide the new toner cartridge into the opening on the right side of the drum unit.

To ensure that the toner cartridge and the drum unit fit together correctly, make sure that the toner cartridge guide arrow is exactly aligned with the guide arrow on the drum unit.

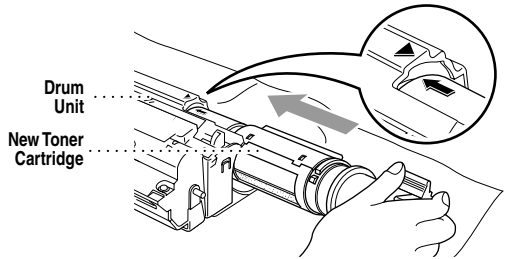

- 9 Gently turn the lever on the toner cartridge clockwise until it stops.

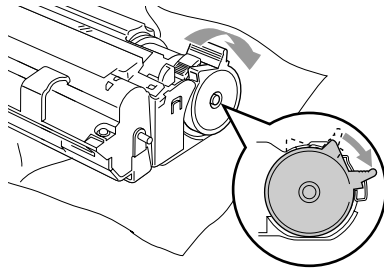

- 10 Reinstall the drum unit in the DCP and close the scanner cover.

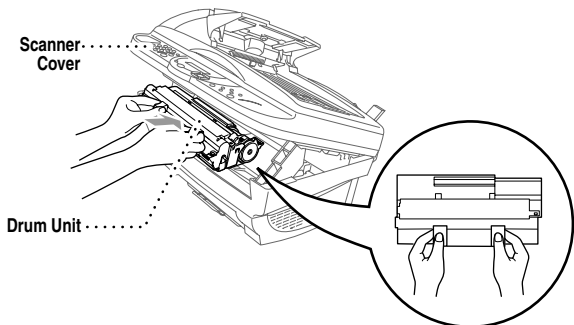

Replacing the Drum Unit

The DCP uses a drum unit to create the print images on paper. If the LCD shows **CHANGE DRUM SOON**, the drum unit is near the end of its life. Purchase a new drum unit to replace the current one.

Even if the LCD shows **CHANGE DRUM SOON**, you may be able to continue to print without replacing the drum unit for a while. However, if there is a noticeable deterioration in the output print quality even before **CHANGE DRUM SOON** is shown, then the drum unit should be replaced. You should clean the printer when you replace the drum unit.

! Caution

- When removing the drum unit, handle it carefully because it contains toner. When you replace the drum unit, you should clean the machine.
- Wait to unpack the drum unit until immediately before installing it into the machine. If an unpacked drum unit is subjected to excessive direct sunlight or room light, the unit may be damaged.
- Handle the toner cartridge and the drum unit carefully because they contain toner. If toner scatters and your hands or clothes get dirty, immediately wipe or wash with cold water.



The drum unit is a consumable item, and it is necessary to replace it periodically. There are many factors that determine the actual drum life, such as temperature, humidity, type of paper and toner that you use and the number of pages per print job, etc. The drum life is estimated at approximately 20,000 pages at 20 pages per job and 8,000 pages at 1 page per job. The actual number of pages your drum will print may be significantly less than these estimates. Because we have no control over the many factors that determine the actual drum life, we cannot guarantee a minimum number of pages that will be printed by your drum.

For best performance, use only a genuine Brother toner cartridge. The product should be used only in a clean, dust-free environment with adequate ventilation.

! WARNING

Just after you have used the DCP, some internal parts of the machine are extremely **HOT!** So please be careful.

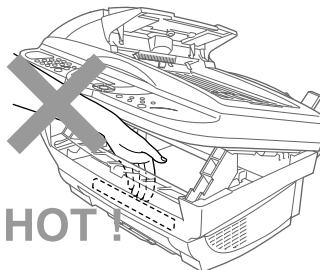

Follow these steps to replace the drum unit:

- 1 Open the scanner cover.
- 2 Remove the used drum unit. Place the drum unit on a drop cloth or large piece of disposable paper to avoid spilling and scattering the toner.

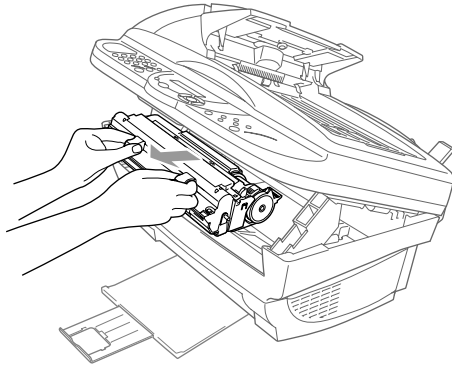

- 3 Remove the toner cartridge from the used drum unit and keep it in a safe place. For more information, see *Replacing the Toner Cartridge*, page 13-15.

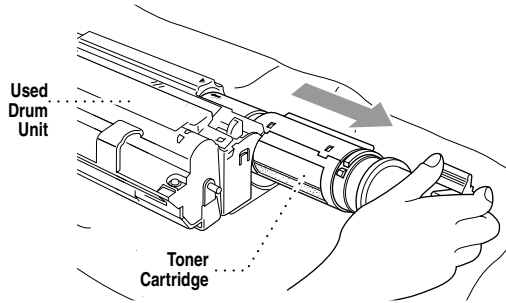

- 4 Place the used drum into the aluminum bag and discard it according to local regulations.

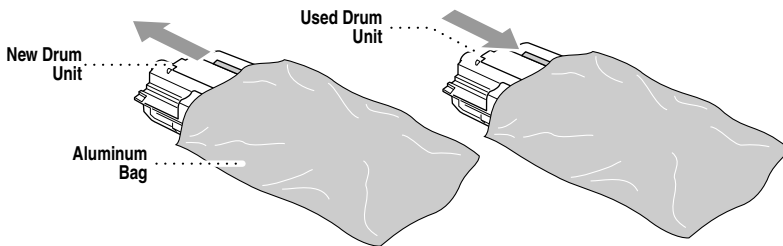

Note Discard the used drum unit according to local regulations. If you are not sure of them, call your local Sanitation Department. Be sure to seal the drum unit tightly so toner powder does not spill out of the unit. When discarding used drums, keep them separate from domestic garbage.

Caution

Do NOT remove the clear plastic starter sheet!

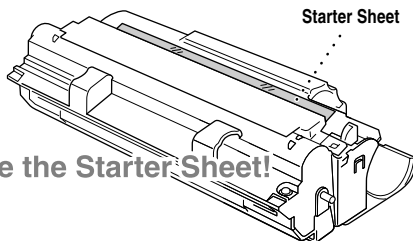

- 5 Reinstall the toner cartridge into the new drum unit. For more information, see *Replacing the Toner Cartridge*, page 13-15.

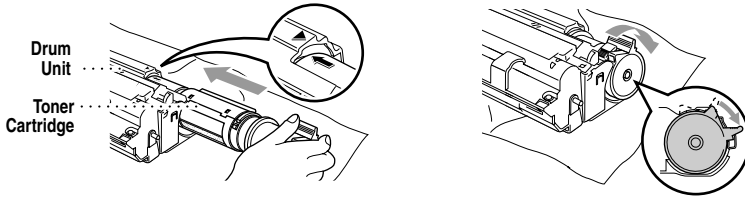

- 6 Holding the new drum unit by its handles, install it. Close the scanner cover.
- 7 The DCP will eject the clear plastic starter sheet automatically.

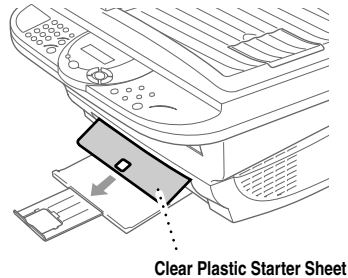

Caution

- Do not touch the scanner window with your finger.
- Handle the toner cartridge and drum unit carefully because they contain toner. If toner scatters and your hands or clothes get dirty, immediately wipe or wash it off with cold water.

Glossary

- ADF (Automatic Document Feeder)** Refers to the number of pages that can be placed in the document feeder and fed one at a time automatically.
- Automatic E-Mail Printing** Software application that automatically prints incoming E-mail messages on the machine (Instructions are on the CD-ROM).
- beeper volume** Volume setting for the beep when you press a key or make an error.
- Brother Resource Manager** The Brother Resource Manager application must be running for you to use your DCP with your Windows® computer. Multi-Function Link® Pro Suite software and the MFL Pro Suite Printer Driver automatically load the Resource Manager, as needed. The Resource Manager allows the single bi-directional Parallel port on the machine to simulate a Communications port for scanning and to simulate a Parallel port for Windows® GDI printing.
- Contrast** A setting that compensates for dark or light originals, by lightening dark documents or darkening light documents.
- drum unit** A printing device for your fax machine.
- gray scale** The shades of gray available for copying photographs.
- LCD (liquid crystal display)** The display screen on the machine that shows interactive messages during On-Screen Programming.
- Menu mode** The programming mode for changing the settings of your machine.
- Multi-Function Link® Pro Suite Software application** Turns your machine into a printer and a scanner.
- Photo mode** A resolution setting that uses varying shades of gray for the best representation of photographs.
- printer alarm** Audible alarm when the printer is not able to print.
- scanning** The process of sending an electronic image of an original paper document into your computer.
- ScanSoft™ PaperPort® LE for Brother** A document management application that enables you to view scanned documents.
- temporary settings** You can select certain options for each copy without changing the default settings. Temporary copy settings remain for 45 seconds after copying so you won't have to set them again for additional copies.
- toner cartridge** An accessory that holds toner for the drum unit on Brother laser models.
- Toner Save** A process that causes less toner to be affixed to the page to extend the life of the toner cartridge. This will make the print on received documents significantly lighter.
- User Settings** A printed report that shows the current settings of your machine.

Specifications

Product Description

Three performance modes are available for the 3 in 1 model DCP-1000: Printer, Copier and Scanner.

Scanner

Document Size	ADF Width: 5.8" to 8.5" (148 mm to 216 mm) ADF Length: 5.8" to 14.0" (148 mm to 356 mm) Scanner Width: Max. 8.5" (216 mm) Scanner Length: Max. 11.7" (297 mm)
Resolution	Up to 9,600 × 9,600 (interpolated) Up to 600 × 2,400 (optical)
Scanning/Printing Width	8.2 inches (208 mm)
Automatic Document Feeder (ADF)	Up to 30 sheets (20 lbs)

Printer

Printer Driver	Windows® 95/98/98SE/Me/2000 Professional and Windows NT® Workstation Version 4.0 driver supporting Brother Native Compression mode and bi-directional capability Apple® Macintosh® QuickDraw® Driver for OS 8.5/8.5.1/8.6/9.0/9.0.4/9.1
Interface	Bi-directional parallel (IEEE 1284); USB (Universal Serial Bus) Interface
Memory Capacity	8 MB
Print Method	Electrophotography by semiconductor laser beam scanning
Resolution	600 dots/inch
Print Quality	Normal printing mode Economy printing mode
Print Speed	Up to 10 pages/minute (when loading letter size or A4 paper from multi-purpose sheet feeder)
Multi-purpose Paper Cassette	200 sheets (20 lbs)

Consumable Items

Toner cartridge Life Expectancy:

Up to 2,200 pages/*new* toner cartridges

Up to 1,000 pages/*starter* toner cartridges

(USA, Canada and some other areas only)

(when printing letter size or A4 paper at 5% print coverage)



Toner life expectancy will vary depending upon the type of average print job.

Drum Unit Life Expectancy:

Up to 20,000 pages (continuous printing)

Up to 8,000 pages at 1 page per job



There are many factors that determine the actual drum life (such as a temperature, humidity, type of paper, toner you use and number of pages per print job).

**True Type Fonts
on CD-ROM**

TrueType compatible soft-fonts for Windows®
on the on bundled CD-ROM

Specifications and printed materials are subject to change without prior notice.

Computer Requirements

For Windows®			
Operating System	CPU (Pentium)	RAM	Hard Disk Space
95, 98, 98SE	75MHz	24MB (32MB recommended)	50MB
NT Workstation4.0	75MHz	32MB (64MB recommended)	
2000 Professional	133MHz	64MB (128MB recommended)	
Me	150MHz	32MB (64MB recommended)	

For Macintosh®			
Operating System	CPU (Pentium)	RAM	Hard Disk Space
Apple® Macintosh® QuickDraw® G3, G4, iMac or iBook with OS8.5, 8.5.1 (Only Printer) OS8.6/9.0/9.0.4/9.1 (Printer & Scanner)	All base models meet minimum requirements.		50MB

Electrical and Environment

Temperature	Operating 50 - 90.5° F (10 - 32.5° C) Storage 32 - 104° F (0 - 40° C)
Warm-Up	Approx. 12 seconds at 73.4° F (23° C)
First Print	15 seconds (using Letter size paper in multi-purpose sheet feeder)
Power Source	120V AC 50/60Hz (USA, Canadian Version Only)
Power Consumption	Average Operating (Copying) 260 W (25° C) Peak: 940 W Sleep Mode: 15 W or less Stand by: 75 W or less (25° C)
Noise	Operating: 52 dB A or less Stand by: 39 dB A or less
Humidity	Operating: 20 to 80% (without condensation) Storage: 10 to 90% (without condensation)
Dimensions	18.1 × 18 × 13.9 inches/(459 × 458 × 354 mm)
Weight	26.4 lbs/(11 kg) (Without Carton)

Parallel Interface

Interface Connector Printer Side: Amphenol FCN-685J036-L/X or equivalent
 A shielded cable should be used.

Pin Assignment

Pin No.	Signal	Direction	Pin No.	Signal	Direction
1	DATA STROBE	Input	19	0V(S.G.)	-
2	DATA 1	Input	20	0V(S.G.)	-
3	DATA 2	Input	21	0V(S.G.)	-
4	DATA 3	Input	22	0V(S.G.)	-
5	DATA 4	Input	23	0V(S.G.)	-
6	DATA 5	Input	24	0V(S.G.)	-
7	DATA 6	Input	25	0V(S.G.)	-
8	DATA 7	Input	26	0V(S.G.)	-
9	DATA 8	Input	27	0V(S.G.)	-
10	<u>ACKNLG</u>	Output	28	0V(S.G.)	-
11	BUSY	Output	29	0V(S.G.)	-
12	PE	Output	30	0V(S.G.)	-
13	SLCT	Output	31	<u>INPUT PRIME</u>	Input
14	<u>AUTO FEED</u>	Input	32	<u>FAULT</u>	Output
15	N.C.	-	33	N.C.	-
16	0V (S.G.)	-	34	N.C.	-
17	0V (S.G.)	-	35	N.C.	-
18	+5V	-	36	<u>SLCT IN</u>	Input

USB (Universal Serial Bus) Interface

Pin Assignment

Pin No.	Signal	
1	Vol (+5V)	
2	- Data	Serial Data -
3	+ Data	Serial Data +
4	Ground	

Index

A

- accessories and supplies ii
- ADF (Automatic Document Feeder) 1-4
- assembly and connection
 - drum unit assembly 2-3
 - grounded 3-prong plug 2-5
 - loading paper 2-7
 - power cord 2-5
 - toner cartridge 2-3
- Automatic E-mail Printing 10-1

B

- bi-directional parallel cable 2-1
- brightness 1-2
- Brother
 - accessories and supplies ii
 - Customer Service i
 - fax-back system i
 - frequently asked questions (FAQs) i
 - product support i
 - warranties iii to vi
- Brother Control Center
 - using and configuring 8-1 to 8-7

C

- cleaning
 - drum unit 13-15
 - printer 13-14
 - scanner 13-13
- control panel 1-2
- copying
 - contrast 5-10
 - default setting 5-9
 - enlarging 5-4
 - multiple 5-2
 - photographs 5-5, 5-9
 - quality 13-8
 - reducing 5-4
 - resolution 1-2
 - scannable area 5-1
 - single 5-1
 - temporary settings 5-3
 - using ADF 1-4, 5-1

- using scanner glass 1-5, 5-2
- Customer Service i

D

- drivers
 - Macintosh® 11-1
 - Windows® 6-1, 7-1
- drum unit
 - cleaning 13-15
 - installing 2-3
 - replacing 13-20

E

- envelopes 2-7
- error messages on LCD 13-1
 - CHECK PAPER 13-1
 - OUT OF MEMORY 13-2

H

- Help List 1-2, 4-3

I

- iMac 11-1

L

- LCD (Liquid Crystal Display) 3-1

M

- Macintosh® G3, G4 or iMac™ 11-1
- maintenance, routine 13-13
- multi-purpose sheet feeder capacity 2-8

O

- OCR (ScanSoft™TextBridge®) 9-1
- Options key 5-6

P

- packing list 2-1
- paper
 - jams 13-5
 - loading 2-7
 - size 2-7, 2-8
 - specifications 2-7, 2-8
 - type 1-2
- PaperPort® for Brother
 - exporting an image file 9-4
 - prescanning an image 9-7
 - scanning into PC
 - accessing 9-4
 - settings 9-5
 - uninstall 9-1
 - viewing faxes and files 9-2
- power cord 2-5
- printing 6-1
 - density 4-2
 - difficulties 13-7, 13-9, 13-10
 - general printing 13-7
 - E-mail 10-1
 - envelopes 6-2
 - jams
 - original 13-4
 - paper 13-5
 - PC software settings 6-1
 - quality 13-9, 13-13
 - Reset key 6-4
 - resolution S-1
 - specifications S-1
 - speed S-1
 - two-sided 6-2
- programming your DCP 3-1

R

- Redial/Pause 1-2
- reducing copies 5-4
- reports 4-3
- resolution
 - printing S-1
 - scanning 9-5

S

- safety instructions 12-4

- scanning
 - Macintosh® 11-4
 - Windows® 8-1, 9-4
- shipping the DCP 13-11
- Sleep mode 4-2
- software
 - Automatic E-mail Printing 10-1
 - Brother Control Center 8-1
 - ScanSoft™ PaperPort® and TextBridge® OCR 9-1
- Speed Dial 1-2

T

- TextBridge® OCR 9-1
- toner cartridge
 - installing 2-3
 - replacing 13-15
- toner save 4-1
- transparencies 2-7
- troubleshooting 13-1
 - error messages on LCD 13-1
 - if you are having difficulty 13-7
 - copy quality 13-8
 - general printing 13-7
 - print quality 13-9
 - printer difficulties 13-7
 - Windows® setup 13-8
- jams
 - original 13-4
 - paper 13-5
 - machine 13-1

V

- Volume, beeper 4-1

W

- warranties
 - Canada vi
 - disclaimer iii
 - USA iv
 - World Wide Web i

brother®

Brother International Corporation
100 Somerset Corporate Boulevard
P.O. Box 6911
Bridgewater, NJ 08807-0911 USA

Brother International Corporation (Canada) Ltd.
1 rue Hôtel de Ville,
Dollard-des-Ormeaux, QC, CANADA H9B 3H6

**Visit us on the World Wide Web
<http://www.brother.com>**

These machines are made for use in the USA and CANADA only. We cannot recommend using them overseas because the power requirements of your Digital Copier/Printer may not be compatible with the power available in foreign countries. **Using USA or CANADA models overseas is at your own risk and will void your warranty.**