

Before you can use the machine, read this Quick Setup Guide for the correct setup and installation.  
To view the Quick Setup Guide in other languages, please visit <http://solutions.brother.com/>.

## ! IMPORTANT

**DO NOT connect the interface cable yet.**



# 1

## Unpack the machine and check the components

		 Drum Unit Assembly (including Standard Toner Cartridge)	 Quick Setup Guide
 User's Guide	 CD-ROMS (Windows®) (Macintosh®)	 Telephone Line Cord Adapter (Australia only)	 Telephone Line Cord
 Australia and New Zealand	 Hong Kong, Malaysia and Singapore	 Philippines and Thailand	 AC Power Cord
The mains plug supplied with this machine is a grounded three pin plug.		The mains plug supplied with this machine is a side grounded two pin plug.	
Make sure that the AC socket will accept the supplied grounded pin plug. This machine must be grounded, If in doubt, call a qualified electrician.			

## ! WARNING

Plastic bags are used in the packaging of your machine. To avoid danger of suffocation, please keep these bags away from babies and children.

 **Note**

- The components included in the box may differ depending on your country.
- Save all packing materials and the box in case for any reason you must ship your machine.
- The interface cable is not a standard accessory. Buy the appropriate interface cable for the interface you want to use (USB, Parallel or Network).
- To ensure safe operation the supplied plug must be inserted only into a standard power outlet that is properly grounded through the standard electrical wiring. Non grounded equipment may cause an electrical shock hazard, and may cause excessive electrical noise radiation.

**USB cable**

- Please make sure you use a USB 2.0 cable (Type A/B) that is no longer than 2 metres.
- DO NOT connect the interface cable at this time. Connecting the interface cable is done during MFL-Pro installation process.
- When you use a USB cable, make sure you connect it to the USB port of your computer and not to a USB port on a keyboard or non-powered USB hub.







**Parallel cable**

DO NOT use a parallel interface cable that is longer than 2 metres. Use a shielded interface cable that is IEEE 1284-compliant.

**Network cable**

Use a straight-through Category5 (or greater) twisted-pair cable for 10BASE-T or 100BASE-TX Fast Ethernet Network.

**Symbols used in this guide**

 <b>WARNING</b>	WARNINGS tell you what to do to prevent possible personal injury.
 <b>CAUTION</b>	CAUTIONS specify procedures you must follow or avoid to prevent possible minor injuries.
 <b>IMPORTANT</b>	IMPORTANT describe procedures you must follow or avoid to prevent possible machine problems or machine damage, or damage to other objects.
	Electrical Hazard icons alert you to a possible electrical shock.
	Hot Surface icons warn you not to touch machine parts that are hot.
 <b>Note</b>	Notes tell you how you should respond to a situation that may arise or give tips about how the current operation works with other features.
 <b>User's Guide</b> <b>Software User's Guide</b> <b>Network User's Guide</b>	Indicates reference to the User's Guide, Software User's Guide or Network User's Guide.

## **⚠ CAUTION**

When you move the machine, grasp the side handholds that are under the scanner. **DO NOT** carry the machine by holding it at the bottom.

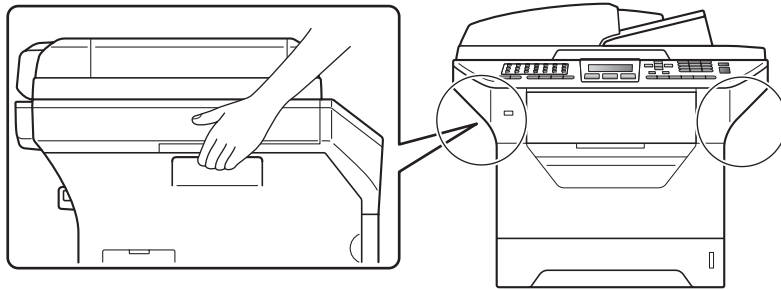

## **📝 Note**

Keep a minimum gap around the machine as shown in the illustration.

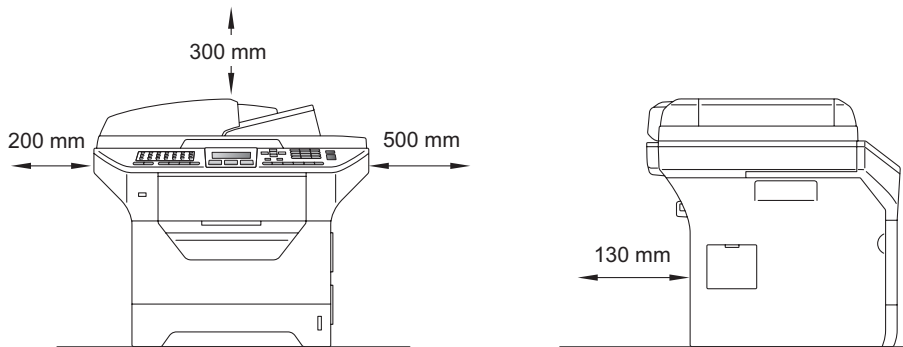

## 2 Install the drum unit and toner cartridge assembly

### ! IMPORTANT

DO NOT connect the interface cable yet.



**a** Remove the protective tape and film covering the scanner glass.

**b** Press the front cover release button and open the front cover ①.

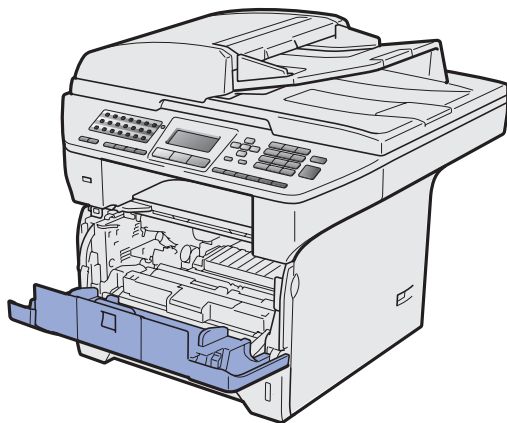
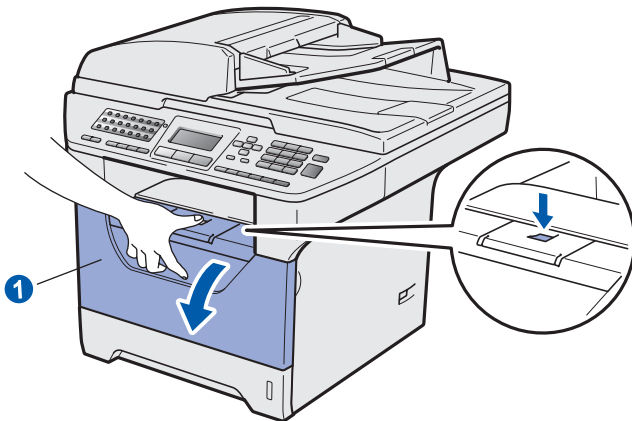

**c** Unpack the drum unit and toner cartridge assembly.

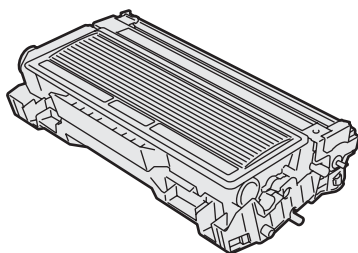

**d** Gently shake it from side to side several times to distribute the toner evenly inside the assembly.

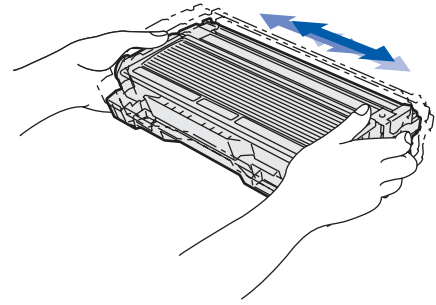

**e** Put the drum unit assembly into the machine until it clicks into place.

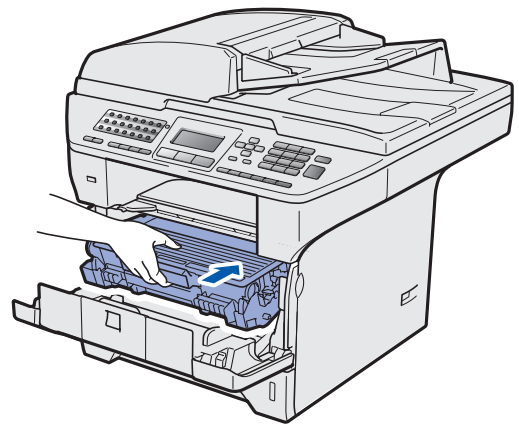

**f** Close the front cover of the machine.

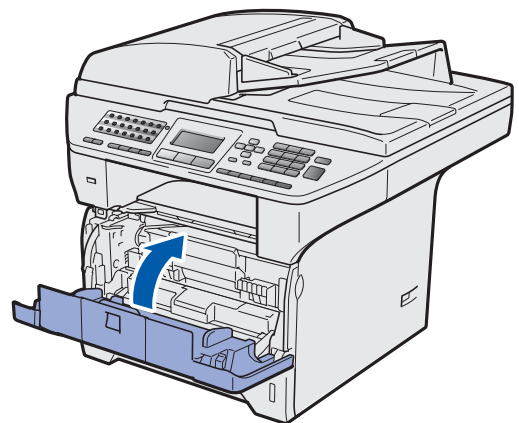

### 3 Load paper in the paper tray

- a** Pull the paper tray completely out of the machine.

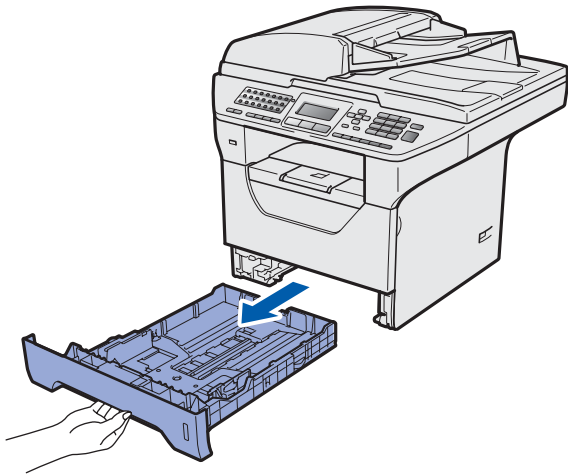

- b** While pressing the blue paper-guide release lever ①, slide the paper guides to fit the paper size you are loading in the tray. Make sure that the guides are firmly in the slots.

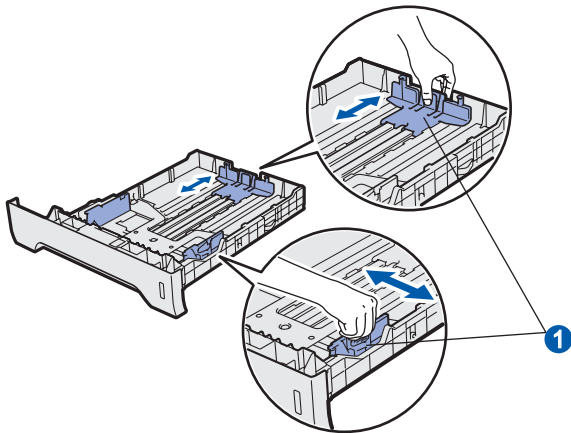

#### Note

For Legal or Folio size paper, press the release button ① in the bottom of the paper tray and then pull out the back of the paper tray. (Legal or Folio size paper are not available in some regions.)

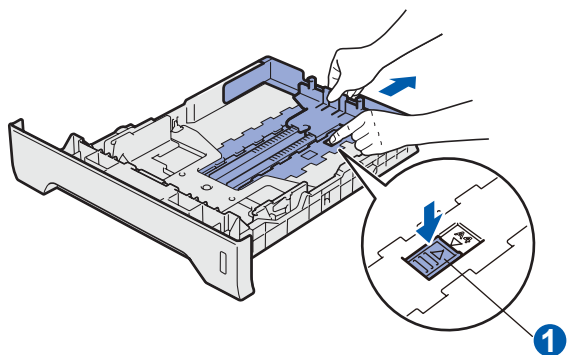

- c** Fan the stack of paper well to avoid paper jams and misfeeds.

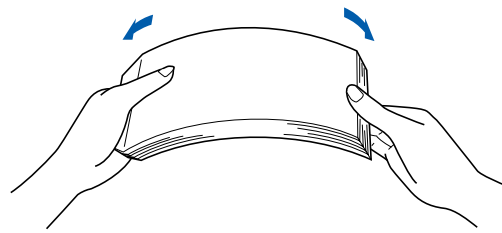

- d** Put paper in the tray, and make sure that the paper is below the maximum paper mark ①. The side to be printed on must be face down.

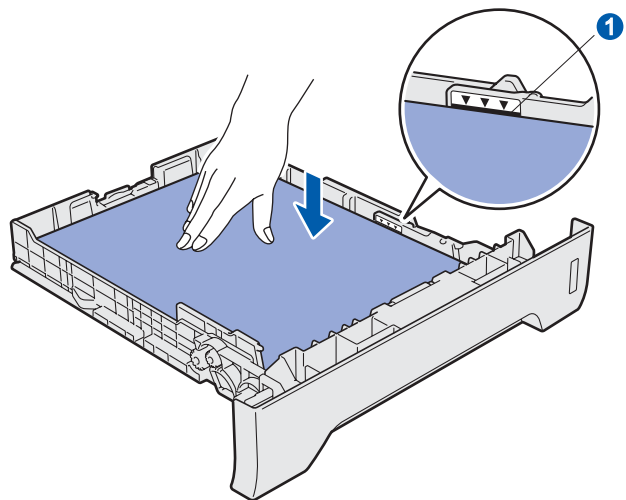

#### ! IMPORTANT

Make sure the paper guides touch the sides of the paper so it will feed correctly.

- e** Put the paper tray firmly back in the machine. Make sure that it is completely inserted into the machine.
- f** Unfold the support flap ① to prevent paper from sliding off the face-down output tray.

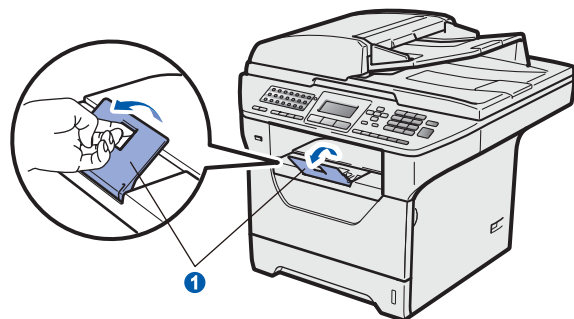

## 4 Release the scanner lock

Push the lever ① in the direction shown to unlock the scanner.

(The grey scanner lock lever is located at the back left side, under the document cover ②.)

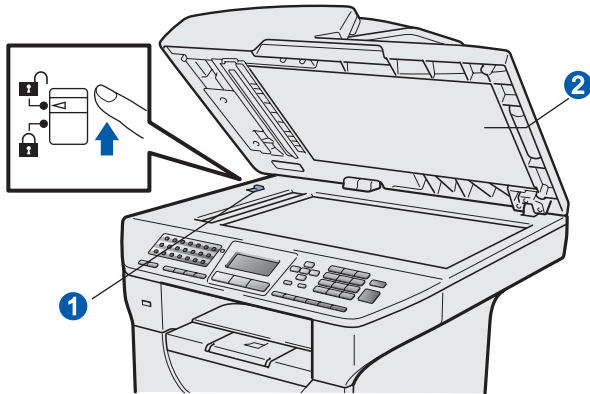

## 5 Connect the power cord and telephone line

### ! IMPORTANT

DO NOT connect the interface cable yet.

- a** Make sure that the machine power switch is off. Connect the AC power cord to the machine.

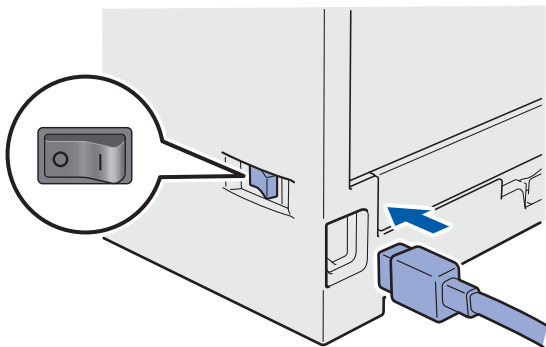

- b** Plug the AC power cord into an AC outlet. Turn the power switch on.

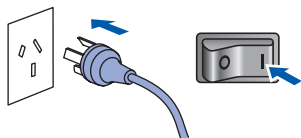

- c** Connect the telephone line cord. Connect one end of the telephone line cord to the socket on the machine marked **LINE** and the other end to a modular wall socket.

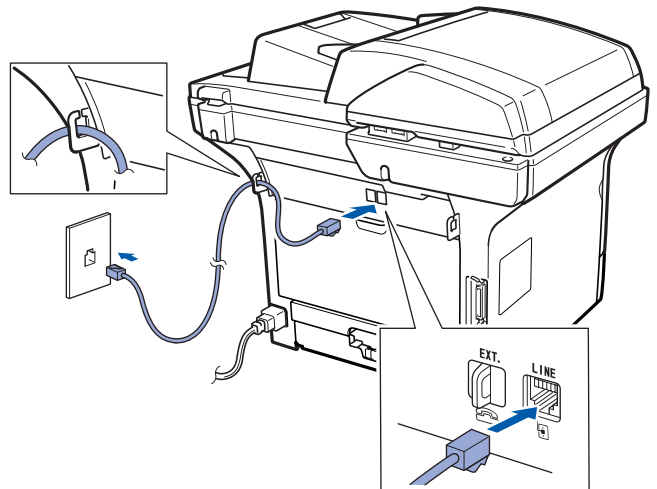

### ! IMPORTANT

The telephone line cord **MUST** be connected to the socket on the machine marked **LINE**.

### ! WARNING

The machine must be grounded using an earthed plug.

Since the machine is grounded through the power outlet, you can protect yourself from potentially hazardous electrical conditions on the telephone network by keeping the power cord connected to your machine when you connect it to a telephone line. Similarly, you can protect yourself when you want to move your machine by disconnecting the telephone line first and then the power cord.

**Note**

If you are sharing one telephone line with an external telephone, connect it as shown below. Before you connect the external telephone, remove the protective cap 1 from the **EXT.** jack on the machine.

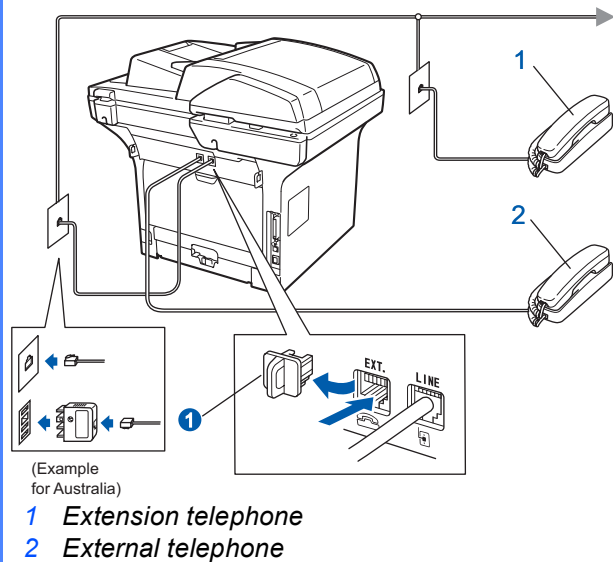

**Note**

If you are sharing one telephone line with an external telephone answering machine, connect it as shown below. Before you connect the external telephone answering machine, remove the protective cap 1 from the **EXT.** jack on the machine.

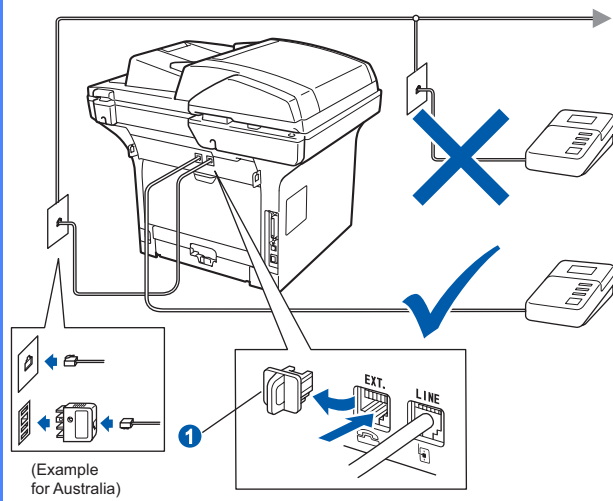

Set the receive mode to *External TAD* if you have an external answering machine. See Choose a Receive Mode on page 8. For additional details, see Connecting an external TAD (telephone answering device) in Chapter 7 of the User's Guide.

## 6 Set your country (for Australia/New Zealand customer only)

You must set your country so that the machine works correctly on local telecommunication lines in each country.

**a** Check that the power is turned on by plugging in the power cord and turn the power switch on.

**b** Press or to choose the country (Australia or New Zealand).



Press **OK** when the LCD shows your country.

**c** The LCD prompts you to make sure of the country again.



**d** If the LCD shows the correct country, press **1** to go to Step **e**.  
—OR—

Press **2** to go back to Step **b** to choose the country again.

**e** After the LCD shows *Accepted*, the machine will restart automatically. After the restart, the LCD shows *Please Wait*.



**Note**

If *Scanner Locked* appears on the LCD, immediately release the scanner lock and press **Stop/Exit**. (See Release the scanner lock on page 6.)

## 7 Choose a Receive Mode

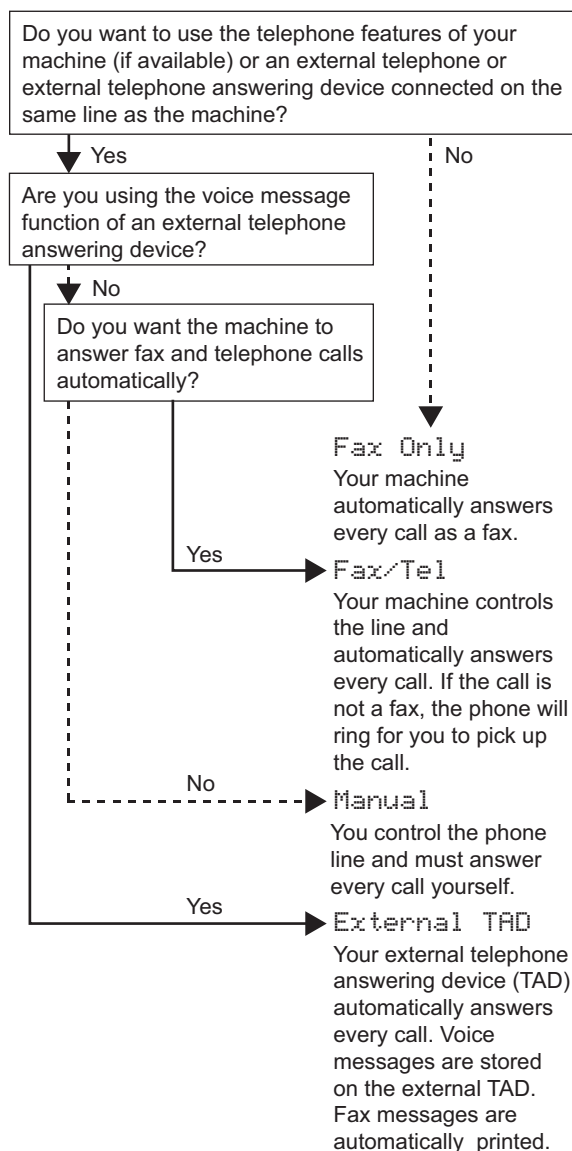
There are four possible receive modes: Fax Only, Fax/Tel, Manual and External TAD.





- a** Press **Menu**.
- b** Press **0**.
- c** Press **1**.
- d** Press  or  to choose the receive mode.  
Press **OK**.
- e** Press **Stop/Exit**.

 For more details, see Receiving a fax in Chapter 6 of the User's Guide.

## 8 Set the LCD contrast (If needed)

If you are having difficulty reading the LCD, try changing the contrast setting.

- a** Press **Menu**.
- b** Press **1**.
- c** Press **7**.
- d** Press  to increase the contrast.  
—OR—  
Press  to decrease the contrast.  
Press **OK**.
- e** Press **Stop/Exit**.



# 9

## Set the date and time

The machine displays the time, and if you set up the station ID the date and time will be added to each fax you send.

- a** Press **Menu**.
- b** Press **0**.
- c** Press **2**.
- d** Enter the last two digits of the year on the dial pad, and then press **OK**.

02.Date&Time  Year:2009
Enter & OK Key

(e.g. Enter **0, 9** for 2009.)

- e** Enter the two digits for the month on the dial pad, and then press **OK**.

02.Date&Time XX/XX/2009  Month:03
Enter & OK Key

(e.g. Enter **0, 3** for March.)

- f** Enter the two digits for the day on the dial pad, and then press **OK**.

02.Date&Time XX/03/2009  Day:25
Enter & OK Key

(e.g. Enter **2, 5**.)

- g** Enter the time in 24-hour format on the dial pad, and then press **OK**.

02.Date&Time 25/03/2009  Time:15:25
Enter & OK Key

(e.g. Enter **1 5, 2 5** for 3:25 P.M.)

- h** Press **Stop/Exit**.

# 10 Enter personal information (station ID)

You should store your name and fax number to be printed on all fax pages that you send.

**a** Press **Menu**.

**b** Press **0**.

**c** Press **3**.

**d** Enter your fax number (up to 20 digits) on the dial pad, and then press **OK**.

```

03.Station ID

Fax: _

Enter & OK Key
    
```

**e** Enter your telephone number (up to 20 digits) on the dial pad, and then press **OK**. If your telephone number and fax number are the same, enter the same number again.

```

03.Station ID
Fax:XXXXXXXXXXXX

Tel: _

Enter & OK Key
    
```



**f** Use the dial pad to enter your name (up to 20 characters), and then press **OK**.

```

03.Station ID
Fax:XXXXXXXXXXXX
Tel:XXXXXXXXXXXX
Name: _

Enter & OK Key
    
```

## Note

- See the following chart for entering your name.
- If you need to enter a character that is on the same key as the last character, press  to move the cursor to the right.
- If you entered a letter incorrectly and want to change it, press  or  to move the cursor to the incorrect character, press **Clear/Back**.

Press key	One time	Two times	Three times	Four times	Five times
2	A	B	C	2	A
3	D	E	F	3	D
4	G	H	I	4	G
5	J	K	L	5	J
6	M	N	O	6	M
7	P	Q	R	7	P
8	T	U	V	8	T
9	W	X	Y	9	W

 For more details, see *Entering Text in the User's Guide*.

**g** Press **Stop/Exit**.

## Note



- If you make a mistake and want to start again, press **Stop/Exit** and go back to step **a**.

## 11 Fax Transmission Report

Your Brother machine is equipped with a Transmission Verification Report that can be used as confirmation that you sent a fax. This report lists the name or fax number of the receiving party, the date, time, and duration of the transmission, the number of pages transmitted, and whether or not the transmission was successful. If you want to use the Fax Transmission Report feature see Chapter 11 *Printing Reports* in the *User's Guide*.

## 12 Set tone or pulse dialling mode (not available in New Zealand)

Your machine comes set for Tone dialling service. If you have Pulse dialling service (rotary), you need to change the dialling mode.

- a** Press **Menu**.
- b** Press **0**.
- c** Press **4**.
- d** Press  or  to choose **Pulse** (or **Tone**). Press **OK**.
- e** Press **Stop/Exit**.

## 13 Dial Prefix

The dial prefix setting will automatically dial a predefined number before every fax number you dial. For example: If your phone system requires a 9 to dial an outside number this setting will automatically dial 9 for every fax you send.

- a** Press **Menu**.
- b** Press **0**.
- c** Press **6** (For New Zealand, press **5**).
- d** Enter the prefix number (up to 5 digits) on the dial pad, and then press **OK**.



### Note

You can use the number 0 to 9, #, \* and !. (Press **Hook** to display "!".)

You cannot use ! with any other numbers or characters.



If your telephone system requires a timed break recall (hookflash), press **Hook** to enter the break.

- e** Press **Stop/Exit**.

# 14

## Set Daylight Saving Time

You can set the machine to change for Daylight Saving Time. If you choose **On**, it will reset the time forward one hour and if you choose **Off**, it will reset the time backward one hour.

- a** Press **Menu**.
- b** Press **1**.
- c** Press **4**.
- d** Press  or  to choose **On** or **Off**.
- e** Press **OK**.
- f** Press **1** or **2** to choose **1** . **Change** or **2** . **Exit**.
- g** Press **Stop/Exit**.

# 15

## Choose your connection type

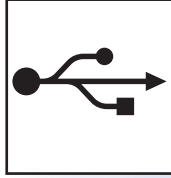
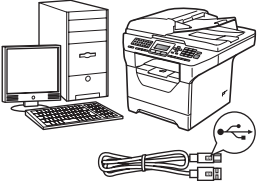

### For USB Interface Users

Windows<sup>®</sup>, go to page 14  
Macintosh<sup>®</sup>, go to page 18

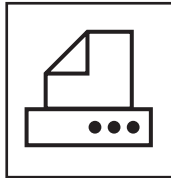
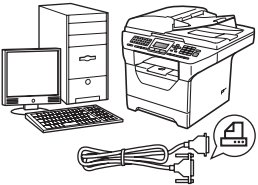

### For Parallel interface cable

Windows<sup>®</sup>, go to page 20

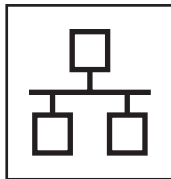
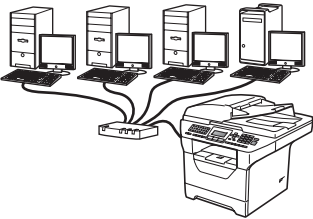

### For Wired Network

Windows<sup>®</sup>, go to page 24  
Macintosh<sup>®</sup>, go to page 28

For Windows Server<sup>®</sup> 2003/ 2008, see the *Network User's Guide* on the CD-ROM.

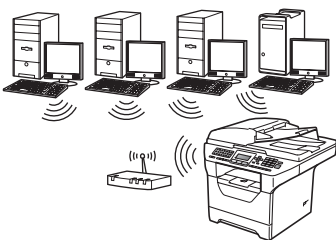

### For Wireless Network

Windows<sup>®</sup> and Macintosh<sup>®</sup>,  
go to page 30

USB	Windows <sup>®</sup>
	Macintosh <sup>®</sup>
Parallel	Windows <sup>®</sup>
Wired Network	Windows <sup>®</sup>
	Macintosh <sup>®</sup>
Wireless Network	Windows <sup>®</sup>
	Macintosh <sup>®</sup>



## For USB Interface Users (Windows® 2000 Professional/XP/XP Professional x64 Edition/ Windows Vista®)

### 16 Before you install

- a Make sure that your computer is ON and you are logged on with Administrator rights.

#### ! IMPORTANT

- DO NOT connect the USB cable yet.
- If there are any programs running, close them.
- Make sure a USB Flash memory device is not inserted into the machine.
- The screen may differ depending on the operating system.
- The supplied CD-ROM includes ScanSoft™ PaperPort™ 11SE. This software supports Windows® 2000 (SP4 or greater), XP (SP2 or greater), XP Professional x64 Edition and Windows Vista®. Update to the latest Windows® Service Pack before installing MFL-Pro Suite.

- b Turn off and unplug the machine from the AC outlet and disconnect it from your computer, if you already connected an interface cable.

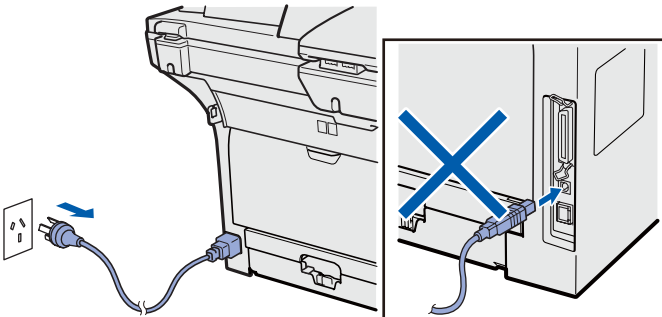

### 17 Install MFL-Pro Suite

- a Put the supplied CD-ROM into your CD-ROM drive. If the model name screen appears, choose your machine. If the language screen appears, choose your language.

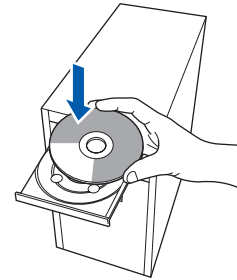

#### Note

If the Brother screen does not appear automatically, go to **My Computer (Computer)**, double-click the CD-ROM icon, and then double-click **Start.exe**.

- b The CD-ROM main menu will appear. Click **Initial Installation**.



- c Click **Install MFL-Pro Suite**.





## Note

- If the installation does not continue automatically, open the main menu again by ejecting and then reinserting the CD-ROM or double-click the **Start.exe** program from the root folder, and continue from step **c** to install MFL-Pro Suite.
- For Windows Vista®, when the **User Account Control** screen appears, click **Allow**.

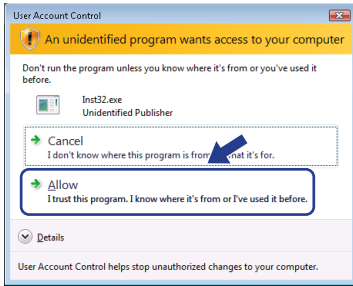

- d** Choose **Local Connection**, and then click **Next**. The installation continues.

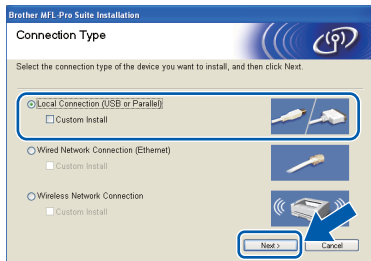

## Note

If you want to install the PS driver (Brother's BR-Script Driver), choose **Custom Install** and then follow the on-screen instructions. When the **Select Features** screen appears, check **PS Printer Driver**, and then continue following the on-screen instructions.

- e** When the ScanSoft™ PaperPort™ 11SE **License Agreement** window appears, click **Yes** if you agree to the Software License Agreement.

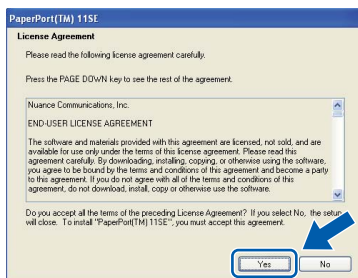

- f** The installation of ScanSoft™ PaperPort™ 11SE will automatically start and is followed by the installation of MFL-Pro Suite.

- g** When the Brother MFL-Pro Suite Software **License Agreement** window appears, click **Yes** if you agree to the Software License Agreement.

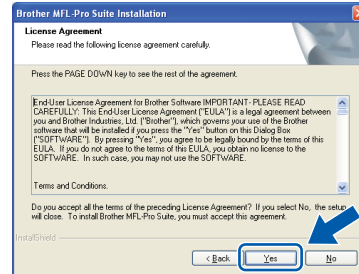

- h** If you do not want to monitor the machine status and error notifications from your computer, uncheck **Enable Status Monitor** and then click **Next**.



## Note

For Windows Vista®, when this screen appears, click the check box and click **Install** to complete the installation correctly.



- i** When this screen appears, go to the next step.

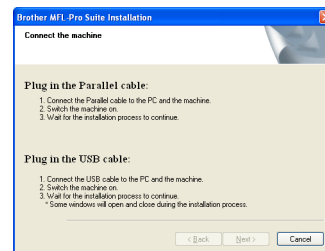





## 18 Connect the USB cable

### ! IMPORTANT

- **DO NOT** connect the machine to a USB port on a keyboard or a non-powered USB hub.
- **Connect the machine directly to your computer.**

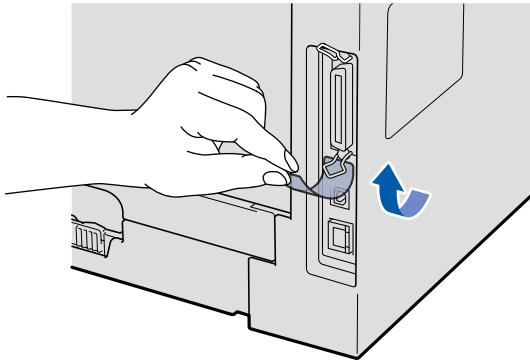
**a** Remove the label covering the USB interface connector.



**b** Connect the USB cable to the USB connector on the machine marked with the  symbol. Then connect the cable to your computer.

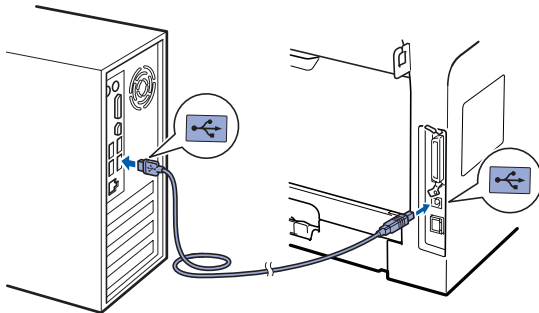

## 19 Connect the power cord

**a** Plug the AC power cord into an AC outlet. Turn the power switch on.

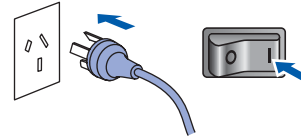

The installation will continue automatically. The installation screens appear one after another.

### ! IMPORTANT

**DO NOT** cancel any of the screens during the installation. It may take a few seconds for all screens to appear.

**b** When the **On-Line Registration** screen is displayed, make your selection and follow the on-screen instructions. Once you have completed the registration process, close your web browser to return to this window. Then click **Next**.

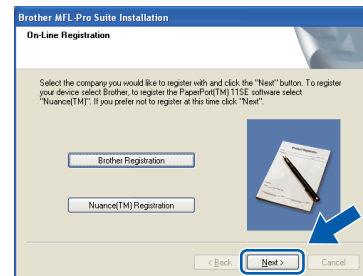





## 20 Finish and restart

- a Click **Finish** to restart your computer. After restarting the computer, you must be logged on with Administrator rights.

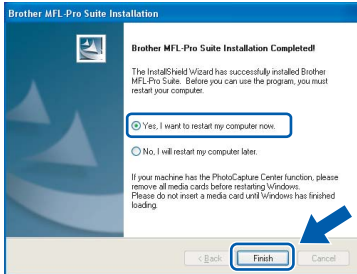

### Note

If an error message appears during the software installation, run the **Installation Diagnostics** located in **Start/All Programs/Brother /MFC-XXXX** (where MFC-XXXX is your model name).

- b If this screen appears, choose the firmware update setting and click **OK**.

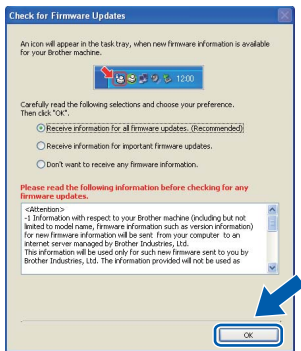

### Note

Internet access is required for the firmware upgrade.

## Finish

The installation is now complete.

### Note

**XML Paper Specification Printer Driver**  
The XML Paper Specification Printer Driver is the most suitable driver when printing from the applications that use the XML Paper Specification documents. Please download the latest driver by accessing the Brother Solutions Center at <http://solutions.brother.com/>.



## For USB Interface Users (Mac OS® X 10.3.9 or greater)

### 16 Before you install

- a** Make sure your machine is connected to the power and your Macintosh® is ON. You must be logged on with Administrator rights.

#### ! IMPORTANT

Make sure a USB Flash memory device is not inserted into the machine.

### 17 Connect the USB cable

#### ! IMPORTANT

- **DO NOT** connect the machine to a USB port on a keyboard or a non-powered USB hub.
- **Connect the machine directly to your Macintosh®.**

- a** Remove the label covering the USB interface connector.

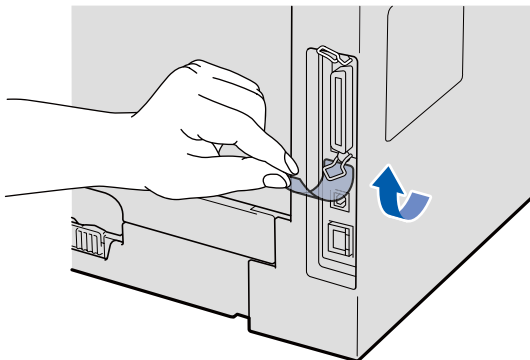

- b** Connect the USB cable to the USB connector on the machine marked with the  symbol. Then connect the cable to your computer.

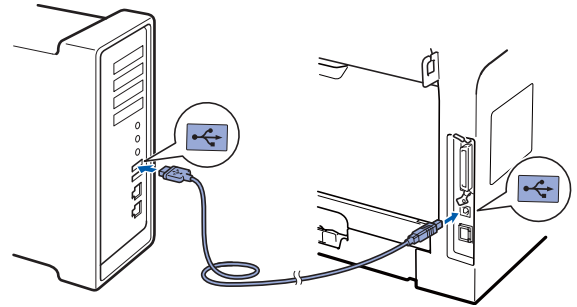

### 18 Install MFL-Pro Suite

- a** Put the supplied CD-ROM into your CD-ROM drive.

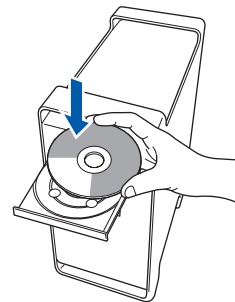

- b** Double-click **Start Here OSX** to install.

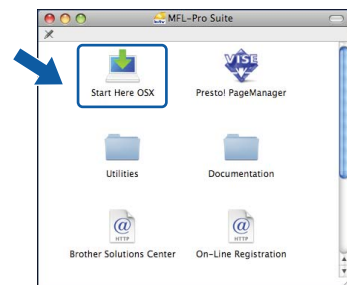

#### Note

Please see the Software User's Guide on the CD-ROM if you want to install the PS driver. (Brother's BR-Script Driver)



- c** Choose **Local Connection**, and then click **Next**. Follow the on-screen instructions.

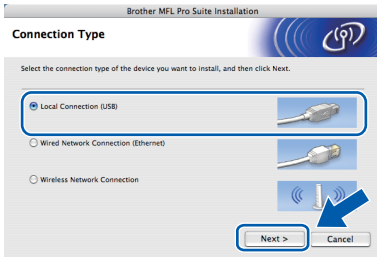

### Note

*Please wait, it will take a few seconds for the software to install. After the installation, click **Restart** to finish installing the software.*

- d** The Brother software will search for the Brother device. During this time the following screen will appear.

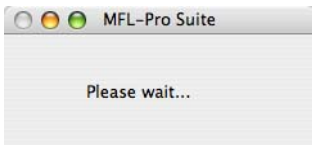

- e** Choose the machine from the list, and then click **OK**.

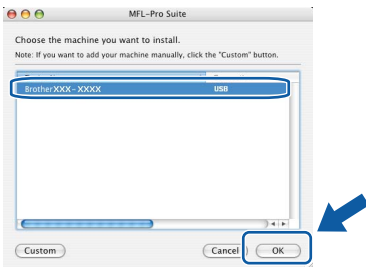

- f** When this screen appears, click **OK**.

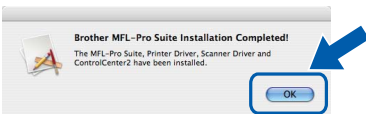

- OK!** The installation of **MFL-Pro Suite** is now complete. Go to **step 19** on page 19.

## 19 Install Presto! PageManager

When Presto! PageManager is installed OCR capability is added to Brother ControlCenter2. You can easily scan, share and organize photos and documents using Presto! PageManager.

- a** Double-click **Presto! PageManager** and follow the on-screen instructions.

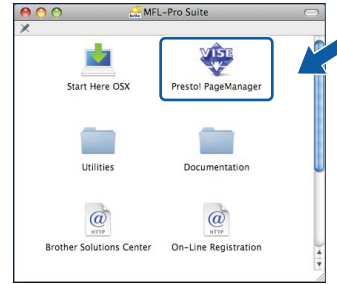

### Finish

The installation is now complete.



## For Parallel Interface Users (Windows® 2000 Professional/XP/XP Professional x64 Edition)

### 16 Before you install

**a** Make sure that your computer is ON and you are logged on with Administrator rights.

#### ! IMPORTANT

- **DO NOT** connect the Parallel cable yet.
- If there are any programs running, close them.
- Make sure a USB Flash memory device is not inserted into the machine.
- The screen may differ depending on the operating system.
- The supplied CD-ROM includes ScanSoft™ PaperPort™ 11SE. This software supports Windows® 2000 (SP4 or greater), XP (SP2 or greater) and XP Professional x64 Edition. Update to the latest Windows® Service Pack before installing MFL-Pro Suite.

**b** Turn off and unplug the machine from the AC outlet and disconnect it from your computer, if you already connected an interface cable.

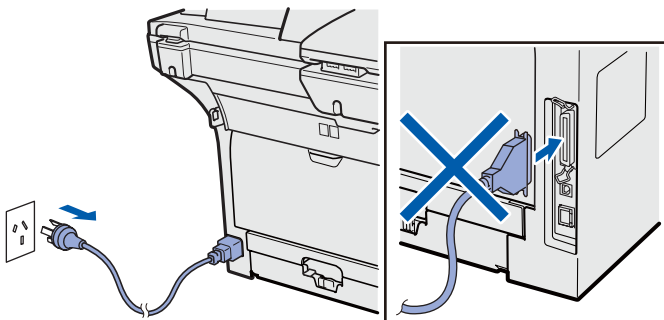

### 17 Install MFL-Pro Suite

**a** Put the supplied CD-ROM into your CD-ROM drive. If the model name screen appears, choose your machine. If the language screen appears, choose your language.

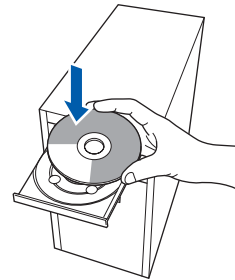

#### Note

*If the Brother screen does not appear automatically, go to **My Computer (Computer)**, double-click the CD-ROM icon, and then double-click **Start.exe**.*

**b** The CD-ROM main menu will appear. Click **Initial Installation**.



**c** Click **Install MFL-Pro Suite**.





## Note

If the installation does not continue automatically, open the main menu again by ejecting and then reinserting the CD-ROM or double-click the **Start.exe** program from the root folder, and continue from **c** to install MFL-Pro Suite.

- d** Choose **Local Connection**, and then click **Next**. The installation continues.

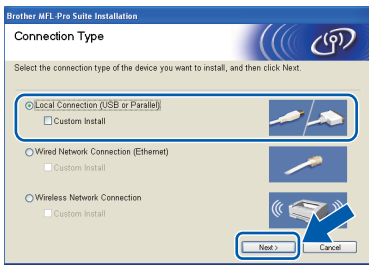

## Note

If you want to install the PS driver (Brother's BR-Script Driver), choose **Custom Install** and then follow the on-screen instructions. When the **Select Features** screen appears, check **PS Printer Driver**, and then continue following the on-screen instructions.

- e** When the ScanSoft™ PaperPort™ 11SE License Agreement window appears, click **Yes** if you agree to the Software License Agreement.

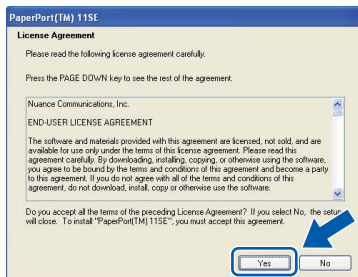

- f** The installation of ScanSoft™ PaperPort™ 11SE will automatically start and is followed by the installation of MFL-Pro Suite.

- g** When the Brother MFL-Pro Suite Software License Agreement window appears, click **Yes** if you agree to the Software License Agreement.

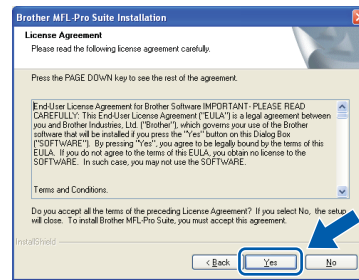

- h** If you do not want to monitor the machine status and error notifications from your computer, uncheck **Enable Status Monitor** and then click **Next**.

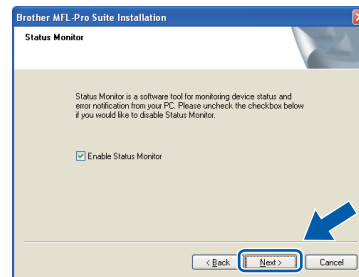

- i** When this screen appears, go to the next step.

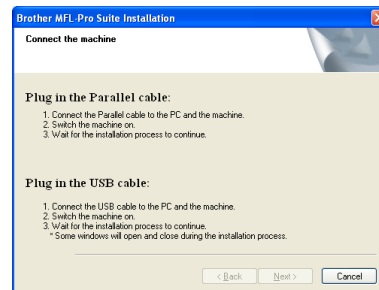



## 18

### Connect the Parallel cable

#### ! IMPORTANT

Connect the machine directly to your computer.

- a Connect the Parallel interface cable to your computer, and then connect it to the machine.

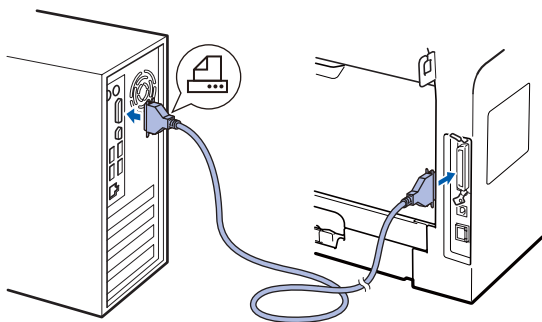

## 19

### Connect the power cord

- a Plug the AC power cord into an AC outlet. Turn the power switch on.

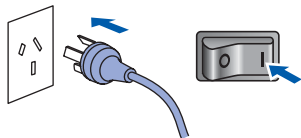

The installation will continue automatically.  
The installation screens appear one after another.

## b

Do one of the following:

- For Windows® 2000 Professional users, click **Next**.

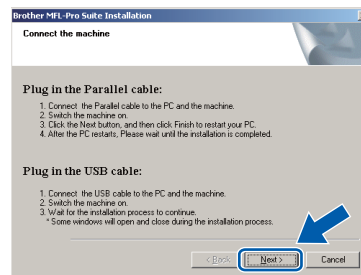

#### Note

If this screen appears, click **OK**.



- For Windows® XP/XP Professional x64 Edition users, wait for a while since the installation of the Brother drivers will automatically start. The screens appear one after another.

#### ! IMPORTANT

**DO NOT cancel any of the screens during the installation. It may take a few seconds for all screens to appear.**

## c

When the **On-Line Registration** screen is displayed, make your selection and follow the on-screen instructions. Once you have completed the registration process, close your web browser to return to this window. Then click **Next**.

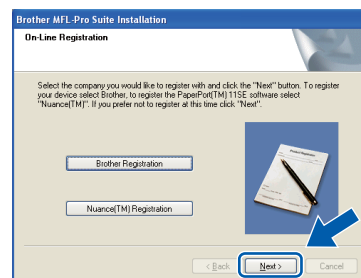



## 20 Finish and restart

- a Click **Finish** to restart your computer. After restarting the computer, you must be logged on with Administrator rights.



### Note

If an error message appears during the software installation, run the **Installation Diagnostics** located in **Start/All Programs/Brother /MFC-XXXX LPT** (where MFC-XXXX is your model name).

- b If this screen appears, choose the firmware update setting and click **OK**.

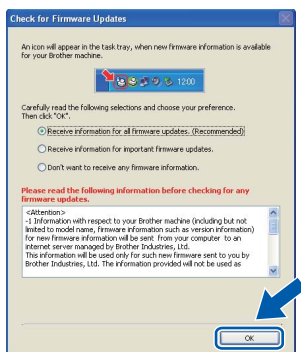

### Note

Internet access is required for the firmware upgrade.

## Finish

The installation is now complete.

### Note

**XML Paper Specification Printer Driver**  
The XML Paper Specification Printer Driver is the most suitable driver when printing from the applications that use the XML Paper Specification documents. Please download the latest driver by accessing the Brother Solutions Center at <http://solutions.brother.com/>.

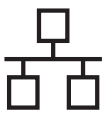

## For Wired Network Interface Users (Windows® 2000 Professional/XP/XP Professional x64 Edition/ Windows Vista®)

### 16 Before you install

- a** Make sure that your computer is ON and you are logged on with Administrator rights.

#### ! IMPORTANT

- If there are any programs running, close them.
- Make sure a USB Flash memory device is not inserted into the machine.
- The screens may differ depending on the operating system.
- The supplied CD-ROM includes ScanSoft™ PaperPort™ 11SE. This software supports Windows® 2000 (SP4 or greater), XP (SP2 or greater), XP Professional x64 Edition and Windows Vista®. Update to the latest Windows® Service Pack before installing MFL-Pro Suite.

#### ! IMPORTANT

**Disable all personal firewall software (other than Windows® Firewall), anti-spyware or antivirus applications for the duration of the installation.**

- b** Unplug the machine from the AC outlet.

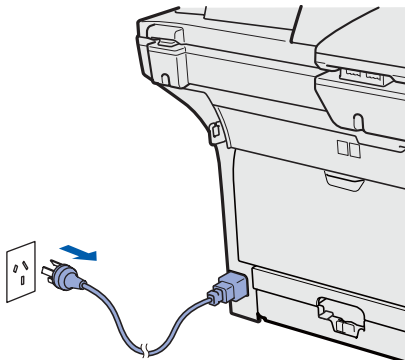

### 17 Connect the network cable

- a** Connect the network interface cable to the LAN connector marked with a  symbol and then connect it to a free port on your hub.

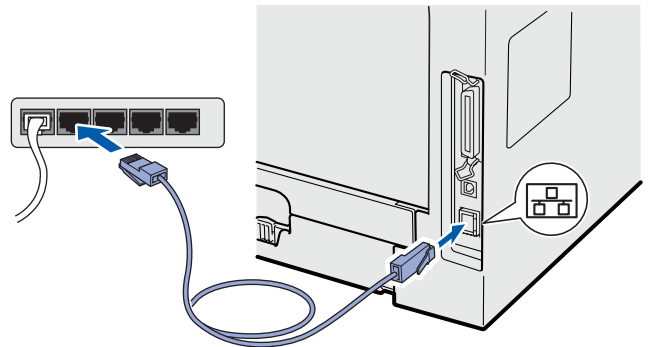

### 18 Connect the power cord

- a** Plug the AC power cord into an AC outlet. Turn the power switch on.

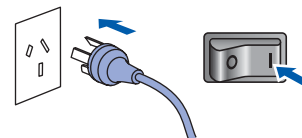





## 19 Install MFL-Pro Suite

- a** Put the supplied CD-ROM into your CD-ROM drive. If the model name screen appears, choose your machine. If the language screen appears, choose your language.

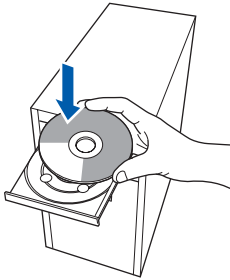

### Note

If the Brother screen does not appear automatically, go to **My Computer (Computer)**, double-click the CD-ROM icon, and then double-click **Start.exe**.

- b** The CD-ROM main menu will appear. Click **Initial Installation**.



- c** Click **Install MFL-Pro Suite**.



### Note

- If the installation does not continue automatically, open the main menu again by ejecting and then reinserting the CD-ROM or double-click the **Start.exe** program from the root folder, and continue from **c** to install MFL-Pro Suite.
- For Windows Vista®, when the **User Account Control** screen appears, click **Allow**.

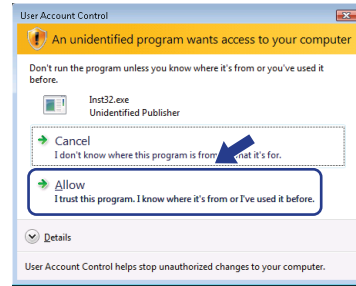

- d** Choose **Wired Network Connection**, and then click **Next**.

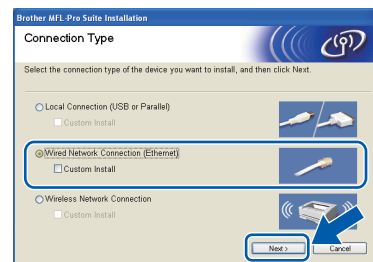

### Note

If you want to install the PS driver (Brother's BR-Script Driver), choose **Custom Install** and then follow the on-screen instructions. When the **Select Features** screen appears, check **PS Printer Driver**, and then continue following the on-screen instructions.

- e** When the ScanSoft™ PaperPort™ 11SE License Agreement window appears, click **Yes** if you agree to the Software License Agreement.

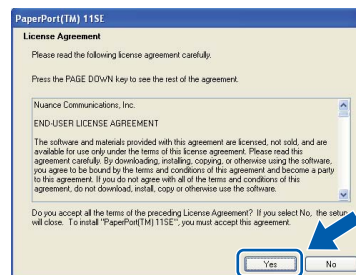

- f** The installation of ScanSoft™ PaperPort™ 11SE will automatically start and is followed by the installation of MFL-Pro Suite.

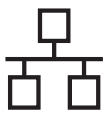

- g** When the Brother MFL-Pro Suite Software **License Agreement** window appears, click **Yes** if you agree to the Software **License Agreement**.

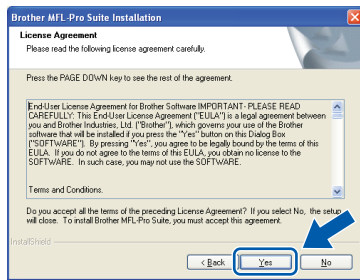

- h** For Windows® XP SP2/XP Professional x64 Edition/ Windows Vista® users, when this screen appears, choose **Change the Firewall port settings to enable network connection and continue with the installation. (Recommended)** and click **Next**.

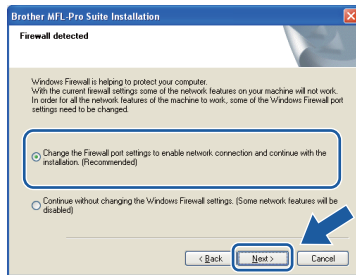

If you are not using the Windows® Firewall, see the *User's Guide* for your software for information on how to add the following network ports.

- For network scanning, add UDP port 54925.
- For network PC-Fax receiving, add UDP port 54926.
- If you still have trouble with your network connection, add UDP port 137.

- i** If the machine is configured for your network, choose the machine from the list, and then click **Next**.

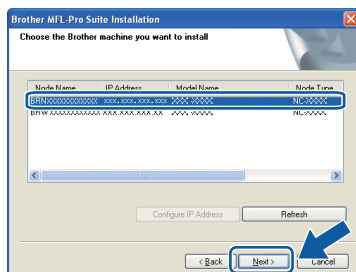

## Note

- You can find your machine's IP address and the node name by printing out the *Network Configuration List*. See *Print the Network Configuration List on page 45*.
- If your machine is not found over the network, following screen will appear.



Confirm your network setting by following the on-screen instructions.

- If the machine is not yet configured for use on your network, the following screen appears.



Click **OK** and then **Configure IP Address**. Enter an IP address for your machine that is suitable for your network by following the on-screen instructions.

- j** If you do not want to monitor the machine status and error notifications from your computer, uncheck **Enable Status Monitor** and then click **Next**.

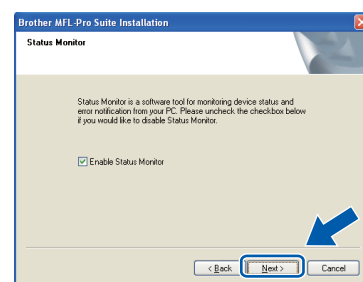

- k** The installation of the Brother drivers will automatically start. The installation screens appear one after another.

## ! IMPORTANT

**DO NOT** cancel any of the screens during the installation. It may take a few seconds for all screens to appear.

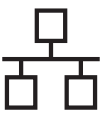

## Note

For Windows Vista®, when this screen appears, click the check box and click **Install** to complete the installation correctly.

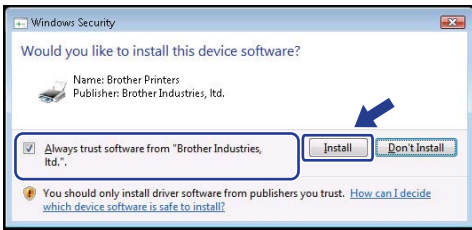

When the **On-Line Registration** screen is displayed, make your selection and follow the on-screen instructions. Once you have completed the registration process, close your web browser to return to this window. Then click **Next**.

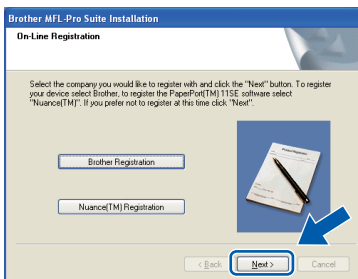

## 20 Finish and restart

**a** Click **Finish** to restart your computer. After restarting the computer, you must be logged on with Administrator rights.

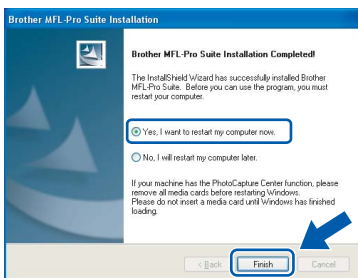

## Note

If an error message appears during the software installation, run the **Installation Diagnostics** located in **Start/All Programs/Brother/MFC-XXXX LAN** (where MFC-XXXX is your model name).

**b**

If this screen appears, choose the firmware update setting and click **OK**.

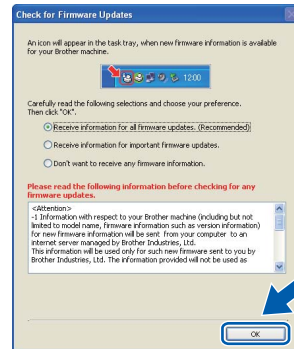

## Note

Internet access is required for the firmware upgrade.

## 21 Install MFL-Pro Suite on additional computers (If needed)

If you want to use your machine with multiple computers on the network, install MFL-Pro Suite on each computer. Go to step **19** on page 25.



## Note

The MFL-Pro Suite Software License permits installation on up to 5 network computers. If you want to install MFL-Pro Suite on additional computers, you can purchase additional NL-5 (five user) license agreements from your authorized Brother dealer or contact Brother customer service.

## Finish

The installation is now complete.



## Note

**XML Paper Specification Printer Driver**  
The XML Paper Specification Printer Driver is the most suitable driver when printing from the applications that use the XML Paper Specification documents. Please download the latest driver by accessing the Brother Solutions Center at <http://solutions.brother.com/>.

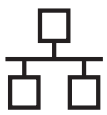

## For Wired Network Interface Users (Mac OS® X 10.3.9 or greater)

### 16 Before you install

- a Make sure your machine is connected to the power and your Macintosh® is ON. You must be logged on with Administrator rights.

#### ! IMPORTANT

Make sure a USB Flash memory device is not inserted into the machine.

### 17 Connect the network cable

- a Connect the network interface cable to the LAN connector marked with a  symbol and then connect it to a free port on your hub.

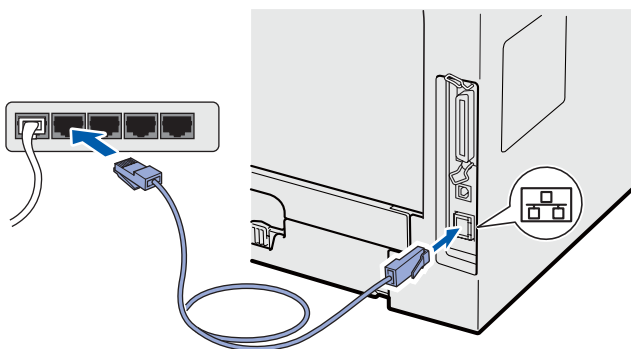

### 18 Install MFL-Pro Suite

- a Put the supplied CD-ROM into your CD-ROM drive.

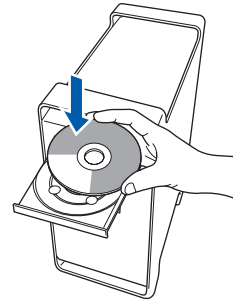

- b Double-click **Start Here OSX** to install.

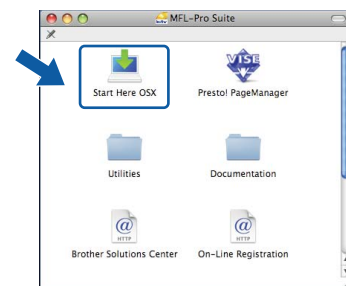

#### Note

Please see the Network User's Guide on the CD-ROM if you want to install the PS driver. (Brother's BR-Script Driver)

- c Choose **Wired Network Connection**, and then click **Next**. Follow the on-screen instructions.

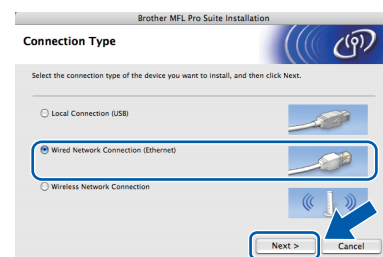

#### Note

Please wait, it will take a few seconds for the software to install. After the installation, click **Restart** to finish installing the software.



- d** The Brother software will search for the Brother device. During this time the following screen will appear.

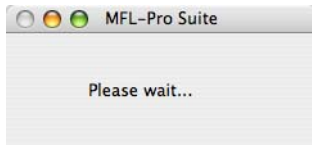

- e** If the machine is configured for your network, choose the machine from the list, and then click **OK**.

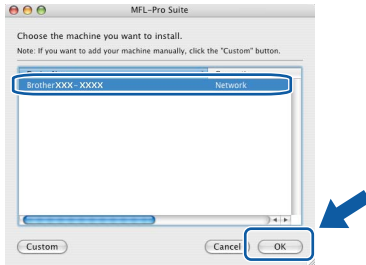

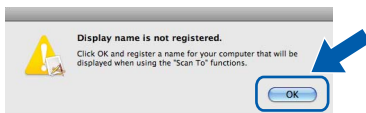

### Note

- You can find your machine's IP address and the node name by printing out the Network Configuration List. See Print the Network Configuration List on page 45.
- If your machine is not found over the network, confirm your network setting.
- If this screen appears click **OK**.

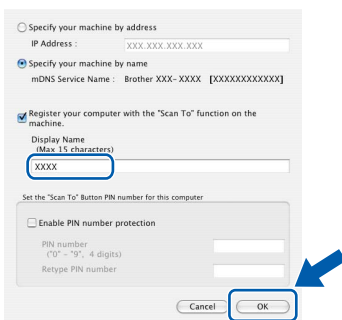

- Enter a name for your Macintosh® in **Display Name** up to 15 characters long and click **OK**. Go to **f**.



- If you want to use the machine's **Scan** key to scan over the network, you must check the **Register your computer with the "Scan To" function on the machine box**.
- The name you enter will appear on the machine's LCD when you press  and choose a scan option. (For more information, see Network Scanning in the Software User's Guide on the CD-ROM.)

- f** When this screen appears, click **OK**.



- OK!** The installation of MFL-Pro Suite is now complete. Go to step **19** on page 29.

## 19 Install Presto! PageManager

When Presto! PageManager is installed OCR capability is added to Brother ControlCenter2. You can easily scan, share and organize photos and documents using Presto! PageManager.

- a** Double-click **Presto! PageManager** and follow the on-screen instructions.

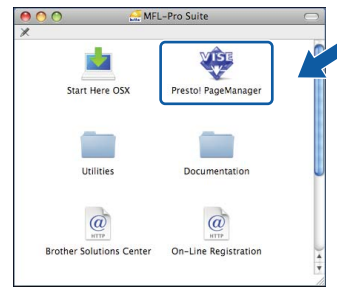

## 20 Install MFL-Pro Suite on additional computers (If needed)

If you want to use your machine with multiple computers on the network, install MFL-Pro Suite on each computer. Go to step **18** on page 28.

### Finish

The installation is now complete.



## For Wireless Network Interface Users

### 16 Before you begin

First you **must** configure the wireless network settings of your machine to communicate with your network access point (router). After the machine is configured to communicate with your access point (router) computers on your network will have access to the machine. To use the machine from these computers, you will need to install the drivers and software. The following steps will guide you through the configuration and installation process.



#### Note

- *To achieve optimum results with normal everyday document printing, place the Brother machine as close to the network access point (router) as possible with minimal obstructions. Large objects and walls between the two devices as well as interference from other electronic devices can affect the data transfer speed of your documents.*
- *Due to these factors, wireless may not be the best method of connection for all types of documents and applications. If you are printing large files, such as multi-page documents with mixed text and large graphics, you may want to consider choosing wired Ethernet for a faster data transfer or USB for the fastest throughput speed.*
- *Although the Brother MFC-8890DW can be used in a both wired and wireless network, only one of the connection methods can be used at a time.*
- *If you have previously configured the wireless settings of the machine you must reset the network (LAN) settings before you can configure the wireless settings again.  
On your machine, press **Menu**. Press **7**.  
Press **0** to choose *Network Reset*.  
Press **1** twice for *Yes* to accept the change.*



#### Note

*The following instructions are for infrastructure mode.*

*To set up your machine in any other wireless environment you can find instructions in the Network User's Guide on the CD-ROM.*

*You can view the Network User's Guide by following the instructions below.*

*1 Turn on your computer/Macintosh<sup>®</sup>. Insert the Brother CD-ROM into your CD-ROM drive.*

*For Windows<sup>®</sup>:*

*2 Choose your model and the language. The CD-ROM main menu will appear.*

*3 Click **Documentation**, and then click **HTML documents**.*

*For Macintosh<sup>®</sup>:*

*2 Double-click **Documentation**, and then double-click your language folder.*

*3 Double-click **top.html**.*



## Infrastructure Mode

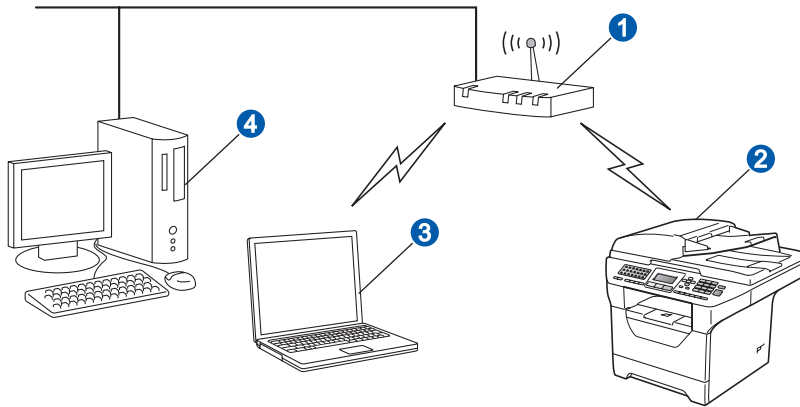

- ① Access Point (router)
- ② Wireless Network machine (your machine)
- ③ Wireless capable computer connected to the access point
- ④ Wired computer connected to the access point



## 17 Confirm your network environment (Infrastructure Mode)

The following instructions will offer two methods for installing your Brother machine in a wireless network environment. Both methods are for infrastructure mode, using a wireless router or access point that uses DHCP to assign IP addresses. Choose a configuration method and proceed to the page indicated.

- a** If your wireless router/access point does not support SecureEasySetup™, Wi-Fi Protected Setup or AOSS™, write down the wireless network settings of your wireless access point/router.

### ! IMPORTANT

If you do not know this information (Network Name, WEP key, WPA2-PSK (Pre-Shared Key), LEAP or EAP-FAST) you cannot continue the wireless setup. You should see the documentation provided with your access point or wireless router, consult the router manufacturer, or your system administrator.

Item	Example	Record the current wireless network settings
Communication mode: (infrastructure)	Infrastructure	
Network name: (SSID, ESSID)	HELLO	
Authentication method: (Open system, Shared key, WPA-PSK <sup>1</sup> , WPA2-PSK <sup>1</sup> , LEAP, EAP-FAST)	WPA2-PSK	
Encryption mode: (None, WEP, TKIP, AES, CKIP)	AES	
Network key: (Encryption key, WEP key <sup>2</sup> , Passphrase)	12345678	

<sup>1</sup> WPA/WPA2-PSK is a Wi-Fi Protected Access Pre-Shared Key, which lets the Brother wireless machine associate with access points using TKIP or AES encryption (WPA-Personal). WPA/WPA2-PSK (TKIP or AES) uses a Pre-Shared Key (PSK) that is 8 or more characters in length, up to a maximum of 63 characters.

<sup>2</sup> The WEP key is for 64-bit encrypted networks or 128-bit encrypted networks and can contain both numbers and letters. If you do not know this information you should see the documentation provided with your access point or wireless router. This key is a 64-bit or 128-bit value that must be entered in an ASCII or HEXADECIMAL format.

#### For example:

64-bit ASCII:	Uses 5 text characters e.g. "Hello" (this is case sensitive)
64-bit Hexadecimal:	Uses 10 digits of hexadecimal data e.g. "71f2234aba"
128-bit ASCII:	Uses 13 text characters e.g. "Wirelesscomms" (this is case sensitive)
128-bit Hexadecimal:	Uses 26 digits of hexadecimal data e.g. "71f2234ab56cd709e5412aa3ba"

Now go to

page 33

- b** If your wireless router/access point supports automatic wireless (one-push) setup (SecureEasySetup™, Wi-Fi Protected Setup or AOSS™)

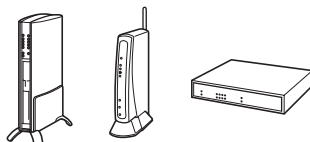

Now go to

page 35





## Connecting the Brother machine to the wireless network

# 18

### Configure the wireless settings (Typical Wireless Setup in infrastructure mode)

**a** On your machine, press **Menu**, **7** (Network), **2** (WLAN), **2** (Setup Wizard).

Press or to choose On, then press **OK**.

**b** The machine will search for available SSIDs. If a list of SSIDs is displayed, use or to choose the SSID you wrote down in step **17** on page 32, then press **OK**. Go to step **f**.



#### Note

*It will take several seconds to display a list of available SSIDs.*

If your access point is set to not broadcast the SSID you will have to manually add the SSID name. Go to step **c**.

**c** Press or to choose <New SSID> and press **OK**. Go to step **d**.

**d** Enter the SSID you wrote down in step **17** on page 32 using the dial pad to choose each letter or number.

You can use and to move the cursor left and right. For example, to enter the letter a, press the **2** key on the dial pad once. To enter the number 3, press the **3** key on the dial pad seven times.

The letters appear in this order: lower case, upper case and then numbers.  
(For more information, see *Entering Text for Wireless Settings* on page 46.)

Press **OK** when you have entered all the characters.

**e** Press or to choose Infrastructure, then press **OK**.

**f**

Use the , and **OK** keys to choose one of the options below: If your network is configured for Authentication and Encryption you must match the settings used for your network.

■ **No Authentication or Encryption:**

Choose Open System, press **OK** then use

or to choose None for Encryption Type? and press **OK**. Then press **1** for Yes to apply your settings. Go to step **k**.

■ **No Authentication with WEP Encryption:**

Choose Open System, press **OK** then use

or to choose WEP for the Encryption Type? and press **OK**. Go to step **g**.

■ **Authentication with WEP Encryption:**

Choose Shared Key and press **OK**.

Go to step **g**.

■ **Authentication with WPA/WPA2-PSK (TKIP or AES) Encryption:**

Choose WPA/WPA2-PSK and press **OK**.

Go to step **h**.

■ **Authentication with LEAP:**

Choose LEAP, press **OK**. Go to step **i**.

■ **Authentication with EAP-FAST/NONE, EAP-FAST/MS-CHAPv2, EAP-FAST/GTC (TKIP or AES Encryption):**

Choose EAP-FAST/NONE, EAP-FAST/MSCHAP (EAP-FAST/MS-CHAPv2) or EAP-FAST/GTC, press **OK**. Go to step **j**.

**g**

Choose the appropriate key number and press **OK**. Enter the WEP key you wrote down in step **17** on page 32 using the dial pad to choose each letter or number.

For example, to enter the letter a, press the **2** key on the dial pad once. To enter the number 3, press the **3** key on the dial pad seven times.

The letters appear in this order: lower case, upper case and then numbers.

(For more information, see *Entering Text for Wireless Settings* on page 46.)

Press **OK** when you have entered all the characters, then press **1** for Yes to apply your settings. Go to step **k**.



**h** Press or to choose TKIP or AES for Encryption Type? and press **OK**. Enter the WPA/WPA2-PSK password you wrote down in step **17** on page 32 using the dial pad to choose each letter or number.

For example, to enter the letter a, press the **2** key on the dial pad once. To enter the number 3, press the **3** key on the dial pad seven times.

The letters appear in this order: lower case, upper case and then numbers.  
(For more information, see *Entering Text for Wireless Settings* on page 46.)

Press **OK** when you have entered all the characters, then press **1** for Yes to apply your settings. Go to step **k**.

**i** Enter the user name and press **OK**. You can use or to move the cursor. For example, to enter the letter a, press the **2** key on the dial pad once.

Enter the password and press **OK**, and then press **1** to apply your settings. Go to step **k**.  
(For more information, see *Entering Text for Wireless Settings* on page 46.)

**j** Press or to choose TKIP or AES for Encryption Type? and press **OK**. Enter the user name and press **OK**. You can use or to move the cursor. For example, to enter the letter a, press the **2** key on the dial pad once.

Enter the password and press **OK**, and then press **1** to apply your settings. Go to step **k**.  
(For more information, see *Entering Text for Wireless Settings* on page 46.)

**k** Your machine will now try to connect to your wireless network using the information you have entered. If successful, Connected will appear briefly on the LCD.

If your machine does not successfully connect to your network, verify your network settings collected in step **17** on page 32, then repeat steps **a** to **j** to make sure you have entered the correct information.

If your access point does not have DHCP enabled you will need to manually configure the IP address, subnet mask and gateway of the machine to suit your network. See the *Network User's Guide* for details.



Wireless setup is now complete. A four level indicator at the top of your machine's LCD will show the wireless signal strength of your access point or router.

To install MFL-Pro Suite, continue to step **19**.

For Windows® Users:

**Now go to**  
page 37

For Macintosh® Users:

**Now go to**  
page 41



## 18 Configure the wireless settings using the automatic wireless (one-push) method

- a** Confirm your wireless router or access point has the SecureEasySetup™, Wi-Fi Protected Setup or AOSS™ symbol as shown below.



- b** Place the Brother machine within range of a SecureEasySetup™, Wi-Fi Protected Setup or AOSS™ access point/router. The range may differ depending on your environment. Refer to the instructions provided with your access point/router.

- c** Push the SecureEasySetup™, Wi-Fi Protected Setup or AOSS™ button on your wireless router or access point. See the user's guide for your wireless router/access point for instructions.

- d** On your machine, press **Menu**, **7** (Network), **2** (WLAN), **3** (SES/WPS/AOSS).

Press or to choose On, then press **OK**.

This feature will automatically detect which mode (SecureEasySetup™, Wi-Fi Protected Setup or AOSS™) your access point uses to configure your machine.

### Note

If your wireless access point supports the Wi-Fi Protected Setup (PIN Method) and you want to configure your machine using the PIN (Personal Identification Number) Method, see Using the PIN Method of Wi-Fi Protected Setup in the Network User's Guide on the CD-ROM.

- e** If the LCD shows *Connected*, the machine has successfully connected to your router/access point. You can now use your machine with your wireless network.

If the LCD shows *Setting WLAN*, *Connecting SES* (*Connecting WPS* or *Connecting AOSS*), then *Connection Fail*, the machine has not successfully connected to your router/access point. Try starting from step **c** again. If the same message is indicated again, reset the machine back to the default factory settings and try again. For resetting, see *Restore the network settings to factory default* on page 45.

If the LCD shows *Setting WLAN*, then *Connection Fail* or *Connection Error*, a session overlap or connection failure was detected (see the table below). The machine has detected 2 or more routers/access points on your network that have the SecureEasySetup™, Wi-Fi Protected Setup mode or AOSS™ mode enabled. Make sure that only one router/access point has the SecureEasySetup™, Wi-Fi Protected Setup mode or AOSS™ mode enabled and try starting from step **c** again.

If the LCD shows *Setting WLAN*, then *No Access Point*, the machine has not detected your router/access point on your network with the SecureEasySetup™ mode, the Wi-Fi Protected Setup mode or AOSS™ mode enabled. Move your machine close to the router/access point and try starting from step **c** again.

<b>LCD messages when using the SES/WPS/AOSS control panel menu</b>	
<i>Setting WLAN</i>	<i>Searching or accessing the access point and downloading settings from the access point.</i>
<i>Connecting SES/WPS/AOSS</i>	<i>Connecting to the access point.</i>
<i>Connection Fail</i>	<i>Connection failed.</i>
<i>Connection Error</i>	<i>A session overlap was detected.</i>
<i>Connected</i>	<i>The machine has successfully connected.</i>
<i>No Access Point</i>	<i>The access point detection failed.</i>

### Note

If you encounter a problem during setup, temporarily place your machine closer to the wireless access point, and go back to step **c**.



**Wireless setup is now complete.**



**Wireless setup is now complete. To install MFL-Pro Suite, continue to step 19.**

**For Windows® Users:**

**Now go to**  
**page 37**

**For Macintosh® Users:**

**Now go to**  
**page 41**



## Install the Drivers & Software

(Windows® 2000 Professional/XP/XP Professional x64 Edition/  
Windows Vista®)

### 19 Before you install MFL-Pro Suite

- a** Make sure that your computer is ON and you are logged on with Administrator rights.

#### ! IMPORTANT

- If there are any programs running, close them.
- Make sure a USB Flash memory device is not inserted into the machine.
- The screens may differ depending on the operating system.
- The supplied CD-ROM includes ScanSoft™ PaperPort™ 11SE. This software supports Windows® 2000 (SP4 or greater), XP (SP2 or greater), XP Professional x64 Edition and Windows Vista®. Update to the latest Windows® Service Pack before installing MFL-Pro Suite.

#### ! IMPORTANT

Disable all personal firewall software (other than Windows® Firewall), anti-spyware or antivirus applications for the duration of the installation.

### 20 Install MFL-Pro Suite

- a** Put the supplied CD-ROM into your CD-ROM drive. If the model name screen appears, choose your machine. If the language screen appears, choose your language.

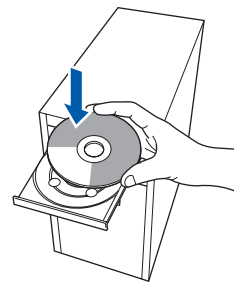

#### Note

If the Brother screen does not appear automatically, go to **My Computer (Computer)**, double-click the CD-ROM icon, and then double-click **Start.exe**.

- b** The CD-ROM main menu will appear. Click **Initial Installation**.



- c** Click **Install MFL-Pro Suite**.





## Note

- If the installation does not continue automatically, open the main menu again by ejecting and then reinserting the CD-ROM or double-click the **Start.exe** program from the root folder, and continue from step **c** to install MFL-Pro Suite.
- For Windows Vista®, when the **User Account Control** screen appears, click **Allow**.

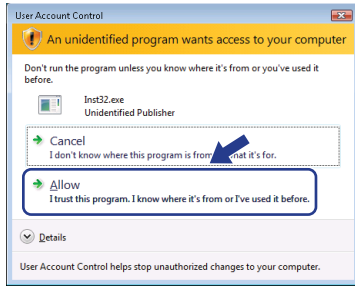

**d** Choose **Wireless Network Connection**, and then click **Next**.

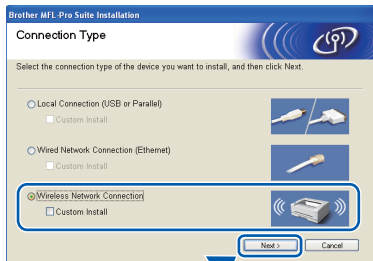

## Note

If you want to install the PS driver (Brother's BR-Script Driver), choose **Custom Install** and then follow the on-screen instructions. When the **Select Features** screen appears, check **PS Printer Driver**, and then continue following the on-screen instructions.

**e** Click on **Wireless settings checked and confirmed** check box, and then click **Next**.

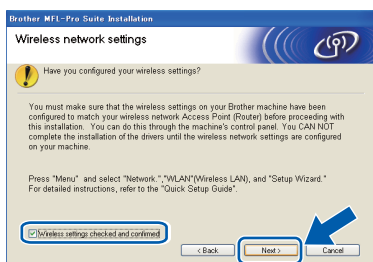

**f**

When the ScanSoft™ PaperPort™ 11SE **License Agreement** window appears, click **Yes** if you agree to the Software **License Agreement**.

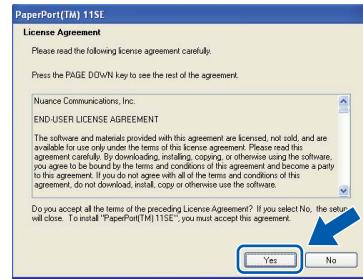

**g**

The installation of ScanSoft™ PaperPort™ 11SE will automatically start and is followed by the installation of MFL-Pro Suite.

**h**

When the Brother MFL-Pro Suite Software **License Agreement** window appears, click **Yes** if you agree to the Software **License Agreement**.

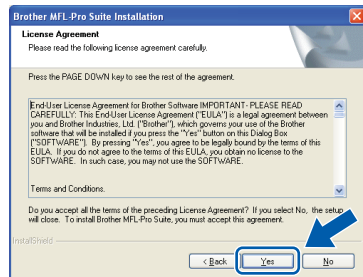

**i**

For Windows® XP SP2/XP Professional x64 Edition/ Windows Vista® users, when this screen appears, choose **Change the Firewall port settings to enable network connection and continue with the installation. (Recommended)** and click **Next**.

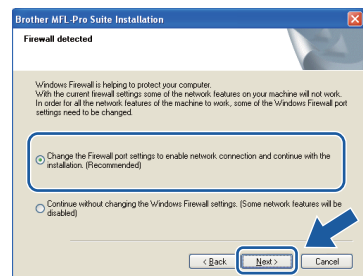

If you are not using the Windows® Firewall, see the User's Guide for your software for information on how to add the following network ports.

- For network scanning, add UDP port 54925.
- For network PC-Fax receiving, add UDP port 54926.
- If you still have trouble with your network connection, add UDP port 137.



**j** If the machine is configured for your network, choose the machine from the list, and then click **Next**.

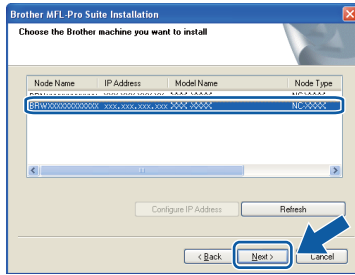

### Note

- You can find your machine's IP address and the node name by printing out the Network Configuration List. See Print the Network Configuration List on page 45.
- If your wireless settings fail, an error message will appear during the installation of MFL-Pro Suite and the installation will be terminated. Confirm your network setting by following the on-screen instruction. If you encounter this failure, please go to step 17 on page 32 and setup the wireless connection again.



- If you are using WEP and the LCD displayed 'Connected' but your machine is not found, make sure you entered the WEP key correctly. The WEP key is case sensitive.
- If the machine is not yet configured for use on your network, the following screen appears.



Click **OK** and then **Configure IP Address**. Enter an IP address for your machine that is suitable for your network by following the on-screen instructions.

**k** If you do not want to monitor the machine status and error notifications from your computer, uncheck **Enable Status Monitor** and then click **Next**.

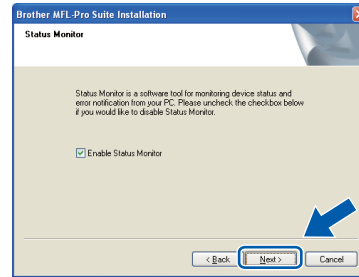

The installation of the Brother drivers will automatically start. The installation screens appear one after another.

### IMPORTANT

**DO NOT** cancel any of the screens during the installation. It may take a few seconds for all screens to appear.



### Note

For Windows Vista®, when this screen appears, click the check box and click **Install** to complete the installation correctly.



**m** When the **On-Line Registration** screen is displayed, make your selection and follow the on-screen instructions. Once you have completed the registration process, close your web browser to return to this window. Then click **Next**.

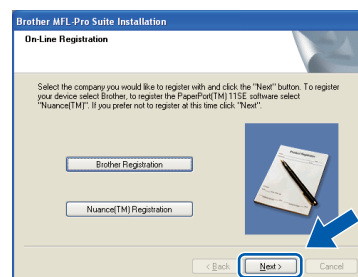



## 21 Finish and restart

- a** Click **Finish** to restart your computer. After restarting the computer, you must be logged on with Administrator rights.

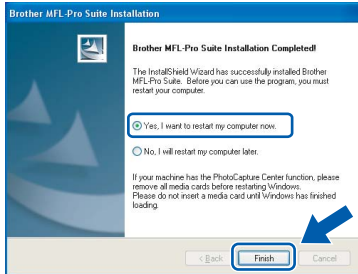

### Note

If an error message appears during the software installation, run the **Installation Diagnostics** located in **Start/All Programs/Brother/MFC-XXXX LAN** (where MFC-XXXX is your model name).

- b** If this screen appears, choose the firmware update setting and click **OK**.

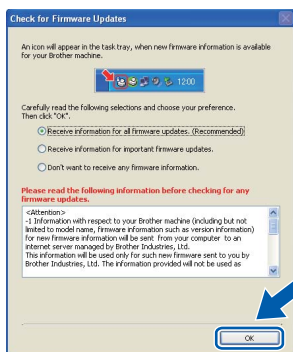

### Note

Internet access is required for the firmware upgrade.

## 22 Install MFL-Pro Suite on additional computers (If needed)

If you want to use your machine with multiple computers on the network, install MFL-Pro Suite on each computer. Go to step **19** on page 37.

### Note

The MFL-Pro Suite Software License permits installation on up to 5 network computers. If you want to install MFL-Pro Suite on additional computers, you can purchase additional NL-5 (five user) license agreements from your authorized Brother dealer or contact Brother customer service.

## Finish

The installation is now complete.

### Note

#### XML Paper Specification Printer Driver

The XML Paper Specification Printer Driver is the most suitable driver when printing from the applications that use the XML Paper Specification documents. Please download the latest driver by accessing the Brother Solutions Center at <http://solutions.brother.com/>.





## Install the Drivers & Software (Mac OS® X 10.3.9 or greater)

### 19 Before you install MFL-Pro Suite

- a Make sure your machine is connected to the power and your Macintosh® is ON. You must be logged on with Administrator rights.

#### ! IMPORTANT

Make sure a USB Flash memory device is not inserted into the machine.

### 20 Install MFL-Pro Suite

- a Put the supplied CD-ROM into your CD-ROM drive.

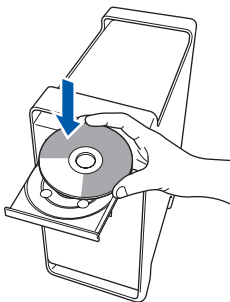

- b Double-click **Start Here OSX** to install.

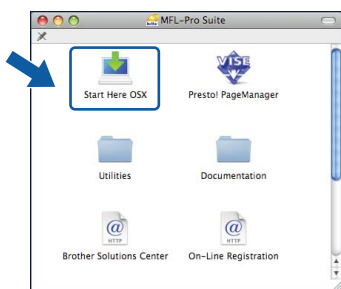

#### Note

Please see the Network User's Guide on the CD-ROM if you want to install the PS driver. (Brother's BR-Script Driver)

- c Choose **Wireless Network Connection**, and then click **Next**.

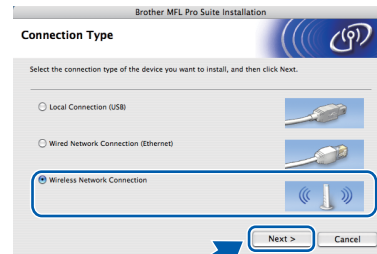

- d Click on the **Wireless settings checked and confirmed** check box, and then click **Next**. Follow the on-screen instructions.

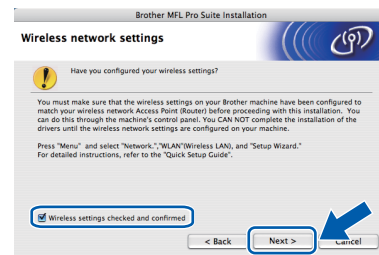

#### Note

Please wait, it will take a few seconds for the software to install. After the installation, click **Restart** to finish installing the software.

- e The Brother software will search for the Brother device. During this time the following screen will appear.

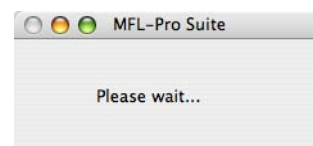

- f If the machine is configured for your network, choose the machine from the list, and then click **OK**.

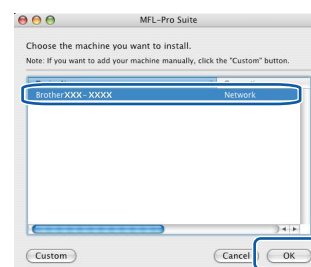



## Note

- You can find your machine's IP address and the node name by printing out the Network Configuration List. See Print the Network Configuration List on page 45.
- If your wireless settings fail, the installation of the MFL-Pro software will be terminated. Confirm your network settings. If you encounter this failure, go to step 17 on page 32 and setup the wireless connection again.
- If this screen appears click **OK**.



- Enter a name for your Macintosh® in **Display Name** up to 15 characters long and click **OK**. Go to step g.

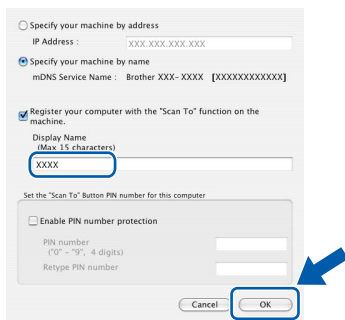

- If you want to use the machine's **Scan** key to scan over the network, you must check the **Register your computer with the "Scan To" function on the machine box**.
- The name you enter will appear on the machine's LCD when you press and choose a scan option. (For more information, see Network Scanning in the Software User's Guide on the CD-ROM.)

- g** When this screen appears, click **OK**.

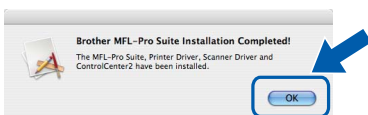

**The installation of MFL-Pro Suite is now complete.**  
Go to step 21 on page 42.

## 21 Install Presto! PageManager

When Presto! PageManager is installed OCR capability is added to Brother ControlCenter2. You can easily scan, share and organize photos and documents using Presto! PageManager.

- a** Double-click **Presto! PageManager** and follow the on-screen instructions.

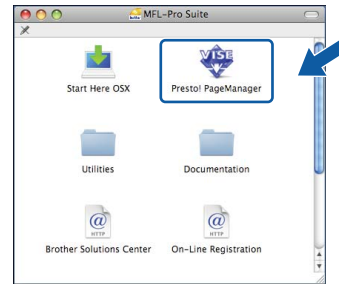

## 22 Install MFL-Pro Suite on additional computers (If needed)

If you want to use your machine with multiple computers on the network, install MFL-Pro Suite on each computer. Go to step 19 on page 41.



**The installation is now complete.**

## BRAdmin Light utility (For Windows® users)

BRAdmin Light is a utility for initial setup of Brother network connected devices. It also can search for Brother products on your network, view the status and configure basic network settings, such as IP address. For more information on BRAdmin Light, visit us at <http://solutions.brother.com/>.

### Note

If you require more advanced printer management, use the latest Brother BRAdmin Professional utility version that is available as a download from <http://solutions.brother.com/>.

## Install the BRAdmin Light configuration utility

- a** Click **Network Utilities** on the menu screen.



- b** Click **BRAdmin Light** and follow the on-screen instructions.



## Set your IP address, Subnet Mask and Gateway using BRAdmin Light

### Note

If you have a DHCP/BOOTP/RARP server in your network, you do not have to do the following operation. The machine will automatically obtain its own IP address.

- a** Start BRAdmin Light. It will search for new devices automatically.

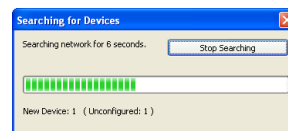

- b** Double-click the unconfigured device.

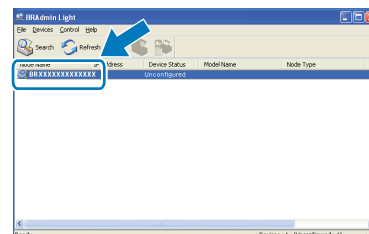

### Note

The default password for the machine is 'access'. You can use BRAdmin Light to change this password.

- c** Choose **STATIC** for the **Boot Method**. Enter the **IP Address**, **Subnet Mask** and **Gateway**, and then click **OK**.

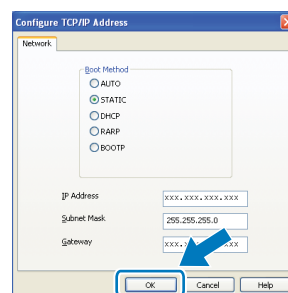

- d** The address information will be saved to the machine.

## BRAdmin Light utility (For Mac OS® X users)

BRAdmin Light is a utility for initial setup of Brother network connected devices. It also can search for Brother products on your network, view the status and configure basic network settings, such as IP address from a computer running Mac OS® X 10.3.9 or greater.

The BRAdmin Light software will be installed automatically when you install the printer driver. If you have already installed the printer driver, you do not have to install BRAdmin Light again. For more information on BRAdmin Light, visit us at <http://solutions.brother.com/>.

### Set your IP address, Subnet Mask and Gateway using BRAdmin Light

#### Note

- If you have a DHCP/BOOTP/RARP server in your network, you do not have to do the following operation. The machine will automatically obtain its own IP address.
- Make sure that version 1.4.2 or greater of Java client software is installed on your computer.
- The default password for the machine is 'access'. You can use BRAdmin Light to change this password.

- a** Double-click **Macintosh HD** on your desktop.

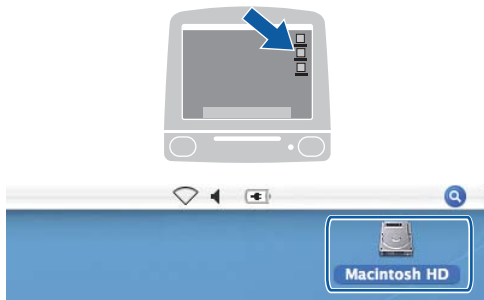

- b** Choose **Library**, **Printers**, **Brother** and then **Utilities**.

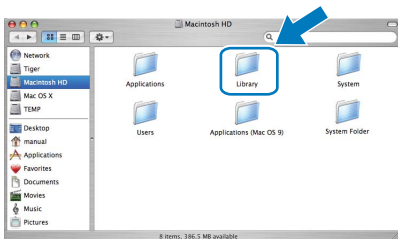

- c** Double-click the file **BRAdmin Light.jar** and run the software. BRAdmin Light will then search for new devices automatically.

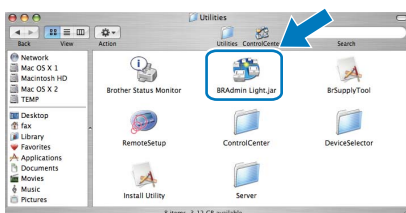

- d** Double-click the unconfigured device.

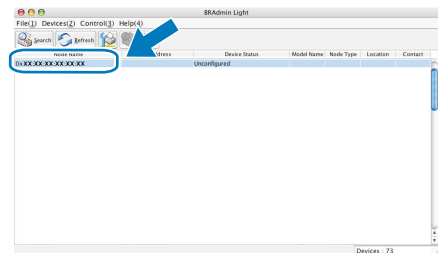

- e** Choose **STATIC** for **Boot Method**. Enter the **IP Address**, **Subnet Mask** and **Gateway**, and then click **OK**.

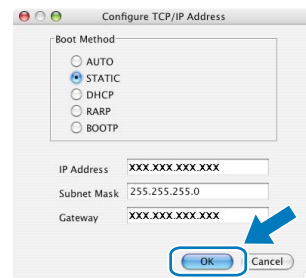

- f** The address information will be saved to the machine.

## Web Based Management (web browser)

The Brother print server is equipped with a web server that allows you to monitor its status or change some of its configuration settings, using HTTP (Hyper Text Transfer Protocol).

### Note

- The User Name is '**admin**' and the default password is '**access**'. You can use a web browser to change this password.
- We recommend Microsoft® Internet Explorer 6.0® (or higher) or Firefox 1.0 (or higher) for Windows® and Safari 1.3 for Macintosh®. Please also make sure that JavaScript and cookies are always enabled in whichever browser you use. To use a web browser, you will need to know the IP address of the print server. The IP address of the print server is listed on the Network Configuration List.

- a Open your browser.
- b Type `http:// printer_ip_address /` into your browser (Where "printer\_ip\_address" is the IP address of the printer or the print server name).  
You can find the IP address of the machine on the Network Configuration List. See *Print the Network Configuration List* on page 45.  
■ For example `http://192.168.1.2/`

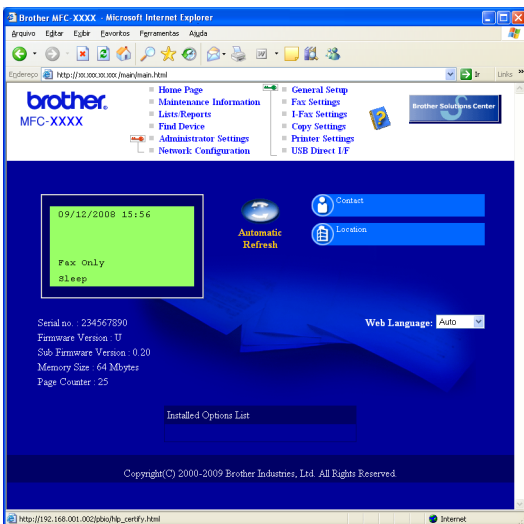

See Chapter 11 of *the Network User's Guide*.

## Print the Network Configuration List

You can print the Network Configuration List to confirm the current network settings. To print the Network Configuration List:

- a Make sure that the front cover is closed and the AC power cord is plugged in.
- b Turn on the machine and wait until the machine is in the Ready state.
- c Press **Menu, 6, 6**.
- d Press **Start**.  
The machine will print the current network settings.

## Restore the network settings to factory default

To restore all network settings of the internal Print/Scan server to factory default, please follow the steps below.

- a Make sure the machine is not operating, then disconnect all the cables from the machine (except the power cord).
- b Press **Menu, 7, 0**.
- c Press **1** to choose **Reset**.
- d Press **1** to choose **Yes**.
- e The machine will restart, re-connect cables once this is complete.

## Entering Text for Wireless Settings

Most number keys have three or four letters printed on them. The keys for **0**, **#** and **\*** do not have printed letters because they are used for special characters.

By pressing the correct number key repeatedly, you can access the character you want.



### For configuring wireless network settings

Press Key	One time	Two times	Three times	Four times	Five times	Six times	Seven times	Eight times
2	a	b	c	A	B	C	2	a
3	d	e	f	D	E	F	3	d
4	g	h	i	G	H	I	4	g
5	j	k	l	J	K	L	5	j
6	m	n	o	M	N	O	6	m
7	p	q	r	s	P	Q	R	S
8	t	u	v	T	U	V	8	t
9	w	x	y	z	W	X	Y	Z

### Putting spaces

To enter a space in a name, press  twice between characters.

### Making corrections

If you entered a letter incorrectly and want to change it, press  or  to move the cursor under the incorrect character, press **Clear/Back**. Re-enter the correct character. You can also back up and insert letters.

### Repeating letters

If you need to enter a letter that is on the same key as the letter before, press  to move the cursor right before you press the key again.

### Special characters and symbols

Press **\***, **#** or **0** repeatedly until you see the special character or symbol you want. Press **OK** to choose it.

Press **\*** for (space)! " # \$ % & ' ( ) \* + , - . /

Press **#** for ; < = > ? @ [ ] ^ \_ \ ~ ' | { }

Press **0** for 0 \ { | } ~

# Options and Consumables

## Options

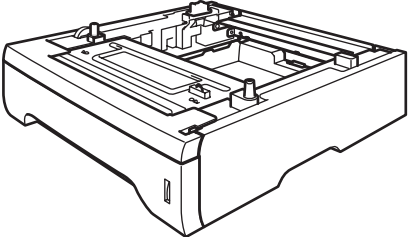
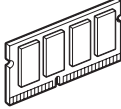
Lower Tray Unit	SO-DIMM Memory
LT-5300	
 <p data-bbox="100 611 671 734">Second lower paper tray unit can hold up to 250 sheets of paper. When the tray is installed, the machine expands total input capacity up to 550 sheets.</p>	 <p data-bbox="746 611 1366 674">You can expand the memory by installing a (144-pin SO-DIMM) memory module.</p>

For more details about the optional Lower Tray Unit and compatible SO-DIMM Memory please see the *User's Guide* or visit <http://solutions.brother.com/>.

## Replacement consumables

When the time comes to replace consumable items, an error message will be indicated on the LCD. For more information about the consumables for your machine, visit <http://www.brother.com/original/> or contact your local Brother re-seller.

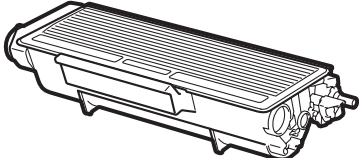
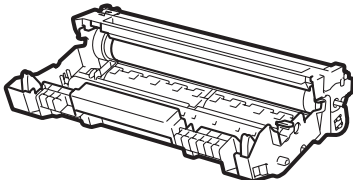
Toner cartridge	Drum unit
TN-3250/TN-3290	DR-3215
	

## **Trademarks**

The Brother logo is a registered trademark of Brother Industries, Ltd.

Brother is a registered trademark of Brother Industries, Ltd.

Multi-Function Link is a registered trademark of Brother International Corporation.

Windows Vista is either a registered trademark or a trademark of Microsoft Corporation in the United States and other countries.

Microsoft, Windows and Windows Server and Internet Explorer are registered trademarks of Microsoft Corporation in the United States and/or other countries.

Apple, Macintosh, Safari and TrueType are trademarks of Apple Inc., registered in the United States and other countries.

Nuance, the Nuance logo, PaperPort and ScanSoft are trademarks or registered trademarks of Nuance Communications, Inc. or its affiliates in the United States and/or other countries.

BROADCOM, SecureEasySetup and the SecureEasySetup logo are trademarks or registered trademarks of Broadcom Corporation in the United States and/or other countries.

AOSS is a trademark of Buffalo Inc.

Wi-Fi, WPA, WPA2, Wi-Fi Protected Access and Wi-Fi Protected Setup are either trademarks or registered trademarks of Wi-Fi Alliance in the United States and/or other countries.

Each company whose software title is mentioned in this manual has a Software License Agreement specific to its proprietary programs.

**All other brand and product names mentioned in this manual are trademarks or registered trademarks of their respective companies.**

## **Compilation and Publication**

Under the supervision of Brother Industries, Ltd., this manual has been compiled and published, covering the latest product descriptions and specifications.

The contents of this manual and the specifications of this product are subject to change without notice.

Brother reserves the right to make changes without notice in the specifications and materials contained herein and shall not be responsible for any damages (including consequential) caused by reliance on the materials presented, including but not limited to typographical and other errors relating to the publication.

## **Copyright and License**

©2009 Brother Industries, Ltd.

This product includes software developed by the following vendors:

©1983-1998 PACIFIC SOFTWARES, INC.

This product includes the "KASAGO TCP/IP" software developed by ELMIC WESCOM, Inc.

©2009 Devicescape Software, Inc.