

brother®

Computerized Sewing and Embroidery Machine

Operation Manual

Product Code:882-S85

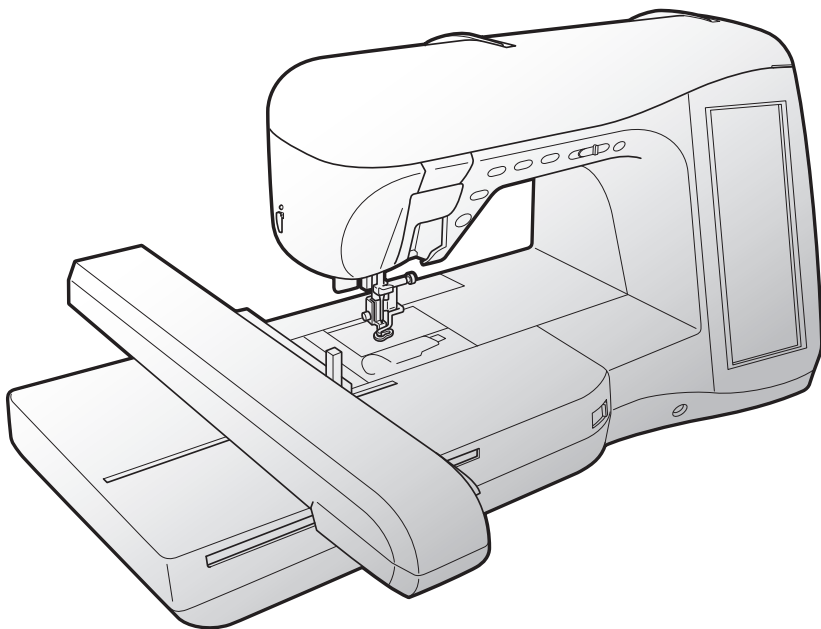

Getting Ready

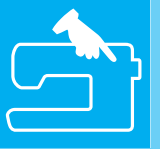

Sewing Basics



Utility Stitches



Character/
Decorative Stitches



Embroidery



Embroidery Edit



My Custom Stitch



Appendix



Please visit us at <http://solutions.brother.com> when you can get product support and answers to frequently asked questions (FAQs).

IMPORTANT SAFETY INSTRUCTIONS

When using this machine, basic safety precautions should always be taken, including the following:
Read all instructions before using.

DANGER - To reduce the risk of electric shock:

1. The machine should never be left unattended while plugged in. Always unplug the machine from the electrical outlet immediately after using and before cleaning.

WARNING - To reduce the risk of burns, fire, electric shock, or injury to persons:

1. Do not allow this machine to be used as a toy. Close attention is necessary when the machine is used by or near children.
2. Use this machine only for its intended use as described in this manual. Use only accessories recommended by the manufacturer as contained in this manual.
3. Never operate this machine if it has a damaged cord or plug, if it is not working properly, if it has been dropped or damaged, or dropped into water. Return the machine to the nearest authorized dealer or service center for examination, repair, electrical or mechanical adjustment.
4. Never operate the machine with any air openings blocked. Keep ventilation openings of the machine and foot control free from the accumulation of lint, dust, and loose cloth.
5. Never drop or insert any object into any opening.
6. Do not use outdoors.
7. Do not operate where aerosol (spray) products are being used or where oxygen is being administered.
8. To disconnect, turn the main switch to the symbol "○" position which represents off, then remove plug from outlet.
9. Do not unplug by pulling on cord. To unplug, grasp the plug, not the cord.
10. Keep fingers away from all moving parts. Special care is required around the machine needle.
11. Always use the proper needle plate. The wrong plate can cause the needle to break.
12. Do not use bent needles.
13. Do not pull or push fabric while stitching. It may deflect the needle causing it to break.
14. Switch the machine to the symbol "○" position when making any adjustments in the needle area.
15. Always unplug the machine from the electrical outlet when removing covers, lubricating, or when making any other user servicing adjustments mentioned in the instruction manual.
16. This sewing machine is not intended for use by young children or infirm persons without supervision.
17. Young children should be supervised to ensure that they do not play with this machine.
18. If the LED light unit (light-emitting diode) is damaged, it must be replaced by authorized dealer.
19. Hold the foot controller plug when rewinding into cord reel. Do not allow the plug to whip when rewinding.
20. When lifting the sewing machine, be careful not to make any sudden or careless movements, otherwise you may injure your back or knees.
21. When transporting the sewing machine, be sure to carry it by its handle. Lifting the sewing machine by any other part may damage the machine or result in the machine falling, which could cause injuries.

Use this machine only for its intended use as described in this manual.

Use accessories recommended by the manufacturer as contained in this manual.

The contents of this manual and specifications of this product are subject to change without notice.

For additional product information, visit our web site at www.brother.com

SAVE THESE INSTRUCTIONS

This machine is intended for household use.

This appliance is not intended for use by persons (including children) with reduced physical, sensory or mental capabilities, or lack of experience and knowledge, unless they have been given supervision or instruction concerning use of the appliance by a person responsible for their safety. Children should be supervised to ensure that they do not play with the appliance.

FOR USERS IN THE UK, EIRE, MALTA AND CYPRUS ONLY

IMPORTANT

- In the event of replacing the plug fuse, use a fuse approved by ASTA to BS 1362, i.e. carrying the  mark, rating as marked on plug.
- Always replace the fuse cover. Never use plugs with the fuse cover omitted.
- If the available electrical outlet is not suitable for the plug supplied with this equipment, you should contact your authorized dealer to obtain the correct lead.

Federal Communications Commission (FCC)

Declaration of Conformity (For USA Only)

Responsible Party: Brother International Corporation
100 Somerset Corporate Boulevard
Bridgewater, NJ 08807-0911 USA
TEL : (908) 704-1700

declares that the product

Product Name: Brother Sewing Machine
Model Number: NV4750D

This device complies with Part 15 of the FCC Rules. Operation is subject to the following two conditions: (1) this device may not cause harmful interference, and (2) this device must accept any interference received, including interference that may cause undesired operation.

This equipment has been tested and found to comply with the limits for a Class B digital device, pursuant to Part 15 of the FCC Rules. These limits are designed to provide reasonable protection against harmful interference in a residential installation. This equipment generates, uses, and can radiate radio frequency energy and, if not installed and used in accordance with the instructions, may cause harmful interference to radio communications. However, there is no guarantee that interference will not occur in a particular installation. If this equipment does cause harmful interference to radio or television reception, which can be determined by turning the equipment off and on, the user is encouraged to try to correct the interference by one or more of the following measures:

- Reorient or relocate the receiving antenna.
- Increase the separation between the equipment and receiver.
- Connect the equipment into an outlet on a circuit different from that to which the receiver is connected.
- Consult the dealer or an experienced radio/TV technician for help.
- The enclosed interface cable should be used in order to ensure compliance with the limits for a Class B digital device.
- Changes or modifications not expressly approved by Brother Industries, Ltd. could void the user's authority to operate the equipment.

CONGRATULATIONS ON CHOOSING OUR MACHINE

Your machine is the most advanced computerized household embroidery and sewing machine. To fully enjoy all the features incorporated, we suggest that you study the manual.

PLEASE READ BEFORE USING THIS MACHINE

For safe operation

1. Be sure to keep your eye on the needle while sewing. Do not touch the handwheel, thread take-up, needle, or other moving parts.
2. Remember to turn off the power switch and unplug the cord when:
 - Operation is completed
 - Replacing or removing the needle or any other parts
 - A power failure occurs during use
 - Maintaining the machine
 - Leaving the machine unattended.
3. Do not store anything on the foot controller.
4. Plug the machine directly into the wall. Do not use extension cords.
5. Do not place or store the machine near heaters or other hot appliances, in any location exposed to extremely high or low temperatures, high humidity or dusty locations. Doing so could cause the machine to malfunction.
6. Never operate the machine if it has a damaged cord or plug, if it is not working properly, if it has been dropped or damaged, or water is spilled on the unit. Return the machine to the nearest authorized retailer or service center for examination, repair, electrical or mechanical adjustment.
7. The sewing machine plastic bag should be kept out of the reach of children or disposed of. Never allow children to play with plastic bags due to the danger of suffocation.
8. Do not place this sewing machine on an unstable surface, such as an unsteady or slanted table; otherwise the sewing machine may fall, resulting in injuries.

For a longer service life

1. When storing this machine, avoid direct sunlight and high humidity locations. Do not use or store the machine near a space heater, iron, halogen lamp, or other hot objects.
2. Use only neutral soaps or detergents to clean the case. Benzene, thinner, and scouring powders can damage the case and machine, and should never be used.
3. Do not drop or hit the machine.
4. Always consult the operation manual when replacing or installing any assemblies, the presser feet, needle, or other parts to assure correct installation.
5. Use only the interface cable (USB cable) included with this machine.

For repair or adjustment

In the event a malfunction occurs or adjustment is required, first follow the troubleshooting table in the back of the operation manual to inspect and adjust the machine yourself. If the problem persists, please consult your local authorized Brother dealer.

For additional product information and updates, visit our web site at www.brother.com

The contents of this manual, specifications of this product and also design of display are subject to change without notice.



WHAT YOU CAN DO WITH THIS MACHINE

SPECIAL FEATURES



Check operations and view advice on the large LCD (liquid crystal display).



Prepare the bobbin thread with one touch.



The automatic thread tension makes trial sewing unnecessary.



Automatic threading makes threading quick and easy.

Getting Ready

To learn the operation of the principal parts and the screens



Chapter 1
Page 9

Sewing Basics

To learn how to prepare for sewing and basic sewing operations



Chapter 2
Page 43

Utility Stitches

Pre-programmed with more than 100 frequently used stitches



Chapter 3
Page 57

Character/Decorative Stitches

The variety of stitches widen your creativity



Chapter 4
Page 115

Embroidery

Maximum 30 cm x 18 cm (approx. 12 x 7 inches) for large embroidery designs



Chapter 5
Page 143

Embroidery Edit

Designs can be combined, rotated or enlarged



Chapter 6
Page 197

My Custom Stitch

Create original decorative stitches



Chapter 7
Page 225

Appendix

Caring for your machine and dealing with errors and malfunctions



Chapter 8
Page 235

HOW TO USE THIS MANUAL

Chapter 1 and Chapter 2 explain your sewing machine's basic operation procedures for someone who is using the sewing machine for the first time. If you want to sew utility stitches or character/ decorative stitches, read Chapter 1 and Chapter 2, then go on to Chapter 3 (Utility Stitches) or Chapter 4 (Character/ Decorative Stitches).

When you are ready to begin using the embroidery function after reading Chapter 1 and Chapter 2, proceed to Chapter 5 (Embroidery). Once you understand the steps explained in Chapter 5, go on to Chapter 6 (Embroidery Edit) for an explanation about the convenient embroidery edit functions.

In the screens that appear in the step-by-step directions the parts that are used for the operation are shown in . Compare the screen in the directions with the actual screen, and carry out the operation.

If, while using the machine, you experience something you do not understand, or there is a function you would like to know more about, refer to the index at the back of the operation manual in conjunction with the table of contents to find the section of the manual you should refer to.

**To sew utility stitches
To sew character or
decorative stitches**

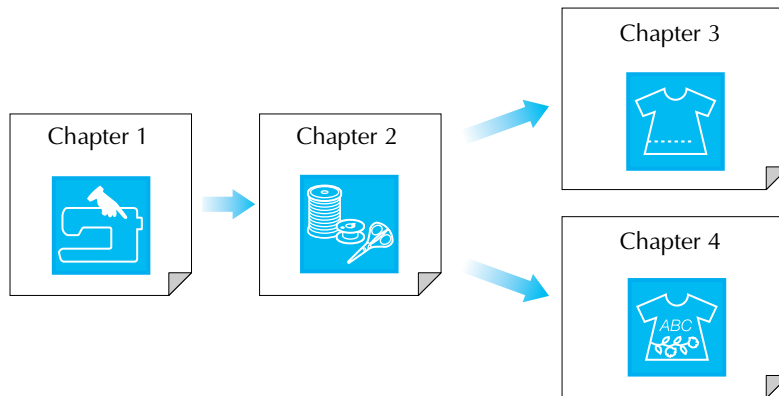

**To do machine
embroidery**

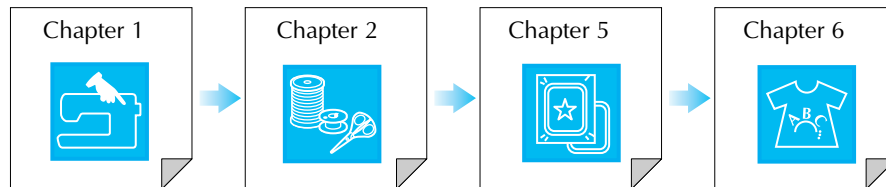

CONTENTS

IMPORTANT SAFETY INSTRUCTIONSi
WHAT YOU CAN DO WITH THIS MACHINE.....vi
HOW TO USE THIS MANUALvii
NAMES OF MACHINE PARTS AND THEIR FUNCTIONS..... 1
 Machine 1
 Needle and Presser Foot Section 2
 Embroidery Unit 3
 Operation Buttons..... 3
 Included Accessories 4
 Options..... 7

Chapter 1 Getting Ready 9

TURNING THE MACHINE ON/OFF10
LCD SCREEN11
 Screens Operations Performed Using a USB Mouse 14
 Using the Machine Setting Mode Key 16
 Using the Machine Operation Mode Key 21
 Using the Pattern Explanation Key 22
LOWER THREADING.....23
 Winding the Bobbin..... 23
 Setting the Bobbin..... 26
 Pulling Up the Bobbin Thread..... 28
UPPER THREADING29
 Threading Using the “Automatic Threading” Button..... 29
 Threading Manually..... 31
 Using the Twin Needle Mode 34
 Using Threads that Unwind Quickly 36
CHANGING THE PRESSER FOOT37
 Removing the Presser Foot 37
 Attaching the Presser Foot..... 37
 Attaching the Walking Foot..... 38
CHANGING THE NEEDLE.....39

Chapter 2 Sewing Basics 43

SEWING44
 Sewing a Stitch 44
 Sewing Reinforcement Stitches 46
 Sewing Curves 46
 Changing Sewing Direction 46
 Sewing Heavyweight Fabrics 47
 Sewing Lightweight Fabrics..... 48
 Sewing Stretch Fabrics..... 48
STITCH SETTINGS.....49
 Setting the Stitch Width..... 49
 Setting the Stitch Length..... 49
 Setting the Thread Tension 50
USEFUL FUNCTIONS.....51
 Automatic Reinforcement Stitching 51
 Automatic Thread Cutting 52
 Pivoting 53
 Automatic Fabric Sensor System (Automatic Presser Foot Pressure) 55
 Locking the Screen..... 55

Chapter 3 Utility Stitches 57

SELECTING UTILITY STITCHES.....58
 Saving Your Stitch Settings 60
 Using the Sewing Type Selection Key 61
SEWING THE STITCHES.....63
 Straight Stitches..... 63
 Dart Seam..... 67
 Gathering..... 68
 Flat Fell Seam 69
 Pintuck 69
 Zigzag Stitches..... 71

Elastic Zigzag Stitches 73
 Overcasting 74
 Quilting..... 79
 Blind Hem Stitches 89
 Appliqué 90
 Shelltuck Stitches 91
 Scallop Stitches 92
 Top Stitching 92
 Smocking Stitches 93
 Fagoting 93
 Tape or Elastic Attaching 94
 Heirloom..... 95
 One-step Buttonholes..... 97
 Four-step Buttonholes..... 101
 Bar Tacks 105
 Button Sewing..... 107
 Eyelet 109
 Multi-directional Sewing (Straight Stitch and Zigzag Stitch) 110
 Zipper Insertion..... 111

Chapter 4 Character/Decorative Stitches 115

SELECTING STITCH PATTERNS..... 116
 Selecting Decorative Stitch Patterns/7mm Decorative Stitch Patterns/Satin Stitch Patterns/7mm Satin Stitch Patterns/ Cross Stitch/Utility Decorative Stitch Patterns 118
 Alphabet Characters 118
SEWING STITCH PATTERNS 120
 Sewing Attractive Finishes 120
 Basic Sewing 120
 Making Adjustments 121
EDITING STITCH PATTERNS..... 123
 Changing the Size 124
 Changing the Length (for 7mm Satin Stitch Patterns Only) ... 125
 Creating a Vertical Mirror Image 125
 Creating a Horizontal Mirror Image..... 125
 Sewing a Pattern Continuously 125
 Changing Thread Density (for Satin Stitch Patterns Only)..... 126
 Checking the Image..... 127
COMBINING STITCH PATTERNS..... 128
 Before Combining 128
 Combining Various Stitch Patterns..... 128
 Combining Large and Small Stitch Patterns..... 130
 Combining Horizontal Mirror Image Stitch Patterns..... 130
 Combining Stitch Patterns of Different Length 131
 Making Step Stitch Patterns (for 7mm Satin Stitch Patterns Only) 132
USING THE MEMORY FUNCTION 134
 Stitch Data Precautions 134
 Saving Stitch Patterns in the Machine’s Memory..... 136
 Saving Stitch Patterns to USB Media (Commercially Available) 138
 Saving Stitch Patterns in the Computer 139
 Retrieving Stitch Patterns from the Machine’s Memory 140
 Recalling from USB Media 141
 Recalling from the Computer..... 142

Chapter 5 Embroidery 143

BEFORE EMBROIDERING..... 144
 Embroidery Step by Step..... 144
 Attaching Embroidery Foot “W” 145
 Attaching the Embroidery Unit 146

SELECTING PATTERNS.....149
 Selecting Embroidery Patterns/Heirloom Patterns/Border Patterns/Cross stitch Patterns/Floral alphabet Patterns 151
 Selecting Alphabet Character Patterns 152
 Selecting Frame Patterns..... 153
 Selecting Patterns from Embroidery Cards 154
 Selecting Patterns from USB media/Computer 154

VIEWING THE SEWING SCREEN.....155

PREPARING THE FABRIC.....157
 Attaching Iron-on Stabilizers (backing) to the Fabric..... 157
 Hooping the Fabric in the Embroidery Frame 158
 Embroidering Small Fabrics or Fabric Edges 160

ATTACHING THE EMBROIDERY FRAME.....162

CONFIRMING THE PATTERN POSITION.....163
 Checking the Pattern Position..... 163
 Previewing the Completed Pattern..... 164

SEWING AN EMBROIDERY PATTERN165
 Sewing Attractive Finishes 165
 Sewing Embroidery Patterns 166
 Sewing Embroidery Patterns Which Use Appliqué..... 168

ADJUSTMENTS DURING THE EMBROIDERY PROCESS170
 If the Bobbin Runs Out of Thread 170
 If the Thread Breaks During Sewing..... 171
 Restarting from the Beginning..... 172
 Resuming Embroidery After Turning Off the Power 172

MAKING EMBROIDERY ADJUSTMENTS174
 Adjusting Thread Tension..... 174
 Using the Automatic Thread Cutting Function (END COLOR TRIM) 175
 Using the Thread Trimming Function (JUMP STITCH TRIM) 175
 Adjusting the Embroidery Speed..... 176
 Changing the Thread Color Display..... 177
 Changing the Embroidery Frame Display..... 178

REVISING THE PATTERN179
 Changing the Pattern Position..... 179
 Aligning the Pattern and the Needle 180
 Changing the Size 181
 Rotating the Pattern 182
 Creating a Horizontal Mirror Image..... 183
 Changing the Density (Alphabet Character and Frame Patterns Only) 183
 Changing the Colors of Alphabet Character Patterns..... 184

USING THE MEMORY FUNCTION.....185
 Embroidery Data Precautions 185
 Saving Embroidery Patterns in the Machine’s Memory 187
 Saving Embroidery Patterns to USB Media (Commercially Available) 189
 Saving Embroidery Patterns in the Computer 190
 Retrieving Patterns from the Machine’s Memory..... 191
 Recalling from USB Media 191
 Recalling from the Computer..... 192

EMBROIDERY APPLICATIONS.....194
 Using a Frame Pattern to Make an Appliqué (1)..... 194
 Using a Frame Pattern to Make an Appliqué (2)..... 195

Chapter 6 Embroidery Edit 197

EXPLANATION OF FUNCTIONS198

SELECTING PATTERNS TO EDIT199
 Selecting Embroidery Patterns/Heirloom Patterns/Border Patterns/Cross stitch Patterns/Floral Alphabet Patterns/Frame Patterns 200
 Selecting Alphabet Character Patterns 200

EDITING PATTERNS.....203
 Moving the Pattern 205
 Rotating the Pattern 205
 Changing the Size of the Pattern..... 206
 Deleting the Pattern..... 207
 Changing the Configuration of Alphabet Character Patterns 207

Changing Alphabet Character Spacing..... 207
 Reducing Character Spacing 208
 Changing the Color of Each Alphabet Character in a Pattern 209
 Changing the Thread Color..... 209
 Creating a Custom Thread Table..... 210
 Choosing a Color from the Custom Thread Table..... 212
 Designing Repeated Patterns..... 213
 After Editing 217

COMBINING PATTERNS219
 Editing Combined Patterns..... 219
 Sewing Combined Patterns 222

USING THE MEMORY FUNCTION223

Chapter 7 MY CUSTOM STITCH 225

DESIGNING A STITCH226

ENTERING STITCH DATA228

USING STORED CUSTOM STITCHES.....233
 Storing Custom Stitches in Your List..... 233
 Retrieving Stored Stitches..... 234

Chapter 8 Appendix 235

CARE AND MAINTENANCE236
 About the Maintenance Message 236
 Cleaning the LCD Screen..... 236
 Cleaning the Machine Casing 236
 Cleaning the Race..... 236
 Adjusting the Alternate Bobbin Case (with no marking) 237

ADJUSTING THE SCREEN238
 Screen Visibility is Low 238
 Touch Panel is Malfunctioning 238

TROUBLESHOOTING240

ERROR MESSAGES.....243

SPECIFICATIONS.....249

UPGRADING YOUR MACHINE’S SOFTWARE.....250
 Upgrade Procedure Using USB Media 250
 Upgrade Procedure Using Computer 251

STITCH SETTING CHART253

Index.....260



NAMES OF MACHINE PARTS AND THEIR FUNCTIONS

The names of the various parts of the sewing machine and their functions are described below. Before using the sewing machine, carefully read these descriptions to learn the names of the machine parts.

Machine

■ Front View

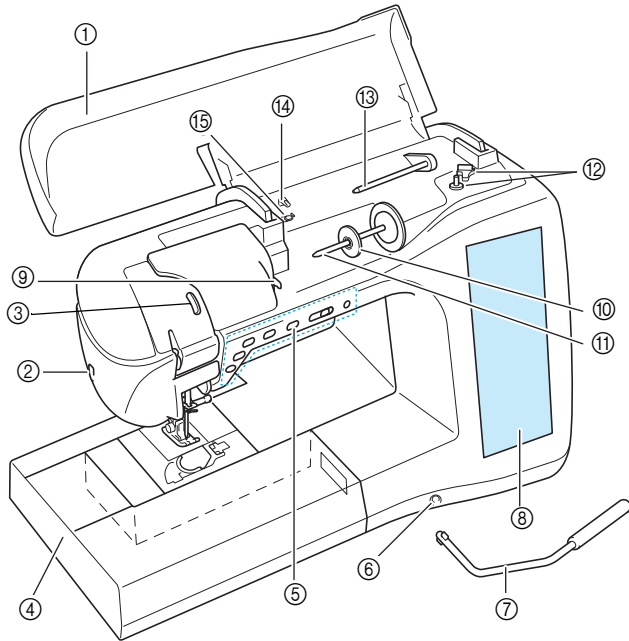

- ① **Top cover**
Open the top cover to thread the machine and wind the bobbin.
- ② **Thread cutter**
Pass the threads through the thread cutter to cut them.
- ③ **Thread take-up lever check window**
Look through the window to check the upper thread passing through in it.
- ④ **Flat bed attachment with accessory compartment**
Store presser feet and bobbins in the accessory compartment of the flat bed attachment. When sewing cylindrical pieces, remove the flat bed attachment.
- ⑤ **Operation buttons (6 buttons) and sewing speed controller**
Use these buttons and the slide to operate the sewing machine.
- ⑥ **Knee lifter slot**
Insert the knee lifter into the slot.
- ⑦ **Knee lifter**
Use the knee lifter to raise and lower the presser foot.
- ⑧ **LCD (liquid crystal display)**
Settings for the selected stitch and error messages appear in the LCD.
- ⑨ **Thread guide plate**
Pass the thread around the thread guide plate when threading upper thread.
- ⑩ **Spool cap**
Use the spool cap to hold the spool in place.
- ⑪ **Spool pin**
Place a spool of thread on the spool pin.
- ⑫ **Bobbin winder**
Use the bobbin winder when winding the bobbin.
- ⑬ **Supplemental spool pin**
Use this spool pin to wind the bobbin thread, or to sew with the twin needle.
- ⑭ **Thread guide for bobbin winding**
Pass the thread around this thread guide when winding the bobbin thread.
- ⑮ **Pretension disk**
Pass the thread around the pretension disk when winding the bobbin thread.

■ Right-side/Rear View

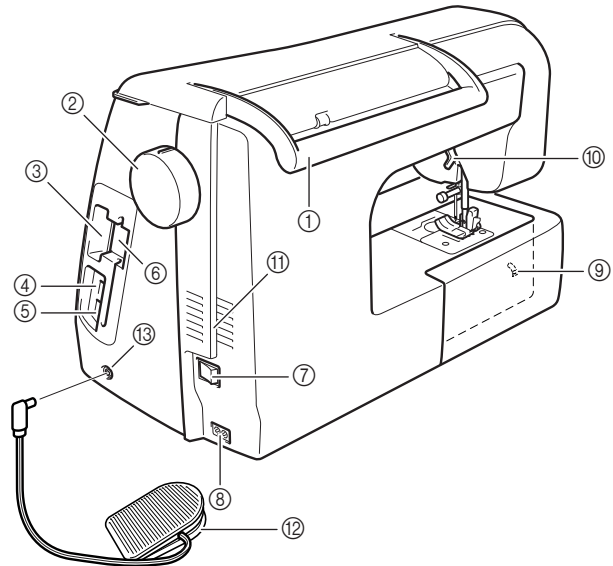

- ① **Handle**
Carry the sewing machine by its handle when transporting the machine.
- ② **Handwheel**
Turn the handwheel toward you to raise and lower the needle. The wheel should be turned toward the front of the machine.
- ③ **Embroidery card slot**
Insert the embroidery cards (sold separately) into the embroidery card slot.
- ④ **USB port connector for media**
In order to send patterns from/to USB media, plug the USB media directly into the USB port connector.
- ⑤ **USB port connector for computer**
In order to import/export patterns between a computer and the machine, plug the USB cable into the USB port connector.
- ⑥ **Touch pen holder**
Use the touch pen holder to hold the touch pen when not in use.
- ⑦ **Main power switch**
Use the main power switch to turn the sewing machine ON and OFF.
- ⑧ **Power cord receptacle**
Insert the power cord into the machine receptacle.
- ⑨ **Feed dog position switch**
Use the feed dog position switch to lower the feed dogs.
- ⑩ **Presser foot lever**
Raise and lower the presser foot lever to raise and lower the presser foot.
- ⑪ **Air vent**
The air vent allows the air surrounding the motor to circulate. Do not cover the air vent while the sewing machine is being used.
- ⑫ **Foot controller with retractable cord**
Depress the foot controller to control the speed of the machine.
- ⑬ **Foot controller jack**
Insert the foot controller plug into its jack on the machine.

Needle and Presser Foot Section

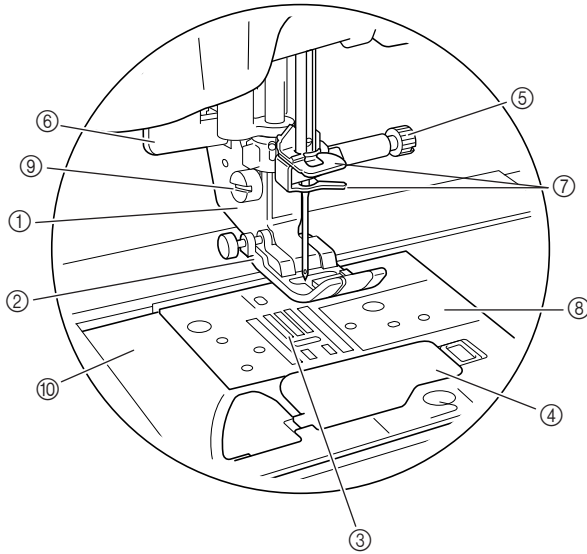

- ① **Presser foot holder**
The presser foot is attached onto the presser foot holder.
- ② **Presser foot**
The presser foot applies pressure consistently on the fabric as sewing takes place. Attach the appropriate presser foot for the selected stitch.
- ③ **Feed dogs**
The feed dogs feed the fabric in the sewing direction.
- ④ **Bobbin cover**
Open the bobbin cover to set the bobbin.
- ⑤ **Needle clamp screw**
Use the needle clamp screw to hold the needle in place.
- ⑥ **Buttonhole lever**
The buttonhole lever is used with the one-step buttonhole foot to create buttonholes.
- ⑦ **Needle bar thread guides**
Pass the upper thread through the two needle bar thread guides.
- ⑧ **Needle plate**
The needle plate is marked with guides to help sew straight seams.
- ⑨ **Presser foot holder screw**
Use the presser foot holder screw to hold the presser foot in place.
- ⑩ **Needle plate cover**
Remove the needle plate cover to clean the race.

Measurements on the needle plate, bobbin cover and needle plate cover

The measurements on the bobbin cover are references for patterns with a middle (center) needle position. The measurements on the needle plate and the needle plate cover are references for stitches with a left needle position.

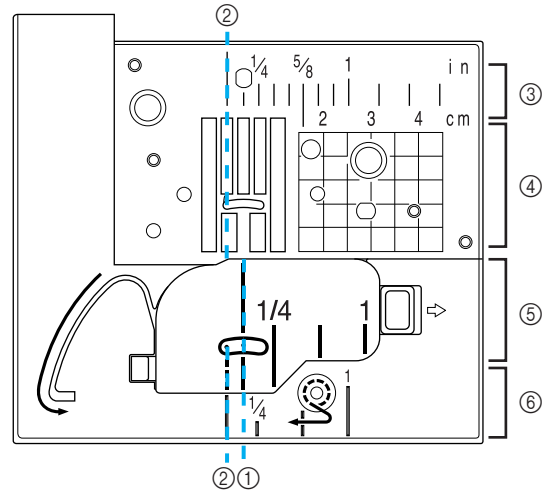

- ① For stitches with a middle (center) needle position
- ② For stitches with a left needle position
- ③ Left needle position on the needle plate <inch>
- ④ Left needle position on the needle plate <cm>
- ⑤ Middle (center) needle position on the bobbin cover <inch>
- ⑥ Left needle position on the needle plate cover <inch>

Embroidery Unit

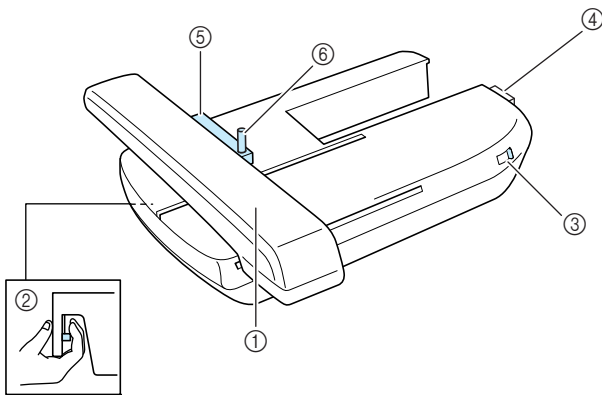

- ① **Carriage**
The carriage moves the embroidery frame automatically when embroidering.
- ② **Release button (located under the embroidery unit)**
Press the release button to remove the embroidery unit.
- ③ **Feed dog position switch**
Use the feed dog position switch to raise and lower the feed dogs while the embroidery unit is attached.
- ④ **Embroidery unit connection**
Insert the embroidery unit connection into the connection port when attaching the embroidery unit.
- ⑤ **Embroidery frame holder**
Insert the embroidery frame into the embroidery frame holder to hold the frame in place.
- ⑥ **Frame-securing lever**
Press the frame-securing lever down to secure the embroidery frame.

! CAUTION



- After the embroidery frame is set in the frame holder, be sure the frame-securing lever is correctly lowered.





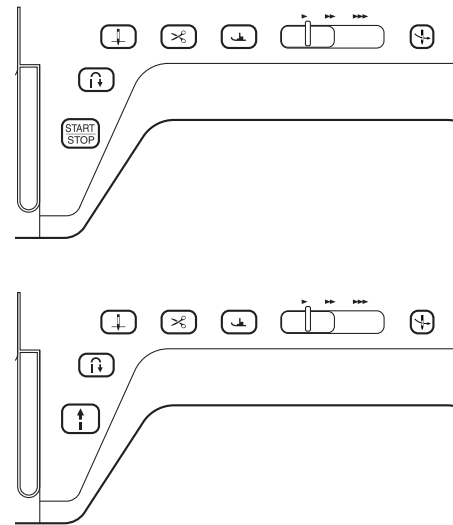

Note

- Be sure that the feed dog position switch on the embroidery unit is located at right when embroidering.
- You can also sew utility/decorative stitches with the embroidery unit attached. Set the feed dog position switch on the embroidery unit to the appropriate setting.

Operation Buttons



- ① **“Start/Stop” button**  
Press this button and the machine will sew a few stitches at a slow speed and then begin sewing at the speed set by the sewing speed controller. Press the button again to stop the machine. Hold the button in to sew at the machine's slowest speed. The button changes color according to the machine's operation mode.

Green: the machine is ready to sew or is sewing.
Red: the machine cannot sew.
- ② **“Reverse/Reinforcement Stitch” button** 
Use this button to sew reinforcement stitches at the beginning and end of sewing. Press this button, and the machine sews 3 stitches in the same spot and stops automatically. For straight and zigzag stitch patterns that take reverse stitches, the machine will sew reverse stitches at low speed only while holding down the “Reverse/Reinforcement Stitch” button (the stitches are sewn in the opposite direction).
- ③ **“Needle Position” button** 
Use this button when changing sewing direction or for detailed sewing in small areas. Press this button to raise or lower the needle position. Press the button twice to sew a single stitch.
- ④ **“Thread Cutter” button** 
Press this button after sewing to automatically trim the excess thread.
- ⑤ **“Presser Foot Lifter” button** 
Press this button to lower the presser foot and apply pressure to the fabric. Press this button again to raise the presser foot.
- ⑥ **Sewing Speed controller** 
Use this controller to adjust the sewing speed. Move the slide to the left to sew at slower speeds. Move the slide to the right to sew at higher speeds. Beginners should sew at a slow speed.
- ⑦ **“Automatic Threading” button** 
Use this button to automatically thread the needle.

! CAUTION

- Do not press the thread cutter button after the threads have already been cut. Otherwise, the needle may break, the threads may become tangled, or damage to the machine may occur.

Included Accessories

Pull the top of the flat bed attachment to open the accessory compartment.

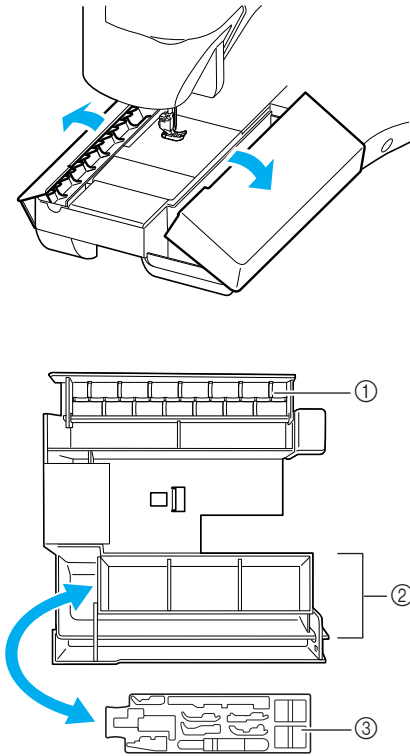

- ① Storage space
- ② Presser foot storage space
- ③ Presser foot storage space

Included Accessories 33-36 are contained in the embroidery unit carrying case. To open the embroidery unit carrying case, raise the lock and move the latch out of position. To re-hook the latches and securely close the case, position the latch on the catch of the unit lid and lower the lock till it snaps.

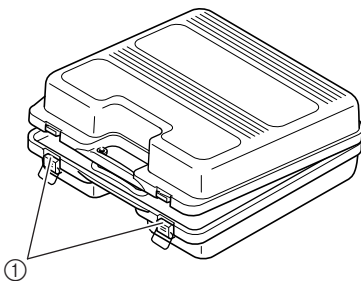

- ① Latches

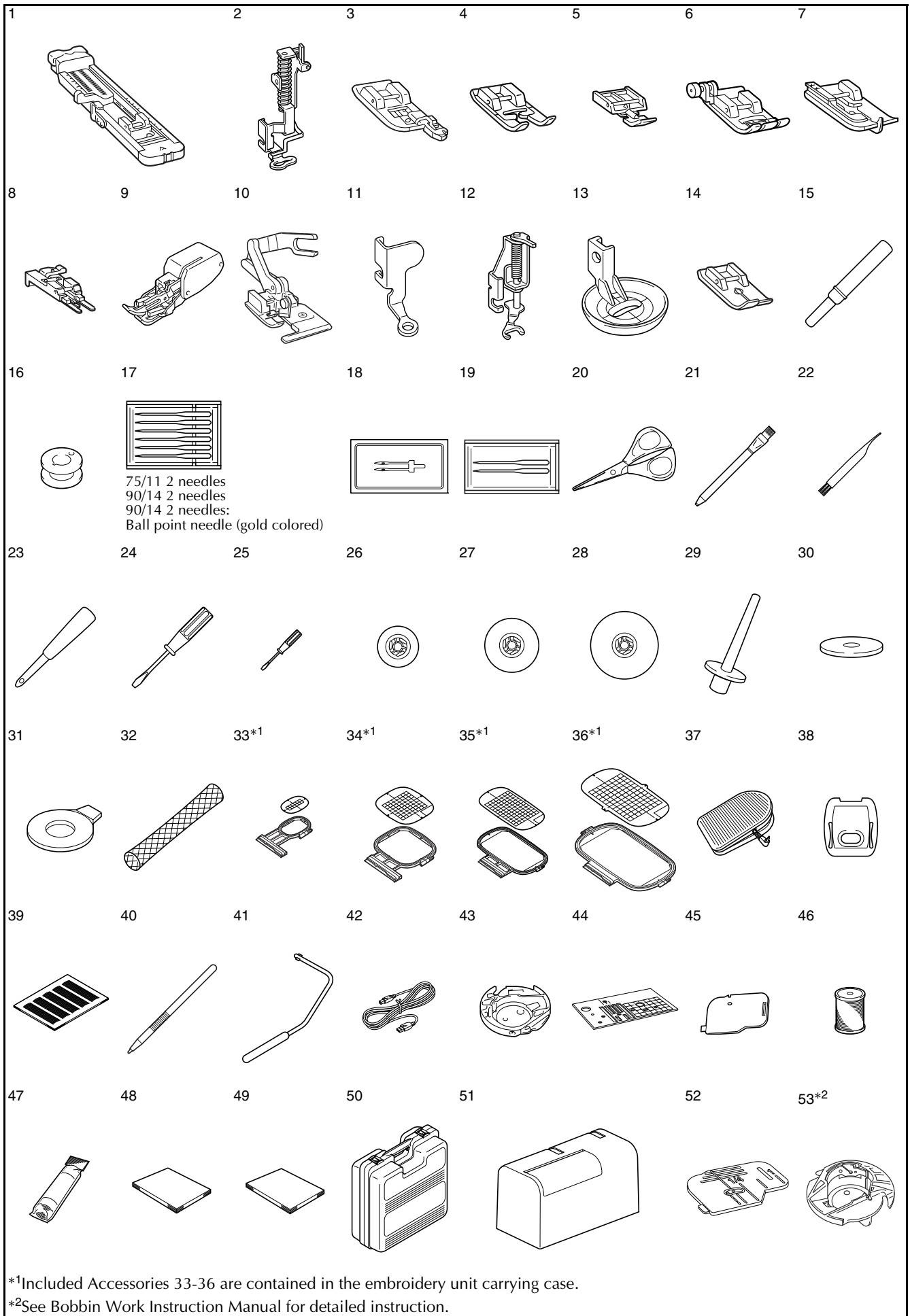

*1Included Accessories 33-36 are contained in the embroidery unit carrying case.

*2See Bobbin Work Instruction Manual for detailed instruction.

No.	Part Name	Part Code	
		U.S.A./ Canada	Others
1	Buttonhole foot "A"		X57789-251
2	Embroidery foot "W"		XC8156-651
3	Overcasting foot "G"		XC3098-051
4	Monogramming foot "N"		X53840-351
5	Zipper foot "I"		X59370-051
6	Zigzag foot "J" (on machine)		XC3021-051
7	Blind stitch foot "R"		X56409-051
8	Button fitting foot "M"		130489-001
9	Walking foot	SA140	F033N:X81125-001
10	Side cutter foot	SA177	F054:XC3198-101
11	Free-motion quilting foot "C"		XE0765-101
12	Free-motion open toe quilting foot "O"		XE0767-001
13	Free-motion echo quilting foot "E"		XE0766-001
14	Straight stitch foot	SA167	F042N:XC1973-102
15	Seam ripper		X54243-151
16	Bobbin × 10 (One is on machine)	SA156	SFB
17	Needle set		X58358-051
18	Twin needle		X59296-151
19	Ball point needle set		XD0705-051
20	Scissors		XC1807-121
21	Chalk pen		XE8568-001
22	Cleaning brush		X59476-051
23	Eyelet punch		135793-001
24	Screwdriver (large)		XC8349-021
25	Screwdriver (small)		X55468-021
26	Spool cap (small)		130013-154
27	Spool cap (medium) × 2		X55260-153
28	Spool cap (large)		130012-054
29	Vertical spool pin		XC8619-051
30	Spool felt		X57045-051
31	Disc-shaped screwdriver		XC1074-051
32	Spool net		XA5523-050
33	Embroidery frame set (small) H 2 cm × W 6 cm (H 1 inch × W 2-1/2 inches)	SA437	EF73:XC8479-052
34	Embroidery frame set (medium) H 10 cm × W 10 cm (H 4 inches × W 4 inches)	SA438	FE74:XC8480-052
35	Embroidery frame set (large) H 18 cm × W 13 cm (H 7 inches × W 5 inches)	SA439	EF75:XC8481-052
36	Embroidery frame set (extra large) H 30 cm × W 18 cm (H 12 inches × W 7 inches)	SA440	EF76:XC8482-052
37	Foot controller		XD0500-151 (EU area) XC8028-051 (other area)
38	Embroidery needle plate cover		XD1644-051
39	Grid sheet set	SA507	GS3:X81277-150
40	Touch pen (stylus)		XA9940-051
41	Knee lifter		XA6941-052
42	USB cable		XD0745-051
43	Bobbin case (no marking)		XC8167-551
44	Straight stitch needle plate		XC8362-251
45	Cord guide bobbin cover (with single hole)		XE8991-001
46	Embroidery bobbin thread	SA-EBT	EBT-CEN: X81164-001
47	Stabilizer material	SA519	BM3:X81175-101
48	Operation manual		XF3896-001
49	Quick reference guide		XE2538-201

No.	Part Name	Part Code	
		U.S.A./ Canada	Others
50	Embroidery unit carrying case	SA529	D6EUC: XC9862-052
51	Hard case		XC7750-051
52	Bobbin cover (with mark)		XF0750-001
53	Bobbin case (gray)		XE8298-001



Memo

(For U.S.A. only)

Foot controller: Model S

This foot controller can be used with this machine model NV4750D.



Memo

- Always use accessories recommended for this machine.
- The screw of the presser foot holder is available through your authorized dealer (Part code XA4813-051).
- Included accessories 37, 48 and 49 can be stored in the machine's hard case.

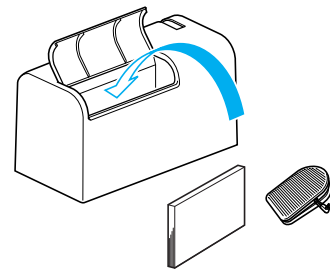

Options

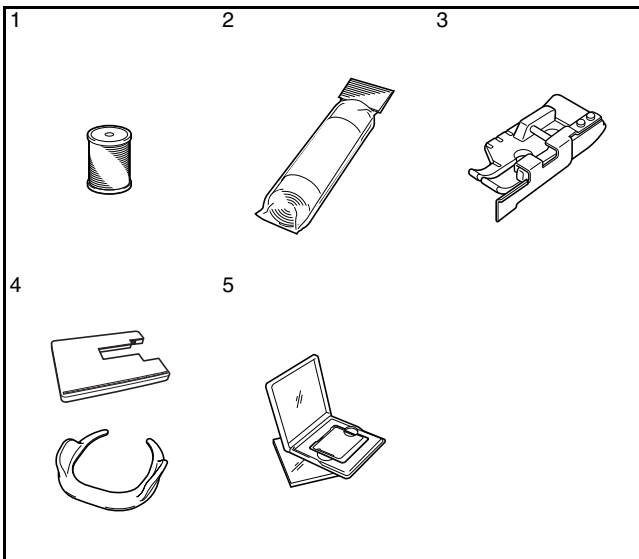

No.	Part Name	Part Code	
		U.S.A./ Canada	Others
1	Embroidery bobbin thread (White)	SA-EBT	X81164-001
	Embroidery bobbin thread (Black)	SAEBT999	XC5520-001
2	Stabilizer material	SA519	X81175-101
	Water soluble stabilizer	SA520	X81267-001
3	1/4" quilting foot with guide	SA185	F057: XC7416-252
4	Table and free motion grip	SATFM 4000D	TFM2: XC8645-052
5	Embroidery card		



Memo

- You can use any of the brother embroidery cards listed above with your machine.
- Please be aware that some specifications may change without notice.



Note

- Embroidery cards purchased in foreign countries may not work with your machine.

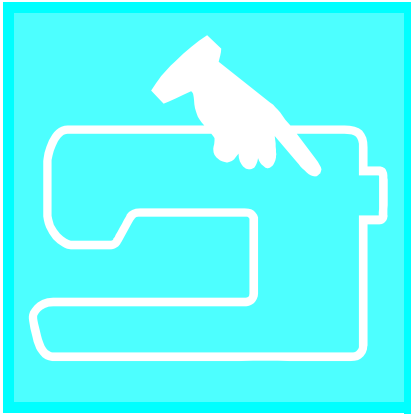

Chapter 1

Getting Ready

TURNING THE MACHINE ON/OFF	10
LCD SCREEN	11
■ Key Functions.....	12
Screens Operations Performed Using a USB Mouse.....	14
■ Clicking a key.....	14
■ Changing pages.....	15
Using the Machine Setting Mode Key.....	16
■ Adjusting Screen Brightness.....	19
■ Choosing the Display Language.....	20
Using the Machine Operation Mode Key.....	21
Using the Pattern Explanation Key.....	22
LOWER THREADING	23
Winding the Bobbin.....	23
■ Using the Supplemental Spool Pin.....	23
■ Using the Spool Pin.....	25
Setting the Bobbin.....	26
Pulling Up the Bobbin Thread.....	28
UPPER THREADING	29
Threading Using the “Automatic Threading” Button.....	29
Threading Manually.....	31
Using the Twin Needle Mode.....	34
Using Threads that Unwind Quickly.....	36
■ Using the Spool Net.....	36
■ Using the Vertical Spool Pin.....	36
CHANGING THE PRESSER FOOT	37
Removing the Presser Foot.....	37
Attaching the Presser Foot.....	37
Attaching the Walking Foot.....	38
CHANGING THE NEEDLE	39
■ About the Needle.....	41
■ Fabric/Thread/Needle Combinations.....	41

TURNING THE MACHINE ON/OFF

⚠ WARNING

- Use only regular household electricity as the power source. Using other power sources may result in fire, electric shock, or damage to the machine.
- Make sure that the plugs on the power cord are firmly inserted into the electrical outlet and the power cord receptacle on the machine.
- Do not insert the plug on the power cord into an electrical outlet that is in poor condition.
- Turn the main power to OFF and remove the plug in the following circumstances:
 - When you are away from the machine
 - After using the machine
 - When the power fails during use
 - When the machine does not operate correctly due to a bad connection or a disconnection
 - During electrical storms

⚠ CAUTION

- Use only the power cord included with this machine.
- Do not use extension cords or multi-plug adapters with many other appliances plugged in to them. Fire or electric shock may result.
- Do not touch the plug with wet hands. Electric shock may result.
- When unplugging the machine, always turn the main power to OFF first. Always grasp the plug to remove it from the outlet. Pulling on the cord may damage the cord, or lead to fire or electric shock.
- Do not allow the power cord to be cut, damaged, modified, forcefully bent, pulled, twisted, or bundled. Do not place heavy objects on the cord. Do not subject the cord to heat. These things may damage the cord, or cause fire or electric shock. If the cord or plug is damaged, take the machine to your authorized dealer for repairs before continuing use.
- Unplug the power cord if the machine is not to be used for a long period of time. Otherwise, a fire may result.
- When leaving the machine unattended, either the main switch of the machine should be turned to OFF or the plug must be removed from the socket-outlet.
- When servicing the machine or when removing covers, either the machine or the electrical set must be unplugged.
- For U.S.A. only

This appliance has a polarized plug (one blade wider than the other). To reduce the risk of electrical shock, this plug is intended to fit in a polarized outlet only one way.

If the plug does not fit fully in the outlet, reverse the plug. If it still does not fit, contact a qualified electrician to install the proper outlet. Do not modify the plug in any way.

- 1** Insert the power cord into the power cord receptacle, then insert the plug into a wall outlet.

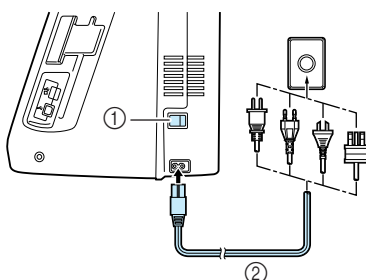

- ① Main power switch
② Power cord

- 2** Turn the main power switch to "I" to turn on the machine.

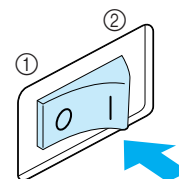

- ① OFF
② ON

- 3** Turn the main power switch to "O" to turn off the machine.

LCD SCREEN

When switching on the machine, the screen will display the name of the machine. Touch the screen to display the utility stitch. Either “1-01 Straight stitch (Left)” or “1-03 Straight stitch (Middle)” is selected, depending on the setting selected in the setting screen (see page 16). Press a key with your finger to select the stitch pattern, to select a machine function, or to select an operation indicated on the key.



Note

- When the straight stitch needle plate is on the machine, the needle will automatically move to the middle position.



Memo

- Only touch the screen with your finger or the included touch pen. Do not use a sharp pencil, screwdriver, or other hard or sharp object. It is not necessary to press hard on the screen. Pressing too hard or using a sharp object may damage the screen.

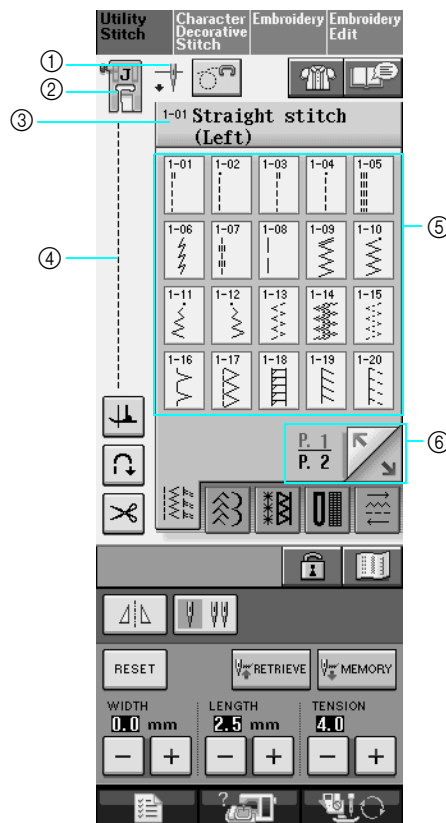

- ① Shows single or twin needle mode setting, and the needle stop position.



Single needle/down position



Single needle/up position



Twin needle/down position



Twin needle/up position

- ② Shows the presser foot code. Attach the presser foot indicated in this display before sewing.
 ③ Shows the name and code number of the selected stitch.
 ④ Shows a preview of the selected stitch.
 ⑤ Shows the stitch patterns.
 ⑥ Shows additional pages that can be displayed.

* All key functions of the LCD are explained in the “key functions” table on the following page.









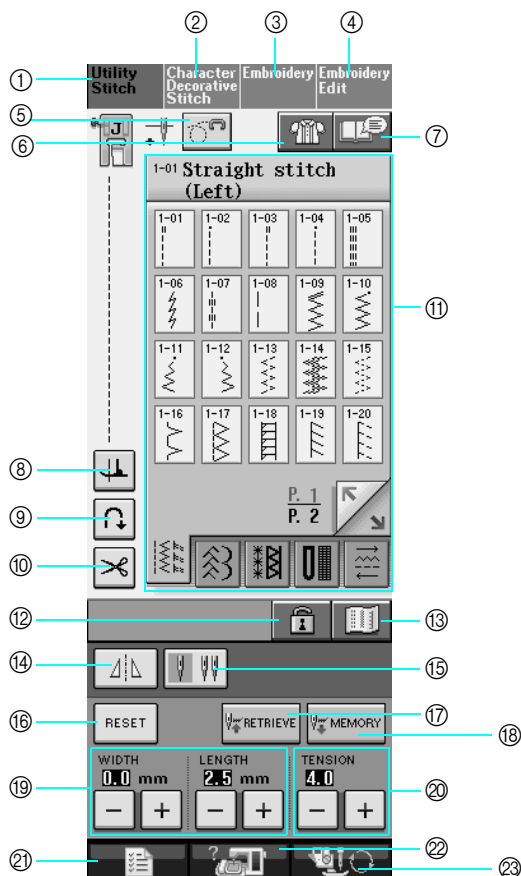





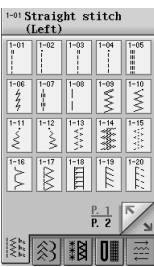

1

Getting Ready

■ Key Functions

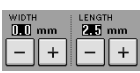

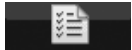
No.	Display	Key Name	Explanation	Page
①		Utility stitch key	Press this key to select a straight stitch, zigzag stitch, buttonhole, blind hem stitch, or other stitches commonly used in garment construction.	59
②		Character/Decorative stitch key	Press this key to select character or decorative stitch patterns.	116
③		Embroidery key	Attach the embroidery unit and press this key to sew embroidery.	149
④		Embroidery edit key	Press this key to combine embroidery patterns. With the embroidery edit functions, you can also create original embroidery patterns or frame patterns.	199
⑤		Free-motion mode key	Press this key to enter free-motion sewing mode. The presser foot is raised to a height appropriate for free-motion quilting.	83
⑥		Sewing type selection key	Press this key when you need help selecting the appropriate stitch pattern for the sewing application and when you need instructions on how to sew the stitch pattern. This key is very helpful for beginners.	61
⑦		Pattern explanation key	Press this key to see an explanation of the selected pattern.	22
⑧		Pivot key	Press this key to select the pivot setting. When the pivot setting is selected, stopping the machine lowers the needle and slightly raises the presser foot automatically. In addition, when sewing is restarted, the presser foot is automatically lowered. <ul style="list-style-type: none"> • If this key appears as , it cannot be used. • Be sure the needle position on page 2 of Machine Settings is set in the down position. 	53

No.	Display	Key Name	Explanation	Page
⑨		Automatic reinforcement stitch key	Press this key to use the automatic reinforcement stitching (reverse stitching) setting. If you select this setting before sewing, the machine will automatically sew reinforcement stitches at the beginning and end of sewing (depending on the pattern, the machine may sew reverse stitches).	51
⑩		Automatic thread cutting key	Press this key to set the automatic thread cutting function. Set the automatic thread cutting function before sewing to have the machine automatically sew reinforcement stitches at the beginning and end of sewing (depending on the pattern, the machine may sew reverse stitches) and trim the threads after sewing.	52
⑪		Stitch selection display	Press the key of the pattern you want to sew. Use  to change selection screens.	59
⑫		Screen lock key	Press this key to lock the screen. When the screen is locked, the various settings, such as the stitch width and stitch length, are locked and cannot be changed. Press this key again to unlock the settings.	55
⑬		Image key	Press this key to display an enlarged image of the selected stitch pattern.	59
⑭		Mirror image key	Press this key to create a mirror image of the selected stitch pattern. If the key display is light gray, a mirror image of the selected stitch pattern cannot be sewn.	59
⑮		Needle mode selection key (single/double)	Press this key to select twin needle sewing mode. The sewing mode changes between single needle mode and twin needle mode each time you press the key. If the key display is light gray, the selected stitch pattern cannot be sewn in twin needle mode.	34
⑯		Reset key	Press this key to return the selected stitch pattern saved settings to the original settings.	49-50
⑰		Retrieve key	Press this key to retrieve a saved pattern.	61
⑱		Manual memory key	Change the stitch pattern settings (zigzag width and stitch length, thread tension, automatic thread cutting or automatic reinforcement stitching, etc.), then save them by pressing this key. Five sets of settings can be saved for a single stitch pattern.	60
⑲		Stitch width and stitch length key	Shows the zigzag width and stitch length settings of the currently selected stitch pattern. You can use the plus and minus keys to adjust the zigzag width and stitch length settings.	49
⑳		Thread tension key	Shows the thread tension setting of the currently selected stitch pattern. The thread tension is usually set automatically. You can use the plus and minus keys to change the thread tension settings.	50
㉑		Machine setting mode key	Press this key to change the needle stop position, turn the buzzer ON/OFF, adjust the pattern or screen, and change other machine settings.	16
㉒		Machine operation mode key	Press this key to see explanations for upper threading, winding the bobbin, changing the presser foot, and how to use the machine.	21
㉓		Presser foot/Needle exchange key	Press this key before changing the needle, the presser foot, etc. This key locks all key and button functions to prevent operation of the machine.	37-40



1

Getting Ready

Screens Operations Performed Using a USB Mouse

If a USB mouse (sold separately by computer retailers) is connected to the sewing machine, the mouse can be used to perform operations in the screens.

In addition, a USB hub can be connected so that USB media and a USB mouse can be used at the same time.

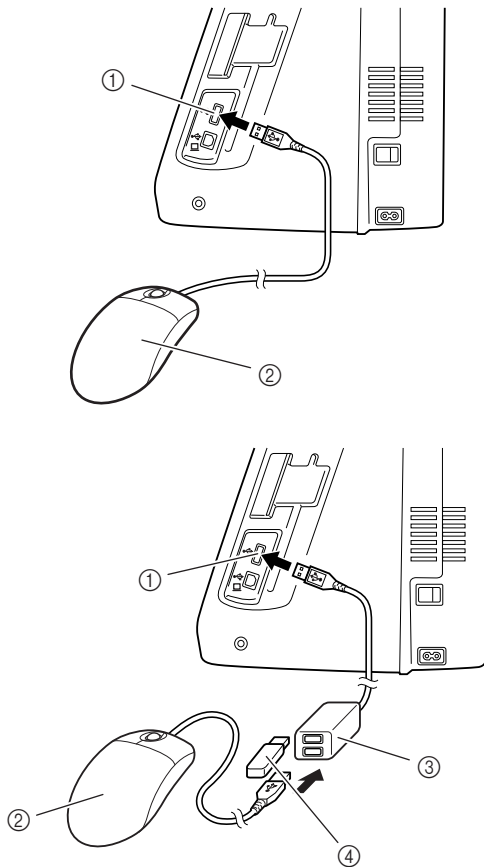

- ① USB port connector for media
- ② USB mouse
- ③ USB hub
- ④ USB media

Note

- Some mouse types cannot be used to operate the machine. For details on the USB mouse types that are compatible, check www.brother.com.
- Do not perform operations with the mouse while also touching the screen with your finger or the included touch pen.
- A USB mouse and USB hub can be connected or disconnected at any time.
- Only the left mouse button and its wheel can be used to perform operations. No other buttons can be used.
- Do not insert two or more USB media into a USB hub. Only one USB media can be recognized.

Clicking a key

When the mouse is connected, the pointer appears in the screen. Move the mouse to position the pointer over the desired key, and then click the left mouse button.

Memo

- Double-clicking has no effect.

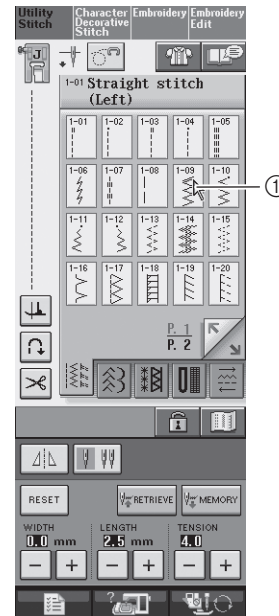



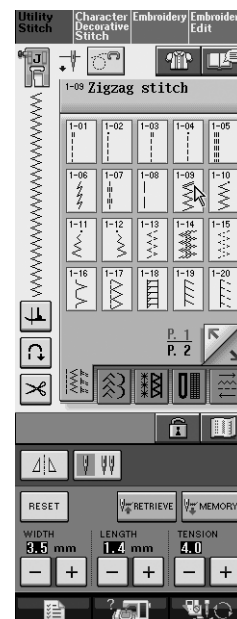
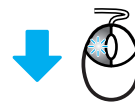

① Pointer



■ Changing pages

Rotate the mouse wheel to switch through the tabs of the pattern selection screens.

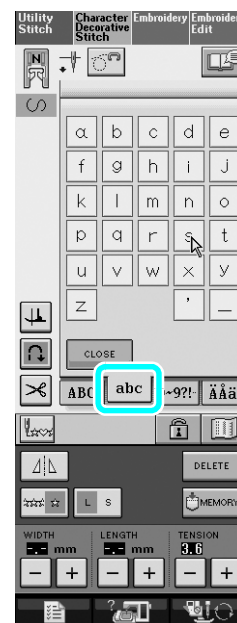
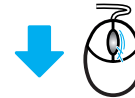
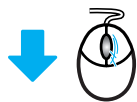
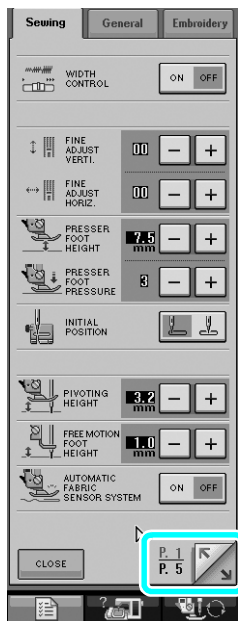

Memo

- If  for additional pages is displayed, rotate the mouse wheel to display the next page. In the  or , click the left mouse button with the pointer on  or  to move down to the next part of a page.

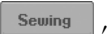

Getting Ready

Using the Machine Setting Mode Key

Press  to change the default machine settings (needle stop position, embroidery speed, opening display, etc.) Press ,  or  to display the different settings screens.

Memo

- This function will be available in future technology upgrades.

- Press  or  to display a different settings screen.

Sewing settings

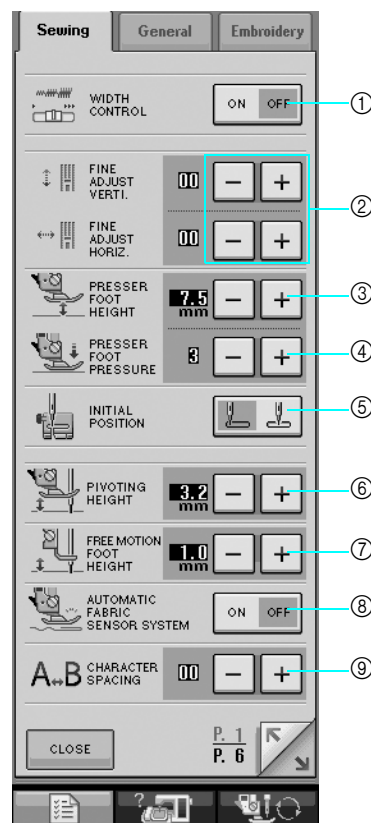

- Select whether to use the sewing speed controller to determine the zigzag width (see page 82).
- Make adjustments to character or decorative stitch patterns (see page 121).
- Adjust the presser foot height. (Select the height of the presser foot when the presser foot is raised.)
- Adjust the presser foot pressure. (The higher the number, the higher the pressure will be. Set the pressure at 3 for normal sewing.)
- Select whether “1-01 Straight stitch (Left)” or “1-03 Straight stitch (Middle)” is the utility stitch that is automatically selected when the machine is turned on.
- Change the height of the presser foot when sewing is stopped when the pivot setting is selected (see page 53). Adjust the presser foot to one of the three heights (3.2 mm, 5.0 mm and 7.5 mm).
- Change the height of the presser foot when the machine is set to free-motion sewing mode (see page 83).
- When set to “ON”, the thickness of the fabric is automatically detected by an internal sensor while sewing, so the fabric can be fed smoothly (see pages 47 and 55).
- Adjust the character spacing on Character/Decorative stitch (see page 119).

General settings



- ① Change the brightness of the LCD (see page 19).
- ② Select the needle stop position (the needle position when the machine is not operating) to be up or down. Select the down position when using the pivot key.
- ③ Turn the buzzer ON/OFF.
- ④ Turn the Needle Area and Work Area Lights ON/OFF.
- ⑤ Turn the opening screen display ON/OFF.
- ⑥ Use when running an application.
- ⑦ Change the display language (see page 20).
- ⑧ Display the service count and the total number of embroidery stitches. The service count is a reminder to take your machine in for regular servicing. (Contact your authorized dealer for details.)
- ⑨ The "NO." is the number for the embroidery and sewing machine.
- ⑩ Display the program version.

Memo

- The latest version of software is installed in your machine. Check with your local authorized Brother dealer or at www.brother.com for available updates (see page 250).



1

Getting Ready

Embroidery settings

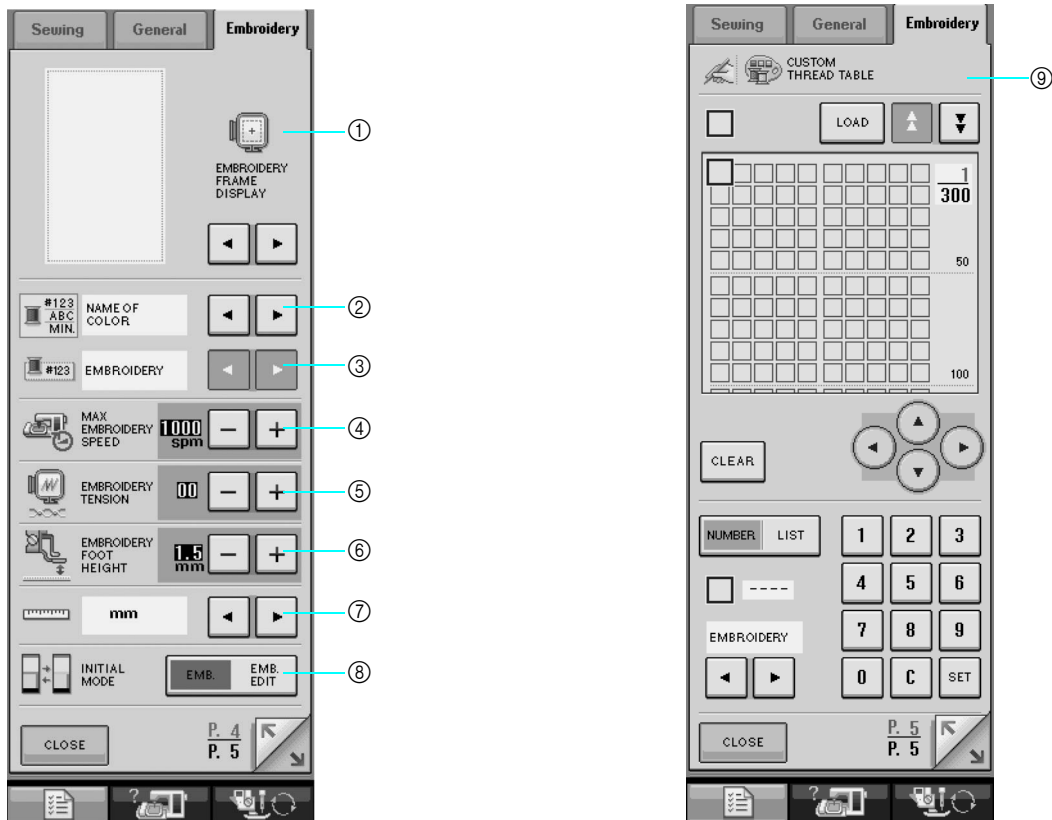

- ① Select from among 10 embroidery frame displays (see page 178).
- ② Change the thread color display on the embroidery screen; thread number, color name or each time to embroider (see page 176).
- ③ When the thread number #123 is selected, select among six thread brands (see page 176).
- ④ Adjust the maximum embroidery speed setting (see page 176).
- ⑤ Adjust the thread tension for embroidering.
- ⑥ Select the height of the embroidery foot “W” during embroidering (see page 157).
- ⑦ Change the display units (mm/inch).
- ⑧ Change the initial mode of the display (embroidery/embroidery edit).
- ⑨ Customize the thread color numbers (see page 210).

■ Adjusting Screen Brightness



Note

- All or part of the screen may sometimes become darker or lighter because of changes in the air temperature or other changes in the environment around the screen. This is normal and is not a sign of malfunction. Adjust the screen if it is difficult to read.
- The screen may be dark immediately after turning on the power. This is a function of the LCD back light screen, and it is not a sign of malfunction. The screen will return to its normal level of brightness after approximately 10 minutes.
- If you are not directly in front of the machine when you view the LCD, the colors may appear to change or the screen may be difficult to see. This is a characteristic of the LCD, and not a sign of damage or malfunction. For best results operate the screen while sitting in front of the machine.

1 Press .

→ The Sewing settings screen appears.



2 Press .





→ The General settings screen appears.





Memo

- Press  or  to display a different settings screen.

3 On the BRIGHTNESS OF LCD display, use

 and  to adjust the screen brightness.

* Press  to make the screen darker.

* Press  to make the screen lighter.

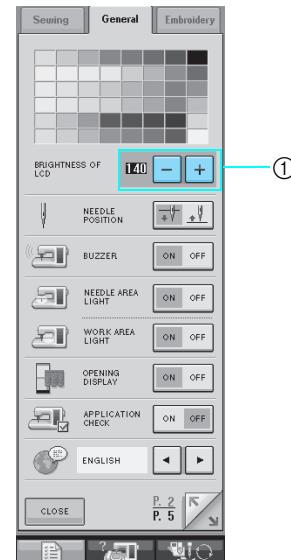

① Brightness of LCD display

4 Press .



Getting Ready

■ Choosing the Display Language

1 Press  .

→ The Sewing settings screen appears.

2 Press  .

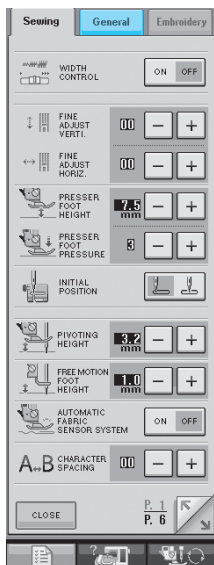

→ The General settings screen appears.

3 Use  and  to choose the display language.

* Choose from the following languages: [ENGLISH], [GERMAN], [FRENCH], [ITALIAN], [DUTCH], [SPANISH], [DANISH], [FINNISH], [SWEDISH], [PORTUGEUSE], [RUSSIAN], [NORWEGIAN] or [JAPANESE].



① Display language



4 Press  .

Using the Machine Operation Mode Key



Press  to open the screen shown below. Six categories are displayed at the top of the screen. Press a key to see more information about that category.

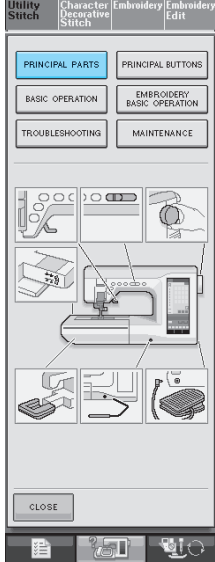

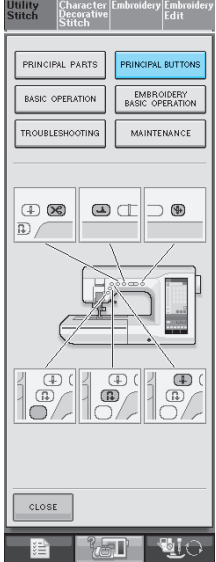
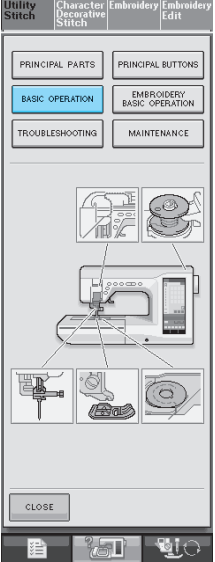
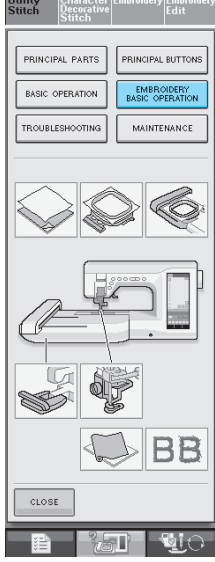
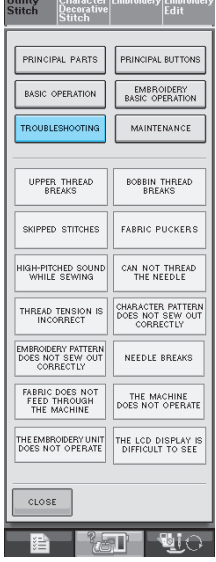
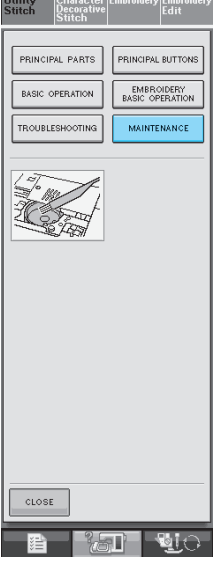
Getting Ready



 <p>PRINCIPAL PARTS displays information about the main parts of the machine and their functions. This is the first screen displayed when you press .</p>	 <p>PRINCIPAL BUTTONS displays information about the operation buttons.</p>	 <p>BASIC OPERATION displays information about threading the machine, changing presser feet, etc.</p>
 <p>EMBROIDERY BASIC OPERATION displays information about attaching the embroidery unit, preparing fabric for embroidering, etc.</p>	 <p>TROUBLESHOOTING displays troubleshooting information.</p>	 <p>MAINTENANCE displays information about cleaning the machine, etc.</p>

Example: Displaying information about upper threading

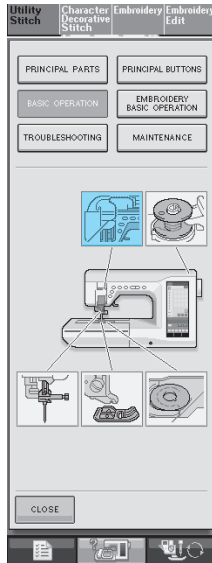
- 1 Press  .
- 2 Press  .
→ The lower half of the screen will change.
- 3 Press  (upper threading).



→ The screen shows instructions for threading the machine.

- 4 Read the instructions.
 - * Press  to see a video of the displayed instructions.
 - * Press  to view the next page.

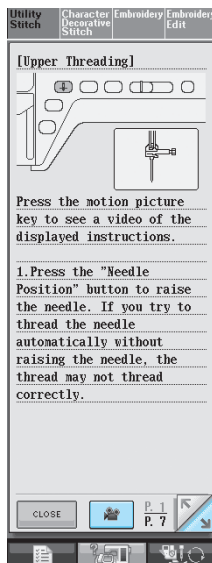



- 5 Press  to return to the original screen.

Using the Pattern Explanation Key

If you want to know more about the uses of a stitch pattern, select the pattern and press  to see an explanation of the stitch selection.

Example: Displaying information about 

- 1 Press  .
- 2 Press  .

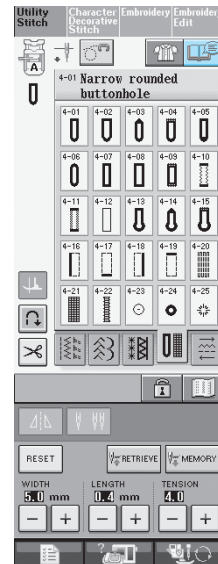

→ The screen shows information about  .

- 3 Press  to return to the original screen.

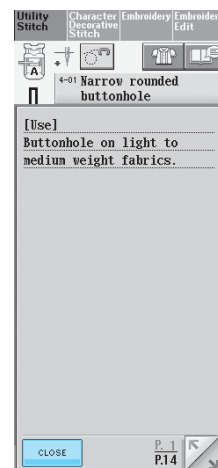



1

Getting Ready

LOWER THREADING

Winding the Bobbin



in that order to display a video example of bobbin winding on the LCD (see page 22). Follow the steps explained below to complete the operation.

CAUTION

- The enclosed bobbin was designed specifically for this sewing machine. If bobbins from other models are used, the machine will not operate correctly. Use only the enclosed bobbin or bobbins of the same type (part code: SA156, SFB).

11.5 mm
(approx.
7/16 inch)

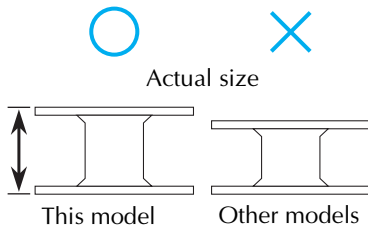

Using the Supplemental Spool Pin

With this machine, you can wind the bobbin during sewing. While using the main spool pin to sew embroidery, you can conveniently wind the bobbin using the supplemental spool pin.

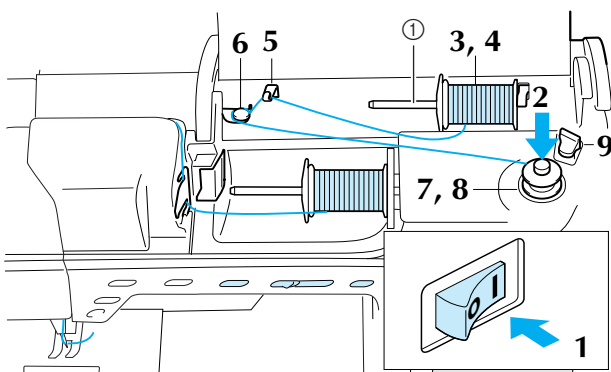

① Supplemental spool pin

- Turn the main power to ON and open the top cover.
- Align the groove in the bobbin with the spring on the bobbin winder shaft, and set the bobbin on the shaft.

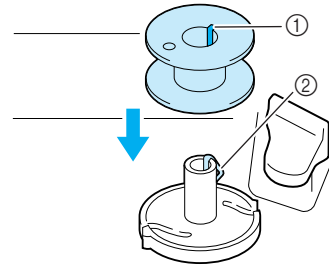

- ① Groove of the bobbin
- ② Spring on the shaft

- Set the supplemental spool pin in the "up" position.

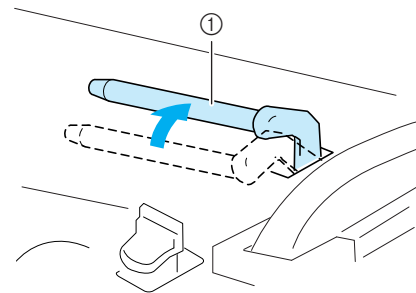

① Supplemental spool pin

- Place the spool of thread on the supplemental spool pin, so that thread unrolls from the front. Then push the spool cap onto the spool pin as far as possible to secure the thread spool.

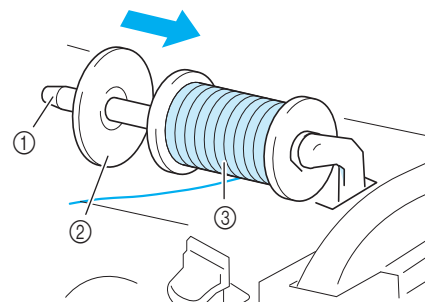

- ① Spool pin
- ② Spool cap
- ③ Thread spool

CAUTION

- If the thread spool and/or spool cap are set incorrectly, the thread may tangle on the spool pin and cause the needle to break.
- Use the spool cap (large, medium, or small) that is closest in size to the thread spool. If a spool cap smaller than the thread spool is used, the thread may become caught in the slit on the end of the spool and cause the needle to break.

Memo

- When sewing with fine, cross-wound thread, use the small spool cap, and leave a small space between the cap and the thread spool.

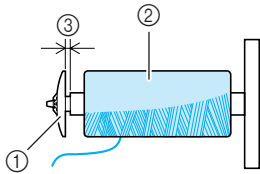

- ① Spool cap (small)
- ② Thread spool (cross-wound thread)
- ③ Space

5 With your right hand, hold the thread near the thread spool. With your left hand, hold the end of the thread, and use both hands to pass the thread through the thread guide.

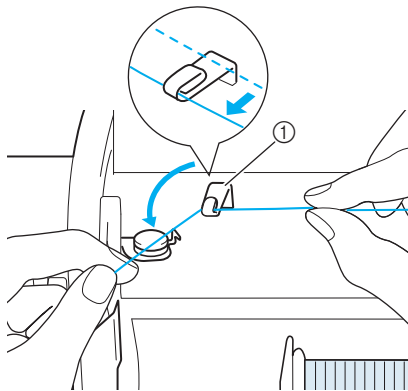

- ① Thread guide

6 Pass the thread under the pin, and pass the thread around the pretension disk making sure that the thread is under the pretension disk.

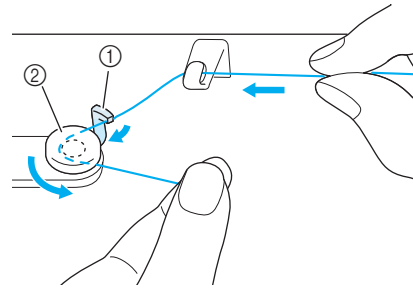

- ① Pin
- ② Pretension disk

7 Wind the thread clockwise around the bobbin 5-6 times.

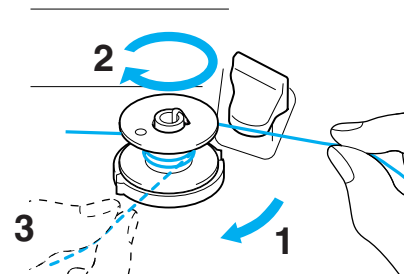

8 Pass the end of the thread through the guide slit in the bobbin winder seat, and pull the thread to the right to cut the thread with the cutter.

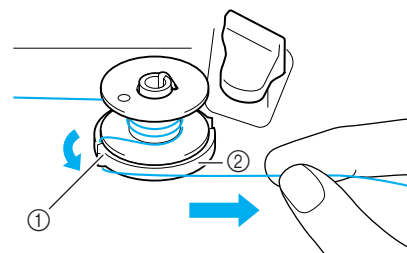

- ① Guide slit (with built-in cutter)
- ② Bobbin winder seat

CAUTION

- Be sure to follow the process described. If the thread is not cut with the cutter, and the bobbin is wound, when the thread runs low it may tangle around the bobbin and cause the needle to break.

- 9** Set the bobbin holder to the left, until it clicks into place.

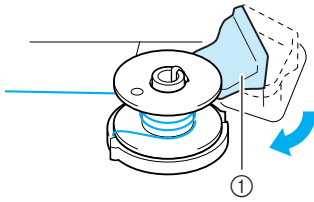

① Bobbin holder (switch)

Memo

When the bobbin holder is set to the left, it works as a switch to make the bobbin wind automatically.

→ The bobbin starts winding automatically and stops rotating when it is done winding. The bobbin holder will return to the original position.

- 10** Cut the thread with the cutter and remove the bobbin.

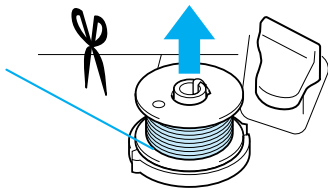

Memo

• When removing the bobbin, do not pull on the bobbin winder seat. Doing so could loosen or remove the bobbin winder seat, and could result in damage to the machine.

CAUTION

• Setting the bobbin improperly may cause the thread tension to loosen, breaking the needle and possibly resulting in injury.

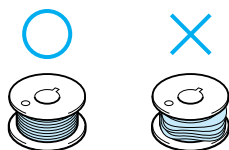

Using the Spool Pin

You can use the main spool pin to wind the bobbin before sewing. You cannot use this spool pin to wind the bobbin while sewing.

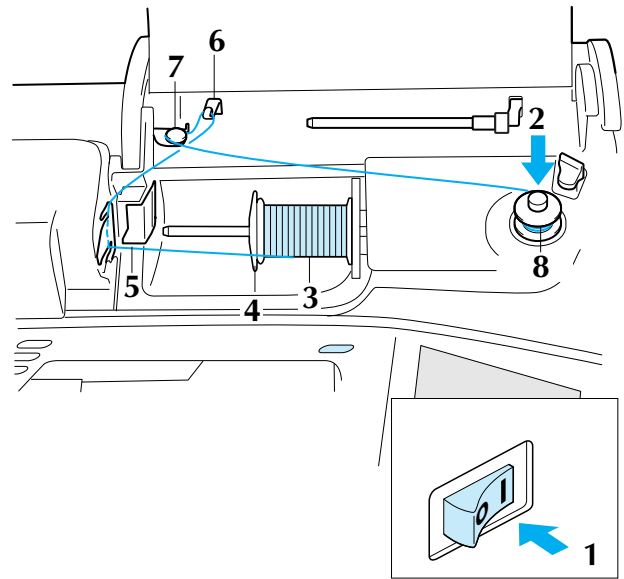

- 1** Turn the main power to ON and open the top cover.

- 2** Align the groove in the bobbin with the spring on the bobbin winder shaft, and set the bobbin on the shaft.

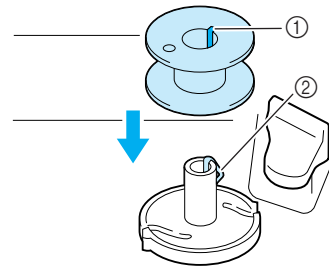

① Groove of the bobbin
② Spring on the shaft

- 3** Pivot the spool pin so that it angles upward. Set the thread spool on the spool pin so that the thread unwinds from the front of the spool.

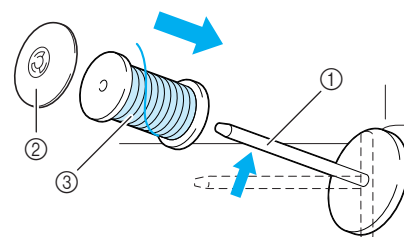

① Spool pin
② Spool cap
③ Thread spool



Getting Ready

4 Push the spool cap onto the spool pin as far as possible, then return the spool pin to its original position.

5 Holding the thread with your hands, slide the thread into the grooves on the thread guide plate.

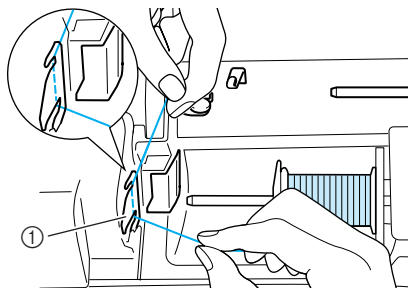

① Thread guide plate

6 Pass the thread through the thread guide.

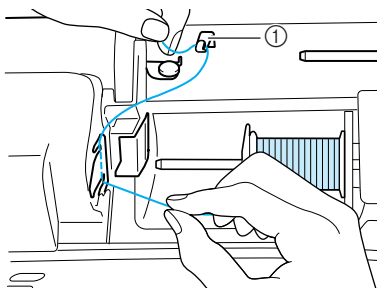

① Thread guide

7 Pass the thread under the pin. Then pass the thread around the pretension disk making sure that the thread is under the pretension disk.

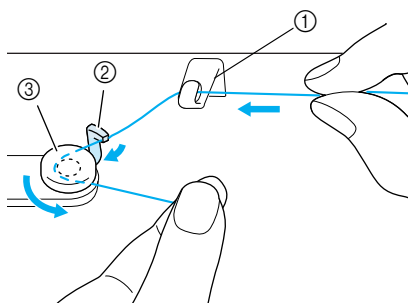

① Thread guide
② Pin
③ Pretension disk

8 Follow steps **7** through **10** on page 24 through 25.

Setting the Bobbin

Press → BASIC OPERATION → →

in that order to display a video example of the operation on the LCD (see page 22). Follow the steps explained below to complete the operation.

! CAUTION

- Use a bobbin thread that has been correctly wound. Otherwise, the needle may break or the thread tension will be incorrect.

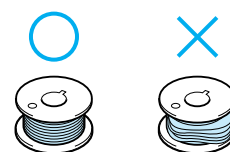

- The enclosed bobbin was designed specifically for this sewing machine. If bobbins from other models are used, the machine will not operate correctly. Use only the enclosed bobbin or bobbins of the same type (part code: SA156, SFB).

11.5 mm
(approx.
7/16 inch)

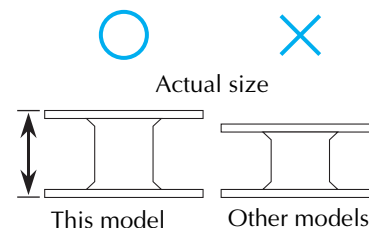

- Before inserting or changing the bobbin, be sure to press in the LCD, otherwise injuries may occur if the "Start/Stop" button or any other button is pressed and the machine starts sewing.

1 Press the "Presser Foot Lifter" button to raise the presser foot.

- 2** Slide the bobbin cover latch to the right.

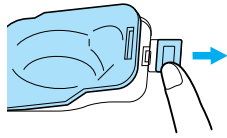

- ① Bobbin cover
② Latch

→ The bobbin cover opens.

- 3** Remove the bobbin cover.

- 4** Hold the bobbin with your right hand and hold the end of the thread with your left hand.

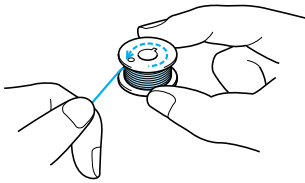

- 5** Set the bobbin in the bobbin case so that the thread unwinds to the left.

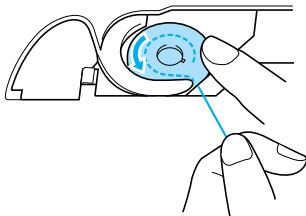

- 6** Hold the bobbin lightly with your right hand, and then guide the thread with your left hand.

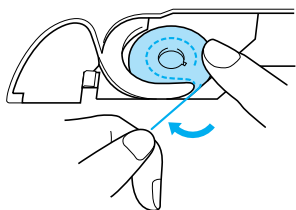

- 7** Pass the thread through the guide, and then pull the thread out towards the front.

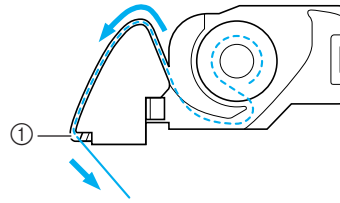

- ① Cutter

→ The cutter cuts the thread.



Note

Make sure that the thread is correctly inserted through the tension-adjusting spring of the bobbin case. If it is not inserted correctly, reinsert the thread.

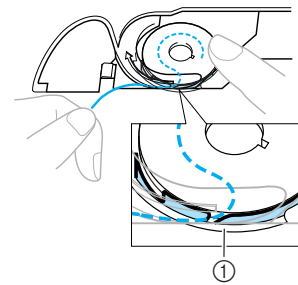

- ① Tension-adjusting spring

CAUTION

- Be sure to hold down the bobbin with your finger and unwind the bobbin thread correctly. Otherwise, the thread may break or the thread tension will be incorrect.

- 8** Insert the tab in the lower-left corner of the bobbin cover (1), and then lightly press down on the right side to close the cover (2).

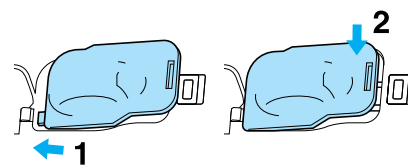

1

Getting Ready

Pulling Up the Bobbin Thread

There may be some sewing applications where you want to pull up the bobbin thread; for example, when making gathers, darts, or doing free motion quilting or embroidery.



Memo

You can pull up the bobbin thread after threading the upper thread (see "UPPER THREADING" on page 29).

- 1 Guide the bobbin thread through the groove, following the arrow in the illustration.**

- * Do not cut the thread with the cutter.
- * Do not replace the bobbin cover.

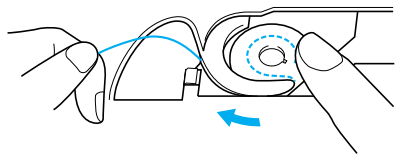

- 2 While holding the upper thread, press the needle position button to lower the needle.**

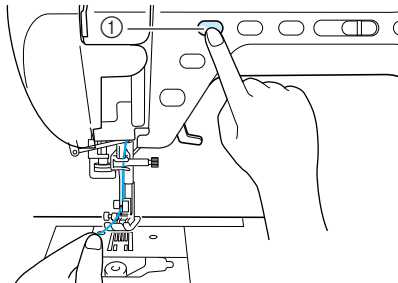

① Needle position button

- 3 Press the "Needle Position" button to raise the needle.**

- 4 Gently pull the upper thread, and a loop of the bobbin thread will come out of the hole in the needle plate.**

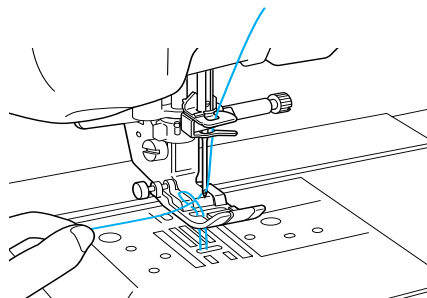

- 5 Pull up the bobbin thread, then pass it under the presser foot and pull it about 100 mm (approx. 3-4 inches) toward the back of the machine, making it even with the upper thread.**

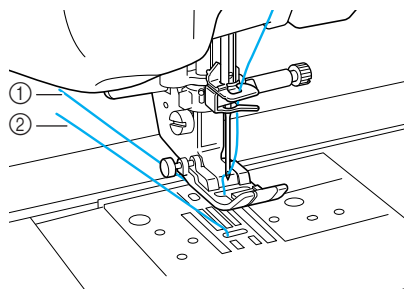

① Upper thread
② Bobbin thread

- 6 Replace the bobbin cover.**

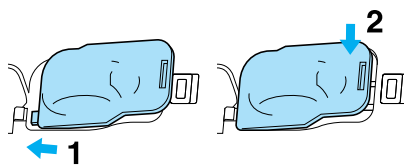

UPPER THREADING

Threading Using the “Automatic Threading” Button

Press  →  →  →

 in that order to display a video example of the operation on the LCD (see page 22). Follow the steps explained below to complete the operation.

CAUTION

- Be sure to thread the machine properly. Improper threading can cause the thread to tangle and break the needle, leading to injury.
- When using accessories not included with this machine, attach the accessory to the machine after threading the machine.

Memo

- The automatic threading function can be used with sewing machine needles 75/11 through 100/16.
- Thread such as transparent nylon monofilament thread and thread with a thickness of 130/20 or thicker cannot be used with the automatic threading function.
- The automatic threading function cannot be used with the wing needle or the twin needle.
- If the automatic threading function cannot be used, see “Threading Manually” on page 31.

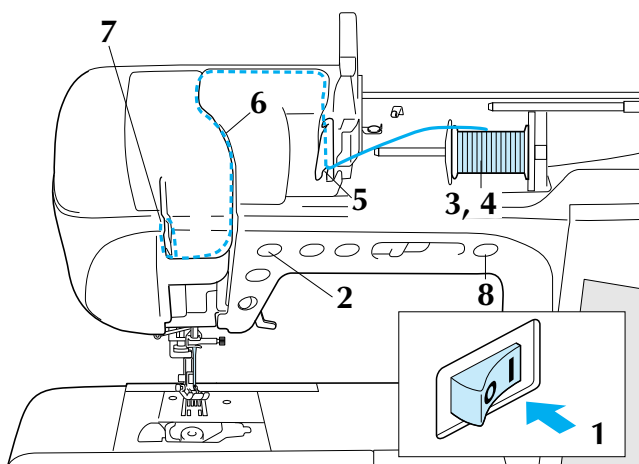

- 1 Turn the main power to ON.
- 2 Press the “Needle Position” button to raise the needle.

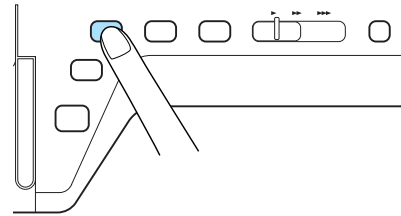

Note

If you try to thread the needle automatically without raising the needle, the thread may not thread correctly.

- 3 Pivot the spool pin so that it angles upward. Set the thread spool on the spool pin so that the thread unwinds from the front of the spool.

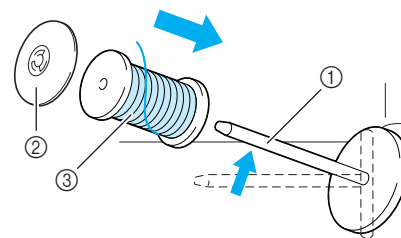

- ① Spool pin
- ② Spool cap
- ③ Thread spool

- 4 Push the spool cap onto the spool pin as far as possible, then return the spool pin to its original position.

CAUTION

- If the thread spool and/or spool cap are set incorrectly, the thread may tangle on the spool pin and cause the needle to break.
- Use the spool cap (large, medium, or small) that is closest in size to the thread spool. If a spool cap smaller than the thread spool is used, the thread may become caught in the slit on the end of the spool and cause the needle to break.



1

Getting Ready



Memo

When sewing with fine, cross-wound thread, use the small spool cap, and leave a small space between the cap and the thread spool.

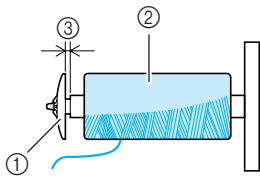

- ① Spool cap (small)
- ② Thread spool (cross-wound thread)
- ③ Space

5

Holding the thread with your hands, slide the thread into the grooves on the thread guide plate.

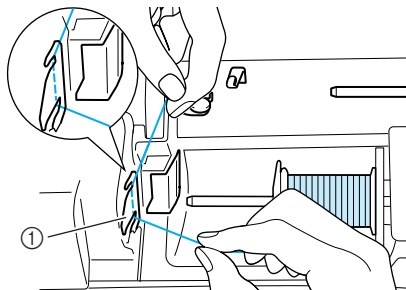

- ① Thread guide plate

6

While holding the thread in your right hand, pass the thread through the thread guide in the direction indicated.

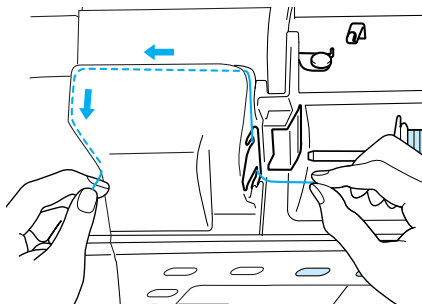

7

When finished pulling the thread through the thread guide, cut the thread and leave the thread in position.

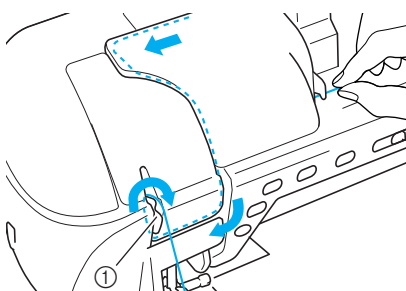

- ① Cutter

8

Press the “Automatic Threading” button to have the machine automatically thread the needle.

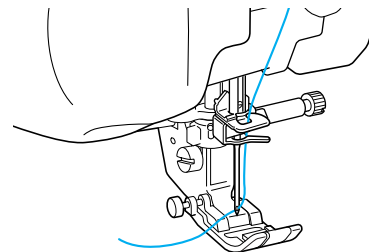
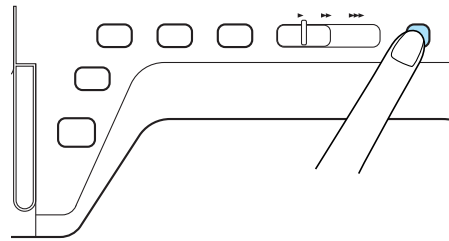

→ The upper threading is finished.



Memo

When the “Automatic Threading” button is pressed, the presser foot will be automatically lowered.



Note

In case the needle is not completely threaded, slowly pull the loop of the thread through from the back of the needle.

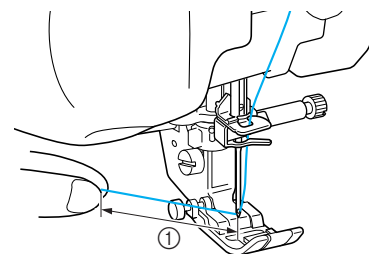
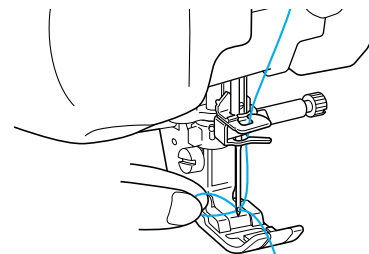

- ① About 5 cm (approx. 2 inches)



Memo

If the needle could not be threaded or the thread was not passed through the needle bar thread guides, perform the procedure again starting from step 3.

Note

When the “Automatic Threading” button is pressed, the presser foot will be automatically lowered.

If you are using an incorrect needle and thread combination, the hook may sometimes get caught in the needle. If this happens, remove the hook from the needle as described below.

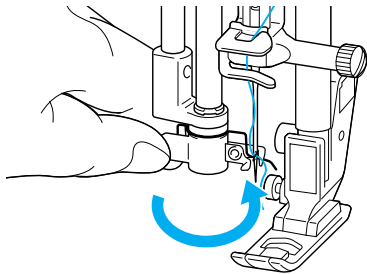
**CAUTION**

- The needle thread carrier will automatically thread the needle when the “Automatic Threading” button is pressed. Be sure to keep your hands and other items away from the needle area, otherwise injuries may occur.

Threading Manually

Automatic threading cannot be used when using the wing needle, the twin needle, or special thread with a thickness of 130/20 or thicker. In these cases, thread the needle as described below.

CAUTION

- Before manually threading the machine, be sure to press  in the LCD, otherwise injuries may occur if the “Start/Stop” button or any other button is pressed and the machine starts sewing.

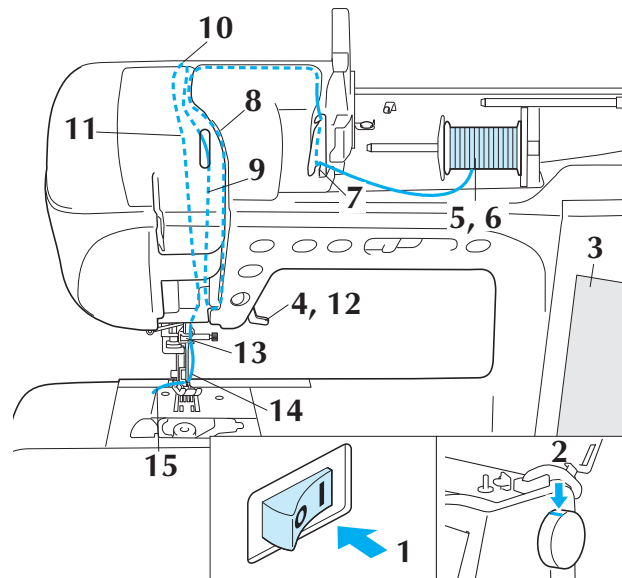

- 1 Turn the main power to ON.
- 2 Turn the handwheel so that the line on the machine is aligned with the line on the handwheel.

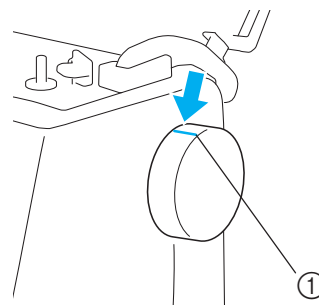

① Line on handwheel

Memo

If the line on the machine is not aligned with the line on the handwheel, the sewing machine cannot be threaded. Check that the line on the handwheel is facing up as shown in the illustration above.

- 3 Press  at the lower right of the LCD screen.

→ The entire screen becomes white, and all keys and operation buttons are locked.



1

Getting Ready

4 Raise the presser foot lever.

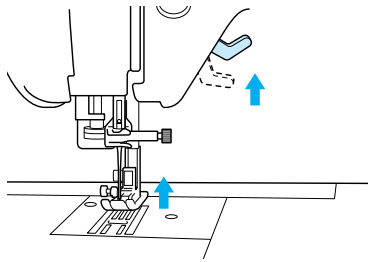

CAUTION

- If the presser foot is not raised, the sewing machine cannot be threaded correctly.

5 Pivot the spool pin so that it angles upward. Set the thread spool on the spool pin so that the thread unwinds from the front of the spool.

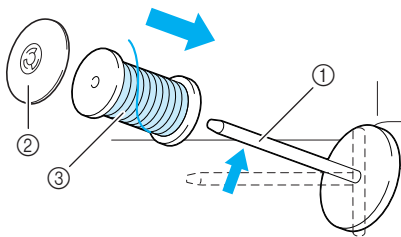

- ① Spool pin
- ② Spool cap
- ③ Thread spool

6 Push the spool cap onto the spool pin as far as possible, then return the spool pin to its original position.

CAUTION

- If the thread spool and/or spool cap are set incorrectly, the thread may tangle on the spool pin and cause the needle to break.
- Use the spool cap (large, medium, or small) that is closest in size to the thread spool. If a spool cap smaller than the thread spool is used, the thread may become caught in the slit on the end of the spool and cause the needle to break.

7 Holding the thread with both hands, slide the thread into the grooves on the thread guide plate.

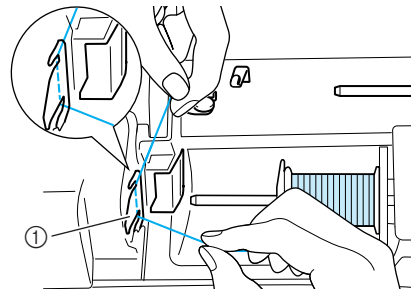

- ① Thread guide plate

8 While holding the thread in your right hand, use your left hand to pull the thread toward the threading path cover, then pass it along the thread path as shown in the illustration.

Be sure to pass the thread along the right side of the thread path guide.

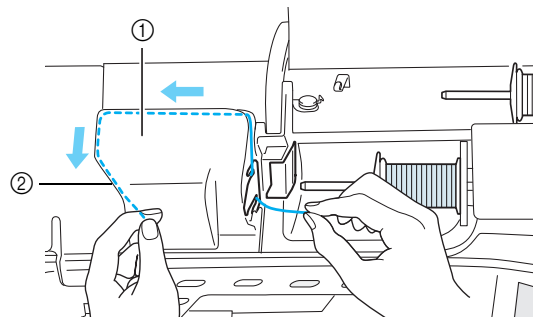

- ① Threading path cover
- ② Thread path guide

9 Pull the thread under the thread path guide.

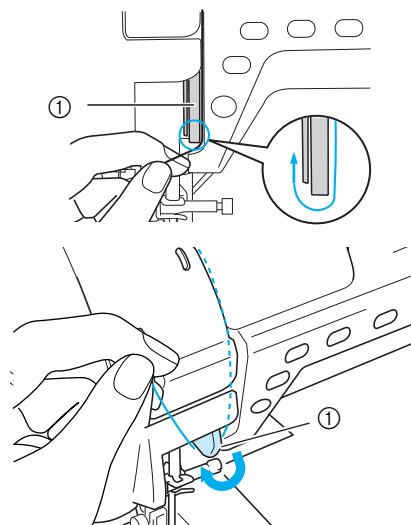

- ① Thread path guide

- 10** Pull the thread up along the left side of the thread path guide to the top left corner of the threading path cover.

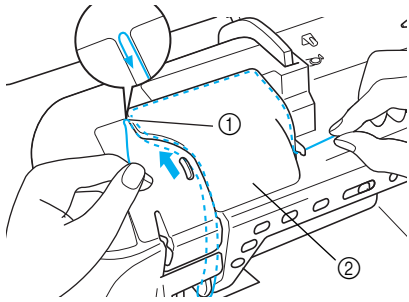

- ① Top left corner
② Threading path cover

- 11** Pull the thread down to the needle bar along the left side of the thread path guide.

* Make sure the thread is hooked at the top corner and positioned behind the transparent front cover.

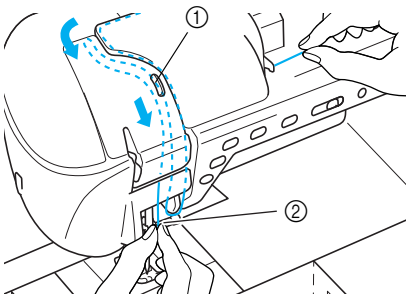

- ① Thread take-up lever check window
② Transparent front cover

 **Memo**

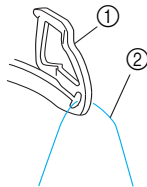

- ① Take-up lever ② Thread

Look through the thread take-up lever check window and check that the thread is correctly fed through the take-up lever, turning the handwheel toward you.

- 12** Lower the presser foot lever.

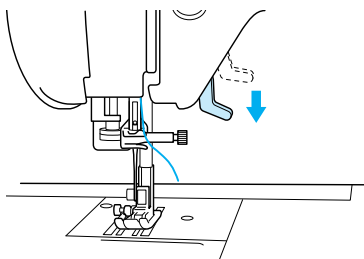

- 13** Holding the thread with both hands, pass the thread through both the upper and lower needle bar thread guides.

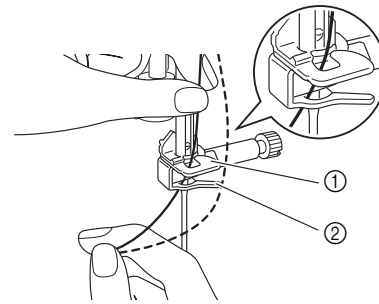

- ① Needle bar thread guide (upper)
② Needle bar thread guide (lower)

- 14** Pass the thread through the eye of the needle from front to back.

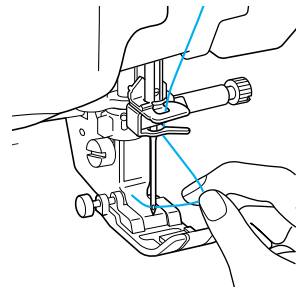

- 15** Pass the thread through the presser foot, and then pull out about 100-150 mm (approx. 4-6 inches) of thread toward the back of the machine.

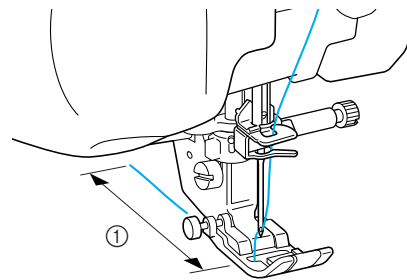

- ① 10 cm-15 cm (approx. 4-6 inches)

- 16** Press  to unlock all keys and buttons.



1

Getting Ready

Using the Twin Needle Mode

The twin needle can only be used for patterns that show  after being selected. Before you select a stitch pattern, make sure the stitch can be sewn in the twin needle mode (refer to the "STITCH SETTING CHART" at the end of this manual).

CAUTION

- Use only twin needles made for this machine (part code X59296-151). Other needles could break, resulting in damage.
- Be sure to set the twin needle mode when using the twin needle. Using the twin needle while the machine is in single needle mode could cause the needle to break, resulting in damage.
- Do not sew with bent needles. The needle could break and cause injury.
- When using the twin needle, be sure to use presser foot "J" only.
- When the twin needle is used, bunched stitches may occur depending on the types of fabric and thread that are used. If this occurs, use monogramming foot "N".
- Before changing the needle or threading the machine, be sure to press  in the LCD, otherwise injuries may occur if the "Start/Stop" button or any other button is pressed and the machine starts sewing.

- 1** Press  and install the twin needle (see "CHANGING THE NEEDLE" on page 39).

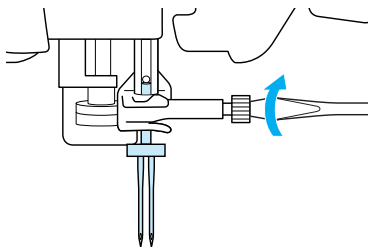

2 Manually thread the machine.

- * Follow the steps for threading a single needle for the first threading (see "Threading Manually" on page 31).

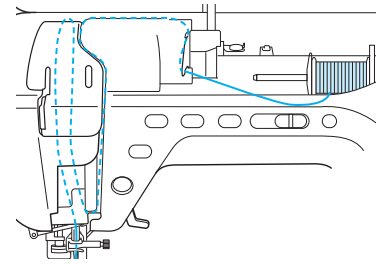

3 Pass the thread through the needle bar thread guides on the needle bar, then thread the needle on the left side.

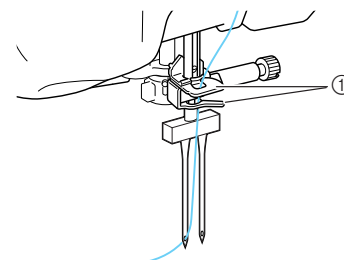

- ① Needle bar thread guides



Note

- The "Automatic Threading" button cannot be used. Manually thread the twin needle from front to back. Using the "Automatic Threading" button may result in damage to the machine.

4 Pull up the supplemental spool pin and set it in the up position.

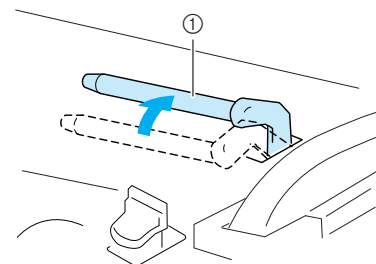

- ① Supplemental spool pin

- 5** Place the additional spool of thread on the supplemental spool pin, so that the thread unwinds from the front. Then push the spool cap onto the spool pin as far as possible to secure the thread spool.

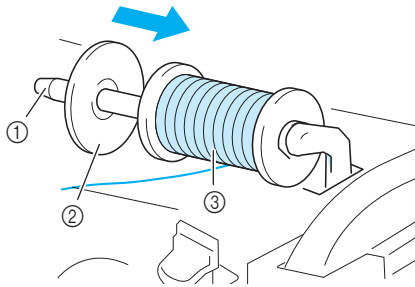

- ① Spool pin
- ② Spool cap
- ③ Thread spool

- 6** Hold the thread from the spool with both hands, and place the thread in the thread guide.

- * Do not place the thread in the bobbin winding thread guide.

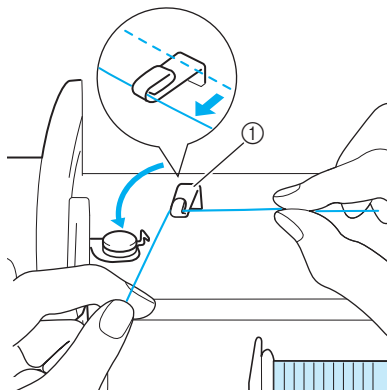

- ① Thread guide

- 7** Pass the thread through the thread guide plate, following the sequence as described below (or refer to "Threading Manually" on page 31).

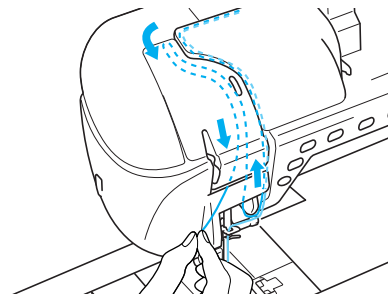
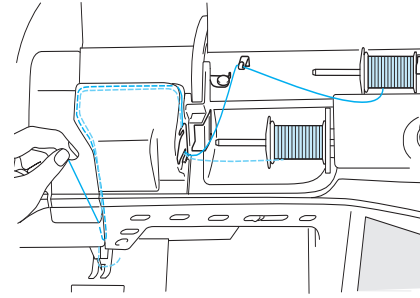

- 8** Do not pass the thread in the needle bar thread guides on the needle bar. Thread the needle on the right side.

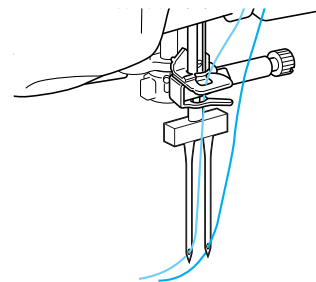

- 9** Press .





1

Getting Ready

10 Select a stitch pattern. (Example: )

- * Refer to the "STITCH SETTING CHART" at the end of this manual for proper stitch to use with presser foot "J".
- The Selected stitch is displayed.

Note
If the  key is light gray after selecting the stitch, the selected stitch cannot be sewn in the twin needle mode.

11 Press  to select the twin needle mode.

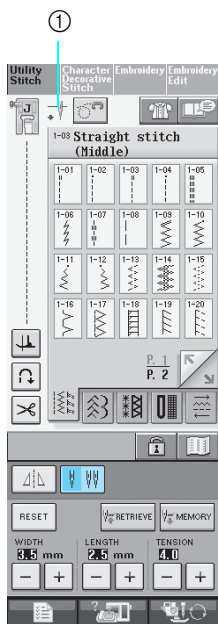

- ① Single needle/twin needle setting
-  appears.

CAUTION
Be sure to set the twin needle mode when using the twin needle. Using the twin needle while the machine is in single needle mode could cause the needle to break, resulting in damage.

12 Start sewing.
Sample of Twin Needle Sewing

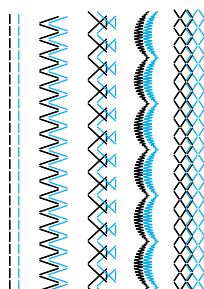

Using Threads that Unwind Quickly

Using the Spool Net

If using transparent nylon thread, metallic thread, or other strong thread, place the included spool net over the spool before using it. When using these threads, threading must be done manually. If the spool net is too long, fold it once to match it to the spool size before placing it over the spool.

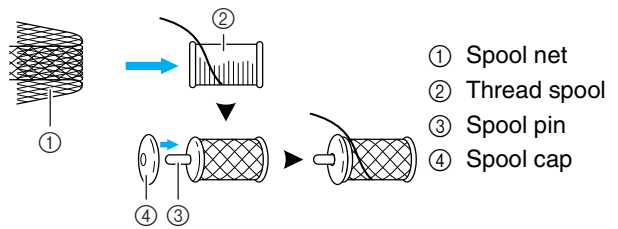

- ① Spool net
- ② Thread spool
- ③ Spool pin
- ④ Spool cap

- Memo**
- When threading the spool with the spool net on, the thread may not come out enough. Make sure that 5-6 cm (approx. 2 - 2-1/2 inches) of thread are pulled out.
 - It may be necessary to adjust the thread tension when using the spool net.

Using the Vertical Spool Pin

Use the vertical spool pin when using an irregularly shaped thread spool, and when sewing or embroidering with metallic thread.

1 Insert the vertical spool pin onto the bobbin winder shaft.

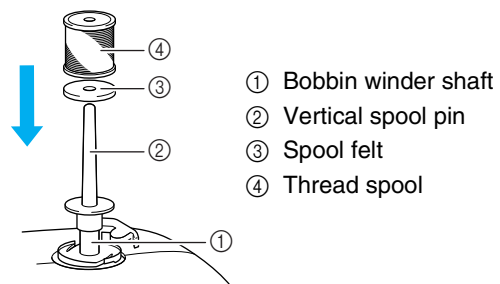

2 Install the spool felt and the thread spool in that order, and then thread the upper thread.

- Memo**
- When setting the thread spool, set it so that the thread winds off from the front of the spool.
 - If using metallic thread, we recommend that you use a 90/14 home sewing machine needle.
 - This method keeps the thread from twisting as it comes off the spool pin.



CHANGING THE PRESSER FOOT



1

Getting Ready

⚠ CAUTION

- Always press  on the screen before changing the presser foot. If  is not pressed and the “Start/Stop” button or another button is pressed, the machine will start and may cause injury.
- Always use the correct presser foot for the selected stitch pattern. If the wrong presser foot is used, the needle may strike the presser foot and bend or break, and may cause injury.
- Only use presser feet made for this machine. Using other presser feet may lead to accident or injury.

Removing the Presser Foot

- 1 Press the “Needle Position” button to raise the needle.

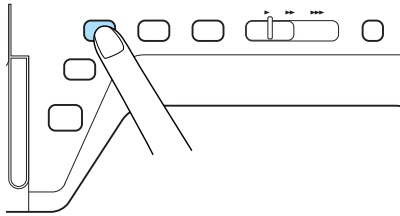

- 2 Press .

- * If “OK to automatically lower the presser foot?” appears on the LCD screen, press OK to continue.
- The entire screen becomes white, and all keys and operation buttons are locked.

- 3 Raise the presser foot lever.

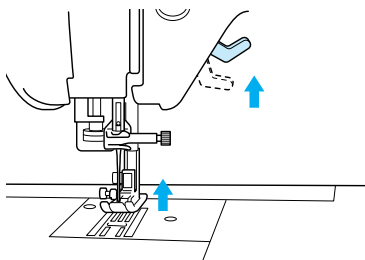

- 4 Press the black button on the presser foot holder and remove the presser foot.

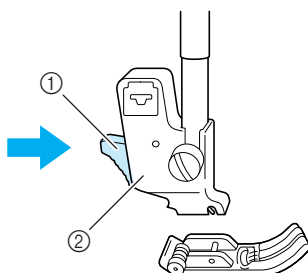

- ① Black button
- ② Presser foot holder

Attaching the Presser Foot

⚠ CAUTION

- Make sure that the presser foot is installed in the correct direction, otherwise the needle may strike the presser foot, breaking the needle and causing injuries.

- 1 Place the new presser foot under the holder, aligning the foot pin with the notch in the holder. Lower the presser foot lever so that the presser foot pin snaps into the notch in the holder.

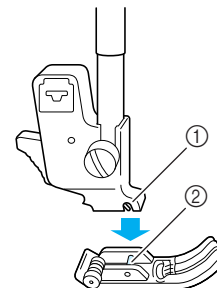

- ① Notch
- ② Pin

- 2 Press  to unlock all keys and buttons.

- 3 Raise the presser foot lever.

Attaching the Walking Foot

The walking foot holds the fabric between the presser foot and the feed dogs to feed the fabric. This enables you to have better fabric control when sewing difficult fabrics (such as quilting or velvet) or fabrics that slip easily (such as vinyl cloth, leather, or synthetic leather).



Note

- When sewing with the walking foot, sew at medium to low speeds.



Memo

- The walking foot can only be used with straight or zigzag stitch patterns. Reverse stitches cannot be sewn with the walking foot. Only select straight or zigzag stitch patterns with reinforcement stitches.

1

Follow the steps in “Removing the Presser Foot” on the previous page.

2

Loosen the screw of the presser foot holder to remove the presser foot holder.

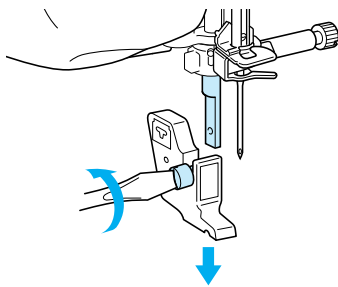

3

Set the operation lever of the walking foot so that the needle clamp screw is set between the fork, and position the walking foot on the presser foot bar.

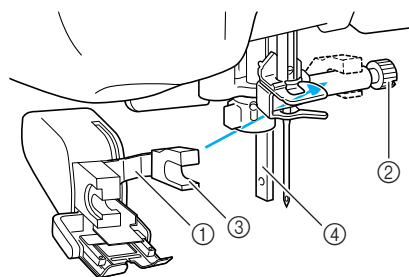

- ① Operation lever
- ② Needle clamp screw
- ③ Fork
- ④ Presser foot bar

4

Lower the presser foot lever. Insert the screw, and tighten the screw securely with the screwdriver.

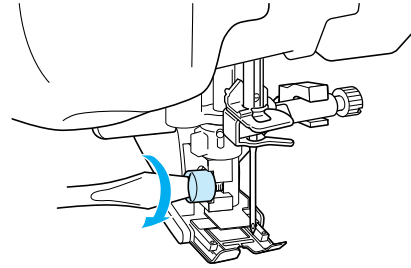

CAUTION

- Use the included screwdriver to tighten the screw securely. If the screw is loose, the needle may strike the presser foot and cause injury.
- Be sure to turn the handwheel toward the front of the machine to check that the needle does not strike the presser foot. If the needle strikes the presser foot, injury may result.



CHANGING THE NEEDLE



1

Getting Ready

⚠ CAUTION

- Always press  on the screen before changing the needle. If  is not pressed and the Start/Stop button or another operation button is pressed accidentally, the machine will start and injury may result.
- Use only sewing machine needles made for home use. Other needles may bend or break and may cause injury.
- Never sew with a bent needle. A bent needle will easily break and may cause injury.



Memo

To check the needle correctly, place the flat side of the needle on a flat surface. Check the needle from the top and the sides. Throw away any bent needles.

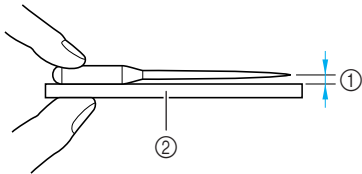

- ① Parallel space
- ② Level surface (bobbin cover, glass, etc.)

1

Press the “Needle Position” button to raise the needle.

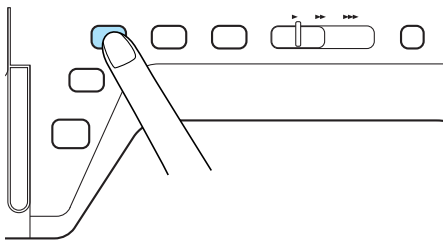

2

Press .

- * If “OK to automatically lower the presser foot?” appears on the LCD screen, press OK to continue.
- The entire screen becomes white, and all keys and operation buttons are locked.



Note

Before replacing the needle, cover the hole in the needle plate with fabric or paper to prevent the needle from falling into the machine.

3

Use the screwdriver to turn the screw toward the front of the machine and loosen the screw, then remove the needle.

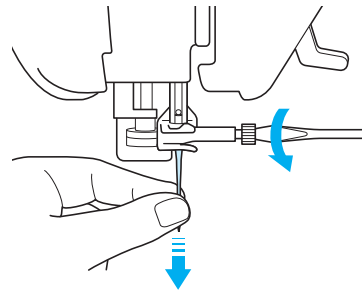

Note

- Do not apply pressure to the needle clamp screw. Doing so may damage the needle or machine.

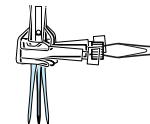

- 4** With the flat side of the needle facing the back, insert the new needle all the way to the top of the needle stopper (viewing window) in the needle clamp. Use a screwdriver to securely tighten the needle clamp screw.

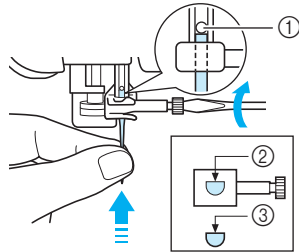

- ① Needle stopper
- ② Hole for setting the needle
- ③ Flat side of needle

⚠ CAUTION

- Be sure to push in the needle until it touches the stopper, and securely tighten the needle clamp screw with a screwdriver. If the needle is not completely inserted or the needle clamp screw is loose, the needle may break or the machine may be damaged.

- 5** Press  to unlock all keys and buttons.



1

Getting Ready

■ About the Needle

The sewing machine needle is probably the most important part of the sewing machine. Choosing the proper needle for your sewing project will result in a beautiful finish and fewer problems. Below are some things to keep in mind about needles.

- The smaller the needle number, the finer the needle. As the numbers increase, the needles get thicker.
- Use fine needles with lightweight fabrics, and thicker needles with heavyweight fabrics.
- To avoid skipped stitches, use ball point needle (golden colored) 90/14 with stretch fabrics.
- To avoid skipped stitches, use ball point needle (golden colored) 90/14 when sewing character or decorative stitches.
- Use needle 75/11 for embroidery. Use ball point needle 75/107 for embroidering patterns with short jump stitches such as alphabet characters when the thread trimming function is turned on. Ball point needles (golden colored) 90/14 are not recommended for embroidery, as they may bend or break, causing injury.
- It is recommended that a 90/14 needle should be used when embroidering on heavyweight fabrics or stabilizing products (for example, denim, puffy foam, etc.). A 75/11 needle may bend or break, which could result in injury.

■ Fabric/Thread/Needle Combinations

The following table provides information concerning the appropriate thread and needle for various fabrics. Please refer to this table when selecting a thread and needle for the fabric you wish to use.

Fabric		Thread		Size of needle
		Type	Size	
Medium weight fabric	Broadcloth	Cotton	60 - 80	75/11 - 90/14
	Taffeta	Synthetic mercerized	60 - 80	
	Flannel, Gabardine	Silk or silk finished	50	
Lightweight fabric	Lawn, Batiste	Cotton	60 - 80	65/9 - 75/11
	Georgette	Synthetic mercerized	60 - 80	
	Challis, Satin	Silk	50	
Heavyweight fabric	Denim	Cotton	30 - 50	90/14 - 100/16
	Corduroy	Synthetic mercerized	50	
	Tweed	Silk	50	
Stretch fabric	Jersey	Thread for knits	50 - 60	Ball point needle (golden colored) 75/11 - 90/14
	Tricot			
Easily frayed fabrics		Cotton thread	50 - 80	65/9 - 90/14
		Synthetic thread		
		Silk thread	50	
For top stitching		Synthetic mercerized	30	90/14 - 100/16
		Silk	30	



Memo

For transparent nylon thread, always use needle 90/14 - 100/16.

The same thread is usually used for the bobbin thread and upper threading.

⚠ CAUTION

- **Be sure to follow the needle, thread, and fabric combinations listed in the table. Using an improper combination, especially a heavyweight fabric (i.e., denim) with a small needle (i.e., 65/9 - 75/11), may cause the needle to bend or break, and lead to injury. Also, the seam may be uneven, the fabric may pucker, or the machine may skip stitches.**



Chapter 2

Sewing Basics

SEWING	44
Sewing a Stitch.....	44
■ Using the Foot Controller.....	45
Sewing Reinforcement Stitches	46
Sewing Curves.....	46
Changing Sewing Direction.....	46
■ Sewing a Seam Allowance of 0.5 cm or Less	46
Sewing Heavyweight Fabrics.....	47
■ If the Fabric does not Fit under the Presser Foot.....	47
■ If the Fabric does not Feed	47
Sewing Lightweight Fabrics	48
Sewing Stretch Fabrics	48
STITCH SETTINGS	49
Setting the Stitch Width	49
Setting the Stitch Length	49
Setting the Thread Tension.....	50
■ Proper Thread Tension	50
■ Upper Thread is Too Tight.....	50
■ Upper Thread is Too Loose.....	50
USEFUL FUNCTIONS	51
Automatic Reinforcement Stitching	51
Automatic Thread Cutting.....	52
■ Using the Knee Lifter.....	53
Pivoting	53
Automatic Fabric Sensor System (Automatic Presser Foot Pressure)	55
Locking the Screen	55

SEWING

! CAUTION

- To avoid injury, pay special attention to the needle while the machine is in operation. Keep your hands away from moving parts while the machine is in operation.
- Do not stretch or pull the fabric during sewing. Doing so may lead to injury.
- Do not use bent or broken needles. Doing so may lead to injury.
- Take care that the needle does not strike basting pins or other objects during sewing. Otherwise, the needle may break and cause injury.
- If stitches become bunched, lengthen the stitch length setting before continuing sewing. Otherwise, the needle may break and cause injury.

Sewing a Stitch

- 1 Turn the main power to ON, and push the "Needle Position" button to raise the needle.
- 2 Press the key of the stitch you want to sew.

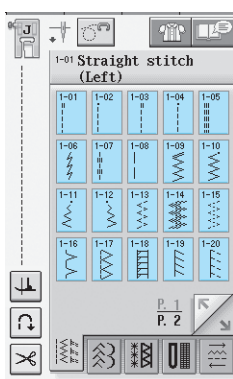

→ The symbol of the correct presser foot will be displayed in the upper left corner of the LCD.

- 3 Install the presser foot (see "CHANGING THE PRESSER FOOT" on page 37).

! CAUTION

- Always use the correct presser foot. If the wrong presser foot is used, the needle may strike the presser foot and bend or break, possibly resulting in injury.

- 4 Set the fabric under the presser foot. Hold the fabric and thread ends in your left hand, and turn the handwheel to set the needle in the sewing start position.

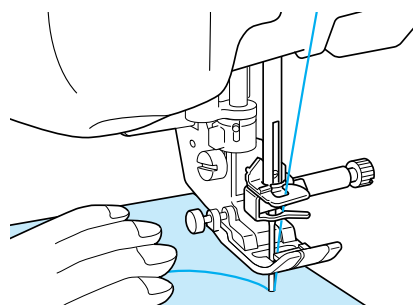
**Memo**

The black button on the left side of presser foot "J" should be pressed only if the fabric does not feed or when sewing thick seams (see page 47). Normally, you can sew without pressing the black button.

- 5 Lower the presser foot.
 - * You do not have to pull up the bobbin thread.
- 6 Adjust the sewing speed with the speed control slide.
 - * You can use this slide to adjust sewing speed during sewing.

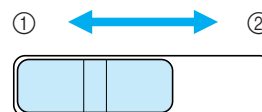

- ① Slow
- ② Fast

7 Press the "Start/Stop" button to start sewing.

- * Guide the fabric lightly by hand.

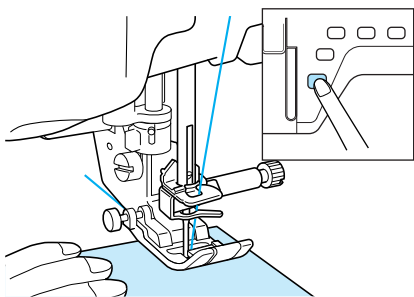

8 Press the "Start/Stop" button again to stop sewing.

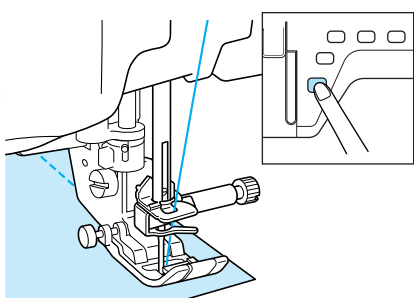

9 Press the "Thread Cutter" button to trim the threads.

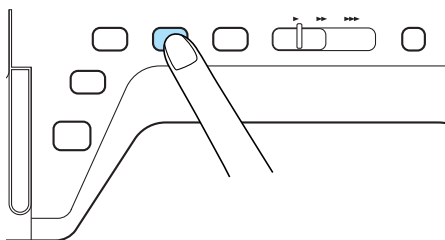

- The needle will return to the up position automatically.

! CAUTION

- Do not press the "Thread Cutter" button after the threads have been cut. Doing so could tangle the thread or break the needle and damage the machine.
- Do not press the "Thread Cutter" button when there is no fabric set in the machine or during machine operation. The thread may tangle, possibly resulting in damage.

Note

- When cutting thread thicker than #30, nylon thread, or other decorative threads, use the thread cutter on the side of the machine.

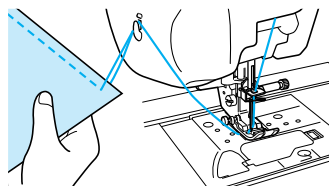

10 When the needle has stopped moving, raise the presser foot and remove the fabric.

Memo

This machine is equipped with a bobbin thread sensor that warns you when the bobbin thread is almost empty. When the bobbin thread is nearly empty, the machine automatically stops. However, if the "Start/Stop" button is pressed, a few stitches can be sewn. If the warning displays, re-thread the machine immediately.

Using the Foot Controller

You can also use the foot controller to start and stop sewing.

! CAUTION

Do not allow fabric pieces and dust to collect in the foot controller. Doing so could cause a fire or an electric shock.

Memo

- When the foot controller is being used, the "Start/Stop" button has no effect on sewing.
- The foot controller cannot be used when embroidering.
- The foot controller can be used for sewing utility and decorative stitches when the embroidery unit is attached.

1 Insert the foot controller plug into its jack on the machine.

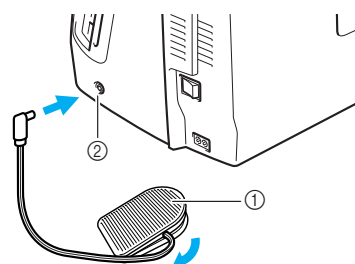

- ① Foot controller
② Foot controller jack

Note

Do not pull the retractable cord out beyond the red mark on the cord.



2

Sewing Basics

- 2 Slowly depress the foot controller to start sewing.

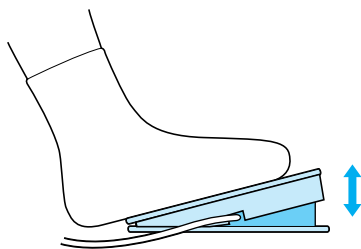

Memo
The speed set using the sewing speed controller is the foot controller's maximum sewing speed.

- 3 Release the foot controller to stop the machine.

Sewing Reinforcement Stitches

Reverse/reinforcement stitches are generally necessary at the beginning and end of sewing. You can use the "Reverse/Reinforcement Stitch" button to sew reverse/reinforcement stitches manually (see page 3).

If the automatic reinforcement stitch is selected on the screen, reverse stitches (or reinforcement stitches) will be sewn automatically at the beginning of sewing when the "Start/Stop" button is pressed. Press the "Reverse/Reinforcement Stitch" button to sew reverse stitches (or reinforcement stitches) automatically at the end of sewing (see page 51).

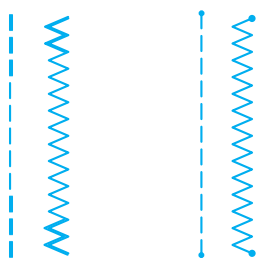

Sewing Curves

Sew slowly while keeping the seam parallel with the fabric edge as you guide the fabric around the curve.

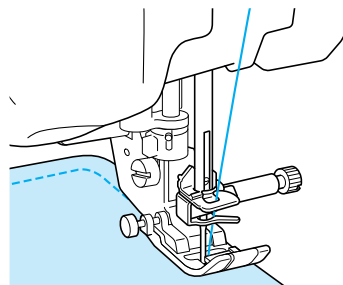

Changing Sewing Direction

Stop the machine. Leave the needle in the fabric, and press the "Presser Foot Lifter" button to raise the presser foot. Using the needle as a pivot, turn the fabric so that you can sew in the new direction. Press the "Presser Foot Lifter" button to lower the presser foot and start sewing.

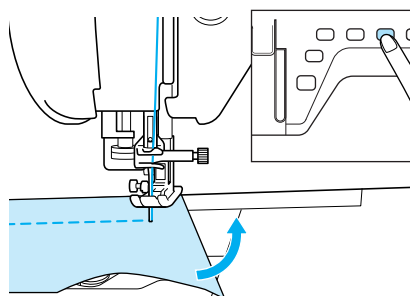

The pivot setting is useful when changing the sewing direction. When the machine is stopped at the corner of the fabric, the machine stops with the needle in the fabric and the presser foot is automatically raised so the fabric can easily be rotated (see "Pivoting" on page 53).

■ Sewing a Seam Allowance of 0.5 cm or Less

Baste the corner before sewing, and then, after changing the sewing direction at the corner, pull the basting thread toward the back while sewing.

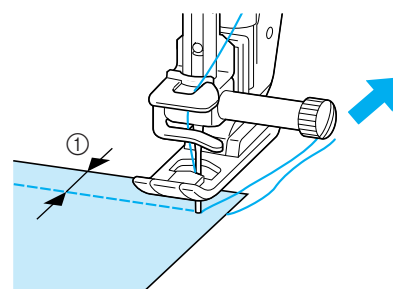

① 5 mm (approx. 3/16 inch)

Sewing Heavyweight Fabrics

The sewing machine can sew fabrics up to 6 mm (approx. 1/4 inch) thick. If the thickness of a seam causes sewing to occur at an angle, help guide the fabric by hand and sew on the downward slope.

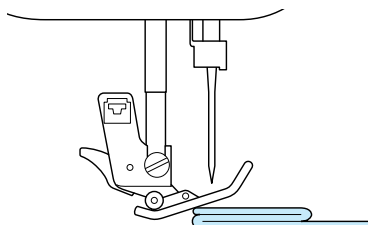

CAUTION

- Do not forcefully push fabrics more than 6 mm (approx. 1/4 inch) thick through the sewing machine. This may cause the needle to break and cause injury.

If the Fabric does not Fit under the Presser Foot

If the presser foot is in the up position, and you are sewing heavyweight or multiple layers of fabric which do not fit easily under the presser foot, use the presser foot lever to raise the presser foot to its highest position. The fabric will now fit under the presser foot.

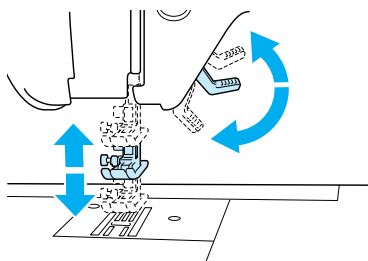

Memo

You cannot use the presser foot lever after the presser foot has been raised using the "Presser Foot Lifter" button.

If the Fabric does not Feed

If the fabric does not feed when starting to sew or when sewing thick seams, press the black button on the left side of presser foot "J".

- Raise the presser foot.
- While keeping the black button on the left side of presser foot "J" pressed in, press the "Presser Foot Lifter" button to lower the presser foot.

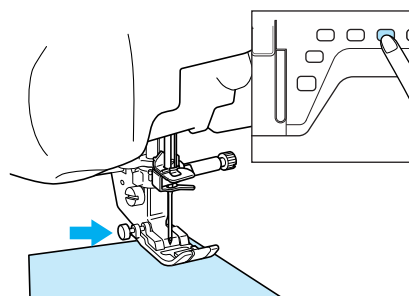

- Release the button.

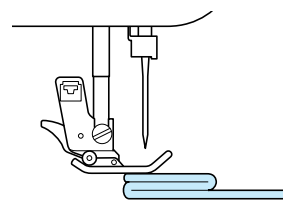

→ The presser foot remains level, enabling the fabric to be fed.



Memo

- Once the trouble spot has been passed, the foot will return to its normal position.
- When "AUTOMATIC FABRIC SENSOR SYSTEM" (Automatic Presser Foot Pressure) in the machine settings screen is set to "ON", the thickness of the fabric is automatically detected by the internal sensor so the fabric can be fed smoothly for best sewing results. (See page 55 for details.)



2

Sewing Basics

Sewing Lightweight Fabrics

Place thin paper or tear away embroidery stabilizer under thin fabrics to make sewing easier. Gently tear off the paper or the stabilizer after sewing.

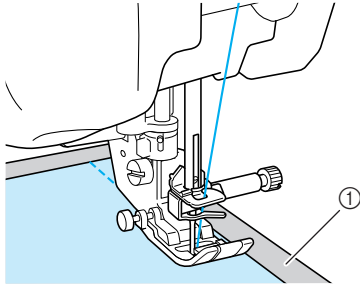

① Thin paper

Sewing Stretch Fabrics

First, baste together the pieces of fabric, and then sew without stretching the fabric.

In addition, a better result can be achieved by using thread for knits or a stretch stitch.



Memo

- For best results when sewing stretch fabrics, decrease the pressure of the presser foot.

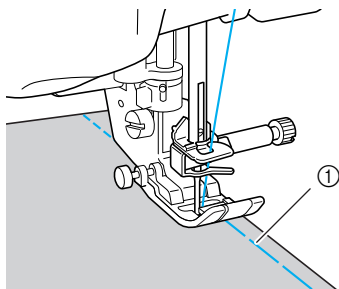

① Basting stitching

STITCH SETTINGS

When you select a stitch, your machine automatically selects the appropriate stitch width, stitch length, and upper thread tension. However, if needed, you can change any of the individual settings.

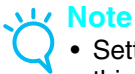

Note

- Settings for some stitches cannot be changed (refer to the “STITCH SETTING CHART” at the end of this manual).
- If you turn off the machine or select another stitch without saving stitch setting changes (see “Saving Your Stitch Settings” on page 60), the stitch settings will return to their default settings.



2

Sewing Basics

Setting the Stitch Width

Follow the steps below when you want to change the zigzag stitch pattern width.

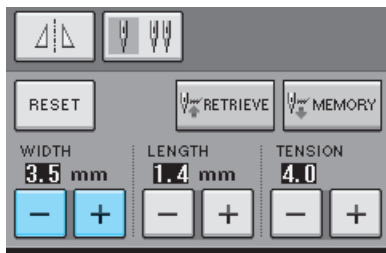

Memo

- For an alternate method of changing the stitch width using the speed controller, see page 82.

Example:

Press **-** to narrow the zigzag stitch pattern width.

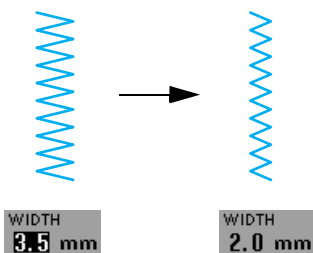

→ The value in the display gets smaller.

Press **+** to widen the zigzag stitch pattern width.

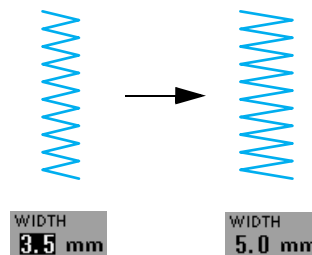

→ The value in the display gets bigger.



Memo

- Press **RESET** to return the stitch width to the original setting.



Note

After adjusting the stitch width, slowly turn the handwheel toward you (counterclockwise) and check that the needle does not touch the presser foot. If the needle hits the presser foot, the needle may bend or break.

Setting the Stitch Length

Follow the steps below when you want to change the stitch pattern length.

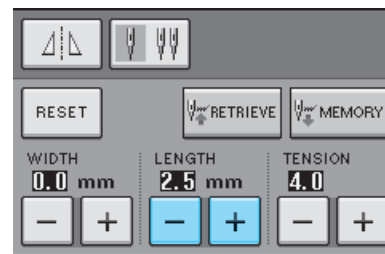

Example:

Press **-** to shorten the stitch length.

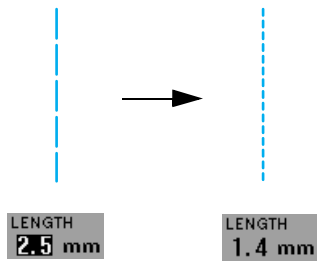

→ The value in the display gets smaller.

Press **+** to lengthen the stitch length.

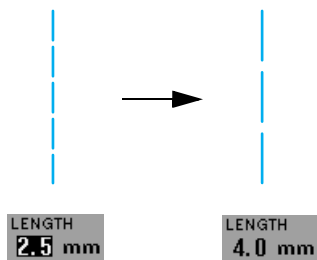

→ The value in the display gets bigger.

Memo

- Using the Image Key, you can check changes made to the stitch.
- Press **RESET** to return the stitch length to the original setting.

CAUTION

If the stitches get bunched together, lengthen the stitch length and continue sewing. Do not continue sewing without lengthening the stitch length. Otherwise, the needle may break and cause injury.

Setting the Thread Tension

You may need to change the thread tension, depending on the fabric and thread being used. Follow the steps below to make any necessary changes.

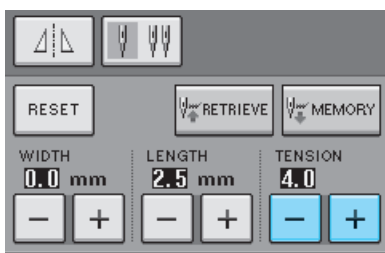

Proper Thread Tension

The upper and lower threads should cross near the center of the fabric. If the thread tension is not properly set, the seam may have a poor finish or the fabric may pucker.

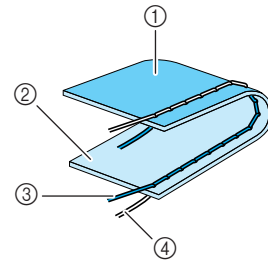

- ① Wrong side
- ② Surface
- ③ Upper thread
- ④ Bobbin thread

Upper Thread is Too Tight

If the bobbin thread can be seen on the surface of the fabric, press **-**.

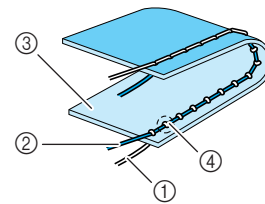

- ① Bobbin thread
- ② Upper thread
- ③ Surface
- ④ Locks appear on surface of fabric

Upper Thread is Too Loose

If the upper thread can be seen on the wrong side of the fabric, press **+**.

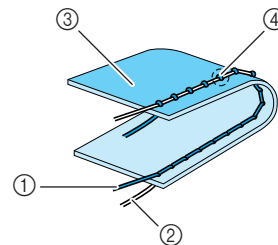

- ① Upper thread
- ② Bobbin thread
- ③ Wrong side
- ④ Locks appear on wrong side of fabric

Memo

- Press **RESET** to return the thread tension to the original setting.

USEFUL FUNCTIONS

Automatic Reinforcement Stitching

After selecting a stitch pattern, turn on the automatic reinforcement stitching function before sewing, and the machine will automatically sew reinforcement stitches (or reverse stitches, depending on the stitch pattern) at the beginning and end of sewing.

- 1 Select a stitch pattern.
- 2 Press  to set the automatic reinforcement stitching function.

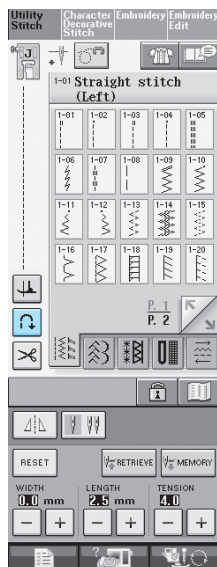

→ The key will display as .

Memo

Some stitches, such as buttonholes and bar tacks, require reinforcement stitches at the beginning of sewing. If you select one of these stitches, the machine will automatically turn on

this function (the key appears as  when the stitch is selected).

- 3 Set the fabric in the start position and start sewing.

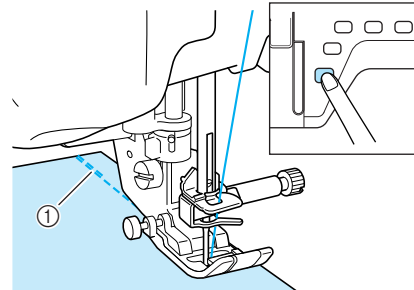

- ① Reverse stitches (or reinforcement stitches)
 - The machine will automatically sew reverse stitches (or reinforcement stitches) and then continue sewing.

Memo

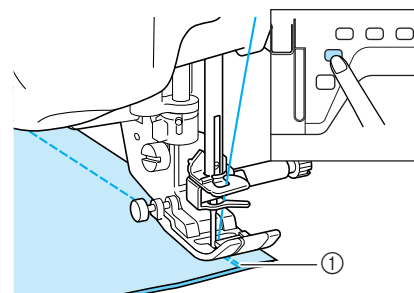

If you press the “Start/Stop” button to pause sewing, press it again to continue. The machine will not sew reverse reinforcement stitches again.

- 4 Press the “Reverse/Reinforcement Stitch” button.



- ① Reverse stitches (or reinforcement stitches)
 - The machine will sew reverse stitches (or reinforcement stitches) and stop.

Memo

To turn off the automatic reinforcement stitching function, press  again, so it appears as .



2

Sewing Basics

Automatic Thread Cutting

After selecting a stitch pattern, turn on the automatic thread cutting function before sewing, and the machine will automatically sew reinforcement stitches (or reverse stitches, depending on the stitch pattern) at the beginning and end of sewing, and trim the threads at the end of sewing. This function is useful when sewing buttonholes and bar tacks.

- 1 Select a stitch pattern.
- 2 Press  to set the automatic thread cutting function.

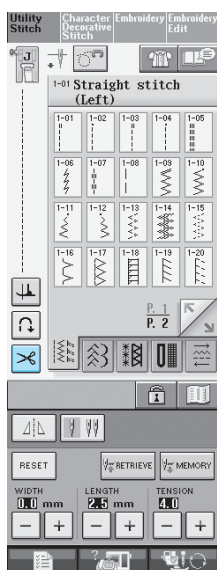

→ The key will display as  .

 **Memo**
This function is set automatically when sewing embroidery.

- 3 Set the fabric in the start position and start sewing.

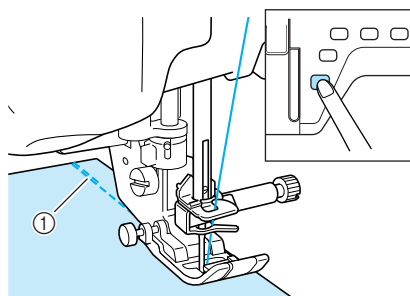



- ① Reverse stitches (or reinforcement stitches)
→ The machine will automatically sew reverse stitches (or reinforcement stitches) and then continue sewing.

 **Memo**
If you press the “Start/Stop” button to pause sewing, press the same button again to continue. The beginning reverse/reinforcement stitches will not be sewn again.

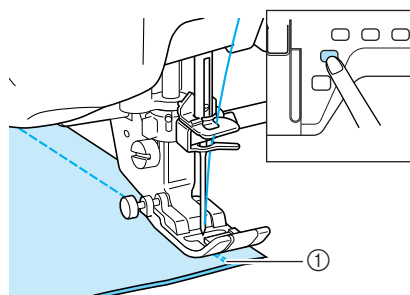
- 4 Press the “Reverse/Reinforcement Stitching” button.



- ① Reverse stitches (or reinforcement stitches)
→ The machine will sew reverse stitches (or reinforcement stitches), then trim the thread.

 **Memo**
To turn off the automatic thread cutting function, press  again, so it appears as  .

Using the Knee Lifter

Using the knee lifter, you can raise and lower the presser foot with your knee, leaving both hands free to handle the fabric.

- 1 Align the tabs on the knee lifter with the notches in the jack, and then insert the knee lifter as far as possible.

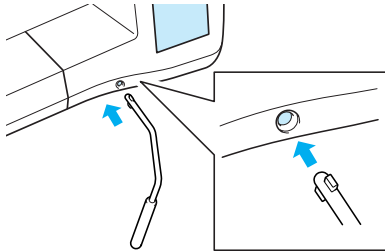

Note

If the knee lifter is not pushed into the mounting slot as far as possible, it may come out during use.

- 2 Use your knee to move the knee lifter to the right in order to raise the presser foot. Release the knee lifter to lower the presser foot.

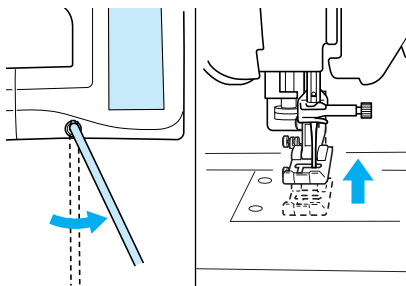

CAUTION

Be sure to keep your knee away from the knee lifter during sewing. If the knee lifter is pushed during machine operation, the needle may break or the thread tension may loosen.

Pivoting

If the pivot setting is selected, the machine stops with the needle lowered (in the fabric) and the presser foot is automatically raised to an appropriate height when the "Start/Stop" button is pressed. When the "Start/Stop" button is pressed again, the presser foot is automatically lowered and sewing continues. This function is useful for stopping the machine to rotate the fabric.

CAUTION

- When the pivot setting is selected, the machine starts when the "Start/Stop" button is pressed or the foot controller is pressed down even if the presser foot has been raised. Be sure to keep your hands and other items away from the needle, otherwise injuries may occur.



Memo

When the pivot setting is selected, the height of the presser foot when sewing is stopped can be changed according to the type of fabric being sewn. Press to display "PIVOTING HEIGHT" on P. 1 of the settings screen. Press or to select one of the three heights (3.2 mm, 5.0 mm or 7.5 mm). To raise the presser foot further, increase the setting. (Normally, 3.2 mm is set.)

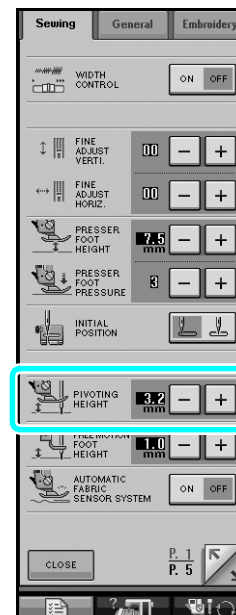





2

Sewing Basics





Note

- The “NEEDLE POSITION” (P. 2 of the settings screen) must be set in the down position  for the pivot function to be used. When “NEEDLE POSITION” is set in the raised position,  appears as light gray and cannot be used.
- When the setting is selected, the pivot function can only be used with stitches where presser foot J or N is indicated in the upper-left corner of the screen. If any other stitch is selected,  appears as light gray and is not available.
- Since the presser foot is fully raised when the automatic thread cutting key is pressed, press the “Presser Foot Lifter” button to lower the presser foot, and then press the “Start/Stop” button to continue sewing.
- If the pivot setting is selected,  and  beside “PRESSER FOOT HEIGHT” in the settings screen are not available and the setting cannot be changed.

1 Select a stitch.

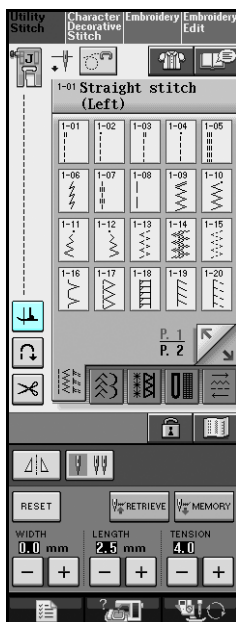
2 Press  to select the pivot setting.



→ The key appears as .

3 Place the fabric under the presser foot with the needle at the starting point of the stitching, and then press the “Start/Stop” button. The machine will begin sewing.

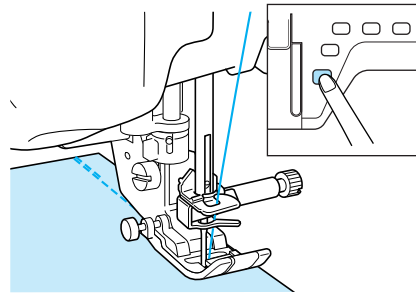

Memo

If you press the “Start/Stop” button to pause sewing, then press it again to continue, reverse stitches (or reinforcement stitches) will not be sewn.

4 Press the “Start/Stop” button to stop the machine at the point where the sewing direction changes.

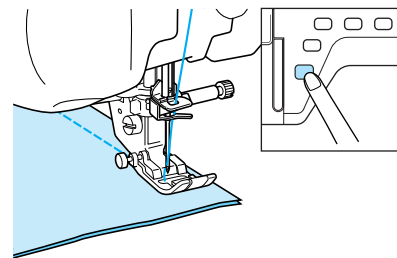

→ The machine stops with the needle in the fabric, and the presser foot is raised.

5 Rotate the fabric, and then press the “Start/Stop” button.

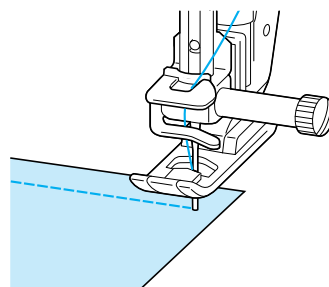

→ The presser foot is automatically lowered, and sewing continues.

Automatic Fabric Sensor System (Automatic Presser Foot Pressure)

The thickness of the fabric is automatically detected and the presser foot pressure is automatically adjusted with an internal sensor while sewing, so your fabric is fed smoothly. The fabric sensor system works continuously while sewing. This function is useful for sewing over thick seams (see page 47), or quilting (see page 80).

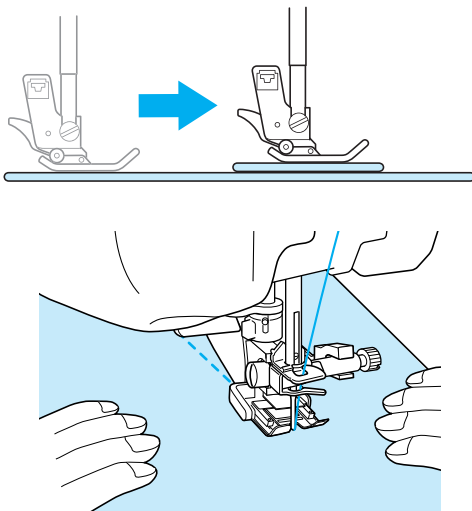

1 Press  .
→ The settings screen appears.

2 Set "AUTOMATIC FABRIC SENSOR SYSTEM" to "ON".

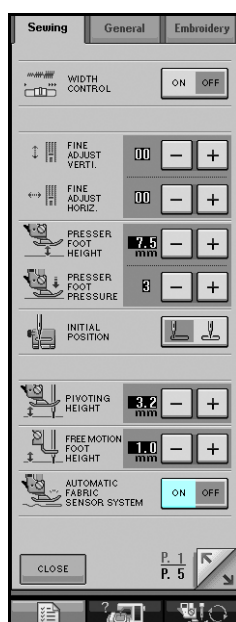

3 Press  to return to the original screen.

Locking the Screen

If the screen is locked before starting to sew, the various settings such as the stitch width and stitch length are locked and cannot be changed. This prevents screen settings from accidentally being changed or the machine from being stopped while large pieces of fabric or projects are being sewn. The screen can be locked when sewing utility stitches and character decorative stitches.

1 Select a stitch pattern.

2 If necessary, adjust any settings such as the stitch width and stitch length.



3 Press  to lock the screen settings.

→ The key appears as  .

4 Sew your project.

5 When you are finished sewing, press  again to unlock the screen settings.

CAUTION

- If the screen is locked (), unlock the screen by pressing  . While the screen is locked, no other key can be operated.
- The settings are unlocked when the machine is turned off and on.



2

Sewing Basics

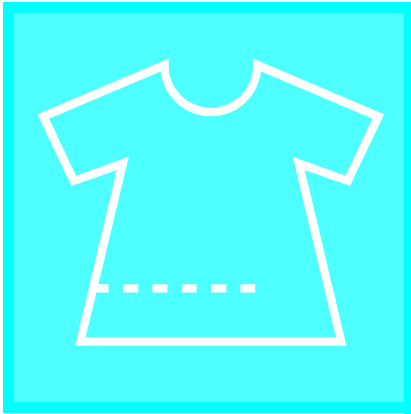

Chapter 3

Utility Stitches

SELECTING UTILITY STITCHES.....58

- Stitch Selection Screens..... 58
- Selecting a Stitch 59
 - Using the Mirror Image Key 59
 - Using the Image Key..... 59
- Saving Your Stitch Settings 60
 - Saving Settings..... 60
 - Retrieving Saved Settings..... 61
- Using the Sewing Type Selection Key 61

SEWING THE STITCHES.....63

- Straight Stitches 63
 - Changing the Needle Position (Left or Middle Needle Position Stitches Only)..... 65
 - Needle Plate and Needle Plate Cover Marks 65
 - Using the Straight Stitch Needle Plate and the Straight Stitch Foot 65
 - Basting 67
- Dart Seam 67
- Gathering..... 68
- Flat Fell Seam..... 69
- Pintuck..... 69
- Zigzag Stitches..... 71
 - Overcasting (Using a Zigzag Stitch) 71
 - Appliqué (Using a Zigzag Stitch) 71
 - Patchwork (for Crazy Quilt)..... 72
 - Sewing Curves (Using a Zigzag Stitch) 72
 - Cord Guide Bobbin Cover (Using a Zigzag Stitch) 72
- Elastic Zigzag Stitches..... 73
 - Tape Attaching 73
 - Overcasting 73
- Overcasting 74
 - Overcasting Using Presser Foot “G” 74
 - Overcasting Using Presser Foot “J” 75
 - Overcasting Using the Side Cutter 76
 - When Sewing Straight Stitches While Using the Side Cutter 78
- Quilting 79
 - Piecing 80
 - Quilting..... 80
 - Appliqué..... 81
 - Quilting with Satin Stitches 82
 - Free-motion Quilting..... 83
 - Echo Quilting Using the Free-motion Echo Quilting Foot “E” .. 86
- Blind Hem Stitches 89
 - If the Needle does not Catch the Fold..... 90
 - If the Needle Catches Too Much of the Fold 90
- Appliqué 90
 - Sewing Sharp Curves 91
- Shelltuck Stitches..... 91
- Scallop Stitches..... 92
- Top Stitching..... 92
- Smocking Stitches 93
- Fagoting..... 93
- Tape or Elastic Attaching 94
- Heirloom 95
 - Hemstitching (1) (Daisy Stitch) 95
 - Hemstitching (2) (Drawn Work (1)) 95
 - Hemstitching (3) (Drawn Work (2)) 96

- One-step Buttonholes.....97
 - Sewing Stretch Fabrics.....100
 - Odd Shaped Buttons/Buttons that do not Fit into the Button Holder Plate.....100
- Four-step Buttonholes.....103
 - Darning.....103
- Bar Tacks105
 - Bar Tacks on Thick Fabrics.....106
- Button Sewing107
 - Attaching 4 Hole Buttons.....108
 - Attaching a Shank to the Button108
- Eyelet.....109
- Multi-directional Sewing (Straight Stitch and Zigzag Stitch) 110
- Zipper Insertion 111
 - Centered Zipper 111
 - Inserting a Side Zipper 112

SELECTING UTILITY STITCHES

Stitch Selection Screens

There are 5 categories of Utility Stitches.

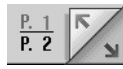

indicates that there is more than one stitch selection screen for that category.

Straight/Overcasting/Quilting Stitches

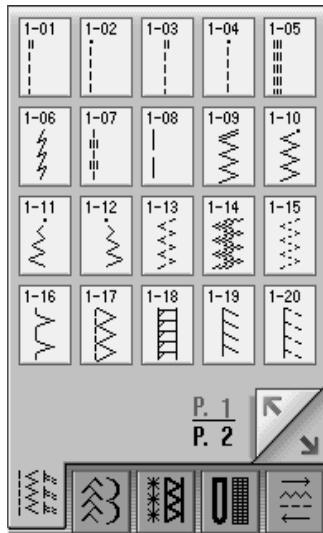

Decorative Stitches

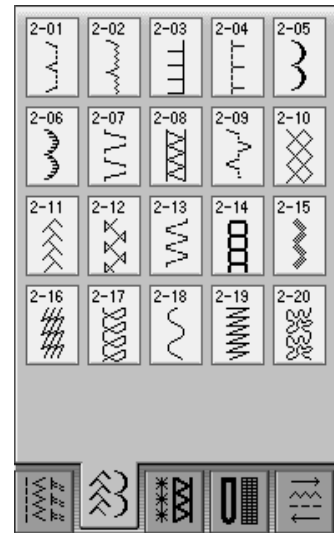

Heirloom Stitches

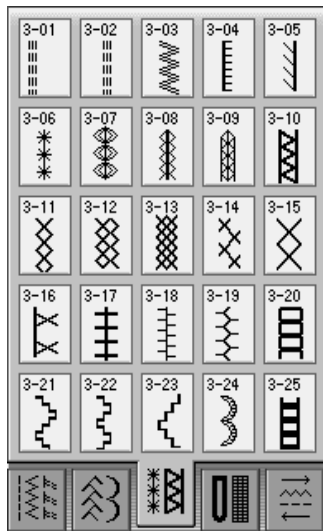

Buttonholes/Bar tacks

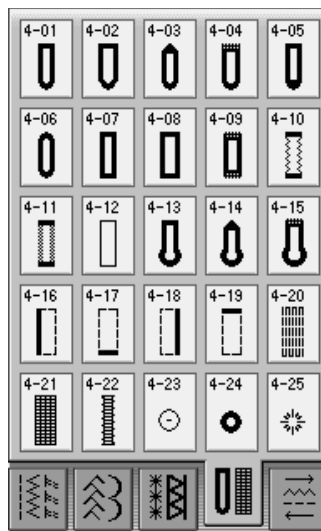

Multi-directional Sewing

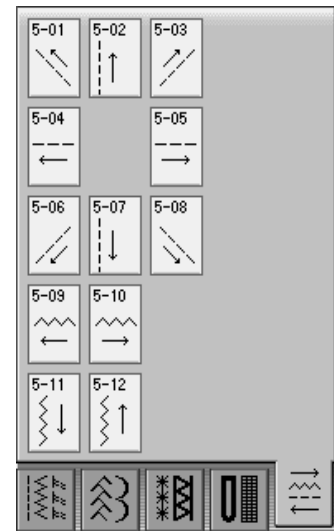

Selecting a Stitch

1 Turn the main power to ON.

→ Either “1-01 Straight stitch (Left)” or “1-03 Straight stitch (Middle)” is selected, depending on the setting selected in the setting screen.

2 Use to select the category you want.

* Press  to view this screen if another screen displays.

* Press  to view the next page.

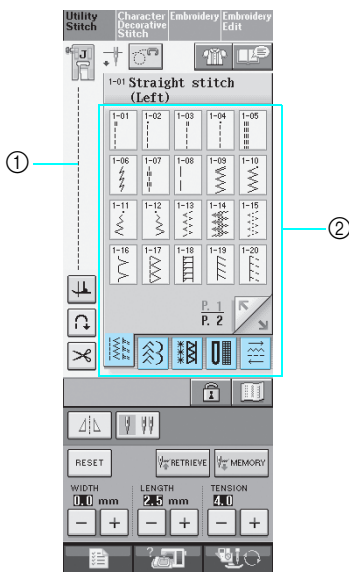

- ① Preview of the selected stitch
- ② Stitch selection screen

3 Press the key of the stitch you want to sew.



Memo

For details on each stitch, refer to the “STITCH SETTING CHART” at the end of this manual.

Using the Mirror Image Key

Depending on the type of utility stitch you select, you may be able to sew a horizontal mirror image of the stitch.

If  is lit when you select a stitch, it will be possible to make a mirror image of the stitch.



Note

If  is light gray after you select a stitch, you cannot create a horizontal mirror image of the selected stitch (this is true of buttonholes, multi-directional sewing, and others).

Press  to create a horizontal mirror image of the selected stitch.

The key will display as .



Using the Image Key

You can display an image of the selected stitch. You can also check and change the colors of the image on the screen.

1 Press .





→ An image of the selected stitch is displayed.



3

Utility Stitches

2 Press  to change the thread color of the stitch on the screen.

* Press  to display an enlarged image of the stitch.

Memo

- The color changes every time you press .
- The units of the stitch display area are in mm.

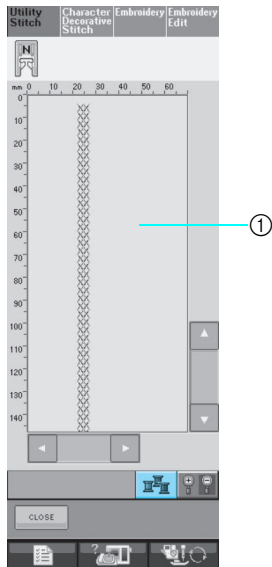

① Stitch screen

3 Press  to go back to the original screen.

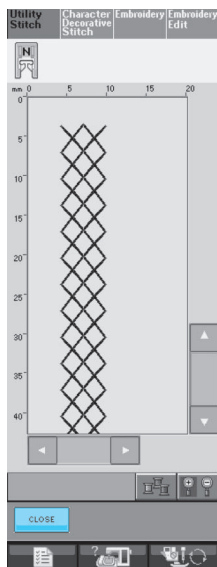

Saving Your Stitch Settings

The settings for the zigzag stitch width, stitch length, thread tension, automatic thread cutting, automatic reinforcement stitching, etc., are preset in the machine for each stitch. However, if you have specific settings that you wish to reuse later for a stitch, you can change the settings so that they can be saved for that stitch. Five sets of settings can be saved for a single stitch.

■ Saving Settings

1 Select a stitch. (Example: )

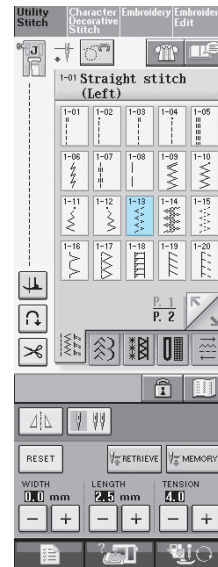

2 Specify your preferred settings.

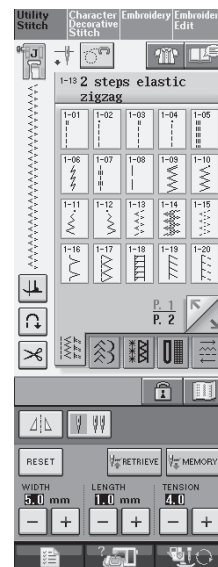

3 Press .

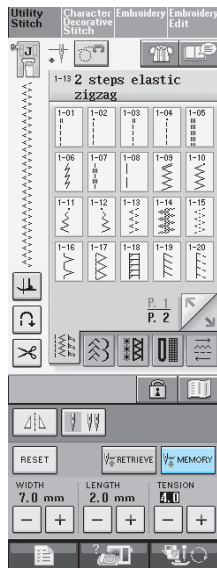

→ The settings are saved and the original screen automatically appears.

 **Memo**

If you try to save settings when there are already 5 sets of settings saved for a stitch, the message “The pockets are full. Delete a pattern” will appear. Close the message and refer to “Deleting Saved Settings” on this page.

Retrieving Saved Settings

1 Select a stitch.

 **Memo**

When a stitch is selected, the last settings retrieved are displayed. The last settings retrieved are retained even if the machine was turned off or a different stitch was selected.

2 Press .

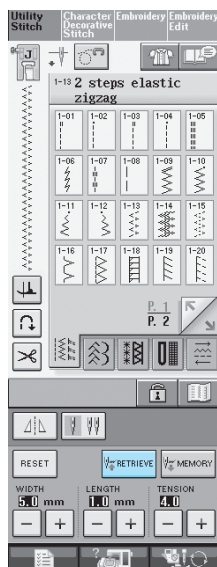

3 Press the numbered key of the settings to be retrieved.

* Press  to return to the original screen without retrieving settings.

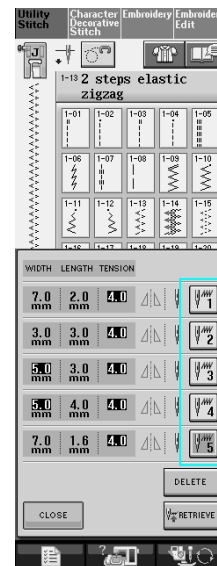





① Numbered keys

4 Press .

→ The selected settings are retrieved, and the original screen automatically appears.

 **Memo**

Deleting Saved Settings

You can delete the selected setting by pressing . Press the numbered key of the setting to be deleted. Press , press  and then . The new setting will be saved in place of the recently deleted setting.

Using the Sewing Type Selection Key

You can also select utility stitches using . Use this key when you are not sure which stitch to use for your application, or to get advice about sewing particular stitches. For example, if you want to sew overcasting, but you do not know which stitch to use or how to sew the stitch, you can use this screen to get advice. We recommend that beginners use this method to select stitches.



Utility Stitches

Example: Displaying information about overcasting

1 Press .

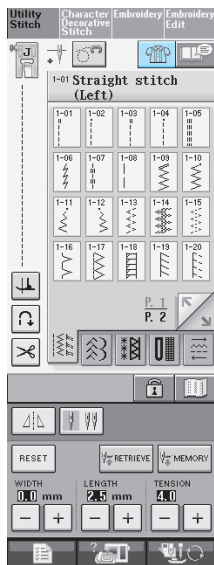

→ The advice screen is displayed.

2 Press .

* Press  to return to the original screen.

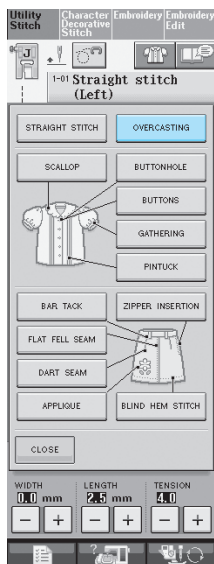

→ The upper part of the screen displays a selection of overcasting stitches with explanations.

3 Read the explanations and select the appropriate stitch.

* Press  or  to scroll the page.

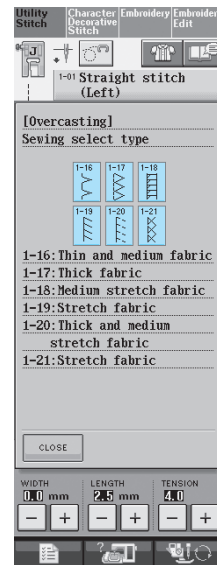

→ The screen displays directions for sewing the selected stitch.





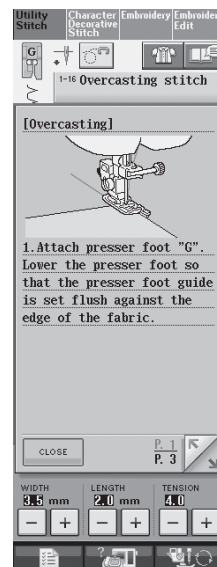



4 Follow the directions to sew the stitch.

* Press  to view the next page.



SEWING THE STITCHES

Straight Stitches

Stitch	Stitch name	Presser foot	Applications	Stitch width [mm (inch.)]		Stitch length [mm (inch.)]		Twin needle
				Auto.	Manual	Auto.	Manual	
1-01	Straight stitch (Left)		General sewing, gather, pintuck, etc. Reverse stitch is sewn while pressing "Reverse/Reinforcement Stitch" button.	0.0 (0)	0.0 - 7.0 (0 - 1/4)	2.5 (3/32)	0.2 - 5.0 (1/64 - 3/16)	OK (J)
1-02	Straight stitch (Left)		General sewing, gather, pintuck, etc. Reinforcement stitch is sewn while pressing "Reverse/Reinforcement Stitch" button.	0.0 (0)	0.0 - 7.0 (0 - 1/4)	2.5 (3/32)	0.2 - 5.0 (1/64 - 3/16)	OK (J)
1-03	Straight stitch (Middle)		General sewing, gather, pintuck, etc. Reverse stitch is sewn while pressing "Reverse/Reinforcement Stitch" button.	3.5 (1/8)	0.0 - 7.0 (0 - 1/4)	2.5 (3/32)	0.2 - 5.0 (1/64 - 3/16)	OK (J)
1-04	Straight stitch (Middle)		General sewing, gather, pintuck, etc. Reinforcement stitch is sewn while pressing "Reverse/Reinforcement Stitch" button.	3.5 (1/8)	0.0 - 7.0 (0 - 1/4)	2.5 (3/32)	0.2 - 5.0 (1/64 - 3/16)	OK (J)
1-05	Triple stretch stitch		General sewing for reinforcement and decorative topstitching	0.0 (0)	0.0 - 7.0 (0 - 1/4)	2.5 (3/32)	1.5 - 4.0 (1/16 - 3/16)	OK (J)
1-06	Stem stitch		Reinforced stitching, sewing and decorative applications	1.0 (1/16)	1.0 - 3.0 (1/16 - 1/8)	2.5 (3/32)	1.0 - 4.0 (1/16 - 3/16)	OK (J)
1-07	Decorative stitch		Decorative stitching, top stitching	0.0 (0)	0.0 - 7.0 (0 - 1/4)	2.5 (3/32)	1.0 - 4.0 (1/16 - 3/16)	OK (J)
1-08	Basting stitch		Basting	0.0 (0)	0.0 - 7.0 (0 - 1/4)	20.0 (3/4)	5.0 - 30.0 (3/16 - 1-3/16)	NO

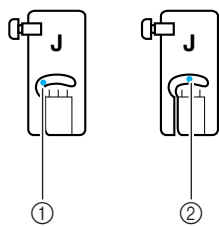

- ① Left needle position
- ② Middle needle position

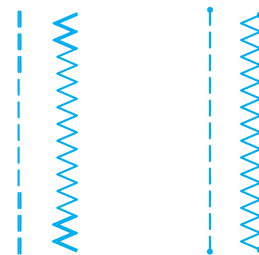

- ① Reverse stitch
- ② Reinforcement stitch



Memo

If the selected stitch has a double mark " " at the top of the key display, you can sew reverse stitches holding the "Reverse/Reinforcement Stitch" button.

If the selected stitch has a dot mark " · " at the top of the key display, you can sew reinforcement stitches holding the "Reverse/Reinforcement Stitch" button (see page 46).



3

Utility Stitches

1 Select a stitch.

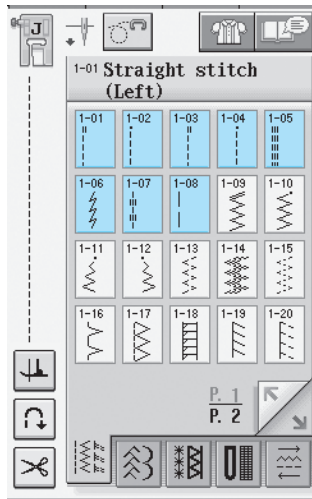

2 Attach presser foot "J".

* Attach presser foot "N" when you select  .

3 Hold the thread tails and fabric with your left hand, and turn the handwheel with your right hand to insert the needle into the fabric.

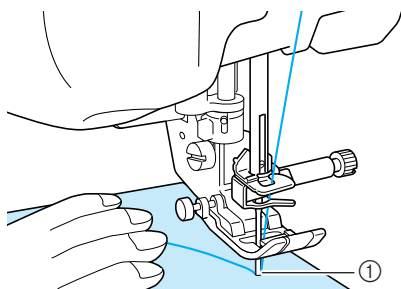

① Sewing start position

4 Lower the presser foot, and hold the "Reverse/Reinforcement Stitch" button to sew 3-4 stitches.

→ The machine sews reverse stitches (or reinforcement stitches).

5 Press the "Start/Stop" button to sew forward.

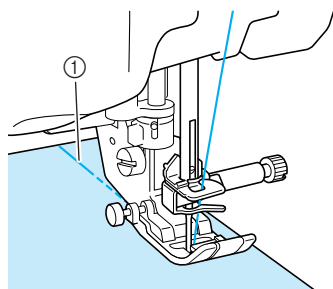

① Reverse stitches

→ The machine will begin sewing slowly.

! CAUTION

Be sure the needle does not strike a basting pin, or any other objects, during sewing. The thread could tangle or the needle could break, causing injury.

6 When sewing is completed, hold the "Reverse/Reinforcement Stitch" button to sew 3-4 reverse stitches (or reinforcement stitches) at the end of the seam.

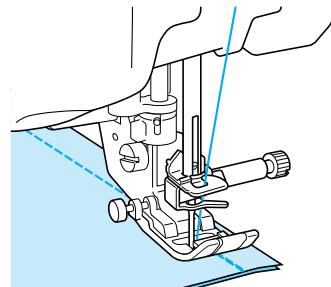

7 After sewing, press the "Thread Cutter" button to trim the threads.

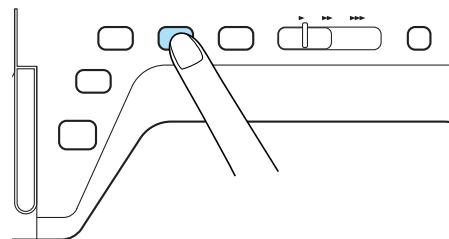

Memo

When the automatic thread cutting and automatic reinforcement stitch keys on the screen are selected, reverse stitches (or reinforcement stitches) will be sewn automatically at the beginning of sewing when the "Start/Stop" button is pressed. Press the "Reverse/Reinforcement Stitch" button to sew reverse stitches (or reinforcement stitches) and trim the thread automatically at the end of sewing.

Changing the Needle Position (Left or Middle Needle Position Stitches Only)

When you select left or middle needle position stitches, you can use **-** and **+** in the stitch width display to change the position of the needle. Match the distance from the right edge of the presser foot to the needle with the stitch width, then align the edge of the presser foot with the edge of the fabric during sewing for an attractive finish.

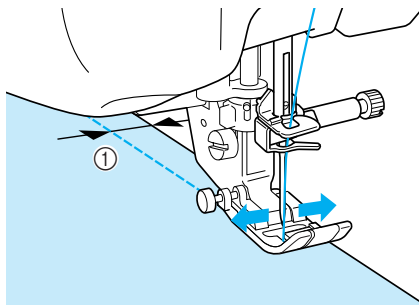

① Stitch width

Example: Left/Middle needle position stitches

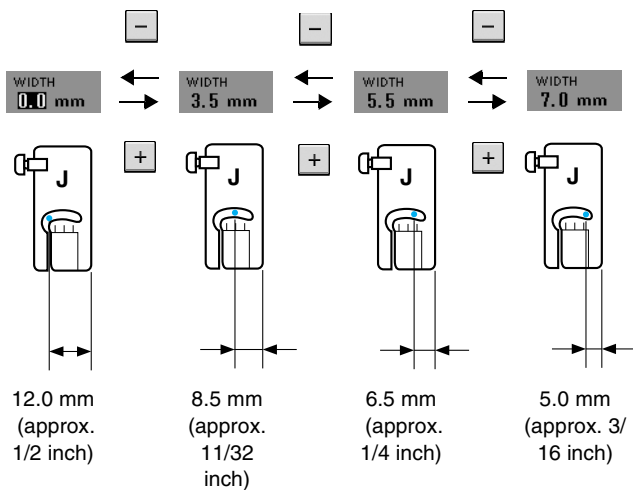

Needle Plate and Needle Plate Cover Marks

For a standard 16 mm (approx. 5/8 inch) seam allowance, set the width to 0.0 mm on the screen. While sewing, align the edge of the fabric with the 16 mm (approx. 5/8 inch) mark on the needle plate.

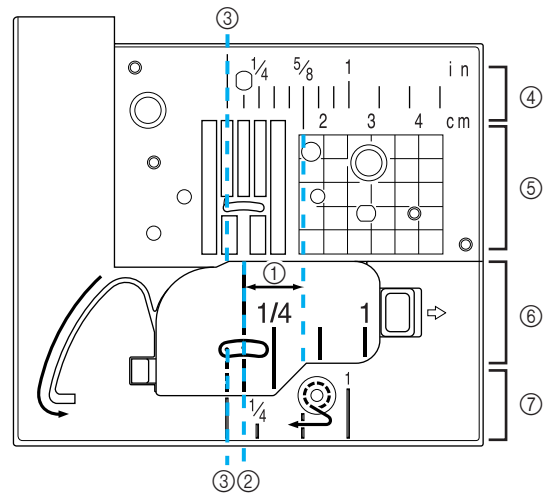

- ① 16 mm (approx. 5/8 inch)
- ② For stitches with a middle (center) needle position
- ③ For stitches with a left needle position
- ④ Left needle position on the needle plate <inch>
- ⑤ Left needle position on the needle plate <cm>
- ⑥ Middle (center) needle position on the bobbin cover <inch>
- ⑦ Left needle position on the needle plate cover <inch>

Using the Straight Stitch Needle Plate and the Straight Stitch Foot

The straight stitch needle plate and the straight stitch foot can only be used for straight stitches (middle needle position stitches). Use the straight stitch needle plate and the straight stitch foot when sewing thin fabrics or when sewing small pieces which tend to sink into the hole of the regular needle plate during sewing. The straight stitch foot is perfect to reduce puckering on lightweight fabrics. The small opening on the foot provides support for the fabric as the needle travels through the fabric.

CAUTION

Always use the straight stitch foot in combination with the straight stitch needle plate.



3

Utility Stitches

- 1 Press the “Presser Foot Lifter” button to raise the presser foot and turn the main power to OFF.
- 2 Remove the flat bed attachment or the embroidery unit if either are attached.
- 3 Grasp both sides of the needle plate cover, and then slide it toward you.

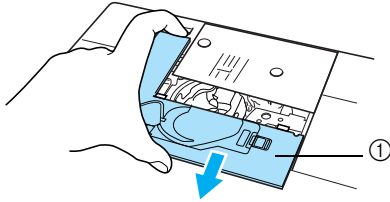

① Needle plate cover

- 4 Grasp the bobbin case, and then pull it out.

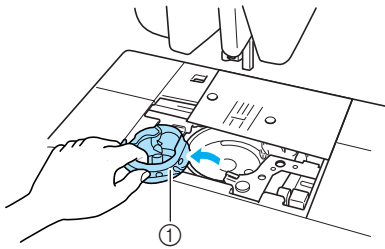

① Bobbin case

- 5 Use the screwdriver included with the machine to unscrew and remove the regular needle plate.

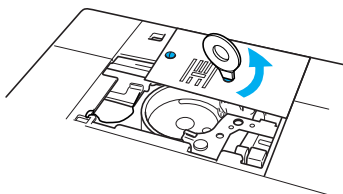

- 6 Set the straight stitch needle plate in place and use the screwdriver to tighten the plate.

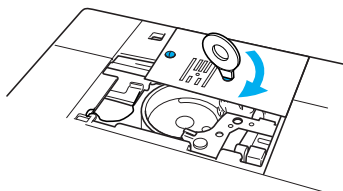

Note

Align the two screw holes on the needle plate with the two holes on the machine and screws in the needle plate.

- 7 Insert the bobbin case in its original position, and then attach the needle plate cover.
- 8 After reinstalling the needle plate cover, select any of the straight stitches.



Memo

- When using the straight stitch needle plate, all straight stitches become middle needle position stitches. You cannot change the needle position using the width display.
- Always secure the needle plate before inserting the bobbin case into its original position.



CAUTION

- Selecting other stitches will cause an error message to be displayed.
- Be sure to turn the handwheel slowly in your direction before sewing and make sure that the needle is not contacting the straight stitch foot and straight stitch needle plate.

- 9 Attach the straight stitch foot.

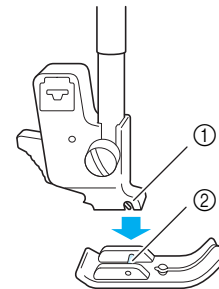

- ① Notch
- ② Pin

- 10 Start sewing.

* After sewing, make sure to remove the straight stitch needle plate and the straight stitch foot, and reinstall the regular needle plate, the needle plate cover and the presser foot “J”.



Memo

To prevent puckering on fine fabrics, use a fine needle, size 75/11, and a short stitch length. For heavier fabrics, use a heavier needle, size 90/14, and longer stitches.

■ Basting

- 1 Select  and attach presser foot "J".
- 2 Press the "Reverse/Reinforcement Stitch" button to sew reinforcement stitches, then continue sewing.

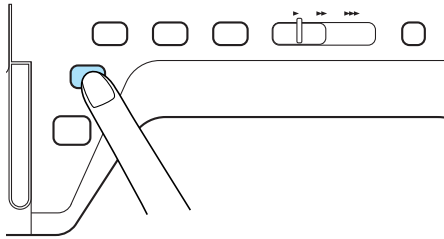

Memo

If you do not want to use a reinforcement stitch at the beginning; you should lift the presser foot, rotate the handwheel, pull up the bobbin thread and pull a length of top and bobbin thread out from the rear of the machine.

You can set the stitch length between 5 mm (approx. 3/16 inch) and 30 mm (approx. 1-3/16 inches)

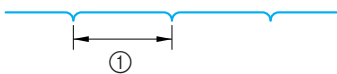

- ① Between 5 mm (approx. 3/16 inch) and 30 mm (approx. 1-3/16 inches)

- 3 Sew while keeping the fabric straight.

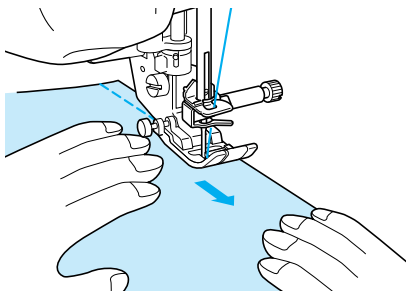

- 4 End the basting with reinforcement stitches.

Dart Seam

- 1 Select  and attach presser foot "J".
- 2 Sew a reverse stitch at the beginning of the dart and then sew from the wide end to the other end without stretching the fabric.

* If automatic reinforcement stitching is preset, a reinforcement stitch will automatically be sewn at the beginning of sewing.

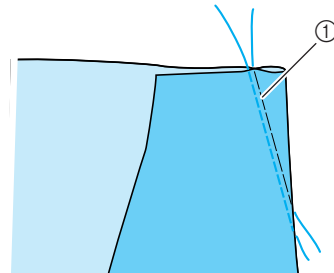

- ① Basting

- 3 Cut the thread at the end leaving 50 mm (approx. 1-15/16 inches), and then tie both ends together.

* Do not sew a reverse stitch at the end.

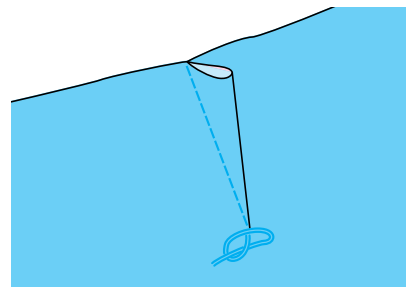

- 4 Insert the ends of the thread into the dart with a needle.

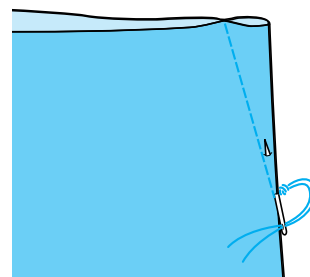

3

Utility Stitches

5 Iron the dart to one side so that it is flat.

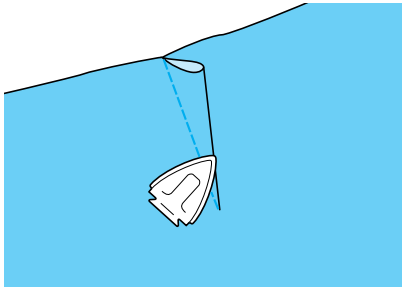

Gathering

Use on waists of skirts, sleeves of shirts, etc.

1 Select a straight stitch and attach presser foot "J".

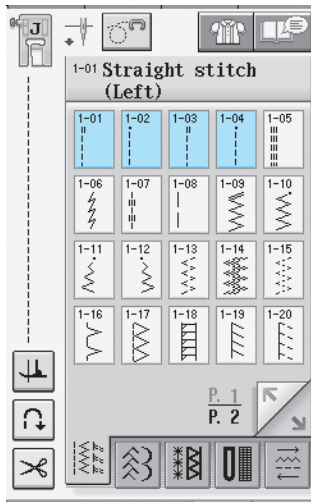

2 Set the stitch length to 4.0 mm (approx. 3/16 inch) and the thread tension to approximately 2.0 (weaker tension).

* If you press **GATHERING** after pressing , the stitch length will be set automatically to 4.0 mm (approx. 3/16 inch) and the thread tension will be automatically set to 2.0.

3 Pull the bobbin and upper threads out by 50 mm (approx. 1-15/16 inches) (see page 28).

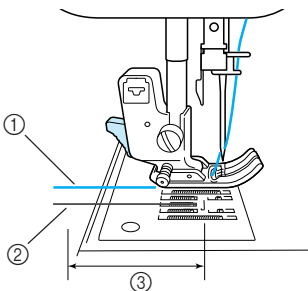

- ① Upper thread
- ② Bobbin thread
- ③ About 50 mm (approx. 1-15/16 inches)

4 Sew two rows of straight stitches parallel to the seam line, then trim excess thread leaving 50 mm (approx. 1-15/16 inches).

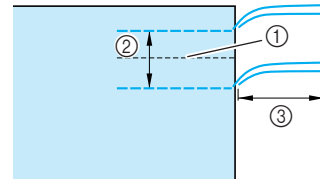

- ① Seam line
- ② 10 to 15 mm (approx. 3/8 inch to 9/16 inch)
- ③ About 50 mm (approx. 1-15/16 inches)

5 Pull the bobbin threads to obtain the desired amount of gather, then tie the threads.

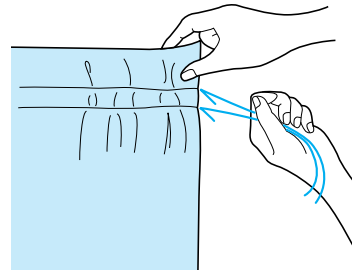

6 Smooth the gathers by ironing them.

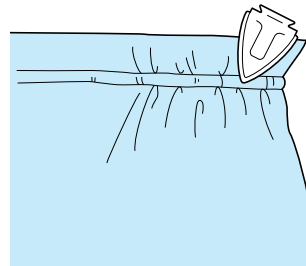

7 Sew on the seam line and remove the basting stitch.

Flat Fell Seam

Use for reinforcing seams and finishing edges neatly.

- 1 Select  and attach presser foot "J".
- 2 Sew the finish line, then cut half of the seam allowance from the side on which the flat fell seam will lie.

* When the automatic thread cutting and automatic reinforcement stitching are preset, reinforcement stitches will be sewn automatically at the beginning of sewing. Press the "Reverse/Reinforcement Stitch" button to sew a reinforcement stitch and trim the thread automatically at the end of sewing.

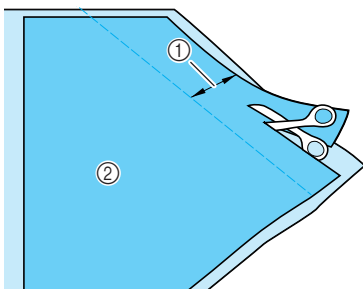

- 1 About 12 mm (approx. 1/2 inch)
- 2 Wrong side

- 3 Spread the fabric out along the finish line.

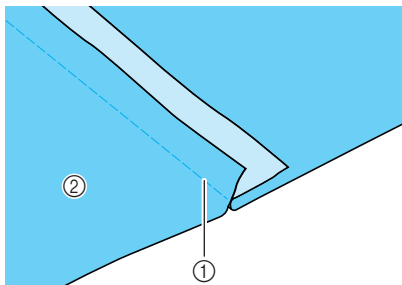

- 1 Finish line
- 2 Wrong side

- 4 Lay both seam allowances on the side of the shorter seam (cut seam) and iron them.

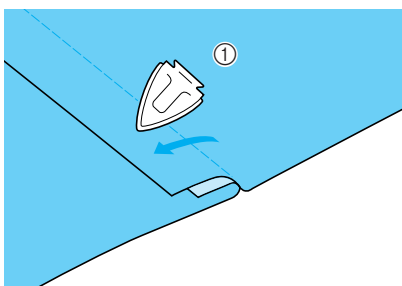

- 1 Wrong side

- 5 Fold the longer seam allowance around the shorter one, and sew the edge of the fold.

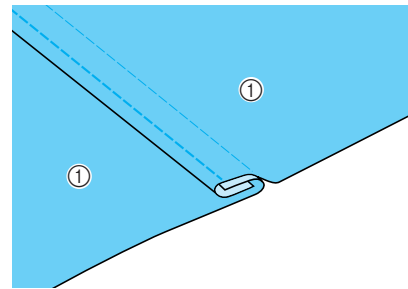

- 1 Wrong side

Finished flat fell seam

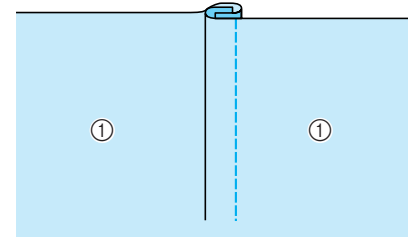

- 1 Surface

Pintuck

- 1 Mark along the folds on the wrong side of the fabric.

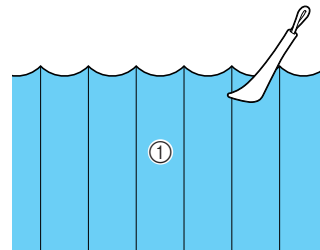

- 1 Wrong side

- 2 Turn the fabric and iron the folded parts only.

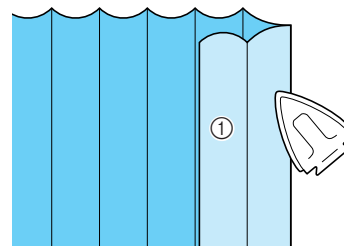

- 1 Surface



3

Utility Stitches

3 Select  and attach presser foot "1".

4 Sew a straight stitch along the fold.

* When the automatic thread cutting and automatic reinforcement stitching are preset, reinforcement stitches will be sewn automatically at the beginning of sewing. Press the "Reverse/Reinforcement Stitch" button to sew a reinforcement stitch and trim the thread automatically at the end of sewing.

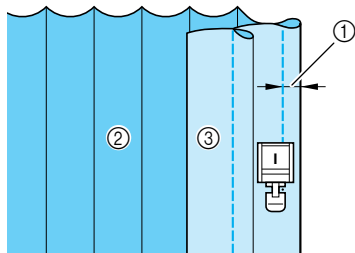

- ① Width for pintuck
- ② Wrong side
- ③ Surface

5 Iron the folds in the same direction.

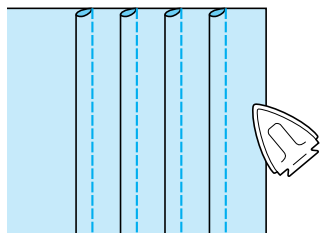





Zigzag Stitches

Zigzag stitches are useful for overcasting, appliqué, patchwork, and many other applications. Select a stitch, and attach presser foot “J”.

If the stitch which you select has a double mark “=” at the top of the key display, you can sew reverse stitches by holding the “Reverse/Reinforcement Stitch” button.

If the stitch which you select has a dot mark “·” at the top of the key display, you can sew reinforcement stitches by holding the “Reverse/Reinforcement Stitch” button (see page 46).

Stitch	Stitch name	Presser foot	Applications	Stitch width [mm (inch.)]		Stitch length [mm (inch.)]		Twin needle
				Auto.	Manual	Auto.	Manual	
1-09	Zigzag stitch		For overcasting, mending. Reverse stitch is sewn while pressing “Reverse/Reinforcement Stitch” button.	3.5 (1/8)	0.0 - 7.0 (0 - 1/4)	1.4 (1/16)	0.0 - 4.0 (0 - 3/16)	OK (J)
1-10	Zigzag stitch		For overcasting, mending. Reinforcement stitch is sewn while pressing “Reverse/Reinforcement Stitch” button.	3.5 (1/8)	0.0 - 7.0 (0 - 1/4)	1.4 (1/16)	0.0 - 4.0 (0 - 3/16)	OK (J)
1-11	Zigzag stitch (right)		Start from right needle position, zigzag sew at left.	3.5 (1/8)	2.5 - 5.0 (3/32 - 3/16)	1.4 (1/16)	0.3 - 4.0 (1/64 - 3/16)	OK (J)
1-12	Zigzag stitch (left)		Start from left needle position, zigzag sew at right.	3.5 (1/8)	2.5 - 5.0 (3/32 - 3/16)	1.4 (1/16)	0.3 - 4.0 (1/64 - 3/16)	OK (J)



3

Utility Stitches

1 Select a stitch.



2 Attach presser foot “J”.

Overcasting (Using a Zigzag Stitch)

Sew the overcasting along the edge of the fabric while positioning the right-hand side needle drop point just outside the edge of the fabric.

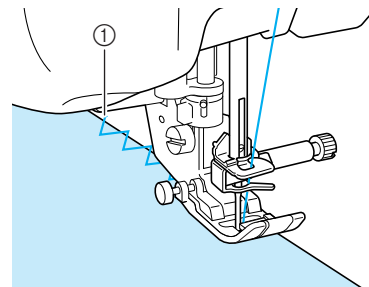

① Needle drop position

Appliqué (Using a Zigzag Stitch)

Attach the appliqué material using a temporary spray adhesive or basting, and then sew it.

* Sew a zigzag stitch while positioning the right-hand side needle drop point just outside the edge of the fabric.

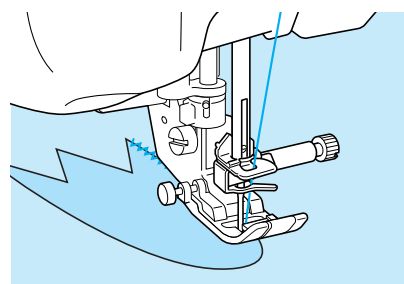

■ Patchwork (for Crazy Quilt)

Turn back the desired width of fabric and position it over the lower fabric, then sew so that the stitch bridges both pieces of fabric.

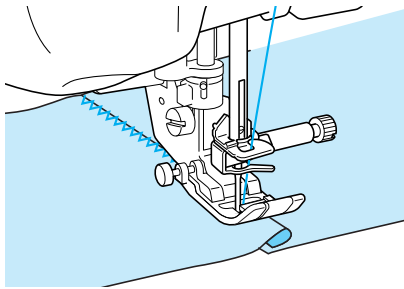

■ Sewing Curves (Using a Zigzag Stitch)

Shorten the stitch length setting to obtain a fine stitch. Sew slowly, keeping the seams parallel with the fabric edge as you guide the fabric around the curve.

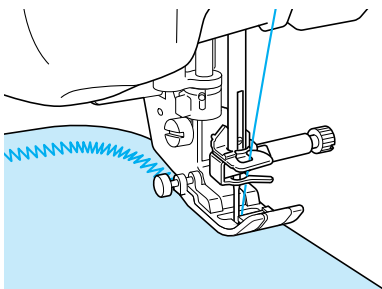

■ Cord Guide Bobbin Cover (Using a Zigzag Stitch)

- 1 Remove the bobbin cover from the machine (see page 27).
- 2 Thread the gimp thread through the hole in the cord guide bobbin cover from top to bottom. Position the thread in the notch at the back of the cord guide bobbin cover.

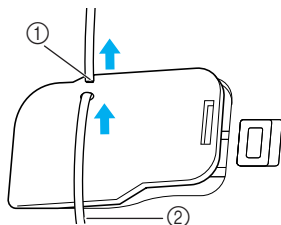

- ① Notch
- ② Gimp thread

- 3 Snap the cord guide bobbin cover into place, making sure that the gimp thread can be fed freely.

* Make sure there are no restrictions when feeding the thread.

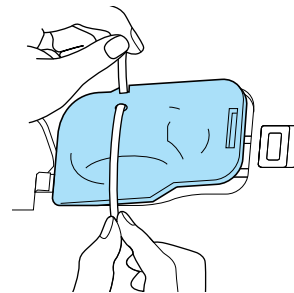

- 4 Set the zigzag width from 2.0-2.5 mm (approx. 1/16 - 3/32 inch).
- 5 Attach presser foot "N".
- 6 Position the fabric right side up on top of the cord and place the cord to the rear of the machine under the presser foot.

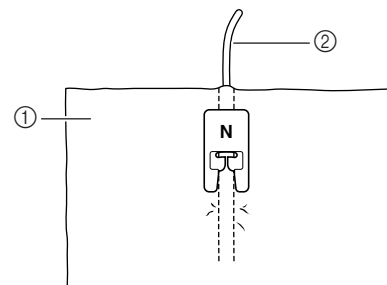





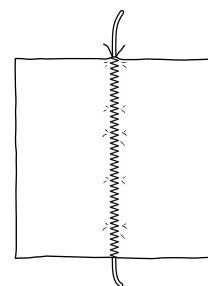

- ① Fabric (right side)
- ② Gimp thread

- 7 Lower the presser foot and start sewing to make a decorative finish.



Elastic Zigzag Stitches

Use elastic zigzag stitches for tape attaching, overcasting, darning, or a wide variety of other uses.

Stitch	Stitch name	Presser foot	Applications	Stitch width [mm (inch.)]		Stitch length [mm (inch.)]		Twin needle
				Auto.	Manual	Auto.	Manual	
	2 step elastic zigzag		Overcasting (medium weight and stretch fabrics), tape and elastic	5.0 (3/16)	1.5 - 7.0 (1/16 - 1/4)	1.0 (1/16)	0.2 - 4.0 (1/64 - 1/16)	OK (J)
	2 step elastic zigzag		Overcasting (medium weight and stretch fabrics), tape and elastic	5.0 (3/16)	1.5 - 7.0 (1/16 - 1/4)	1.0 (1/16)	0.2 - 4.0 (1/64 - 1/16)	OK (J)
	3 step elastic zigzag		Overcasting (medium, heavyweight and stretch fabrics), tape and elastic	5.0 (3/16)	1.5 - 7.0 (1/16 - 1/4)	1.0 (1/16)	0.2 - 4.0 (1/64 - 1/16)	OK (J)

1 Select a stitch.

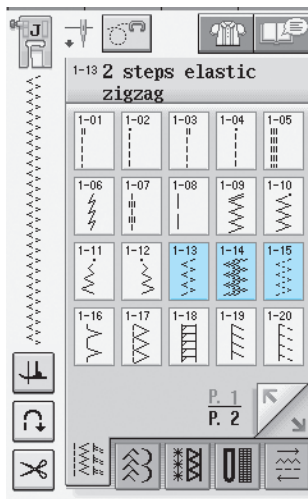

2 Attach presser foot "J".

■ Tape Attaching

Stretch the tape flat. While stretching the tape flat, sew the tape to the fabric.

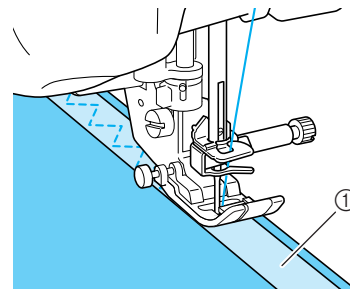

① Tape

■ Overcasting

Use this stitch to sew overcasting on the edge of stretch fabrics. Sew the overcasting along the edge of the fabric while positioning the right-hand side needle drop point just outside the edge of the fabric.

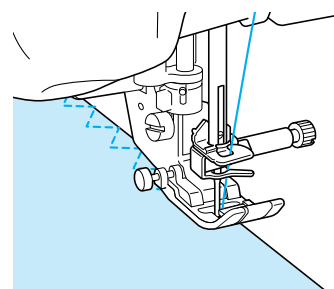







3

Utility Stitches

Overcasting

Use for the beginning and end of seams in skirts or trousers, and the beginning and end of all cuttings. Use presser foot “G”, presser foot “J”, or the side cutter attachment depending on the kind of overcasting stitch you select.

Overcasting Using Presser Foot “G”

Stitch	Stitch name	Presser foot	Applications	Stitch width [mm (inch.)]		Stitch length [mm (inch.)]		Twin needle
				Auto.	Manual	Auto.	Manual	
	Overcasting stitch		Reinforcing of light and medium weight fabrics	3.5 (1/8)	2.5 - 5.0 (3/32 - 3/16)	2.0 (1/16)	1.0 - 4.0 (1/16 - 3/16)	NO
	Overcasting stitch		Reinforcing of heavyweight fabric	5.0 (3/16)	2.5 - 5.0 (3/32 - 3/16)	2.5 (3/32)	1.0 - 4.0 (1/16 - 3/16)	NO
	Overcasting stitch		Reinforcing of medium, heavyweight and easily frayable fabrics or decorative stitching.	5.0 (3/16)	3.5 - 5.0 (1/8 - 3/16)	2.5 (3/32)	1.0 - 4.0 (1/16 - 3/16)	NO

1 Select a stitch and attach presser foot “G”.

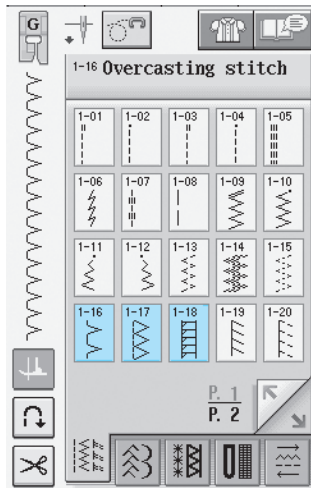

2 Lower the presser foot so that the presser foot guide is set flush against the edge of the fabric.

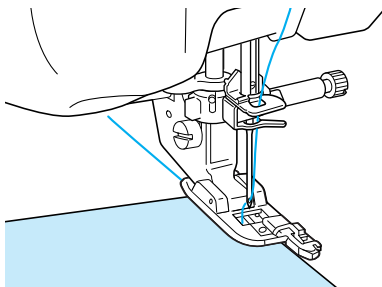

3 Sew along the presser foot guide.

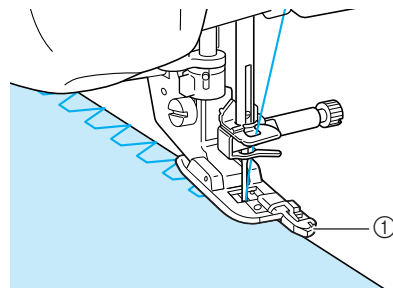

① Guide

CAUTION



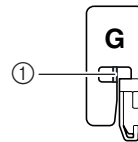









- After the stitch width is adjusted, turn the handwheel toward you by hand and check that the needle does not touch the presser foot. If the needle hits the presser foot, the needle may break and cause injury.



① The needle should not touch

- If the presser foot is raised to its highest level, the needle may strike the presser foot.

Overcasting Using Presser Foot “J”

Stitch	Stitch name	Presser foot	Applications	Stitch width [mm (inch.)]		Stitch length [mm (inch.)]		Twin needle
				Auto.	Manual	Auto.	Manual	
	Overcasting stitch		Reinforced seaming of stretch fabric	5.0 (3/16)	0.0 - 7.0 (0 - 9/32)	2.5 (3/32)	0.5 - 4.0 (1/32 - 3/16)	OK (J)
	Overcasting stitch		Reinforcing of medium stretch fabric and heavyweight fabric, decorative stitching	5.0 (3/16)	0.0 - 7.0 (0 - 9/32)	2.5 (3/32)	0.5 - 4.0 (1/32 - 3/16)	OK (J)
	Overcasting stitch		Reinforcement of stretch fabric or decorative stitching	4.0 (3/16)	0.0 - 7.0 (0 - 1/4)	4.0 (3/16)	1.0 - 4.0 (1/16 - 3/16)	OK (J)
	Overcasting stitch		Stretch knit seam	5.0 (3/16)	0.0 - 7.0 (0 - 1/4)	4.0 (3/16)	1.0 - 4.0 (1/16 - 3/16)	NO
	Single diamond overcast		Reinforcement and seaming stretch fabric	6.0 (15/64)	1.0 - 7.0 (1/16 - 1/4)	3.0 (1/8)	1.0 - 4.0 (1/16 - 3/16)	OK (J)
	Single diamond overcast		Reinforcement of stretch fabric	6.0 (15/64)	1.0 - 7.0 (1/16 - 1/4)	1.8 (1/16)	1.0 - 4.0 (1/16 - 3/16)	OK (J)



3

Utility Stitches

1 Select a stitch and attach presser foot “J”.

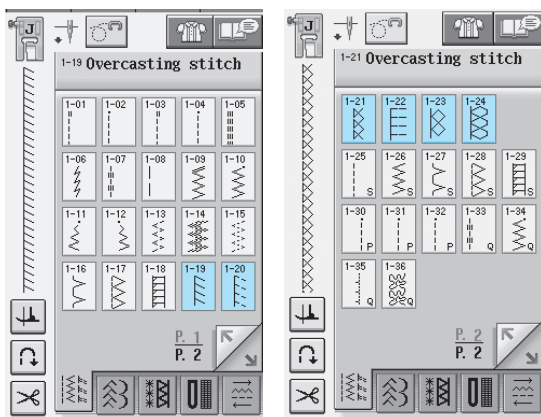

2 Sew with the needle dropping slightly off the edge of the fabric.

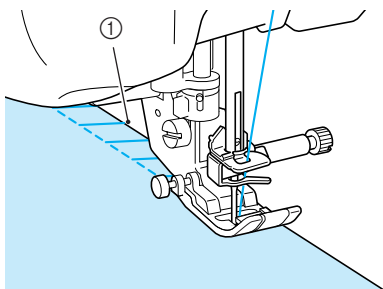

① Needle drop position

Overcasting Using the Side Cutter

By using the side cutter, you can do overcasting while cutting the fabric.

CAUTION

- Make sure to only select one of the stitches listed below. Using another stitch may cause the needle to hit the presser foot and break, possibly causing injury.



Memo

Thread the needle manually when using the side cutter, or only attach the side cutter after threading the needle using the "Automatic Threading" button.

Stitch	Stitch name	Presser foot	Applications	Stitch width [mm (inch.)]		Stitch length [mm (inch.)]		Twin needle
				Auto.	Manual	Auto.	Manual	
	With side cutter		Straight stitch while cutting fabrics	0.0 (0)	0.0 - 2.5 (0 - 3/32)	2.5 (3/32)	0.2 - 5.0 (1/64 - 3/16)	NO
	With side cutter		Zigzag stitch while cutting fabrics	3.5 (1/8)	3.5 - 5.0 (1/8 - 3/16)	1.4 (1/16)	0.0 - 4.0 (0 - 3/16)	NO
	With side cutter		Overcasting stitch while cutting fabrics	3.5 (1/8)	3.5 - 5.0 (1/8 - 3/16)	2.0 (1/16)	1.0 - 4.0 (1/16 - 3/16)	NO
	With side cutter		Overcasting stitch while cutting fabrics	5.0 (3/16)	3.5 - 5.0 (1/8 - 3/16)	2.5 (3/32)	1.0 - 4.0 (1/16 - 3/16)	NO
	With side cutter		Overcasting stitch while cutting fabrics	5.0 (3/16)	3.5 - 5.0 (1/8 - 3/16)	2.5 (3/32)	1.0 - 4.0 (1/16 - 3/16)	NO

1 Select a stitch.

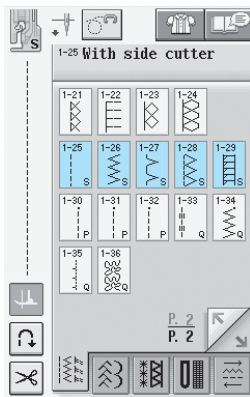

2 Follow the steps on page 37 to remove the presser foot.

3 Position the fork on the side cutter's operating lever onto the needle clamp screw.

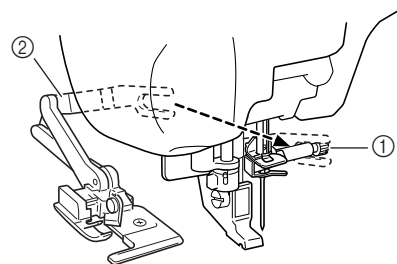

- ① Needle clamp screw
- ② Operating lever



Memo

Make sure that the fork of the operating lever is set onto the needle screw firmly.

- 4** Position the side cutter so that the side cutter pin is aligned with the notch in the presser foot holder, and then lower the presser foot.

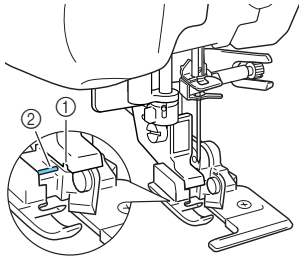

- ① Notch in presser foot holder
② Pin
→ The side cutter is attached.

- 5** Make a cut of approximately 20 mm (approx. 3/4 inch) in the fabric.

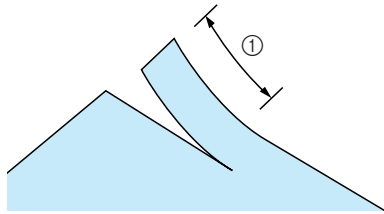

- ① 20 mm (approx. 3/4 inch)

- 6** Position the fabric so that the right side of the cut is on top of the guide plate and the left side of the cut is underneath the presser foot.

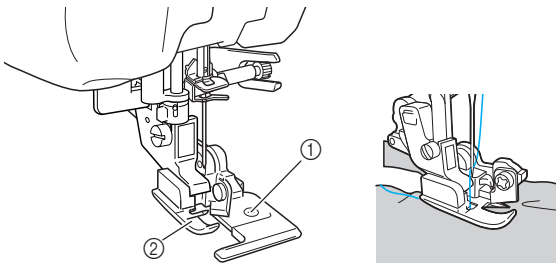

- ① Guide plate (lower knife)
② Presser foot



Memo

If the fabric is not positioned correctly, the fabric will not be cut.

- 7** Thread the needle manually and pull out a long section of the upper thread. Pass it below the presser foot and pull it out in the fabric feed direction.

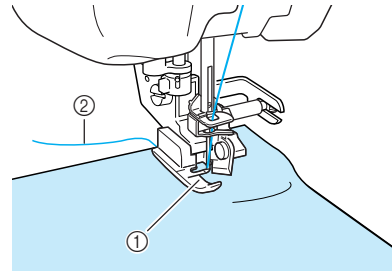

- ① Presser foot
② Upper thread

- 8** Start sewing.

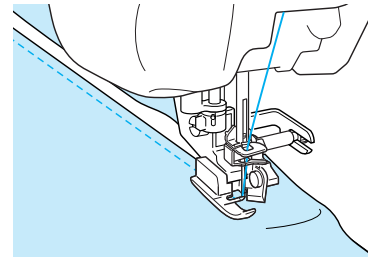

→ A seam allowance is cut while the stitching is sewn.



Note

If the width has been adjusted, turn the hand-wheel by hand to check that the needle does not touch the side cutter. If the needle touches the side cutter, it might cause the needle to break.



3

Utility Stitches

■ When Sewing Straight Stitches While Using the Side Cutter

The seam margin should be approximately 5 mm (approx. 3/16 inch).

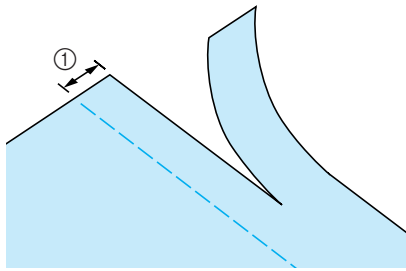

① Seam margin



Memo

- The fabric will not be cut if the whole fabric is simply spread out underneath the presser foot guide plate. Set the fabric as explained in step ⑥ from the previous section, and then start sewing.

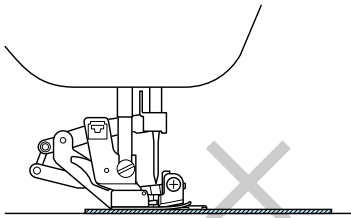























- One layer of 13 oz. denim can be cut.
- Clean the side cutter after use to avoid having dust and scraps of thread build up on it.
- Add a small amount of oil as required to the cutting edge of the cutter.

Quilting

You can make beautiful quilts quickly and easily with this machine. When making a quilt, you will find it convenient to use the knee lifter and foot controller to free your hands for other tasks (see “Using the Foot Controller” on page 45 and /or see “Using the Knee Lifter” on page 53).

If there is a “P” or “Q” at the bottom of the key display, the indicated stitch is intended for quilting.

Pattern	Name of pattern	Type of presser foot		Use	Stitch width [mm (inch.)]		Stitch length [mm (inch.)]		Twin needle
					Auto.	Manual	Auto.	Manual	
	Piecing stitch (Right)			Piecework/patchwork 6.5 mm (approx. 1/4 inch) right seam allowance	5.5 (7/32)	0.0 - 7.0 (0 - 1/4)	2.0 (1/16)	0.2 - 5.0 (1/64 - 3/16)	NO
	Piecing stitch (Middle)			Piecework/patchwork	—	—	2.0 (1/16)	0.2 - 5.0 (1/64 - 3/16)	NO
	Piecing stitch (Left)			Piecework/patchwork 6.5 mm (approx. 1/4 inch) left seam allowance	1.5 (1/16)	0.0 - 7.0 (0 - 1/4)	2.0 (1/16)	0.2 - 5.0 (1/64 - 3/16)	NO
	Hand-look quilting			Quilting stitch made to look like hand quilting stitch	0.0 (0)	0.0 - 7.0 (0 - 1/4)	2.5 (3/32)	1.0 - 4.0 (1/16 - 3/16)	NO
	Quilting appliqué zigzag stitch			Zigzag stitch for quilting and sewing on appliqué quilt pieces	3.5 (1/8)	0.0 - 7.0 (0 - 1/4)	1.4 (1/16)	0.0 - 4.0 (0 - 3/16)	NO
	Quilting appliqué stitch			Quilting stitch for invisible appliqué or attaching binding	1.5 (1/16)	0.5 - 5.0 (1/64 - 3/16)	1.8 (1/16)	1.0 - 4.0 (1/16 - 3/16)	NO
	Quilting stippling			Background quilting	7.0 (1/4)	1.0 - 7.0 (1/16 - 1/4)	1.6 (1/16)	1.0 - 4.0 (1/16 - 3/16)	NO





3

Utility Stitches

■ Piecing

Sewing two pieces of fabric together is called piecing. When cutting pieces for quilt blocks, make sure the seam allowance is 6.5 mm (approx. 1/4 inch).

1 Select  or  and attach presser foot “J”.

2 Align the edge of the fabric with the edge of the presser foot, and start sewing.

- * To sew a 6.5 mm (approx. 1/4 inch) seam allowance along the left edge of the presser foot with  selected, the width should be set to 5.5 mm (approx. 7/32 inch).

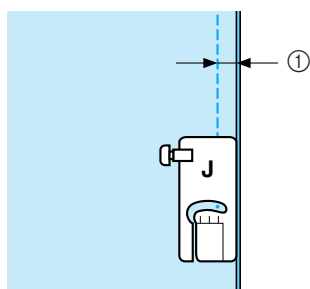

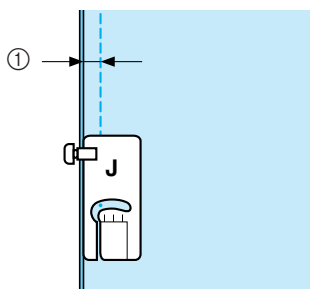

① 6.5 mm (approx. 1/4 inch)

- * To sew a 6.5 mm (approx. 1/4 inch) seam allowance along the left edge of the presser foot with  selected, the width should be set to 1.5 mm (approx. 1/32 inch).



① 6.5 mm (approx. 1/4 inch)

- * To change the needle position, use  or  in the width display.

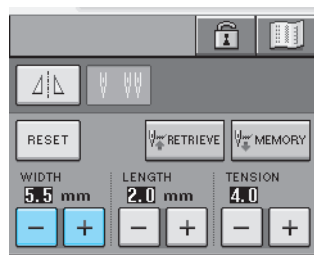



Memo

Using a straight stitch (middle needle position) makes it easier to sew smoothly (see page 63).

■ Quilting

Sewing together the quilt top, batting, and backing is called quilting. You can sew the quilt with the walking foot to keep the quilt top, batting, and backing from sliding. The walking foot has a set of feed dogs that move together with the feed dogs in the needle plate during sewing.

For straight line quilting, use the walking foot and the straight stitch needle plate. Always select a straight stitch (middle needle position) when using the straight stitch needle plate.

1 Select ,  or .

2 Attach the walking foot (see page 38).

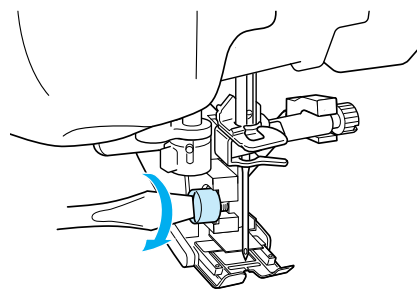

3 Place one hand on each side of the presser foot to hold the fabric secure while sewing.



Memo

- Sew at slow to medium speed.
- Do not sew in reverse or use stitches that require side ways or reverse feeding. Always check to be sure that your quilting surface is securely basted before beginning to sew. Specialized machine quilt needles and threads are also available for machine quilting.

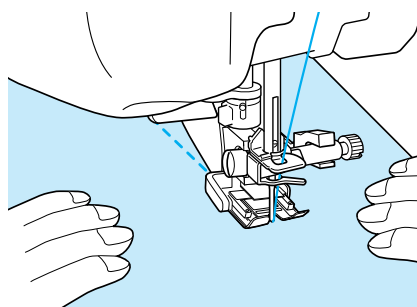

■ Appliqué

- 1 Trace the pattern onto the appliqué fabric and then cut around it, leaving a 3 to 5 mm (approx. 1/8 to 3/16 inch) seam allowance.

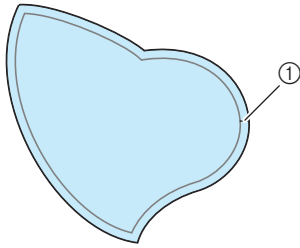

① Seam allowance: 3 to 5 mm (approx. 1/8 to 3/16 inch)

- 2 Place a piece of thick paper cut to the finished size of the appliqué design onto the fabric, and then fold over the seam margin using an iron. Clip curves when necessary.

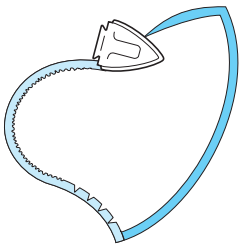

- 3 Turn the appliqué over, and attach the thick paper with basting pins or a basting stitch.

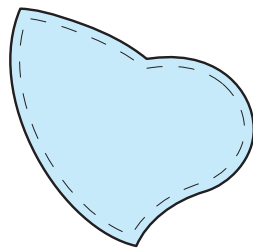

- 4 Select  and attach presser foot "J".

- 5 Use the quilting appliqué stitch to attach the appliqué. Sew around the edge while dropping the needle as close to the edge as possible.

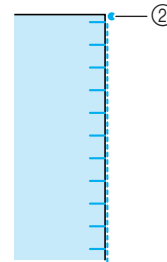
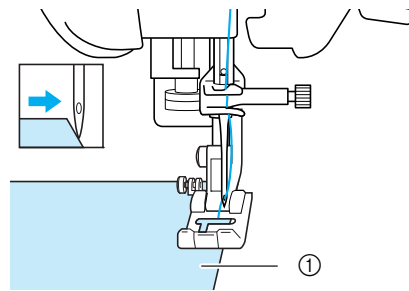
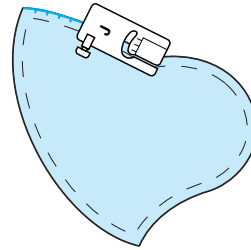

- ① Appliqué
- ② Needle drop position

⚠ CAUTION

- Be careful that the needle does not strike a basting pin during sewing. Striking a pin can cause the needle to break, resulting in injury.

You can use the appliqué technique to attach appliqué designs like the three pictured below.

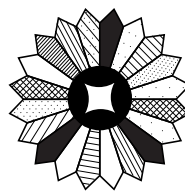

①

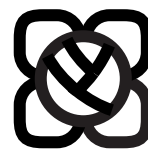

②



③

- ① Dresden plate
- ② Stained glass
- ③ Sunbonnet sue





3

Utility Stitches

■ Quilting with Satin Stitches

Use the foot controller to sew with satin stitches. If you set the speed control slide to control the stitch width, you can make subtle changes in the stitch width during sewing.

- 1 Attach the foot controller (see page 45).
- 2 Select  and attach presser foot “J”.
- 3 Press  in the length display to shorten the stitch length.

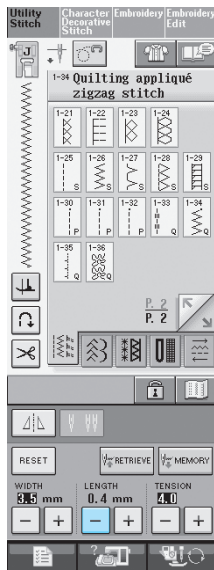

Memo

The setting will vary according to the kind of fabric and the thickness of the thread, but a length of 0.3 to 0.5 mm (approx. 1/64 to 1/32 inch) is best for satin stitches.

- 4 Press  to use the speed control slide to control the stitch width.

- 5 Set the width control to “ON”.

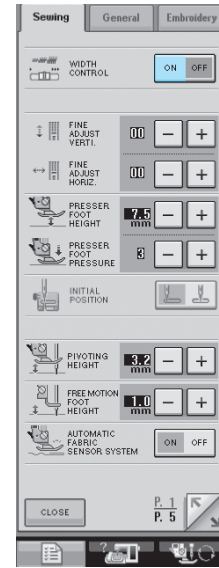

Memo

You can use the speed control slide to adjust the stitch width. Use the foot controller to adjust the sewing speed.

- 6 Press .

→ The display will return to the original screen.

- 7 Start sewing.

* You can adjust the stitch width during sewing by moving the sewing speed controller. Slide the lever to the left, and the stitch width becomes narrower. Slide it to the right, the stitch width becomes wider. The size of the width changes equally on both sides of the middle needle position.

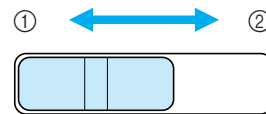

- ① narrower
- ② wider



Rough sketch (line)

- 8 When you are finished sewing, set the width control back to “OFF”.

Free-motion Quilting

With free-motion quilting, the feed dogs can be lowered (using the feed dog position switch) so that the fabric can be moved freely in any direction. For free-motion quilting, use free-motion quilting foot "C" or free-motion open toe quilting foot "O" depending on the stitch that is selected, and set the machine to free-motion sewing mode. In this mode, the presser foot is raised to the necessary height for free-motion sewing.

We recommend attaching the foot controller and sewing at a consistent speed. You can adjust the sewing speed with the speed control slide on the machine.

Using Free-motion Quilting Foot "C"

The free-motion quilting foot "C" is used for free-motion sewing using the straight stitch needle plate.



Free-motion quilting foot "C"

CAUTION

- With free-motion quilting, control the feeding speed of the fabric to match the sewing speed. If the fabric is moved faster than the sewing speed, the needle may break or other damage may result.
- When using free-motion quilting foot "C", be sure to use the straight stitch needle plate and sew with the needle in middle (center) needle position. If the needle is moved to any position other than the middle (center) needle position, the needle may break, which may result in injuries.

Memo

- When starting to sew, the internal sensor detects the thickness of the fabric, and the quilting foot is raised to the height specified in the machine settings screen. Press



to display "FREE MOTION FOOT HEIGHT" on P. 1 of the settings screen.

Press **-** or **+** to select the height that the quilting foot is raised above the fabric.

Increase the setting by pressing **+**, for example, when sewing very stretchy fabric, so that it is easier to sew.



- In order to sew with a balanced tension, it may be necessary to adjust the upper thread tension. Test with a sample piece of fabric that is similar to your chosen fabric.

1 Attach the straight stitch needle plate (see page 65).

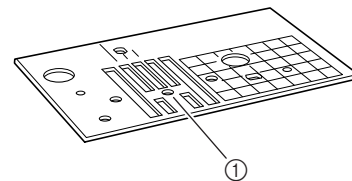

① Round hole

Memo

Notice that there is a round hole in this needle plate.



3

Utility Stitches

- 2** Press  to set the machine to free-motion sewing mode.

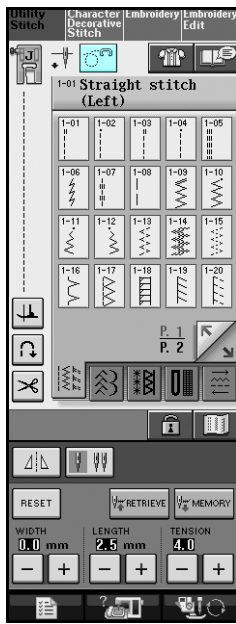

→ The key appears as , and the quilting foot is raised to the necessary height for free-motion sewing.

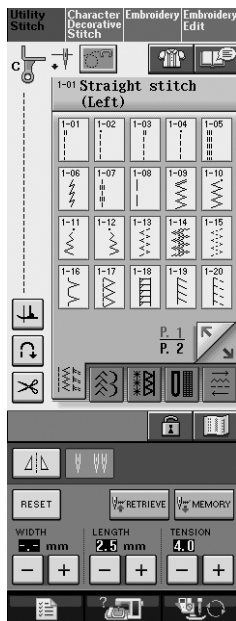

- 3** Select any of the following stitches.

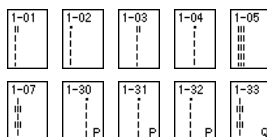

→ Free-motion quilting foot “C” is indicated in the upper-left corner of the screen.

- 4** Remove the presser foot holder (see page 38).
- 5** Attach free-motion quilting foot “C” at the front with the presser foot holder screw aligned with the notch in the quilting foot.

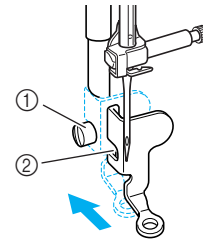

- ① Presser foot holder screw
② Notch



Note

Make sure that the quilting foot is attached properly and not slanted.

- 6** Hold the quilting foot in place with your right hand, and tighten the presser foot holder screw using the screwdriver with your left hand.

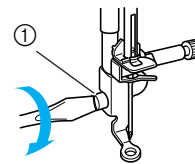

- ① Presser foot holder screw

CAUTION

- Be sure to securely tighten the screws with the included screwdriver. Otherwise, the needle may touch the quilting foot, causing it to bend or break.

- 7** Lower the feed dog position switch, located at the rear of the base of the machine, to .

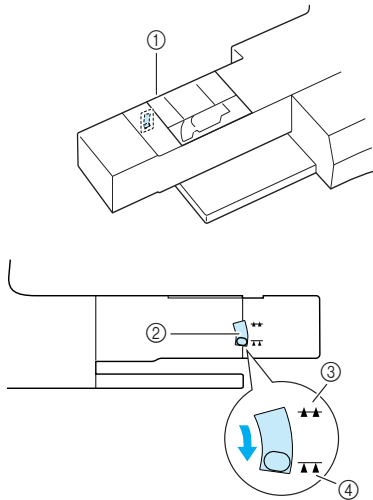

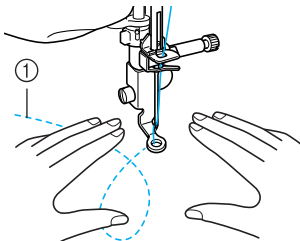

- ① Rear of machine
 ② Feed dog position switch (as seen from the rear of the machine)
 ③ Up
 ④ Down

- 8** Use both hands to stretch the fabric taut, and then move the fabric at a consistent pace in order to sew uniform stitches roughly 2.0-2.5 mm (approx. 1/16 - 3/32 inch) in length.



- ① Stitch

- 9** Press  to cancel the free-motion sewing mode.

- 10** After sewing is finished, raise the feed dog position switch to  to raise the feed dogs.

Memo

- Normally, the feed dog position switch is in the up position.
- Do not be discouraged with your initial results. The technique requires practice.

Using Free-motion Open Toe Quilting Foot “O”

The free-motion open toe quilting foot “O” is used for free-motion quilting with zigzag or decorative stitches or for free-motion quilting of straight lines on fabric with an uneven thickness. Various stitches can be sewn using free-motion open toe quilting foot “O”. For details on the stitches that can be used, refer to the “Stitch Setting Chart” at the end of this manual.

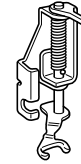

Free-motion open toe quilting foot “O”

Note

Free-motion open toe quilting foot “O” can also be used with the straight stitch needle plate. We recommend using free-motion open toe quilting foot “O” with free-motion sewing of fabrics of uneven thicknesses. For details on installing the straight stitch needle plate, refer to page 65. Select one of the following stitches when using the straight stitch needle plate.

1-01 	1-02 	1-03 	1-04 	1-05
1-07 	1-30 	1-31 	1-32 	1-33

Memo

In order to sew with a balanced tension, it may be necessary to adjust the upper thread tension (see page 50). Test with a sample piece of quilting fabric.



3

Utility Stitches

- 1 Press  to set the machine to free-motion sewing mode.

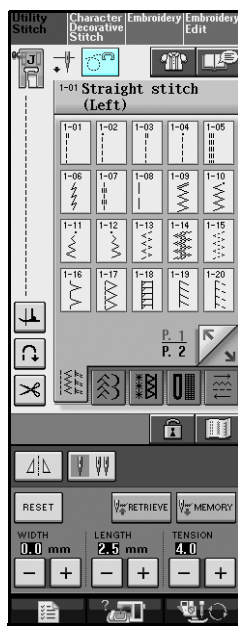

→ The key appears as , and the quilting foot is raised to the necessary height for free-motion sewing.

- 2 Select a stitch.



Memo

Free-motion open toe quilting foot “O” is indicated in the upper-left corner of the screen. When using the straight stitch needle plate, free-motion quilting foot “C” is indicated.

- 3 Remove the presser foot holder (see page 38).

- 4 Attach free-motion open toe quilting foot “O” by positioning the pin of the quilting foot above the needle clamp screw and aligning the lower-left of the quilting foot and the presser bar.

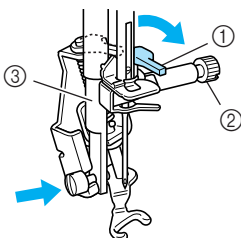

- ① Pin
- ② Needle clamp screw
- ③ Presser bar



Note

Make sure that the quilting foot is not slanted.

- 5 Hold the quilting foot in place with your right hand, and tighten the presser foot holder screw using the screwdriver with your left hand.

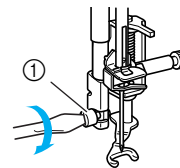

- ① Presser foot holder screw

CAUTION

- Be sure to securely tighten the screws with the included screwdriver. Otherwise, the needle may touch the quilting foot, causing it to bend or break.

- 6 Use both hands to stretch the fabric taut, and then move the fabric at a consistent pace in order to sew uniform stitches roughly 2.0-2.5 mm (approx. 1/16 - 3/32 inch) in length.

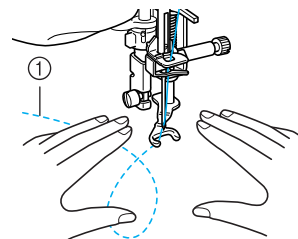

- ① Stitch

- 7 Press  to cancel the free-motion sewing mode.



Memo

Do not be discouraged with your initial results. The technique requires practice.

Echo Quilting Using the Free-motion Echo Quilting Foot “E”

Sewing quilting lines at equal distances around a motif is called echo quilting. The quilting lines, which appear as ripples echoing away from the motif, are the distinguishing characteristic of this quilting style. Use the free-motion echo quilting foot “E” for echo quilting. Using the measurement on the presser foot as a guide, sew around the motif at a fixed interval. We recommend attaching the foot controller and sewing at a consistent speed.

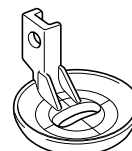

Free-motion echo quilting foot "E" measurement

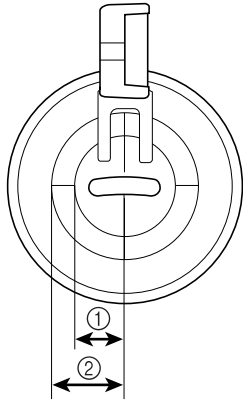





- ① 6.4 mm (approx. 1/4 inch)
- ② 9.5 mm (approx. 3/8 inch)

CAUTION

- With free-motion quilting, control the feeding speed of the fabric to match the sewing speed. If the fabric is moved faster than the sewing speed, the needle may break or other damage may result.

Memo

- When starting to sew, the internal sensor detects the thickness of the fabric, and the quilting foot is raised to the height specified in the machine settings screen. Press  to display "FREE MOTION FOOT HEIGHT" on P. 1 of the settings screen (see page 16). Press  or  to select the height that the quilting foot is raised above the fabric. Increase the setting by pressing , for example, when sewing very soft fabric, so that it is easier to sew.



- In order to sew with a balanced tension, it may be necessary to adjust the upper thread tension (see page 50). Test with a sample piece of quilting fabric.

- 1 Press  to set the machine to free-motion sewing mode.



→ The key appears as , and the quilting foot is raised to the necessary height for free-motion sewing.

- 2 Select .
- 3 Follow the steps on page 37 "Removing the Presser Foot" to remove the presser foot.
- 4 Remove the presser foot holder (see page 38) and the screw.
- 5 Position the free-motion echo quilting foot "E" on the left side of the presser bar with the holes in the quilting foot and presser bar aligned.

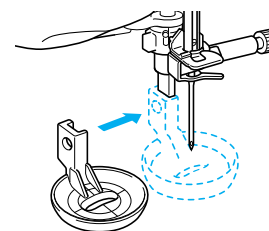

3

Utility Stitches

- 6** Tighten the screw with the included screwdriver.

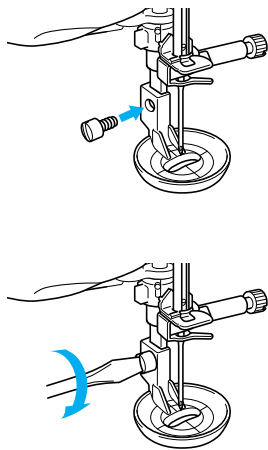

! CAUTION

- Be sure to securely tighten the screws with the included screwdriver. Otherwise, the needle may touch the quilting foot, causing it to bend or break.

- 7** Using the measurement on the quilting foot as a guide, sew around the motif.

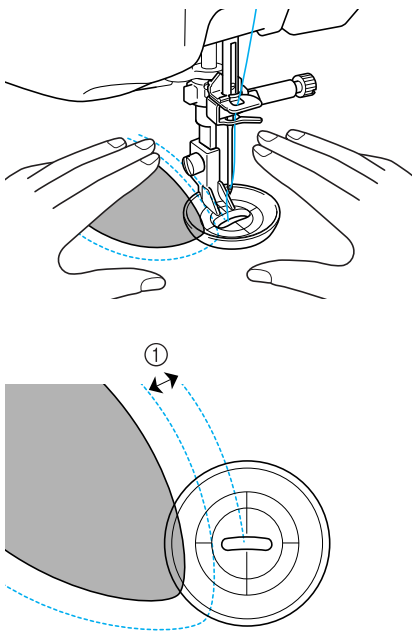

① 6.4 mm (approx. 1/4 inch)

Finished project

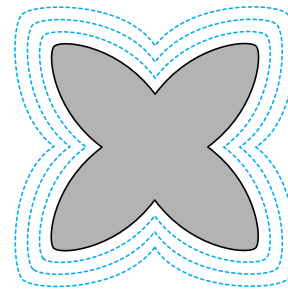

- 8** Press  to cancel the free-motion sewing mode.

Blind Hem Stitches

Select from these stitches to sew the hems or cuffs of dresses, blouses, pants, or skirts.

Stitch	Stitch name	Presser foot	Applications	Stitch width [mm (inch.)]		Stitch length [mm (inch.)]		Twin needle
				Auto.	Manual	Auto.	Manual	
	Blind hem stitch		Hemming woven fabrics	0.0 (0)	+3.0 - -3.0 (+1/8 - -1/8)	2.0 (1/16)	1.0 - 3.5 (1/16 - 1/8)	NO
	Blind hem stretch		Hemming stretch fabric	0.0 (0)	+3.0 - -3.0 (+1/8 - -1/8)	2.0 (1/16)	1.0 - 3.5 (1/16 - 1/8)	NO

1 Select a stitch.

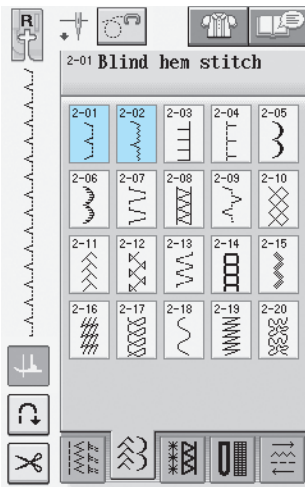

2 Place the fabric wrong side up, and fold and baste the fabric.

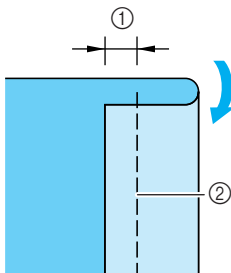

- ① 5 mm (approx. 3/16 inch)
- ② Basting stitches

3 Fold the fabric again.

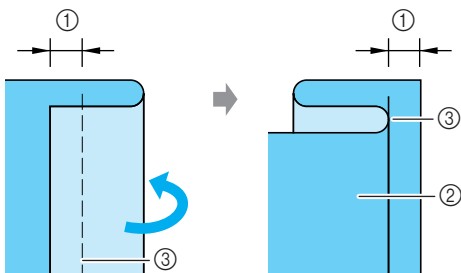

- ① 5 mm (approx. 3/16 inch)
- ② Wrong side of fabric
- ③ Basting stitches

4 Attach blind hem stitch foot "R", and lower the presser foot. Position the fabric so the folded edge touches the guide of the presser foot.

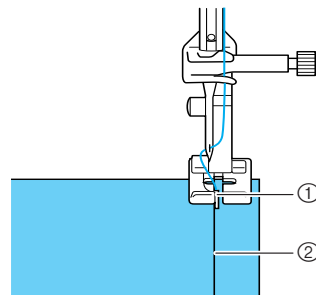

- ① Guide
- ② Fold

5 Sew the fabric, keeping the folded edge in contact with the presser foot.

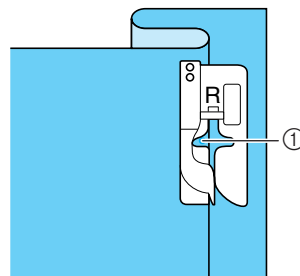

- ① Needle position



3

Utility Stitches

6 Remove the basting stitches and turn the fabric over.

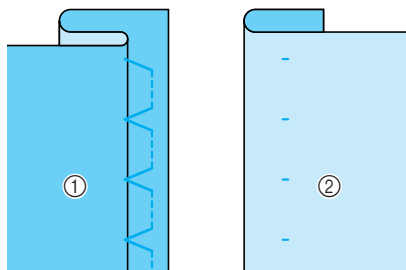

- ① Wrong side of fabric
- ② Right side of fabric



Memo

Blind hem stitches cannot be sewn if the left needle drop point does not catch the fold. If the needle catches too much of the fold, the fabric cannot be unfolded and the seam appearing on the right side of the fabric will be very large, leaving an unattractive finish. If you experience either of these cases, follow the instructions below to solve the problem.

■ If the Needle does not Catch the Fold

Adjust the width so that the needle slightly catches the fold by pressing **-** in the width display.

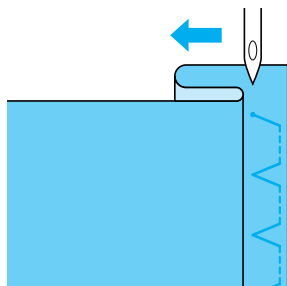

■ If the Needle Catches Too Much of the Fold

Adjust the width so that the needle slightly catches the fold by pressing **+** in the width display.

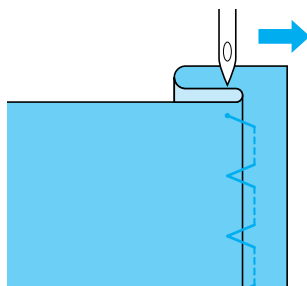



Appliqué

1 Use a temporary spray adhesive, fabric glue or a basting stitch to attach the appliqué to the fabric.

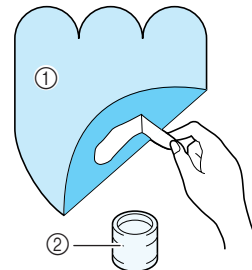
* This will keep the fabric from moving during sewing.



- ① Appliqué
- ② Fabric glue

2 Select  or .

* Adjust the stitch length and width to correspond to the appliqué shape, size, and quality of material (see page 49).



Memo

For details on each stitch, refer to the "STITCH SETTING CHART" at the end of this manual.

3 Attach presser foot "J". Check that the needle drops slightly off the edge of the appliqué, then start sewing.

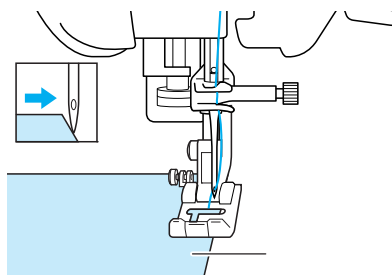

- ① Appliqué material

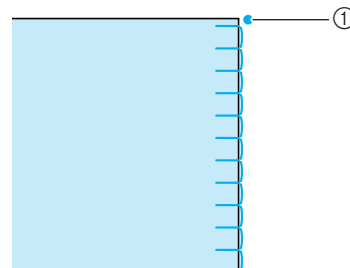

- ① Needle drop position

■ Sewing Sharp Curves

Stop the machine with the needle in the fabric outside the appliqué. Raise the presser foot and turn the fabric a little bit at a time while sewing for an attractive finish to the seam.

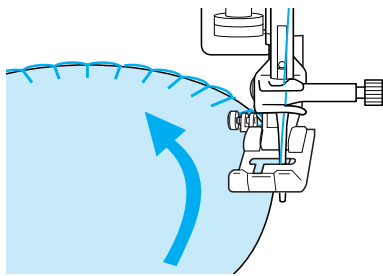

Memo

Placing a lightweight tear away stabilizer beneath the stitching area will improve the stitch placement along the edge of the appliqué fabric.

Shelltuck Stitches

Shelltuck stitches give an attractive appearance of shells along the curve of a collar. This stitch pattern can be used for edging the neckline or sleeves of dresses and blouses.

1 Select .

Memo

For details on each stitch, refer to the “STITCH SETTING CHART” at the end of this manual.

2 Increase the upper thread tension for an attractive scallop finish to the shelltuck stitches (see page 50).

Memo

If the upper thread tension is too weak, the shelltuck stitches will not scallop.

3 To make rows of shell tuck stitches, fold the fabric in half along the bias.

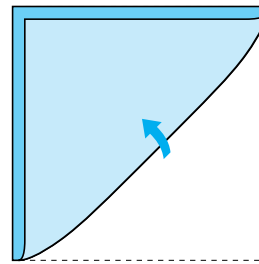

Memo

Use a thin fabric.

4 Attach presser foot “J”. Set the needle drop point slightly off the edge of the fabric, and start sewing.

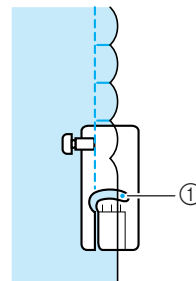
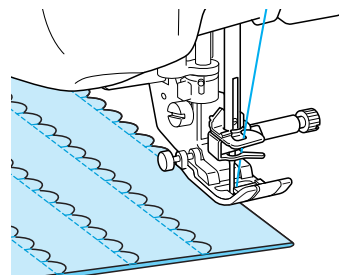

① Needle drop position

5 Unfold the fabric, and iron the tucks to one side.

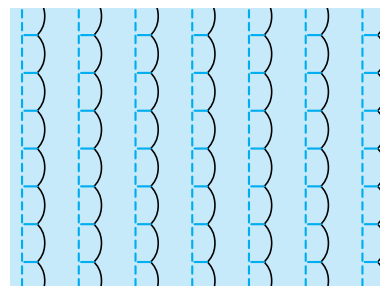

Memo

To make shell tucks at the edge of a collar or neckline, follow the pattern's instructions and then use this stitch to make a decorative finish on the collar or neckline.



3

Utility Stitches

Scallop Stitches

This wave-shaped satin stitch is called the scallop stitch. Use this stitch to decorate the edges of blouse collars and handkerchiefs or use it as a hem accent.



Memo

A temporary spray adhesive may be necessary for lightweight fabrics. Test sew the fabric before sewing a project.

- 1 Select .



Memo

For details on each stitch, refer to the "STITCH SETTING CHART" at the end of this manual.

- 2 Attach presser foot "N". Sew scallop stitches along the edge of the fabric.

* Do not sew directly on the edge of the fabric.

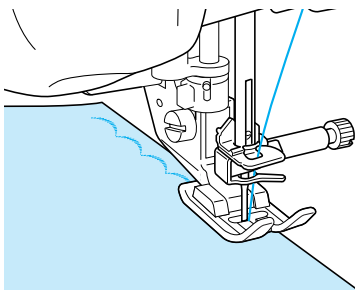

- 3 Trim along the seam, making sure not to cut the stitches.

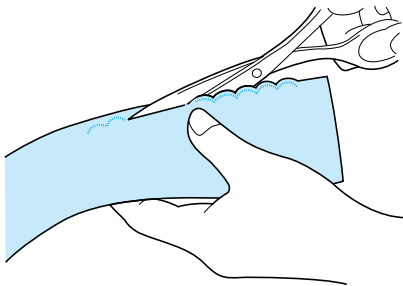

Memo

Use a seam sealant to secure the edges of the scallop stitches.

Top Stitching

For a decorative look called "Crazy Quilting", the following stitches can be sewn on top of a pressed seam allowance.

- 1 Select a straight stitch and attach presser foot "J".
- 2 With the right sides facing each other, sew two pieces of fabric together, and then press open the seam allowance.

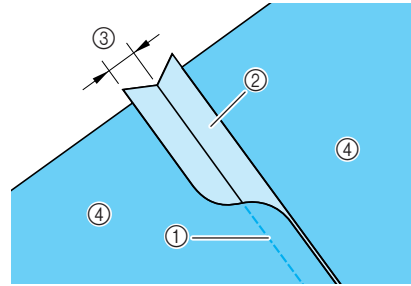

- 1 Straight stitch
- 2 Seam margins
- 3 6.5 mm (approx. 1/4 inch)
- 4 Wrong side

- 3 Select a stitch for top stitching.



- 4 Place the fabric right side up in the machine, and center the presser foot over the seam when sewing.

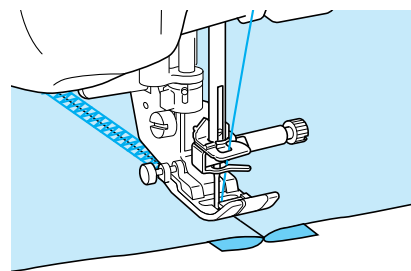

- 1 Right side of fabric

Smocking Stitches

Use smocking stitches for decorative sewing on clothes, etc.

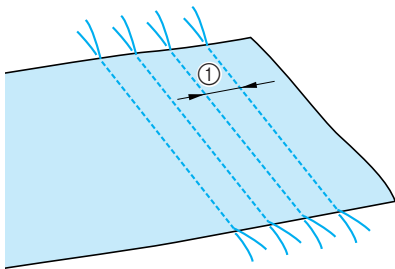

- 1 Select a straight stitch and attach presser foot "J".
- 2 Set the stitch length to 4.0 mm (approx. 3/16 inch) and loosen the upper thread tension to approximately 2.0 (See pages 49 through 50).
- 3 Pull the bobbin and upper threads out by 50 mm (approx. 1-15/16 inches).
- 4 Sew the seams, leaving approximately 10 mm (approx. 3/8 inch) between the seams, then trim excess thread, leaving 50 mm (approx. 1-15/16 inches).

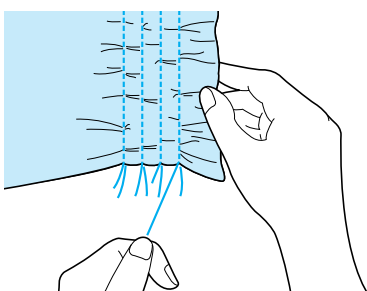

① Approximately 10 mm (approx. 3/8 inch)

- 5 Pull the bobbin threads to obtain the desired amount of gather, and then smooth the gathers by ironing them.



- 6 Select  or .



Memo

For details on each stitch, refer to the "STITCH SETTING CHART" at the end of this manual.

- 7 Sew the spaces between the straight seams.

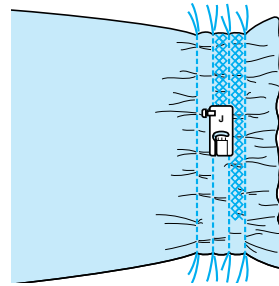

- 8 Pull out the straight stitch threads.

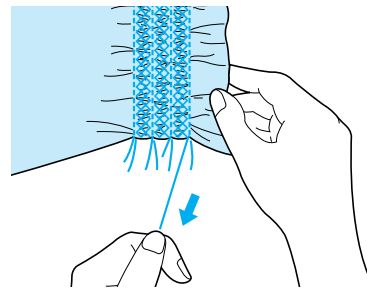



Fagoting

When there is a space between two fabrics with thread sewn over the space to join the fabrics together, it is called fagoting. Use this stitch when sewing blouses or children's clothes.

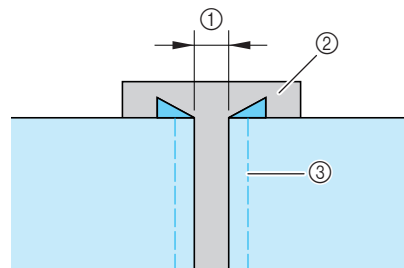
- 1 Baste two pieces of fabric onto thin paper, leaving a space of 4 mm (approx. 3/16 inch) between the fabrics.



- ① 4.0 mm (approx. 3/16 inch)
- ② Paper
- ③ Basting stitches

- 2 Select  or .



Memo

For details on each stitch, refer to the "STITCH SETTING CHART" at the end of this manual.



3

Utility Stitches

- 3** Attach presser foot “J”. Align the center of the presser foot with the middle of the space between the fabrics and begin sewing.

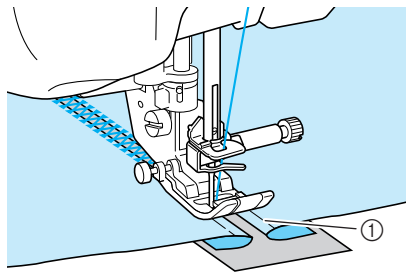

① Basting stitches





Memo
Use a thick thread.

- 4** When sewing is finished, gently tear the paper away.

Tape or Elastic Attaching

- 1** Select a straight stitch and attach presser foot “J”.
- 2** Set the stitch length to 4.0 mm (approx. 3/16 inch), and loosen the upper thread tension to 2.0 (See pages 49 through 50).



Memo
Be sure that neither automatic reinforcement  nor automatic thread cutting  is selected.

- 3** Sew two rows of straight stitches on the right side of the fabric, then pull the bobbin thread to create the necessary gather.

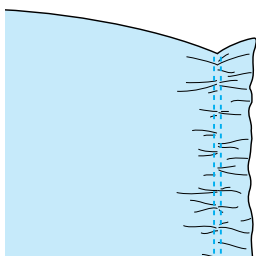

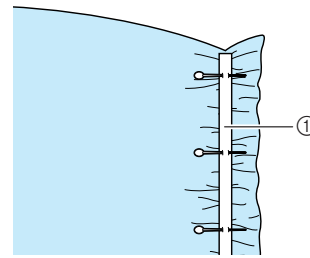

Memo
Before sewing the straight stitch, rotate the handwheel and pull up the bobbin thread. Holding the top and bobbin thread, pull a length of thread out from the rear of the machine. (Be sure that the presser foot is raised.)

- 4** Place the tape over the gather, and hold it in place with basting pins.



① Tape

- 5** Select  or .



Memo
For details on each stitch, refer to the “STITCH SETTING CHART” at the end of this manual.

- 6** Sew over the tape (or elastic).

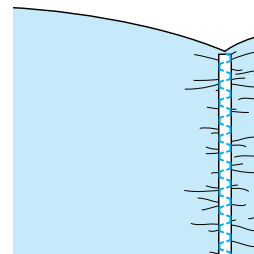
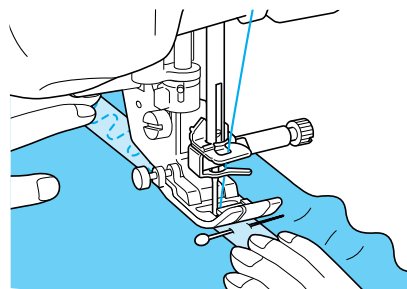

CAUTION

Be sure the needle does not strike a basting pin, or any other objects, during sewing. The thread could tangle or the needle could break, causing injury.

- 7** Pull out the straight stitch threads.

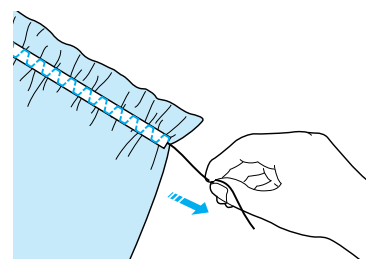

Heirloom

■ Hemstitching (1) (Daisy Stitch)

Use for sewing tablecloths, decorative hems, and decorative stitching on shirt fronts.

Memo

Use a light to medium weight homespun fabric with a little stiffness.

- 1** Insert a type 130/705H, size 100/16 Wing needle.

CAUTION

- The “Automatic Threading” button cannot be used. Thread the wing needle by hand, from front to back. Refer to “Threading Manually” on page 31. Using the “Automatic Threading” button may result in damage to the machine.
- A more attractive finish can be obtained if you use a “130/705H Wing” needle when sewing these patterns. If using a wing needle and the stitch width has been set manually, check that the needle will not touch the presser foot by carefully rotating the handwheel before starting sewing.

- 2** Select a stitch and attach presser foot “N”.

* Select any stitch between 3-01 and 3-25.

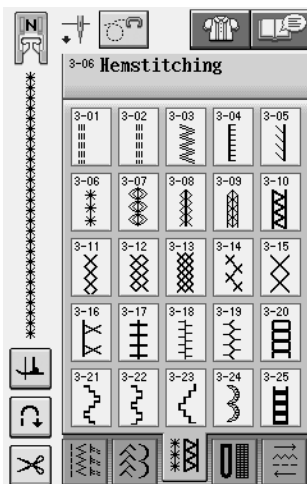

Memo

- For details on each stitch, refer to the “STITCH SETTING CHART” at the end of this manual.

- 3** Start sewing.

Example: Illustration of finished product

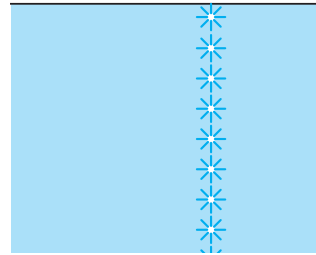

■ Hemstitching (2) (Drawn Work (1))

- 1** Pull out several threads from one area on a piece of fabric to open the area.

* Pull out 5 or 6 threads to leave a 3 mm (approx. 1/8 inch) area open.

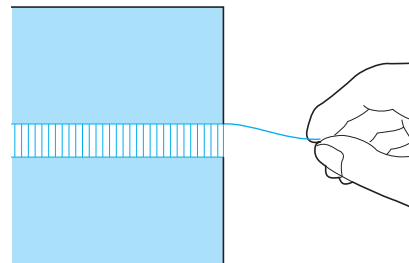

Memo

Loosely woven fabrics work best for this.

- 2** Select .

Memo

For details on each stitch, refer to the “STITCH SETTING CHART” at the end of this manual.

- 3** Attach presser foot “N”. With the right side of the fabric facing up, sew one edge of the open area.

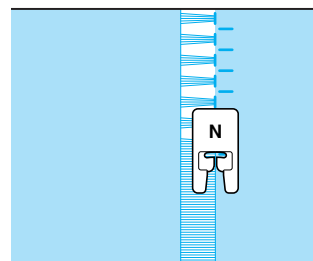

3

Utility Stitches

4 Press  to create a mirror image of the stitch.

5 Sew the opposite side to keep the stitch symmetrical.

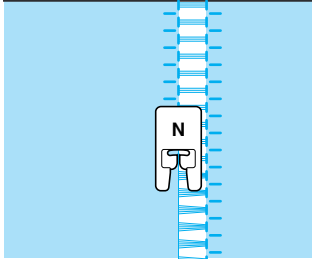

■ Hemstitching (3) (Drawn Work (2))

1 Pull out several threads from both sides of the 4 mm (approx. 3/16 inch) area which are not yet open.

* Pull out four threads, leave five threads, and then pull out four threads. The width of five threads is approximately 4 mm (approx. 3/16 inch) or less.

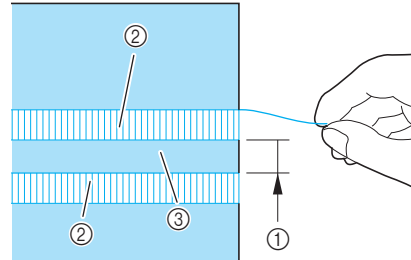

- ① Approx. 4 mm (approx. 3/16 inch) or less
- ② Four threads (pull out)
- ③ Five threads (leave)

2 Select .



Memo

For details on each stitch, refer to the "STITCH SETTING CHART" at the end of this manual.

3 Sew the decorative stitch in the center of the five threads created above.

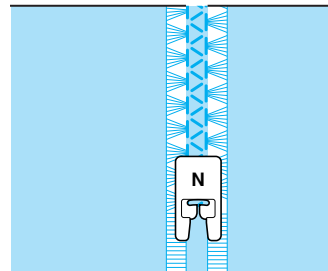































Memo

A wing needle can be used for Hemstitching (3).

One-step Buttonholes

With one-step buttonholes, you can make buttonholes appropriate to the size of your button.

Stitch	Stitch name	Presser foot	Applications	Stitch width [mm (inch.)]		Stitch length [mm (inch.)]		Twin needle
				Auto.	Manual	Auto.	Manual	
	Narrow rounded buttonhole		Buttonhole on light to medium weight fabrics	5.0 (3/16)	3.0 - 5.0 (1/8 - 3/16)	0.4 (1/64)	0.2 - 1.0 (1/64 - 1/16)	NO
	Wide round ended buttonhole		Buttonholes with extra space for larger buttons	5.5 (7/32)	3.5 - 5.5 (1/8 - 7/32)	0.4 (1/64)	0.2 - 1.0 (1/64 - 1/16)	NO
	Tapered round ended buttonhole		Reinforced waist tapered buttonholes	5.0 (3/16)	3.0 - 5.0 (1/8 - 3/16)	0.4 (1/64)	0.2 - 1.0 (1/64 - 1/16)	NO
	Round ended buttonhole		Buttonholes with vertical bar tack in heavyweight fabrics	5.0 (3/16)	3.0 - 5.0 (1/8 - 3/16)	0.4 (1/64)	0.2 - 1.0 (1/64 - 1/16)	NO
	Round ended buttonhole		Buttonholes with bar tack	5.0 (3/16)	3.0 - 5.0 (1/8 - 3/16)	0.4 (1/64)	0.2 - 1.0 (1/64 - 1/16)	NO
	Round double ended buttonhole		Buttonholes for fine, medium to heavyweight fabrics	5.0 (3/16)	3.0 - 5.0 (1/8 - 3/16)	0.4 (1/64)	0.2 - 1.0 (1/64 - 1/16)	NO
	Narrow squared buttonhole		Buttonholes for light to medium weight fabrics	5.0 (3/16)	3.0 - 5.0 (1/8 - 3/16)	0.4 (1/64)	0.2 - 1.0 (1/64 - 1/16)	NO
	Wide squared buttonhole		Buttonholes with extra space for larger decorative buttons	5.5 (7/32)	3.5 - 5.5 (1/8 - 7/32)	0.4 (1/64)	0.2 - 1.0 (1/64 - 1/16)	NO
	Squared buttonhole		Heavy-duty buttonholes with vertical bar tacks	5.0 (7/32)	3.0 - 5.0 (1/8 - 3/16)	0.4 (1/64)	0.2 - 1.0 (1/64 - 1/16)	NO
	Stretch buttonhole		Buttonholes for stretch or woven fabrics	6.0 (15/64)	3.0 - 6.0 (1/8 - 15/64)	1.0 (1/16)	0.5 - 2.0 (1/32 - 1/16)	NO
	Heirloom buttonhole		Buttonholes for heirloom and stretch fabrics	6.0 (15/64)	3.0 - 6.0 (1/8 - 15/64)	1.5 (1/16)	1.0 - 3.0 (1/1 - 1/8)	NO
	Bound buttonhole		The first step in making bound buttonholes	5.0 (3/16)	0.0 - 6.0 (0 - 15/64)	2.0 (1/16)	0.2 - 4.0 (1/64 - 3/16)	NO
	Keyhole buttonhole		Buttonholes in heavyweight or thick fabrics for larger flat buttons	7.0 (1/4)	3.0 - 7.0 (1/8 - 1/4)	0.5 (1/32)	0.3 - 1.0 (1/64 - 1/16)	NO
	Tapered keyhole buttonhole		Buttonholes in medium to heavy weight fabrics for larger flat buttons	7.0 (1/4)	3.0 - 7.0 (1/8 - 1/4)	0.5 (1/32)	0.3 - 1.0 (1/64 - 1/16)	NO
	Keyhole buttonhole		Buttonholes with vertical bar tack for reinforcement in heavyweight or thick fabrics	7.0 (1/4)	3.0 - 7.0 (1/8 - 1/4)	0.5 (1/32)	0.3 - 1.0 (1/64 - 1/16)	NO



3

Utility Stitches

One-step buttonholes are sewn from the front of the presser foot to the back, as shown below.

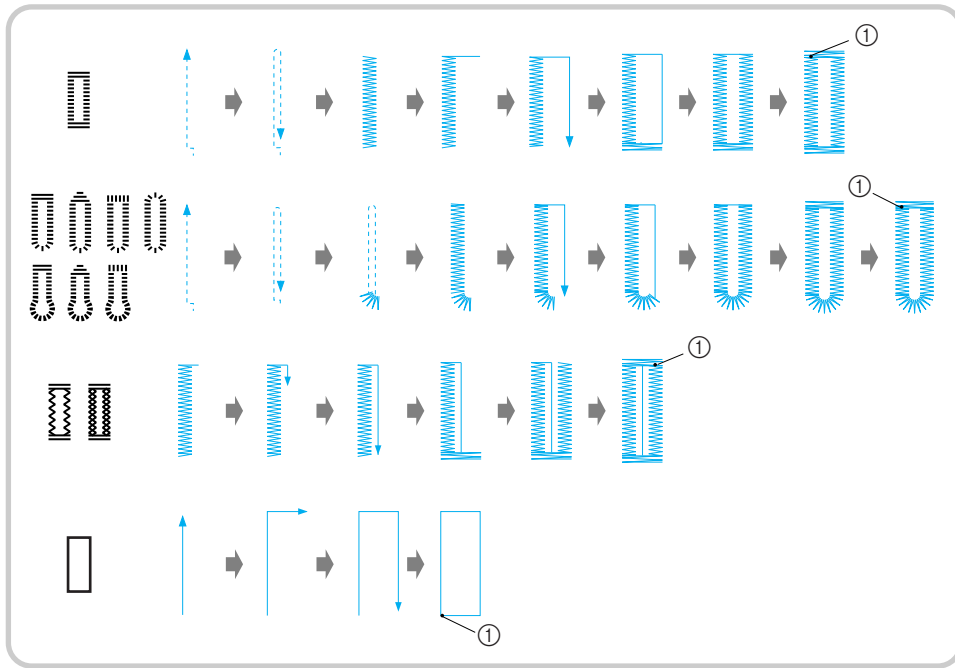

① Reinforcement stitching

- 1 Select a buttonhole stitch, and attach buttonhole foot “A”.
- 2 Mark the position and length of the buttonhole on the fabric.

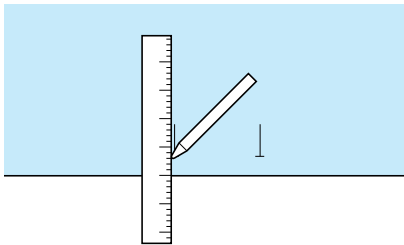

Memo

The maximum buttonhole length is about 28 mm (approx. 1-1/16 inches) (diameter + thickness of the button).

3

- 3 Pull out the button holder plate on the presser foot, and insert the button that will be put through the buttonhole. Then tighten the button holder plate around the button.

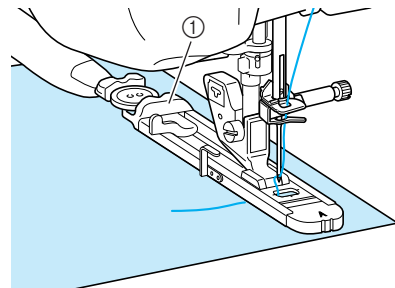

① Button holder plate



Memo

The size of the buttonhole is decided by the button holder plate holding the button.

4 Align the presser foot with the mark on the fabric, and lower the presser foot.

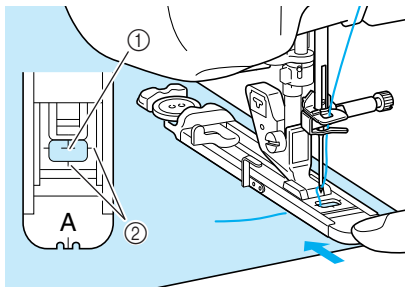

- ① Mark on the fabric
- ② Marks on the presser foot



Note

- Pass the thread underneath the presser foot.
- Slide the outside frame of the buttonhole foot backward as far as possible as shown in the illustration, making sure that there is no gap behind the part of the foot marked "A". If the buttonhole foot is not slid back as far as possible, the buttonhole will not be sewn at the correct size.

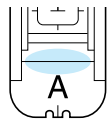

5 Lower the buttonhole lever so that it is positioned behind the metal bracket on the buttonhole foot.

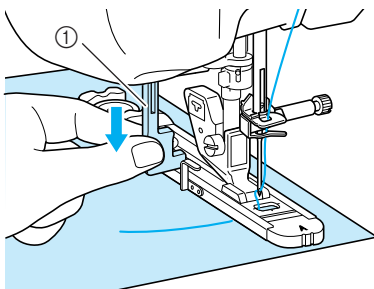

- ① Buttonhole lever

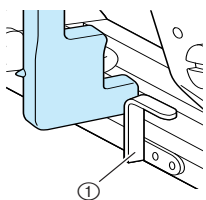

- ① Metal bracket

6 Gently hold the end of the upper thread, and then start sewing.

- * Feed the fabric carefully by hand while the buttonhole is sewn.

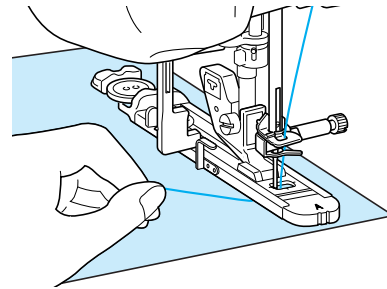

- Once sewing is completed, the machine automatically sews reinforcement stitches, and then stops.



Memo

If automatic thread cutting is turned on before you start sewing, both threads are automatically cut after the reinforcement stitches are sewn. If the fabric does not feed (for example, because it is too thick), increase the stitch length setting.

7 Insert a pin along the inside of one of the bar tacks, and then insert the seam ripper into the center of the buttonhole and cut towards the pin.

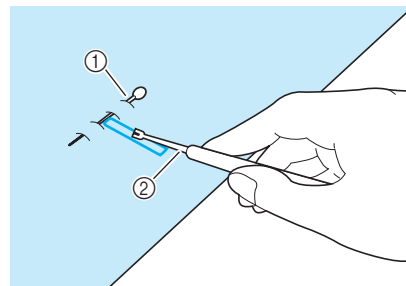

- ① Basting pin
- ② Seam ripper

CAUTION

When using the seam ripper to open the buttonhole, do not put your hand or finger in the path of the ripper. The ripper may slip and cause injury. Do not use the seam ripper in any other way than how it is intended.



3

Utility Stitches



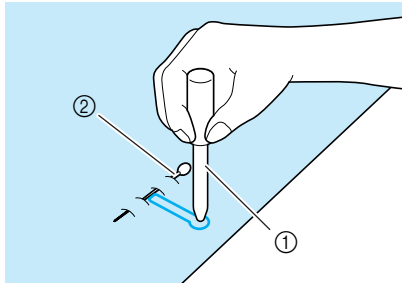

Memo

For keyhole buttonholes, use the eyelet punch to make a hole in the rounded end of the buttonhole. Then insert a pin along the inside of one of the bar tacks, insert a seam ripper into the hole made with the eyelet punch, and cut towards the pin.



- ① Eyelet punch
- ② Basting pin

■ Sewing Stretch Fabrics

When sewing on stretch fabric with  or , sew the buttonhole stitches over a gimp thread.

- 1** Hook the gimp thread onto the back of presser foot “A”. Insert the ends into the grooves at the front of the presser foot, and then temporarily tie them there.

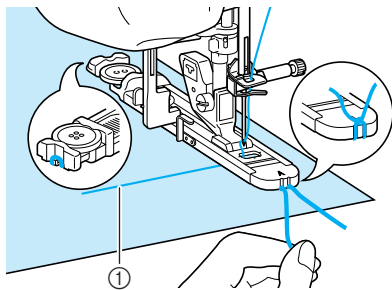

- ① Upper thread

- 2** Lower the presser foot and start sewing.

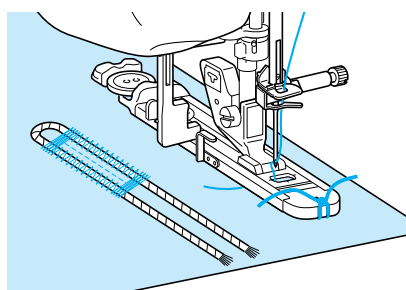

Memo

Set the width of the satin stitches to the width of the gimp thread, and set the buttonhole width to be 2-3 times the width of the gimp thread.

3

Once sewing is completed, gently pull the gimp thread to remove any slack, and trim off any excess.

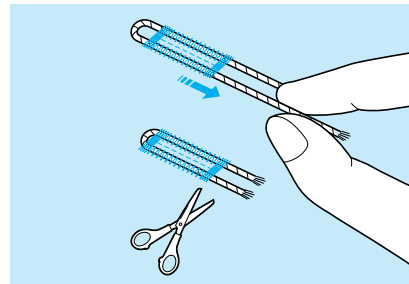

Memo

After using the seam ripper to cut open the threads over the buttonhole, trim off the threads.

■ Odd Shaped Buttons/Buttons that do not Fit into the Button Holder Plate

Use the markings on the presser foot scale to set the size of the buttonhole. One mark on the presser foot scale equals 5 mm (approx. 3/16 inch). Add the button diameter and thickness together, and then set the plate at the calculated value.

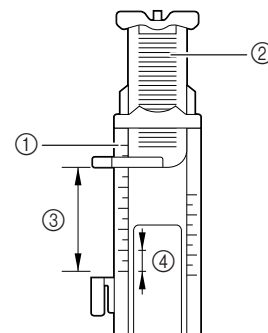

- ① Presser foot scale
- ② Button holder plate
- ③ Completed measurement of diameter + thickness
- ④ 5 mm (approx. 3/16 inch)



Memo

For example, for a button with a diameter of 15 mm (approx. 9/16 inch) and a thickness of 10 mm (approx. 3/8 inch), the scale should be set at 25 mm (approx. 1 inch).

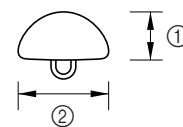







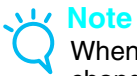

- ① 10 mm (approx. 3/8 inch)
- ② 15 mm (approx. 9/16 inch)

Four-step Buttonholes

You can sew 4-step buttonholes using the following 4 stitches together. You can sew any desired length for the buttonhole when using 4-step buttonholes. 4-step buttonholes are a good option when attaching oversized buttons.



Note When changing the stitch settings for the left side of the buttonhole, make sure that all settings should be changed to match.

Stitch	Stitch name	Presser foot	Applications	Stitch width [mm (inch.)]		Stitch length [mm (inch.)]		Twin needle
				Auto.	Manual	Auto.	Manual	
	4 step buttonhole 1		Left side of 4 step buttonhole	5.0 (7/32)	1.5 - 7.0 (1/16 - 1/4)	0.4 (1/64)	0.2 - 1.0 (1/64 - 1/16)	NO
	4 step buttonhole 2		Bar tack of 4 step buttonhole	5.0 (7/32)	1.5 - 7.0 (1/16 - 1/4)	0.4 (1/64)	0.2 - 1.0 (1/64 - 1/16)	NO
	4 step buttonhole 3		Right side of 4 step buttonhole	5.0 (7/32)	1.5 - 7.0 (1/16 - 1/4)	0.4 (1/64)	0.2 - 1.0 (1/64 - 1/16)	NO
	4 step buttonhole 4		Bar tack of 4 step buttonhole	5.0 (7/32)	1.5 - 7.0 (1/16 - 1/4)	0.4 (1/64)	0.2 - 1.0 (1/64 - 1/16)	NO

Four-step buttonholes are sewn as shown below.

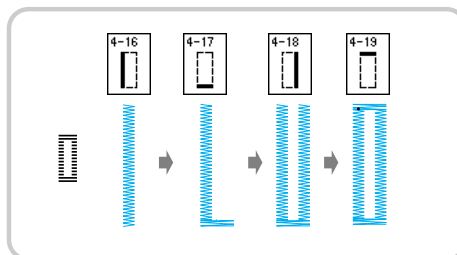

- 1 Mark the position and length of the buttonhole on the fabric.

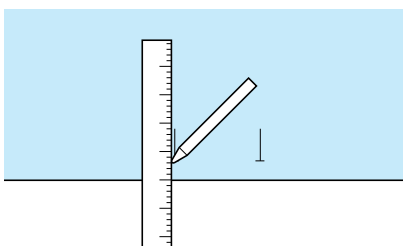

- 2 Attach monogramming foot "N", and select stitch  to sew the left side of the buttonhole.

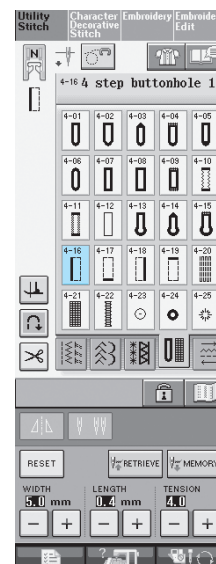

3

Utility Stitches

- 3** Press the “Start/Stop” button to start sewing.
- 4** Sew the desired length for the buttonhole and press the “Start/Stop” button again.

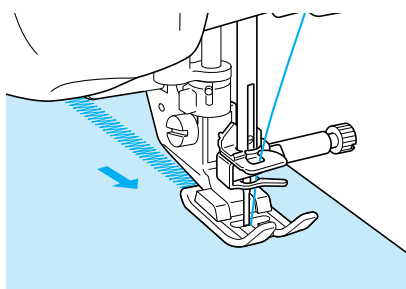

- 5** Select stitch  to sew the bar tack and press the “Start/Stop” button.

→ The machine will automatically stop after sewing the bar tack.

- 6** Select stitch  to sew the right side of the buttonhole, and press the “Start/Stop” button to begin sewing.

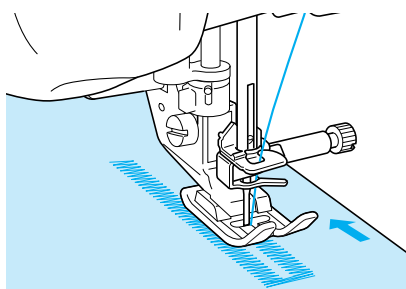

- 7** Sew the right side of the buttonhole and press the “Start/Stop” button again.

* Sew the right side of the buttonhole the same length as the left.



- 8** Select stitch  to sew the bar tack and then press the “Start/Stop” button.

→ The machine will automatically sew off the bar tack tie and stop when the bar tack is complete.

- 9** Raise the presser foot and remove the fabric.
- 10** Refer to page 99 to open the buttonhole.

Darning

Use darning stitches for mending and other applications.

Stitch	Stitch name	Presser foot	Applications	Stitch width [mm (inch.)]		Stitch length [mm (inch.)]		Twin needle
				Auto.	Manual	Auto.	Manual	
4-20	Darning		Darning of medium weight fabric	7.0 (1/4)	2.5 - 7.0 (3/32 - 1/4)	2.0 (1/16)	0.4 - 2.5 (1/64 - 1/16)	NO
4-21	Darning		Darning of heavyweight fabric	7.0 (1/4)	2.5 - 7.0 (3/32 - 1/4)	2.0 (1/16)	0.4 - 2.5 (1/64 - 1/16)	NO

Darning is performed by sewing from the front of the presser foot to the back as shown below.

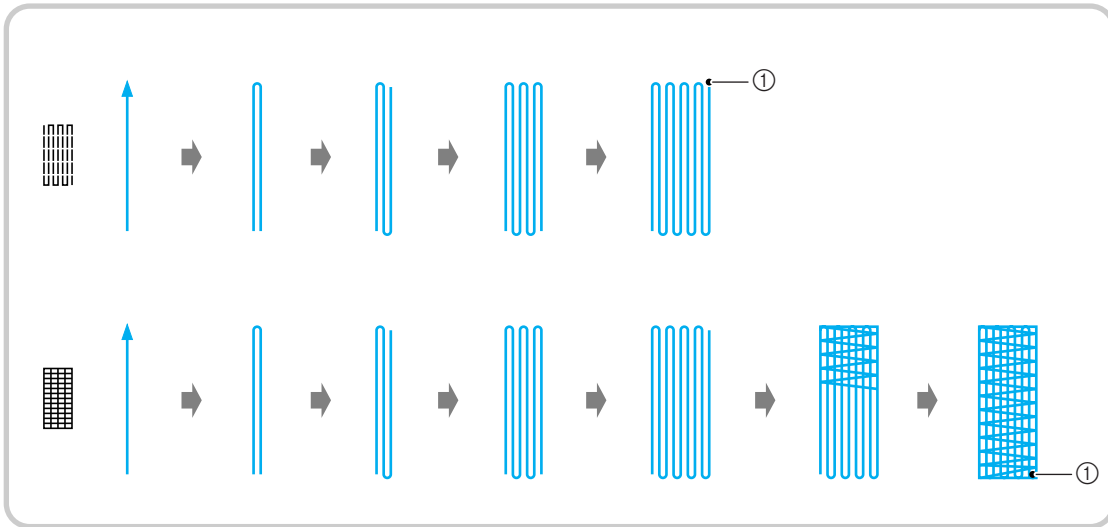

① Reinforcement stitches

- 1 Select a stitch, and attach buttonhole foot "A".
- 2 Set the scale to the desired length of the darning.

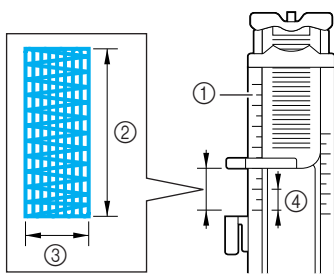

- 1 Presser foot scale
- 2 Completed length measurement
- 3 Width 7 mm (approx. 1/4 inch)
- 4 5 mm (approx. 3/16 inch)

Memo

The maximum length for darning is 28 mm (approx. 1-1/16 inches).

- 3 Check that the needle drops at the desired position and lower the presser foot, making sure the upper thread passes underneath the buttonhole foot.

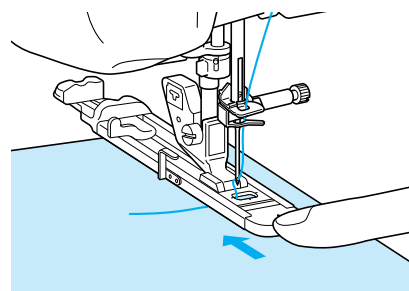

Note

- Pass the thread underneath the presser foot.
- Set the presser foot so that there is no gap behind the section marked with an "A" (the shaded area in the illustration below). If there is a gap, the size of the darning will not be correct.

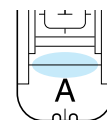

3

Utility Stitches

- 4** Lower the buttonhole lever so that it is positioned behind the metal bracket on the buttonhole foot.

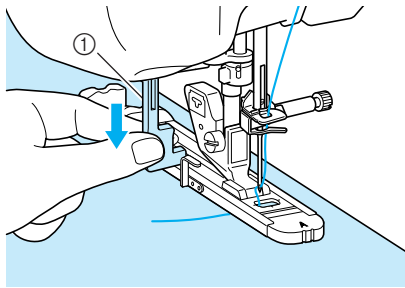

① Buttonhole lever

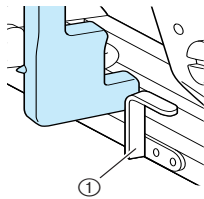

① Metal bracket

- 5** Gently hold the end of the upper thread, and then press the “Start/Stop” button to start the machine.

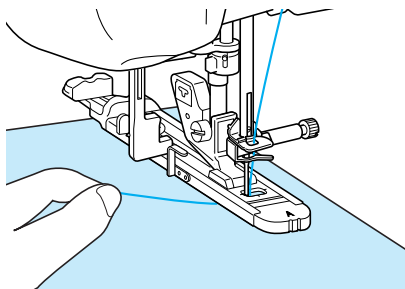

→ Once sewing is completed, the machine automatically sews reinforcement stitches, and then stops.





Memo

If automatic thread cutting is turned on before you start sewing, both threads are automatically cut after the reinforcement stitches are sewn. If the fabric does not feed (for example, because it is too thick), increase the stitch length setting.

Bar Tacks

Use bar tacks to reinforce areas that will be subject to strain, such as pocket corners.

Stitch	Stitch name	Presser foot	Applications	Stitch width [mm (inch.)]		Stitch length [mm (inch.)]		Twin needle
				Auto.	Manual	Auto.	Manual	
	Bar tack		Reinforcement at opening of pocket, etc.	2.0 (1/16)	1.0 - 3.0 (1/16 - 1/8)	0.4 (1/64)	0.3 - 1.0 (1/64 - 1/16)	NO

1 Select .

2 Attach buttonhole foot "A" and set the scale to the length of the bar tack you wish to sew.

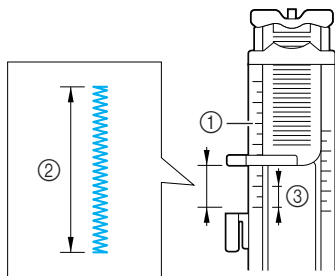

- ① Presser foot scale
- ② Completed length measurement
- ③ 5 mm (approx. 3/16 inch)

Memo

Bar tacks can be between 5 mm (approx. 3/16 inch) and 28 mm (approx. 1-1/16 inches). Bar tacks are usually between 5 mm (approx. 3/16 inch) and 10 mm (approx. 3/8 inch).

3 Set the fabric so that the pocket moves towards you during sewing.

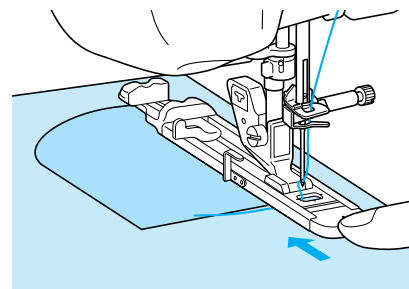

Note

- Pass the thread underneath the presser foot.
- Slide the outside frame of the buttonhole foot backward as far as possible as shown in the illustration, making sure that there is no gap behind the part of the foot marked "A". If the buttonhole foot is not slid back as far as possible, the bar tack will not be sewn to the correct size.

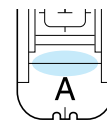

4 Check the first needle drop point and lower the presser foot.

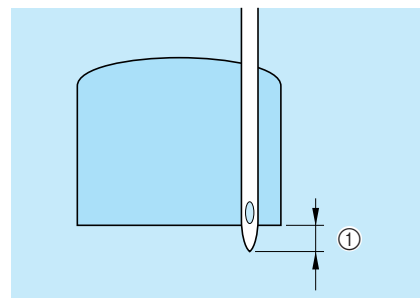

- ① 2 mm (approx. 1/16 inch)



3

Utility Stitches

- 5** Lower the buttonhole lever so that it is positioned behind the metal bracket on the buttonhole foot.

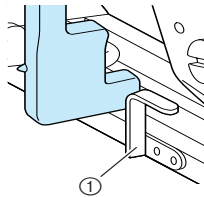
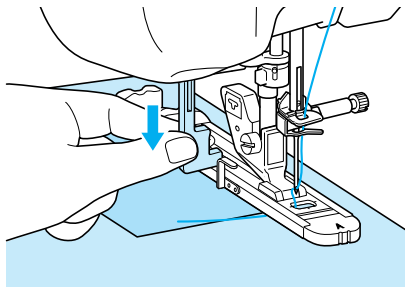

① Metal bracket

- 6** Gently hold the end of the upper thread and begin sewing.

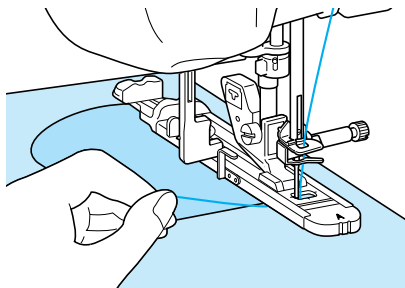

→ When sewing is completed, the machine will sew reinforcement stitches and stop automatically.

■ Bar Tacks on Thick Fabrics

Place a piece of folded fabric or cardboard beside the fabric being sewn to level the buttonhole foot and allow for easier feeding.

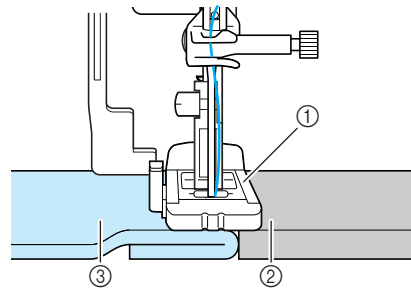

- ① Presser foot
- ② Thick paper
- ③ Fabric





Memo

If automatic thread cutting is turned on before you start sewing, both threads are automatically cut after the reinforcement stitches are sewn. If the fabric does not feed (for example, because it is too thick), increase the stitch length setting.

Button Sewing

Buttons can be sewn on using the machine.

Buttons with 2 or 4 holes can be attached.

Stitch	Stitch name	Presser foot	Applications	Stitch width [mm (inch.)]		Stitch length [mm (inch.)]		Twin needle
				Auto.	Manual	Auto.	Manual	
4-23 	Button sewing		Attaching buttons	3.5 (1/8)	2.5 - 4.5 (3/32 - 3/16)	—	—	NO



Note

- Do not use the automatic thread cutting function when sewing buttons. Otherwise, you will lose the thread ends.

1 Select .

2 Raise the presser foot and detach the flat bed table attachment.

3 Lower the feed dog position switch to lower the feed dogs.

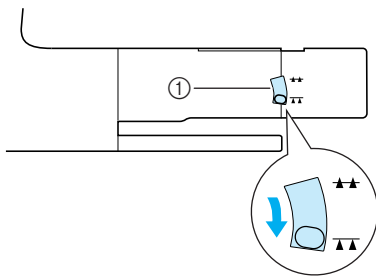

① Feed dog position switch

4 Attach button sewing foot "M", slide the button along the metal plate and into the presser foot, and lower the presser foot.

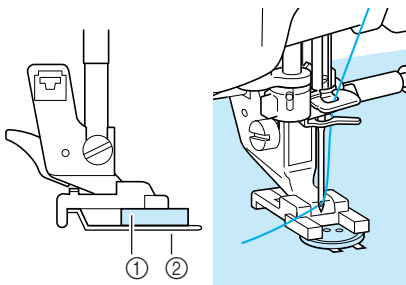

① Button

② Metal plate

5 Turn the handwheel to check that the needle goes into each hole correctly.

- * If the needle does not reach the holes on the left side, adjust the stitch width.
- * To attach the button more securely, repeat the process.

6 Gently hold the end of the upper thread and start sewing.

→ The machine stops automatically when sewing is finished.

CAUTION

Make sure the needle does not strike the button during sewing. The needle may break and cause injury.

7 From the wrong side of the fabric, pull the end of the bobbin thread to pull the upper thread through to the wrong side of the fabric. Tie the two thread ends together and cut the threads.

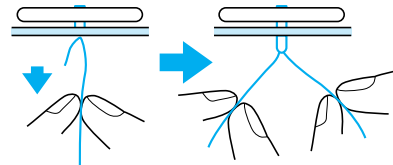

3

Utility Stitches

■ Attaching 4 Hole Buttons

Sew the two holes closest to you. Then raise the presser foot and move the fabric so that the needle goes into the next two holes, and sew them in the same way.

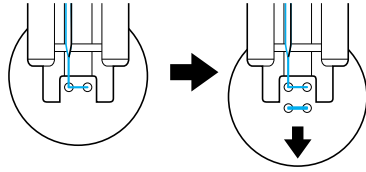

■ Attaching a Shank to the Button

- 1** Pull the shank lever toward you before sewing.

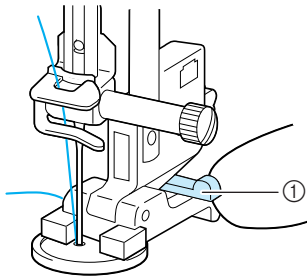

① Shank lever

- 2** Pull the two ends of the upper thread between the button and the fabric, wind them around the shank, and then tie them firmly together.

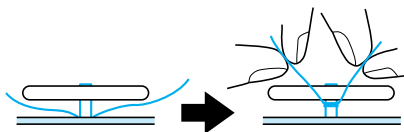

- 3** Tie the ends of the bobbin thread from the beginning and end of sewing together on the wrong side of the fabric.



Note

- When sewing is completed, be sure to return the feed dog position switch to its original position.

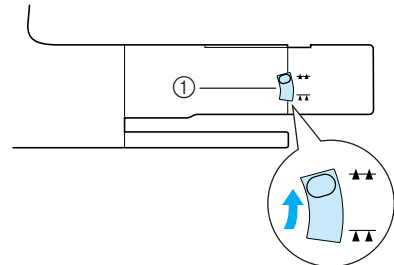







① Feed dog position switch



- 4** Cut off any excess thread.

Eyelet

Use this stitch for making belt holes and other similar applications.



Stitch	Stitch name	Presser foot	Applications	Stitch width [mm (inch.)]		Stitch length [mm (inch.)]		Twin needle
				Auto.	Manual	Auto.	Manual	
4-24 	Eyelet		For making eyelets, holes on belts, etc.	7.0 (1/4)	7.0 6.0 5.0 (1/4 15/64 3/16)	7.0 (1/4)	7.0 6.0 5.0 (1/4 15/64 3/16)	NO
4-25 	Star eyelet		For making star-shaped eyelets on holes.	—	—	—	—	NO

1 Select  or .

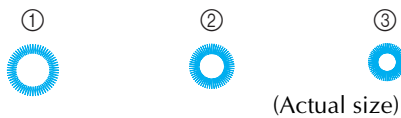
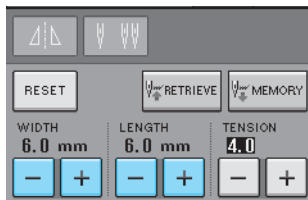
2 Use   in either the stitch width display or the stitch length display to choose the size of the eyelet.



- ① Large 7 mm (approx. 1/4 inch)
- ② Medium 6 mm (approx. 15/64 inch)
- ③ Small 5 mm (approx. 3/16 inch)

 **Note** Only one size is available for .

3 Attach monogramming foot “N”, then turn the handwheel to check the needle drop position.

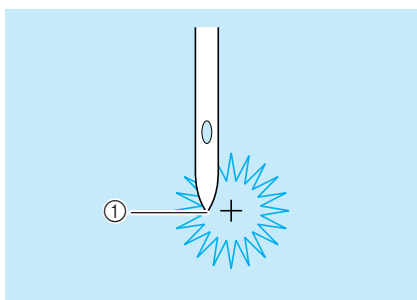

- ① Needle drop position

4 Lower the presser foot and start sewing.

→ When sewing is finished, the machine sews reinforcement stitches and stops automatically.

 **Note** If the stitch pattern comes out poorly, make adjustments (see page 121).

5 Use the eyelet punch to make a hole in the center of the stitching.

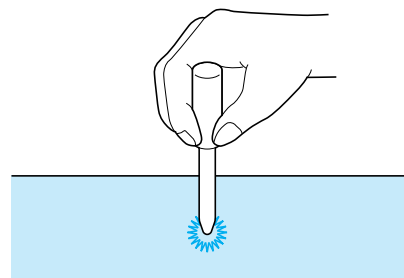

3

Utility Stitches

Multi-directional Sewing (Straight Stitch and Zigzag Stitch)

Use these stitch patterns to attach patches or emblems to pant legs, shirt sleeves, etc.

- 1 Remove the flat bed attachment to create the free arm function.

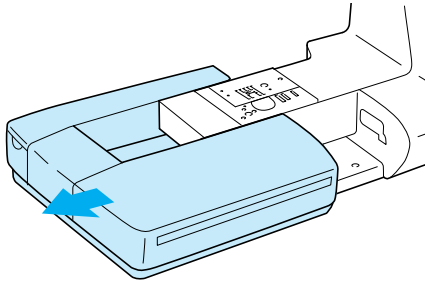

Memo

Pass the free arm through a tubular piece of fabric, and then sew in the order shown in the illustration.

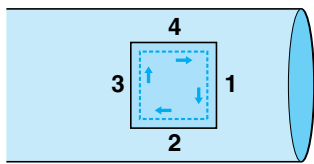

- 2 Select  and attach monogramming foot "N".

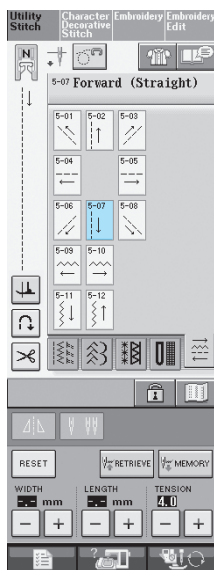

Memo

For details on each stitch, refer to the "STITCH SETTING CHART" at the end of this manual.

- 3 Set the needle in the fabric at the sewing start point, and sew seam "1" as shown.

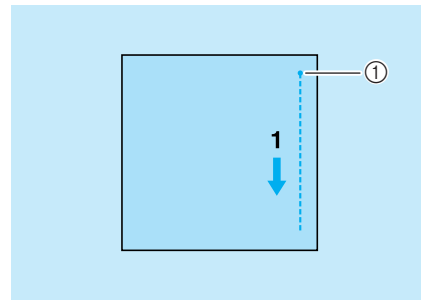

① Start Point

- 4 Select  and sew seam "2" as shown.

* The fabric will move sideways, so guide the fabric by hand to keep sewing straight.

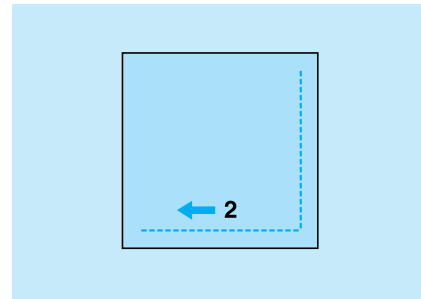

- 5 Select  and sew seam "3" as shown.

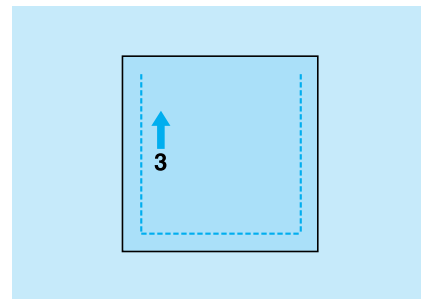

→ The fabric feeds forward while stitching backward.

- 6 Select  and sew seam "4" as shown.

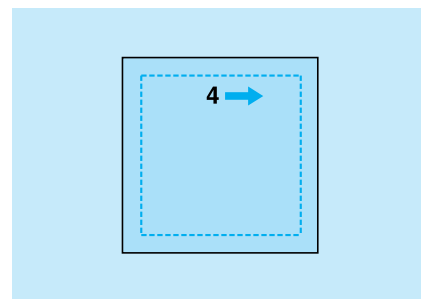

→ The seam will be connected to the starting point of seam 1.

Zipper Insertion

Centered Zipper

Use for bags and other such applications.

1 Select .

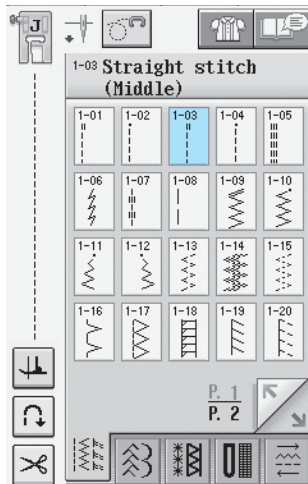

Memo

- For details on each stitch, refer to the "STITCH SETTING CHART" at the end of this manual.

Note

- Make sure you sew using the middle needle position.

2 Attach presser foot "J" and sew straight stitches up to the zipper opening. Change to a basting stitch (see page 67) and sew to the top of the fabric.

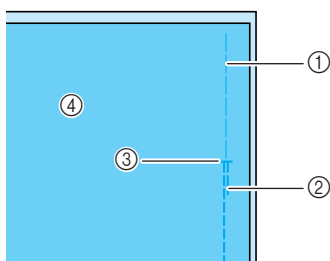

- ① Basting stitches
- ② Reverse stitches
- ③ End of zipper opening
- ④ Wrong side

3 Press the seam allowance open and attach the zipper with a basting stitch in the middle of each side of the zipper tape.

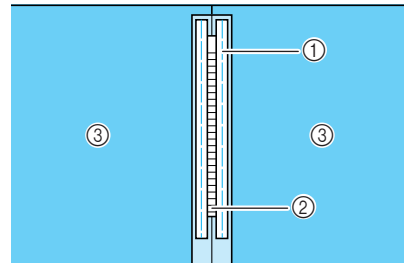

- ① Basting stitches
- ② Zipper
- ③ Wrong side

4 Remove presser foot "J". Align the right side of the pin in zipper foot "I" with the presser foot holder, and attach the zipper foot.

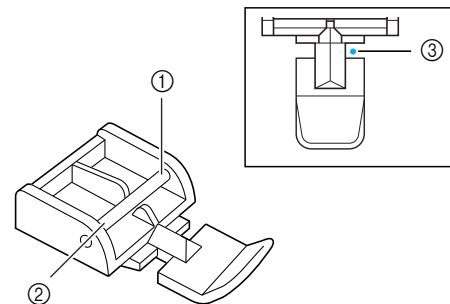

- ① Right
- ② Left
- ③ Needle drop position

CAUTION

- When using zipper foot "I", make sure the straight stitch, middle needle position is selected. Turn the handwheel to make sure the needle does not strike the presser foot. If another stitch is selected, the needle will strike the presser foot, causing the needle to break and possibly causing injury.

5 Topstitch 7 to 10 mm (approx. 1/4 to 3/8 inch) from the seamed edge of the fabric, then remove the basting.

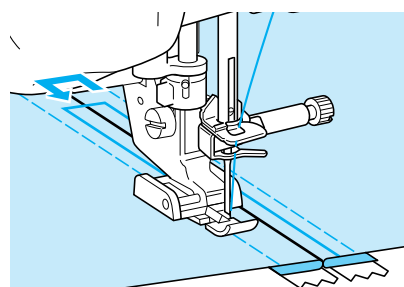

3

Utility Stitches

CAUTION

Make sure the needle does not strike the zipper during sewing. If the needle strikes the zipper, the needle may break, leading to injury.

Inserting a Side Zipper

Use for side zippers in skirts or dresses.

1 Select 1-03.

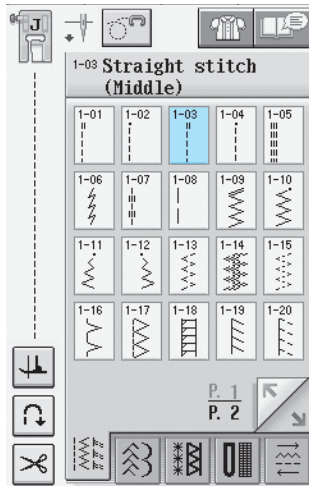

Note

- Make sure you sew using the middle needle position.

2 Attach presser foot "J" and sew straight stitches up to the zipper opening. Change to a basting stitch and sew to the top of the fabric.

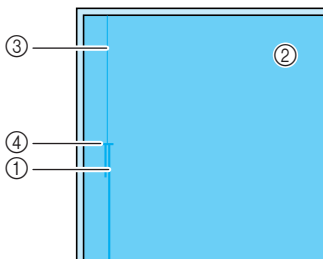

- 1 Reverse stitches
- 2 Wrong side of fabric
- 3 Basting stitches
- 4 End of zipper opening

3 Press the seam allowance open and align the folded hem along the teeth of the zipper, while maintaining 3 mm (approx. 1/8 inch) of sewing space.

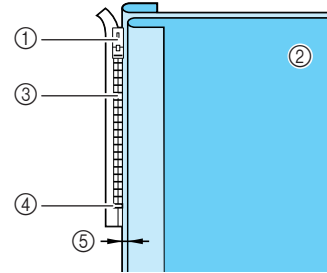

- 1 Zipper pull tab
- 2 Wrong side of fabric
- 3 Zipper teeth
- 4 End of zipper opening
- 5 3 mm (approx. 1/8 inch)

4 Remove presser foot "J".

5 Align the right side of the pin in zipper foot "I" with the presser foot holder, and attach the presser foot.

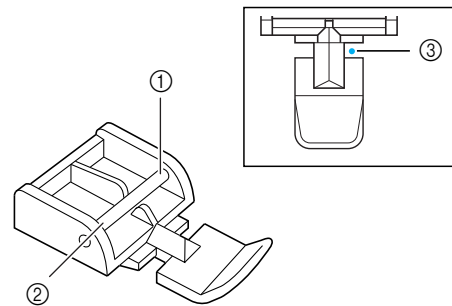

- 1 Right
- 2 Left
- 3 Needle drop position

CAUTION

When using zipper foot "I", make sure the straight stitch, middle needle position is selected. Turn the handwheel to make sure the needle does not strike the presser foot. If another stitch is selected, the needle will strike the presser foot, causing the needle to break and possibly causing injury.

- 6 Set the presser foot in the 3 mm (approx. 1/8 inch) margin.
- 7 Starting from the end of the zipper opening, sew to a point about 50 mm (approx. 2 inches) from the edge of the fabric, then stop the machine.
- 8 Pull down the zipper slider, then continue sewing to the edge of the fabric.

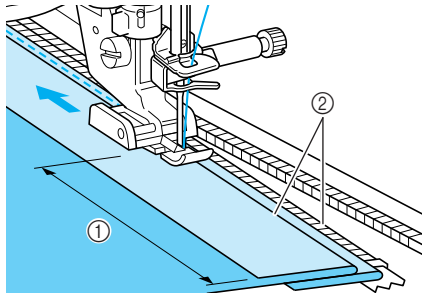

- ① 50 mm (approx. 2 inches)
- ② 3 mm (approx. 1/8 inch)

CAUTION

Make sure the needle does not strike the zipper during sewing. If the needle strikes the zipper, the needle may break, leading to injury.

- 9 Close the zipper, turn the fabric over, and sew a basting stitch.

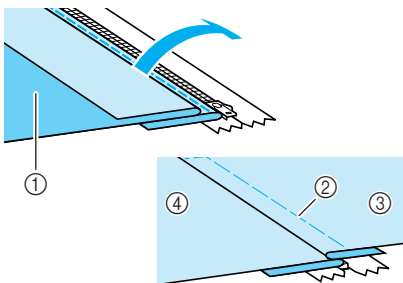

- ① Front of the skirt (wrong side of fabric)
- ② Basting stitches
- ③ Front of the skirt (right side of fabric)
- ④ Back of the skirt (right side of fabric)

- 10 Remove the presser foot, and reattach it so that the left side of the pin is attached to the presser foot holder.

- * When sewing the left side of the zipper, the needle should drop on the right side of the presser foot. When sewing the right side of the zipper, the needle should drop on the left side of the presser foot.

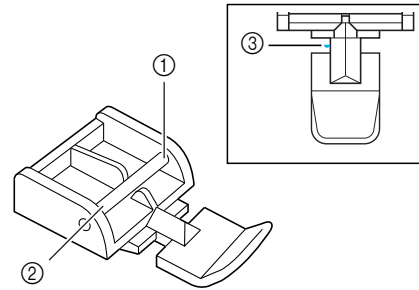

- ① Right
- ② Left
- ③ Needle drop position

- 11 Set the fabric so that the left edge of the presser foot touches the edge of the zipper teeth.

- 12 Sew reverse stitches at the top of the zipper, then continue sewing.

- 13 Stop sewing about 50 mm (approx. 2 inches) from the edge of the fabric, leave the needle in the fabric, and remove the basting stitches.

- 14 Open the zipper and sew the rest of the seam.

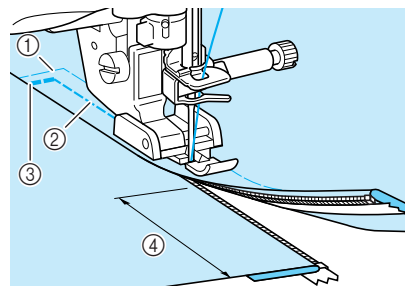

- ① Basting stitches
- ② 7 to 10 mm (approx. 1/4 inch to 3/8 inch)
- ③ Reverse stitches
- ④ 50 mm (approx. 2 inches)



3

Utility Stitches



Chapter 4

Character/ Decorative Stitches

SELECTING STITCH PATTERNS	116
■ Stitch Selection Screens	117
Selecting Decorative Stitch Patterns/7mm Decorative Stitch Patterns/Satin Stitch Patterns/7mm Satin Stitch Patterns/ Cross Stitch/Utility Decorative Stitch Patterns	118
Alphabet Characters	118
■ Deleting Characters	119
■ Character Spacing Adjustment	119
SEWING STITCH PATTERNS	120
Sewing Attractive Finishes	120
Basic Sewing	120
Making Adjustments	121
EDITING STITCH PATTERNS	123
■ Key Functions	123
Changing the Size	124
Changing the Length (for 7mm Satin Stitch Patterns Only)	125
Creating a Vertical Mirror Image	125
Creating a Horizontal Mirror Image	125
Sewing a Pattern Continuously	125
Changing Thread Density (for Satin Stitch Patterns Only)	126
Returning to the Beginning of the Pattern	126
Checking the Image	127
COMBINING STITCH PATTERNS	128
Before Combining	128
Combining Various Stitch Patterns	128
Combining Large and Small Stitch Patterns	130
Combining Horizontal Mirror Image Stitch Patterns	130
Combining Stitch Patterns of Different Length	131
Making Step Stitch Patterns (for 7mm Satin Stitch Patterns Only)	132
■ More Examples	133
USING THE MEMORY FUNCTION	134
Stitch Data Precautions	134
■ Types of Stitch Data that can be Used	134
■ Types of USB Devices/Media that can be Used	134
■ Computers and Operating Systems with the Following Specifications can be Used	134
■ Precautions on Using the Computer to Create and Save Data	134
■ Trademarks	135
Saving Stitch Patterns in the Machine's Memory	136
■ If the Memory is Full	136
Saving Stitch Patterns to USB Media (Commercially Available)	138
Saving Stitch Patterns in the Computer	139
Retrieving Stitch Patterns from the Machine's Memory	140
Recalling from USB Media	141
Recalling from the Computer	142

SELECTING STITCH PATTERNS

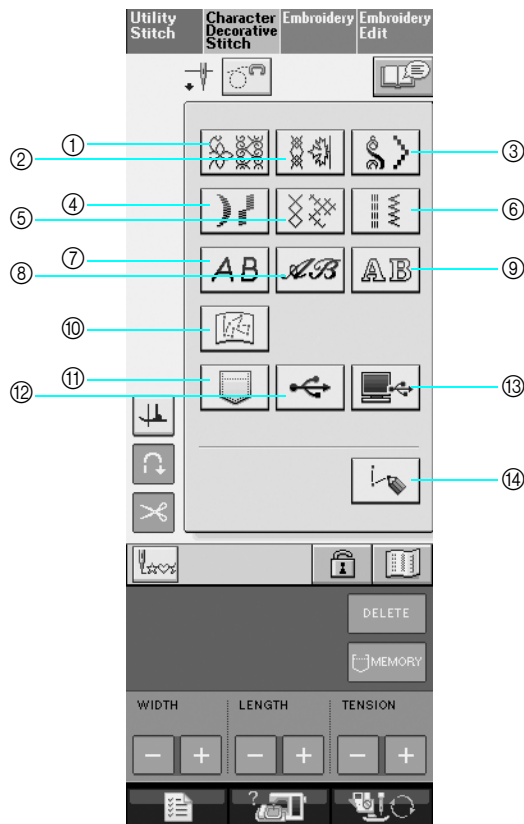

Press  to display the screen below.



- ① Decorative stitch patterns
- ② 7mm decorative stitch patterns. You can set stitch length and width.
- ③ Satin stitch patterns
- ④ 7mm satin stitch patterns. You can set stitch length and width.
- ⑤ Cross stitch
- ⑥ Utility decorative stitch patterns
- ⑦ Alphabet characters (gothic font)
- ⑧ Alphabet characters (handwriting font)
- ⑨ Alphabet characters (outline)
- ⑩ Patterns stored in "MY CUSTOM STITCH™" (see page 234)
- ⑪ Patterns saved in the machine's memory (see page 140)
- ⑫ Patterns saved in USB media (see page 141)
- ⑬ Patterns saved on the computer (see page 142)
- ⑭ Press this key to create your own stitches with the "MY CUSTOM STITCH™" function (see page 228).



Note

- If the screen is locked () , unlock the screen by pressing  . While the screen is locked, no other key can be operated.

Stitch Selection Screens

There are 9 categories of Character/Decorative stitch patterns.  indicates that there is more than one stitch selection screen for that category.

Decorative Stitch Patterns

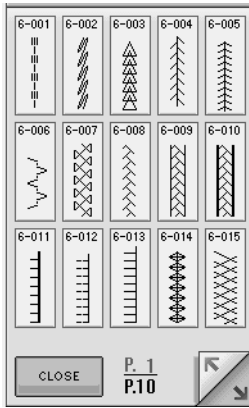

7mm Decorative Stitch Patterns

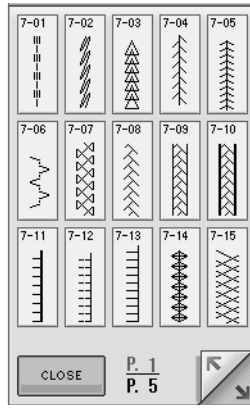

Satin Stitch Patterns

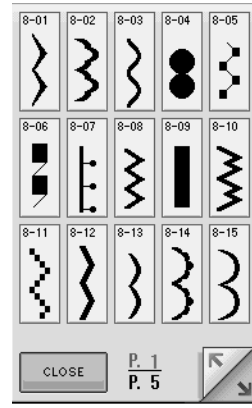

7mm Satin Stitch Patterns

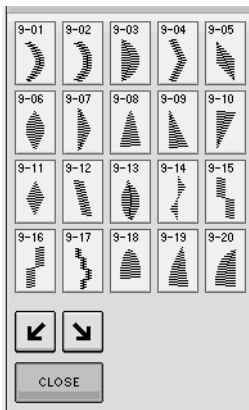

Cross Stitch

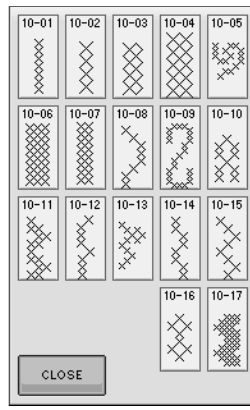

Utility Decorative Stitch Patterns

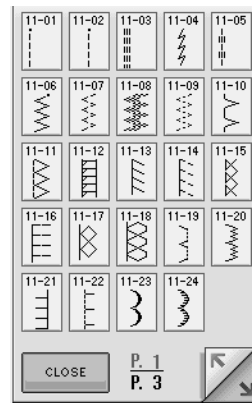

Alphabet Characters (Gothic Font)



Alphabet Characters (Handwriting Font)

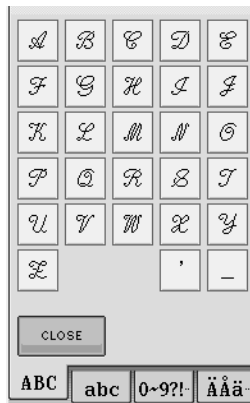

Alphabet Characters (Outline)





4

Character/Decorative Stitches

Selecting Decorative Stitch Patterns/7mm Decorative Stitch Patterns/7mm Satin Stitch Patterns/Satin Stitch Patterns/7mm Satin Stitch Patterns/Cross Stitch/Utility Decorative Stitch Patterns

1 Select the category of the pattern you want to sew.

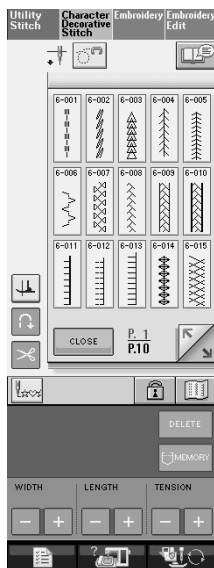

2 Press the key of the stitch pattern you want to sew.

- * Press  to view the next page.
- * Press  to view the previous page.
- * To select a different stitch pattern, press . When the current stitch pattern is erased, select the new stitch pattern.







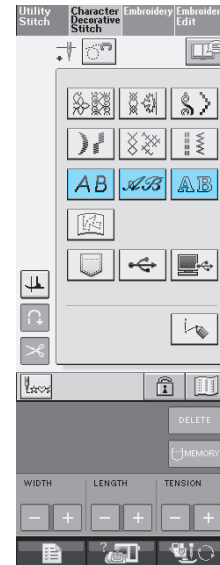

→ The selected pattern is displayed.

Alphabet Characters

1 Press ,  or  to select a font.



2 Press , , , or  to change the selection screen, and then enter the characters that you want to sew.

- * To enter a space, press .
- * If you want to continue entering characters in a different font, press , and then repeat from step 1.



Memo

There are three fonts for alphabet character stitching.

■ Deleting Characters

1 Press **DELETE** to delete the last character.

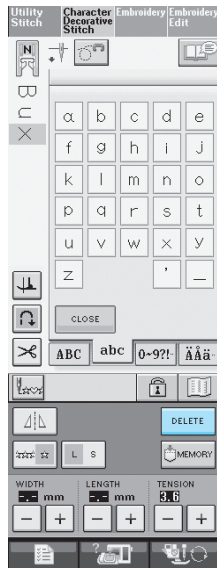

Memo

Characters are deleted individually starting with the last character entered.

2 Select the correct character.



■ Character Spacing Adjustment

1 Press **MEMORY** to display the setting screen.

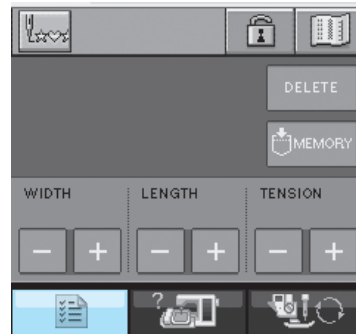

2 Press **- +** to adjust character spacing.

* Press **+** to increase and press **-** to decrease the character spacing.



4

Character/Decorative Stitches

The setting range is from “00” through “10”. The default setting is “00”.

Each setting equals a specific distance between characters.

Value	mm
00	0
01	0.18
02	0.36
03	0.54
04	0.72
05	0.9
06	1.08
07	1.26
08	1.44
09	1.62
10	1.8

Example:



Memo

Changing Character Spacing by this method, pertains to all characters. Spacing changes are valid not only while entering characters but also before and after the entering of characters.

SEWING STITCH PATTERNS

Sewing Attractive Finishes

To achieve attractive results when sewing character/decorative stitches, check the table below for the proper fabric/needle/thread combinations.



Note

- Other factors, such as fabric thickness, stabilizer material, etc., also have an effect on the stitch, so you should always sew a few trial stitches before beginning your project.
- When sewing satin stitch patterns, there may be shrinking or bunching of stitches, so be sure to attach a stabilizer material.
- Guide the fabric with your hand to keep the fabric feeding straight and even during sewing.

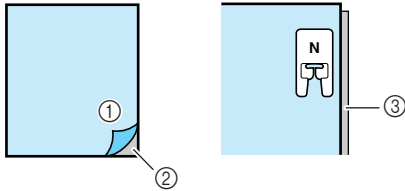
Fabric	When sewing on stretch fabrics, lightweight fabrics, or fabrics with coarse weaves, attach stabilizer on the wrong side of the fabric. If you do not wish to do so, place the fabric on a thin paper such as tracing paper.  ① Fabric ② Stabilizer ③ Thin paper
Thread	#50 - #60
Needle	With lightweight, regular, or stretch fabrics: the Ball point needle (golden colored) With heavyweight fabrics: home sewing machine needle 90/14
Presser foot	Monogramming foot "N". Using another presser foot may give inferior results.

Basic Sewing

- 1 Select a stitch pattern.
- 2 Attach monogramming foot "N".
- 3 Place the fabric under the presser foot, pull the upper thread out to the side, and then lower the presser foot.

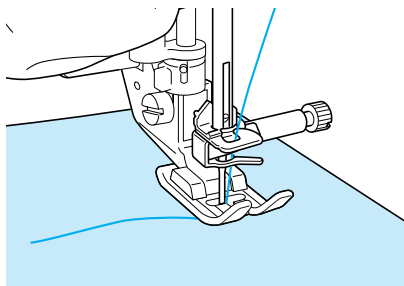

- 4 Press the "Start/Stop" button to start sewing.

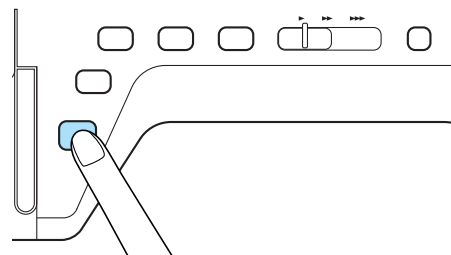

CAUTION

- When sewing 7 mm satin stitch patterns and the stitches are bunched, lengthen the stitch length. If you continue sewing when the stitches are bunched, the needle may bend or break (see "Setting the Stitch Length" on page 49).



Memo

If the fabric is pulled or pushed during sewing, the pattern may not turn out correctly. Also, depending on the pattern, there may be movement to the left and right as well as front and back. Guide the fabric with your hand to keep the fabric feeding straight and even during sewing.

5 Press the “Start/Stop” button to stop sewing.

6 Press the “Reverse/Reinforcement Stitch” button to sew reinforcement stitches.

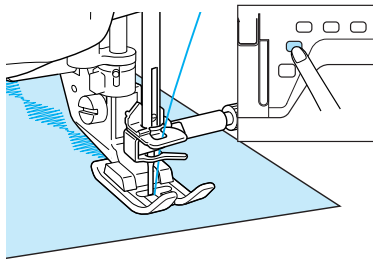

Memo

- When sewing character stitches, the machine automatically sews reinforcement stitches at the beginning and end of each character.

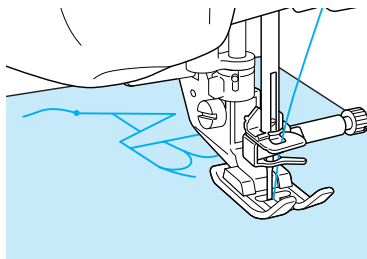

- When sewing is completed, trim any excess thread.

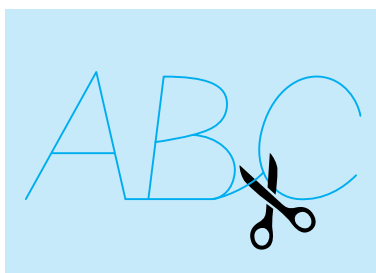



Note

- When sewing some patterns, the needle will stop in the raised position while the fabric is fed due to the operation of the needle bar separation mechanism which is used in this machine. At such times, a clicking sound different from the sound generated during sewing will be heard. This sound is normal and is not the sign of a malfunction.

Making Adjustments

Your stitch pattern may sometimes turn out poorly, depending on the type or thickness of fabric, the stabilizer material used, sewing speed, etc. If your sewing does not turn out well, sew trial stitches using the same conditions as the real sewing, and adjust the stitch pattern as explained below. If the pattern does not turn out well even after making

adjustments based on the  pattern, make adjustments for each pattern individually.

1 Press  and select  on P.10.



2 Attach monogramming foot “N” and sew the pattern.

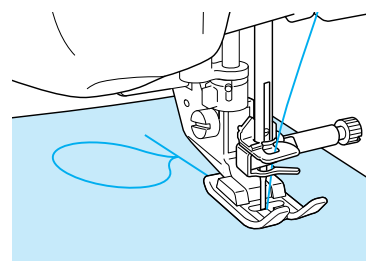

3 Compare the finished pattern to the illustration of the correct pattern below.

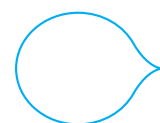

4

Character/Decorative Stitches

- 4** Press , and then adjust the pattern with the FINE ADJUST VERTI. or HORIZ. displays.

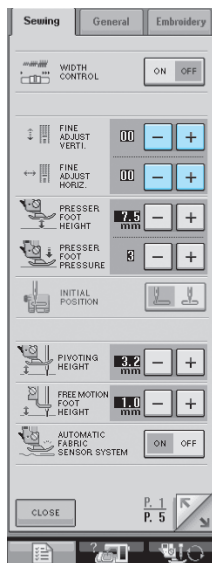

- * If the pattern is bunched:
Press  in the FINE ADJUST VERTI. display.
→ The displayed value increases each time the button is pressed and the pattern will lengthen.

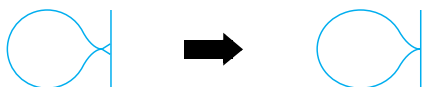

- * If the pattern has gaps:
Press  in the FINE ADJUST VERTI. display.
→ The displayed value decreases each time the button is pressed and the pattern will shorten.



- * If the pattern is skewed to the left:
Press  in the FINE ADJUST HORIZ. display.
→ The displayed value increases each time the button is pressed and the pattern will slide to the right.



- * If the pattern is skewed to the right:
Press  in the FINE ADJUST HORIZ. display.
→ The displayed value decreases each time the button is pressed and the pattern will slide to the left.



- 5** Sew the stitch pattern again.
- * If the stitch pattern still comes out poorly, make adjustments again. Adjust until the stitch pattern comes out correctly.



Memo

You can sew with the setting screen on the display.

- 6** Press  to return to the original screen.

EDITING STITCH PATTERNS

Key Functions

You can create just the finish you want using the editing functions. Make patterns larger or smaller, make mirror images, etc.



Note

- Some editing functions cannot be used with certain stitch patterns. Only the functions for the displayed keys are available when a pattern is selected.

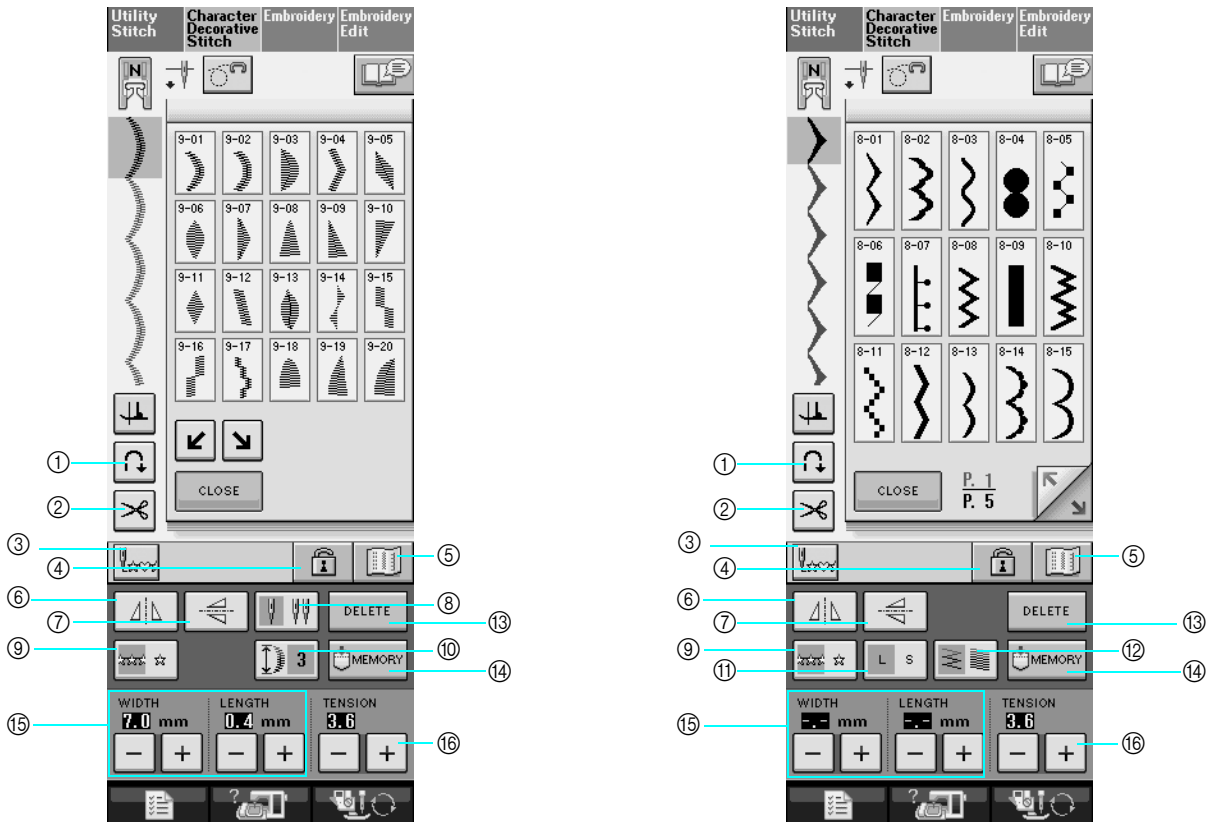

4

Character/Decorative Stitches

No.	Display	Key Name	Explanation	Page
①		Automatic reinforcement stitch key	Press this key to turn on the automatic reinforcement stitching mode.	51
②		Automatic thread cutting key	Press this key to turn on the automatic thread cutting mode.	52
③		Back to beginning key	When sewing is stopped, press this key to return to the beginning of the pattern.	126
④		Screen lock key	Press this key to lock the screen. When the screen is locked, the various settings, such as the stitch width and stitch length, are locked and cannot be changed. Press this key again to unlock the settings.	55
⑤		Image key	Press this key to check large combination patterns.	127
⑥		Horizontal mirror image key	After selecting the stitch pattern, use this key to create a horizontal mirror image of the stitch pattern.	125
⑦		Vertical mirror image key	After selecting the stitch pattern, use this key to create a vertical mirror image of the stitch pattern.	125
⑧		Needle mode selection key (Single/Double)	Press this key to choose single needle sewing or twin needle sewing.	34

No.	Display	Key Name	Explanation	Page
⑨		Single/Repeat sewing key	Press this key to choose single stitches or continuous stitches.	125
⑩		Elongation key	When 7mm satin stitch patterns are selected, press this key to choose from 5 automatic length settings, without changing the stitch zigzag width or stitch length settings.	125
⑪		Size selection key	Use this key to select the size of the stitch pattern (large, small).	124
⑫		Thread density key	After selecting the stitch pattern, use this key to change the thread density of the pattern.	126
⑬		Delete key	When you make a mistake selecting a stitch pattern, use this key to delete the mistake. When you make a mistake in combining stitch patterns, use this key to delete stitch patterns.	118, 119
⑭		Memory key	Use this key to save stitch pattern combinations.	136-137
⑮		Stitch width and stitch length key	Shows the stitch width and stitch length of the selected stitch pattern. The machine has default settings.	49-50
⑯		Thread tension key	Shows the thread tension setting for the selected stitch pattern. The machine has default settings.	50

Changing the Size

Select a stitch pattern, then press to change the size of the stitch pattern. The stitch pattern will be sewn in the size highlighted on the key.



Memo

- If you continue entering stitch patterns after changing the size, those patterns will also be sewn in that size.
- You cannot change the size of combined stitch patterns once the stitch pattern is entered.

Actual Stitch Pattern Size

L



S



L



S



Changing the Length (for 7mm Satin Stitch Patterns Only)

When stitch patterns are selected, press  3 to choose from 5 automatic length settings, without changing the stitch zigzag width or stitch length settings.

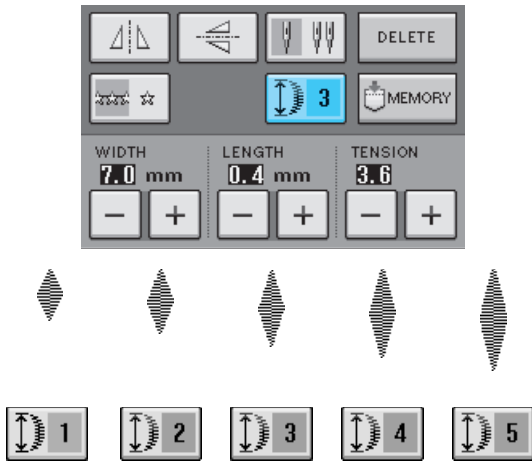

Creating a Vertical Mirror Image

To create a vertical mirror image, select a stitch pattern then press .

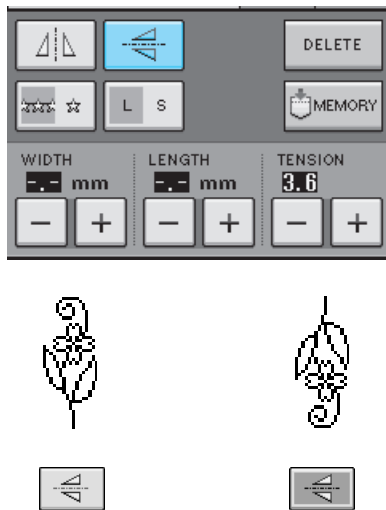

Creating a Horizontal Mirror Image

To create a horizontal mirror image, select a stitch pattern then press .

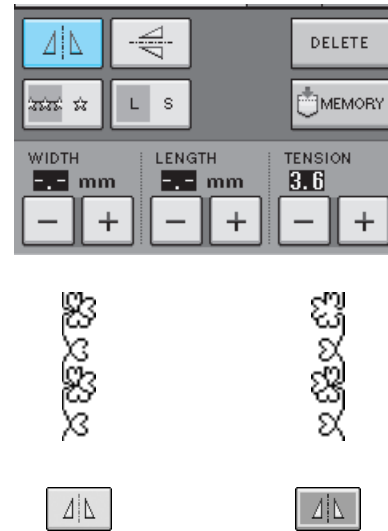

Sewing a Pattern Continuously

Press  to select continuous sewing or single stitch sewing.

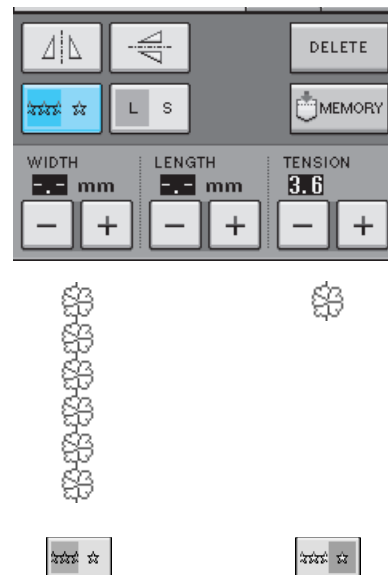

Memo

To finish a complete motif while sewing the pattern continuously, you can press the  key while sewing. The machine will automatically stop when the motif is finished.





4

Changing Thread Density (for Satin Stitch Patterns Only)

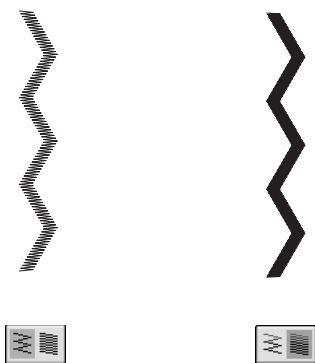
After selecting the pattern, press  to select your preferred thread density.



CAUTION

If the stitches bunch when thread density is changed to , return the thread density to . If you continue sewing when the stitches are bunched, the needle may bend or break.

Memo

- Even if you select a new pattern after changing the thread density, the thread density remains the same until you change it.
- You cannot change thread density for a combined pattern after the combination is finished.

Returning to the Beginning of the Pattern

When sewing character/decorative stitches, you can return to the beginning of the pattern after trial sewing or when the stitching is sewn incorrectly.

- 1 Press the “Start/Stop” button to stop the machine, and then press .



→ Sewing returns to the beginning of the selected pattern (“W”) from the point where sewing was stopped.

Memo

If this key is pressed when sewing is stopped, patterns can be added at the end of a combined stitch pattern. (In this example, “!” is added.)

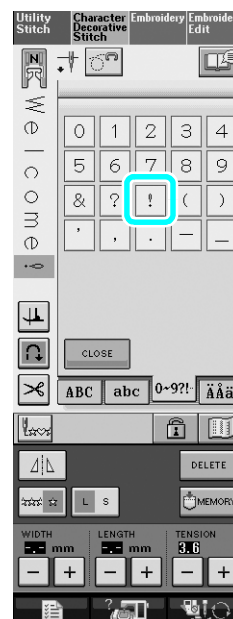

- Press the "Start/Stop" button to continue sewing.

Checking the Image

You can display an approximate size image of the selected stitch pattern. You can also check and change the colors of the image on the screen.

- Press .

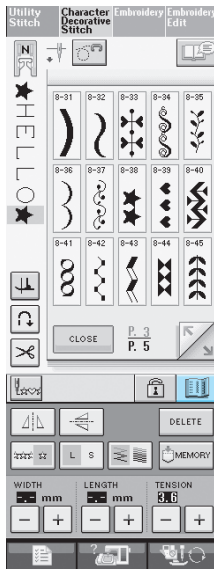

→ An image of the selected pattern is displayed.

- Press  to change the thread color in the image.

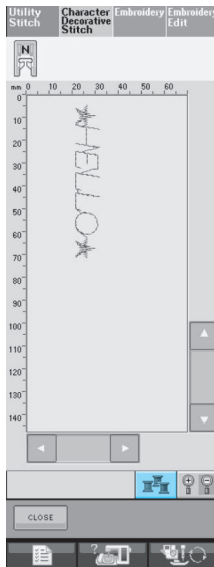

→ The color changes every time you press the button.

- Press  to display the enlarged image.

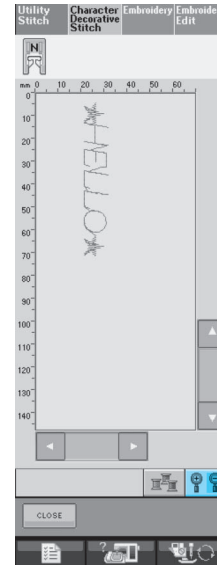

- Use  to view any part of the image that extends out of the viewable display area.

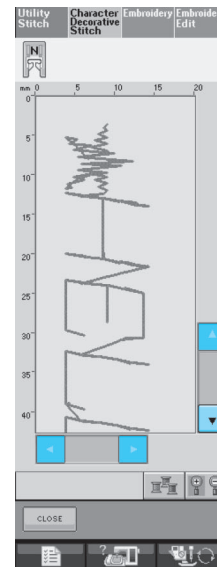

- Press  to return to the original screen.



Memo

- You can also sew from this screen when the presser foot symbol is displayed.
- Image of some patterns will display in default size only.



4

Character/Decorative Stitches

COMBINING STITCH PATTERNS

You can combine many varieties of stitch patterns, such as character stitches, cross stitches, satin stitches, or stitches you design with MY CUSTOM STITCH function (see chapter 7 for information about MY CUSTOM STITCH). You can also combine stitch patterns of different sizes, mirror image stitch patterns, and others.

Before Combining

Single stitch sewing is automatically selected for sewing combined patterns. If you want to sew the pattern continuously, press  after finishing the stitch pattern combination.

When changing sizes, creating mirror images, or making other adjustments to a combined stitch pattern, be sure to edit the selected stitch pattern before selecting the next one. You cannot edit a stitch pattern once the next stitch pattern is selected.

Combining Various Stitch Patterns

Example:



1 Press .



2 Select .

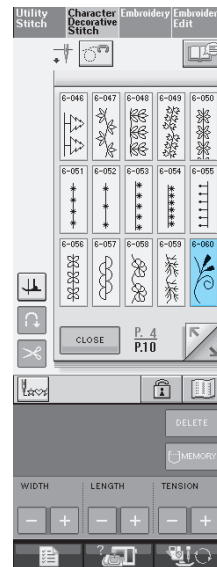

3 Press  .

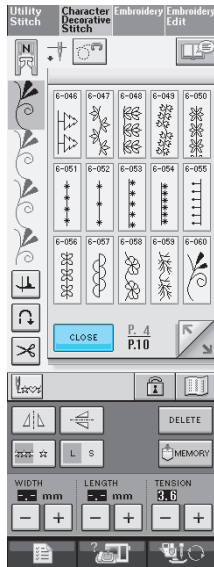



→ The display returns to the stitch selection screen.

4 Press  .

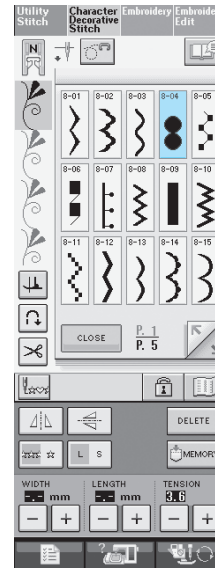

5 Select  .



6 Press  to sew the pattern continuously.

* Press  to view the completed pattern (see page 127).

7 Press  .

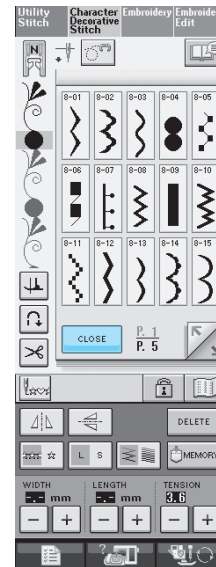

Memo

Patterns are deleted individually starting with the last pattern entered by pressing  .



4

Character/Decorative Stitches

Combining Large and Small Stitch Patterns

Example:



→ The large size stitch will be selected.

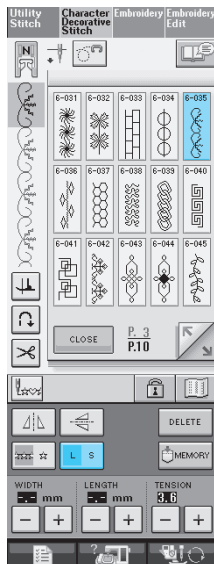
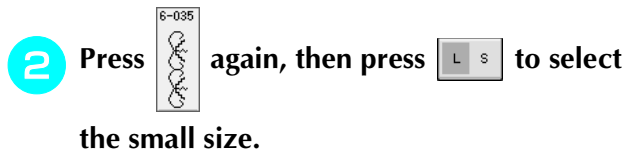

→ The pattern is displayed in a smaller size.

3 Press  to sew continuously.

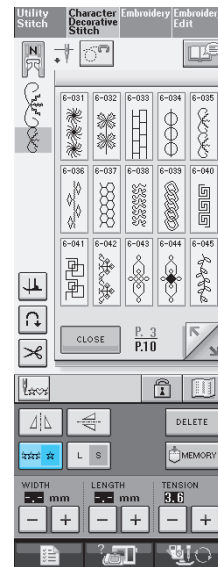



→ The entered pattern is repeated.

Combining Horizontal Mirror Image Stitch Patterns

Example:



1 Press .

2 Press  again, then press .

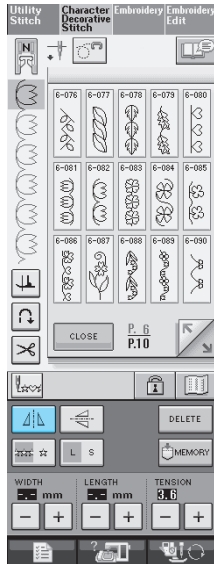

→ The pattern is flipped along a vertical axis.

3 Press .

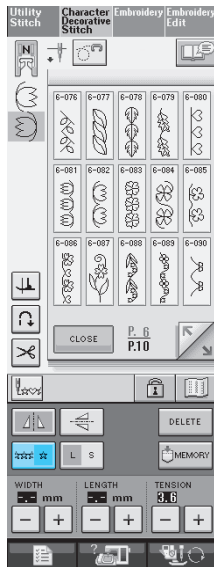

→ The entered pattern is repeated.



Combining Stitch Patterns of Different Length

Example:



1 Press , then press  3 once.

→ The length of the image is set to  4.

2 Select  again, then press  4 3 times.

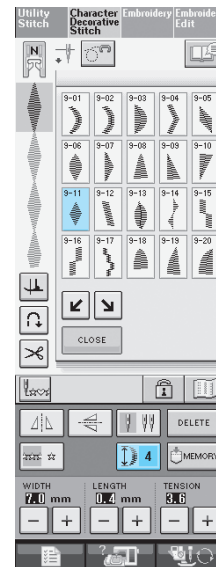

→ The length of the image is set to  2.



4

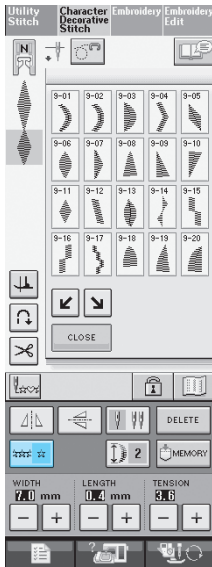

Character/Decorative Stitches

3 Press .





→ The entered pattern is repeated.

Making Step Stitch Patterns (for 7mm Satin Stitch Patterns Only)

You can use the   keys with 7mm satin stitch patterns to create a step effect.

Stitch patterns sewn so that they create a step effect are called step stitch patterns.

- * Press  to move the stitch pattern a distance equal to half of the stitch pattern's size to the left.
- * Press  to move the stitch pattern a distance equal to half of the stitch pattern's size to the right.

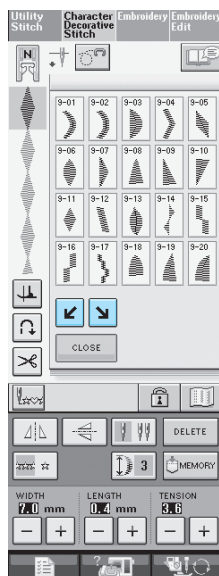

Example:



1 Press .

2 Press .



→ The next stitch pattern will move to the right.

3 Press  again.

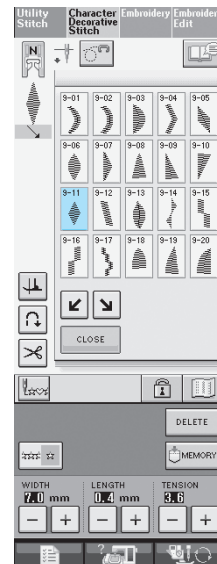

4 Press .



→ The next stitch pattern will move to the left.

5 Press .

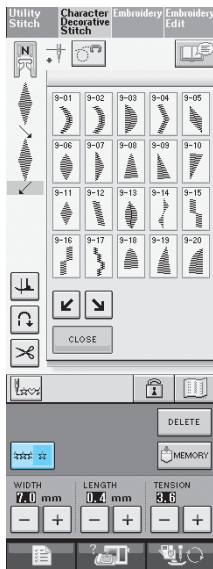

→ The entered pattern is repeated.

More Examples

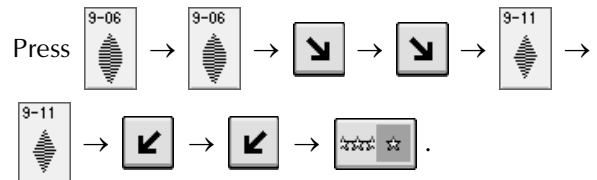
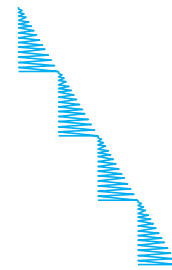
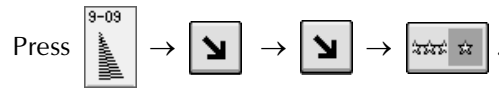
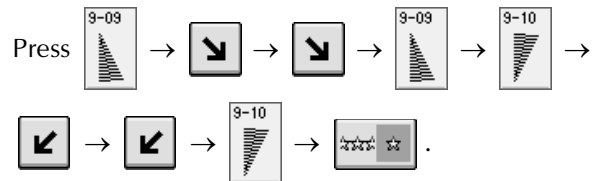
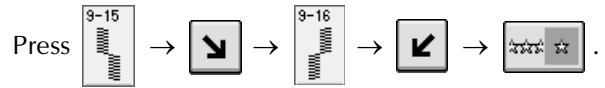

4

Character/Decorative Stitches

USING THE MEMORY FUNCTION

Stitch Data Precautions

Observe the following precautions when using stitch data other than that created and saved in this machine.

■ Types of Stitch Data that can be Used

- In the Character/Decorative Stitch memory, only .pmu stitch data files can be used with this machine. Using data other than that created using this machine may cause the machine to malfunction.

■ Types of USB Devices/Media that can be Used

Stitch data can be saved to or recalled from USB media. Use media that meets the following specifications.

- USB Floppy disk drive
- USB Flash drive (USB Flash memory)

Stitch data can be recalled only.

- USB CD-ROM, CD-R, CD-RW drives

You can also use the following types of USB media with the USB Memory Card Reader/Writer.

- Secure Digital (SD) Card
- CompactFlash
- Memory Stick
- Smart Media
- Multi Media Card (MMC)
- XD-Picture Card



Note

- Some USB media may not be usable with this machine. Please visit our website for more details.
- The access lamp will begin blinking after inserting USB Devices/Media, and it will take about 5 to 6 seconds to recognize the Devices/Media. (Time will differ depending on the USB Device/Media).

- When a file folder is necessary to create, use a computer.

■ Computers and Operating Systems with the Following Specifications can be Used

- Compatible models:
IBM PC with a USB port as standard equipment
IBM PC-compatible computer equipped with a USB port as standard equipment
- Compatible operating systems:
Microsoft Windows 98SE/Me/2000/XP/Windows Vista/7
(Windows 98SE requires a driver. Download the driver from our Web site (www.brother.com). In addition, only Windows 98 Second Edition can use the driver.)

■ Precautions on Using the Computer to Create and Save Data

- If the name of the stitch data file/folder cannot be identified, for example, because the name contains special characters, the file/folder is not displayed. If this occurs, change the name of the file/folder. We recommend using the 26 letters of the alphabet (uppercase and lowercase), the numbers 0 through 9, "-", and "_".
- Stitch data in a folder created in USB media can be retrieved.
- Do not create folders in "Removable Disk" on a computer. If stitch data is stored in a folder in "Removable Disk", that stitch data cannot be retrieved by the machine.

■ Trademarks

- Secure Digital (SD) Card is a registered trademark or a trademark of SD Card Association.
- CompactFlash is a registered trademark or a trademark of Sandisk Corporation.
- Memory Stick is a registered trademark or a trademark of Sony Corporation.
- Smart Media is a registered trademark or a trademark of Toshiba Corporation.
- Multi Media Card (MMC) is a registered trademark or a trademark of Infineon Technologies AG.
- xD-Picture Card is a registered trademark or a trademark of Fuji Photo Film Co. Ltd.
- IBM is a registered trademark or a trademark of International Business Machines Corporation.
- Microsoft and Windows are registered trademarks or trademarks of Microsoft Corporation.

Each company whose software title is mentioned in this manual has a Software License Agreement specific to its proprietary programs.

All other brands and product names mentioned in this manual are registered trademarks of their respective companies. However, the explanations for markings such as ® and ™ are not clearly described within the text.



4

Character/Decorative Stitches

Saving Stitch Patterns in the Machine's Memory

You can save often-used stitch patterns in the machine's memory. The machine's memory can hold up to 20 stitch patterns.



Note

- Do not turn the main power to OFF while the "Saving" screen is displayed. You will lose the stitch pattern you are saving.



Memo

- It takes a few seconds to save a stitch pattern.
- See page 140 for information on retrieving a saved stitch pattern.

1 Press .



2 Press .

- Press  to return to the original screen without saving.

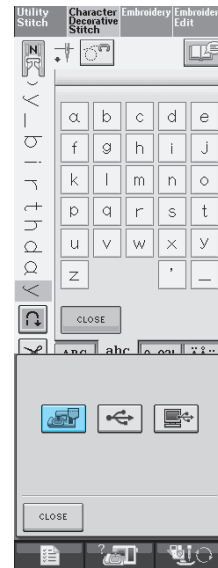

→ The "Saving" screen is displayed. When the pattern is saved, the display returns to the original screen automatically.

■ If the Memory is Full

If this screen appears while you are trying to save a pattern on the machine's memory, the memory is too full to hold the currently selected stitch pattern. To save the stitch pattern in the machine's memory, you have to delete a previously saved stitch pattern.

1 Press .

- Press  to return to the original screen without saving.

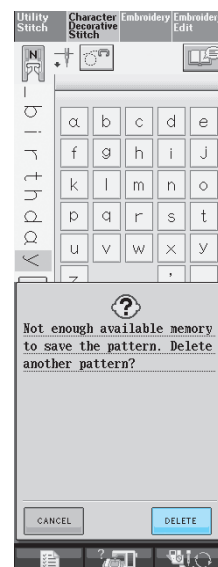

2 Choose a stitch pattern to delete.

- * Press  so the pattern saved in that pocket appears.
- * Press **CLOSE** if you decide not to delete the stitch pattern.

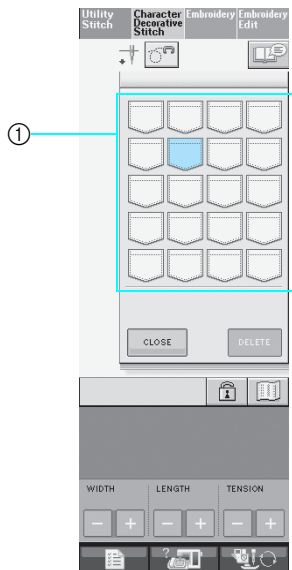

① Pockets holding saved stitch patterns

3 Press **DELETE.**

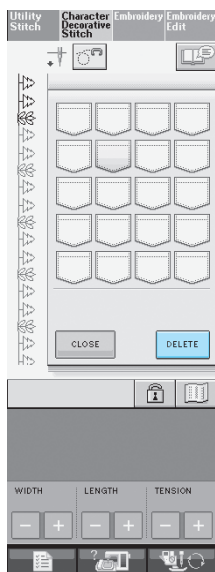

→ A confirmation message appears.

4 Press **OK.**

- * If you decide not to delete the stitch pattern, press **CANCEL**.

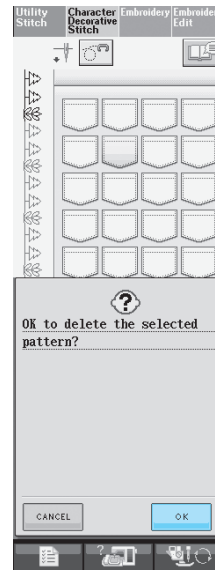

→ The machine deletes the stitch pattern, then automatically saves the new stitch pattern.



4

Character/Decorative Stitches

Saving Stitch Patterns to USB Media (Commercially Available)

When sending stitch patterns from the machine to USB media, plug the USB media into the machine's USB port. Depending on the type of USB media being used, either directly plug the USB device into the machine's USB port or plug the USB Card Writer/Reader into the machine's USB port.



Memo

Some USB media may not be usable with this machine. Please visit our web site for more details.

1

Press .



2

Insert the USB media into the USB port connector on the machine.

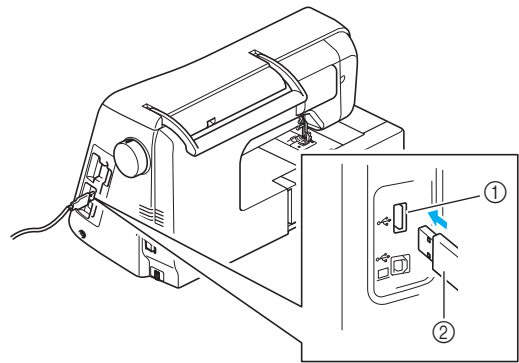

- ① USB port connector for media
- ② USB media



Memo

- The USB media can be inserted or removed at any time.
- Do not insert anything other than USB media into the USB media port connector. Otherwise, the USB media drive may be damaged.

3

Press .

- * Press to return to the original screen without saving.

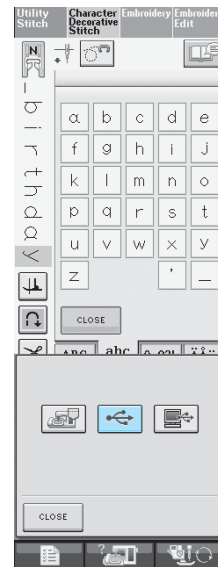

→ The "Saving" screen is displayed. When the pattern is saved, the display returns to the original screen automatically.

Saving Stitch Patterns in the Computer

Using the included USB cable, the sewing machine can be connected to your computer, and the stitch patterns can be temporarily retrieved from and saved on your computer.



Note

- Do not turn the main power to OFF while the "Saving" screen is displayed. You will lose the stitch pattern you are saving.

1 Plug the USB cable connector into the corresponding USB port connectors for the computer and for the machine.

- * The USB cable can be plugged into the USB port connectors on the computer and machine whether or not they are turned on.

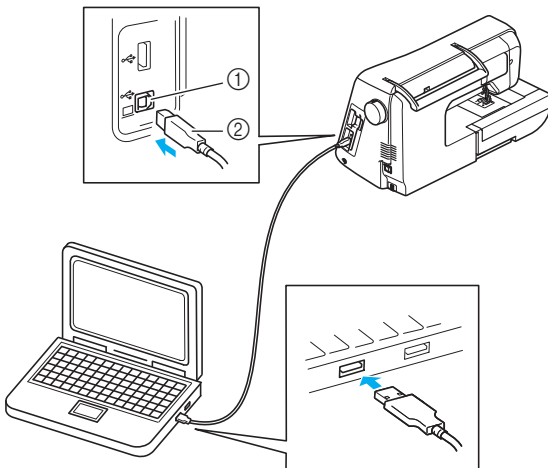

- ① USB port connector for computer
- ② USB cable connector

→ The "Removable Disk" icon will appear in "My Computer" on the computer.



Note

- The connectors on the USB cable can only be inserted into a connector in one direction. If it is difficult to insert the connector, do not insert it with force and check the orientation of the connector.
- For details on the position of the USB port on the computer, refer to the instruction manual for the corresponding equipment.

2 Press .



3 Press .

- * Press  to return to the original screen without saving.

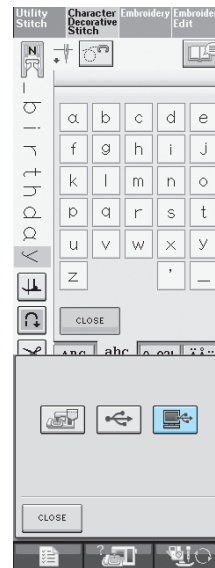

- The stitch pattern will be temporarily saved to "Removable Disk" under "My Computer".



4

Character/Decorative Stitches

4 Select the stitch pattern's .pmu file and copy the file to the computer.

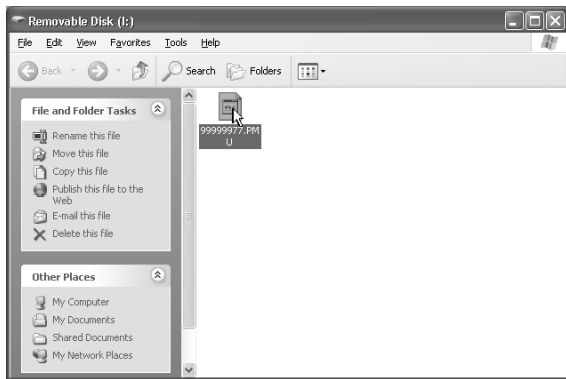

Note

- Do not turn off the machine while the "Saving" screen is showing. You may lose the data.

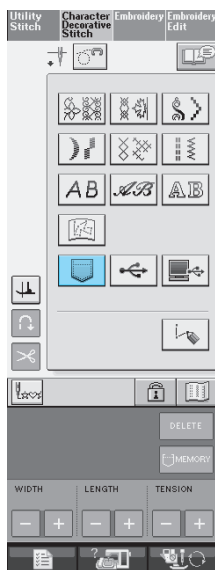

Retrieving Stitch Patterns from the Machine's Memory

1 Press  .



→ The pocket selection screen appears.

2 Choose a stitch pattern to retrieve.

- * Press  so the pattern saved in that pocket appears. If the entire saved stitch pattern is not displayed, press  to view the entire stitch pattern.
- * Press  to return to the original screen without saving.

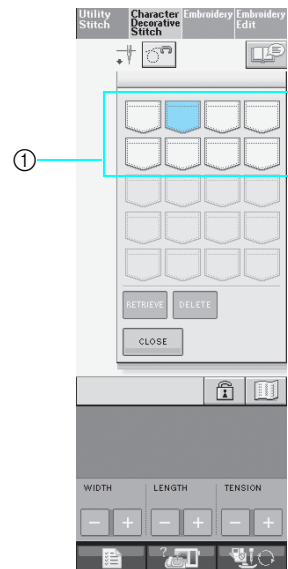

① Pockets holding saved stitch patterns

3 Press  .

- * Press  to delete the stitch pattern.

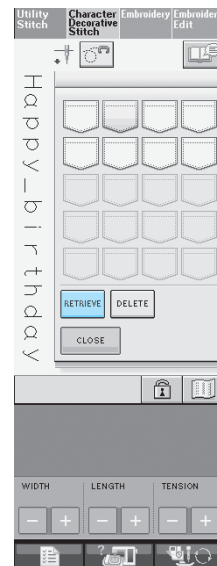

→ The selected stitch pattern is retrieved and the sewing screen will be displayed.

Recalling from USB Media

You can recall a specific stitch pattern from either direct USB media or a folder in the USB media. If the stitch pattern is in a folder, check each folder to find the stitch pattern.

1 Insert the USB Media into the USB port connector on the machine (see page 138).

2 Press .

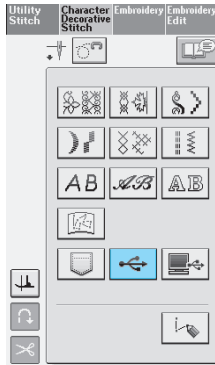

→ Stitch patterns and a folder in a top folder are displayed.

3 Press  when there is a subfolder to sort two or more stitch patterns to USB media, the stitch pattern in the subfolder is displayed.

* Press  to return to the original screen without recalling.

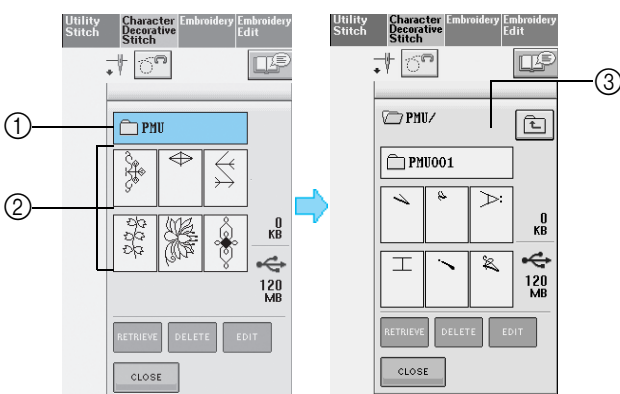

- ① Folder name
- ② Stitch patterns in a folder show only the first pattern of any combined patterns.
- ③ Path

→ The path shows the current folder at the top of the list.
Stitch patterns and a subfolder within a folder are displayed.

* Press  to return to the previous folder.

4 Press the key of the stitch pattern you want to recall.

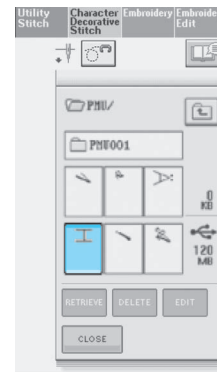

5 Press .

* Press  to delete the stitch pattern. The pattern will be deleted from the USB media.



→ The selected stitch pattern is recalled and the sewing screen will be displayed.



4

Character/Decorative Stitches

Recalling from the Computer

- 1 Plug the USB cable connector into the corresponding USB connectors for the computer and for the machine (see page 139).
- 2 On the computer, open “My Computer” then go to “Removable Disk”.

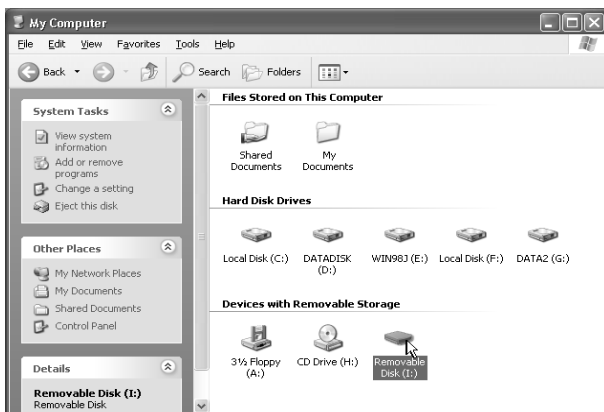

- 3 Move/copy the pattern data to “Removable Disk”.

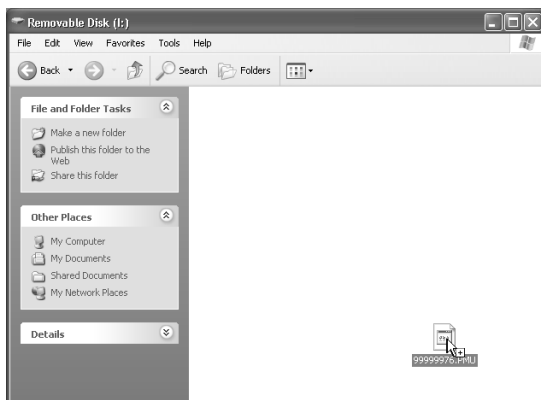

→ Stitch pattern data in “Removable Disk” is written to the machine.

Note

- While data is being written, do not disconnect the USB cable.
- Do not create folders within “Removable Disk”. Since folders are not displayed, stitch pattern data within folders cannot be recalled.

- 4 Press .

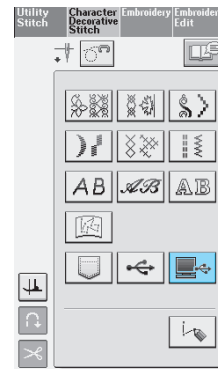

→ The stitch patterns in the computer are displayed on the selection screen.

- 5 Press the key of the stitch pattern you want to recall.

* Press to return to the original screen without recalling.

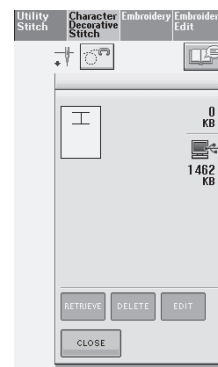

- 6 Press .

* Press to delete the stitch pattern.

The pattern will be deleted from the “Removable Disk” folder in your computer.

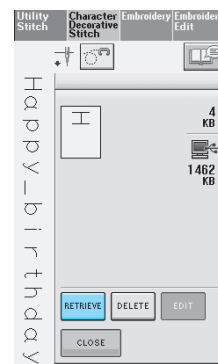

→ The selected stitch pattern is recalled and the sewing screen will be displayed.

Note

- The pattern recalled from the computer is only temporarily written to the machine. It is erased from the machine when the machine is turned off. If you wish to keep the stitch pattern, store it in the machine (see “Saving Stitch Patterns in the Machine’s Memory” on page 136).

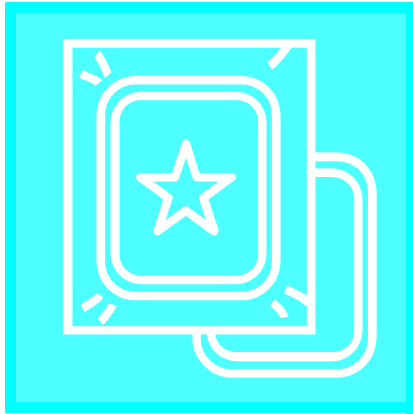

Chapter 5

Embroidery

BEFORE EMBROIDERING 144

Embroidery Step by Step.....	144
Attaching Embroidery Foot "W".....	145
Attaching the Embroidery Unit.....	146
■ About the Embroidery Unit.....	146
■ Removing the Embroidery Unit.....	147

SELECTING PATTERNS 149

■ Copyright Information.....	149
■ Pattern Selection Screens.....	150
Selecting Embroidery Patterns/Heirloom Patterns/Border Patterns/Cross stitch Patterns/Floral alphabet Patterns ..	151
Selecting Alphabet Character Patterns.....	152
Selecting Frame Patterns.....	153
Selecting Patterns from Embroidery Cards.....	154
■ About Embroidery Cards (Sold Separately).....	154
Selecting Patterns from USB media/Computer	154

VIEWING THE SEWING SCREEN 155

■ Key Functions.....	156
----------------------	-----

PREPARING THE FABRIC 157

Attaching Iron-on Stabilizers (backing) to the Fabric.....	157
Hoooping the Fabric in the Embroidery Frame.....	158
■ Types of Embroidery Frames.....	158
■ Inserting the Fabric.....	159
■ Using the Embroidery Sheet.....	160
Embroidering Small Fabrics or Fabric Edges.....	160
■ Embroidering Small Fabrics.....	160
■ Embroidering Edges or Corners.....	160
■ Embroidering Ribbons or Tape.....	161

ATTACHING THE EMBROIDERY FRAME..... 162

■ Removing the Embroidery Frame.....	162
--------------------------------------	-----

CONFIRMING THE PATTERN POSITION 163

Checking the Pattern Position.....	163
Previewing the Completed Pattern	164

SEWING AN EMBROIDERY PATTERN 165

Sewing Attractive Finishes.....	165
■ Embroidery Needle Plate Cover.....	165
Sewing Embroidery Patterns.....	166
■ When Threading Manually.....	167
Sewing Embroidery Patterns Which Use Appliqué.....	168

ADJUSTMENTS DURING THE EMBROIDERY PROCESS..... 170

If the Bobbin Runs Out of Thread.....	170
If the Thread Breaks During Sewing.....	171
Restarting from the Beginning.....	172
Resuming Embroidery After Turning Off the Power.....	172

MAKING EMBROIDERY ADJUSTMENTS..... 174

Adjusting Thread Tension.....	174
■ Correct Thread Tension.....	174
■ Upper Thread is Too Tight.....	174
■ Upper Thread is Too Loose.....	174
Using the Automatic Thread Cutting Function (END COLOR TRIM)	175
Using the Thread Trimming Function (JUMP STITCH TRIM)	175
■ Selecting the length of JUMP STITCH not to trim.....	176
Adjusting the Embroidery Speed.....	176
Changing the Thread Color Display.....	177
Changing the Embroidery Frame Display.....	178

REVISING THE PATTERN..... 179

Changing the Pattern Position.....	179
Aligning the Pattern and the Needle.....	180
Changing the Size.....	181
Rotating the Pattern.....	182
Creating a Horizontal Mirror Image.....	183
Changing the Density (Alphabet Character and Frame Patterns Only)	183
Changing the Colors of Alphabet Character Patterns	184

USING THE MEMORY FUNCTION 185

Embroidery Data Precautions.....	185
■ Types of Embroidery Data that can be Used.....	185
■ Types of USB Devices/Media that can be Used.....	185
■ Computers and Operating Systems with the Following Specifications can be Used.....	186
■ Precautions on Using the Computer to Create and Save Data.....	186
■ Tajima (.dst) Embroidery Data.....	186
■ Trademarks.....	186
Saving Embroidery Patterns in the Machine's Memory.....	187
■ If the Memory is Full.....	187
Saving Embroidery Patterns to USB Media (Commercially Available)	189
Saving Embroidery Patterns in the Computer.....	190
Retrieving Patterns from the Machine's Memory.....	191
Recalling from USB Media.....	191
Recalling from the Computer.....	192

EMBROIDERY APPLICATIONS 194

Using a Frame Pattern to Make an Appliqué (1).....	194
Using a Frame Pattern to Make an Appliqué (2).....	195

BEFORE EMBROIDERING

Embroidery Step by Step

Follow the steps below to prepare the machine for embroidery.

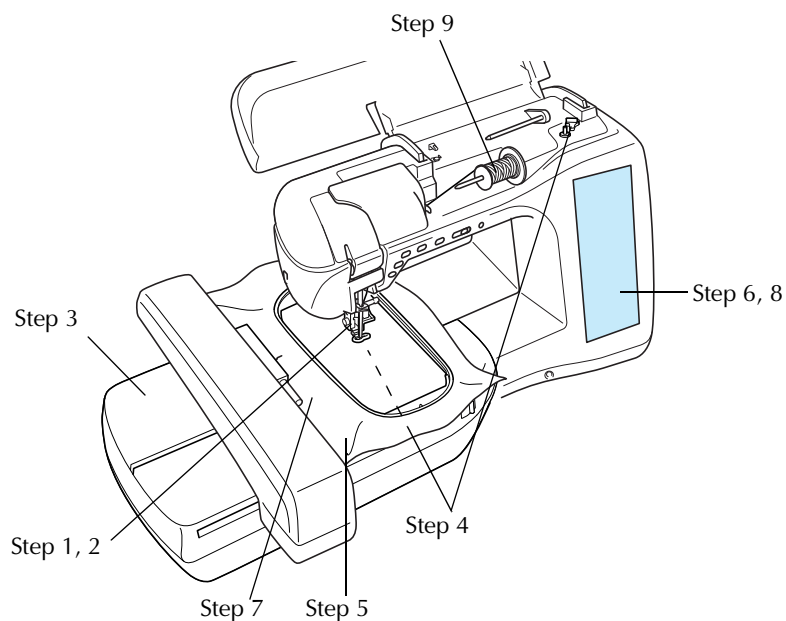

Step #	Aim	Action	Page
1	Presser foot attachment	Attach embroidery foot "W".	145
2	Checking the needle	Use needle 75/11 for embroidery. *	41
3	Embroidery unit attachment	Attach the embroidery unit.	146
4	Bobbin thread setup	For the bobbin thread, wind embroidery bobbin thread and set it in place.	23
5	Fabric preparation	Attach a stabilizer material to the fabric, and hoop it in the embroidery frame.	157
6	Pattern selection	Turn the main power to ON, and select an embroidery pattern.	149
7	Embroidery frame attachment	Attach the embroidery frame to the embroidery unit.	162
8	Checking the layout	Check and adjust the size and position of the embroidery.	163
9	Embroidery thread setup	Set up embroidery thread according to the pattern.	29

* It is recommended that a 90/14 needle should be used when embroidering on heavy weight fabrics or stabilizing products (for example; denim, puffy foam, etc.).

Attaching Embroidery Foot “W”

⚠ CAUTION

- When attaching a presser foot, always press  on the screen. You may accidentally press the “Start/Stop” button and possibly cause injury.
- Be sure to use embroidery foot “W” when doing embroidery. Using another presser foot may cause the needle to strike the presser foot, causing the needle to bend or break and possibly cause injury.

- 1** Press the “Needle Position” button to raise the needle.

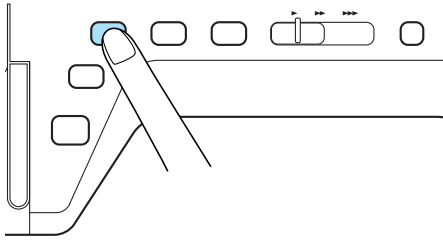

- 2** Press .

→ The entire screen becomes white, and all keys and operation buttons are locked.

- 3** Raise the presser foot lever.

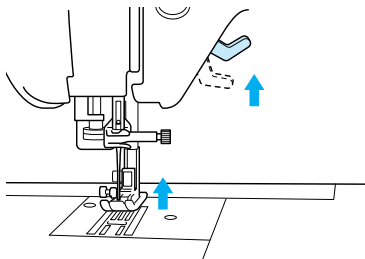

- 4** Push the black button on the presser foot holder and remove the presser foot.

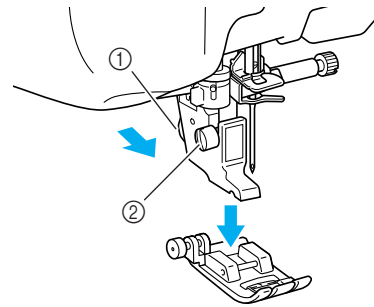

- ① Black button
② Presser foot holder

→ Remove the presser foot from the presser foot holder.

- 5** Use the included screwdriver to loosen the screw of the presser foot holder, then remove the presser foot holder.

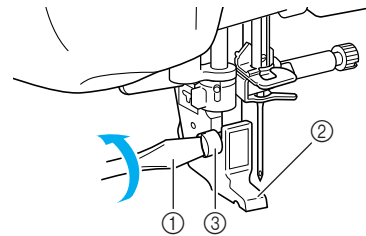

- ① Screwdriver
② Presser foot holder
③ Presser foot holder screw

→ Remove the presser foot holder.

- 6** Position embroidery foot “W” on the presser foot bar so that the arm of embroidery foot “W” is behind the needle holder and the wiper is behind the needle.

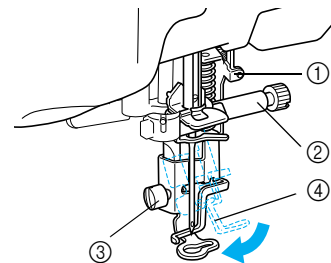

- ① Arm
② Needle holder
③ Presser foot holder screw
④ Wiper

- 7** Hold the embroidery foot in place with your right hand, and then use the included screwdriver to securely tighten the presser foot holder screw.

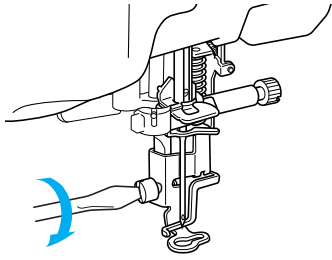

! CAUTION

- Use the included screwdriver to firmly tighten the screw of the presser foot holder. If the screw is loose, the needle may strike the presser foot and possibly cause injury.

- 8** Press  to unlock all keys and buttons.

→ All keys and operation buttons are unlocked, and the previous screen is displayed.

Attaching the Embroidery Unit

About the Embroidery Unit

! CAUTION

- Do not move the machine with the embroidery unit attached. The embroidery unit could fall off and cause injury.
- Keep your hands and foreign objects away from the embroidery carriage and frame when the machine is embroidering. Otherwise, injury may result.
- If the embroidery unit could not be initialized correctly, a buzzer will sound. If this happens, go through the initialization process again. This is not a malfunction.

Note

- You can also sew utility/decorative stitches with the embroidery unit attached. Set the feed dog position switch on the embroidery unit to the appropriate setting.
- Be sure to turn off the power before installing the embroidery unit. Otherwise, the machine may be damaged.
- Do not touch the inner connector of the embroidery unit. The pins on the embroidery unit connection may be damaged.
- Do not apply strong force to the embroidery unit carriage or pick up the unit by the carriage. Otherwise, the embroidery unit may be damaged.
- Store the embroidery unit in the proper storage case.

- 1** Turn the main power to OFF, and remove the flat bed attachment.

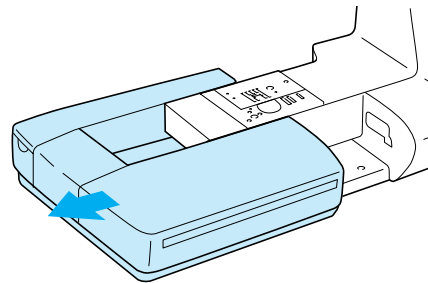

- 2** Open the cover of the connection port.

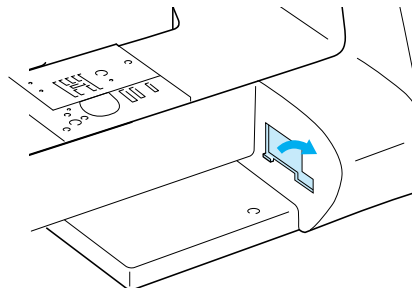

! CAUTION

- Be sure to replace the cover when the embroidery unit is not installed.

- 3** Insert the embroidery unit connection into the machine connection port. Push lightly until the unit clicks into place.

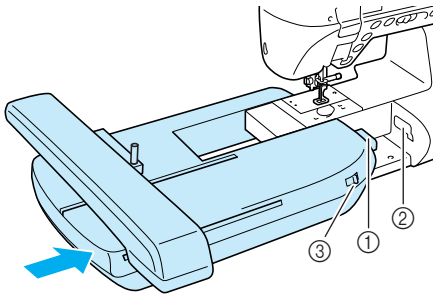

- ① Embroidery unit connection
- ② Machine connection port
- ③ Feed dog position switch

**Note**

- Be sure there is no gap between the embroidery unit and the sewing machine. If there is a gap, the embroidery patterns will not embroider with the correct registration.
- Do not push on the carriage when installing the embroidery unit onto the machine. Moving the carriage may damage the embroidery unit.
- Be sure to set the feed dog position switch to right to lower the feed dogs.

- 4** Turn the main power to ON.

→ The following message will appear.

- 5** Press .

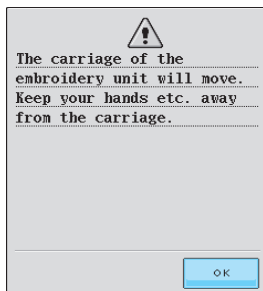

→ The carriage will move to the initialization position.

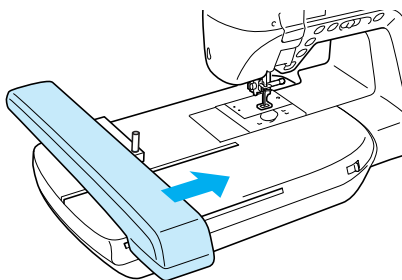
**Note**

- A confirmation message to lower the frame-securing lever after the carriage moves to its initial position.

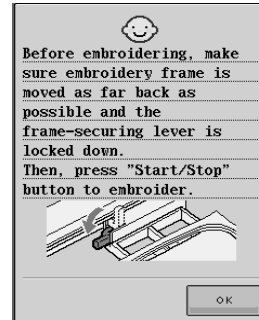

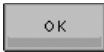
- The message will disappear after 15 seconds or press  to move to the next step.

■ Removing the Embroidery Unit

- 1** Press either  or , then press



→ The carriage will move to the removal position.

⚠ CAUTION

- Always remove the embroidery frame before pressing . Otherwise, the frame may strike the embroidery foot, and possibly cause injury.
- The embroidery unit will not fit in the storage case if this step is not done.

- 2** Turn the main power to OFF.

**Note**

- Be sure to turn off the machine before attaching the embroidery unit, otherwise damage to the machine may result.



5

Embroidery

- 3** Hold down the release button, and pull the embroidery unit away from the machine.

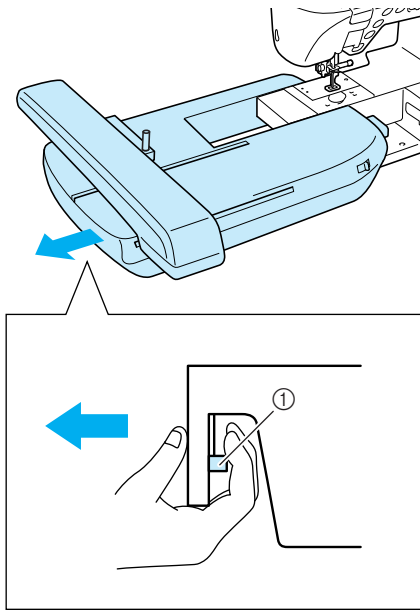

① Release button

! CAUTION

- Do not carry the embroidery unit by holding the release button compartment.

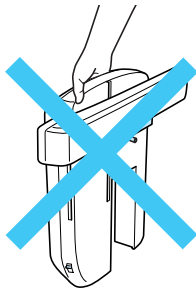

- Be sure to close the cover of the connection port when the embroidery unit is not being used.

SELECTING PATTERNS

■ Copyright Information

The patterns stored in the sewing machine and embroidery cards are intended for private use only. Any public or commercial use of copyrighted patterns is an infringement of copyright law and is strictly prohibited.

There are many character and decorative embroidery patterns stored in the machine's memory (see the "QUICK REFERENCE GUIDE" for a full summary of patterns in the machine's memory). You can also use patterns from the embroidery cards (sold separately).

Once the machine has finished the initialization and the carriage has moved to the start position, the pattern type selection screen will display.

If another screen is displayed, press **Embroidery** to display the screen below.

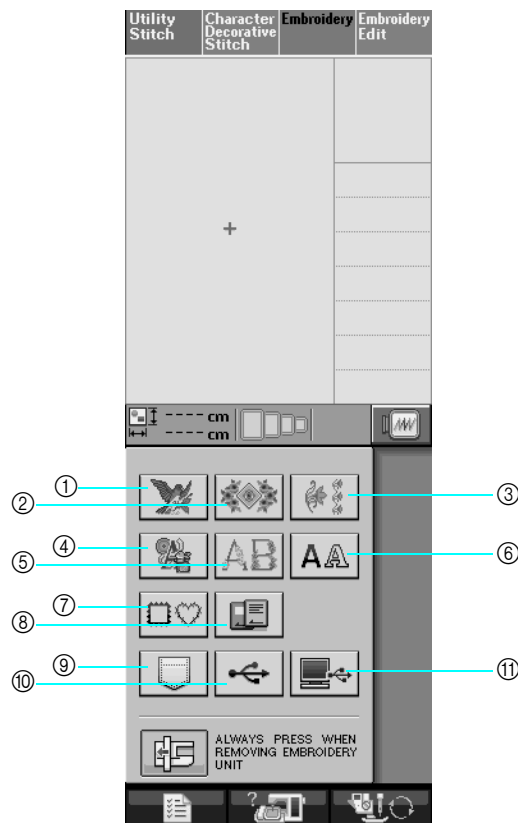

- ① Embroidery patterns
- ② Heirloom patterns
- ③ Border patterns
- ④ Cross stitch patterns
- ⑤ Floral alphabet patterns
- ⑥ Alphabet character patterns
- ⑦ Frame patterns
- ⑧ Patterns from an embroidery card (sold separately)
- ⑨ Patterns saved in the machine's memory (see page 191)
- ⑩ Patterns saved in USB media (see page 191)
- ⑪ Patterns saved on the computer (see page 192)



5

Embroidery

■ Pattern Selection Screens

There are 7 categories of patterns in this machine.  indicates that there is more than one pattern selection screen for that category.



Embroidery patterns

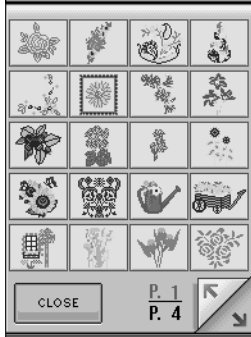

Heirloom patterns

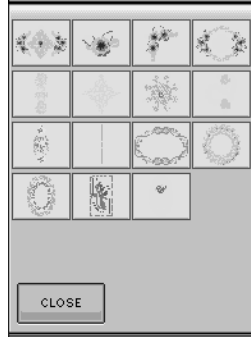

Border patterns

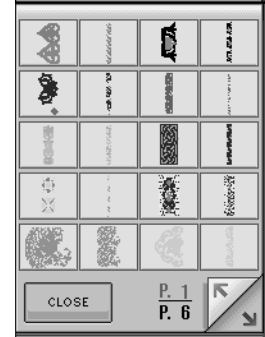

Cross stitch patterns



Floral alphabet patterns

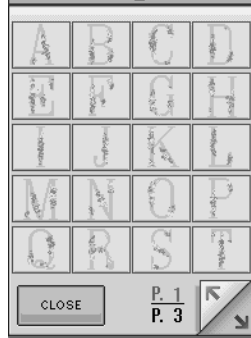

Alphabet characters

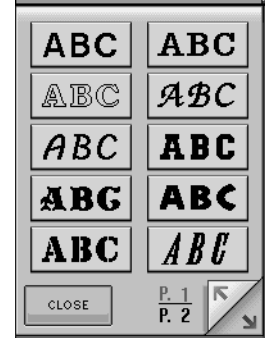

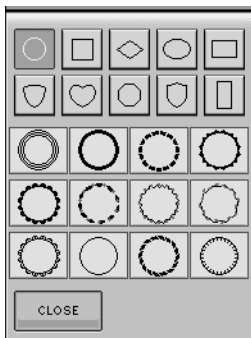

Frame patterns



Selecting Embroidery Patterns/ Heirloom Patterns/Border Patterns/Cross stitch Patterns/ Floral alphabet Patterns

- 1 Select the category of the pattern you want to embroider.
- 2 Press the key of the pattern you want to embroider.

* Press  to view the next page.

* Press  to view the previous page.

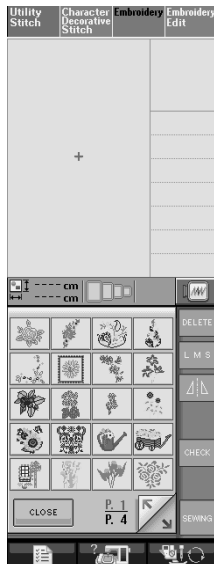

→ The selected pattern is displayed.

- 3 Press  to create a mirror image of the pattern as needed.

* If you make a mistake selecting the pattern, press the key of the pattern you want to embroider.

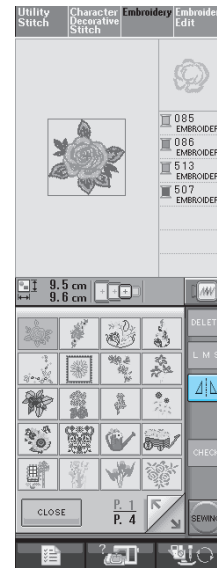

- 4 Press .

→ The sewing screen is displayed.

- 5 Proceed to see “VIEWING THE SEWING SCREEN” on page 155 to embroider the pattern.

* To return to the previous screen to select another pattern, press .

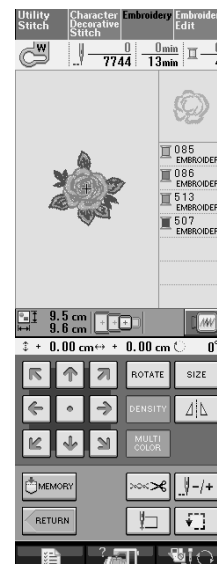

5

Embroidery

Selecting Alphabet Character Patterns

1 Press **AA**.

2 Press the key of the font you want to embroider.

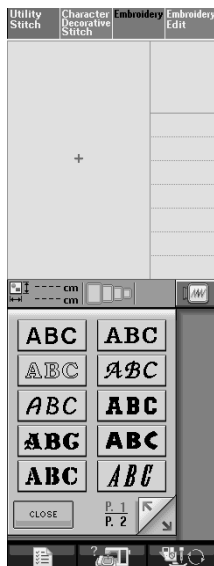

3 Press **ABC abc 0-9?!: ÄÄä** to change the selection screen, and then enter the characters that you want to embroider.

- * To enter a space, press **—**.
- * If you want to change the size of a character, select the character and then press **L M S** to change the size. The size changes each time you press the key, from large to medium to small.
- * If you make a mistake, press **DELETE** to erase the mistake.
- * If the pattern is too small to see clearly, you can use the **CHECK** key to check it.

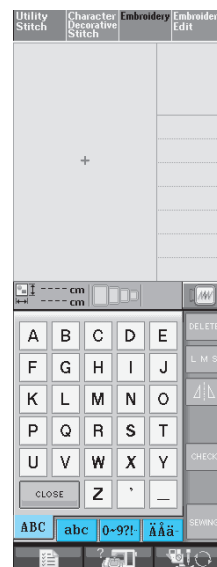

Memo

If you continue adding characters after changing the size, the new characters will be entered in the new size.

You cannot change the size of the entered characters after combining character stitch patterns.

4 Press  .



→ The sewing screen is displayed.

5 Proceed to see “VIEWING THE SEWING SCREEN” on page 155 to embroider the pattern.

* To return to the previous screen to select another pattern, press  .

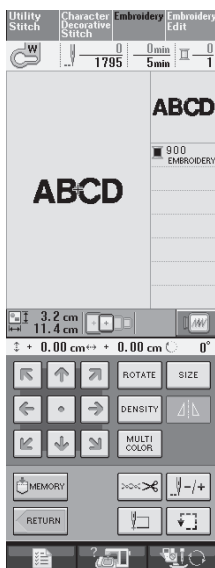

Selecting Frame Patterns

1 Press  .

2 Press the key of the frame shape you want to embroider in the top part of the screen.

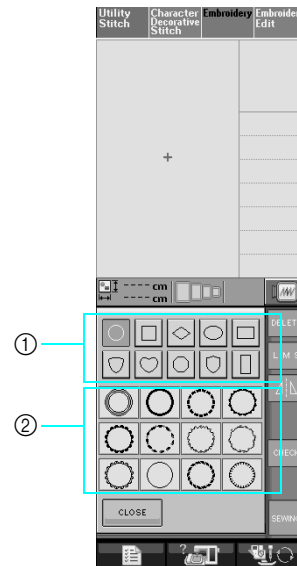

- ① Frame shapes
- ② Frame patterns

→ Various frame patterns are displayed at the bottom part of the screen.

3 Press the key of the frame pattern you want to embroider.

* If you make a mistake selecting the pattern, press the key of the pattern you want to embroider.
→ The selected pattern is displayed on the screen.

4 Press  .

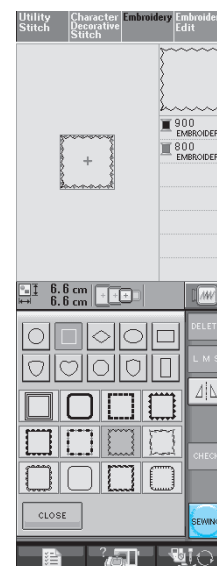

→ The sewing screen is displayed.



5

Embroidery

5 Proceed to see “VIEWING THE SEWING SCREEN” on page 155 to embroider the pattern.

* To return to the previous screen to select another pattern, press  .

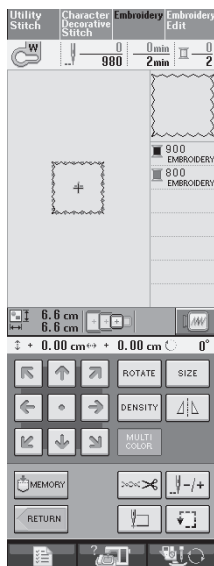

Selecting Patterns from Embroidery Cards

About Embroidery Cards (Sold Separately)

- Use only embroidery cards manufactured for this machine. Using unauthorized cards may cause your machine to operate incorrectly.
- Embroidery cards sold in foreign countries cannot be used with this machine.
- Store embroidery cards in the hard case.



Note

- Only insert or remove the embroidery card when  is displayed, or when the machine is turned off.
- Do not insert the card in a direction other than that shown by the arrow on the card, and do not force the card into the slot strongly. Do not put any object except for the embroidery cards into the slot. Otherwise, your machine may be damaged.

1 Insert the card completely into the slot on the right side of the machine.

* Insert the embroidery card so that the end with a printed arrow is facing the front.

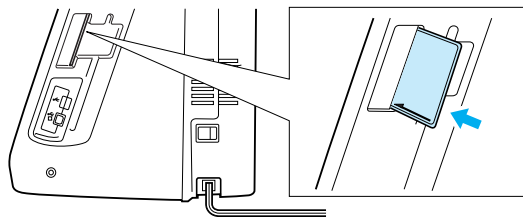

2 Press  .

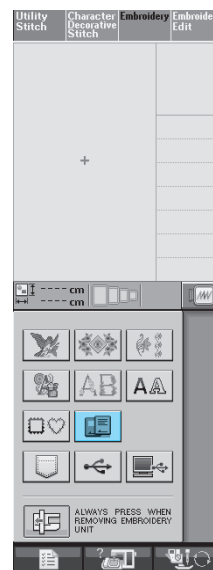

→ The patterns on the embroidery card are displayed on the selection screen.

3 Follow the steps on page 151 to select a pattern.

Selecting Patterns from USB media/Computer

To recall patterns from the computer or USB media, see pages 191 through 193.

VIEWING THE SEWING SCREEN

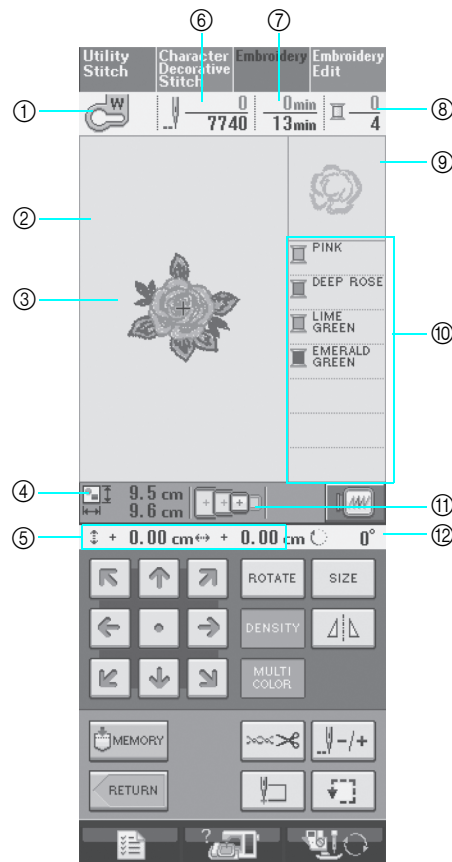

- ① Shows the presser foot code.
Attach embroidery foot "W" for all embroidery projects. When the foot presser symbol is displayed on the screen, you are able to sew.
- ② Shows the boundary for embroidering with the extra large frame (30 cm × 18 cm (approx. 12 inches × 7 inches)).
- ③ Shows a preview of the selected pattern.
- ④ Shows the size of the selected pattern.
- ⑤ Shows how far the sewing position is from the center (when you move the sewing position).
- ⑥ Shows how many stitches are in the selected pattern and how many stitches have been sewn so far.
- ⑦ Shows the time necessary to sew the pattern, and the time already spent sewing the pattern (not including time for changing and automatically trimming the thread).
- ⑧ Shows the number of colors in the selected pattern, and the number of the color currently being sewn.
- ⑨ Shows the part of the embroidery that will be sewn with the first thread color.
- ⑩ Shows the order the colors are sewn in.
- ⑪ Shows the embroidery frames that can be used for the selected pattern. Be sure to use the proper frame (see page 158).
- ⑫ Shows the degree of rotation of the pattern.

* There is an explanation of each key's function on the next page.



5

Embroidery

■ Key Functions

Using these keys, you can change the size of the pattern, rotate the pattern, etc.

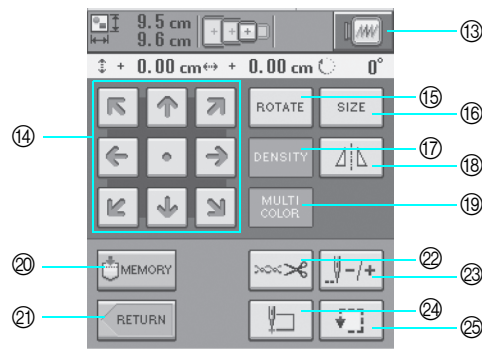

No.	Display	Key Name	Explanation	Page
13		Image key	Press this key for a preview of the sewn image.	164
14		Arrow keys (Center key)	Press an arrow key to move the pattern in the direction shown by the arrow. (Press the Center key to return the pattern to the center of the embroidery area.)	179
15		Rotate key	Press this key to rotate the pattern. You can rotate a pattern one degree, 10 degrees or 90 degrees at a time.	182
16		Size key	Press this key to change the size of the pattern.	181
17		Density key	Press this key to change the density of alphabet character or frame patterns.	183
18		Horizontal mirror image key	Press this key to create a horizontal mirror image of the pattern.	183
19		Multi color key	Press this key to change the color of each letter when sewing alphabet character patterns.	184
20		Memory key	Saves a pattern in the machine's memory, USB media or a computer.	187-190
21		Return key	Press this key to return to the pattern type selection screen.	—
22		Cut/Tension key	Press this key to specify automatic thread cutting, thread trimming or the thread tension. For embroidery, these functions are set automatically.	174-175
23		Forward/Back key	Press this key to move the needle forward or back in the pattern; useful if the thread breaks while sewing or if you want to start again from the beginning.	171-173
24		Starting point key	Press this key to move the needle start position to align the needle with the pattern position.	180
25		Trial key	Press this key to check the position of the pattern. The embroidery frame moves to the desired position so you can check that there is enough space to sew the pattern.	163



Note

- Some operations or functions are not available for certain patterns. If the key display is light gray, you cannot use that function or operation with the selected pattern.



PREPARING THE FABRIC

⚠ CAUTION

- Use fabrics with a thickness of less than 3 mm (approx. 1/8 inch). Using fabrics thicker than 3 mm (approx. 1/8 inch) may cause the needle to break.
- When using layers with thicker batting etc., you can sew more attractive embroidery by adjusting the embroidery presser foot height in the embroidery settings screen (see below).
- In the case of thick terry cloth towels we recommend that you place a piece of water soluble stabilizer on the top surface of the towel. This will help to reduce the nap of the toweling and result in more attractive embroidery.

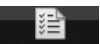

Note

Press , and use  and  in the EMBROIDERY FOOT HEIGHT display in the embroidery settings screen to adjust the presser foot height.



Attaching Iron-on Stabilizers (backing) to the Fabric

For best results in your embroidery projects, always use stabilizer material for embroidery. Follow the package instructions for the stabilizer being used.

When using fabrics that cannot be ironed (such as towel or fabrics that have loops which expand when ironed) or in places where ironing is difficult, position the stabilizer material under the fabric without fusing it, then position the fabric and stabilizer in the embroidery frame, or check with your authorized dealer for the correct stabilizer to use.

⚠ CAUTION

- Always use a stabilizer material for embroidery when sewing stretch fabrics, lightweight fabrics, fabrics with a coarse weave, or fabrics which cause pattern shrinkage. Otherwise, the needle may break and cause injury. Not using a stabilizer material may result in a poor finish to your project.

- 1 Use a piece of stabilizer which is larger than the embroidery frame being used.

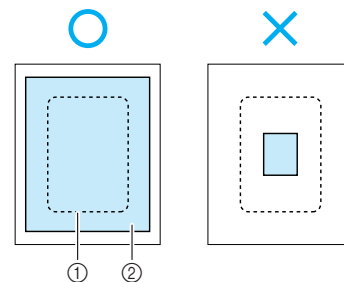

- ① Size of the embroidery frame
- ② Iron-on stabilizer (backing)

- 2 Iron the iron-on stabilizer material to the wrong side of the fabric.

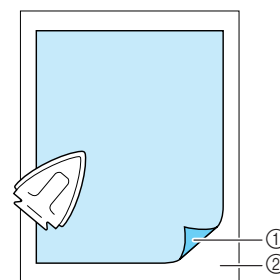

- ① Fusible side of stabilizer
- ② Fabric (wrong side)

Memo

- When embroidering on thin fabrics such as organdy or lawn, or on napped fabrics such as towel or corduroy, use water soluble stabilizer (sold separately) for best results. The water soluble stabilizer material will dissolve completely in water, giving the project a more attractive finish.





5

Embroidery

Hooping the Fabric in the Embroidery Frame

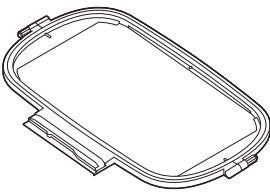
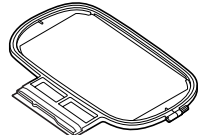
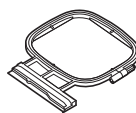
■ Types of Embroidery Frames

Extra Large	Large	Medium	Small
			
Can embroider an area 30 cm × 18 cm (approx. 12 inches × 7 inches)	Can embroider an area 18 cm × 13 cm (approx. 7 inches × 5 inches)	Can embroider an area 10 cm × 10 cm (approx. 4 inches × 4 inches)	Can embroider an area 2 cm × 6 cm (approx. 1 inch × 2-1/2 inches)
Use when embroidering connected or combined characters or patterns, or when embroidering large patterns.	Use when embroidering patterns between 10 cm × 10 cm (approx. 4 inches × 4 inches) and 18 cm × 13 cm (approx. 7 inches × 5 inches).	Use when embroidering patterns under 10 cm × 10 cm (approx. 4 inches × 4 inches).	Use for embroidering names or very small patterns.

Embroidery Frame 26 cm × 16 cm (approx. 10-1/4 inches × 6-1/4 inches) can be used. Select a frame that matches the pattern size. Frame options are displayed on the LCD.

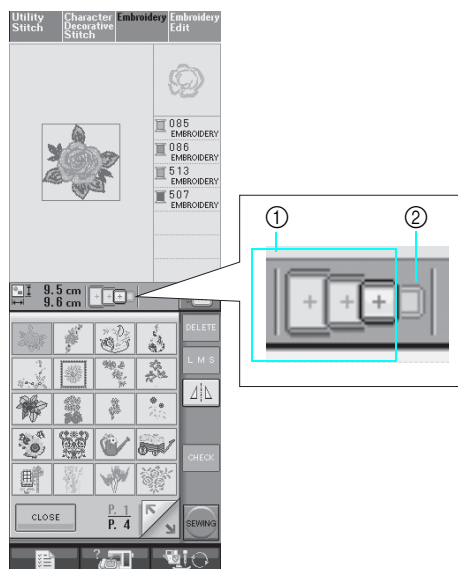

- ① Can be used
- ② Cannot be used

! CAUTION

- If you use a frame that is too small, the presser foot may strike the frame during sewing and cause injury.

■ Inserting the Fabric



Note

- If the fabric is placed loose in the embroidery frame, the embroidery design will sew out poorly. Insert the fabric on a level surface, and gently stretch the fabric taut in the frame. Follow the steps below to insert the fabric correctly.

- 1** Lift-up and loosen the frame adjustment screw and remove the inner frame.

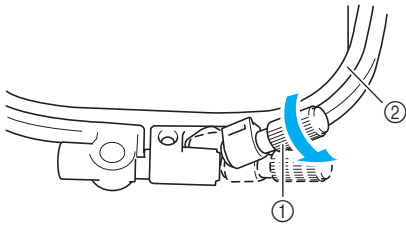

- ① Frame adjustment screw
- ② Inner frame

- 2** Lay the fabric right side up on top of the outer frame.

Re-insert the inner frame making sure to align the inner frame's \triangle with the outer frame's ∇ .

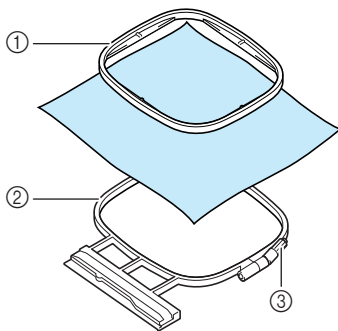

- ① Inner frame
- ② Outer frame
- ③ Frame adjustment screw

- 3** Slightly tighten the frame adjustment screw, and then remove the slack in the fabric by pulling on the edges and corners. Do not loosen the screw.

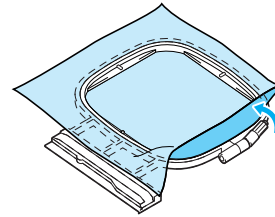

Memo

When using the extra large frame, tighten the adjustment screws at the top and bottom of the frame, so that the spaces at the top and bottom of the frame are equal.

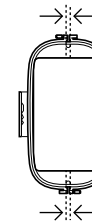

- 4** Gently stretch the fabric taut, and tighten the frame adjustment screw to keep the fabric from loosening after stretching.

* After stretching the fabric, make sure the fabric is taut.

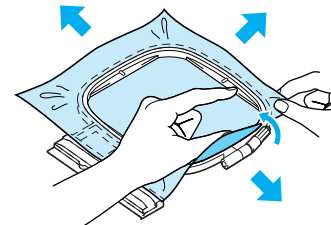

* Make sure the inside and outside frames are even before you start embroidering.

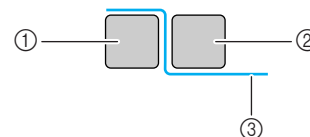

- ① Outer frame
- ② Inner frame
- ③ Fabric



Memo

Stretch the fabric from all four corners and all four edges. While stretching the fabric, tighten the frame adjustment screw.



5

Embroidery

- 5** Return the frame adjustment screw to its initial position.

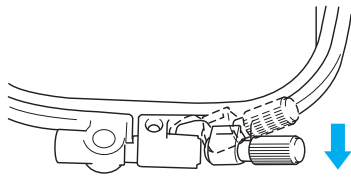

■ Using the Embroidery Sheet

When you want to embroider the pattern in a particular place, use the embroidery sheet with the frame.

- 1** With a chalk pen, mark the area of the fabric you want to embroider.

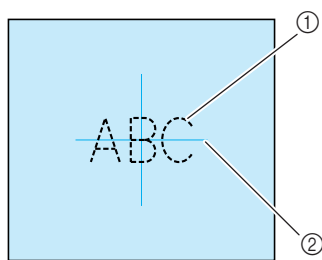

- ① Embroidery pattern
- ② Mark

- 2** Place the embroidery sheet on the inner frame. Align the guide lines on the embroidery sheet with the mark you made on the fabric.

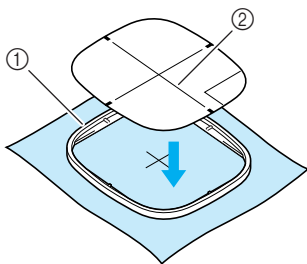

- ① Inner frame
- ② Guide line

- 3** Gently stretch the fabric so there are no folds or wrinkles, and press the inner frame into the outer frame.

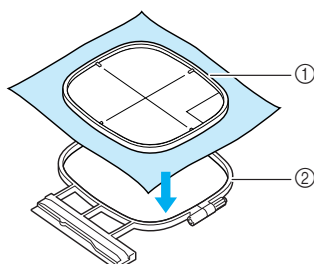

- ① Inner frame
- ② Outer frame

- 4** Remove the embroidery sheet.

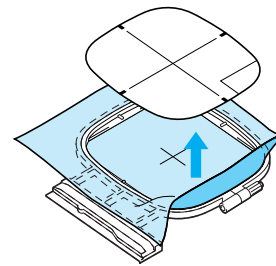

Embroidering Small Fabrics or Fabric Edges

Use an embroidery stabilizer to provide extra support. After embroidering, remove the stabilizer carefully. Attach the stabilizer as shown in the examples below. We recommend using a stabilizer for embroidery.

■ Embroidering Small Fabrics

Use a temporary spray adhesive to adhere the small piece of fabric to the larger piece in the frame. If you do not wish to use a temporary spray adhesive, attach the stabilizer with a basting stitch.

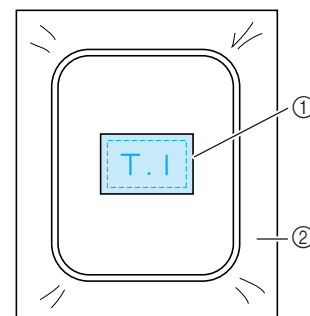

- ① Fabric
- ② Stabilizer

■ Embroidering Edges or Corners

Use a temporary spray adhesive to adhere the small piece of fabric to the larger piece in the frame. If you do not wish to use a temporary spray adhesive, attach the stabilizer with a basting stitch.

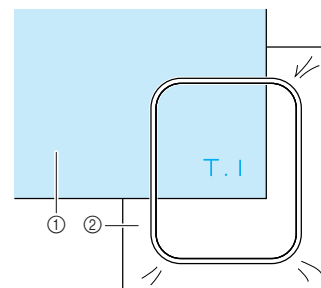

- ① Fabric
- ② Stabilizer

■ Embroidering Ribbons or Tape

Secure with double-sided tape or a temporary spray adhesive.

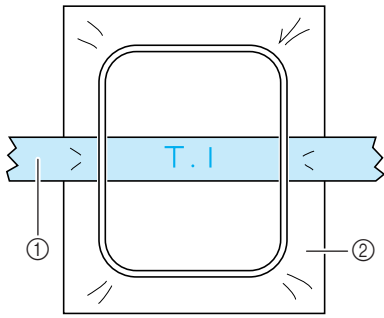

- ① Ribbon or tape
- ② Stabilizer



ATTACHING THE EMBROIDERY FRAME



Note

Wind and insert the bobbin before attaching the embroidery frame.

- 1 Press the “Presser Foot Lifter” button to raise the presser foot.

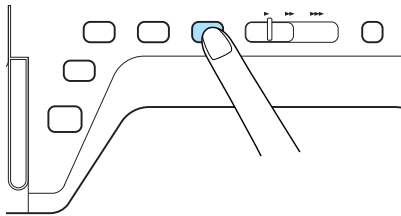

- 2 Align the embroidery frame guide with the right edge of the embroidery frame holder.

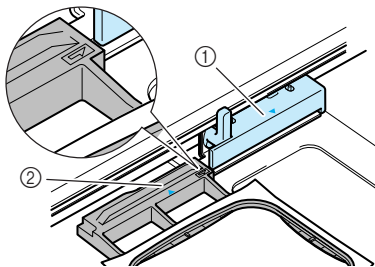

- ① Embroidery frame holder
- ② Embroidery frame guide

- 3 Slide the embroidery frame into the holder, making sure to align the embroidery frame’s \triangle with the holder’s ∇ .

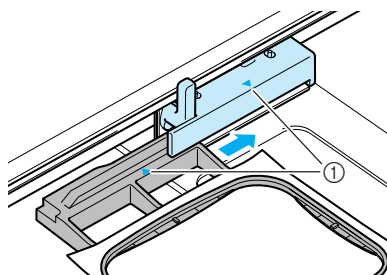

- ① Arrow mark

- 4 Lower the frame-securing lever to be level with the frame to secure the embroidery frame in the embroidery frame holder.

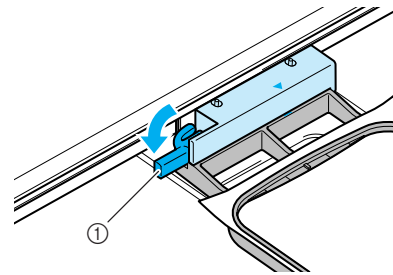

- ① Frame-securing lever



CAUTION

- If the frame-securing lever is not lowered, the embroidery pattern may not sew out correctly or the presser foot may strike the embroidery frame and cause injury.

Removing the Embroidery Frame

- 1 Raise the frame-securing lever.

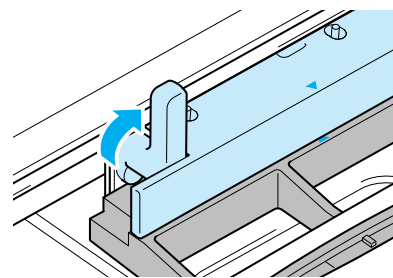

- 2 Pull the embroidery frame toward you.

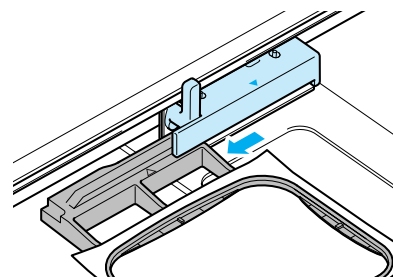

CONFIRMING THE PATTERN POSITION

The pattern is normally positioned in the center of the embroidery frame. You can check the layout before starting embroidery and change the position.

Checking the Pattern Position

The embroidery frame moves and shows the pattern position. Watch the frame closely to make sure the pattern will be sewn in the right place.

1 Press .

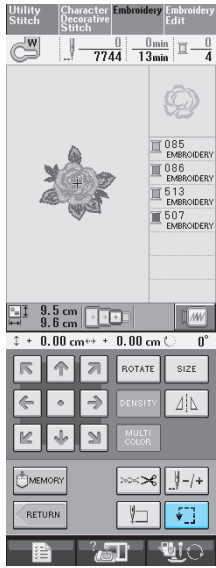

→ The following screen is displayed.

2 From , press the key for the position that you want to check.

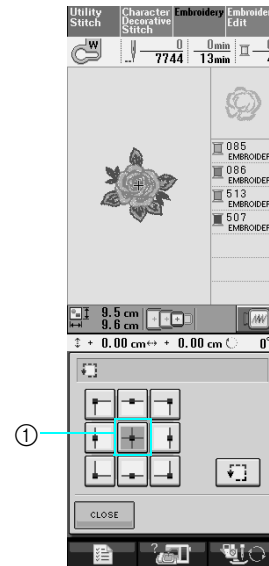

- ① Selected position
- The needle will move to the selected position on the pattern.



Memo

To see the entire embroidering area, press . The embroidery frame moves and shows the embroidery area.

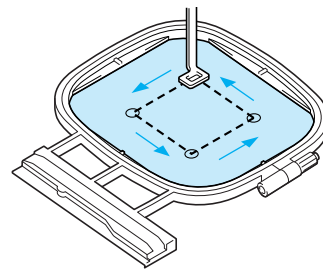

⚠ CAUTION

- Make sure the needle is up when the embroidery frame is moving. If the needle is down, it could break and result in injury.

3 Press .

Previewing the Completed Pattern

1 Press .

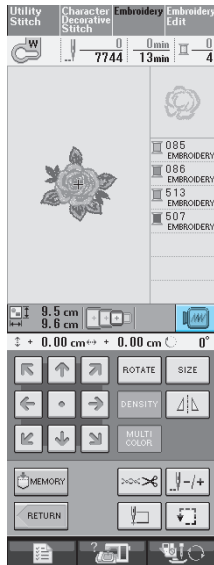

→ An image of the pattern as it will be embroidered appears.

2 Press  to select the frame used in the preview.

- * Frames displayed in light gray cannot be selected.
- * Press  to see a full screen preview.
- * The pattern can be sewn as it appears in the following display.



Memo

You can begin sewing from this screen by pressing the “Start/Stop” button.

3 Press  to return to the original screen.

SEWING AN EMBROIDERY PATTERN

Sewing Attractive Finishes

There are many factors that go into sewing beautiful embroidery. Using the appropriate stabilizer (see page 157) and hooping the fabric in the frame (see page 158) are two important factors mentioned earlier. Another important point is the appropriateness of the needle and thread being used. See the explanation of threads below.

Thread	Upper thread	Use embroidery thread, or country embroidery thread intended for use with this machine. Other embroidery threads may not yield optimum results.
	Bobbin thread	Use embroidery bobbin thread intended for use with this machine. When using other kinds of embroidery bobbin thread, use the bobbin case (no marking) included with this machine (The bobbin case originally installed in the machine has a green screw). (See page 236 for how to remove the bobbin case.)



Memo

If you use threads other than those listed above, the embroidery may not sew out correctly.



Note

- Before embroidering, check that there is enough thread in the bobbin. If you continue sewing without enough thread in the bobbin, the thread may tangle.
- Do not leave objects in the range of motion of the embroidery frame. The frame may strike the object and cause a poor finish to the embroidery pattern.
- When embroidering on large garments (especially jackets or other heavy fabrics), do not let the fabric hang over the table. Otherwise, the embroidery unit cannot move freely, and the pattern may not turn out as planned.

Embroidery Needle Plate Cover

Under some conditions, based on the type of fabric, stabilizer, or thread being used, there may be some looping in the upper thread. In this case, attach the included embroidery needle plate cover to the needle plate. Attach the cover by inserting the two projections on the underside of the cover into the notches on the needle plate as shown below.

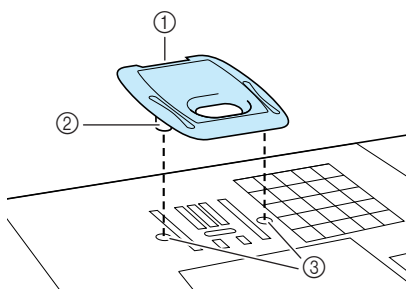

- ① Groove
- ② Projection
- ③ Notch

To remove the embroidery needle plate cover, place your fingernail in the groove and lift the plate out.

CAUTION

- Push the embroidery needle plate cover as far as possible to attach it. If the embroidery needle plate cover is not securely attached, it may cause the needle to break.



Note

- Do not use the embroidery needle plate cover for any applications other than embroidery.



5

Embroidery

Sewing Embroidery Patterns

Example:

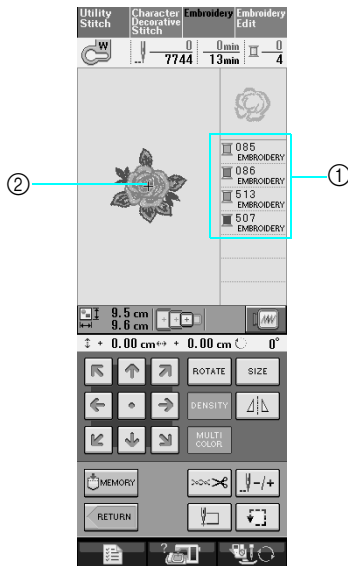

- ① Embroidery color order
- ② Cursor



Memo

The [+] cursor moves over the pattern, showing which part of the pattern is being sewn.

- 1 Thread the machine with the first color (see "Threading Using the "Automatic Threading" Button" on page 29).

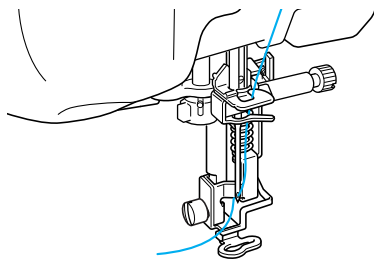

- 2 Lower the presser foot, then press the "Start/Stop" button to start embroidering. After 5-6 stitches, press the "Start/Stop" button again to stop the machine.
- 3 Trim the excess thread at the end of the seam. If the end of the seam is under the presser foot, raise the presser foot, then trim the excess thread.

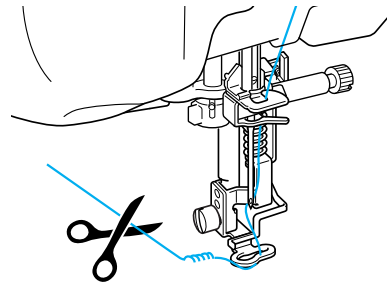

- 4 Press the "Start/Stop" button to start embroidering.
 - When the first color is completely sewn, the machine will automatically trim the threads and stop. The presser foot will then automatically be raised. On the embroidery color order display, the next color will move to the top.





Memo

If there is thread left over from the beginning of sewing, it may be sewn over as you continue embroidering the pattern, making it very difficult to deal with the thread after the pattern is finished. Trim the threads at the beginning.

- 5 Remove the thread for the first color from the machine. Thread the machine with the next color.

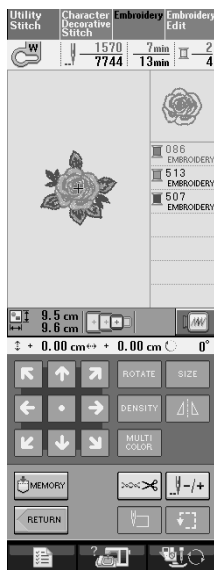
- 6** Repeat the same steps for embroidering the remaining colors.



→ When the last color is sewn, "Finish sewing" will appear on the display. Press , and the display will return to the original screen.



Memo

The Thread Trimming Function is originally set to trim excess thread jumps (threads linking parts of the pattern, etc.). When an end of upper thread may remain on the surface of the fabric at the beginning of the stitching, depending on the type of thread and fabric that are used, cut off this excess thread.

*If the setting has been turned off, trim the excess thread jumps using scissors after the pattern is finished. See page 175 for information on the thread trimming function.

When Threading Manually

- 1** Thread the machine manually with the first color (see "Threading Manually" on page 31).

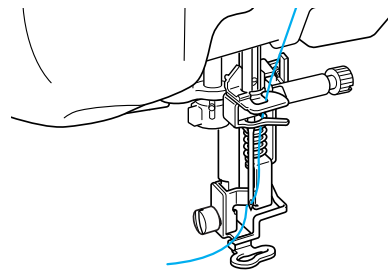

- 2** Lower the presser foot, then press the "Start/Stop" button to start embroidering. After 5-6 stitches, press the "Start/Stop" button again to stop the machine.

- 3** Trim the excess thread at the end of the seam. If the end of the seam is under the presser foot, raise the presser foot, then trim the excess thread.

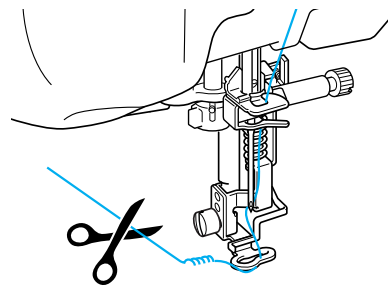

Memo

If there is thread left over from the beginning of sewing, it may be sewn over as you continue embroidering the pattern, making it very difficult to deal with the thread after the pattern is finished. Trim the threads at the beginning.

- 4** Press the "Start/Stop" button again to restart the machine.
- 5** Repeat steps **4** and **5** from the previous section.



5

Embroidery

Sewing Embroidery Patterns Which Use Appliqué



There are some patterns which call for an appliqué inside the pattern. Prepare the base fabric and the appliqué fabric (appliqué piece).

When sewing an embroidery pattern with an appliqué, the color sewing order display shows “Appliqué Material”, “Appliqué Position”, “Appliqué”, and then the sewing order of the colors around the appliqué.

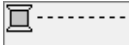

Memo

Depending on the thread color display setting, the display may show  ,

 , or  .

1

Attach an iron-on stabilizer to the wrong side of the appliqué material.

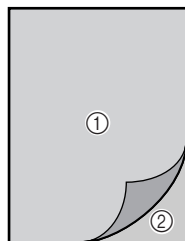

- ① Appliqué material (cotton, felt, etc.)
- ② Iron-on stabilizer

2

Place the appliqué material into the embroidery frame, and then press the “Start/Stop” button to sew the outline of the appliqué.

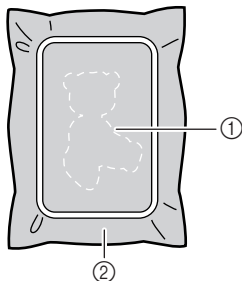

- ① Outline of appliqué
- ② Appliqué material



Memo

The embroidery procedure is the same as the basic procedure explained on pages 166 through 167.

→ The machine will sew around the outline of the appliqué pieces and will then stop.

3

Remove the appliqué material from the embroidery frame, and then cut carefully along the stitching. After cutting, remove all of the stitching thread carefully.

- * Carefully cut out the pattern on the outline you just sewed. Do not cut inside the stitching line, as the appliqué fabric will not be caught by the appliqué stitch.

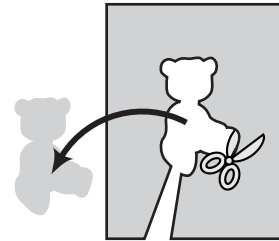

4

Place the base material into the embroidery frame.

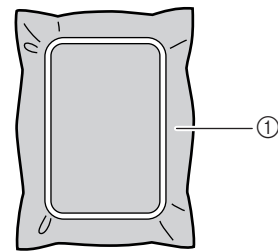

- ① Base material

5

Press the “Start/Stop” button to sew the position of the appliqué.

- * Use the same thread color you plan to use when attaching the appliqué in step 7.

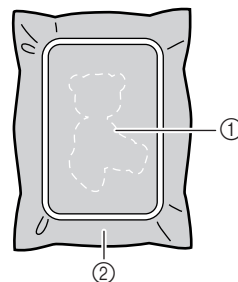

- ① Position of appliqué
- ② Base material

→ The machine will sew around the position of the appliqué and will then stop.

- 6** Apply a thin layer of adhesive or spray adhesive to the back of the appliqué piece and attach it to the appliqué position so that it follows the seam of the outline.

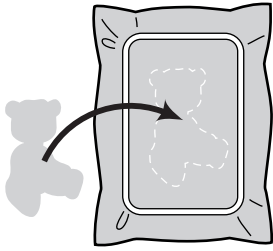

 **Memo**

If the appliqué material is a lightweight fabric, you may want to use a fusible web on the back to stabilize the fabric and for appliqué placement. Fuse appliqué in place with an iron. Do not remove fabric from the frame to iron the appliqué material.

- 7** Press the “Start/Stop” button.

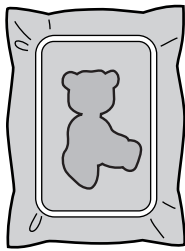

 **Memo**

Some patterns may not show all three appliqué steps. Sometimes the “Appliqué” step will be shown as a color.

→ The appliqué will then be completed.

- 8** Change the upper thread and then carry out the rest of the embroidering.

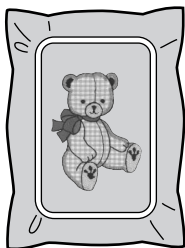

 **Memo**

- Some glue may get onto the presser foot, needle, and needle plate at this time. Finish embroidering the appliqué pattern and then clean away the glue.
- For best sewing results clip all threads between color steps.





ADJUSTMENTS DURING THE EMBROIDERY PROCESS



Note

- Be careful not to bump the embroidery unit carriage or the presser foot when removing or attaching the embroidery frame. Otherwise, the pattern will not embroider correctly.

If the Bobbin Runs Out of Thread

When the bobbin begins to run out of thread during embroidering, the machine will stop and the message below will appear. Press  and follow the directions below to rethread the lower threading. If very little sewing remains, you can embroider 10 final stitches without rethreading the machine by pressing . The machine will stop after sewing the 10 stitches.

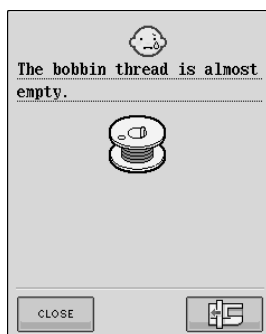

- 1 Press .

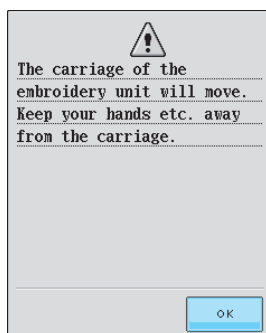

→ After the thread is automatically cut, the carriage will move.

- 2 **Unlock the frame-securing lever and remove the embroidery frame.**

- * Be careful not to apply strong force to the fabric at this time. Otherwise, the fabric may loosen in the frame.

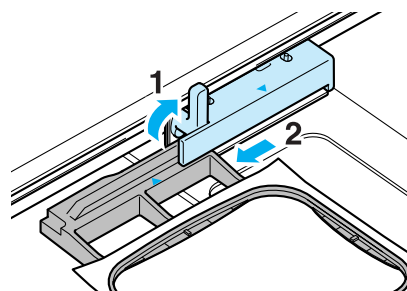

- 3 **Insert a wound bobbin into the machine.** (See page 26 for Setting the bobbin.)

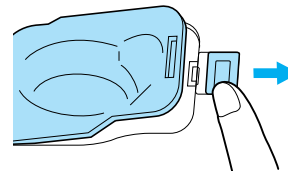

- 4 Press .

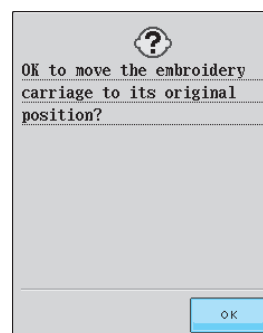



→ The carriage will return to its original position.





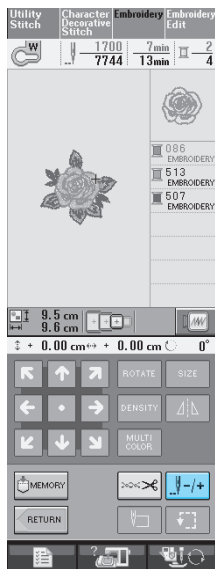

- 5 **Attach the embroidery frame.**

- 6 **To return to the spot in the pattern where you stopped sewing, follow steps 3 through 6 in the next section.**

If the Thread Breaks During Sewing

- 1 Press the “Start/Stop” button to stop the machine.
- 2 If the upper thread is broken, redo the upper threading. If the bobbin thread is broken, press  and follow the directions in steps 1 through 5 from the previous section to reset the bobbin.
- 3 Press .



- 4 Press  -1,  -10, or  -100 to move the needle back the correct number of stitches before the spot where the thread broke.
 - * If you cannot move back to the spot where the thread broke, press  to select the color and move to the beginning position of that color, then use  +1,  +10, or  +100 to move ahead to slightly before where the thread broke.

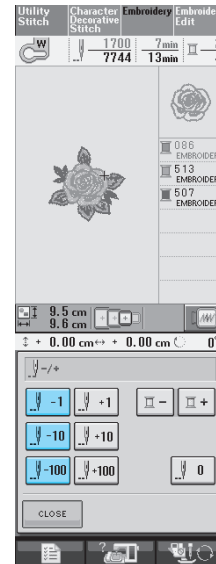

- 5 Press  to return to the original screen.
- 6 Press the “Presser Foot Lifter” button to lower the presser foot, and press the “Start/Stop” button to continue sewing.



5

Embroidery

Restarting from the Beginning

1 Press .



2 Press .

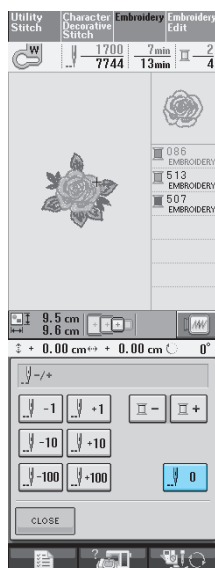

→ The embroidery frame moves, returning the needle to the pattern's beginning position.

3 Press the "Presser Foot Lifter" button to lower the presser foot and start sewing.

Resuming Embroidery After Turning Off the Power

The current color and stitch number are saved when embroidery is stopped. The next time that the machine is turned on, you can choose whether or not to continue the stopped sewing operation.



Memo

Even if the power goes out in the middle of embroidery, the machine returns to the point where embroidery was stopped when the machine is turned on again.

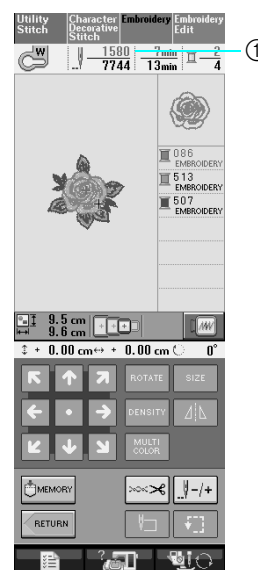

① Current stitch number when embroidery was stopped



Note

- Do not remove the embroidery unit or the memory will no longer remember your design.

1

Turn the main power to ON.

2

Follow the instructions shown on the screen and remove the embroidery frame.

→ The following message will appear.

3 Attach the embroidery frame and press

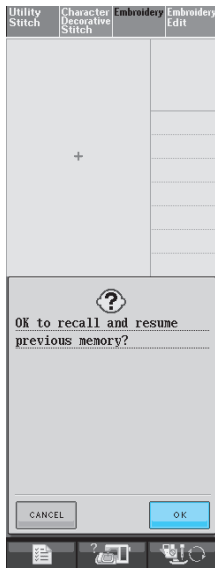
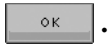

→ The previous sewing screen displayed before the machine was turned off appears.



Memo

If you want to start a new operation, press



so the pattern selection screen appears.

4 Continue embroidering.

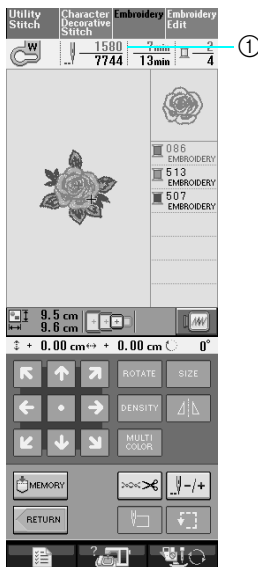

① Stitch number when embroidery is resumed



5

Embroidery

MAKING EMBROIDERY ADJUSTMENTS

Adjusting Thread Tension

When embroidering, the thread tension should be set so that the upper thread can slightly be seen on the wrong side of the fabric.

■ Correct Thread Tension

The pattern can be seen from the wrong side of the fabric. If the thread tension is not set correctly, the pattern will not finish well. The fabric may pucker or the thread may break.



(Right side)



(Wrong side)

Follow the operations described below to adjust thread tension according to the situation.



Note

- If the thread tension setting is made extremely weak, the machine may stop during sewing. This is not the sign of a malfunction. Increase the thread tension slightly, and begin sewing again.



Memo

- If you turn the main power to OFF or select a different pattern, the thread tension will reset to the automatic setting.
- When you retrieve a saved pattern, the thread tension setting will be the same as when the pattern was saved.

■ Upper Thread is Too Tight

The tension of the upper thread is too tight, resulting in the bobbin thread being visible from the right side of the fabric.



(Right side)



(Wrong side)

1 Press .

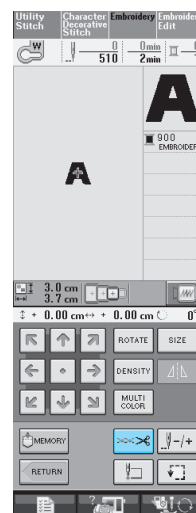

2 Press to weaken the upper thread tension. (The tension number will decrease.)



3 Press .

■ Upper Thread is Too Loose

The tension of the upper thread is too loose, resulting in a loose upper thread, loose thread locks, or loops appearing on the right side of the fabric.



(Right side)





(Wrong side)

1 Press .

2 Press to tighten the upper thread tension. (The tension number will increase.)

3 Press .

Using the Automatic Thread Cutting Function (END COLOR TRIM)

The automatic thread cutting function  will cut the thread at the end of sewing each color. This function is initially turned on. To turn this function off, press  key and then . This function can be turned on or off during embroidering.

- * This setting returns to its default  when the machine is turned off.

1 Press .

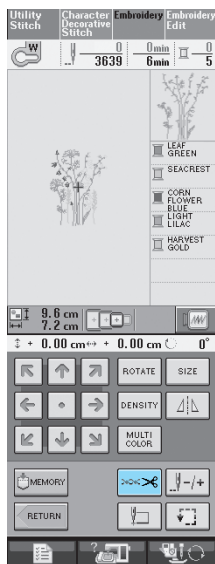



2 Press  to turn off END COLOR TRIM.



→ The key will display as 

- * When one color thread is sewn, the machine will stop without cutting the thread.

Using the Thread Trimming Function (JUMP STITCH TRIM)

The thread trimming function  will automatically trim any excess thread jumps within the color. This function is initially turned on. To turn this function off, press  key and then . This function can be turned on or off during embroidering.

- * Your customized setting remains after turning off and on the machine.

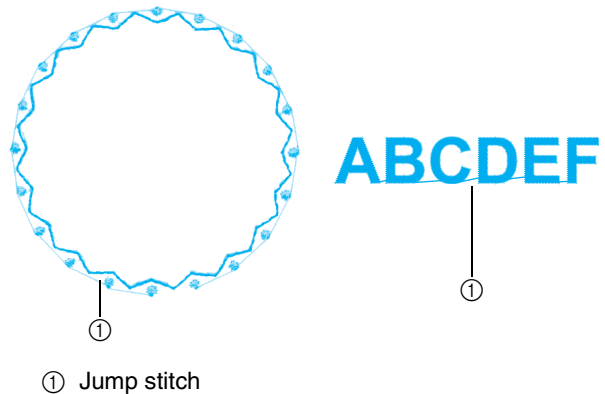

Note

- When this function is turned on, use the enclosed ball point needle 75/107 for embroidering patterns with short jump stitches such as alphabet characters. Using other needles may cause the thread to break.

1 Press .

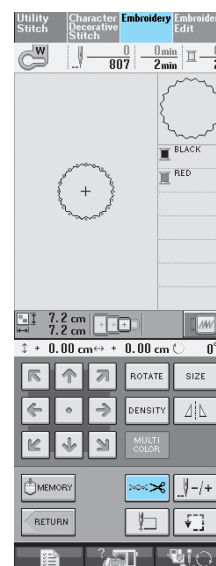

5

Embroidery

2 Press  to turn off JUMP STITCH TRIM.





→ The key will display as 

* The machine will not trim the thread before moving to the next stitching.

■ Selecting the length of JUMP STITCH not to trim

When the thread trimming function  is turned on, you can select the length of the jump stitch not to trim the thread. This function can be turned on or off during embroidering. Select a setting from 5 mm to 50 mm in 5 mm increments.

* Your customized setting remains after turning off and on the machine.

Press  or  to select the length of JUMP STITCH.

For example: Press  to select 25 mm (1 inch) and the machine will not trim a jump stitch of 25 mm or less before moving to the next stitching.

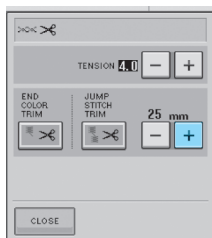



Note

- If design has many trims it is recommended to select a higher jump stitch trim setting in order to reduce the amount of excess tails on backside of fabric.
- The higher number of the jump stitch length selected, the fewer number of times the machine will trim. In this case, more jump stitches remain on the surface of the fabric.

Adjusting the Embroidery Speed

1 Press  and Embroidery.

2 In the MAX EMBROIDERY SPEED display, use   to change the maximum embroidery speed.

* You can choose from 3 different speed levels.



Memo

- SPM is the number of stitches sewn in one minute.
- Decrease the sewing speed when embroidering on thin, thick, or heavy fabrics.
- The sewing speed can be changed while embroidery is being sewn.
- The maximum sewing speed setting does not change until a new setting is selected. The setting specified before the main power is set to OFF remains selected the next time that the machine is turned on.
- Decrease the sewing speed to 600 spm when using a speciality thread like a metallic thread.

3 Press .

Changing the Thread Color Display



You can display the name of the thread colors, the time or embroidery thread number.

Memo



Colors on the screen may vary slightly from actual spool colors.

1 Press  .

2 Press  .

3 In the **THREAD COLOR DISPLAY**, use   to display the name of the thread colors, the time or the embroidery thread number.



4 When the thread number **#123** is displayed, use   to select from six embroidery thread brands pictured below.

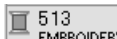
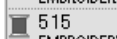
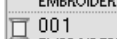

EMBROIDERY/POLYESTER THREAD#

-  513 EMBROIDERY
-  515 EMBROIDERY
-  001 EMBROIDERY

COUNTRY/COTTON THREAD#

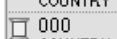
-  444 COUNTRY
-  446 COUNTRY
-  000 COUNTRY

MADEIRA /POLYESTER THREAD#

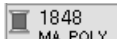
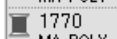
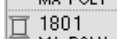
-  1848 MA POLY
-  1770 MA POLY
-  1801 MA POLY

MADEIRA RAYON THREAD#

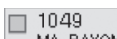
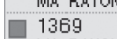
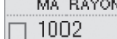
-  1049 MA RAYON
-  1369 MA RAYON
-  1002 MA RAYON

SULKY / POLYESTER THREAD#

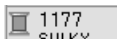
-  1177 SULKY
-  1176 SULKY
-  1001 SULKY

ROBISON-ANTON/POLYESTER THREAD#

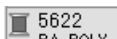
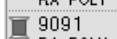
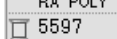



-  5622 RA POLY
-  9091 RA POLY
-  5597 RA POLY

5 Press  .



Embroidery

Changing the Embroidery Frame Display

- 1 Press .
- 2 Press .
- 3 In the FRAME DISPLAY, use   to change the embroidery frame display mode.

* There are 10 choices.

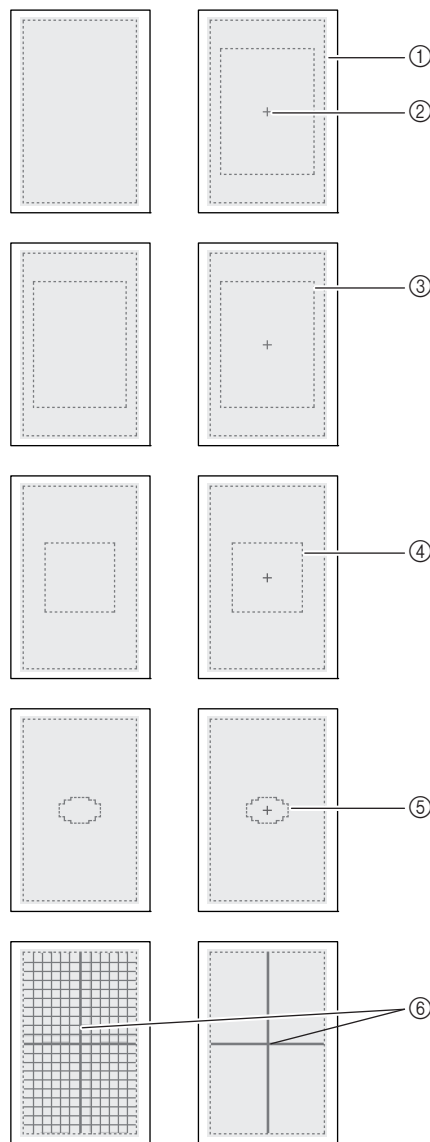

- ① Extra large frame embroidering area
- ② Center line
- ③ Large frame embroidering area
- ④ Medium frame embroidering area
- ⑤ Small frame embroidering area
- ⑥ Grid lines

- 4 Press .

REVISING THE PATTERN

⚠ CAUTION

- When you have revised the pattern, check the display of available embroidery frames and use an appropriate frame. If you use an embroidery frame not displayed as available for use, the presser foot may strike the frame and possibly cause injury.

Changing the Pattern Position

Use  to move the pattern in the direction shown by the arrow.

Press  to center the pattern.

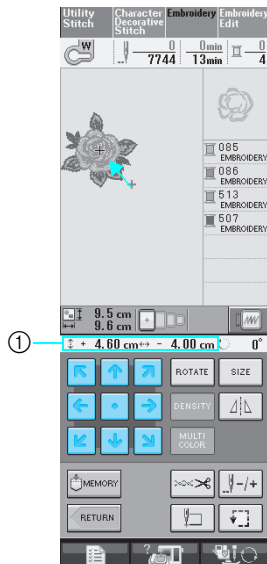

① Distance from the center

The pattern can also be moved by dragging it.

If a USB mouse is connected, move the mouse to position the pointer on the desired pattern, and then select and drag the pattern. The pattern can also be dragged by selecting it directly in the screen with your finger or the touch pen.

Memo

- Patterns cannot be moved in screens where



does not appear.

- If  in the Embroidery Edit screen is pressed to display an enlargement of the pattern, the pattern cannot be moved by

dragging it. Press  in the screen to move the pattern.



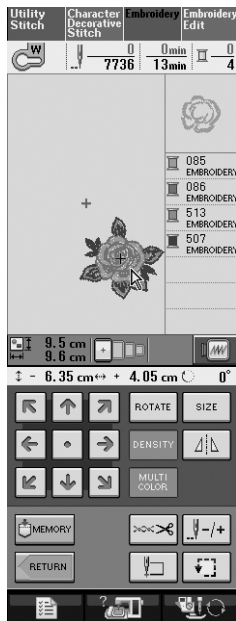
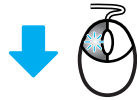
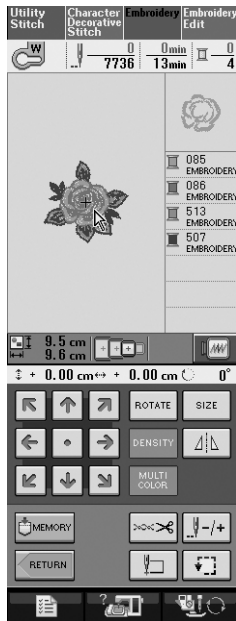

Aligning the Pattern and the Needle

Example: Aligning the lower left side of a pattern and the needle

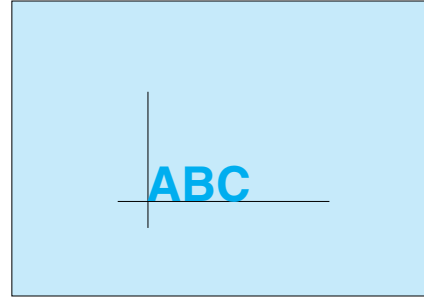

1 Mark the embroidery start position on the fabric, as shown.

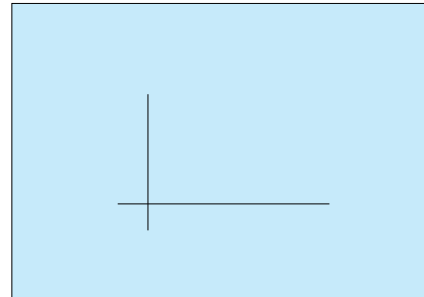

2 Press .

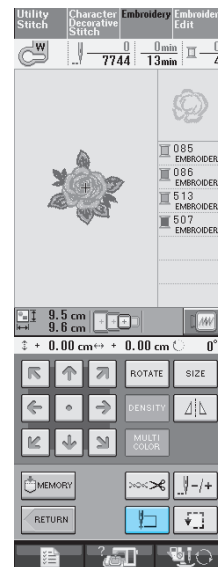

3 Press .

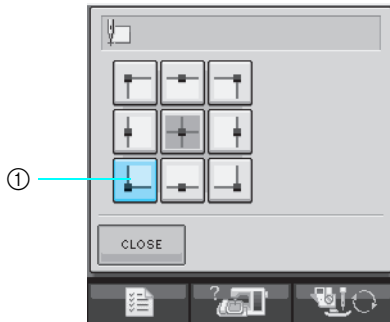

① Start position

→ The needle position moves to the bottom left corner of the pattern (the embroidery frame moves so that the needle is positioned correctly).

4 Press .

5 Use  to align the needle and the mark on the fabric, and begin embroidering the pattern.

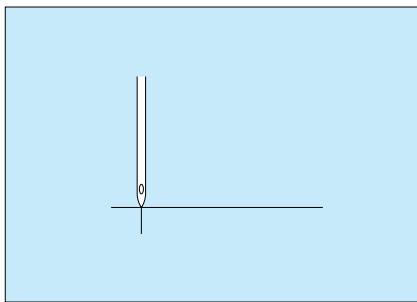







Changing the Size

1 Press .



2 Select the direction in which to change the size.

- * Press  to enlarge the pattern proportionately.
- * Press  to shrink the pattern proportionately.
- * Press  to stretch the pattern horizontally.
- * Press  to compact the pattern horizontally.
- * Press  to stretch the pattern vertically.
- * Press  to compact the pattern vertically.
- * Press  to return the pattern to its original appearance.

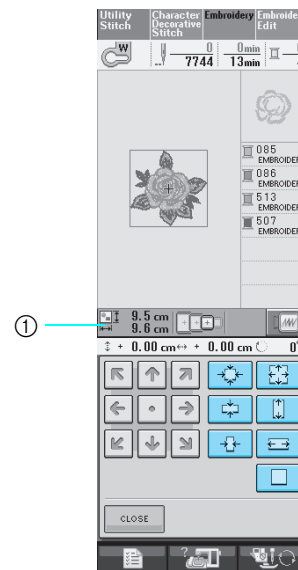

① Size of the pattern

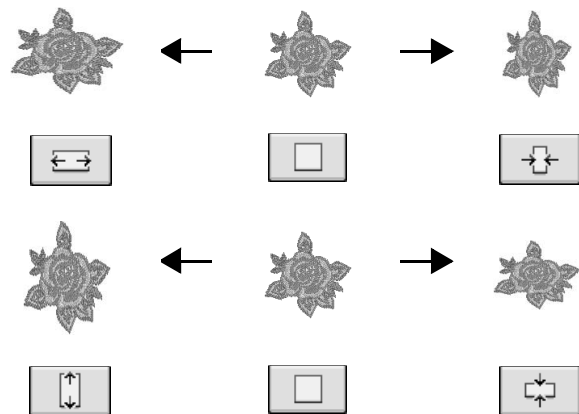

Memo

- Some patterns or characters can be enlarged more than others.
- Some patterns or characters can be enlarged to a greater degree if they are rotated 90 degrees.

3 Press  to return to the original screen.

Rotating the Pattern

1 Press **ROTATE**.

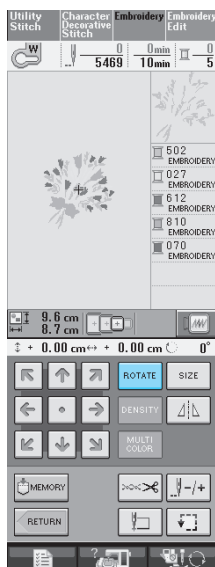

2 Select the angle of rotation for the pattern.

- * Press to rotate the pattern 90 degrees to the left.
- * Press to rotate the pattern 90 degrees to the right.
- * Press to rotate the pattern 10 degrees to the left.
- * Press to rotate the pattern 10 degrees to the right.
- * Press to rotate the pattern 1 degree to the left.
- * Press to rotate the pattern 1 degree to the right.
- * Press **RESET** to return the pattern to its original position.

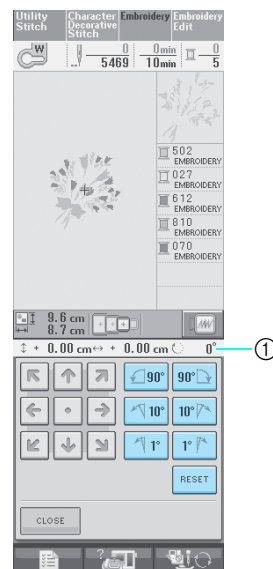

① Degree of rotation





0°



3 Press **CLOSE** to return to the original screen.

Creating a Horizontal Mirror Image

Press  so it appears as  to create a horizontal mirror image of the selected pattern.
Press  again to return the pattern to normal.

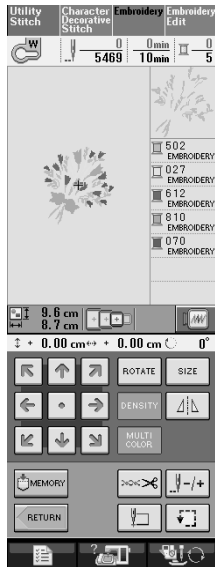

Changing the Density (Alphabet Character and Frame Patterns Only)

The thread density for some alphabet character and frame patterns can be changed.

A setting between 80% and 120% in 5% increments can be specified.

1 Press .

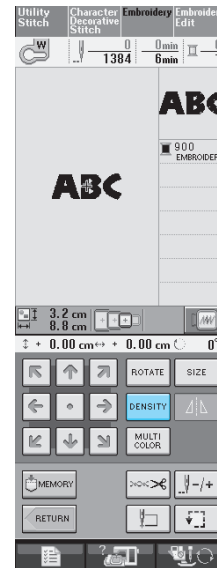

5

Embroidery

2 Change the density.

- * Press **-** to make the pattern less dense.
- * Press **+** to make the pattern more dense.

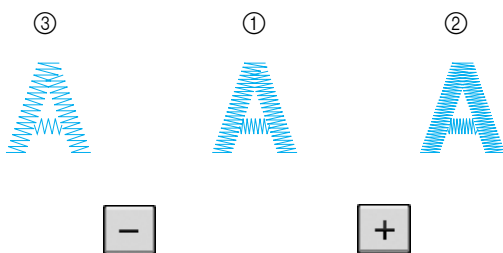
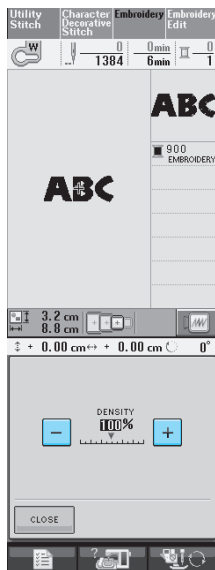

- ① Normal
- ② Fine (stitches closer together)
- ③ Coarse (stitches farther apart)

→ The pattern density changes each time you press a button.

3 Press **CLOSE** to return to the pattern selection screen.

Changing the Colors of Alphabet Character Patterns

Combined alphabet character patterns can be sewn with each letter in a different color. If "MULTI COLOR" is set, the machine stops after each character is sewn so that the thread can be changed to a different color.

1 Press **MULTI COLOR** so that it appears as **MULTI COLOR**.

- * Press the key again to return to the original setting.

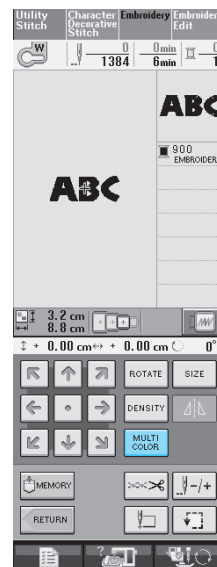

2 After a character is sewn, change the thread color, and then sew the next character.

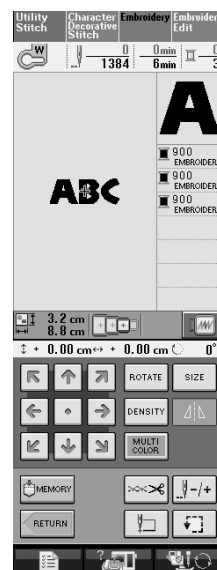

USING THE MEMORY FUNCTION

Embroidery Data Precautions

Observe the following precautions when using embroidery data other than that created and saved in this machine.

CAUTION

- When using embroidery data other than our original patterns, the thread or needle may break when sewing with a stitch density that is too fine or when sewing three or more overlapping stitches. In that case, use one of our original data design systems to edit the embroidery data.

■ Types of Embroidery Data that can be Used

- Only .pes,.pha,.phb,.phc, and .dst embroidery data files can be used with this machine. Using data other than that saved using our data design systems or sewing machines may cause the embroidery machine to malfunction.

■ Types of USB Devices/Media that can be Used

Stitch data can be saved to or recalled from USB media. Use media that meets the following specifications.

- USB Floppy disk drive
- USB Flash drive (USB Flash memory).

Stitch data can be recalled only.

- USB CD-ROM, CD-R, CD-RW drives

You can also use the following types of USB media with the USB Memory Card Reader/Writer.

- Secure Digital (SD) Card
- CompactFlash
- Memory Stick
- Smart Media
- Multi Media Card (MMC)
- XD-Picture Card



Note

- Some USB media may not be usable with this machine. Please visit our website for more details.
- The access lamp will begin blinking after inserting USB Devices/Media, and it will take about 5 to 6 seconds to recognize the Devices/Media. (Time will differ depending on the USB Device/Media).



Memo

- When a file folder is necessary to create, use a computer.
- Letters and numerals can be used in the file names. In addition, if the file name contains no more than eight characters, the entire file name will appear on the screen. If the file name is more than eight characters long, only the first six characters followed by “~” and a number appear as the file name.



5

Embroidery

■ Computers and Operating Systems with the Following Specifications can be Used

- Compatible models:
IBM PC with a USB port as standard equipment
IBM PC-compatible computer equipped with a USB port as standard equipment
- Compatible operating systems:
Microsoft Windows 98SE/Me/2000/XP/Windows Vista/7
(Windows 98SE requires a driver. Download the driver from our Web site (www.brother.com). In addition, only Windows 98 Second Edition can use the driver.)

■ Precautions on Using the Computer to Create and Save Data

- If the name of the embroidery data file/folder cannot be identified, for example, because the name contains special characters, the file/folder is not displayed. If this occurs, change the name of the file/folder. We recommend using the 26 letters of the alphabet (uppercase and lowercase), the numbers 0 through 9, "-", and "_".
- If embroidery data larger than 300 mm (H) × 180 mm (W) (approx. 12 inches (H) × 7 inches (W)) is selected, a message is shown asking if you wish to rotate the pattern 90 degrees. Even after being rotated 90 degrees, embroidery data larger than 300 mm (H) × 180 mm (W) (approx. 12 inches (H) × 7 inches (W)) cannot be used. (All designs must be within the 300 mm (H) × 180 mm (W) (approx. 12 inches (H) × 7 inches (W)) design field size.)
- .pes files saved with the number of stitches or the number of colors exceeding the specified limits cannot be displayed. Use one of our original data design systems to edit the embroidery pattern so that it meets the specifications.
- Embroidery data stored in a folder created in USB media can be retrieved.
- Do not create folders in "Removable Disk" on a computer. If embroidery data is stored in a folder in "Removable Disk", that embroidery data cannot be retrieved by the machine.
- Even if the embroidery unit is not attached, the machine will manage embroidery data.

■ Tajima (.dst) Embroidery Data

- .dst data is displayed in the pattern list screen by file name (the actual image cannot be displayed). Only the first eight characters of the file name can be displayed.
- Since Tajima (.dst) data does not contain specific thread color information, it is displayed with our default thread color sequence. Check the preview and change the thread colors as desired.

■ Trademarks

- Secure Digital (SD) Card is a registered trademark or a trademark of SD Card Association.
- CompactFlash is a registered trademark or a trademark of Sandisk Corporation.
- Memory Stick is a registered trademark or a trademark of Sony Corporation.
- Smart Media is a registered trademark or a trademark of Toshiba Corporation.
- Multi Media Card (MMC) is a registered trademark or a trademark of Infineon Technologies AG.
- xD-Picture Card is a registered trademark or a trademark of Fuji Photo Film Co. Ltd.
- IBM is a registered trademark or a trademark of International Business Machines Corporation.
- Microsoft and Windows are registered trademarks or trademarks of Microsoft Corporation.

Each company whose software title is mentioned in this manual has a Software License Agreement specific to its proprietary programs.

All other brands and product names mentioned in this manual are registered trademarks of their respective companies. However, the explanations for markings such as ® and ™ are not clearly described within the text.

Saving Embroidery Patterns in the Machine's Memory

You can save embroidery patterns that you have customized and will use often; for example, your name, patterns that have been rotated or had the size changed, patterns that have had the sewing position changed, etc. You can save up to 20 patterns.



Note

- Do not turn the main power to OFF while the "Saving" screen is displayed. You will lose the pattern you are saving.



Memo

- It takes a few seconds to save a pattern to the machine's memory.
- See page 191 for information on retrieving a saved pattern.

- 1 Press  when the pattern you want to save is in the sewing screen.

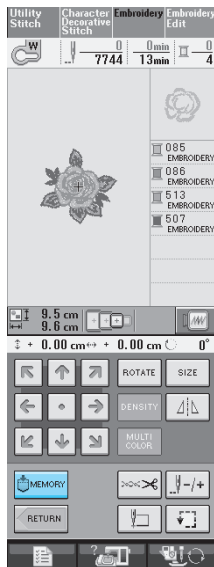

- 2 Press .

- * Press  to return to the original screen without saving.

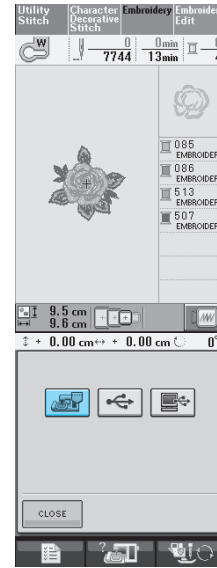

- The "Saving" screen is displayed. When the pattern is saved, the display returns to the original screen automatically.

■ If the Memory is Full

If the screen below displays, either the maximum number of patterns have been saved or the pattern you want to save takes a lot of memory, and the machine cannot save it. If you delete a previously saved pattern, you can save the current pattern.

- 1 Press .

- * Press  to return to the original screen without saving.

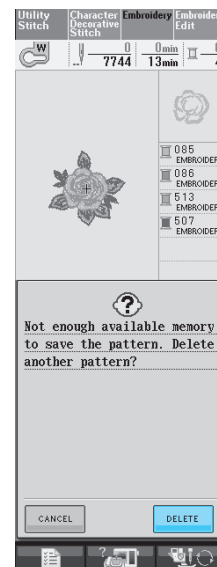

- The machine displays the patterns currently saved.



5

Embroidery

2 Select the pattern you want to delete.



3 Press **DELETE**.

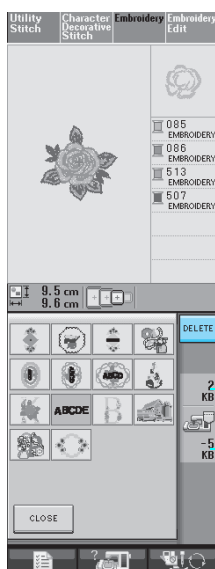

- ① Amount of memory used by the pattern to be deleted
- ② Amount of memory needed to save the current pattern

4 Press **OK**.

* If you decide not to delete the pattern, press

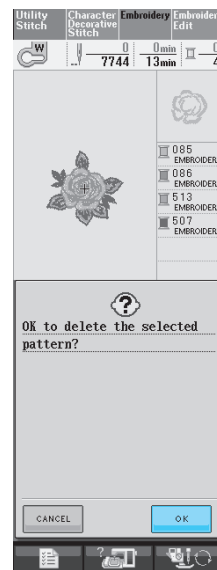

→ The "Saving" screen displays. When the pattern is saved, the display returns to the original screen automatically.



Note

- Do not turn the main power to OFF while the "Saving" screen is displayed. You will lose the pattern you are saving.



Memo

- If there is enough memory available after deleting the pattern, the pattern you want to save will be saved automatically. If there is not enough memory available after deleting the pattern, repeat the steps above to delete another pattern from the machine's memory.
- It takes a few seconds to save a pattern.
- See page 191 for more information about retrieving saved patterns.

Saving Embroidery Patterns to USB Media (Commercially Available)

When sending embroidery patterns from the machine to USB media, plug the USB media into the machine's USB port. Depending on the type of USB media being used, either directly plug the USB device into the machine's USB port or plug the USB Card Writer/Reader into the machine's USB port.



Memo

Some USB media may not be usable with this machine. Please visit our web site for more details.

1

Press  when the pattern you want to save is in the sewing screen.



2

Insert the USB media into the USB port connector on the machine.

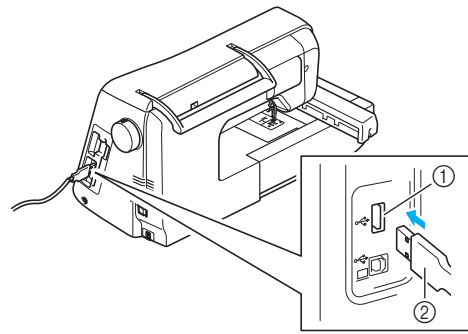

- ① USB port connector for media
- ② USB media



Memo

- The USB media can be inserted or removed at any time.
- Do not insert anything other than USB media into the USB media port connector. Otherwise, the USB media drive may be damaged.

3

Press .

- * Press  to return to the original screen without saving.

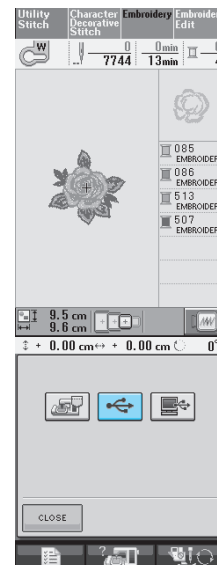

→ The "Saving" screen is displayed. When the pattern is saved, the display returns to the original screen automatically.



5

Embroidery

Saving Embroidery Patterns in the Computer

Using the included USB cable, the machine can be connected to your computer, and the embroidery patterns can be temporarily retrieved from and saved in your computer.



Note

- Do not turn the main power to OFF while the “Saving” screen is displayed. You will lose the pattern you are saving.

1 Plug the USB cable connector into the corresponding USB port connectors for the computer and for the machine.

- * The USB cable can be plugged into the USB port connectors on the computer and embroidery machine whether or not they are turned on.

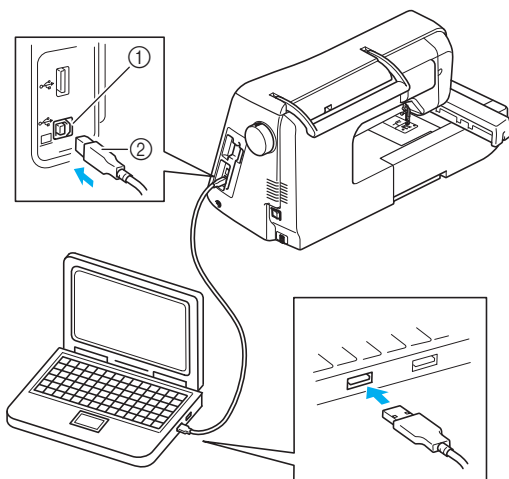

- ① USB port connector for computer
- ② USB cable connector

→ The “Removable Disk” icon will appear in “My Computer” on the computer.



Note

- The connectors on the USB cable can only be inserted into a connector in one direction. If it is difficult to insert the connector, do not insert it with force. Check the orientation of the connector.
- For details on the position of the USB port on the computer (or USB hub), refer to the instruction manual for the corresponding equipment.

2 Press  when the pattern you want to save is in the sewing screen.

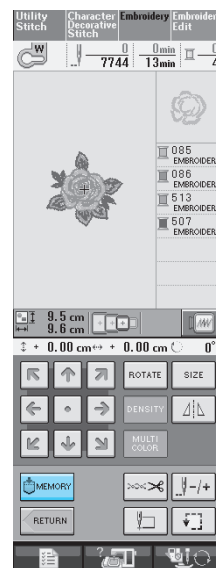

3 Press .

- * Press  to return to the original screen without saving.

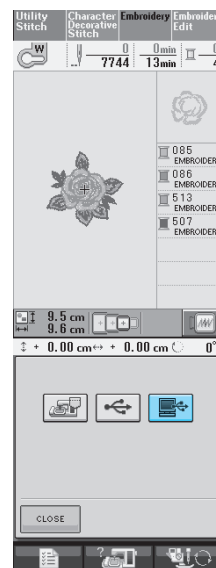

→ The pattern will be temporarily saved to “Removable Disk” under “My Computer”.

4 Select the pattern's .phc file in “Removable Disk” and copy the file to the computer.

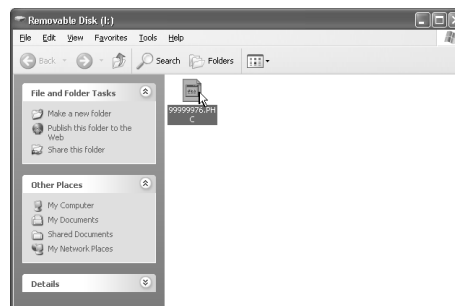

Retrieving Patterns from the Machine's Memory

1 Press .

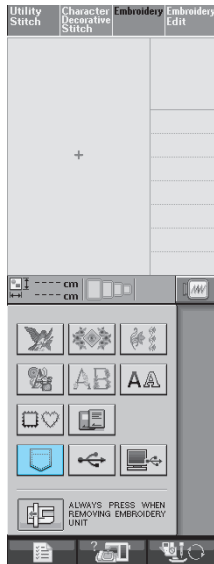

→ The machine displays the patterns currently in the memory.

2 Press the key of the pattern you want to retrieve.

* Press  to return to the original screen.

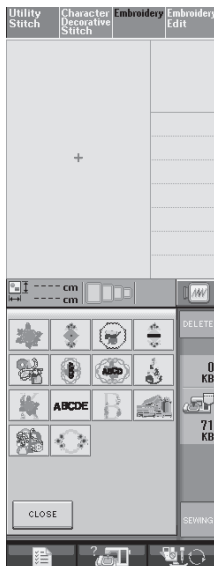

3 Press .

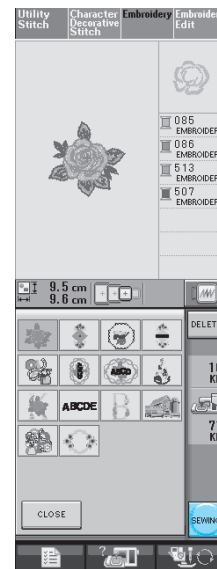

→ The sewing screen is displayed.

Recalling from USB Media

You can recall a specific embroidery pattern from either direct USB media or a folder in the USB media. If the pattern is in a folder, check each folder to find the embroidery pattern.

1 Insert the USB media into the USB port connector on the machine (see page 189).

2 Press .

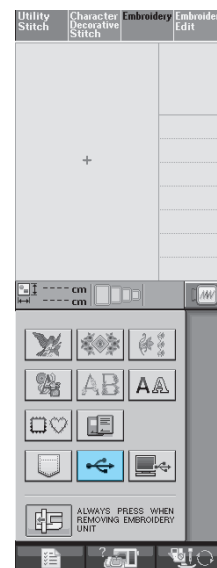

→ Embroidery patterns and a folder in a top folder are displayed.



Embroidery

3 Press  when there is a subfolder to sort two or more stitch patterns to USB media, the embroidery pattern in the subfolder is displayed.

* Press  to return to the original screen without recalling.

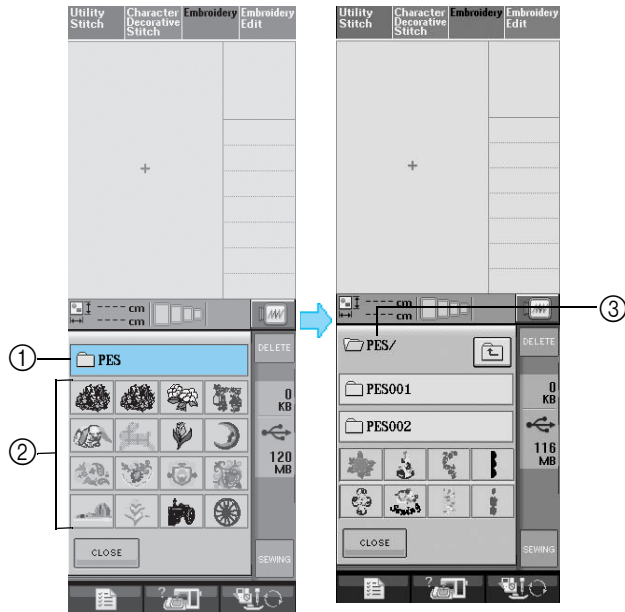

- ① Folder name
- ② Embroidery patterns in a folder
- ③ Path

→ The path to shows the current folder at the top of the list. Embroidery patterns and subfolders within a folder are displayed.

* Press  to return to the previous folder.

4 Press the key of the pattern you want to retrieve.

* Press  to return to the original screen.

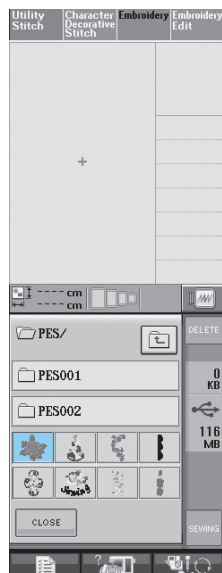

5 Press .

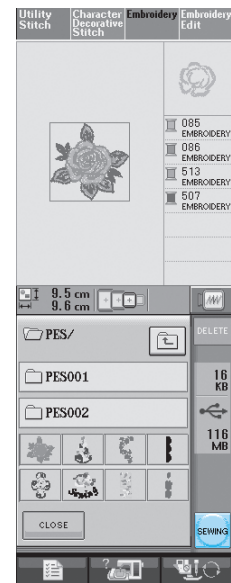

→ The sewing screen is displayed.

Recalling from the Computer

- 1** Plug the USB cable connector into the corresponding USB port connectors for the computer and for the machine (see page 190).
- 2** On the computer, open “My Computer” then go to “Removable Disk”.

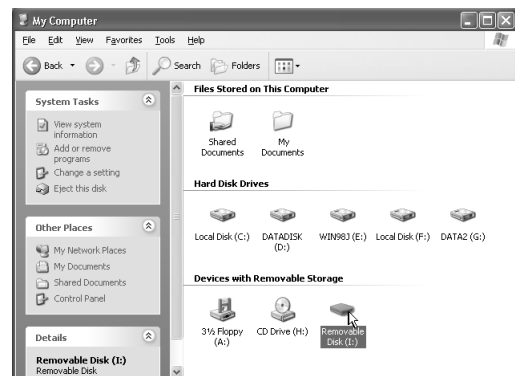

3 Move/copy the pattern data to “Removable Disk”.

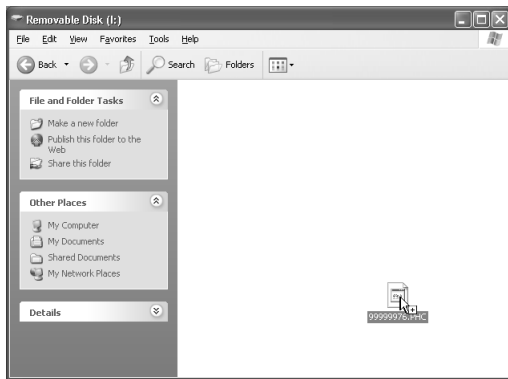

→ Pattern data in “Removable Disk” is written to the machine.



Note

- While data is being written, do not disconnect the USB cable.
- Do not create folders within “Removable Disk”. Since folders are not displayed, stitch pattern data within folders cannot be recalled.

4 Press .

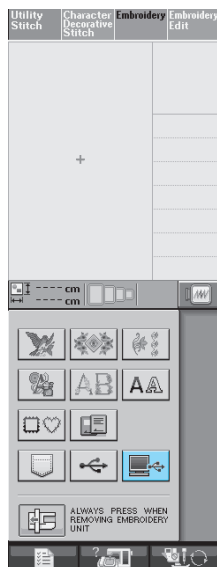

→ The patterns in the computer are displayed on the selection screen.

5 Press the key of the pattern you want to recall.

* Press  to return to the original screen.

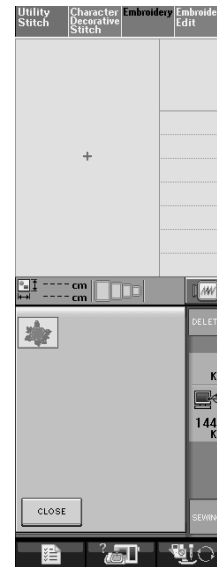

6 Press .

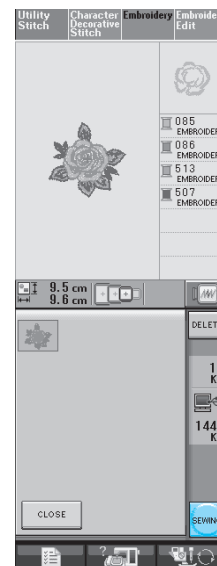

→ The sewing screen is displayed.



5

Embroidery

EMBROIDERY APPLICATIONS

Using a Frame Pattern to Make an Appliqué (1)

You can use framed patterns of the same size and shape to create an appliqué. Embroider one pattern with a straight stitch and one pattern with a satin stitch.

- 1 Select a straight stitch frame pattern. Embroider the pattern onto the appliqué material, then cut neatly around the outside of the shape.

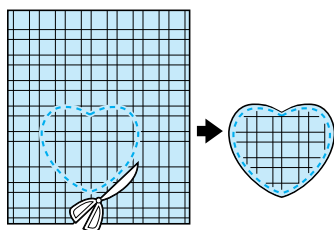
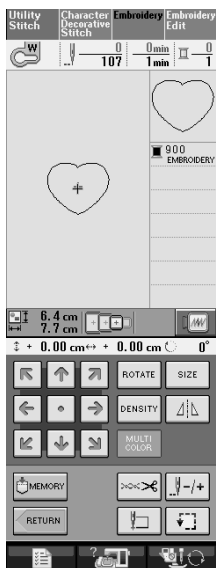

- 2 Embroider the same pattern from step 1 onto the base fabric.

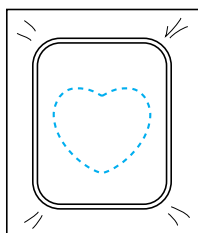

- 3 Apply a thin layer of fabric glue or a temporary spray adhesive to the rear of the appliqué created in step 1. Attach the appliqué to the base fabric matching the shapes.

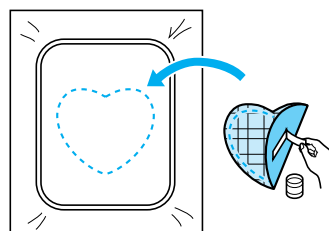

- 4 Select the satin stitch frame pattern of the same shape as the appliqué. Embroider over the appliqué and base fabric from step 3 to create the appliqué.

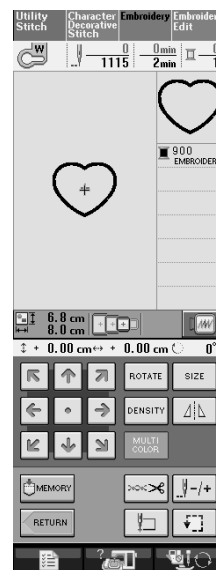

- Note**
- If you change the size or position of the patterns when selecting them, make a note of the size and location.

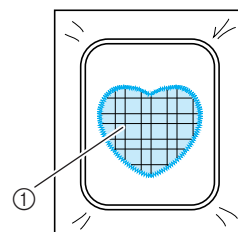

① Appliqué material

Using a Frame Pattern to Make an Appliqué (2)

This is a second method to make appliqué using embroidery patterns. You do not have to change the fabric in the embroidery frame using this method. Embroider one pattern with a straight stitch and one pattern with a satin stitch.

- 1 Select a straight stitch frame pattern, and embroider the pattern onto the base fabric.

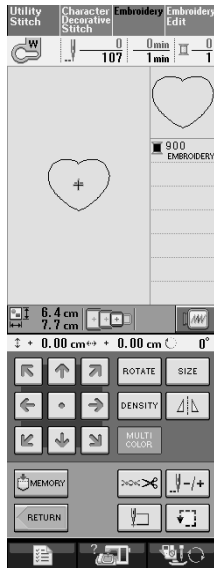

- 2 Place the appliqué fabric over the pattern embroidered in step 1.

* Be sure that the appliqué fabric completely covers the seam.

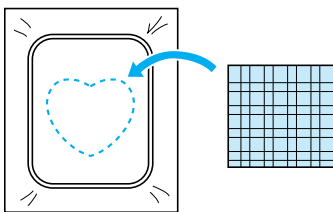

- 3 Embroider the same pattern on the appliqué fabric.

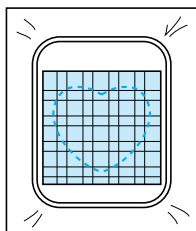

- 4 Remove the embroidery frame from the embroidery unit, and cut around the outside of the stitches.

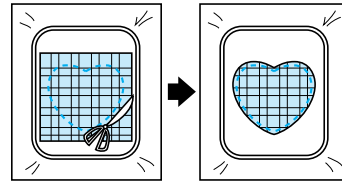

Note

- Do not remove the fabric from the embroidery frame to cut it. Also, do not pull strongly on the fabric. Otherwise, the fabric may loosen in the frame.

- 5 Select the satin stitch frame pattern of the same shape as the appliqué.

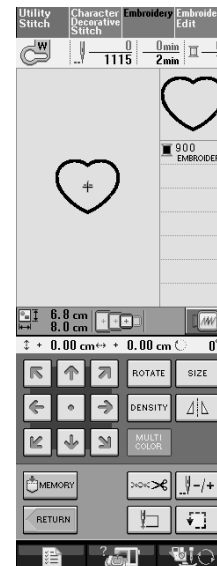

Note

- Do not change the size or position of the pattern.

- 6 Reattach the embroidery frame to the embroidery unit, and embroider the satin stitch pattern to create an appliqué.

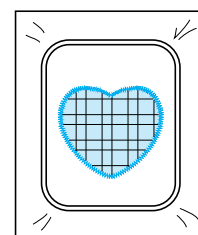

5

Embroidery

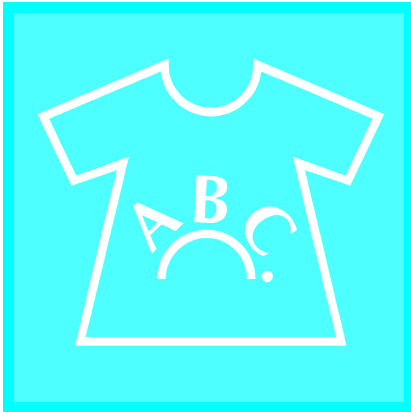

Chapter 6

Embroidery Edit

EXPLANATION OF FUNCTIONS..... 198

SELECTING PATTERNS TO EDIT 199

Selecting Embroidery Patterns/Heirloom Patterns/Border Patterns/Cross stitch
Patterns/Floral Alphabet Patterns/Frame Patterns..... 200
Selecting Alphabet Character Patterns 200

EDITING PATTERNS..... 203

■ Key Functions 204
Moving the Pattern..... 205
Rotating the Pattern 205
Changing the Size of the Pattern 206
Deleting the Pattern 207
Changing the Configuration of Alphabet Character Patterns..... 207
Changing Alphabet Character Spacing 207
Reducing Character Spacing 208
Changing the Color of Each Alphabet Character in a Pattern..... 209
Changing the Thread Color 209
Creating a Custom Thread Table 210
■ Adding a Color to the Custom Thread Table from the List 211
Choosing a Color from the Custom Thread Table 212
Designing Repeated Patterns..... 213
■ Sewing Repeated Patterns 213
■ Repeating One Element of a Repeated Pattern 215
■ Assigning Thread Marks..... 216
After Editing 217
■ Color Sorting Repeated Patterns..... 218

COMBINING PATTERNS..... 219

Editing Combined Patterns 219
■ Selecting combined embroidery patterns 221
Sewing Combined Patterns..... 222

USING THE MEMORY FUNCTION 223

EXPLANATION OF FUNCTIONS

With the Embroidery Edit functions, you can combine embroidery patterns and character patterns, change the size of patterns, rotate patterns, and perform many other editing functions. This machine can perform the 9 functions listed below.

■ Combine Patterns

You can easily create combinations of embroidery patterns, frame patterns, character patterns, patterns from the machine's memory, patterns from separately sold embroidery cards, and many other patterns.

■ Move Patterns

Within the 30 cm × 18 cm (approx. 12 inches × 7 inches) wide embroidery area, you can change the position of patterns, and check the position on the LCD.

■ Rotate Patterns

You can rotate patterns one degree, ten degrees or ninety degrees at a time.

■ Enlarge or Reduce Patterns

You can make patterns larger or smaller.

- This function is not available for some patterns.

■ Create Mirror Images

You can create horizontal mirror images.

- This function is not available for some patterns.

■ Change Alphabet Character Spacing

You can increase or decrease the spacing between characters in combined patterns.

■ Change Alphabet Character Appearance/Layout

You can change the layout of the characters to a curved line, diagonal, etc. There are 6 choices total.

■ Change the Thread Colors of Patterns

You can change the thread colors of the pattern to your favorite colors.

■ Creating a Repeating Pattern

You can add copies of a pattern to create a pattern that repeats in a vertical or horizontal direction.

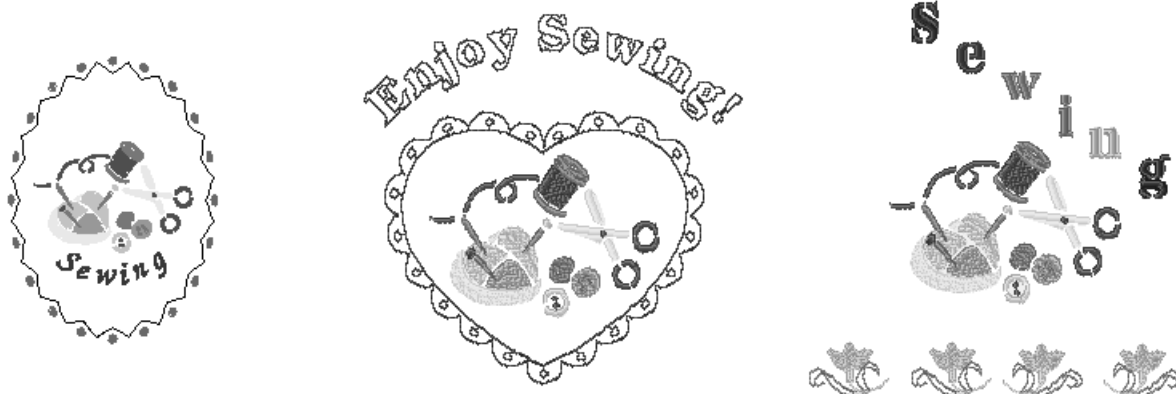

SELECTING PATTERNS TO EDIT

Prepare the machine for embroidery according to the instructions on page 144, and press **Embroidery Edit** to display the screen below.

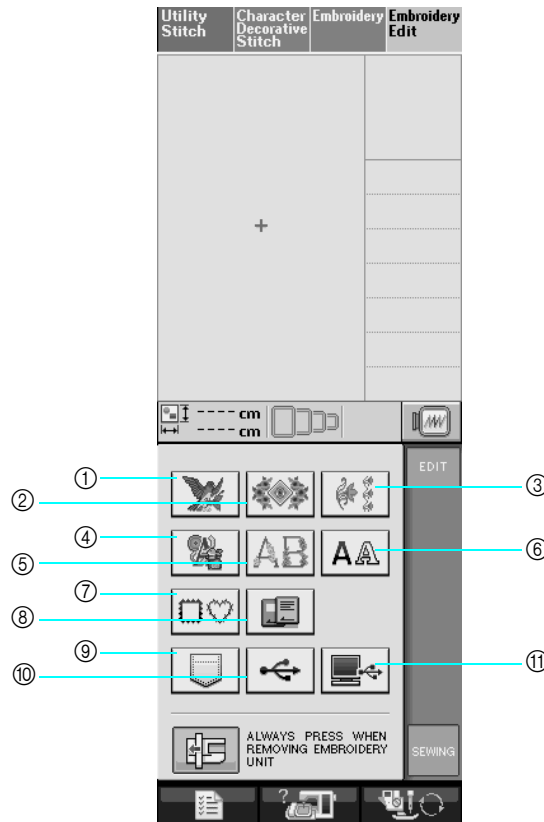

- ① Embroidery patterns
- ② Heirloom patterns
- ③ Border patterns
- ④ Cross stitch patterns
- ⑤ Floral alphabet patterns
- ⑥ Alphabet character patterns
- ⑦ Frame patterns
- ⑧ Patterns from an embroidery card (sold separately)
- ⑨ Patterns saved in the machine's memory (see page 191)
- ⑩ Patterns saved in USB media (see page 191)
- ⑪ Patterns saved on the computer (see page 192)



Memo

See page 150 for more information on each category's selection screen.



Note

You can also sew Utility Stitches or Character/Decorative Stitches with the embroidery unit attached by pressing **Utility Stitch** or **Character Decorative Stitch** (a confirmation message for moving the carriage will appear). Raise the feed dogs, and then attach the appropriate presser foot before sewing.



6

Embroidery Edit

Selecting Embroidery Patterns/ Heirloom Patterns/Border Patterns/Cross stitch Patterns/ Floral Alphabet Patterns/Frame Patterns

- 1 Select the category of the pattern.
- 2 Press the key of the pattern you want to edit.
 - * See pages 151 and 153 for more information on selecting patterns.
 - The pattern is displayed in the top part of the screen.

- 3 Press **SET**.

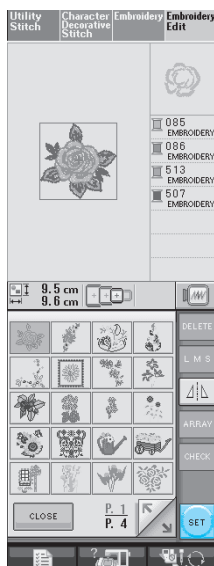

→ The pattern selected for editing is outlined in red on the embroidery edit display.

- 4 Proceed to see “EDITING PATTERNS” on page 203 to edit the pattern.

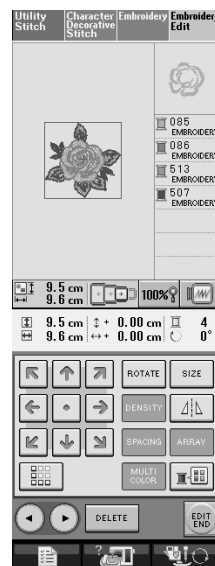

Selecting Alphabet Character Patterns

When you select character patterns from the embroidery edit screen, you can edit the appearance of the pattern at the same time.

- 1 Press **AA**.

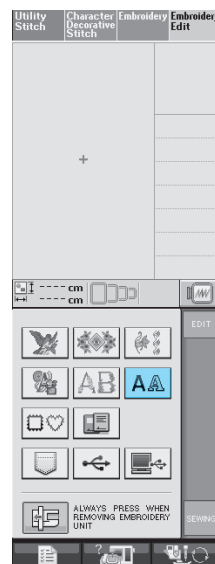

2 Select the font, then enter the characters.
(Example: A B C D)

* See page 152 for more information about selecting characters.

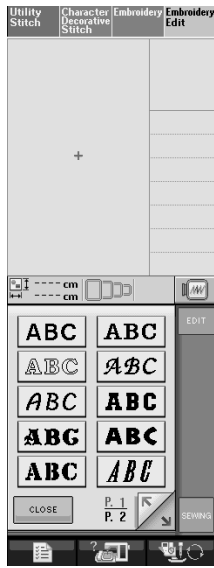



3 Press **ARRAY** to change the layout of the pattern.

* If the characters are too small to see, press **CHECK** to view a display of all entered characters.







4 Select the layout. (Example: )

When selecting an arc, use  and  to change the degree of the arc.

- * Press  to make the arc flatter.
- * Press  to make the arc rounder.

Memo

When selecting ,  and  change to  and . You can increase or decrease the incline.



6

Embroidery Edit

5 Press  to return to the original screen.

6 After you finish your selections, press



→ The embroidery edit screen will appear.

7 Proceed to see “EDITING PATTERNS” on page 203 to edit the pattern.

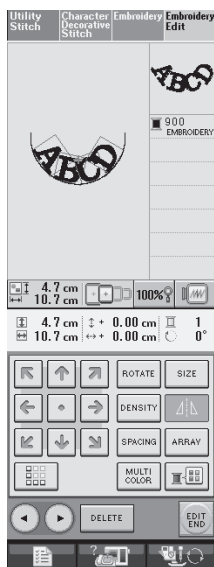

EDITING PATTERNS

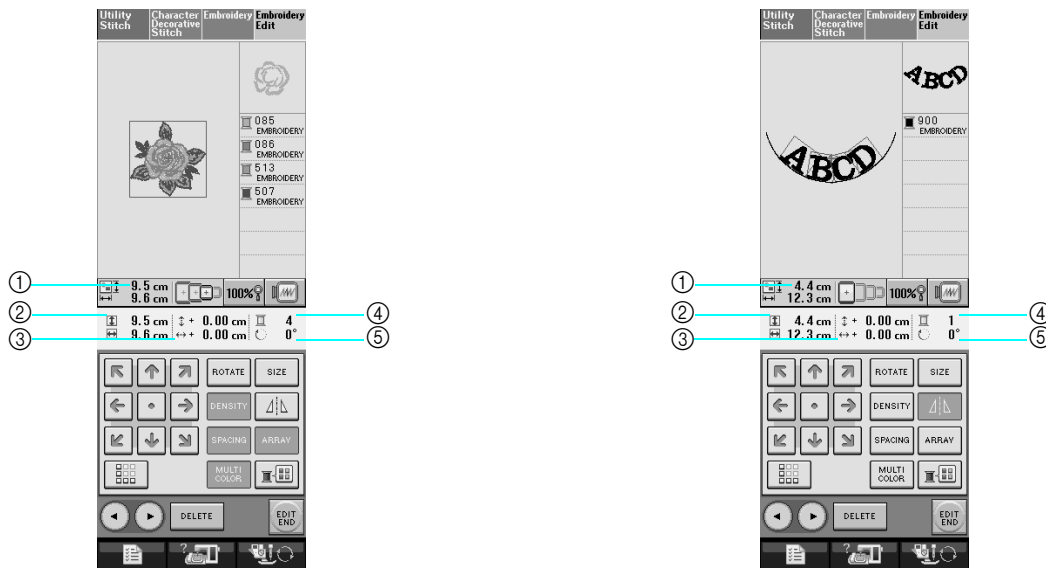

- ① Shows the size of the entire combined pattern.
- ② Shows the size of the pattern currently selected.
- ③ Shows the distance from the center of the frame.
- ④ Shows the number of colors in the pattern currently selected.
- ⑤ Shows the degree of rotation for the pattern.











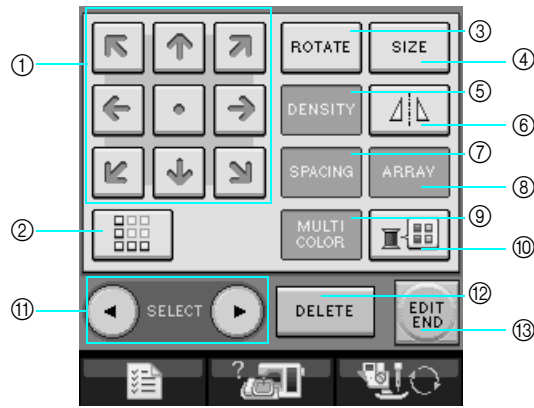

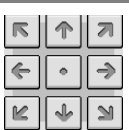



Memo

If a key display is light gray, you cannot use that function with the selected pattern.





■ Key Functions



No.	Display	Key Name	Explanation	Page
①		Arrow keys ( Center key)	Press these keys to move the pattern in the direction indicated by the arrow on the key. (Press  to return the pattern to its original position.)	205
②		Border key	Press this key to make a repeating pattern.	213
③		Rotate key	Press this key to rotate the pattern. You can rotate a pattern one degree, ten degrees or ninety degrees at a time.	205
④		Size key	Press this key to change the size of the pattern. Patterns can be enlarged or reduced.	206
⑤		Density key	Press this key to change the density of frame patterns or character patterns.	183
⑥		Horizontal mirror image key	Press this key to make a horizontal mirror image of the selected pattern.	183
⑦		Character spacing key	Press this key to change the spacing of character patterns.	207
⑧		Array key	Press this key to change the configuration of a character pattern.	207
⑨		Multi color key	Press this key to change the color of individual characters in a pattern.	209
⑩		Thread palette key	Press this key to change the colors of the displayed pattern.	209
⑪		Pattern select key	When a combined pattern is selected, use these keys to select a part of the pattern to edit.	—
⑫		Delete key	Press this key to delete the selected pattern (the pattern outlined by the red box).	207
⑬		Edit end key	Press this key to continue to the next step.	217

Moving the Pattern

Press  to move the pattern in the direction shown on the key.

Press  to return the pattern to the center.

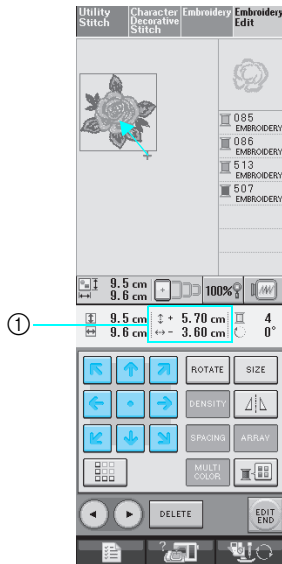





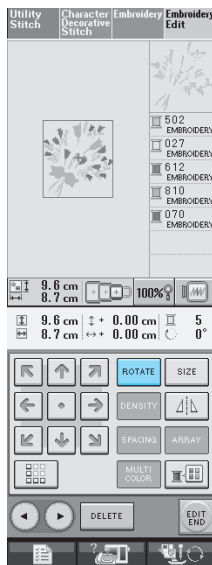

① Distance from the center

Rotating the Pattern

1 Press .



2 Select the angle by which the pattern is rotated.

- * Press  to rotate the pattern 90 degrees to the left.
- * Press  to rotate the pattern 90 degrees to the right.
- * Press  to rotate the pattern 10 degrees to the left.
- * Press  to rotate the pattern 10 degrees to the right.
- * Press  to rotate the pattern 1 degree to the left.
- * Press  to rotate the pattern 1 degree to the right.
- * Press  to return the pattern to its original position.

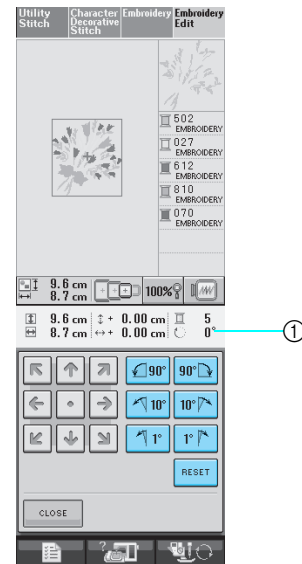

① Degree of the pattern's rotation



6

Embroidery Edit

3 Press **CLOSE** to return to the original screen.

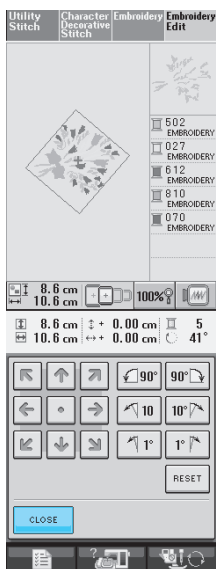





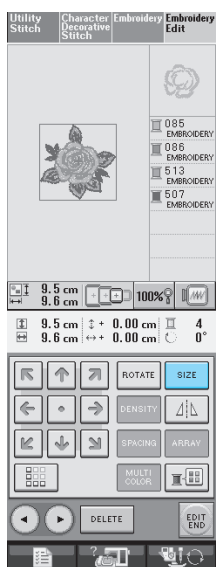

Changing the Size of the Pattern

1 Press **SIZE**.



2 Select the direction in which to change the size.

- * Press  to enlarge the pattern proportionately.
- * Press  to shrink the pattern proportionately.
- * Press  to stretch the pattern horizontally.
- * Press  to compact the pattern horizontally.
- * Press  to stretch the pattern vertically.
- * Press  to compact the pattern vertically.
- * Press  to return the pattern to its original appearance.

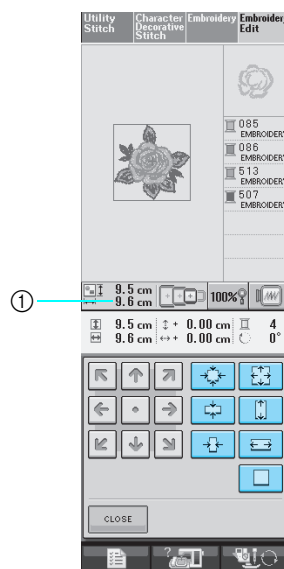

① Shows the size of the pattern being edited.

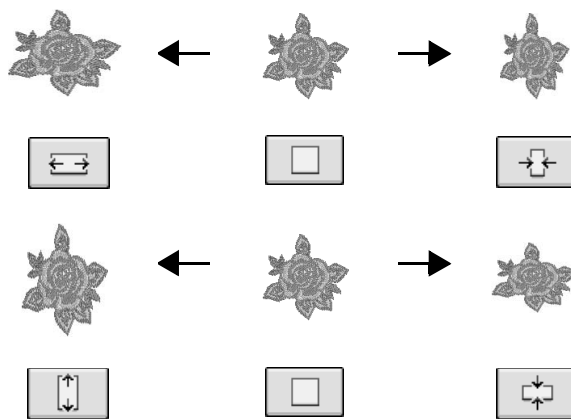

3 Press **CLOSE** to return to the original screen.

Deleting the Pattern

Press **DELETE** to delete the pattern from the screen.

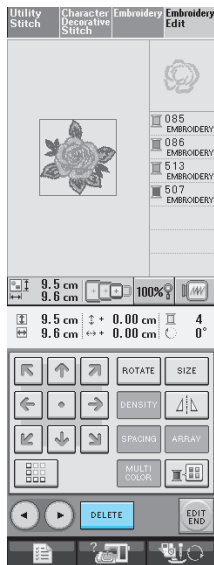

2 Press the key of the layout you want to embroider.

* See page 201 for more information about layout types.

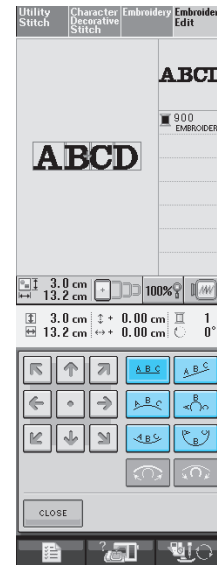

→ The display will show the selected layout.

3 Press **CLOSE**.

Changing the Configuration of Alphabet Character Patterns

1 Press **ARRAY**.

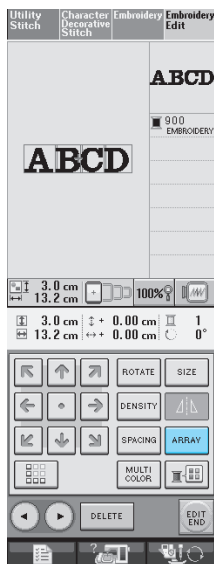

Changing Alphabet Character Spacing

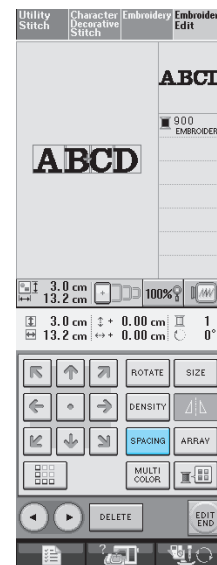

1 Press **SPACING**.



6

Embroidery Edit

2 Use  or  to change the spacing.

- * Press  to widen the character spacing.
- * Press  to tighten the character spacing.
- * Press  to return the pattern to its original appearance.

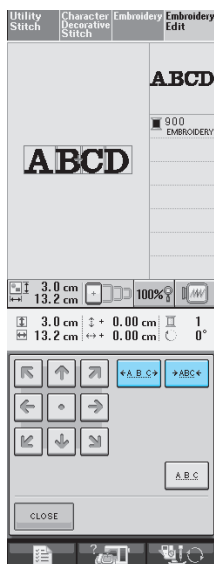

A B C D ↔ ABCD



3 Press  to return to the original screen.

Reducing Character Spacing

The spacing between characters can be reduced to 50% of the narrowest character in the group.



Note

- It is not recommended to edit data and transfer to other or older version machines. Same features do not apply in other machines, so problems may occur.
- Character spacing can be reduced only when characters are arranged normally on a straight line.

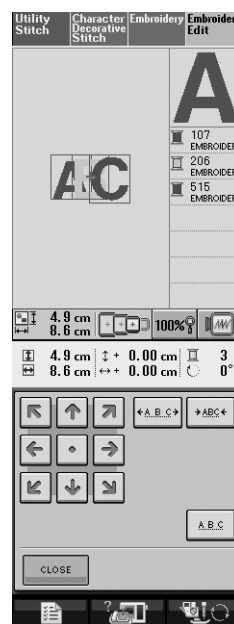
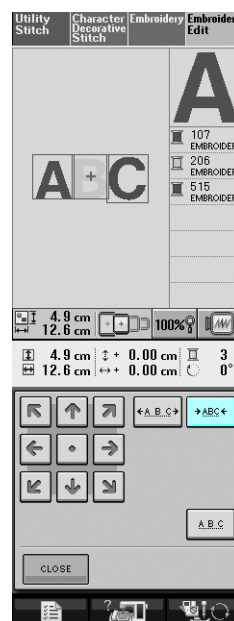

Changing the Color of Each Alphabet Character in a Pattern

- 1 Press  so you can assign a thread color to each character.

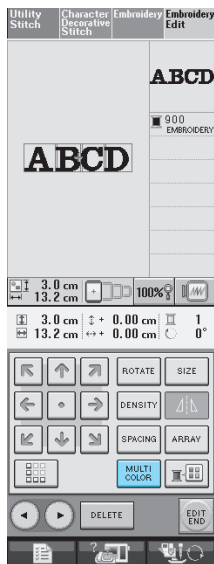

- 2 Change the thread to sew each character in a different color.

- * Press  to change the colors in the sewing order.

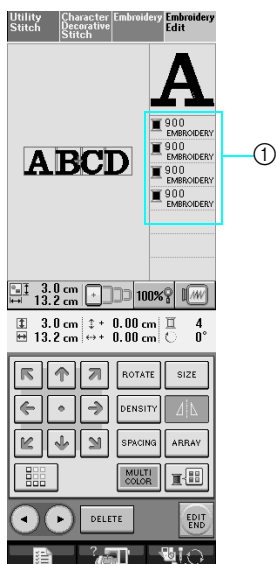

- 1 Color for each character



Changing the Thread Color

You can change the thread color by moving the color to be changed to the top of the sewing order and selecting a new color from the thread colors in the machine.

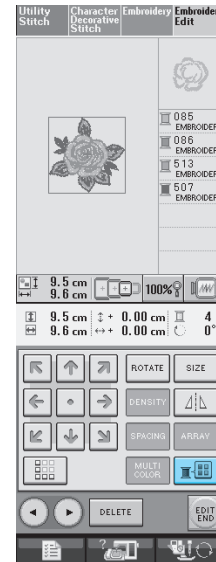
- 1 Press .



→ The thread color palette screen displays.

- 2 Press  or  to put the color you want to change at the top of the sewing order.

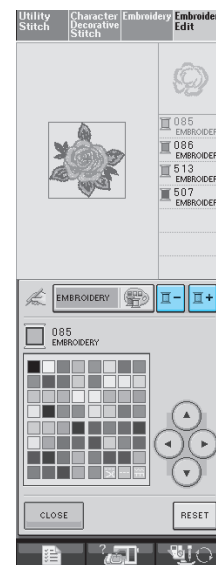

6

Embroidery Edit

3 Press     to choose a new color from the color palette.

- * To return to the original color, press . If multiple colors have been changed, this command will return all colors to their original colors.
- * You can select colors from the color palette by directly touching the color selection with the touch pen.

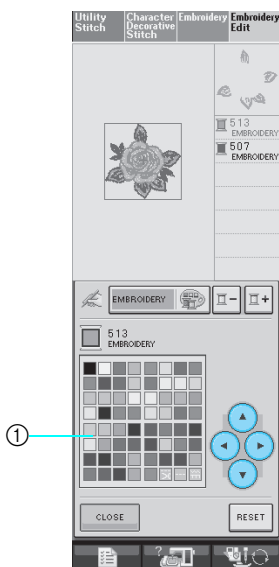

- ① Color palette
- The selected color appears at the top of the sewing order.

4 Press .

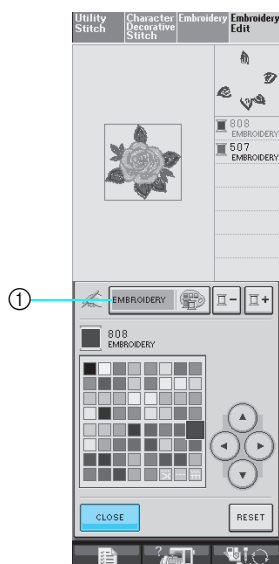

- ① Color palette/Custom thread table change key
- The display shows the changed colors.





Memo
To select a color from the Custom Thread Table, see “Choosing a Color from the Custom Thread Table” on page 212.

Creating a Custom Thread Table

You can create a custom thread table containing the thread colors that you most often use. You can select thread colors from the machine’s extensive list of thread colors from nine different thread brands. You can select any color and move the color to your custom thread table.





- Note**
- Some machines may already have an additional 300 Robison-Anton thread colors contained in the custom thread table.
 - You have the option to completely clear, or to restore the Custom Thread Table to the original factory setting. Visit the website for Custom Thread Table Clear/Restore Program and instructions.

1 Press , and then press .

Press  to display P. 5.

2 Use     to select where to add a color on the custom thread table.

- * You can also touch the palette directly with the touch pen.
- * You can scroll through 100 colors at a time using  and  on the custom thread table.

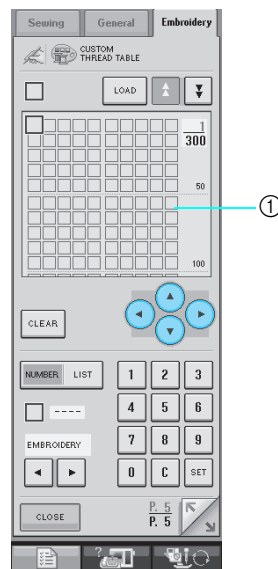

- ① Custom thread table

3 Use **◀ ▶** to select one of the thread brands in the machine.

4 Use **1 2 3 4 5 6 7 8 9 0** to enter a color's 4-digit number.

* If you make a mistake, press **C** to erase the entered number, and then enter the correct number.

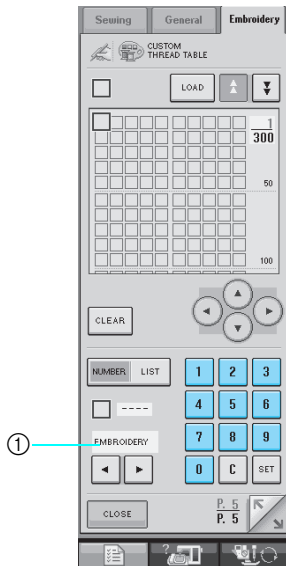

① Thread brand

5 Press **SET**.

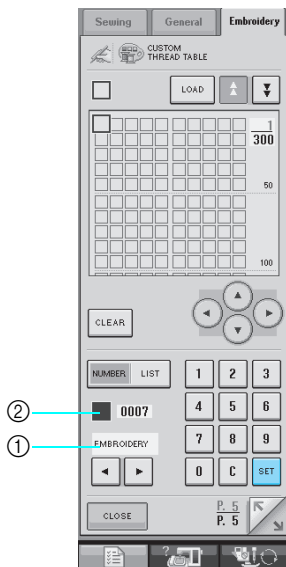

① Thread brand
② Entered number

→ The selected thread color is set in the custom thread table.

Note

- If **SET** is not pressed, the thread color number will not be changed.

6 Repeat the previous steps until all desired thread colors are specified.

* To delete a specified color from the palette, press **CLEAR**.

7 Press **CLOSE** to return to the original screen.

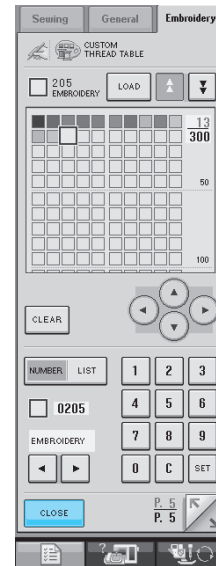

■ Adding a Color to the Custom Thread Table from the List

1 Repeat the previous steps ① through ③.

2 Press **NUMBER LIST** to display the thread list.

3 Use **▲ ▼** to select a thread color.

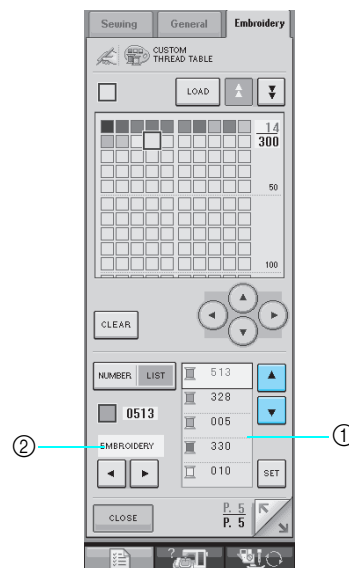

① Thread list
② Thread brand



6

Embroidery Edit

4 Press **SET**.

5 Repeat the previous steps until all desired thread colors are specified.

* To delete a specified color from the palette, press

CLEAR.

6 Press **CLOSE** to return to the original screen.

Choosing a Color from the Custom Thread Table

You can select a color from the up to 300 thread colors you have set in the custom thread table.

1 Press **EMBROIDERY**.

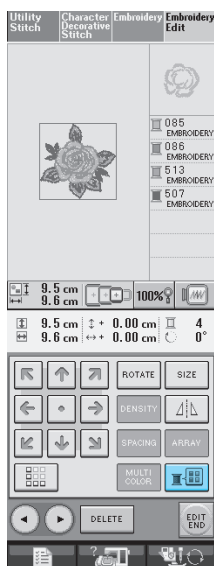

→ The thread color palette screen displays.

2 Press **+** or **-** to put the color you want to change at the top of the sewing order.

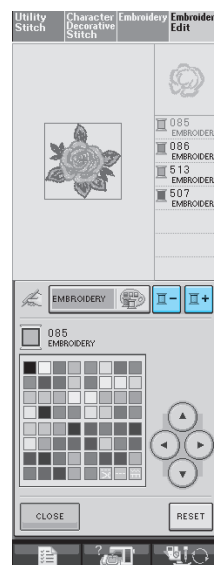

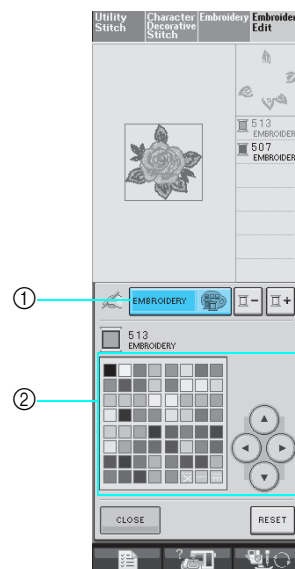

3 Press **EMBROIDERY**.



- ① Color palette/Custom thread change key
- ② Color palette

→ The custom thread table will appear.

4 Press     to choose a new color from the custom thread table.

- * Use  and  to scroll through the custom thread table.
- * Press  to return to the original color.
- * You can select colors from the custom thread table by directly touching the screen with the touch pen.

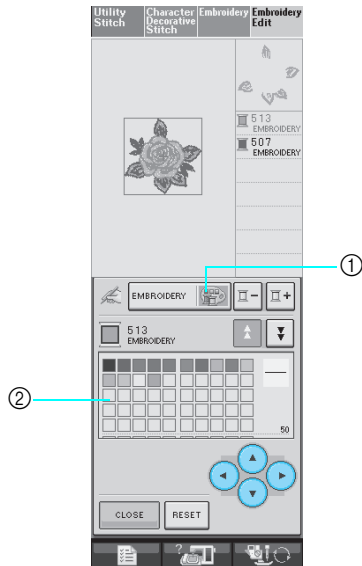

- ① Custom thread
 - ② Custom thread table
- The display shows the changed colors.

5 Press .

Designing Repeated Patterns

■ Sewing Repeated Patterns

Using the border function, you can create stitches using repeated patterns. You can also adjust the spacing of the patterns within a repeated pattern stitch.

1 Select a pattern, and then press .

2 Press .

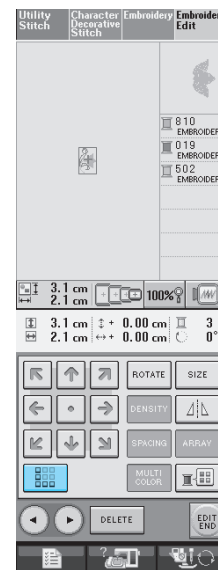



6

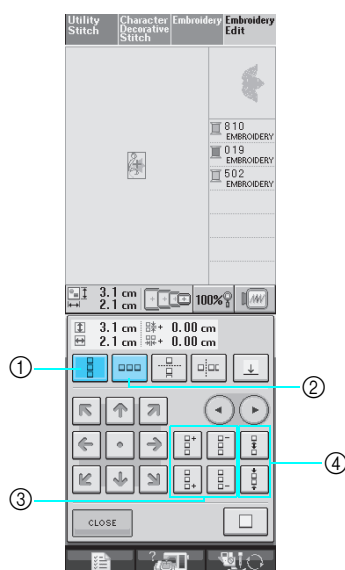

Embroidery Edit

3 Select the direction in which the pattern will be repeated.





- ① Vertical direction
 - ② Horizontal direction
 - ③ Repeating and deleting keys
 - ④ Spacing keys
- The pattern direction indicator will change depending on the direction selected.

4 Use  to repeat the pattern on top and  to repeat the pattern at the bottom.

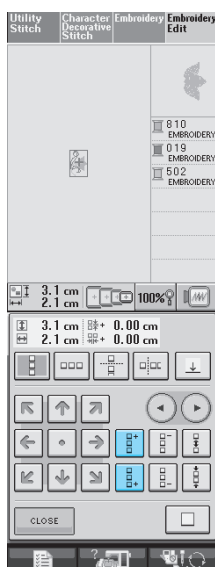
- * To delete the top pattern, press .
- * To delete the bottom pattern, press .



5 Adjust the spacing of the repeated pattern.

- * To widen spacing, press .
- * To tighten spacing, press .

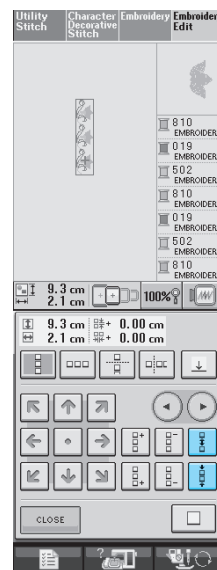

 **Memo**
You can only adjust the spacing of patterns enclosed in the red frame.

6 Complete repeated patterns by repeating steps 3 through 5.

7 Press  to finish repeating.

 **Memo**

- When there are two or more patterns, all patterns will be grouped together as one pattern in the red frame.

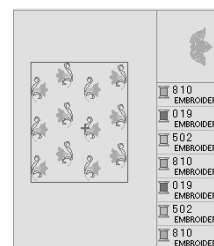



- When changing the direction in which the pattern will be repeated, all of the patterns in the red frame will automatically be grouped as one repeating unit. Press  to change a repeated pattern back to one single pattern. See the following section on how to repeat one element of a repeated pattern.

Repeating One Element of a Repeated Pattern

By using the Cut function, you can select one element of a repeated pattern and repeat only that single element. This function allows you to design complex repeated patterns.

1 Choose the direction in which the repeated pattern will be cut.

- * Press  to cut horizontally.
- * Press  to cut vertically.

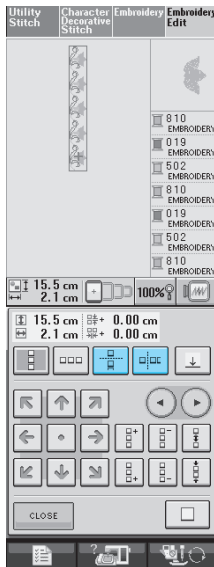

→ The pattern direction indicator will change depending on the direction selected.

2 Use and to select the cut line.

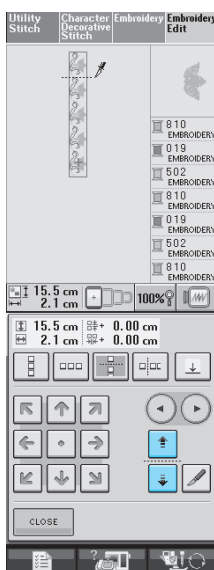

→ The cut line will move.

3 Press .

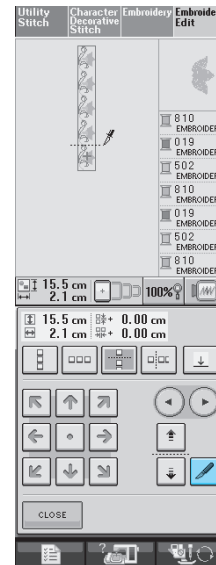

→ The repeated pattern will be divided into separate elements.

4 Use and to select the element to repeat.

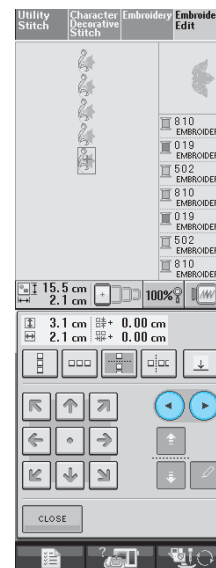

Embroidery Edit

5 Repeat the selected element.

6 Press  to finish repeating.

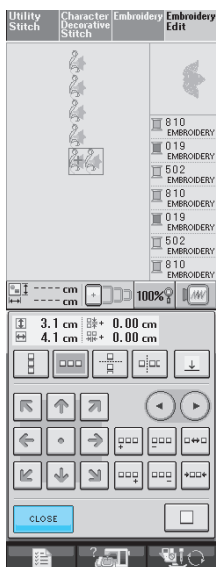

Note

- Once you have cut a repeated pattern into separate elements, you cannot return to the original repeated pattern.
- Each element can be edited separately in the edit screen. See “Selecting combined embroidery patterns” on page 221.

Assigning Thread Marks

By sewing thread marks, you can easily align patterns when sewing a series. When sewing is finished on a pattern, a thread mark in the shape of an arrow will be sewn using the final thread. When sewing a series of patterns, use the point of this arrow for positioning the following designs to be sewn.

Memo

- When repeatedly sewing individual patterns, thread marks can be sewn around the perimeter of the pattern only.

1 Press .



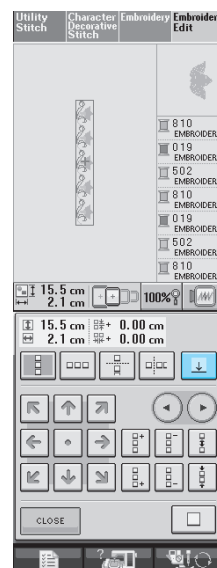

2 Press .

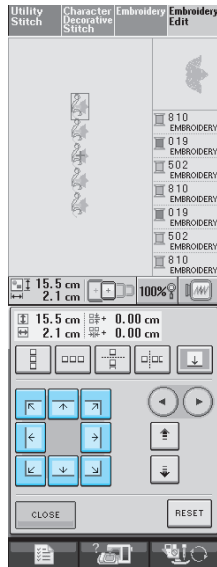

3 Press  to select the thread mark to be sewn.



Memo

- When there are two or more elements, use  and  or  and  to select a pattern that you want to assign a thread mark(s) to.

4 Press .

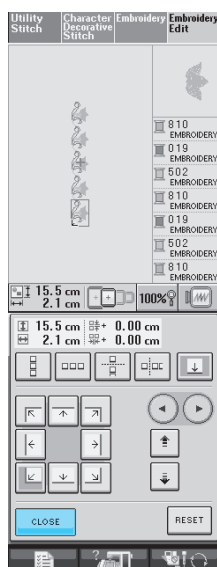

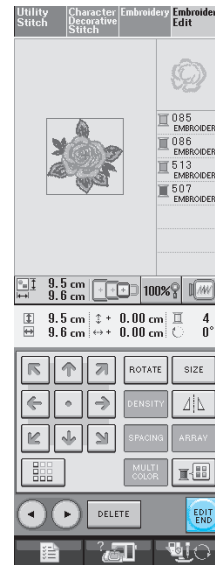

After Editing

1 Press .



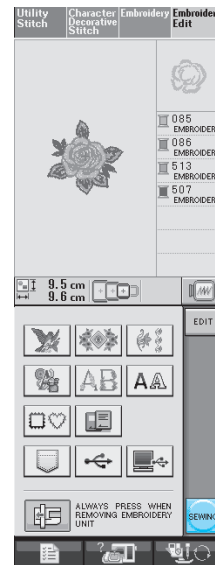

2 If you want to sew the pattern immediately, press  to call up the sewing screen.



- * Press  to return to the embroidery edit screen.
- * To combine the pattern with other patterns, select the next pattern from this screen (see page 219).
- * See page 165 for more information about sewing patterns.

Memo

If you return to the edit screen after pressing , press , then .



Embroidery Edit

Color Sorting Repeated Patterns

Press  to automatically change the sewing order of colors in combined border embroidery patterns so that the same color can be continuously sewn. This allows you to continue sewing without repeatedly changing the upper thread or changing the sewing order manually.

Memo

- In combined stitch patterns that contain two or more border patterns or other patterns combined with border patterns, the sewing order of only the border patterns is changed.
- When a group of two or more patterns using border patterns is repeated, the sewing order is changed so that the same color can be sewn continuously in each pattern.

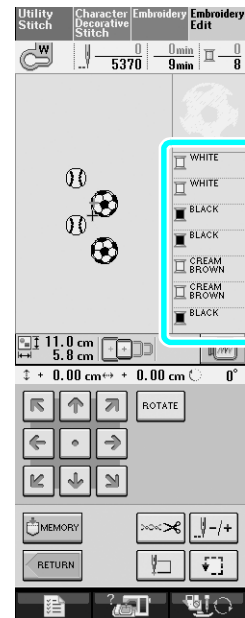
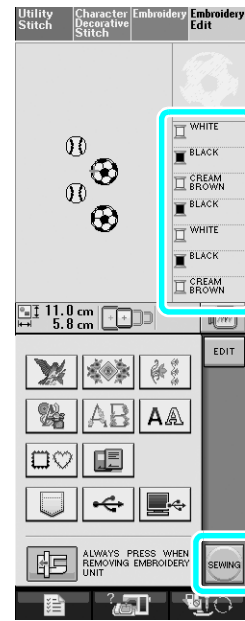
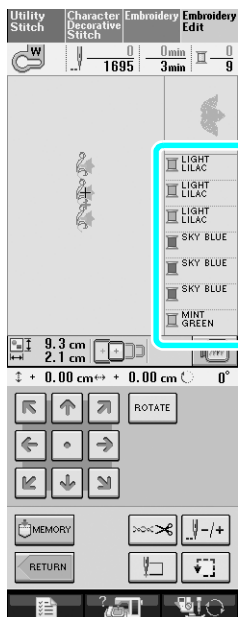
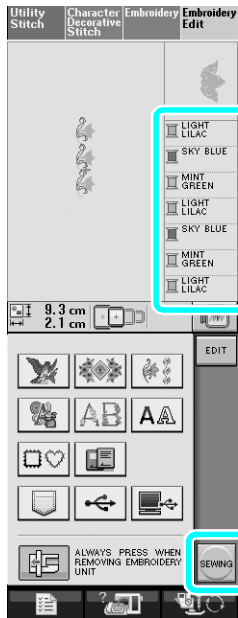

COMBINING PATTERNS

Editing Combined Patterns

Example: Combining alphabet characters with an embroidery pattern and editing



1 Press  to select an embroidery pattern.

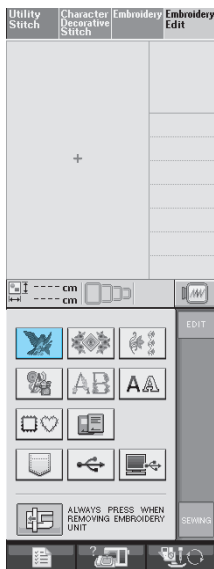

2 Use  to view P.4, then select .

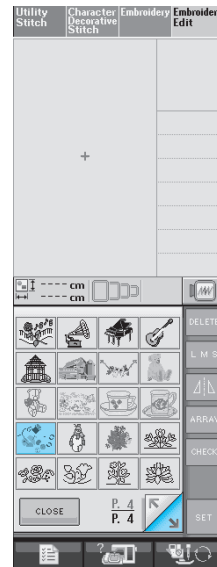

3 Press .

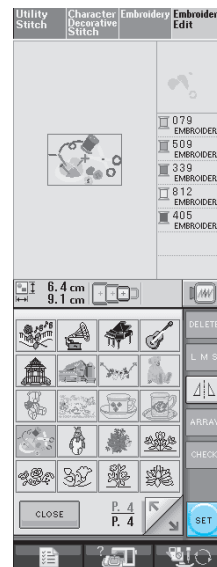

6

Embroidery Edit

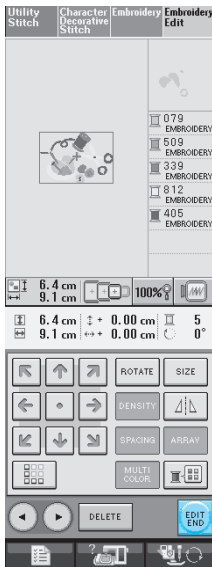

4 Press  .



5 Press  to enter the alphabet characters.



6 Select  and enter "Sewing".

* After selecting  , press  to change the character size to M, then enter the remaining characters.

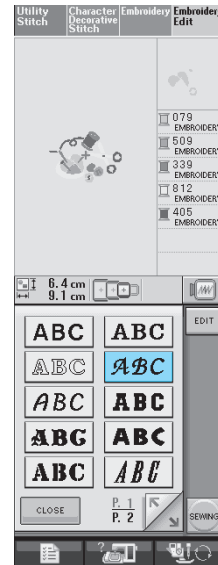

→ The characters you enter will be displayed in the center of the display.

7 Press  .



8 Use  to move the characters.

* With a USB mouse, your finger or the touch pen, drag the characters to move them.

9 Press **ARRAY** to change the layout of the characters. Press **CLOSE**.

* See page 207 for more information about changing the layout.

10 Press **MULTI COLOR** to change the color of the characters.

* See page 209 for more information about changing the color.

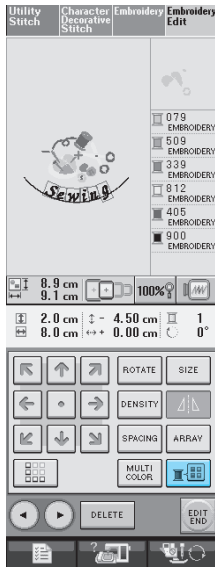

11 When all editing is finished, press **EDIT END**.

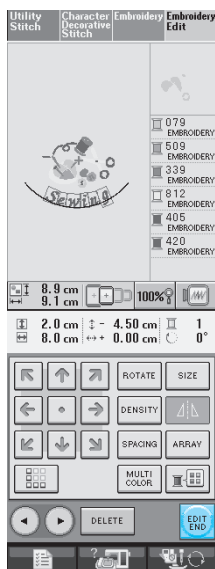

■ Selecting combined embroidery patterns

If multiple patterns have been combined, use



to select the pattern to be edited. If a USB mouse is connected, the pattern can be selected by clicking it. Move the mouse to position the pointer over the desired pattern, and then click the left mouse button. In addition, patterns can be selected by directly touching the screen with your finger or touch pen.



- Use **SELECT** to select patterns that are overlapping and cannot be selected by clicking them or by touching the screen.

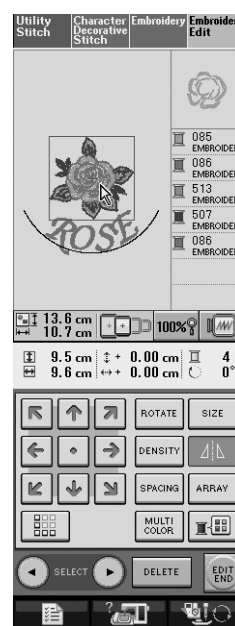

6

Embroidery Edit

Sewing Combined Patterns

Combined patterns will be embroidered in the order they were entered. In this example, the embroidery order will be as follows:

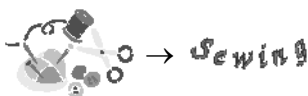

Note

Follow the directions in “Sewing Embroidery Patterns” on page 166.

1

Embroider  **by following the color order on the right side of the display.**

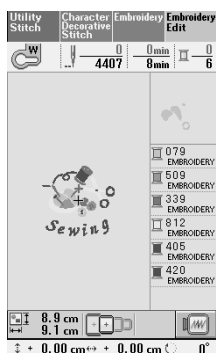

→ When the border is finished, the [+] cursor will move to the “Sewing” part of the pattern.

2

Embroider *Sewing*.

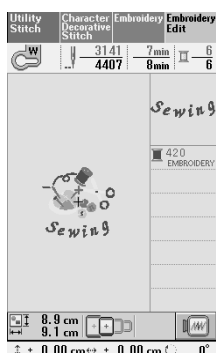

→ When “Sewing” is embroidered, the display returns to the sewing screen.

USING THE MEMORY FUNCTION

In the same way as embroidery patterns in Chapter 5, you can save and retrieve edited embroidery patterns to and from the machine's memory, a personal computer, or USB media. Refer to the relevant sections in Chapter 5 on saving and retrieving embroidery patterns and follow the same procedures in order to save and retrieve edited embroidery patterns.
See page 185 for more information about the MEMORY FUNCTION.



6

Embroidery Edit



Chapter 7

MY CUSTOM STITCH

DESIGNING A STITCH.....226

ENTERING STITCH DATA228

- Key Functions228
- Moving a Point230
- Moving Part or All of the Design231
- Inserting New Points232

USING STORED CUSTOM STITCHES233

Storing Custom Stitches in Your List233

- If the Memory is Full233

Retrieving Stored Stitches234

DESIGNING A STITCH

By using the MY CUSTOM STITCH™ function, you can register stitches you have created yourself. You can also sew designs combining MY CUSTOM STITCH™ creations with built-in characters (see page 128).



Memo

- Stitches that you create with MY CUSTOM STITCH™ can be a maximum of 7 mm (approx. 9/32 inch) wide and 37 mm (approx. 1-1/3 inches) long.
- Stitches can be designed more easily with MY CUSTOM STITCH™ if you first draw the stitch on the included grid sheet.

1 Draw the stitch design on the grid sheet (part code SA507, X81277-001).

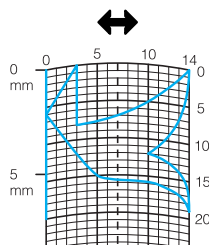

Memo

Simplify the design so that it can be sewn as a continuous line. For a more attractive stitch, close the design by intersecting lines.

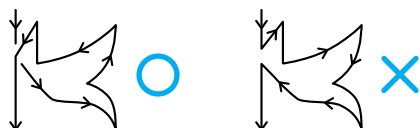

If the design is to be repeated and linked, the start point and end point of the design should be at the same height.



2 Decide the spacing of the stitch.

- * By adjusting the spacing of a stitch, you can create various patterns with one stitch.

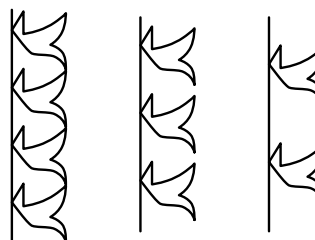
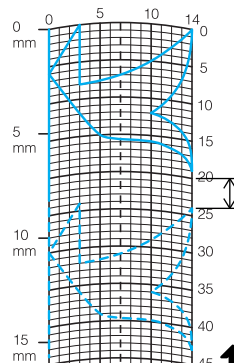

3 Place points where the pattern intersects with the grid, and connect all the points with a line.

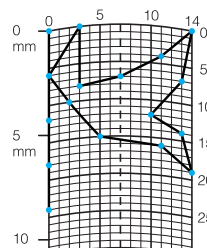

4 Determine the x and y coordinates of each of the marked points.

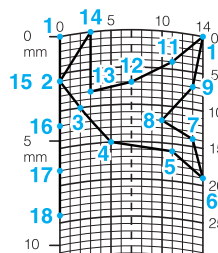

Memo

This will determine the stitch design that will be sewn.

Examples of Custom Stitches

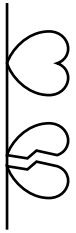
	Stitch	1	2	3	4	5	6	7	8	9	10	11	12	13	14	15
	↕	0	12	18	22	23	21	17	14	12	9	6	3	1	3	6
	↔	0	0	3	6	10	13	14	13	11	13	14	13	10	6	3
	Stitch	16	17	18	19	20	21	22	23	24	25	26	27	28	29	30
	↕	12	41	43	40	41	38	35	32	30	32	35	41	45	47	44
	↔	0	0	4	7	11	13	14	13	10	6	3	0	0	4	7
	Stitch	31	32	33	34	35	36	37	38	39	40	41	42	43	44	45
	↕	45	47	50	54	56	55	51	45	70						
↔	11	13	14	13	10	6	3	0	0							

	Stitch	1	2	3	4	5	6	7	8	9	10	11	12	13	14	15
	↕	0	30	32	32	32	33	35	35	37	35	32	30	30	29	26
	↔	0	0	1	7	10	12	11	8	12	14	14	11	5	3	8
	Stitch	16	17	18	19	20	21	22	23	24	25	26	27	28	29	30
	↕	24	18	13	12	13	10	12	8	12	7	12	6	10	5	10
	↔	10	13	14	14	12	11	10	9	8	6	6	3	2	0	2
	Stitch	31	32	33	34	35	36	37	38	39	40	41	42	43	44	45
	↕	16	19	23	22	17	22	23	19	42						
↔	1	0	0	6	10	6	0	0	0							

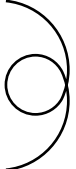
	Stitch	1	2	3	4	5	6	7	8	9	10	11	12	13	14	15
	↕	0	3	5	8	12	17	20	24	27	29	31	32	30	27	24
	↔	0	5	8	11	13	14	14	13	12	11	9	6	3	1	0
	Stitch	16	17	18	19	20	21	22	23	24	25	26	27	28	29	30
	↕	21	18	16	15	15	16	18	21	25	28	33	37	41	43	44
	↔	0	1	3	5	8	10	12	13	14	14	13	11	8	5	0
	Stitch	31	32	33	34	35	36	37	38	39	40	41	42	43	44	45
	↕															
↔																

	Stitch	1	2	3	4	5	6	7	8	9	10	11	12	13	14	15
	↕	0	5	4	5	8	7	8	11	11	11	16	11	7	4	0
	↔	7	7	3	7	7	0	7	7	3	7	7	3	0	3	7
	Stitch	16	17	18	19	20	21	22	23	24	25	26	27	28	29	30
	↕	4	7	11	16	21	20	21	24	23	24	27	27	27	32	27
	↔	11	14	11	7	7	11	7	7	14	7	7	11	7	7	11
	Stitch	31	32	33	34	35	36	37	38	39	40	41	42	43	44	45
	↕	23	20	16	20	23	27	32								
↔	14	11	7	3	0	3	7									



ENTERING STITCH DATA

Key Functions

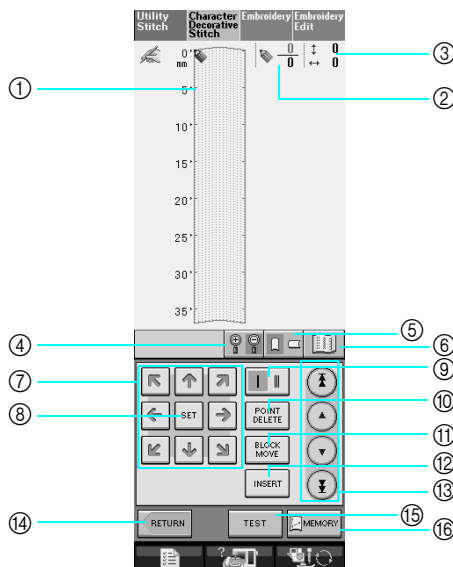



- ① This area displays the stitch being created.
- ② Displays the number of the present set point over the total number of points in the stitch.
- ③ Displays the y-coordinate of over the x-coordinate of .

No.	Display	Key Name	Explanation	Page
④		Enlarger key	Press this key to see an enlarged version of the stitch being created.	229
⑤		Grid direction key	Press this key to change the direction of the grid sheet.	229
⑥		Image key	Press this key to view an image of the stitch.	230
⑦		Arrow keys	Use these keys to move over the display area.	229-232
⑧		Set key	Press this key to set a point on the stitch design.	229-231
⑨		Single/triple stitching key	Press this key to select whether one or three stitches will be sewn between two points.	229
⑩		Point delete key	Press this key to delete a selected point.	230
⑪		Block move key	Press this key to group points together and move them together.	231
⑫		Insert key	Press this key to insert new points on the stitch design.	232
⑬		Point-to-point key	Use these keys to move from point to point on the stitch, or to the first or last point entered on the stitch.	230-232
⑭		Return key	Press this key to exit the entering stitch data screen.	—
⑮		Test key	Press this key to sew a test-run of the stitch.	230, 233
⑯		MY CUSTOM STITCH™ memory key	Press this button to store the stitch being created.	233

1 Press **Character Decorative Stitch** .

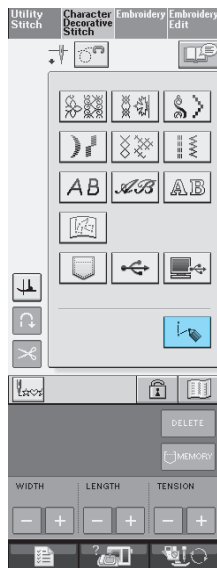
2 Press  .



3 Use  to move  to the coordinates of the first point on the grid sheet.

* Press  to change the direction of the grid sheet.

* Press  to enlarge the image of the stitch being created.

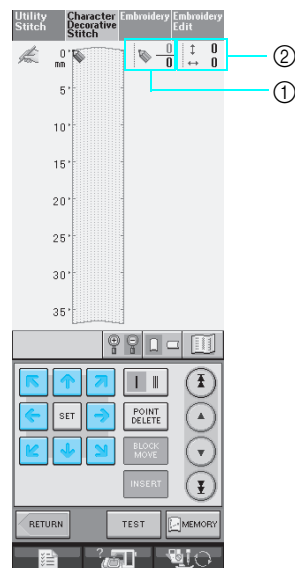

① Currently selected point/Total number of points

② Coordinates of 

 **Memo**

Whenever  is in the top left corner of the LCD display, you can use the touch pen to enter data.

4 Press **SET** to add the point indicated by



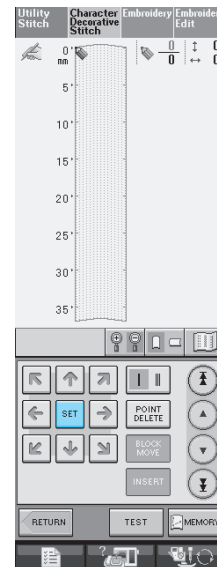

* To insert coordinates with the touch pen, move the tip of the pen to a desired point. Once you release the pen from the screen a point will be entered into the graph at those coordinates. The number of the currently selected point along with the total number of points will be displayed.



5 Select whether one stitch or three stitches will be sewn between the first two points.

* To sew three stitches, press the key so that it appears as  .

6 Use  to move  to the second point and press **SET** .

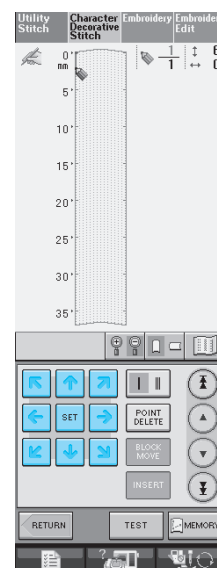

7 Repeat the steps above for each point that you have drawn on the grid sheet until the stitch design is drawn on the screen as a continuous line.

- * Press **POINT DELETE** to delete a selected point entered.
- * Press **TEST** to sew a test-run of the stitch.
- Press **EDIT** to return to the original screen.
- * Press **MEMORY** to view an image of the stitch.

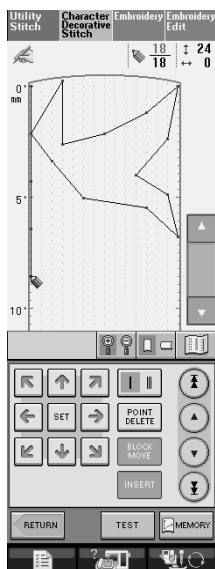

Memo

- If you have entered points that are too close together, the fabric may not feed properly. Edit the stitch data to leave a larger space between points.
- If the stitch design is to be repeated and linked, make sure that linking stitches are added so that the stitch designs will not overlap.

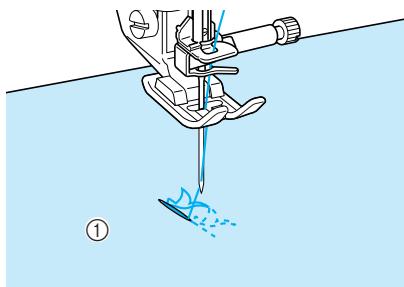

① Linking stitches

Moving a Point

1 Press **▲** or **▼** to move **✎** to the point that you want to move.

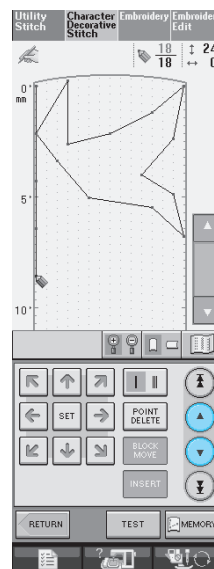

- * To move **✎** to the first point, press **▲**.
- * To move **✎** to the last point, press **▼**.
- * You can also move **✎** by using the touch pen.



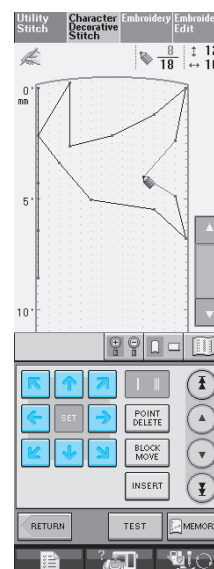



2 Use **←** **→** **↶** **↷** to move the point.



■ Moving Part or All of the Design

1 Press  or  to move  to the first point of the section that you want to move.

- * To move  to the first point, press .
- * To move  to the last point, press .
- * You can also move  by using the touch pen.

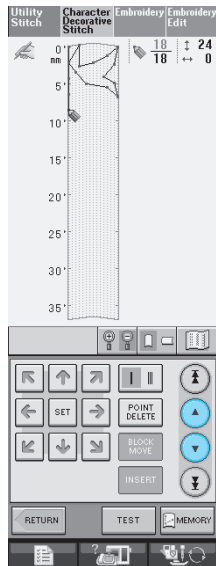

2 Press .

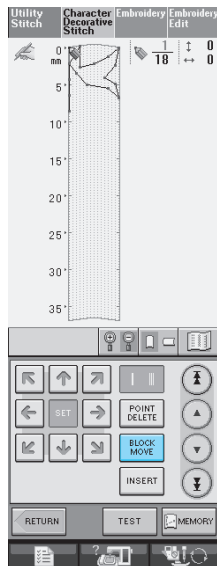

→ The selected point and all points that were entered after it are selected.

3 Press  or  to move the section.

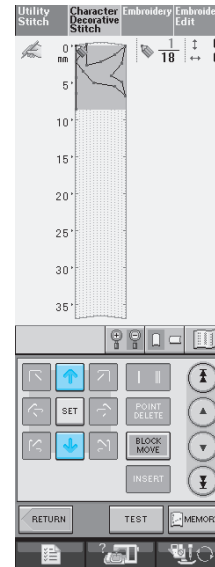

4 Press .

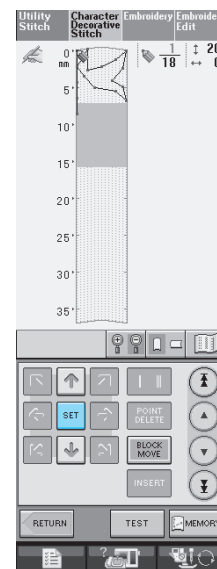



→ The section will be moved.







7

MY CUSTOM STITCH

■ Inserting New Points

1 Press  or  to move  to a place on the design where you want to add a new point.

- * To move  to the first point, press .
- * To move  to the last point, press .
- * You can also move  by using the touch pen.

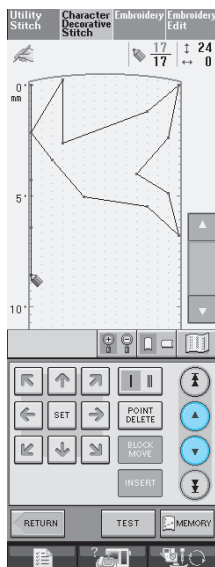

2 Press .

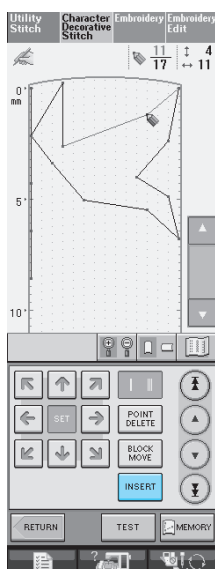

→ A new point is entered and  moves to it.

3 Use  to move the point.

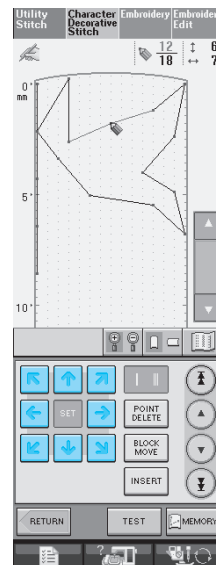

USING STORED CUSTOM STITCHES

Storing Custom Stitches in Your List

Stitch patterns created using the MY CUSTOM STITCH™ function can be stored for later use. Once you finish entering the stitch data, press . The “Saving” message appears and the stitch will be stored.

Before storing a stitch, press  to sew a test-run of the stitch.

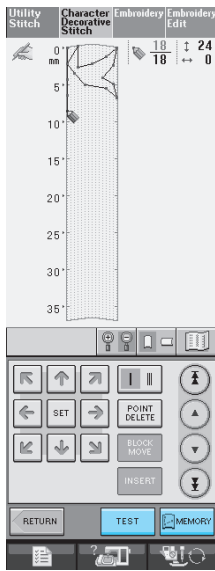

Memo

- Storing a stitch pattern takes a few seconds.
- For details on retrieving a stored stitch pattern, see page 234.

Note

- Do not turn off the machine while the “Saving” message is displayed, otherwise the stitch pattern data being saved may be lost.

■ If the Memory is Full

If the following message appears after  is pressed, the stitch pattern cannot be stored because either the machine’s memory is full or the stitch pattern being stored is larger than the amount of space available in the memory. To be able to store the stitch pattern in the machine’s memory, a previously stored stitch pattern must be deleted.

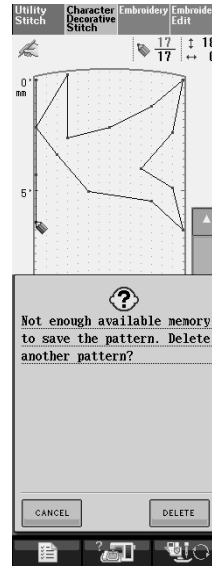

Note

To save custom stitches to USB media or in the computer, follow the previously described procedure to store the custom stitch, and then press  to select the stitch (see the following “Retrieving Stored Stitches” section).

Press  to save the stitch to USB media or in the computer. (For details, see “Saving Stitch Patterns to USB Media (Commercially Available)” on page 138 or “Saving Stitch Patterns in the Computer” on page 139.)



7

MY CUSTOM STITCH

Retrieving Stored Stitches

1 Press .

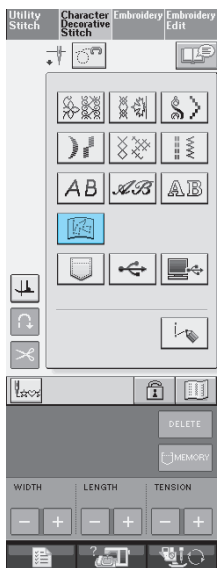



→ A list of stored stitch patterns is displayed.

2 Select the stitch pattern.

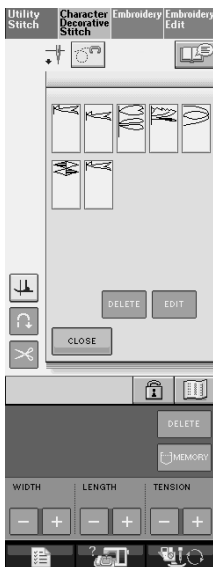
* Press  to return to the previous screen without retrieving.



3 Press .

- * To delete the stored stitch pattern, press .
- * To edit the stored stitch pattern, press .

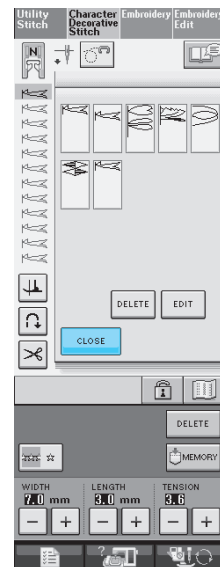



Chapter 8

Appendix

CARE AND MAINTENANCE	236
About the Maintenance Message.....	236
Cleaning the LCD Screen	236
Cleaning the Machine Casing	236
Cleaning the Race	236
Adjusting the Alternate Bobbin Case (with no marking).....	237
ADJUSTING THE SCREEN	238
Screen Visibility is Low	238
Touch Panel is Malfunctioning	238
TROUBLESHOOTING	240
ERROR MESSAGES	243
■ Alarm Sounds	248
SPECIFICATIONS	249
UPGRADING YOUR MACHINE'S SOFTWARE	250
Upgrade Procedure Using USB Media	250
Upgrade Procedure Using Computer	251

CARE AND MAINTENANCE

⚠ CAUTION

- Be sure to unplug the machine before cleaning it. Otherwise, electric shock or injury may result.

About the Maintenance Message

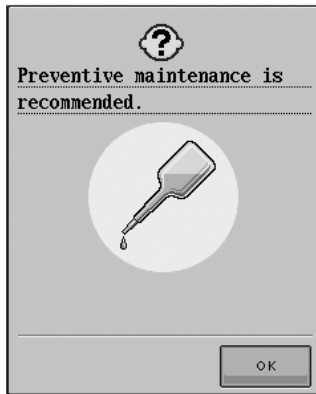

Once this message appears, it is recommended to take your machine to an authorized retailer for a regular maintenance check. Although this message will disappear and the machine will continue to function once you press **OK**, the message will display several more times until the appropriate maintenance is performed.

Please take the time to arrange the maintenance your machine requires once this message appears. Such steps will help to ensure you receive continued, uninterrupted hours of machine operation for the future.

Cleaning the LCD Screen

If the screen is dirty, gently wipe it with a soft, dry cloth. Do not use organic solvents or detergents.

Cleaning the Machine Casing

If the surface of the machine is dirty, lightly soak a cloth in a neutral detergent, squeeze it out firmly, and then wipe the surface. Then wipe again with a dry cloth.

Cleaning the Race

If dust or bits of dirt collect in the race or bobbin case, the machine will not run well, and the bobbin thread detection function may not operate. Keep the machine clean for best results.

- 1 Press the "Needle Position" button to raise the needle.
- 2 Turn the main power to OFF.
- 3 Remove the needle and the presser foot holder (see pages 38 through 39).
- 4 Remove the flat bed attachment or the embroidery unit if either is attached.
- 5 Grasp both sides of the needle plate cover, and then slide it toward you.

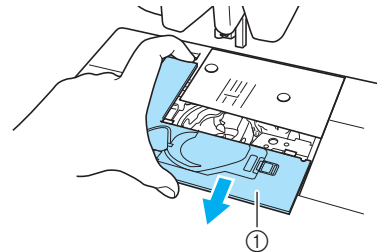

- ① Needle plate cover
→ The needle plate cover is removed.

- 6 Grasp the bobbin case, and then pull it out.

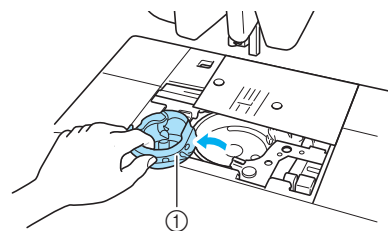

- ① Bobbin case

- 7 Use the cleaning brush or a vacuum cleaner to remove any lint and dust from the race and its surrounding area.

- * Do not apply oil to the bobbin case.

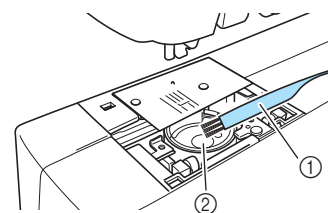

- ① Cleaning brush
② Race

- 8** Insert the bobbin case so that the ▲ mark on the bobbin case aligns with the ● mark on the machine.

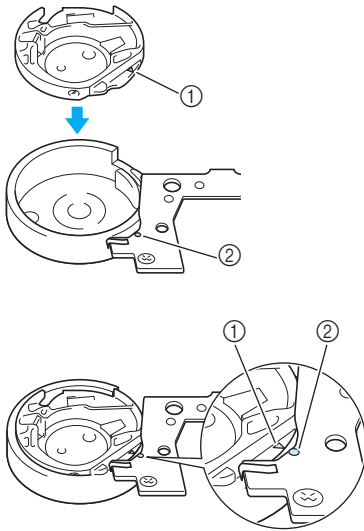

* Align the ▲ and ● marks.

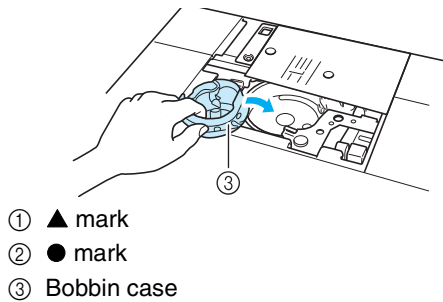

- ① ▲ mark
- ② ● mark
- ③ Bobbin case

Note

- Never use a bobbin case that is scratched; otherwise, the upper thread may become tangled, the needle may break, or sewing performance may suffer. For a new bobbin case (part code: XC3153-351 (green screw), XC8167-551 (no marking)), contact your nearest authorized service center.
- Be sure that the bobbin case is correctly installed. Otherwise, the needle may break.

- 9** Insert the tabs on the needle plate cover into the needle plate, and then slide the cover back on.

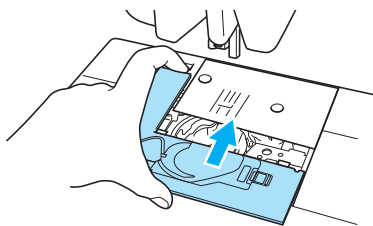

Note

- If the needle plate has been removed it is especially important to reinstall the needle plate and tighten the screws prior to installing the bobbin case.

Adjusting the Alternate Bobbin Case (with no marking)

The alternate bobbin case (with no marking) can be easily adjusted when bobbin tension changes are required to accommodate different bobbin threads. To adjust the bobbin tension for embroidery function, using the alternate bobbin case (with no marking), turn the slotted-head (-) screw with a (small) screwdriver.

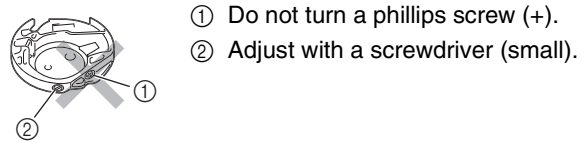

- ① Do not turn a phillips screw (+).
- ② Adjust with a screwdriver (small).

Correct tension

See page 174 about the correct tension.

Bobbin thread is loose

Bobbin thread appears slightly on the right side of fabric. If this occurs, turn the slotted-head screw (-) clockwise, being careful not to over-tighten the screw, approximately 30-45 degrees to increase bobbin tension.

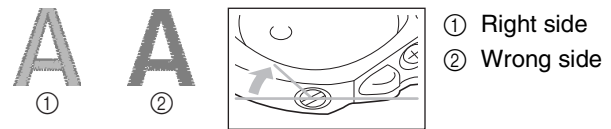

Bobbin thread is tight

Upper thread on the right side of fabric seems to be lifting/looping and bobbin thread is not seen on the wrong side of fabric. If this occurs, turn the slotted-head screw (-) counterclockwise, being careful not to over-tighten the screw, approximately 30-45 degrees to decrease bobbin tension.

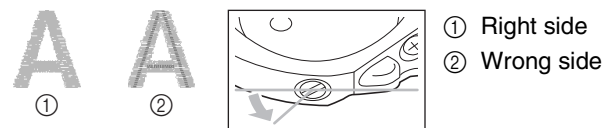

CAUTION

- When adjusting the alternate bobbin case, be sure to remove the bobbin from the alternate bobbin case.
- DO NOT adjust the position of the Phillips (+) screw on the alternate bobbin case as this may result in damage to the bobbin case, rendering it unusable.
- If the slotted-head screw (-) is difficult to turn, do not use force. Turning the screw too much or providing force in either (rotational) direction may cause damage to the bobbin case. Should damage occur, the bobbin case may not maintain proper tension.



ADJUSTING THE SCREEN

Screen Visibility is Low

If the screen is difficult to see when you turn on the power, follow the steps below.

- 1 Press your finger anywhere on the screen. Holding your finger on the screen, turn the main power switch to OFF and back to ON.

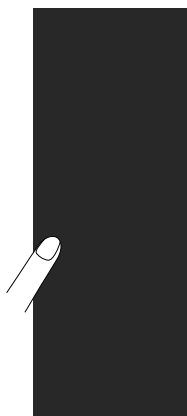

→ BRIGHTNESS OF LCD is displayed.

- 2 Use the **+**, **-** keys to adjust the screen until you can see it easily.

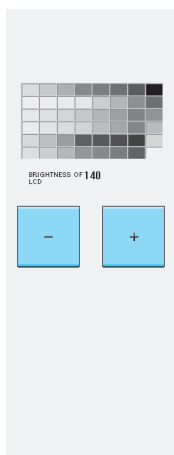

- 3 Turn the main power to OFF and back to ON.

Touch Panel is Malfunctioning

If the screen does not respond correctly when you touch a key (the machine does not perform the operation or performs a different operation), follow the steps below to make the proper adjustments.

- 1 Press your finger anywhere on the screen. Holding your finger on the screen, turn the main power switch to OFF and back to ON.

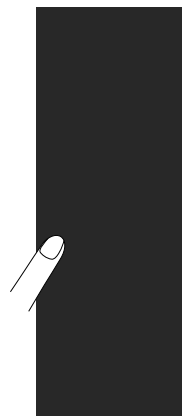

→ BRIGHTNESS OF LCD is displayed.

- 2 Press the "Automatic Threading" button.

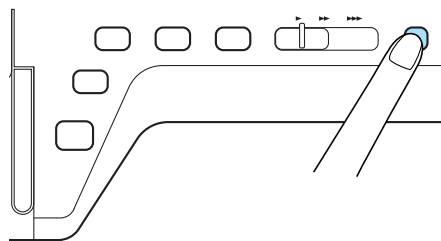

→ The touch panel adjustment screen is displayed.

3 Using the included touch pen, lightly touch the center of each +, in order from 1 to 5.

- * If the buzzer sounds one time after you press number 5, the operation is finished. If the buzzer sounds twice, there was an error. In this case, repeat the steps above.



Note

- Only use the included touch pen to touch the screen. Do not use a mechanical pencil, pin, or other sharp object. Do not press strongly on the screen. Otherwise, damage may result.

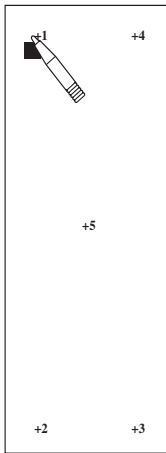

4 Turn the main power to OFF, then turn it back to ON.





Note

- If you finish the screen adjustment and the screen still does not respond, or if you cannot do the adjustment, contact your authorized dealer.



TROUBLESHOOTING





If you have a minor problem with your sewing machine, check the following solutions. If the solutions suggested do not correct the problem, contact your authorized dealer. You can also press  then

 for advice about minor sewing problems during sewing. Press  at any time to return to the original screen.

Problem	Cause	Solution	Page
Upper thread breaks	Machine is not threaded correctly (used the wrong spool cap, spool cap is loose, the thread did not catch the needle bar threader, etc.)	Rethread the machine correctly.	29
	Thread is knotted or tangled.	Rethread upper and lower thread.	26, 29
	Thread is too thick for the needle.	Check needle and thread combinations.	41
	Upper thread tension is too strong.	Adjust the thread tension.	50, 174
	Thread is twisted.	Use scissors, etc., to cut the twisted thread and remove it from the race, etc.	—
	Needle is turned, bent or the point is dull.	Replace the needle.	39
	Needle is installed incorrectly.	Reinstall the needle correctly.	39
	There are scratches near the hole of the needle plate.	Replace the needle plate, or consult your authorized dealer.	65
	There are scratches near the hole in the presser foot.	Replace the presser foot, or consult your authorized dealer.	37
	There are scratches on the race.	Replace the race, or consult your authorized dealer.	236
Bobbin thread breaks	Bobbin is set incorrectly.	Reset the bobbin thread correctly.	26
	There are scratches on the bobbin or it doesn't rotate properly.	Replace the bobbin.	26
	Thread is twisted.	Use scissors, etc. to cut the twisted thread and remove it from the race, etc.	—
Skipped stitches	Machine is threaded incorrectly.	Check the steps for threading the machine and rethread it correctly.	29
	Using improper needle or thread for the selected fabric.	Check the "Fabric/Thread/Needle Combination" chart.	41
	Needle is turned, bent or the point is dull.	Replace the needle.	39
	Needle is installed incorrectly.	Reinstall the needle correctly.	39
	Needle is defective.	Replace the needle.	39
	Dust or lint has collected under the needle plate.	Remove the dust or lint with the brush.	236
Fabric puckers	There is a mistake in the upper or bobbin threading.	Check the steps for threading the machine and rethread it correctly.	26, 29
	Spool cap is set incorrectly.	Check the method for attaching the spool cap, then reattach the spool cap.	29
	Using improper needle or thread for the selected fabric.	Check the "Fabric/Thread/Needle Combination" chart.	41
	Needle is turned, bent or the point is dull.	Replace the needle.	39
	Stitches are too long when sewing thin fabrics.	Shorten the stitch length.	49
	Thread tension is set incorrectly.	Adjust the thread tension.	50, 174
	Wrong presser foot.	Use the correct presser foot.	"STITCH SETTING CHART"
High-pitched sound while sewing	Dust or lint is caught in the feed dogs.	Remove the dust or lint.	236
	Pieces of thread are caught in the race.	Clean the race.	236
	Upper threading is incorrect.	Check the steps for threading the machine and rethread the machine.	29
	There are scratches on the race.	Replace the race, or consult your authorized dealer.	236
Cannot thread the needle	Needle is not in the correct position.	Press the "Needle Position" button to raise the needle.	3
	Threading hook does not pass through the eye of the needle.	Press the "Needle Position" button to raise the needle.	3
	Needle is installed incorrectly.	Reinstall the needle correctly.	39

Problem	Cause	Solution	Page
Cannot lower the presser foot with the presser foot lever	Presser foot was raised using the "Presser Foot Lifter" button.	Press the "Presser Foot Lifter" button to lower the presser foot.	3
Thread tension is incorrect	Upper threading is incorrect.	Check the steps for threading the machine and rethread the machine.	29
	Bobbin is set incorrectly.	Reset the bobbin. (If needle plate was removed, reinstall needle plate and tighten screws prior to installing bobbin case.)	26
	Using improper needle or thread for the selected fabric.	Check the "Fabric/Thread/Needle Combination" chart.	41
	Presser foot holder is not attached correctly.	Reattach the presser foot holder correctly.	38
	Thread tension is set incorrectly.	Adjust the thread tension.	50, 174
Character pattern does not turn out	Wrong presser foot was used.	Attach the correct presser foot.	"STITCH SETTING CHART"
	Pattern adjustment settings were set incorrectly.	Revise the pattern adjustment settings.	121
	Did not use a stabilizer material on thin fabrics or stretch fabrics.	Attach a stabilizer material.	120
	Thread tension is set incorrectly.	Adjust the thread tension.	50, 174
Embroidery pattern does not sew out correctly	Thread is twisted.	Use scissors, etc., to cut the twisted thread and remove it from the race, etc.	—
	Fabric was not inserted into the frame correctly (fabric was loose, etc.).	If the fabric is not stretched tight in the frame, the pattern may turn out poorly or there may be shrinkage of the pattern. Set the fabric into the frame correctly.	159
	Stabilizing material was not attached.	Always use stabilizing material, especially with stretch fabrics, lightweight fabrics, fabrics with a coarse weave, or fabrics that often cause pattern shrinkage. See your authorized dealer for the proper stabilizer.	157
	There was an object placed near the machine, and the carriage or embroidery frame hit the object during sewing.	If the frame bumps something during sewing, the pattern will turn out poorly. Do not place anything in the area where the frame may bump it during sewing.	165
	Fabric outside the frame edges interferes with the sewing arm, so the embroidery unit cannot move.	Reinsert the fabric in the embroidery frame so that the excess fabric is away from the sewing arm, and rotate the pattern 180 degrees.	159
	Fabric is too heavy, so the embroidery unit cannot move freely.	Place a large thick book or similar object under the arm head to lightly lift the heavy side and keep it level.	—
	Fabric is hanging off the table.	If the fabric is hanging off the table during embroidery, the embroidery unit will not move freely. Place the fabric so that it does not hang off the table or hold the fabric to keep it from dragging.	165
	Fabric is snagged or caught on something.	Stop the machine and place the fabric so that it does not get caught or snagged.	—
	Embroidery frame was removed during sewing (for example, to reset the bobbin). The presser foot was bumped or moved while removing or attaching the embroidery frame, or the embroidery unit was moved.	If the presser foot is bumped or the embroidery unit is moved during sewing, the pattern will not turn out. Be careful when removing or reattaching the embroidery frame during sewing.	170
Loops appear on the surface of the fabric when embroidering	The thread tension is incorrectly set.	Adjust the thread tension.	174
	The tension of the upper thread is incorrectly set for the combination of the fabric, thread and pattern being used.	Use the embroidery needle plate cover.	165
	The combination of the bobbin case and bobbin thread is incorrect.	Change the bobbin case or bobbin thread so that the correct combination is used.	165



Problem	Cause	Solution	Page
Needle breaks	Needle is installed incorrectly.	Reinstall the needle correctly.	39
	Needle clamp screw is not tightened.	Tighten the needle clamp screw.	40
	Needle is turned or bent.	Replace the needle.	39
	Using improper needle or thread for the selected fabric.	Check the "Fabric/Thread/Needle Combination" chart.	41
	Wrong presser foot was used.	Use the recommended presser foot.	"STITCH SETTING CHART"
	Upper thread tension is too strong.	Adjust the thread tension setting.	50, 174
	Fabric is pulled during sewing.	Do not pull the fabric during sewing.	—
	Spool cap is set incorrectly.	Check the method for attaching the spool cap, then reattach the spool cap.	29
	There are scratches around the holes in the needle plate.	Replace the needle plate, or consult your authorized dealer.	65
	There are scratches around the hole(s) in the presser foot.	Replace the presser foot, or consult your authorized dealer.	37
	There are scratches on the race.	Replace the race, or consult your authorized dealer.	236
Needle is defective.	Replace the needle.	39	
Fabric does not feed through the machine	Feed dogs are set in the down position.	Use the feed dog position lever to raise the feed dogs.	85
	Stitches are too close together.	Lengthen the stitch length setting.	49
	Wrong presser foot was used.	Use the correct presser foot.	"STITCH SETTING CHART"
	Needle is turned, bent or the point is dull.	Replace the needle.	39
	Thread is entangled.	Cut the entangled thread and remove it from the race.	—
Machine does not operate	There is no pattern selected.	Select a pattern.	59, 116, 149, 199
	"Start/Stop" button was not pushed.	Press the "Start/Stop" button.	3
	Main power switch is not turned on.	Turn the main power to ON.	10
	Presser foot is not lowered.	Lower the presser foot.	3
	"Start/Stop" button was pushed with the foot controller attached.	Remove the foot controller, or use the foot controller to operate the machine.	45
	Speed control lever is set to control the zigzag stitch width.	Use the foot controller instead of the "Start/Stop" button to operate the machine.	45
	All keys and buttons have been locked by  .	Press  to unlock all keys and buttons.	37, 39
Embroidery unit does not operate	There is no pattern selected.	Select a pattern.	149, 199
	Main power switch is not turned on.	Turn the main power to ON.	10
	Embroidery unit is not attached correctly.	Reattach the embroidery unit correctly.	146
	Embroidery frame was attached before the unit was initialized.	Perform the initialization process correctly.	146
LCD display is difficult to see	LCD contrast is not properly adjusted.	Adjust the LCD contrast.	19, 238
Nothing happens, even if the LCD display is pressed	The screen has been locked.	Press either of the following keys to unlock the screen.  	—

CAUTION

- This machine is equipped with a thread detection device. If the "Start/Stop" button is pushed before the upper threading is done, the machine will not operate properly. Also, depending on the pattern selected, the machine may feed the fabric even if the needle is raised. This is due to the needle bar release mechanism. At these times, the machine will make a sound different from that made during normal sewing. This is not the sign of a malfunction.
- If the power is disconnected during sewing:
Turn the main power to OFF and unplug the machine.
If you restart the machine, follow the instructions for operating the machine correctly.

ERROR MESSAGES

If the machine is not properly set and the “Start/Stop” button or the “Reverse/Reinforcement Stitch” button is pressed, or if the operation procedure is incorrect, the machine does not start. An alarm sounds and an error message is displayed on the LCD. If an error message displays, follow the instructions in the message.

Below is an explanation of 55 error messages. Refer to these when necessary (if you press  or do the operation correctly while the error message is displayed, the message disappears).

CAUTION

- **Be sure to rethread the machine. If you press the “Start/Stop” button without rethreading the machine, the thread tension may be wrong or the needle may break and cause injury.**

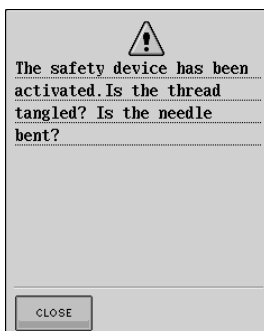

This message is displayed when the motor locks due to tangled thread or for other reasons related to thread delivery.

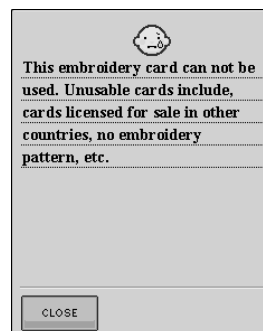

This message is displayed if the  is touched when an unusable embroidery card is inserted.

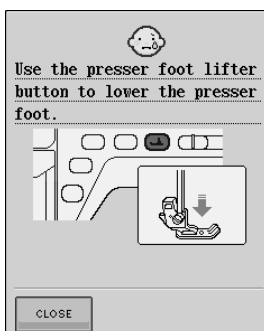

This message is displayed when a button, such as the “Start/Stop” button, is pushed while the presser foot is raised.

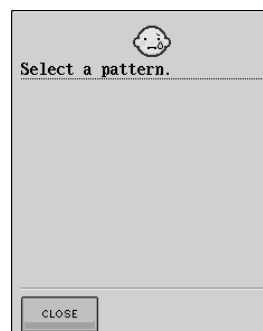

This message is displayed when there is no stitch or embroidery pattern selected and the “Start/Stop” button or the “Reverse/Reinforcement Stitch” button is pressed.

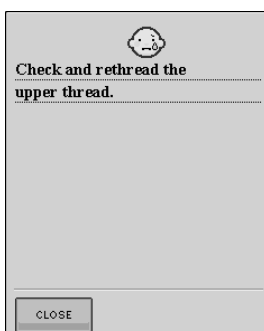

This message is displayed when the upper thread is broken or not threaded correctly, and the “Start/Stop” button or the “Reverse/Reinforcement Stitch” button is pressed.

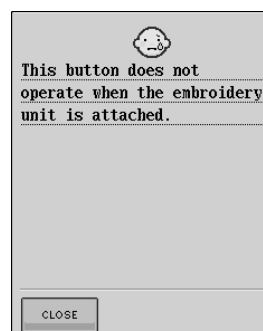

This message is displayed when the “Reverse/Reinforcement Stitch” button is pushed while the embroidery unit is attached.

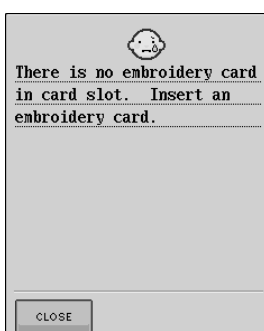

This message is displayed when the  is touched without an embroidery card inserted.

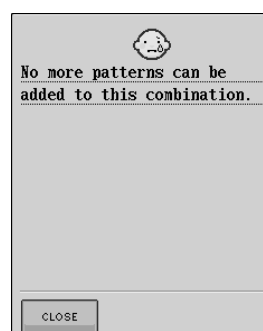

This message is displayed when you try to combine more than 71 patterns.



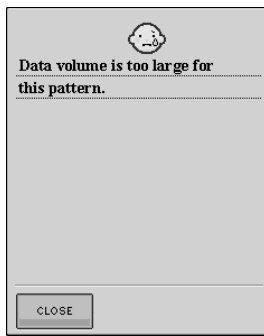

This message is displayed when the patterns you are editing take up too much memory, or if you are editing too many patterns for the memory.

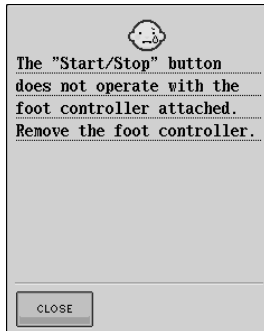

This message is displayed when the "Start/Stop" button is pushed to sew Utility stitches or Character/Decorative stitches while the foot controller is connected. (This message does not appear when embroidering.)

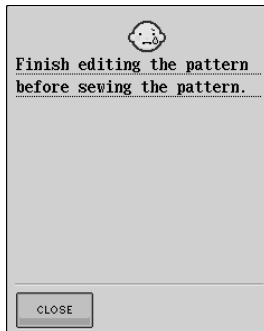

This message is displayed when the "Start/ Stop" button is pushed while the machine is in embroidery edit mode and a pattern is being edited.

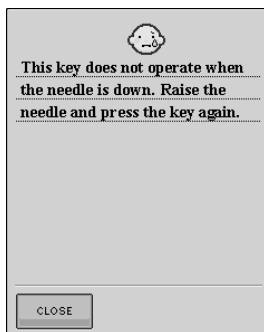

This message is displayed when a key on the LCD display is touched while the needle is in the down position.

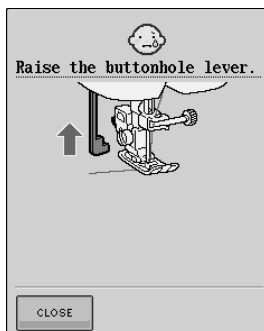

This message is displayed when the buttonhole lever is down, a stitch other than a buttonhole is selected, and the "Start/ Stop" button or the "Reverse/ Reinforcement Stitch" button is pushed.

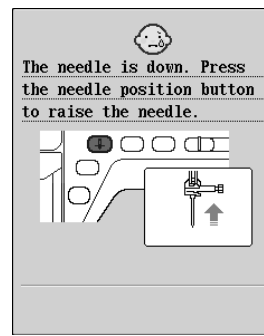

This message is displayed when the embroidery unit is attached and the power is turned on with the needle in the down position.

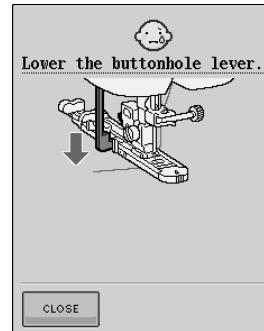

This message is displayed when the buttonhole lever is up, a buttonhole stitch is selected, and the "Start/ Stop" button or "Reverse/Reinforcement Stitch" button is pushed.

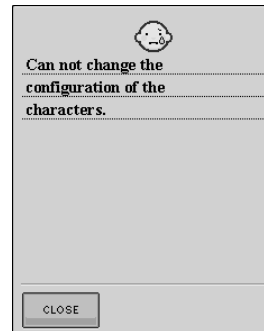

This message is displayed when there are too many characters and the curved character configuration is impossible.

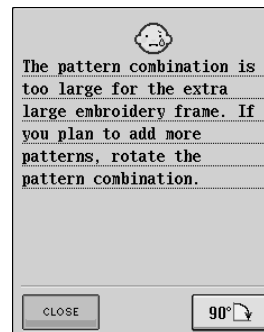

This message is displayed when the machine is in embroidery mode and the combined character pattern is too large for the embroidery frame. You can rotate the pattern 90 degrees and continue combining characters.

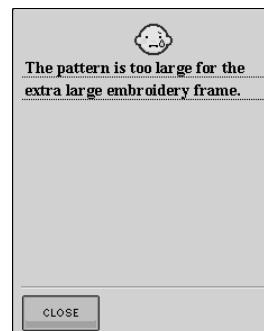

This message is displayed when the machine is in embroidery mode, and the character pattern combination is too large to fit in the embroidery frame.

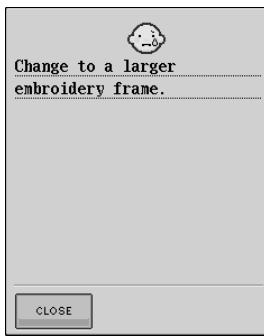

This message is displayed when the machine is in embroidery mode and the small frame is attached, and the selected pattern does not fit in the small frame.

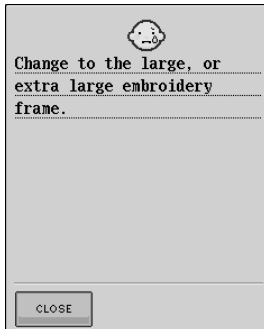

This message is displayed when, with the machine in embroidery mode and the small embroidery frame or medium embroidery frame attached, the selected pattern is larger than the embroidery area of the medium embroidery frame.

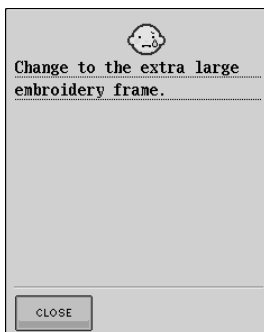

This message is displayed when, with the machine in embroidery mode and the small embroidery frame, medium embroidery frame or large embroidery frame attached, the selected pattern is larger than the embroidery area of the large embroidery frame.

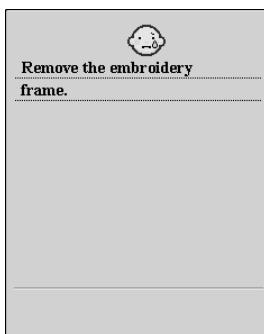

This message is displayed when the machine is in embroidery mode and the embroidery unit tries to initialize while the embroidery frame is attached.

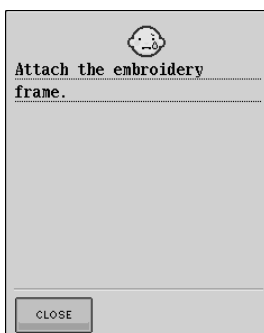

This message is displayed when the machine is ready to sew an embroidery pattern, and the "Start/Stop" button is pushed while the embroidery frame is not attached.

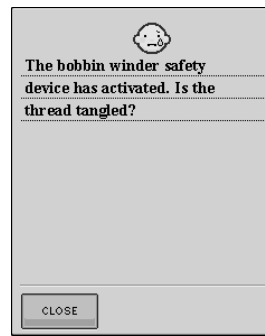

This message is displayed when the bobbin is being wound, and the motor locks because the thread is tangled, etc.

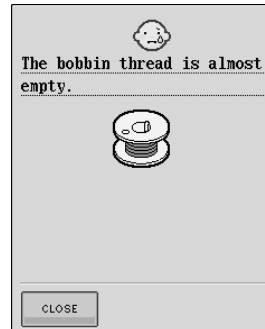

This message is displayed when the bobbin thread is running out.

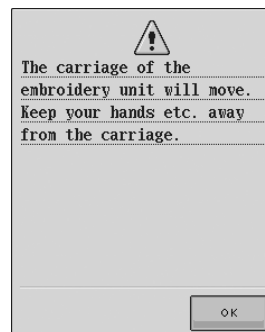

This message is displayed when the embroidery unit is initializing.

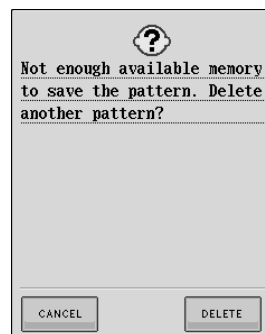

This message is displayed when the memory is full and the stitch or pattern cannot be saved.

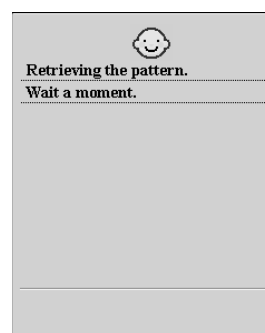

This message is displayed when the machine is retrieving a previously saved pattern while in embroidery edit mode.



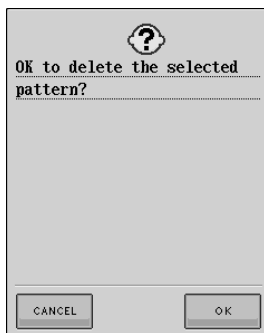

This message is displayed when, after selecting a pattern,



or **Embroidery Edit** is pressed and the pattern is about to be deleted.

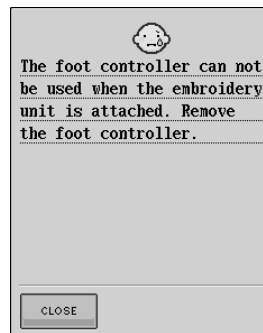

This message is displayed when the foot controller is pressed while the embroidery unit is attached and machine is set up for embroidering.

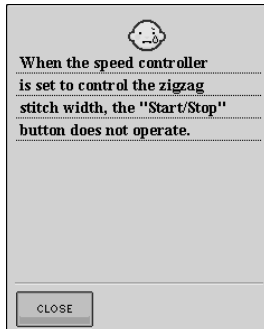

This message is displayed when the speed control lever is set to control the zigzag stitch width, and the "Start/ Stop" button is pushed. Use the foot controller to operate the machine.

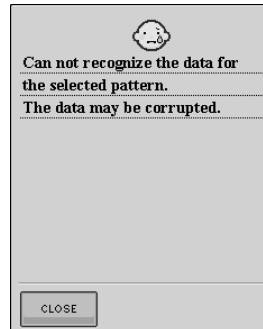

This message is displayed when there is a possibility that the data for the selected pattern is corrupted.

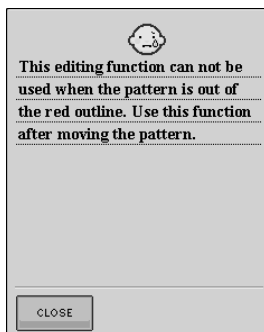

This message is displayed when the machine is in embroidery edit mode, and you try to use an editing function when the pattern is not completely within the red outline.

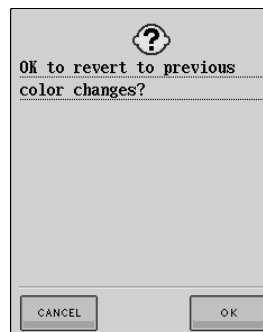

This message is displayed when **RESET** is pressed when changing thread colors.

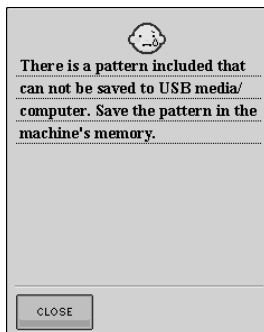

This message is displayed when you try to save a copyright protected pattern to USB media/ Computer. According to copyright laws, patterns that are illegal to reproduce or edit cannot be saved to USB media or computer. If this message displays, save the pattern in the machine's memory.

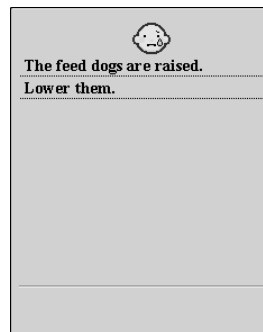

This message is displayed when the feed dogs are raised while the Embroidery or Embroidery Edit screen is displayed.

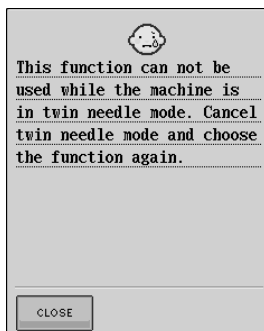

This message is displayed when the machine is in twin needle mode and a pattern that cannot be sewn with the twin needle is selected.

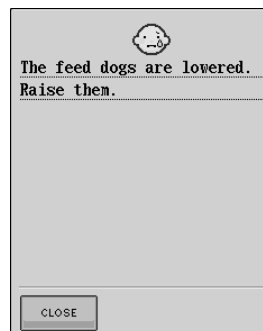

This message is displayed when either **Utility Stitch** or **Character Decorative Stitch** is pressed when the feed dogs are lowered.

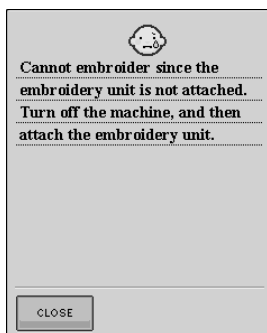

This message is displayed when the "Start/Stop" button is pushed and the machine is in embroidery mode, but the embroidery unit is not attached.

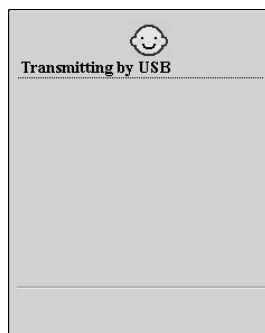

This message is displayed while the USB media is transmitting.

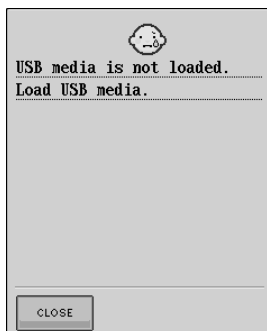

This message is displayed when you try to recall or save a pattern while no USB media is loaded.

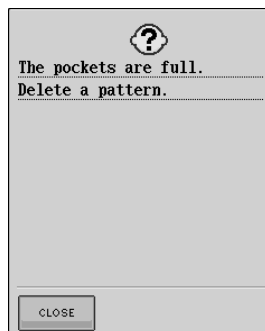

This message is displayed when the memory is full and a pattern must be deleted.

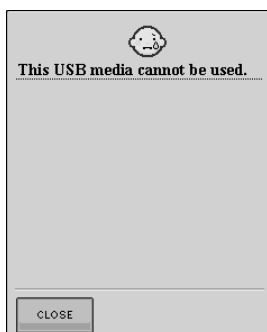

This message is displayed when you try to use incompatible media.



This message is displayed when the "Presser Foot Lifter" button is pushed while the presser foot lever is raised/the needle is lowered.

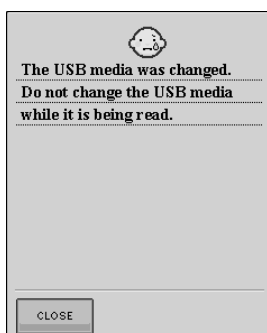

This message is displayed when you attempt to select a pattern after the USB media in which the pattern is saved has been changed.

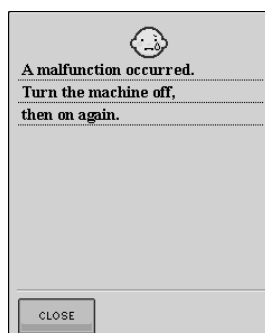

This message is displayed if some malfunction occurs.

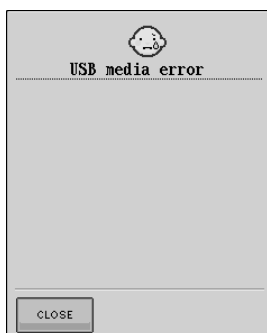

This message is displayed when an error occurs with the USB media.

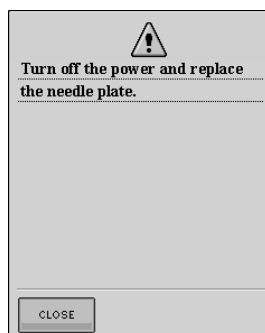

This message is displayed when you try to sew with a stitch other than a middle needle position while the single-hole needle plate is installed. This message is displayed when the needle plate is removed with the machine on or when the machine is turned on in the embroidery or embroidery edit mode.



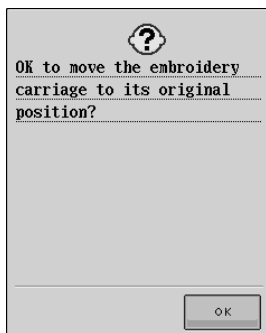

This message is displayed when replacing the embroidering bobbin thread.

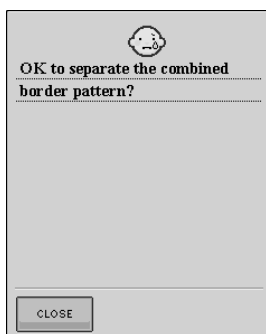

This message is displayed when rotating a saved combined pattern in the Embroidery screen.

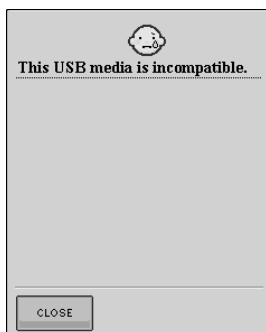

This message is displayed when you try to use incompatible USB media.

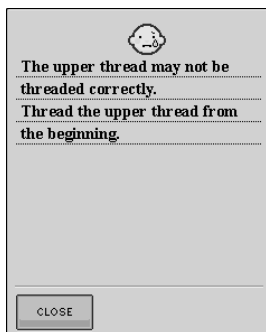

This message is displayed when it seems that the upper thread has not been threaded correctly.

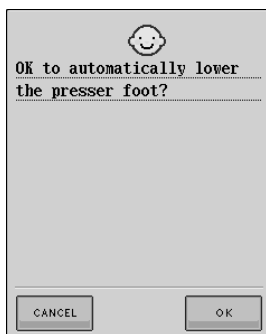

This message is displayed when  is pressed (the presser foot is raised).

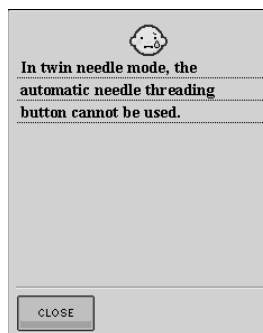

This message is displayed when the automatic needle threading button is pushed while twin needle sewing is set.

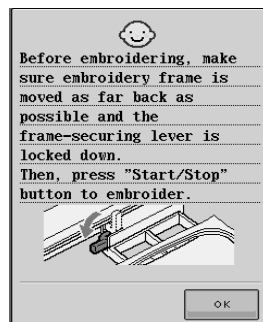

This confirmation message appears after the machine is turned on and the carriage of the embroidery unit has moved to its initial position.

■ Alarm Sounds

If the operation procedure was correct, the machine will beep once. If the operation procedure was incorrect, the machine will beep twice or four times.



Memo

If you want to turn the alarm off, press



. See page 16 for more details.

SPECIFICATIONS

	Item	Specification
Sewing Machine	Dimensions	55.6 cm (W) × 30.5 cm (H) × 25.8 cm (D) (approx. 21-7/8 inches (W) × 12 inches (H) × 10-1/8 inches (D))
	Case Dimensions	58.2 cm (W) × 31.9 cm (H) × 28.4 cm (D) (approx. 22-7/8 inches (W) × 12-1/2 inches (H) × 11-1/8 inches (D))
	Weight	12 kg (27 lb.) (with case: 14.3 kg (32 lb.))
	Sewing speed	70 to 1000 stitches per minute
	Needles	Home sewing machine needles (HA × 130)
Embroidery Unit	Dimensions	45.8 cm (W) × 13.1 cm (H) × 46.2 cm (D) (approx. 18 inches (W) × 5-1/8 inches (H) × 18-1/4 inches (D))
	Dimensions of machine with embroidery unit attached	72.4 cm (W) × 30.5 cm (H) × 46.2 cm (D) (approx. 28-1/2 inches (W) × 12 inches (H) × 18-1/4 inches (D))
	Weight	3.6 kg (8 lb.)



8

Appendix

UPGRADING YOUR MACHINE'S SOFTWARE

You can use USB media or a computer to download software upgrades for your sewing machine. When an upgrade program is available on " <http://solutions.brother.com> ", please download the files following the instructions on the web site and steps below.



Memo

- When the machine's software is upgraded, saved combinations of character and decorative stitches are erased.
- During the process of upgrading software, the buzzer will not sound when a key is pressed.

Upgrade Procedure Using USB Media

- 1 While pressing the "Automatic Threading" button, turn the main power to ON.

→ The following screen will appear on the LCD.

- 2 Press  .

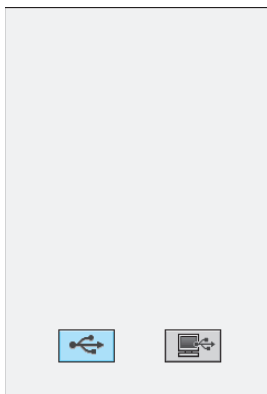

- 3 Insert the USB media into the USB port connector on the machine, making sure the media only contains the upgrade file.

- 4 Press  .

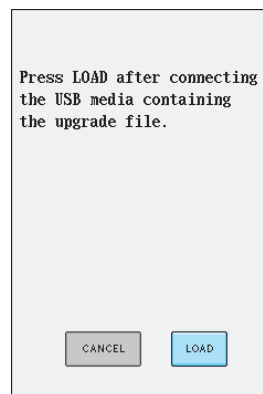

→ The upgrade file is downloaded.



Note

If an error occurs, a red text error message will appear. If the download is performed successfully, an "Upgrade complete." message will appear.

- 5 Remove the USB media, and turn the machine off and on again.

Upgrade Procedure Using Computer

- 1** While pressing the “Automatic Threading” button, turn the main power to ON.

→ The following screen will appear on the LCD.

- 2** Press  .

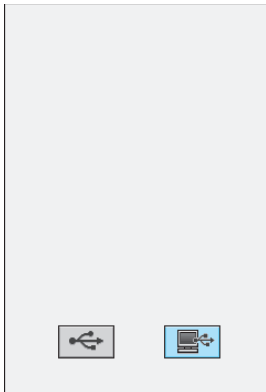

- 3** Plug the USB cable connector into the corresponding USB port connectors for the computer and for the machine.

→ “Removable Disk” will appear in “My Computer”.

- 4** Copy the upgrade file to “Removable Disk”.

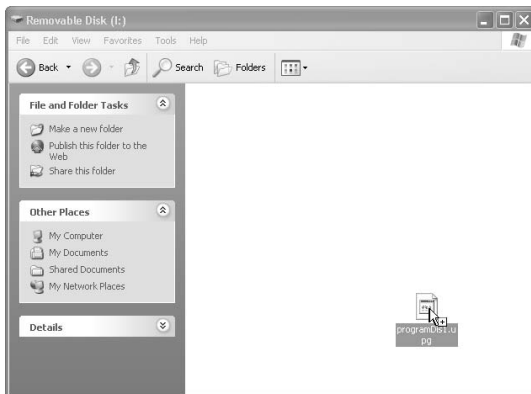

→ The “Connected to PC. Do not disconnect the USB cable.” message will appear.

- 5** When the message disappears, press

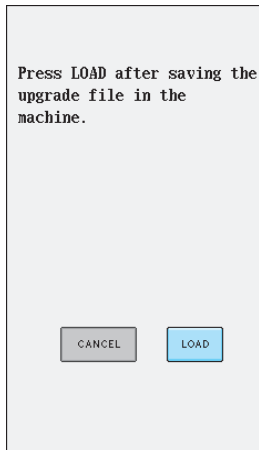

→ The upgrade file is downloaded.



Note

If an error occurs, a red text error message will appear. If the download is performed successfully, an “Upgrade complete.” message will appear.

- 6** Unplug the USB cable, and turn the machine off and on again.

















































































































8































































Appendix

STITCH SETTING CHART































































The following chart shows information for each utility stitch concerning applications, stitch lengths, stitch widths, and whether or not the twin needle mode can be used.















































Stitch	Stitch name	Presser foot		Applications	Stitch width [mm (inch.)]		Stitch length [mm (inch.)]		Twin needle
					Auto.	Manual	Auto.	Manual	
	Straight stitch (Left)			General sewing, gather, pintuck, etc. Reverse stitch is sewn while pressing "Reverse/Reinforcement Stitch" button.	0.0 (0)	0.0 - 7.0 (0 - 1/4)	2.5 (3/32)	0.2 - 5.0 (1/64 - 3/16)	OK (J)
	Straight stitch (Left)			General sewing, gather, pintuck, etc. Reinforcement stitch is sewn while pressing "Reverse/Reinforcement Stitch" button.	0.0 (0)	0.0 - 7.0 (0 - 1/4)	2.5 (3/32)	0.2 - 5.0 (1/64 - 3/16)	OK (J)
	Straight stitch (Middle)			General sewing, gather, pintuck, etc. Reverse stitch is sewn while pressing "Reverse/Reinforcement Stitch" button.	3.5 (1/8)	0.0 - 7.0 (0 - 1/4)	2.5 (3/32)	0.2 - 5.0 (1/64 - 3/16)	OK (J)
	Straight stitch (Middle)			General sewing, gather, pintuck, etc. Reinforcement stitch is sewn while pressing "Reverse/Reinforcement Stitch" button.	3.5 (1/8)	0.0 - 7.0 (0 - 1/4)	2.5 (3/32)	0.2 - 5.0 (1/64 - 3/16)	OK (J)
	Triple stretch stitch			General sewing for reinforcement and decorative topstitching	0.0 (0)	0.0 - 7.0 (0 - 1/4)	2.5 (3/32)	1.5 - 4.0 (1/16 - 3/16)	OK (J)
	Stem stitch			Reinforced stitching, sewing and decorative applications	1.0 (1/16)	1.0 - 3.0 (1/16 - 1/8)	2.5 (3/32)	1.0 - 4.0 (1/16 - 3/16)	OK (J)
	Decorative stitch			Decorative stitching, top stitching	0.0 (0)	0.0 - 7.0 (0 - 1/4)	2.5 (3/32)	1.0 - 4.0 (1/16 - 3/16)	OK (J)
	Basting stitch			Basting	0.0 (0)	0.0 - 7.0 (0 - 1/4)	20.0 (3/4)	5.0 - 30.0 (3/16 - 1-3/16)	NO
	Zigzag stitch			For overcasting, mending. Reverse stitch is sewn while pressing "Reverse/Reinforcement Stitch" button.	3.5 (1/8)	0.0 - 7.0 (0 - 1/4)	1.4 (1/16)	0.0 - 4.0 (0 - 3/16)	OK (J)
	Zigzag stitch			For overcasting, mending. Reinforcement stitch is sewn while pressing "Reverse/Reinforcement Stitch" button.	3.5 (1/8)	0.0 - 7.0 (0 - 1/4)	1.4 (1/16)	0.0 - 4.0 (0 - 3/16)	OK (J)
	Zigzag stitch (right)			Start from right needle position, zigzag sew at left.	3.5 (1/8)	2.5 - 5.0 (3/32 - 3/16)	1.4 (1/16)	0.3 - 4.0 (1/64 - 3/16)	OK (J)
	Zigzag stitch (left)			Start from left needle position, zigzag sew at right.	3.5 (1/8)	2.5 - 5.0 (3/32 - 3/16)	1.4 (1/16)	0.3 - 4.0 (1/64 - 3/16)	OK (J)
	2 step elastic zigzag			Overcasting (medium weight and stretch fabrics), tape and elastic	5.0 (3/16)	1.5 - 7.0 (1/16 - 1/4)	1.0 (1/16)	0.2 - 4.0 (1/64 - 1/16)	OK (J)
	2 step elastic zigzag			Overcasting (medium weight and stretch fabrics), tape and elastic	5.0 (3/16)	1.5 - 7.0 (1/16 - 1/4)	1.0 (1/16)	0.2 - 4.0 (1/64 - 1/16)	OK (J)
	3 step elastic zigzag			Overcasting (medium, heavyweight and stretch fabrics), tape and elastic	5.0 (3/16)	1.5 - 7.0 (1/16 - 1/4)	1.0 (1/16)	0.2 - 4.0 (1/64 - 1/16)	OK (J)
	Overcasting stitch			Reinforcing of light and medium weight fabrics	3.5 (1/8)	2.5 - 5.0 (3/32 - 3/16)	2.0 (1/16)	1.0 - 4.0 (1/16 - 3/16)	NO

















































Stitch	Stitch name	Presser foot		Applications	Stitch width [mm (inch.)]		Stitch length [mm (inch.)]		Twin needle
					Auto.	Manual	Auto.	Manual	
	Overcasting stitch			Reinforcing of heavyweight fabric	5.0 (3/16)	2.5 - 5.0 (3/32 - 3/16)	2.5 (3/32)	1.0 - 4.0 (1/16 - 3/16)	NO
	Overcasting stitch			Reinforcing of medium, heavyweight and easily frayable fabrics or decorative stitching.	5.0 (3/16)	3.5 - 5.0 (1/8 - 3/16)	2.5 (3/32)	1.0 - 4.0 (1/16 - 3/16)	NO
	Overcasting stitch			Reinforced seaming of stretch fabric	5.0 (3/16)	0.0 - 7.0 (0 - 9/32)	2.5 (3/32)	0.5 - 4.0 (1/32 - 3/16)	OK (J)
	Overcasting stitch			Reinforcing of medium stretch fabric and heavyweight fabric, decorative stitching	5.0 (3/16)	0.0 - 7.0 (0 - 9/32)	2.5 (3/32)	0.5 - 4.0 (1/32 - 3/16)	OK (J)
	Overcasting stitch			Reinforcement of stretch fabric or decorative stitching	4.0 (3/16)	0.0 - 7.0 (0 - 1/4)	4.0 (3/16)	1.0 - 4.0 (1/16 - 3/16)	OK (J)
	Overcasting stitch			Stretch knit seam	5.0 (3/16)	0.0 - 7.0 (0 - 1/4)	4.0 (3/16)	1.0 - 4.0 (1/16 - 3/16)	NO
	Single diamond overcast			Reinforcement and seaming stretch fabric	6.0 (15/64)	1.0 - 7.0 (1/16 - 1/4)	3.0 (1/8)	1.0 - 4.0 (1/16 - 3/16)	OK (J)
	Single diamond overcast			Reinforcement of stretch fabric	6.0 (15/64)	1.0 - 7.0 (1/16 - 1/4)	1.8 (1/16)	1.0 - 4.0 (1/16 - 3/16)	OK (J)
	With side cutter			Straight stitch while cutting fabrics	0.0 (0)	0.0 - 2.5 (0 - 3/32)	2.5 (3/32)	0.2 - 5.0 (1/64 - 3/16)	NO
	With side cutter			Zigzag stitch while cutting fabrics	3.5 (1/8)	3.5 - 5.0 (1/8 - 3/16)	1.4 (1/16)	0.0 - 4.0 (0 - 3/16)	NO
	With side cutter			Overcasting stitch while cutting fabrics	3.5 (1/8)	3.5 - 5.0 (1/8 - 3/16)	2.0 (1/16)	1.0 - 4.0 (1/16 - 3/16)	NO
	With side cutter			Overcasting stitch while cutting fabrics	5.0 (3/16)	3.5 - 5.0 (1/8 - 3/16)	2.5 (3/32)	1.0 - 4.0 (1/16 - 3/16)	NO
	With side cutter			Overcasting stitch while cutting fabrics	5.0 (3/16)	3.5 - 5.0 (1/8 - 3/16)	2.5 (3/32)	1.0 - 4.0 (1/16 - 3/16)	NO
	Piecing stitch (Right)			Piecework/patchwork 6.5 mm (approx. 1/4 inch) right seam allowance	5.5 (7/32)	0.0 - 7.0 (0 - 1/4)	2.0 (1/16)	0.2 - 5.0 (1/64 - 3/16)	NO
	Piecing stitch (Middle)			Piecework/patchwork	—	—	2.0 (1/16)	0.2 - 5.0 (1/64 - 3/16)	NO
	Piecing stitch (Left)			Piecework/patchwork 6.5 mm (approx. 1/4 inch) left seam allowance	1.5 (1/16)	0.0 - 7.0 (0 - 1/4)	2.0 (1/16)	0.2 - 5.0 (1/64 - 3/16)	NO
	Hand-look quilting			Quilting stitch made to look like hand quilting stitch	0.0 (0)	0.0 - 7.0 (0 - 1/4)	2.5 (3/32)	1.0 - 4.0 (1/16 - 3/16)	NO
	Quilting appliqué zigzag stitch			Zigzag stitch for quilting and sewing on appliqué quilt pieces	3.5 (1/8)	0.0 - 7.0 (0 - 1/4)	1.4 (1/16)	0.0 - 4.0 (0 - 3/16)	NO
	Quilting appliqué stitch			Quilting stitch for invisible appliqué or attaching binding	1.5 (1/16)	0.5 - 5.0 (1/64 - 3/16)	1.8 (1/16)	1.0 - 4.0 (1/16 - 3/16)	NO
	Quilting stippling			Background quilting	7.0 (1/4)	1.0 - 7.0 (1/16 - 1/4)	1.6 (1/16)	1.0 - 4.0 (1/16 - 3/16)	NO









Stitch	Stitch name	Presser foot		Applications	Stitch width [mm (inch.)]		Stitch length [mm (inch.)]		Twin needle
					Auto.	Manual	Auto.	Manual	
	Blind hem stitch			Hemming woven fabrics	0.0 (0)	+3.0 - -3.0 (+1/8 - -1/8)	2.0 (1/16)	1.0 - 3.5 (1/16 - 1/8)	NO
	Blind hem stitch stretch			Hemming stretch fabric	0.0 (0)	+3.0 - -3.0 (+1/8 - -1/8)	2.0 (1/16)	1.0 - 3.5 (1/16 - 1/8)	NO
	Blanket stitch			Appliqués, decorative blanket stitch	3.5 (1/8)	2.5 - 7.0 (3/32 - 1/4)	2.5 (3/32)	1.6 - 4.0 (1/16 - 3/16)	OK (J)
	Shell tuck edge			Shell tuck edge finish on fabrics	4.0 (3/16)	0.0 - 7.0 (0 - 1/4)	2.5 (3/32)	0.2 - 4.0 (1/64 - 1/16)	OK (J)
	Satin scallop stitch			Decorating collar of blouse, edge of handkerchief	5.0 (3/16)	2.5 - 7.0 (3/32 - 1/4)	0.5 (1/32)	0.1 - 1.0 (1/64 - 1/16)	OK (J)
	Scallop stitch			Decorating collar of blouse, edge of handkerchief	7.0 (1/4)	0.0 - 7.0 (0 - 1/4)	1.4 (1/16)	1.0 - 4.0 (1/16 - 3/16)	NO
	Patchwork join stitch			Patchwork stitches, decorative stitching	4.0 (1/16)	0.0 - 7.0 (0 - 1/4)	1.2 (1/16)	0.2 - 4.0 (1/64 - 1/16)	OK (J)
	Patchwork double overlock stitch			Patchwork stitches, decorative stitching	5.0 (3/16)	2.5 - 7.0 (3/32 - 1/4)	2.5 (3/32)	1.0 - 4.0 (1/16 - 3/16)	OK (J)
	Couching stitch			Decorative stitching, attaching cord and couching	5.0 (3/16)	0.0 - 7.0 (0 - 1/4)	1.2 (1/16)	0.2 - 4.0 (1/64 - 1/16)	OK (J)
	Smocking stitch			Smocking, decorative stitching	5.0 (3/16)	0.0 - 7.0 (0 - 1/4)	1.6 (1/16)	1.0 - 4.0 (1/16 - 3/16)	OK (J)
	Feather stitch			Fagoting, decorative stitching	5.0 (3/16)	0.0 - 7.0 (0 - 1/4)	2.5 (3/32)	1.0 - 4.0 (1/16 - 3/16)	OK (J)
	Fagoting cross stitch			Fagoting, bridging and decorative stitching	5.0 (3/16)	2.5 - 7.0 (3/32 - 1/4)	2.5 (3/32)	1.0 - 4.0 (1/16 - 3/16)	OK (J)
	Tape attaching			Attaching tape to seam in stretch fabric	4.0 (3/16)	0.0 - 7.0 (0 - 1/4)	1.0 (1/16)	0.2 - 4.0 (1/61 - 3/16)	OK (J)
	Ladder stitch			Decorative stitching	4.0 (3/16)	0.0 - 7.0 (0 - 1/4)	3.0 (1/8)	2.0 - 4.0 (1/16 - 3/16)	NO
	Rick-rack stitch			Decorative top stitching	4.0 (3/16)	0.0 - 7.0 (0 - 1/4)	2.5 (3/32)	1.0 - 4.0 (1/16 - 3/16)	OK (J)
	Decorative stitch			Decorative stitching	1.0 (1/16)	1.0 - 3.0 (1/16 - 1/8)	2.5 (3/32)	1.0 - 4.0 (1/16 - 3/16)	OK (J)
	Decorative stitch			Decorative stitching	5.5 (3/16)	0.0 - 7.0 (0 - 1/4)	1.6 (1/16)	1.0 - 4.0 (1/16 - 3/16)	OK (J)
	Serpentine stitch			Decorative stitching and attaching elastic	5.0 (3/16)	1.5 - 7.0 (1/16 - 1/4)	1.0 (1/16)	0.2 - 4.0 (1/64 - 3/16)	OK (J)
	Decorative stitch			Decorative stitching and appliqué	6.0 (15/64)	1.0 - 7.0 (1/16 - 1/4)	1.0 (1/16)	0.2 - 4.0 (1/64 - 3/16)	OK (J)
	Decorative stippling stitch			Decorative stitching	7.0 (1/4)	1.0 - 7.0 (1/16 - 1/4)	1.6 (1/16)	1.0 - 4.0 (1/16 - 3/16)	NO

STITCH SETTING CHART

Stitch	Stitch name	Presser foot		Applications	Stitch width [mm (inch.)]		Stitch length [mm (inch.)]		Twin needle
					Auto.	Manual	Auto.	Manual	
	Hemstitching			Decorative hems, triple straight at left	1.0 (1/16)	1.0 - 7.0 (1/16 - 1/4)	2.5 (3/32)	1.5 - 4.0 (1/16 - 3/16)	OK (J)
	Hemstitching			Decorative hems, triple straight at center	3.5 (1/8)	1.0 - 7.0 (1/16 - 1/4)	2.5 (3/32)	1.5 - 4.0 (1/16 - 3/16)	OK (J)
	Hemstitching zigzag			Decorative hems, top stitching	6.0 (15/64)	1.5 - 7.0 (1/16 - 1/4)	3.0 (1/8)	1.0 - 4.0 (1/16 - 3/16)	OK (J)
	Hemstitching			Decorative hems, lace attaching pin stitch	3.5 (1/8)	1.5 - 7.0 (1/16 - 1/4)	2.5 (3/32)	1.6 - 4.0 (1/16 - 3/16)	NO
	Hemstitching			Decorative hems	3.0 (1/8)	1.5 - 7.0 (1/16 - 1/4)	3.5 (1/8)	1.6 - 4.0 (1/16 - 3/16)	NO
	Hemstitching			Decorative hems daisy stitch	6.0 (15/64)	1.5 - 7.0 (1/16 - 1/4)	3.0 (1/8)	1.5 - 4.0 (1/16 - 3/16)	NO
	Hemstitching			Heirloom, decorative hems	5.0 (3/16)	1.5 - 7.0 (1/16 - 1/4)	3.5 (1/8)	1.6 - 4.0 (1/16 - 3/16)	NO
	Hemstitching			Heirloom, decorative hems	5.0 (3/16)	1.5 - 7.0 (1/16 - 1/4)	3.5 (1/8)	1.5 - 4.0 (1/16 - 3/16)	NO
	Hemstitching			Heirloom, decorative hems	5.0 (3/16)	1.5 - 7.0 (1/16 - 1/4)	3.5 (1/8)	1.6 - 4.0 (1/16 - 3/16)	OK (J)
	Hemstitching			Heirloom, decorative hems	5.0 (3/16)	1.5 - 7.0 (1/16 - 1/4)	4.0 (3/16)	1.5 - 4.0 (1/16 - 3/16)	OK (J)
	Hemstitching			Heirloom, decorative hems	4.0 (3/16)	1.5 - 7.0 (1/16 - 1/4)	2.5 (3/32)	1.5 - 4.0 (1/16 - 3/16)	OK (J)
	Honeycomb stitch			Heirloom, decorative hems	5.0 (3/64)	1.5 - 7.0 (1/16 - 1/4)	2.5 (3/32)	1.5 - 4.0 (1/16 - 3/16)	OK (J)
	Honeycomb stitch			Heirloom, decorative hems	6.0 (15/64)	1.5 - 7.0 (1/16 - 1/4)	3.5 (1/8)	1.5 - 4.0 (1/16 - 3/16)	OK (J)
	Hemstitching			Heirloom, decorative hems	6.0 (15/64)	1.5 - 7.0 (1/16 - 1/4)	1.6 (1/16)	1.0 - 4.0 (1/16 - 3/16)	OK (J)
	Hemstitching			Heirloom, decorative hems	6.0 (15/64)	1.5 - 7.0 (1/16 - 1/4)	3.0 (1/8)	1.5 - 4.0 (1/16 - 3/16)	NO
	Hemstitching			Heirloom, decorative hems	6.0 (15/64)	1.5 - 7.0 (1/16 - 1/4)	4.0 (3/16)	1.5 - 4.0 (1/16 - 3/16)	OK (J)
	Hemstitching			Heirloom, decorative hems	4.0 (3/16)	1.5 - 7.0 (1/16 - 1/4)	2.5 (3/32)	1.6 - 4.0 (1/16 - 3/16)	NO
	Hemstitching			Heirloom, decorative hems	5.0 (3/16)	1.5 - 7.0 (1/16 - 1/4)	2.0 (1/16)	1.5 - 4.0 (1/16 - 3/16)	OK (J)
	Hemstitching			Decorative hems and bridging stitch	6.0 (15/64)	1.5 - 7.0 (1/16 - 1/4)	2.0 (1/16)	1.5 - 4.0 (1/16 - 3/16)	OK (J)
	Hemstitching			Decorative hems. Fagoting, attaching ribbon	5.0 (3/16)	1.5 - 7.0 (1/16 - 1/4)	3.0 (1/8)	1.5 - 4.0 (1/16 - 3/16)	OK (J)

Stitch	Stitch name	Presser foot		Applications	Stitch width [mm (inch.)]		Stitch length [mm (inch.)]		Twin needle
					Auto.	Manual	Auto.	Manual	
	Hemstitching			Decorative hems, smocking	6.0 (15/64)	1.5 - 7.0 (1/16 - 1/4)	1.6 (1/16)	1.0 - 4.0 (1/16 - 3/16)	NO
	Hemstitching			Decorative hems, smocking	5.0 (3/16)	1.5 - 7.0 (1/16 - 1/4)	1.6 (1/16)	1.0 - 4.0 (1/16 - 3/16)	NO
	Hemstitching			Decorative hems, smocking	5.0 (3/16)	1.5 - 7.0 (1/16 - 1/4)	1.6 (1/16)	1.0 - 4.0 (1/16 - 3/16)	NO
	Hemstitching			Decorative hems	5.0 (3/16)	1.5 - 7.0 (1/16 - 1/4)	1.6 (1/16)	1.0 - 4.0 (1/16 - 3/16)	NO
	Ladder stitch			Decorative hems. Fagoting, attaching ribbon	7.0 (1/4)	5.0 - 7.0 (3/16 - 1/4)	1.6 (1/16)	1.0 - 4.0 (1/16 - 3/16)	NO
	Narrow rounded buttonhole			Buttonhole on light to medium weight fabrics	5.0 (3/16)	3.0 - 5.0 (1/8 - 3/16)	0.4 (1/64)	0.2 - 1.0 (1/64 - 1/16)	NO
	Wide round ended buttonhole			Buttonholes with extra space for larger buttons	5.5 (7/32)	3.5 - 5.5 (1/8 - 7/32)	0.4 (1/64)	0.2 - 1.0 (1/64 - 1/16)	NO
	Tapered round ended buttonhole			Reinforced waist tapered buttonholes	5.0 (3/16)	3.0 - 5.0 (1/8 - 3/16)	0.4 (1/64)	0.2 - 1.0 (1/64 - 1/16)	NO
	Round ended buttonhole			Buttonholes with vertical bar tack in heavyweight fabrics	5.0 (3/16)	3.0 - 5.0 (1/8 - 3/16)	0.4 (1/64)	0.2 - 1.0 (1/64 - 1/16)	NO
	Round ended buttonhole			Buttonholes with bar tack	5.0 (3/16)	3.0 - 5.0 (1/8 - 3/16)	0.4 (1/64)	0.2 - 1.0 (1/64 - 1/16)	NO
	Round double ended buttonhole			Buttonholes for fine, medium to heavyweight fabrics	5.0 (3/16)	3.0 - 5.0 (1/8 - 3/16)	0.4 (1/64)	0.2 - 1.0 (1/64 - 1/16)	NO
	Narrow squared buttonhole			Buttonholes for light to medium weight fabrics	5.0 (3/16)	3.0 - 5.0 (1/8 - 3/16)	0.4 (1/64)	0.2 - 1.0 (1/64 - 1/16)	NO
	Wide squared buttonhole			Buttonholes with extra space for larger decorative buttons	5.5 (7/32)	3.5 - 5.5 (1/8 - 7/32)	0.4 (1/64)	0.2 - 1.0 (1/64 - 1/16)	NO
	Squared buttonhole			Heavy-duty buttonholes with vertical bar tacks	5.0 (7/32)	3.0 - 5.0 (1/8 - 3/16)	0.4 (1/64)	0.2 - 1.0 (1/64 - 1/16)	NO
	Stretch buttonhole			Buttonholes for stretch or woven fabrics	6.0 (15/64)	3.0 - 6.0 (1/8 - 15/64)	1.0 (1/16)	0.5 - 2.0 (1/32 - 1/16)	NO
	Heirloom buttonhole			Buttonholes for heirloom and stretch fabrics	6.0 (15/64)	3.0 - 6.0 (1/8 - 15/64)	1.5 (1/16)	1.0 - 3.0 (1/1 - 1/8)	NO
	Bound buttonhole			The first step in making bound buttonholes	5.0 (3/16)	0.0 - 6.0 (0 - 15/64)	2.0 (1/16)	0.2 - 4.0 (1/64 - 3/16)	NO
	Keyhole buttonhole			Buttonholes in heavyweight or thick fabrics for larger flat buttons	7.0 (1/4)	3.0 - 7.0 (1/8 - 1/4)	0.5 (1/32)	0.3 - 1.0 (1/64 - 1/16)	NO
	Tapered keyhole buttonhole			Buttonholes in medium to heavy weight fabrics for larger flat buttons	7.0 (1/4)	3.0 - 7.0 (1/8 - 1/4)	0.5 (1/32)	0.3 - 1.0 (1/64 - 1/16)	NO
	Keyhole buttonhole			Buttonholes with vertical bar tack for reinforcement in heavyweight or thick fabrics	7.0 (1/4)	3.0 - 7.0 (1/8 - 1/4)	0.5 (1/32)	0.3 - 1.0 (1/64 - 1/16)	NO

Stitch	Stitch name	Presser foot		Applications	Stitch width [mm (inch.)]		Stitch length [mm (inch.)]		Twin needle
					Auto.	Manual	Auto.	Manual	
	4 step buttonhole 1			Left side of 4 step buttonhole	5.0 (7/32)	1.5 - 7.0 (1/16 - 1/4)	0.4 (1/64)	0.2 - 1.0 (1/64 - 1/16)	NO
	4 step buttonhole 2			Bar tack of 4 step buttonhole	5.0 (7/32)	1.5 - 7.0 (1/16 - 1/4)	0.4 (1/64)	0.2 - 1.0 (1/64 - 1/16)	NO
	4 step buttonhole 3			Right side of 4 step buttonhole	5.0 (7/32)	1.5 - 7.0 (1/16 - 1/4)	0.4 (1/64)	0.2 - 1.0 (1/64 - 1/16)	NO
	4 step buttonhole 4			Bar tack of 4 step buttonhole	5.0 (7/32)	1.5 - 7.0 (1/16 - 1/4)	0.4 (1/64)	0.2 - 1.0 (1/64 - 1/16)	NO
	Darning			Darning of medium weight fabric	7.0 (1/4)	2.5 - 7.0 (3/32 - 1/4)	2.0 (1/16)	0.4 - 2.5 (1/64 - 1/16)	NO
	Darning			Darning of heavyweight fabric	7.0 (1/4)	2.5 - 7.0 (3/32 - 1/4)	2.0 (1/16)	0.4 - 2.5 (1/64 - 1/16)	NO
	Bar tack			Reinforcement at opening of pocket, etc.	2.0 (1/16)	1.0 - 3.0 (1/16 - 1/8)	0.4 (1/64)	0.3 - 1.0 (1/64 - 1/16)	NO
	Button sewing			Attaching buttons	3.5 (1/8)	2.5 - 4.5 (3/32 - 3/16)	—	—	NO
	Eyelet			For making eyelets, holes on belts, etc.	7.0 (1/4)	7.0 6.0 5.0 (1/4 15/64 3/16)	7.0 (1/4)	7.0 6.0 5.0 (1/4 15/64 3/16)	NO
	Star eyelet			For making star-shaped eyelets on holes.	—	—	—	—	NO
	Diagonally left up (Straight)			For attaching appliqué on tubular pieces of fabric and mitering corners	—	—	—	—	NO
	Reverse (Straight)			For attaching appliqué on tubular pieces of fabric and mitering corners	—	—	—	—	NO
	Diagonally right up (Straight)			For attaching appliqué on tubular pieces of fabric and mitering corners	—	—	—	—	NO
	Sideways to left (Straight)			For attaching appliqué on tubular pieces of fabric	—	—	—	—	NO
	Sideways to right (Straight)			For attaching appliqué on tubular pieces of fabric	—	—	—	—	NO
	Diagonally left down (Straight)			For attaching appliqué on tubular pieces of fabric and mitering corners	—	—	—	—	NO
	Forward (Straight)			For attaching appliqué on tubular pieces of fabric and mitering corners	—	—	—	—	NO
	Diagonally right down (Straight)			For attaching appliqué on tubular pieces of fabric and mitering corners	—	—	—	—	NO
	Sideways to left (Zigzag)			For attaching appliqué on tubular pieces of fabric	—	—	—	—	NO
	Sideways to right (Zigzag)			For attaching appliqué on tubular pieces of fabric	—	—	—	—	NO

Stitch	Stitch name	Presser foot		Applications	Stitch width [mm (inch.)]		Stitch length [mm (inch.)]		Twin needle
					Auto.	Manual	Auto.	Manual	
	Forward (Zigzag)			For attaching appliqué on tubular pieces of fabric and mitering corners	—	—	—	—	NO
	Reverse (Zigzag)			For attaching appliqué on tubular pieces of fabric and mitering corners	—	—	—	—	NO

Index

A

Accessories	
included accessories	4
options	7
Accessory compartment	4
Adjustments	
screen	238
screen brightness	19, 238
Air vent	1
Alarm sounds	248
Alphabet characters	
character/decorative stitches	118
embroidery	152
embroidery edit	200
Appliqué	90
embroidery patterns	168
quilting	81
using a zigzag stitch	71
using an embroidery frame pattern	194
Array key	201, 207
Arrow keys	179, 205, 220, 229
automatic fabric sensor system	55
Automatic reinforcement stitch key	51
Automatic thread cutting key	52
Automatic Threading button	3, 29

B

Back to beginning key	126
Ball point needle 75/107	41, 175
Bar tacks	105
Basting	67
Blind hem stitches	89
Block move key	231
Bobbin	
pulling up the bobbin thread	28
runs out of thread	170
setting	26
winding	23
Bobbin case (green screw, no marking)	165, 236
Bobbin cover	2, 27
Bobbin holder (switch)	25
Bobbin winder	1
Border key	213, 216
Button sewing	107
4 hole buttons	108
shank	108
Buttonhole lever	2, 99, 104
Buttonholes	
four-step	101
odd-shaped/buttons that do not fit the button holder plate	100
one-step	97

C

Character spacing key	207
Character/Decorative Stitches	
adjustments	121
combining	128
editing	123
key functions	123
retrieving	140, 141
saving	136, 138, 139
selecting	116
sewing	120
stitch selection screens	117
Cleaning	
LCD screen	236
machine casing	236

race	236
Combining Patterns	
character/decorative stitches	128
embroidery edit	219
Cord guide bobbin cover	72
Crazy quilt	72
Custom Thread Table	210, 212
Cut/Tension key	174

D

Darning	103
Dart seam	67
Density key	183

E

echo quilting	86
Edit end key	217
Editing	
character/decorative stitches	123
embroidery	179
embroidery edit	203
MY CUSTOM STITCH	228
Elastic zigzag stitches	73
Elongation key	125
Embroidery	
adjusting the speed	176
automatic thread cutting function (END COLOR TRIM)	175
edges or corners	160
key functions	156
restarting from the beginning	172
resuming embroidery after turning off the power	172
ribbons or tape	161
selecting patterns	149
small fabrics	160
thread color display	177
thread trimming function (JUMP STITCH TRIM)	175
Embroidery card	154
Embroidery card slot	1
Embroidery edit	
changing the thread color	209
combined patterns	219, 222
custom thread table	210, 212
explanation of functions	198
key functions	204
repeated patterns	213
Embroidery foot "W"	145
Embroidery frame display	178
Embroidery frames	
attaching	162
inserting fabric	159
removing	162
types	158
using the embroidery sheet	160
Embroidery needle plate cover	165
Embroidery patterns	
checking the position	163
combining	219
editing	203
pattern selection screens	150
patterns which use appliqué	168
retrieving	191, 192
revising	179
saving	187, 189, 190
selecting	149, 199
sewing	165
using a frame pattern to make an appliqué	194, 195
Embroidery sheet	160
Embroidery unit	3, 146

carriage	3
carrying case	4
Enlarger key	229
Error messages	243
Eyellet	109

F

Fabrics	
fabric/thread/needle combinations	41
sewing heavyweight fabrics	47
sewing lightweight fabrics	48
sewing stretch fabrics	48, 100
Fagoting	93
Feed dog position switch	1, 3, 83, 85, 107
Feed dogs	2, 83, 107
Flat bed attachment	1, 146
Flat fell Seam	69
Foot controller	1, 45
Forward/Back key	171, 172
free-motion quilting	
free-motion echo quilting foot "E"	86
free-motion open toe quilting foot "O"	85
free-motion quilting foot "C"	83
free-motion sewing mode	83

G

Gathering	68
Grid direction key	229

H

Handle	1
Handwheel	1, 31
Hard case	7
Heirloom	95
Hemstitching	
daisy stitch	95
drawn work	96

I

Image key	59, 127, 164, 230
Insert key	232

K

Key functions	
character/decorative stitches	123
embroidery	156
embroidery edit	204
MY CUSTOM STITCH	228
utility stitches	12
Knee lifter	1, 53

L

LCD screen	
adjusting	1, 11
cleaning	238
locking	236
winding	55
Lower threading	
pulling up the bobbin thread	28
setting the bobbin	26
winding the bobbin	23

M

Machine operation mode key	21, 240
Main power switch	1, 10
Maintenance Message	236
Mirror image key	59, 125, 183
Multi color key	184, 209
Multi-directional sewing	110

MY CUSTOM STITCH

designing	226
entering data	228
key functions	228
retrieving	234
saving	233
storing in your list	233

N

Needle	
changing the needle	39
changing the needle position	65
fabric/thread/needle combinations	41
mode	11
twin needle	34
Needle bar thread guides	2, 33, 34
Needle clamp screw	2
Needle mode selection key	34
Needle plate	2
Needle position	65
Needle Position button	3

O

Operation buttons	1, 3
Overcasting	71, 73, 74

P

Patchwork	72
Piecing	80
Pintuck	69
pivoting	53
Point delete key	230
Power cord	10
Power cord receptacle	1
Presser foot	
attaching	37
pressure	55
removing	37
types	253
Presser foot code	11, 155
Presser foot holder	2, 37
Presser foot holder screw	2
Presser foot lever	1, 47
Presser Foot Lifter button	3
Presser foot/Needle exchange key	31, 34, 37, 39, 145
Pretension disk	1, 24, 26

Q

Quilting	
free-motion	79
with satin stitches	83
with satin stitches	82

R

Race	236
Repeated patterns	213
Retrieving	
character/decorative stitch patterns	140
computer	142, 192
embroidery patterns	191
machine's memory	140, 191
MY CUSTOM STITCH designs	234
stitch settings	61
USB media	141, 191
utility stitches	61
Reverse/Reinforcement Stitch button	3, 46, 51
Reverse/Reinforcement stitches	46, 51
Rotate key	182, 205

S

Satin stitches	82, 126
Saving	
character/decorative stitches	136
computer	139, 190
embroidery patterns	187
machine's memory	136, 187
MY CUSTOM STITCH designs	233
stitch settings	60
USB media	138, 189
utility stitches	60
Scallop stitches	92
Set key	229
Settings	
automatic reinforcement stitching	51
automatic thread cutting	52, 175
display language	20
embroidery settings	18
general settings	17
machine setting mode key	16, 176, 210
screen brightness	19
sewing settings	16
stitch length	49
stitch width	49
thread tension	50, 174
thread trimming	175
Sewing speed controller (speed control slide)	1, 3, 44
Sewing type selection key	61
Shelltuck stitches	91
Side cutter	76
Single/Repeat sewing key	125
Single/triple stitching key	229
Size key	181, 206
Size selection key	124
Smocking stitches	93
Specifications	249
Spool cap	1
Spool net	36
Spool pin	1
Stabilizer	157
Start/Stop button	3
Starting point key	180
Step stitch patterns	132
Stitch setting chart	253
Straight stitch foot	65
Straight stitch needle plate	65
Straight stitches	63
Supplemental spool pin	1, 23, 34

T

Take-up lever	33
Tape attaching	73
Tape or elastic attaching	94
Test key	230, 233
Thread	
fabric/thread/needle combinations	41
thread tension	50, 174
Thread color display	177
Thread cutter	1, 45
Thread Cutter button	3
Thread density key	126
Thread guide	1, 24, 26, 35
Thread guide plate	1, 26, 29
Thread marks	216
Thread palette key	209, 212
Thread take-up lever check window	1, 33
Top cover	1
Top stitching	92
Touch pen	210, 229, 238
holder	1
Trial key	163
Troubleshooting	240
Twin needle	34

U

Upgrading	250
Upper threading	
threading manually	31
twin needle mode	34
using the "Automatic Threading" button	29
using the spool net	36
using the vertical spool pin	36
USB media	
recalling	141, 191
saving	138, 189
usable	134, 185
USB port connector	
for computer	1, 139, 190
for media	1, 138, 189
Utility stitches	
key functions	12
pattern explanation key	22
retrieving	61
saving	60
selecting	58
sewing type selection key	61
stitch selection screens	58
stitch setting chart	253

V

Vertical spool pin	36
--------------------------	----

W

Walking foot	38
--------------------	----

Z

Zigzag stitches	71
Zipper insertion	
centered	111
side	112

English
882-S85
Printed in Taiwan



XF3896-001