

AppiquéStation

Operation manual
Manuel d'instructions
Manual de instrucciones

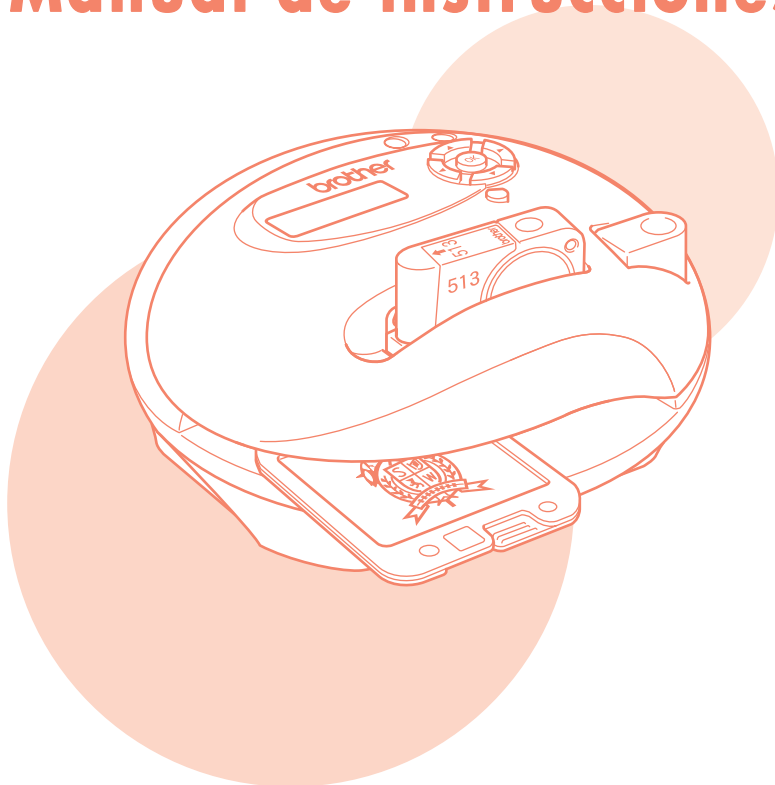

brother®

IMPORTANT SAFETY INSTRUCTIONS

When using this machine, basic safety precautions should always be taken, including the following:

Please read all instructions before using.

DANGER - To reduce the risk of electric shock:

The machine should never be left unattended while plugged in. Always unplug the machine from the electrical outlet immediately after using and before cleaning.

WARNING - To reduce the risk of burns, fire, electric shock, or personal injury:

1. This product should be used only for its intended purpose. Caution is necessary when the machine is used by or near children.
2. Operate this machine only for its intended use as described in this manual. Use only accessories recommended by the manufacturer as contained in this manual.
3. Never operate this machine or AC adapter if it has a damaged cord or plug, if it is not working properly, if it has been dropped or damaged, or dropped into water. Return the machine to the nearest authorized dealer or service center for examination, repair, electrical or mechanical adjustment.
4. Never operate the machine with any air openings blocked. Keep ventilation openings of the machine free from the accumulation of lint, dust, and loose cloth.
5. Never drop or insert any object into any opening.
6. Do not use outdoors.
7. Do not operate where aerosol (spray) products are being used or where oxygen is being administered.
8. Do not unplug by pulling on the cord. To unplug, grasp the plug, not the cord, and carefully remove from the electrical wall outlet.
9. Keep fingers away from all moving parts.

SAVE THESE INSTRUCTIONS

This machine is intended for household use.

FOR USERS IN THE UK, EIRE, MALTA AND CYPRUS ONLY

If this machine is fitted with a three-pin non-rewireable BS plug, then please read the following.

IMPORTANT

If the available socket outlet is not suitable for the plug supplied with this equipment, it should be cut off and an appropriate three-pin plug fitted. With alternative plugs, an approved fuse must be fitted in the plug.

NOTE

The plug served from the main lead must be destroyed as a plug with bared flexible cords is hazardous if engaged in a live socket outlet. In the event of replacing the plug fuse, use a fuse approved by ASTA to BS 1362, i.e., carrying the  mark, rating as marked on the plug.

Always replace the fuse cover, never use plugs with the fuse cover omitted.

WARNING

DO NOT CONNECT EITHER WIRE TO THE EARTH TERMINAL WHICH IS MARKED WITH THE LETTER 'E', BY THE EARTH SYMBOL \perp OR COLOURED GREEN OR GREEN AND YELLOW.

The wires in this main lead are coloured in accordance with the following code:

Blue	Neutral
Brown	Live

As the colours of the wiring in the main lead of this appliance may not correspond with the coloured markings identifying the terminals in your plug, proceed as follows.

The wire which is coloured blue must be connected to the terminal which is marked with the letter 'N' or coloured black or blue.

The wire which is coloured brown must be connected to the terminal which is marked with the letter 'L' or coloured red or brown.

Important (in the United Kingdom)

- Mains Supply (AC 230/240V, 50Hz only)
- DO NOT cut off the mains plug from equipment. If the plug fitted is not suitable for the power point in your home or the cable is too short to reach a power point, then obtain an appropriate safety-approved extension lead or consult your dealer.
- BE SURE to replace the fuse only with an identical approved type, as originally fitted, and to replace the fuse cover.
- If nonetheless the mains plug is cut off, be sure to remove the fuse and dispose of the plug immediately, to avoid a possible shock hazard by inadvertent connection to the mains supply.

CONGRATULATIONS ON CHOOSING OUR MACHINE

Your machine is the latest addition to the exciting world of home embroidery. To fully enjoy all the features, we suggest that you read the manual before using.

PLEASE READ BEFORE USING THIS MACHINE

For safe operation

1. Do not touch the thread cartridge or design frame while embroidering.
2. Remember to unplug the AC adapter:
 - after each use
 - when a power failure occurs during use
 - when maintaining the machine
 - when leaving the machine unattended
3. Do not use an AC adapter other than the models specified for this machine.
4. Plug the AC adapter directly into the wall outlet. Do not use extension cords.
5. Always be sure to turn off the power switch when inserting and removing the embroidery design cassette. Do not remove the embroidery design cassette from the slot while the machine is running. (Please follow the instructions outlined in this instruction manual.)

For a longer service life

1. When storing this machine, avoid direct sunlight and high humidity locations. Do not use or store the machine near a space heater, iron, halogen lamp, or other hot objects.
2. Use only neutral soaps or detergents to clean the outer case. Benzene, thinner, and scouring powders can damage the case and machine, and should never be used.
3. Use caution in order to avoid dropping or hitting the machine or AC adapter.

For repair or adjustment

In the event a malfunction occurs or adjustment is required, first follow the troubleshooting table in the back of this manual to inspect the machine yourself. If the problem persists, please contact your nearest authorized service center.

- Please note that specifications and external appearance are subject to change for improvement without notice.

INTRODUCTION

Congratulations on choosing this embroidery machine!

With your new machine, you can quickly and easily embroider appliqués for your clothes, book bags, or anything else you can imagine. Using the wide range of thread colors available, you can sew embroidery from any of the built-in patterns. There are also many other patterns available on design cassettes sold separately.

After embroidering the appliqué, you can cut it out and iron it onto anything made of fabric, using the enclosed iron-on adhesive film. You can also attach it to other objects, using commercially available double-sided tape. There are many washable fabric adhesives available at your local craft retailer.

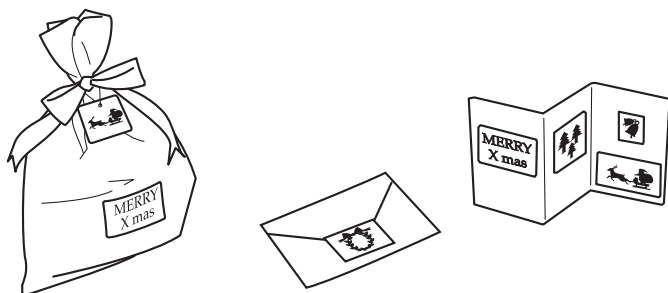
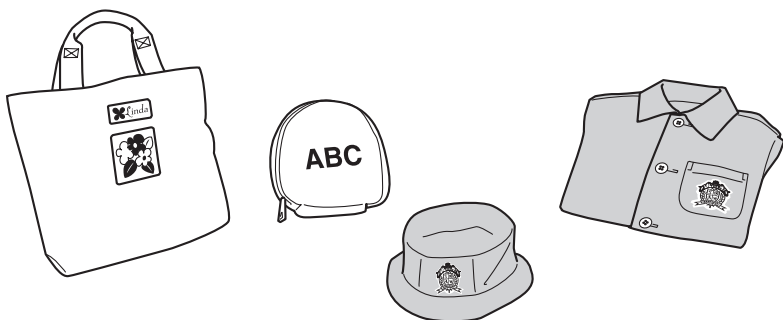

Visit www.brother.com for more project ideas.

Contents

Chapter 1	Before You Start.....	1
<hr/>		
	Unpacking	1
	Supplies	2
	Basic supplies	2
	Optional supplies.....	2
	Important parts.....	3
	Machine	3
	Operation keys	3
	LCD display.....	4
	Design frame	4
	Thread cartridge.....	4
	Useful vocabulary.....	5
Chapter 2	Overview and Patterns.....	7
<hr/>		
	Overview	7
	Types of patterns	8
	Reading the pattern list.....	8
Chapter 3	Making an Embroidered Appliqué.....	9
<hr/>		
	Making an embroidered appliqué from a one-point pattern	9
Step 1	Getting ready	9
Step 2	Starting up the machine	11
Step 3	Selecting the pattern	11
Step 4	Inserting the thread cartridge and design frame.....	13
Step 5	Embroidering the appliqué	17
Step 6	Selecting the next operation.....	20
Step 7	Finishing the appliqué	21
Step 8	Attaching the appliqué	23
	Chenille embroidery	25

Working with text (when a frame or template pattern is selected)	27
Entering text.....	28
Changing the text.....	31
Checking the text.....	32
Chapter 4 Additional Operations.....	33
<hr/>	
Selecting a pattern from a Design cassette	33
Saving a pattern.....	34
If a pattern has not yet been saved in the selected pocket:	35
If a pattern has already been saved in the selected pocket:.....	35
Retrieving a saved pattern	37
Checking the text in a saved pattern.....	39
Editing the text in a saved pattern	40
Stopping and continuing embroidering.....	41
Continuing embroidering after your machine is turned off	43
Removing the design frame	44
Pulling the thread end out of the cartridge.....	45
Changing the contrast of the LCD display	47
If the safety mechanism was activated.....	48
Chapter 5 Appendix.....	49
<hr/>	
Cleaning precautions	49
Troubleshooting.....	49
Error screens.....	50
Specifications	52
Index	53
Chapter 6 Quick Reference Guide	55
<hr/>	

Chapter 1

Before You Start

Before using your machine, read the information in this chapter to fully understand how to use it.

UNPACKING

Machine

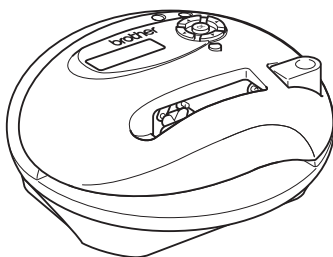

Included accessories

AC adapter

For 120 V areas

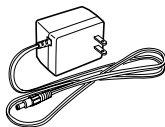

For 230 V areas

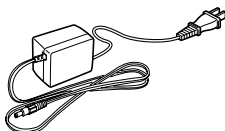

15 Pre-filled thread cartridges
(15 individual thread colors)

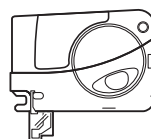

2 Design frames

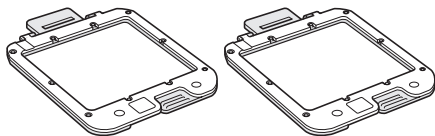

10 Pre-cut design fabrics (4 white, 3 beige & 3 gray)

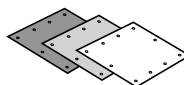

10 Iron-on adhesives

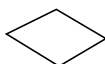

Scissors



Operation manual

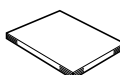

Pattern list

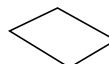

SUPPLIES

Additional pre-cut design fabrics and thread cartridges can be purchased at your nearest Brother retailer. The optional design cassettes that are also available provide a large selection of embroidery patterns.

Basic supplies

Pre-filled thread cartridges

(Visit www.brother.com for a complete listing.)

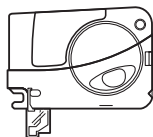

Pre-cut design fabrics with iron-on adhesives

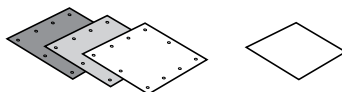

Optional supplies

Design cassettes

(Visit www.brother.com for a complete listing.)

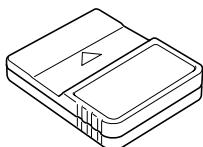

CAUTION

- Only use Brother “AppliquéStation” supplies with this machine. Check to be sure that the supplies have the **AppliquéStation** mark or “for AppliquéStation” on them.

IMPORTANT PARTS

Machine

Top

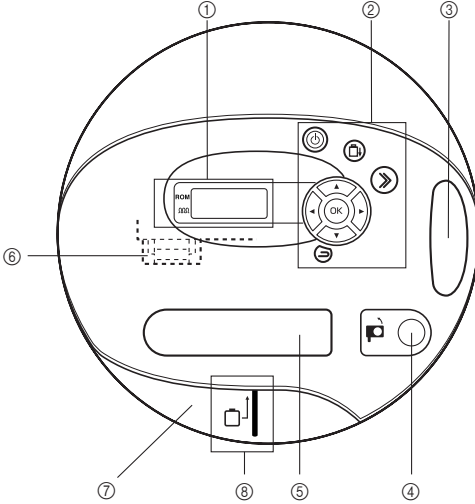

- ① LCD display
- ② Operation keys
- ③ Slot for an optional design cassette
- ④ Thread cartridge release button ()
- ⑤ Thread cartridge slot
- ⑥ Design frame mounting bracket (inside the machine)
- ⑦ Design frame slot
- ⑧ Design frame positioning line
- ⑨ AC adapter connector
- ⑩ Needle position adjustment dial

Back



Bottom

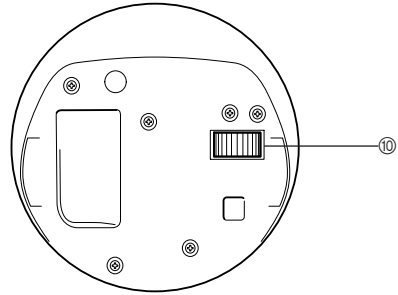

Operation keys



key

Press this key to turn the machine on or off.



key

Press this key to set the design frame for removal from the machine.



key

Press this key to start or stop embroidering.



Press these keys to make a choice (for example, to find the pattern or letter that you want).



key

Press this key to confirm the choice (for example, to select the chosen pattern or letter).



key

Press this key to return to the previous screen.

LCD display

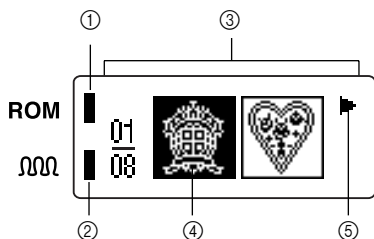

- ① This indicator light appears when a category or pattern from the design cassette is selected.
- ② This indicator light appears when the part of the pattern that is displayed or being sewn will have a chenille texture. (For more details, see page 25.)
- ③ Patterns and instructions appear in this part of the LCD display.
- ④ The chosen pattern or letter is highlighted.
- ⑤ If ▲, ▼, ◀ or ▶ appears, press the ▲, ▼, ◀ or ▶ key to display more information, patterns or letters.

Design frame

The A side of the design frame is white, and the B side is gray.

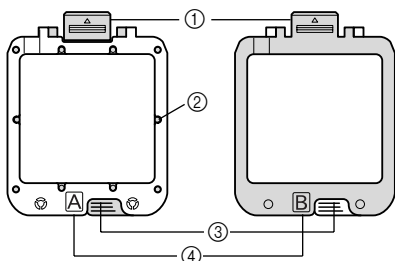

- ① Design frame mount
- ② Pre-cut design fabric pins
- ③ Frame-opening tabs
- ④ Frame side marks

Thread cartridge

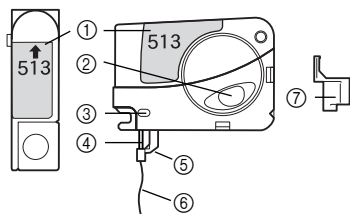

- ① Thread color ID number (The color of the label corresponds to the color of the thread.)
- ② Look in this window to see how much thread is left in the cartridge.
- ③ Guide
- ④ Needle
- ⑤ Presser foot
- ⑥ Thread (Normally 3/4" to 1" (2 to 3 cm) of thread should hang out of the bottom of the cartridge.)
- ⑦ Needle guard cap

⚠ WARNING

To prevent injuries, keep the needle guard cap over the needle when the thread cartridge is not being used. Also, do not try to disassemble the thread cartridges.

USEFUL VOCABULARY

Below is a handy reference list of terms used in this manual.

Character	A letter, number or symbol
Font	A style of characters
Highlight	The darker part of the screen that shows a selection
Jump stitches	Stitches that connect the ending point of one part of the pattern to the starting point of another part of the pattern when sewing different parts of the pattern with the same color
Chenille	Embroidery made of looped threads, similar to a terry cloth towel
Pocket	Computer memory area in the machine where a pattern can be stored
Right side	The front of the embroidery
ROM	Readable Optic Memory
Wrong side	The back of the embroidery



CONTENTS
Chapter 1
Chapter 2
Chapter 3
Chapter 4
Chapter 5
INDEX
Chapter 6

Chapter 2

Overview and Patterns

This chapter gives a simple overview on how to embroider an appliqué, and describes the different types of patterns that can be embroidered.

OVERVIEW

The following is a general description of how to make an embroidered appliqué.

- ① From the pattern list, select which pattern to embroider.
- ② Connect the AC adapter. Place the pre-cut design fabric in the design frame.
- ③ Start up this machine.
- ④ Use the operation keys to select the pattern.
- ⑤ Insert the thread cartridge and design frame following the on-screen instructions.
- ⑥ Embroider the appliqué, changing the thread cartridge for each color.
- ⑦ After the embroidery is finished, remove the thread cartridge.
- ⑧ Remove the design frame from the mounting bracket, and then take the appliqué out of the frame.
- ⑨ Use the iron-on adhesive film to secure the threads in the appliqué fabric.
- ⑩ Cut off any extra threads, and then cut out the appliqué in any shape you want.
- ⑪ Attach the appliqué to your favorite garment.





NOTE

- Each item listed above is described in greater detail in *Chapter 3 Making an Embroidered Appliqué*. Follow the instructions in Chapter 3 to learn how to make an embroidered appliqué.

TYPES OF PATTERNS

This machine can embroider three types of patterns. Check the enclosed pattern list for samples and thread color ID numbers.

One-point patterns	These patterns are small designs that can be embroidered as they appear.
Frame patterns	These patterns are made up of a frame and text that you can enter. The  mark in the pattern shows where text can be added.
Template patterns	These patterns are made up of 1 to 4 lines of text that you can enter. The  mark in the pattern shows where text can be added.



NOTE

- The number of letters that can be entered into frame and template patterns depends on the pattern and the selected font. Also, some patterns can only be used with certain fonts.

READING THE PATTERN LIST

The pattern list shows you samples of the embroidery patterns. It also shows you where you can find the pattern you want and helps you decide if you have all the thread colors needed. The symbols and numbers in the pattern list are explained below.

Pattern list (example)



- ① Category icon shown in the LCD display
- ② Type of patterns in the category
- ③ Sample of the embroidery
- ④ Pattern number
- ⑤ “ ΩΩΩ ” means that part of the pattern is embroidered with the chenille texture. (See page 25.)
- ⑥ Thread color ID numbers in the sewing order
- ⑦ Side of design frame used with the thread color
- ⑧ Total number of patterns in the category



NOTE



- A pattern list is included with each optional design cassette.
- The layout and contents of the pattern list may change without notice. (Check our Web site for the latest updates: www.brother.com)

Chapter 3

Making an Embroidered Appliqué

This chapter gives details on each step that you should follow to embroider an appliqué and how to iron it on. In the section *Making an embroidered appliqué from a one-point pattern*, we will practice making an appliqué from a one-point pattern. Since text can be added to frame and template patterns, the section *Working with text (when a frame or template pattern is selected)* explains how to enter the text.

MAKING AN EMBROIDERED APPLIQUÉ FROM A ONE-POINT PATTERN

As an example, the following procedure describes how to embroider  (pattern number 03) of the built-in pattern category . For pattern numbers and samples, refer to the pattern list.

1. Getting ready

- 1 Insert the plug on the AC adapter cord into the connector on the back of the machine.
- 2 Plug the adapter into an electrical wall outlet.

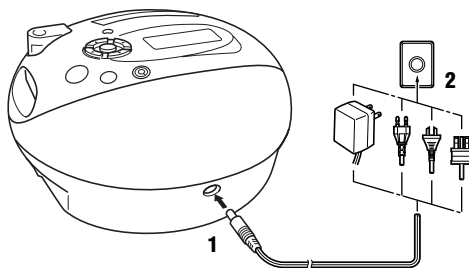

WARNING

Use only the enclosed AC adapter, designed exclusively for this machine. If the machine will not be used for a long time, disconnect the AC adapter.

3 Place the pre-cut design fabric in the design frame.

Putting the pre-cut design fabric in the design frame

- 1 Lift up side A of the design frame.

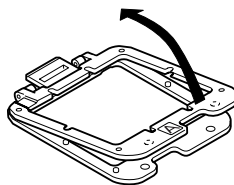

- 2 Place the pre-cut design fabric in the design frame so the side that will be the front of the embroidery faces up.

Either side of the pre-cut design fabric can be used as the front of the embroidery.

Hook the holes in the design fabric onto the pins on side B of the design frame.

- ① Side A (white)
- ② Side that will be the front of the embroidery

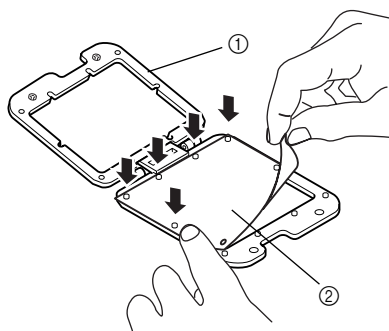

- 3 Snap the design frame closed at the two places shown.

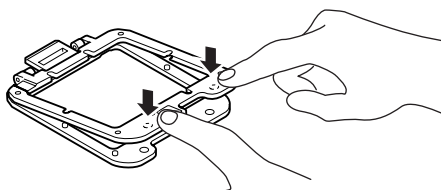

The maximum embroidering area is 6×6 cm. However, the actual size of the embroidery will depend on the pattern selected.

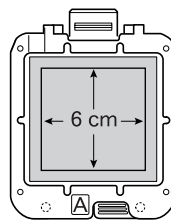

CAUTION

- Do not embroider onto anything other than the pre-cut design fabrics designed exclusively for this machine.
- The smoother (leather-like) side of the pre-cut design fabric may shrink or become wrinkled if it gets wet.

2. Starting up the machine

1 Press the key to turn on the machine.

The screen shown at the right appears on the LCD display.



2 Press the key.

The design frame holder moves to its starting point. Next, the start-up animation appears on the LCD display. Then, a screen showing the various pattern categories appears. (The icons in the screens that appear may be slightly different than those shown in this manual.)



Key information

- To skip the animation, press any key.



NOTE

- The design frame holder will make an obvious noise while moving. This is normal and does not mean that the machine is broken.
- If it is hard to read the screen, change the contrast of the LCD display. (For more details, see page 47.)
- To turn the machine off, press the  key again.

3. Selecting the pattern

1 The pattern categories are displayed.

As long as  or  appears, more pattern categories can be displayed.



2 Press the or key until the category for the pattern that you want is highlighted.

For this example, highlight .



 **NOTE**

- For details about the patterns, check the pattern list, and see the section *Overview and Patterns* on page 7.
- To select a pattern that was previously saved to a memory pocket, highlight . For details, see the section *Retrieving a saved pattern* on page 37.
- To select a pattern from a design cassette, see page 33.

3 Press the  key.

The patterns in the category chosen in step 2 appear.

- ① Total number of patterns in the category
- ② Number of the highlighted pattern
- ③ This indicator appears if the selected pattern is embroidered with the chenille texture.
- ④ Patterns in the chosen category

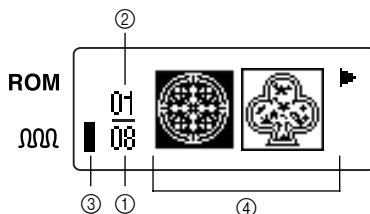

4 Press the  or  key until the pattern that you want is highlighted.

For this example, highlight  (pattern number 03). (The pattern icons and total number of patterns that appear may be slightly different than the one shown at the right.)



 **NOTE**

- For details about the patterns, check the pattern list, and see the section *Overview and Patterns* on page 7.



Key information

- To go back to the pattern categories, press the  key.

5 Press the  key.

The embroidering animation appears on the LCD display. Then, the screen shown at the right appears.

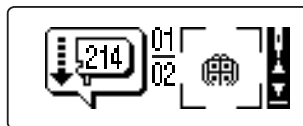

Key information

- To skip the animation, press any key.

 NOTE

- If a frame or template pattern was selected, you would now select the font and type in the text. For details, see the section *Working with text (when a frame or template pattern is selected)* on page 27.

4. Inserting the thread cartridge and design frame

1 The first thread color ID number and the first part of the pattern that will be embroidered are shown in the LCD display.

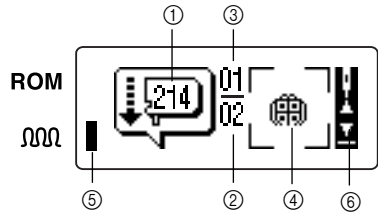





- ① Thread color ID number
- ② Total number of thread colors used in the pattern
- ③ Number showing the order of the thread color being used
- ④ The part of the pattern that will currently be embroidered
- ⑤ This indicator appears if the part of the pattern that is displayed will be embroidered with the chenille texture.
- ⑥ See *Key information* below.

 NOTE

- When embroidering text in frame or template patterns, “” appears instead of the thread color ID number. This means that you can use any thread color.

 Key information

- To go back to the previous screen, press the  key.
- To skip or move around within a stitch area or advance to the next thread color, press the  key. (For details, see the section *Stopping and continuing embroidering* on page 41.)
- To stop embroidering and move forward to the end, press the  key. (For details, see the section *Selecting the next operation* on page 20.)
- To advance to the step where the design frame is inserted, press the  or  key. (For details, see the section *Inserting the design frame* on page 16.)

2 Insert the thread cartridge with the corresponding color ID number shown in the LCD display.

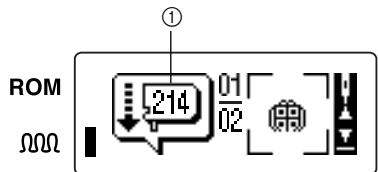

- ① Thread color ID number

Inserting a thread cartridge

- 1 Hold the thread cartridge as shown in the diagram, and then align the guide on the thread cartridge with the groove in the thread cartridge slot.

- ① Guide
- ② Groove

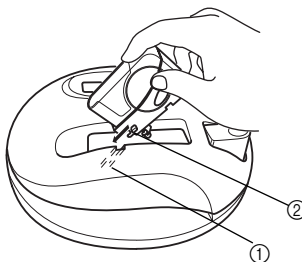

NOTE

- Be sure to take the needle guard cap off the needle before inserting the thread cartridge.
- Check that about 3/4" to 1" (2 to 3 cm) of thread hangs out of the bottom of the cartridge. If it does not, see the section *Pulling the thread end out of the cartridge* on page 45.

- 2 Slide the thread cartridge into the thread cartridge slot.

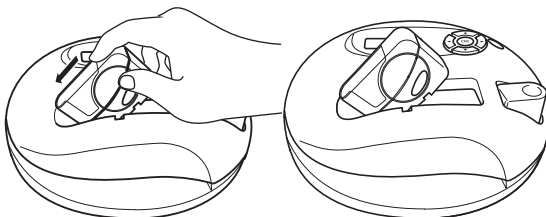

- 3 Swing down the back end of the thread cartridge until it locks in place.

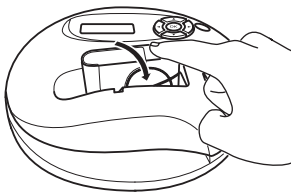

CAUTION

- Insert the thread cartridge after selecting the pattern and when the screen showing the thread ID number appears.
- Before inserting the thread cartridge, make sure there is enough thread in it. Plan ahead when sewing chenille texture embroidery, since it uses more thread than standard embroidery.

Removing the thread cartridge



- 1 Press the thread cartridge release button ().

The thread is automatically cut and the back end of the thread cartridge pops up.

- 2 Slide out the thread cartridge.



CAUTION

- Be sure to press the thread cartridge release button () before trying to take out the thread cartridge. **Do not** try removing the thread cartridge without pressing the thread cartridge release button () first, otherwise the cartridge may be damaged.

- 3 A screen appears, showing which side of the design frame should face up.



NOTE

- If chenille texture embroidery is being sewn, the screen shown at the right appears. (See the section *Chenille embroidery* on page 25.)

ROM



Key information

- To go back to the previous screen, press the  key.

4 Insert the design frame with the side shown in the screen facing up.

Inserting the design frame

- 1 Check the screen to see which side of the design frame should face up.

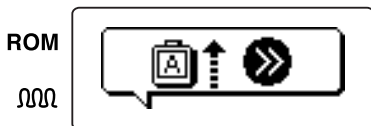

When the screen shown above appears, insert the design frame with side A facing up.



When the screen shown above appears, insert the design frame with side B facing up.

- 2 Line up the right side of the design frame with the line on the machine at the design frame slot.

① Line

- 3 Insert the mount on the design frame into the design frame mounting bracket inside the machine.

② Design frame mount

③ Design frame mounting bracket

④ Frame side marks (A or B)

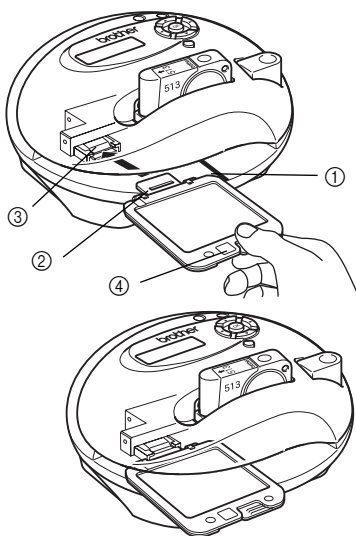

CAUTION

- Make sure that the design frame is inserted correctly, otherwise the embroidery may not be sewn correctly or thread cartridge may break.

Removing the design frame

- 1 Pull the design frame straight out.

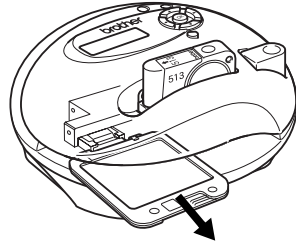

CAUTION

- Before pulling out the design frame, remove the thread cartridge, and make sure that the design frame has moved to its starting point so it can be taken out.



NOTE

- When embroidering is finished or while sewing chenille embroidery, the design frame automatically moves so that it can be taken out after the thread cartridge is removed. (See the section *Chenille embroidery* on page 25.) If you want to stop embroidering and take out the design frame, follow the instructions in the section *Removing the design frame* on page 44.

5. Embroidering the appliqué



Before embroidering, check that the thread cartridge and design frame are correctly inserted.

- 1 Press the  key.

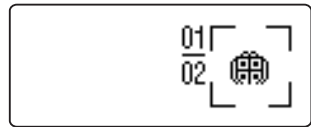
The part of the pattern shown on the LCD display is embroidered.





Key information

- To stop embroidering, press the  key. After sewing a few stitches, the machine will stop.
- To continue embroidering, press the  key.



CAUTION

- Be sure to insert the design frame before pressing the  key.
- If the  key is pressed without a thread cartridge inserted, the warning screen shown at the right appears. Insert the thread cartridge.
- If the thread cartridge runs out of thread or the thread breaks, embroidering will not automatically stop. Press the  key, and then fix the problem. (See *Stopping and continuing embroidering* on page 41.)

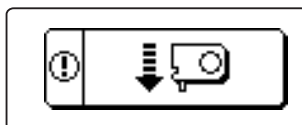

WARNING

The thread cartridge and design frame move while the embroidery is being sewn. For that reason, do not touch the thread cartridge or design frame, prevent them from moving in any way, or press the thread cartridge release button () while embroidering; otherwise, the machine or thread cartridge may break.

2 When the machine is finished embroidering the part of the pattern shown on the LCD display, it automatically stops and the screen shown at the right appears.



3 Press the thread cartridge release button () , and then remove the thread cartridge.

(See the section *Removing the thread cartridge* on page 15.)



First color to be embroidered



CAUTION

- Be sure to wait until embroidering is finished before removing the thread cartridge.

4 The next thread color ID number and the next part of the pattern are shown in the LCD display.

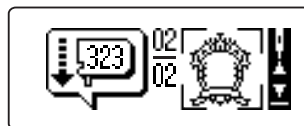

5 Insert the next thread cartridge.

A screen appears, showing which side of the design frame should face up.



NOTE

- If chenille embroidery is being sewn, the screen shown at the right appears.

ROM

ΩΩΩ



- If the screen changes as shown below:

1. After the thread cartridge is removed, the design frame automatically moves to its starting point so that it can be taken out.
2. Pull out the design frame, and then insert it with the side shown in the screen facing up. (See the section *Chenille embroidery* on page 25.)

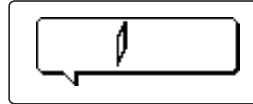
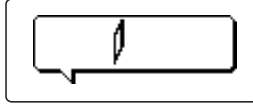

When the screen changes as shown above, insert the design frame with side A facing up.

When the screen changes as shown above, insert the design frame with side B facing up.

6 Check that the design frame is inserted with the side shown in the screen facing up, and then press the key.

The part of the pattern shown on the LCD display is embroidered.

If the pattern uses many thread colors, repeat steps 2 through 6 until all parts of the pattern are embroidered.

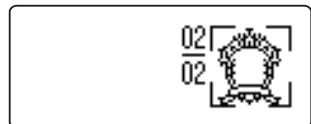

- 7** When the machine is finished embroidering, it automatically stops and the screen shown at the right appears.



- 8** Remove the thread cartridge.

The design frame moves back to its starting point so it can be removed. After the final animation is displayed, the screen shown at the right appears.



Key information

- To skip the animation, press any key.

- 9** Pull out the design frame. Then, take the pre-cut design fabric out of the frame.



Finished embroidery





CAUTION





- Be sure to follow the correct procedure for removing the thread cartridge before removing the design frame, otherwise the stitching may be damaged. (See the section *Removing the thread cartridge* on page 15 and *Removing the design frame* on page 17.)

6. Selecting the next operation



To embroider the same pattern again

Press the  key until  is highlighted, and then press the  key. The screen shown on page 13 under *Inserting the thread cartridge and design frame* appears. Repeat the steps to embroider the same pattern.

To save the pattern

Press the  or  key until  is highlighted, and then press the  key. For more details, see the section *Saving a pattern* on page 34.

To embroider a different pattern

Press the  key until  is highlighted, and then press the  key. The screen shown on page 11 under *Selecting the pattern* appears. Repeat the steps to embroider a different pattern.

To finish using the machine

Press the  key.

7. Finishing the appliqué

In order to prevent threads from being pulled out, attach the iron-on adhesive film to the wrong side of the embroidery. Then, cut the embroidery into any shape you want.



CAUTION

- Before the iron-on adhesive film is attached, the embroidery threads can easily be pulled out. Be careful not to pull them out.



NOTE

- A reference line of stitching is sewn around the pattern so the pattern can be cut out more easily.
 - ① Reference line of stitching (line that shows how to cut out the embroidery)
- The reference line may not be sewn around all patterns.
- If you do not want to cut out the embroidery along the reference line, carefully take out the reference line threads before ironing on the adhesive film.

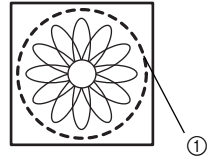

- 1 Place the right side of the embroidery face down. Then, completely cover the threads with the iron-on adhesive, making sure that the printed backing paper faces up.**

Make sure that the backing paper is on the top.

- ① Ironing board
- ② Pre-cut design fabric (wrong side facing up)
- ③ Iron-on adhesive (printed backing paper facing up)

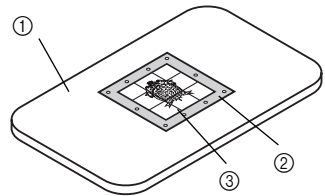

- 2 Be sure to heat the iron to a medium temperature of 285 to 320 °F (140 to 160 °C) and not to use the steam setting. Then, press the iron down for 30 to 40 seconds on the backing paper of the iron-on adhesive.**

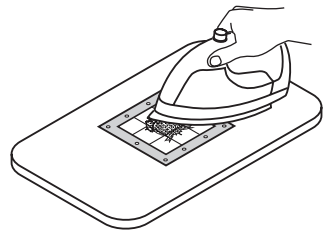

NOTE

- If some of the adhesive melts onto the iron, wait until the iron cools down, and then peel off the adhesive.

⚠ WARNING

- Be very careful when using the iron since it is very hot and can cause burns.
- During or after ironing the pre-cut design fabric, wait until the fabric has cooled down before touching it.

3 After the design fabric cools down completely, cut off any extra threads.

① Extra thread

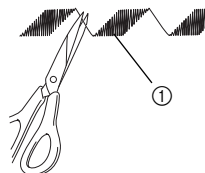

NOTE

- The extra threads can be cut off before attaching the iron-on adhesive. But, since the embroidery threads can easily be pulled out, be careful not to pull them out.

4 Peel the backing paper off the back of the appliqué.

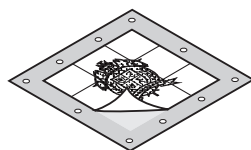

5 Cut out the appliqué.

Cut out the embroidery either along the reference line or in any shape you want.

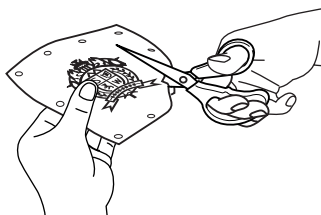



CAUTION

- When cutting out the embroidery in any shape you want, cut at least 3/16" (5 mm) away from the edge of the embroidery. If you cut too close to the embroidery, you might cut the embroidery threads.
- When cutting along the reference line, cut outside of the reference line. Do not cut inside the reference line.
- If the iron-on adhesive film did not completely attach to the appliqué and must be ironed on again, make sure that the film is covered by the backing paper. Place the backing paper on top of the film with the printed side of the backing paper facing up.

8. Attaching the appliqué

To ensure that an iron-on appliqué will not come off after repeated washings, sew it to the fabric either by hand or with a sewing machine.

To iron on the appliqué:

1 Place the appliqué right side up on the fabric at the place where you want to attach it. Then, place an extra piece of cloth over the embroidery to protect it.

Be sure to iron on a hard surface, like an ironing board.

- ① Ironing board
- ② Fabric
- ③ Appliqué
- ④ Extra piece of cloth

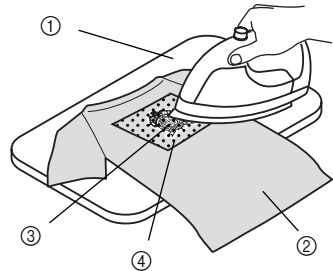

2 Be sure to heat the iron to a medium temperature of 285 to 320 °F (140 to 160 °C) and do not use the steam setting. Then, use both hands to press the iron down hard for 20 to 30 seconds on the extra piece of cloth covering the appliqué.

If the appliqué did not attach well to the fabric, iron it from the back.

⚠ WARNING

- Be very careful when using the iron since it is very hot and can cause burns.
- During or after ironing the pre-cut design fabric, wait until the fabric has cooled down before touching it, otherwise you may be burned.
- After ironing on the appliqué, wait until it cools down completely (about 20 minutes) before folding it or pulling on it.



CAUTION

- Do not attach the appliqué to fabric that may be damaged when ironed at a medium temperature for a certain amount of time.
- Do not attach the appliqué to water-proofed, stretch or furry fabric.
- The appliqué will not attach to wet or damp fabric. Be sure to dry the fabric first.
- Do not dry clean the appliqué.
- Sew the appliqué onto sweaters and other knitted items.

To attach the appliqué like a sticker:

Attach a piece of commercially available double-sided tape to the back of the applique. Then, attach it to anything you want.

CONTENTS

Chapter 1

Chapter 2

Chapter 3

Chapter 4

Chapter 5

INDEX

Chapter 6

CHENILLE EMBROIDERY

This section gives additional details on chenille embroidery.

Parts of certain patterns that can be embroidered with the machine are designed to be sewn with a chenille texture. The chenille texture is made of looped threads and looks like a terry cloth towel. When sewing chenille embroidery, be sure to insert the design frame with side B facing up.

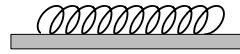

Chenille embroidery



NOTE

- In this manual, “chenille embroidery” is embroidery with sections that are sewn with a chenille texture.
- In the pattern list, “” means that part of the pattern is embroidered with the chenille texture.

When a chenille pattern is selected:

When sewing chenille embroidery, the side of the design frame facing up will have to be changed from side B to side A or from side A to side B. After replacing the thread cartridge, check that the design frame is installed correctly.

For the sample pattern list information at the right, the embroidery would be sewn as described below.

Example: 1: (800)B
2: (124) A
3: (323)B

1 Insert the thread cartridge for the first color (800). After the screen shown at the right appears, insert the design frame with side B facing up, and then press the  key.

ROM





2 After the first color is embroidered and the machine stops automatically, press the thread cartridge release button () to cut the thread, and then remove the thread cartridge. (See the section *Removing the thread cartridge* on page 15).

- 3** Insert the thread cartridge for the second color (124). After the screen shown at the right appears, insert the design frame with side A facing up, and then press the  key.

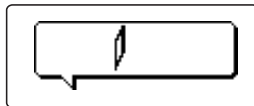
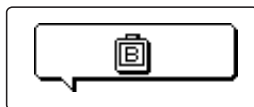

- 4** After the second color is embroidered and the machine automatically stops, remove the thread cartridge.

- 5** Insert the thread cartridge for the third color (323). After the screen shown at the right appears, insert the design frame with side B facing up, and then press the  key.

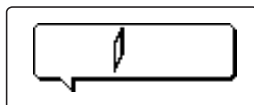

- 6** After the third color is embroidered and the machine automatically stops, continue with the steps in the section *Finishing the appliqué* on page 21 to finish making the appliqué.



NOTE

- The parts of the patterns that will be sewn with the chenille texture are pre-set. Also, the built-in fonts cannot be sewn with the chenille texture.
- Sewing chenille embroidery uses a lot of thread. Make sure that there is enough thread left in the cartridge before sewing chenille embroidery.

WORKING WITH TEXT (WHEN A FRAME OR TEMPLATE PATTERN IS SELECTED)

With frame and template patterns, you can enter text and select the font that will be used for embroidering. The  mark in the pattern list and on the LCD display shows where text can be added. The number of lines and characters that can be entered depends on the pattern selected.



CAUTION

- Template patterns are embroidery that have only text. If no text is entered, the embroidery cannot be sewn.

The following two fonts are available in two sizes.



Large (about 10 mm high)
Satin stitches

(Sewn image)



Small (about 7 mm high)
Straight stitches

(Sewn image)



NOTE

- For a list of characters that can be entered, see page 29.



CAUTION

- All text appearing in the same line must have the same font. But, each line in a template with more than one line can have different fonts.
- All text appearing in the same line must have the same size. But, each line in a template with more than one line can have different sizes.
- With some patterns, the large fonts cannot be chosen.
- The number of letters that can be entered within  depends on the pattern and the selected font and text size.



Entering text

After a template pattern is selected, the screen shown at the right appears so that you can choose the font and text size.

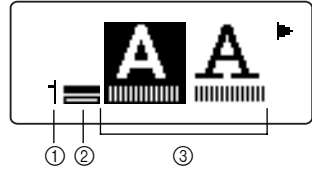
- ① Number of the line of text being entered
- ② Shows which line of the total number of lines of text is being entered
- ③ Fonts and text sizes that are available



NOTE

- The large fonts cannot be chosen with some patterns. With those patterns,   will not appear.

- 1** Press the  or  key until the font and text size that you want is highlighted.





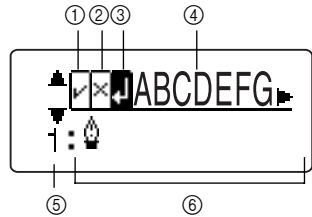

- 2** Press the  key.

The screen shown at the right appears.

- ① Select this icon to check the entered text. (For details, see the section *Checking the text* on page 32.)
- ② Select this icon to delete a character. (For details, see the section *Changing the text* on page 31.)
- ③ Select this icon to quit entering the text.
- ④ Characters that are available
- ⑤ Number of the line of text being entered
- ⑥ Text that has been entered



- 3** Press the  or  key until the character that you want to enter is highlighted.

To select another set of characters, press the  or  key until the characters you want appear.



The following are the sets of available characters in the two fonts shown below.





ABCDEFGHIJKLMNOPQRSTUVWXYZ
 abcdefghijklmnopqrstuvwxyz
 0123456789
 (space) & ? ! () ' , . - / _ @ ♥ ★ ♪
 Ä Å Æ Ñ Ö Ø Ç Ü ä å ä å æ è é ê ë ñ ö ø ì ç ü ß

ABCDEFGHIJKLMNOPQRSTUVWXYZ
 abcdefghijklmnopqrstuvwxyz
 0123456789
 (space) & ? ! () ' , . - / _ @ ♥ ★ ♪
 Ä Å Æ Ñ Ö Ø Ç Ü ä å å æ è é ê ë ñ ö ø ì ç ü ß



 **Key information**

- To go back to change the font or text size, press the  key. If any text has been entered, it is erased when you change the font and text size.

Example: To enter “Star ★”

1 Press the  or  key until either  or  is highlighted, and then press the  key.





2 Press the  key until “S” is highlighted, and then press the  key.



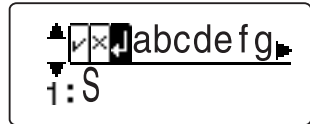

3 Press the  or  key until the lowercase letters appear.

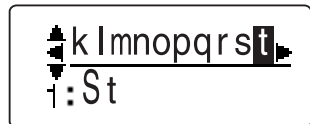

4 Press the  key until “t” is highlighted, and then press the  key.



5 Press the  key until “a” is highlighted, and then press the  key.

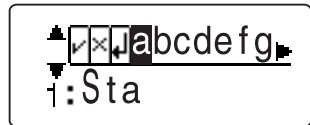

CONTENTS

Chapter 1

Chapter 2



Chapter 3

Chapter 4

Chapter 5

INDEX



Chapter 6

- 6 Press the  key until "r" is highlighted, and then press the  key.



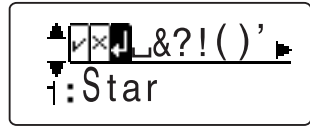

- 7 Press the  or  key until the symbols appear.







- 8 Press the  key until "★" is highlighted, and then press the  key.



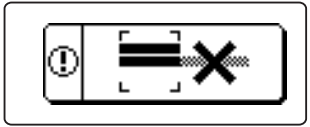

 **NOTE**

- If the screen shown at the right appears, no more characters can be entered. Press the  key to go back to the text. Then, change the text to make it shorter (see the section *Changing the text* on page 31), select a smaller text size, or quit entering text.



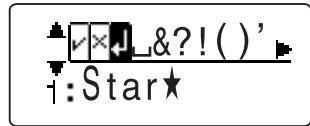



- 9 After all the text is entered, press the  or  key until  is highlighted, and then press the  key.



- 10 If the pattern has two or more  marks, the screen shown at the right appears. Repeat steps 1 to 9 to enter the next line of text.



 **Key information**

- If you do not want to enter another line of text, press the  or  key until  is highlighted, and then press the  key.

CONTENTS

Chapter 1

Chapter 2

Chapter 3

Chapter 4

Chapter 5

INDEX

Chapter 6

- After all of the text is entered, the embroidering animation appears on the LCD display. Then, the screen shown on page 13 under *Inserting the thread cartridge and design frame* appears. Continue in same way that a one-point pattern is embroidered.



Key information

- To go back to edit the text, press the key. (See the section *Changing the text* on page 31.)

When it is time to embroider a line of text (), the machine stops and a screen like the one shown at the right appears. “” appears instead of the thread color ID number. This means that you can use any thread color that you would like for the text. The text is embroidered starting from the top line.

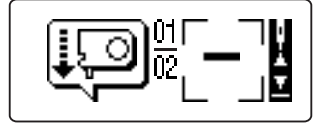

Changing the text

If you would like to edit the text, you will have to delete the characters that you have entered, starting from the last one, until you reach the point where your editing should begin. Then, enter the text.

- Press the or key until is highlighted, and then press the key. The last entered character is deleted.



- Keep pressing the key until you reach the place in the text that you want to change.

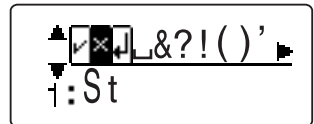

Example: To change “Ster ★” to “Star ★”

- Press the or key until is highlighted, and then press the key three times to delete “er★”.
- Press the or key until the lowercase letters appear.

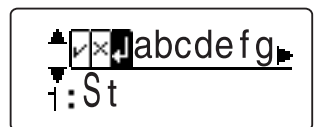
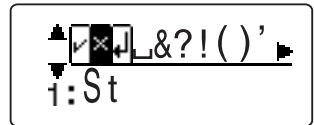

- 3 Enter "ar★" as described on pages 29 and 30.



● Checking the text

If the line of text that has been entered is too long to fit in the LCD display, you can scroll it from the beginning to the end.

- 1 Press the or key until is highlighted, and then press the key.

The whole line of text, starting from the beginning, scrolls to the left at the bottom of the LCD display.

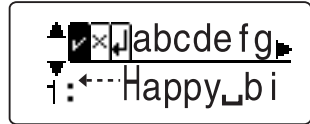
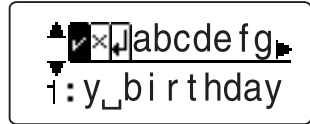

Chapter 4

Additional Operations

This chapter explains some of the other functions available with this machine.

SELECTING A PATTERN FROM A DESIGN CASSETTE

In addition to the many patterns built into the machine, there are a variety of optional design cassettes containing other patterns.

1 Before turning on the machine, insert the design cassette into the slot for an optional design cassette.

Make sure that the arrow mark on the design cassette faces up. Then, insert the design cassette straight into the slot as far as possible.

If the machine is on, press the  key to turn it off.

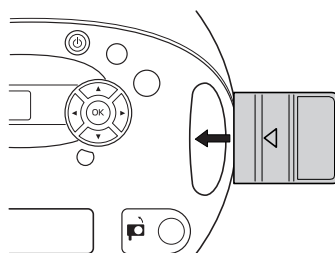

CAUTION

- Be sure to turn off the machine before removing the design cassette.
- Be sure to insert the optional design cassette correctly. Also, be sure not to insert anything other than the design cassette into the slot, otherwise the machine may break.
- Do not try to disassemble the design cassette. Also, do not touch the connectors of the design cassette.

2 Press the key, and then press .

After the start-up animation appears on the LCD display, a screen like the one shown at the right appears. The icons of the categories on the design cassette appear in front of the icons for the built-in pattern categories.

- ① The **ROM** mark means that pattern category is on the design cassette.

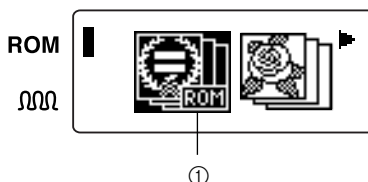

NOTE

- The design cassettes may contain more than one pattern category.
- For more information about the patterns, check the pattern list included with each optional design cassette.

3 Select the pattern, enter the text, and sew the embroidery in the same way that you would with a built-in pattern.

- ① This indicator appears when a pattern from the design cassette is selected.

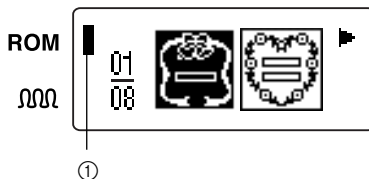

SAVING A PATTERN

Patterns that you use often or patterns with text that you entered can be saved so you can quickly select them to be used again. Up to four patterns can be saved.

1 Press the or key until is highlighted.



NOTE

- This is the same screen that appears after embroidering is finished or when the key is pressed while the screen shown on page 13 of the section *Inserting the thread cartridge and design frame* is displayed.

2 Press the key.

A screen like the one shown at the right appears.

- ① This indicates that this screen is for saving patterns.
 ② This means that a pattern has not yet been saved in this pocket. The number refers to the pocket that the information will be saved in.
 ③ “♥” indicates that a pattern has already been saved in this pocket.
 ④ This indicator appears if the pattern saved in the selected pocket will be embroidered with a chenille texture.

If patterns from a design cassette have been saved, a screen like the one shown at the right appears.

- ⑤ The **ROM** mark means that the pattern saved in that pocket is from the inserted design cassette.
 ⑥ The **ROM?** mark means that the pattern saved in that pocket is not from the inserted design cassette in place at this time.
 ⑦ This indicator appears if the pattern saved in a pocket with the **ROM** or **ROM?** mark is selected or a design cassette is inserted.

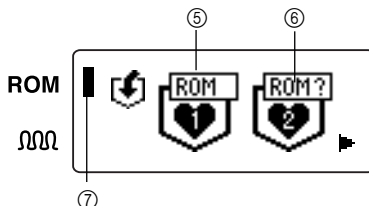
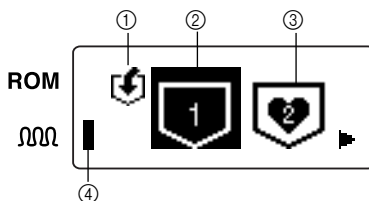

- 3** Press the ◀ or ▶ key until the pocket where you want to save the pattern is highlighted, and then press the (OK) key.

ROM
ΩΩΩ



If a pattern has not yet been saved in the selected pocket:

- 4** The pattern is saved and a screen like the one shown at the right appears.

(The number indicated will be the number of the selected pocket.)



- 5** Then, the screen shown at the right appears.



If a pattern has already been saved in the selected pocket:

- 4** A screen showing the saved pattern appears.

- ① Number of the selected pocket
② Sample of the saved pattern (If a pocket with the ROM mark was selected, the pattern is displayed at ②, and the indicator at ⑤ appears. If a pocket with the ROM? mark was selected, "?" appears at ②, and the indicator at ⑤ appears. To check the saved pattern, turn off the machine, insert the design cassette for the saved pattern, and then start again from the beginning. (Even if "?" is displayed, the new pattern can be saved.)

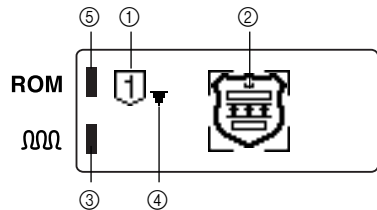

- ③ This indicator appears if the pattern saved in the selected pocket will be embroidered with a chenille texture.
④ If ▼ appears, the pattern saved in the selected pocket is a frame or template pattern. (For details on checking the text, see the section *Checking the text in a saved pattern* on page 39.)
⑤ This indicator appears if the pattern saved in the selected pocket is from a design cassette.

- 5** Press the (OK) key.

An animation like the one shown at the right appears.



6 To replace the old pattern with the new one, press the key.

The pattern is saved and a screen like the one shown at the right appears.



Key information

- If you want to keep the old pattern, press the  key.

7 Then, the screen shown at the right appears.





CAUTION

- Do not turn off the machine or disconnect the AC adapter from it or from the electrical outlet while a pattern is being saved, otherwise the pattern will not be saved correctly.

RETRIEVING A SAVED PATTERN

Saved patterns can quickly be retrieved to be used again.

- 1** Press the  or  key until  is highlighted.



NOTE



- If the saved pattern that you want to retrieve is from a design cassette, be sure that the design cassette is inserted before turning on the machine.

- 2** Press the  key.

A screen like the one shown at the right appears.

- ① Indicates that this screen is for retrieving saved patterns
(For details about the other symbols, see page 34.)



- 3** Press the  or  key until the pocket with the pattern that you want is highlighted.

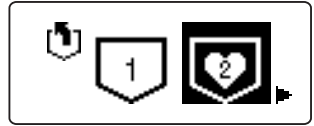

- 4** Press the  key.

A screen like the one shown at the right appears.
(For details about the other symbols, see page 35.)



Key information

- If you want to select a different saved pattern, press the  key.

 NOTE

- If the screen shown at the right appears, a design cassette is not currently inserted.
- If the screen shown at the right appears, the design cassette for the pattern saved in the selected pocket is not currently inserted.

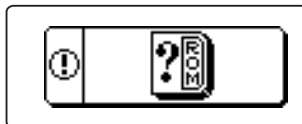
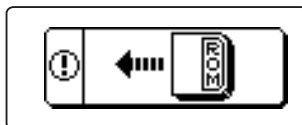



If either of these error screens appear, turn off the machine, insert the correct design cassette for the saved pattern, and then start again from the beginning.





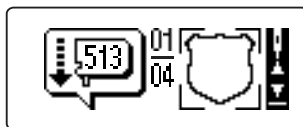

5 To retrieve the saved pattern, press the

 key.

The embroidering animation appears on the LCD display, and then a screen like the one shown at the right appears. Go back to the section *Inserting the thread cartridge and design frame* on page 13 to start embroidering.



 Key information

- If a saved one-point pattern was selected, press the  key to go to the screen where you can select a pattern.
If a saved frame or template pattern was selected, press the  key to go to the screen where you can enter the text for the last line.
- To select a different saved pattern, do one of the following:
 - Press the  key, highlight , and then press the  key.
 - Press the  key, and then turn on the machine again.

This will take you back to the screen where you can select a pattern category. Then, start again from step 1.

● Checking the text in a saved pattern

If the saved pattern is a frame or template pattern with text, ▼ appears to show that you can check the text. (See the section *Saving a pattern* on page 34 and the section *Retrieving a saved pattern* on page 37.)

1 Press the ▼ key. If ► appears, press the ► key to check the rest of the text.

A screen like the one shown at the right appears.

- ① Number of the selected pocket
- ② Selected font and text size (stitch)
- ③ If ◀ or ▶ appears, press the ◀ or ▶ key to display more characters.
- ④ Number of the line of text being checked
- ⑤ Shows which line of the total number of lines of text is being checked
- ⑥ Text that has been entered

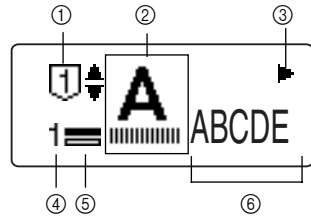

2 If more than one line of text has been entered, press the ▼ key.

A screen like the one shown at the right appears for the next line of text.

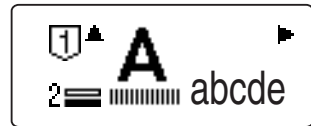

Key information

- To go back to the screen where you can select a pocket, press the ⏪ key.
- To go back to the previous screen, press the ▲ key.

3 When you are finished checking the text, press the OK key.

If you were saving a pattern, an animation like the one shown at the right appears. Go back to step 5 on page 35.



If you were selecting a saved pattern, an animation appears, and then a screen like the one shown at the right appears. Go back to the section *Inserting the thread cartridge and design frame* on page 13 to start embroidering.

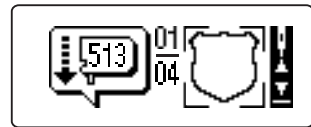

EDITING THE TEXT IN A SAVED PATTERN

After a saved template pattern is selected, the text can be changed. This is convenient if you want to use the same pattern and change the text.

1 Select the saved frame or template pattern.

(See the section *Retrieving a saved pattern* on page 37.)

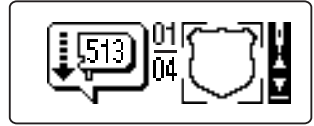

2 Press the \ominus key.

3 A screen like the one shown at the right appears for the last line of text.

① Text that has been entered

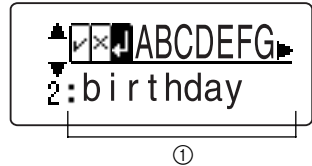

4 Change the text, font or text size.

To change the text, go to the section *Changing the text* on page 31.

To change the font or text size, press the \ominus key. A screen like the one shown at the right appears so that you can choose the font and text size. (See the section *Entering text* on page 28.)

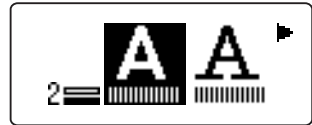

If more than one line of text has been entered, press the \ominus key. A screen showing the previous line of text appears.

5 Repeat steps 2 through 4 for each line of text that you want to change.

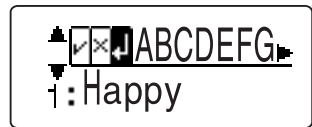

CAUTION

- If the font or text size is changed, the complete line of text will be deleted.
- If the font screen for the first line of text is displayed and the \ominus key is pressed, the screen for selecting the pattern appears. From here, you will have to select a new pattern and enter the text in its entirety again.
- Even after retrieving a saved pattern and changing the text, the original saved text does not change. If you want to keep the new text, you will have to save it.

STOPPING AND CONTINUING EMBROIDERING

If the thread breaks or the cartridge runs out of thread, stop embroidering, fix the thread, and then go back to the point in the pattern where sewing stopped.

If the thread cartridge ran out of thread:

Get a new thread cartridge.

If the thread broke:

Pull the thread out of the cartridge. For details on pulling the thread out from the cartridge, see the section *Pulling the thread end out of the cartridge* on page 45.

1 Press the key to stop embroidering.

After sewing a few stitches, the machine stops, and a screen like the one shown at the right appears.



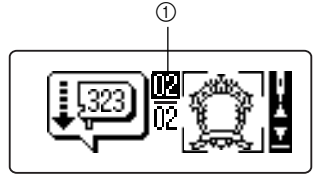

- ① The highlighted number is the number of the thread color that was being embroidered.



2 Press the thread cartridge release button () , and then remove the thread cartridge.



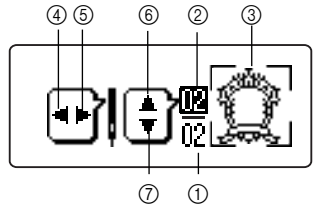

3 Press the key.

A screen like the one shown at the right appears.

- ① Total number of thread colors used in the pattern
 ② Number indicating the order of the thread color being embroidered
 ③ The part of the pattern that is being embroidered
 ④ Press the  key to go back 11 stitches.
 ⑤ Press the  key to skip ahead 11 stitches.
 ⑥ Press the  key to skip ahead one thread color. (The number at ⑤ increases by 1.)
 ⑦ Press the  key to go back one thread color. (The number at ⑥ decreases by 1.)



Key information

- Holding down the  or  key moves forward or backward 31 stitches.
- Holding down the  or  key moves forward or backward through the thread colors.



NOTE

- If the number at ② is highlighted, embroidering for that thread color was stopped. If stitching is moved back to the beginning for that thread color or if another thread color is selected, the highlighting at ② disappears.

4 Press the key to go back to the point where sewing stopped.

Align the hole in the thread cartridge slot (shown by the arrow at the right) with the point where sewing stopped. Go back a little before the point where sewing stopped so the stitches will overlap a little.

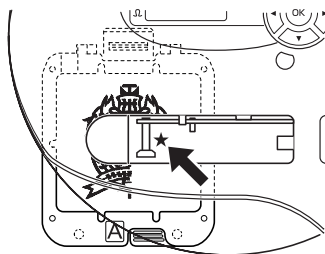

Key information

- If you go back too far, press the  key.



NOTE

- If the screen shown at the right appears, the thread cartridge was not removed. Remove the thread cartridge.
- If it is difficult to find the point where sewing stopped, insert the thread cartridge, and then align the needle with the desired position.



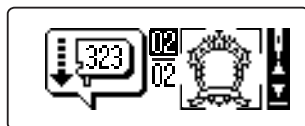

5 Press the key.

The screen displayed in step 1 appears again.



Key information

- Pressing the  key goes back to step 1.
- To go back to step 3, press the  key.

6 Insert the thread cartridge, and then press the key to continue sewing.



NOTE

- If embroidering is stopped and restarted, some extra needle holes may be punched in the pre-cut design fabric, but it can still be used.
- If you wish to remove the design frame, press the  key, and then pull it out. (See the section *Removing the design frame* on page 44.) Before continuing embroidering, be sure to insert the design frame with the correct side facing up.

Continuing embroidering after your machine is turned off

If the machine was turned off, restart embroidering as explained below.

Example: To continue embroidering from the second color

1 Turn on the machine and insert the design frame.

2 Select the pattern that you wish to finish. When a screen like the one shown at the right appears, press the  key.

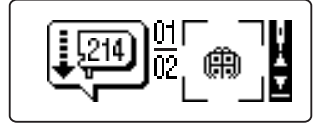

3 A screen like the one shown at the right appears.

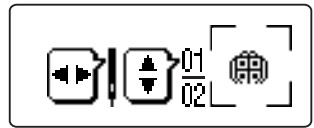

4 Press the  key until "02" appears at ^①.

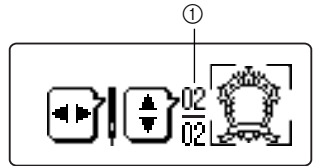

Key information

- If you go forward too far, press the  key.

5 Like in step 4 on page 42, press the  key to go forward to the point where sewing stopped.

Go back a little before the point where sewing stopped so the stitches will overlap a little.





Key information

- If you go forward too far, press the  key.

6 Press the  key.

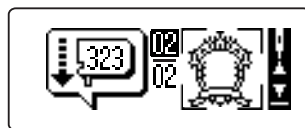
The screen displayed at the right appears again.

**Key information**



- Pressing the  key displays the screen shown at the right.
- To go back to step 4, press the  key.

7 Insert the thread cartridge, and then press the  key to continue sewing.**REMOVING THE DESIGN FRAME**

If you want to stop embroidering and take out the design frame, follow the steps below.

1 Press the  key to stop embroidering.

After sewing a few stitches, the machine stops.

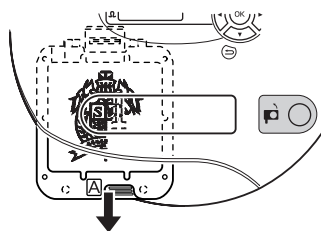
2 Press the thread cartridge release button , and then remove the thread cartridge.**3** Press the  key. After the design frame moves to its starting point, pull it straight out.**NOTE**

- If the screen shown at the right appears, the thread cartridge was not removed. Remove the thread cartridge.



PULLING THE THREAD END OUT OF THE CARTRIDGE

If the thread breaks or is not feeding out of the cartridge, the embroidery will not be sewn correctly. Follow the steps below to pull the end of the thread out from the cartridge.

1 Put the needle guard cap over the needle.

- ① Needle guard cap

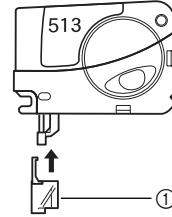

2 Swing open the cover of the thread cartridge.

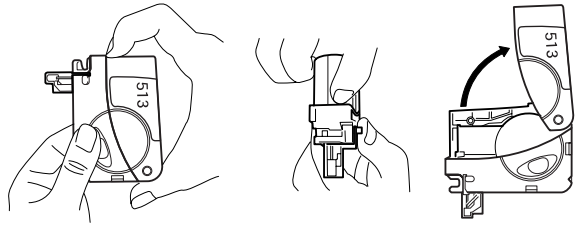

CAUTION

- Do not open the cover too far. Also, do not open it with excess force, otherwise the thread cartridge may break.

3 Use a thin object to depress the thread release button. Now, pull out about 6" (15 cm) of thread.

- ① Thread release button

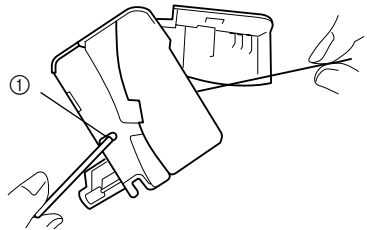

- 4** Use scissors to cut off the end of the thread that was pulled out. Then, insert the end of the thread into the red hole, and while twisting it, guide it through the cartridge until it comes out at the bottom of the cartridge.

① Red hole

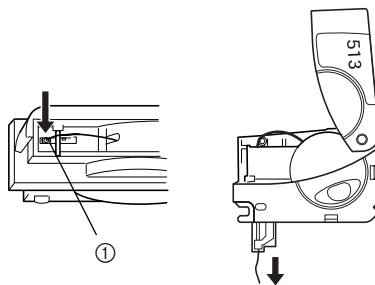

- 5** After the thread is fed out of the bottom of the cartridge, check that the thread is hooked over the pin shown at the right. Then, while pulling on the thread feeding out the bottom of the cartridge, close the cover.

① Pin
② Thread
③ Thread pulled out of the cartridge

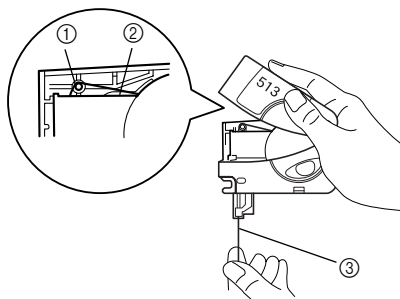

CAUTION

- If the thread is not hooked over the pin, the machine cannot embroider.

- 6** Trim the thread at the bottom of the cartridge so it is 3/4 to 1" (2 to 3 cm) long.

① 3/4 to 1" (2 to 3 cm)

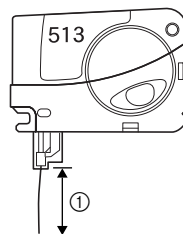



⚠ WARNING

Keep the needle guard cap over the needle while guiding the thread through the cartridge. If the needle sticks out, it could cause injuries.

CHANGING THE CONTRAST OF THE LCD DISPLAY

If the LCD display is hard to read, it can be made either lighter or darker.

- 1 Turn off the machine.
- 2 Hold down the  key, and press the  key to turn the machine on again.

The screen shown at the right appears.

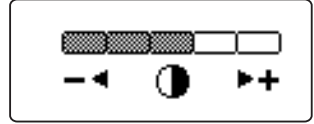

- 3 Press the  or  key to change the contrast.

To make the LCD display lighter, press the  key.

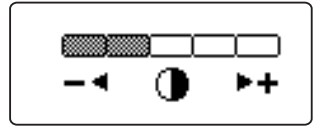

To make the LCD display darker, press the  key.

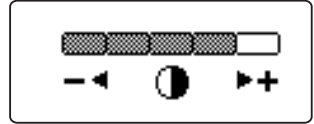

Key information

- If you do not want to change the LCD display contrast, press the  key.

- 4 Press the  key.

The LCD display becomes darker, and then the machine goes off automatically.

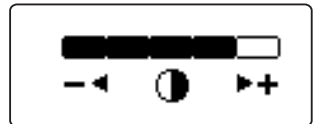

IF THE SAFETY MECHANISM WAS ACTIVATED

If the safety mechanism is activated and this machine automatically stops, follow the steps below to reset the machine.

- 1** If the safety mechanism is activated, the screen shown at the right appears.





- 2** Press the  key to turn off the machine.

- 3** Disconnect the AC adapter from the machine and from the electrical outlet.

- 4** Turn the needle position adjustment dial (at the bottom of the machine) in either direction as shown until the thread cartridge is level.

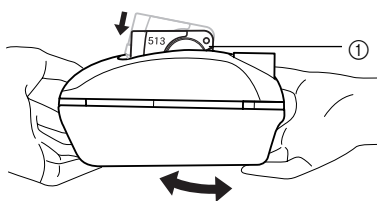
- ① Level position
- ② Needle position adjustment dial



- 5** Press the thread cartridge release button () , and then remove the thread cartridge.

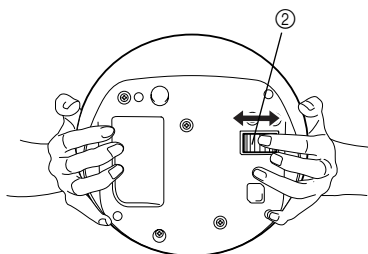

- 6** Turn on the machine and finish embroidering.



CAUTION

- After the safety mechanism has been activated, check that the thread cartridge, design frame and pre-cut design fabric are not damaged.
 - If the thread cartridge that was removed is broken or has a bent needle, dispose of the cartridge. Use a new thread cartridge.
 - If the design frame is damaged, use a different frame.
 - If the pre-cut design fabric is damaged, use a new design fabric.

Chapter 5

Appendix

CLEANING PRECAUTIONS

Cleaning the surface of this machine

Using a soft, dry cloth, wipe off any dust and dirt from the surface of the machine. Dirt that is hard to remove can be cleaned off using a damp cloth.

WARNING

Before cleaning, disconnect the AC adapter from the electrical outlet, otherwise injuries or electric shock may occur.



CAUTION

- Do not use solvents such as benzene, thinner or alcohol to clean the surface of the machine, otherwise it may become discolored or damaged the surface.



TROUBLESHOOTING





If this machine is not working correctly, check the following table for details on how to fix it. If the machine is still not working correctly, contact your Brother retailer or visit www.brother.com for the name of your nearest authorized service center.





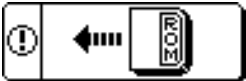

Symptom	Cause	Solution
The machine cannot be turned on.	The AC adapter is not connected correctly.	Make sure that the AC adapter is connected correctly. (page 9)
The embroidery cannot be sewn. The pattern is not sewn correctly.	① The pre-cut design fabric is not correctly placed in the design frame.	Make sure that the pre-cut design fabric is correctly placed in the design frame. (page 10)
	② The design frame is not correctly inserted into the machine.	Make sure that the design frame is correctly inserted into the machine. (page 16)
	③ The specially designed pre-cut design fabric was not used.	Use only the pre-cut design fabrics designed exclusively for this machine. (page 10)
	④ The thread cartridge has run out of thread.	Insert a new thread cartridge. (page 14)
	⑤ The thread is not feeding out of the cartridge.	Make sure that the thread feeds correctly from the thread cartridge. (page 45)

Symptom	Cause	Solution
The thread is not cut when the cartridge is being removed.	The thread cartridge was being pressed down while the thread cartridge release button () was pressed.	Follow the precautions for removing the thread cartridge (page 15).

ERROR SCREENS

If wrong operation is performed, such as pressing the  key while the thread cartridge is incorrectly inserted, an error screen appears. When an error screen appears, follow the instructions given in the screen or press the  key to continue operation.

Error screen	Remedy
	No more characters can be entered. The maximum number of characters that can be entered in the template pattern has been reached. Change the text to make it shorter (page 31), select a smaller text size (page 28), or quit entering text.
	No text has been entered. No text has been entered in a template pattern. Enter the text. (page 28)
	No design cassette is inserted. The design cassette for the pattern saved in the selected pocket is not inserted. Turn off the machine before inserting the design cassette. (page 33)
	The wrong design cassette is inserted. The selected pattern is not on the design cassette that is inserted. Turn off the machine before inserting the correct design cassette. (page 33)
	This design cassette cannot be used. The design cassette that is inserted cannot be used with this machine. Remove the design cassette and check with your Brother retailer.

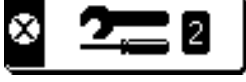
Error screen	Remedy
	<p>No thread cartridge is inserted. Insert the thread cartridge. (page 14)</p>
	<p>Press the thread cartridge release button (). This screen appears when an operation was performed without removing the thread cartridge. Press the thread cartridge release button () and remove the thread cartridge.</p>
	<p>The thread cartridge was removed. The thread cartridge release button () was pressed while embroidering. Turn off the machine, remove the thread cartridge, and then continue embroidering from the point where sewing was stopped. (page 14)</p>
	<p>The safety mechanism has activated. Follow the instructions in the section <i>If the safety mechanism was activated</i> on page 48. If the error is not corrected, turn off the machine and contact your Brother retailer.</p>
	<p>System error Disconnect the machine and contact your Brother retailer or visit www.brother.com for the name of your nearest authorized service center.</p>

CONTENTS

Chapter 1

Chapter 2

Chapter 3

Chapter 4

Chapter 5

INDEX

Chapter 6

SPECIFICATIONS

Input	Solid rubber keyboard Number of keys: 9 (8 + power key)
LCD display	Dot matrix LCD Size: 32 × 96 dots Indicators: 2
Embroidering	Thread insertion method (using specially designed thread cartridges) Maximum embroidering area: 60 × 60 mm Maximum embroidering speed: 300 stitches/minute
Power supply	Specially designed AC adapter
Size	Dimensions: 220 (W) × 220 (D) × 110 (H) mm Weight: Approx. 1.1 kg (main unit only)

INDEX

- A**
AC adapter 1, 9
AC adapter connector 3, 9
accessories 1
arrow keys 3
- B**
built-in characters 29
built-in fonts 27
- C**
chenille embroidery 25
chenille indicator 4
cleaning 49
continuing embroidering 43
- D**
design cassette 33
design cassette indicator 4, 34
design frame 1, 4, 19
 inserting 16
 removal position 44
 removing 17, 44
design frame key 3, 44
design frame mount 4, 16
design frame mounting bracket 3, 16
design frame slot 3
- E**
embroidering 17
embroidering area 10
error screens 50
- F**
finishing 21
fonts 27
frame patterns 8
frame-opening tabs 4
- G**
groove 14
guide 4, 14
- H**
highlighting 4
- I**
inserting
 design cassette 33
 design frame 16
 pre-cut design fabric 10
 thread cartridge 14
iron-on adhesive 1, 21
- K**
keys 3
- N**
needle position adjustment dial 3, 48
- O**
OK key 3
On/off key 3
one-point patterns 8
operation keys 3
- P**
parts 3
pattern categories 8, 11
pattern list 8
pattern number 8, 12
pattern types 8
patterns 11
power key 3
pre-cut design fabric 1, 10
pre-cut design fabric pins 4, 10
- R**
reference line 21
removing
 design frame 17, 44
 thread cartridge 15
retrieving saved patterns 37
return key 3















S

safety mechanism48, 51
 saving patterns34
 screens
 contrast47
 description4
 error50
 quick reference guide55
 selecting
 characters28
 patterns11
 slot for design cassette3, 33
 specifications52
 start/stop key3
 supplies2

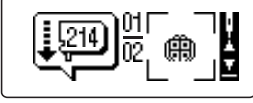
T



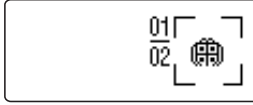















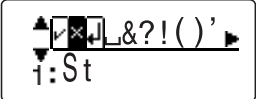

template patterns8, 27
 text
 checking32, 39
 editing31, 40
 entering28
 fonts27
 size27
 thread amount check window4
 thread cartridge1, 45
 inserting14
 removing15
 thread cartridge release button3, 15, 41
 thread cartridge slot3, 14
 thread color ID number4, 13
 thread cutting15, 50
 troubleshooting49

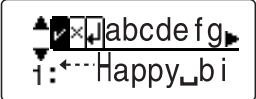









CONTENTS
 Chapter 1
 Chapter 2
 Chapter 3
 Chapter 4
 Chapter 5
 INDEX
 Chapter 6

No.	Screen	Details	See page
①		Appears when the machine is turned on. Press  .	p. 11
②		Select the pattern category. For a one-point pattern, select  . (Continue with ③.) For a frame pattern, select  . (Continue with ⑨.) For a template pattern, select  . (Continue with ⑨.) To select a saved pattern, select  . (Continue with ⑩.)	p. 11
③		Select the pattern.	p. 12
④		Insert the thread cassette with the number that is displayed. If  is pressed, continue with ⑫. If  is pressed, continue with ⑧.	p. 13
⑤		Insert the design frame with the side shown in the display facing up. Then, press  .	p. 16
⑥		The embroidery is being sewn.	p. 17
⑦		Press the thread cartridge release button () , and then remove the thread cartridge.	p. 20

Repeat for each color.

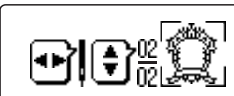
CONTENTS
Chapter 1
Chapter 2
Chapter 3
Chapter 4
Chapter 5
INDEX
Chapter 6

No.	Screen	Details	See page
⑧		<p>To sew the same pattern again (Then, continue with ④.):</p> <p>To save the pattern (Then, continue with ④.):</p> <p>To select a different pattern (Then, continue with ②.):</p>	 <p>p. 20</p>
To type in text (for a template text):			
⑨		<p>Select the pattern.</p>	<p>p. 12</p>
⑩		<p>Select the font and text size.</p>	<p>p. 28</p>
⑪		<p>Enter the text.</p> <p>Press , ,  or  to select the character.</p> <p>When you are finished entering the text, select , and then press . (If you are finished entering all lines of text for the pattern, continue with ④.)</p>	<p>p. 28</p>
⑫		<p>To delete a character, select .</p>	<p>p. 31</p>
⑬		<p>To check the text, select .</p>	<p>p. 32</p>
To save a pattern:			
⑭		<p>Select a pocket.</p> <p>To select a pocket where a pattern is not saved yet (Then, continue with ⑰.):</p> <p>To select a pocket where a pattern is already saved (Then, continue with ⑮.):</p>	 <p>p. 35</p>
⑮		<p>Check the saved pattern. (Then, continue with ⑰.)</p> <p>For a template pattern, press , and then continue with ⑯.</p>	<p>p. 35</p>
⑯		<p>Check the text in a saved pattern. (Then, continue with ⑰.)</p> <p>For more than one line, press  to check the next line.</p>	<p>p. 39</p>

No.	Screen	Details	See page
⑰		The pattern is saved. (Then, continue with ⑱.)	p. 35
To retrieve a saved pattern:			
⑱		Select a pocket.	p. 37
⑲		Check the pattern. (Then, continue with ④.) For a template pattern, press  , and then continue with ⑳.	p. 37
㉑		Check the text in the pattern. (Then, continue with ④.) For more than one line, press  to check the next line.	p. 39
While embroidering:			
㉑		To find a thread color, press  or  . To find a stitch, press  or  . (Then, continue with ④.)	p. 43

ENGLISH
FRANÇAIS
ESPAÑOL

885-311
194311-014
0202

Printed in China