

brother®

- 1** *KNOWING YOUR SEWING MACHINE*
- 2** *SEWING BASICS*
- 3** *VARIOUS STITCHES*
- 4** *APPENDIX*

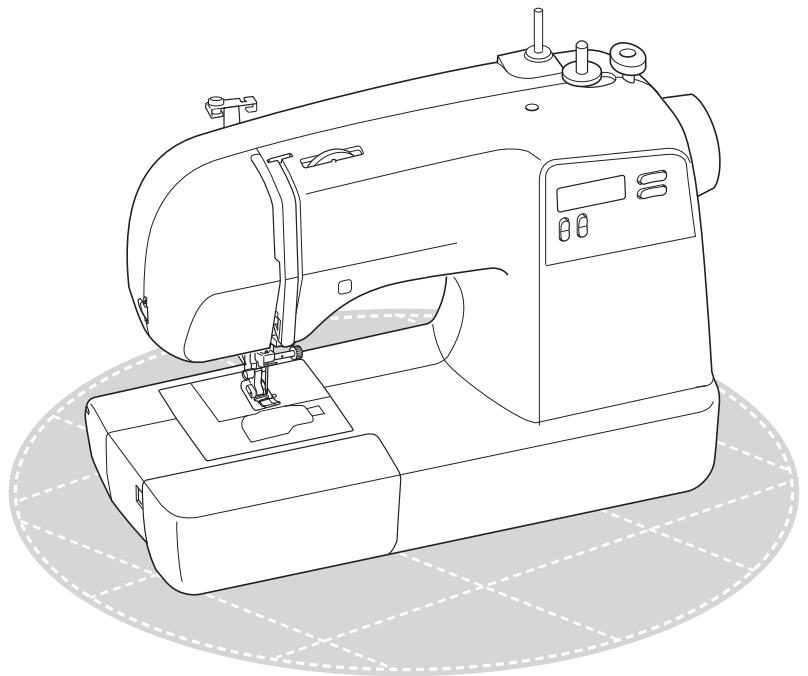

# Computerized Sewing Machine Operation Manual

Please visit us at <http://solutions.brother.com> where you can get product support and answers to frequently asked questions (FAQs).

## INTRODUCTION

Thank you for purchasing this sewing machine. Before using this machine, carefully read the "IMPORTANT SAFETY INSTRUCTIONS", and then study this manual for the correct operation of the various functions. In addition, after you have finished reading this manual, store it where it can quickly be accessed for future reference.

## IMPORTANT SAFETY INSTRUCTIONS

Please read these safety instructions before attempting to use the machine.

### **DANGER** - To reduce the risk of electric shock:

- 1 Always** unplug the machine from the electrical outlet immediately after using, when cleaning, when making any user servicing adjustments mentioned in this manual, or if you are leaving the machine unattended.

### **WARNING** - To reduce the risk of burns, fire, electric shock, or injury to persons.

- 2 Always** unplug the machine from the electrical outlet when making any adjustments mentioned in the instruction manual:

- To unplug the machine, switch the machine to the symbol "O" position to turn it off, then grasp the plug and pull it out of the electrical outlet. **Do not** pull on the cord.
- Plug the machine directly into the electrical outlet. Do not use an extension cord.
- **Always** unplug your machine if the power is cut.

- 3 Never** operate this machine if it has a damaged cord or plug, if it is not working properly, if it has been dropped or damaged, or water is spilled on the unit. Return the machine to the nearest authorized dealer or service center for examination, repair, electrical or mechanical adjustment. While the machine is stored or in use if you notice anything unusual, such as an odor, heat, discoloration or deformation, stop using the machine immediately and unplug the power cord. When transporting the sewing machine, be sure to carry it by its handle. Lifting the sewing machine by any other part may damage the machine or result in the machine falling, which could cause injuries.

When lifting the sewing machine, be careful not to make any sudden or careless movements, otherwise you may injure your back or knees.

## 4 Always keep your work area clear:

- Never operate the machine with any air openings blocked. Keep ventilation openings of the sewing machine and foot control free from the build up of lint, dust, and loose cloth.
- **Do not** store objects on the foot controller.
- **Do not** use extension cords. Plug the machine directly into the electrical outlet.
- **Never** drop or insert **any** object into **any** opening.
- **Do not** operate where aerosol (spray) products are being used or where oxygen is being administered.
- **Do not** use the machine near a heat source, such as a stove or iron; otherwise, the machine, power cord or garment being sewn may ignite, resulting in fire or an electric shock.
- **Do not** place this sewing machine on an unstable surface, such as an unsteady or slanted table, otherwise the sewing machine may fall, resulting in injuries.

## 5 Special care is required when sewing:

- **Always** pay close attention to the needle. Do not use bent or damaged needles.
- Keep fingers away from **all** moving parts. Special care is required around the machine needle.
- Switch the sewing machine to the symbol "O" position to turn it off when making any adjustments in the needle area.
- **Do not** use a damaged or incorrect needle plate, as it could cause the needle to break.
- **Do not** push or pull the fabric when sewing, and follow careful instruction when freehand stitching so that you do not deflect the needle and cause it to break.

## 6 This machine is **not** a toy:

- Your close attention is necessary when the machine is used by or near children.
- The plastic bag that this sewing machine was supplied in should be kept out of the reach of children or disposed of. Never allow children to play with the bag due to the danger of suffocation.
- **Do not** use outdoors.

## 7 For a longer service life:

- When storing this machine, avoid direct sunlight and high humidity locations. Do not use or store the machine near a space heater, iron, halogen lamp, or other hot objects.
- Use only neutral soaps or detergents to clean the case. Benzene, thinner, and scouring powders can damage the case and machine, and should never be used.
- Always consult the operation manual when replacing or installing any assemblies, the presser feet, needle, or other parts to assure correct installation.

## **8 For repair or adjustment:**

- If the Light unit (light-emitting diode) is damaged, it must be replaced by authorized dealer.
- In the event a malfunction occurs or adjustment is required, first follow the troubleshooting table in the back of the operation manual to inspect and adjust the machine yourself. If the problem persists, please consult your local authorized Brother dealer.

**Use this machine only for its intended use as described in this manual.**

**Use accessories recommended by the manufacturer as contained in this manual.**

**The contents of this manual and specifications of this product are subject to change without notice.**

**For additional product information, visit our web site at [www.brother.com](http://www.brother.com)**

**SAVE THESE INSTRUCTIONS**  
**This machine is intended for household use.**

**FOR USERS IN THE UK, EIRE,  
MALTA AND CYPRUS ONLY**

### **IMPORTANT**

- In the event of replacing the plug fuse, use a fuse approved by ASTA to BS 1362, i.e. carrying the  mark, rating as marked on plug.
- Always replace the fuse cover. Never use plugs with the fuse cover omitted.
- If the available electrical outlet is not suitable for the plug supplied with this equipment, you should contact your authorized dealer to obtain the correct lead.

**FOR USERS IN AC INPUT 220-240V  
COUNTRIES AND MEXICO**

This appliance is not intended for use by persons (including children) with reduced physical, sensory or mental capabilities, or lack of experience and knowledge, unless they have been given supervision or instruction concerning use of the appliance by a person responsible for their safety. Children should be supervised to ensure that they do not play with the appliance.

# CONTENTS

<b>1. KNOWING YOUR SEWING MACHINE</b> .....	<b>5</b>
<b>NAMES OF MACHINE PARTS AND THEIR FUNCTIONS</b> .....	<b>5</b>
The main parts .....	5
Needle and presser foot section .....	6
Operation buttons .....	6
Operation panel .....	7
Flat bed attachment .....	7
<b>ACCESSORIES</b> .....	<b>8</b>
Optional accessories .....	8
<b>USING YOUR SEWING MACHINE</b> .....	<b>9</b>
Power supply precautions .....	9
Turning on the machine .....	9
Foot controller .....	10
Sewing speed controller (for models equipped with the sewing speed controller) .....	10
Changing the needle stop position .....	10
Changing the initial needle position .....	11
Cancelling the operation beep .....	11
<b>THREADING THE MACHINE</b> .....	<b>12</b>
Winding the bobbin .....	12
Lower threading .....	15
Upper threading .....	17
Drawing up the lower thread .....	20
<b>REPLACING THE NEEDLE</b> .....	<b>21</b>
Needle precautions .....	21
Needle types and their uses .....	21
Checking the needle .....	22
Replacing the needle .....	22
Sewing with a twin needle .....	24
<b>REPLACING THE PRESSER FOOT</b> .....	<b>25</b>
Replacing the presser foot .....	25
Removing the presser foot holder .....	26
<b>2. SEWING BASICS</b> .....	<b>27</b>
<b>SEWING</b> .....	<b>27</b>
General sewing procedure .....	27
Selecting a stitch .....	28
Starting to sew .....	29
Adjusting thread tension .....	31
<b>USEFUL SEWING TIPS</b> .....	<b>32</b>
Trial sewing .....	32
Changing the sewing direction .....	32
Sewing curves .....	32
Sewing thick fabrics .....	32
Sewing hook-and-loop fastener .....	33
Sewing thin fabrics .....	34
Sewing stretch fabrics .....	34
Using a free-arm style .....	34

<b>3. VARIOUS STITCHES</b> .....	<b>35</b>
<b>STITCH SETTINGS</b> .....	<b>35</b>
Utility stitches .....	35
Character stitches (for models equipped with character stitches) .....	41
<b>OVERCASTING STITCHES</b> .....	<b>42</b>
<b>BASIC STITCHING</b> .....	<b>43</b>
Basic stitching .....	43
<b>BLIND HEM STITCHING</b> .....	<b>44</b>
<b>BUTTONHOLE SEWING</b> .....	<b>46</b>
Button sewing .....	49
<b>ZIPPER INSERTION</b> .....	<b>51</b>
<b>SEWING STRETCH FABRICS AND ELASTIC TAPE</b> .....	<b>52</b>
Stretch stitching .....	52
Elastic attaching .....	52
<b>APPLIQUÉ, PATCHWORK AND QUILT STITCHING</b> .....	<b>53</b>
Appliqués .....	53
Patchwork (crazy quilt) stitching .....	54
Piecing .....	54
Quilting .....	55
Free-motion quilting .....	56
<b>REINFORCEMENT STITCHING</b> .....	<b>57</b>
Triple stretch stitching .....	57
Bar tack stitching .....	57
<b>DECORATIVE STITCHING</b> .....	<b>59</b>
Fagoting .....	60
Scallop stitching .....	61
Smocking .....	61
Shell tuck stitching .....	62
Joining .....	62
Heirloom stitching .....	63
<b>SEWING CHARACTERS (for models equipped with character stitches)</b> .....	<b>64</b>
Selecting characters .....	64
Checking characters .....	66
Deleting characters .....	66
Sewing the character stitches .....	67
<b>ADJUSTING STITCHES (for models equipped with character stitches)</b> .....	<b>68</b>
<b>4. APPENDIX</b> .....	<b>70</b>
<b>MAINTENANCE</b> .....	<b>70</b>
Cleaning the machine surface .....	70
Cleaning the bobbin case .....	70
<b>TROUBLESHOOTING</b> .....	<b>72</b>
<b>ERROR MESSAGES</b> .....	<b>75</b>
Operation beep (for models equipped with the operation beep) .....	75
<b>INDEX</b> .....	<b>76</b>

# 1 KNOWING YOUR SEWING MACHINE

## NAMES OF MACHINE PARTS AND THEIR FUNCTIONS

### The main parts

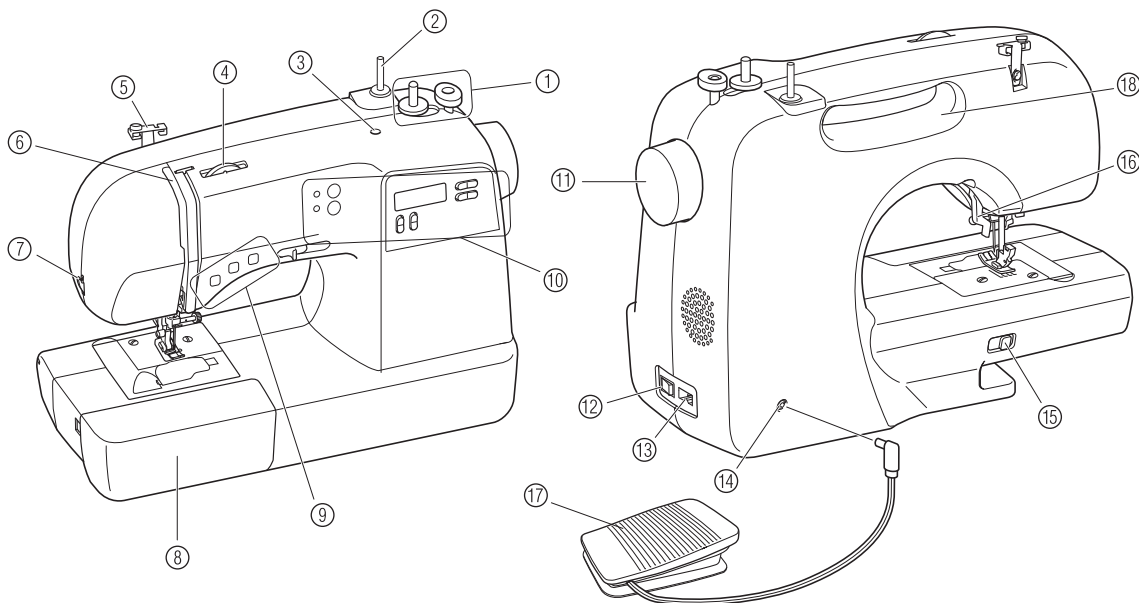

- ① **Bobbin winder (page 12)**  
This winds the thread onto the bobbin for use as the lower thread.
- ② **Spool pin (pages 12 and 17)**  
This holds the spool of thread.
- ③ **Hole for extra spool pin (page 24)**  
This holds a second spool of thread for sewing with two needles. Not for lubrication.
- ④ **Upper tension-control dial (page 31)**  
This controls the tension of the upper thread.
- ⑤ **Thread guide (pages 12 and 17)**  
This is used when winding the thread onto the bobbin and then threading the machine.
- ⑥ **Thread take-up lever (page 18)**
- ⑦ **Thread cutter (page 30)**  
Pass the threads through the thread cutter to cut them.
- ⑧ **Flat bed attachment with accessory compartment (pages 7 and 34)**
- ⑨ **Operation buttons (page 6)**  
The operation buttons differ depending on the sewing machine model.
- ⑩ **Operation panel (page 7)**  
This is used to select the stitch and specify the various settings.
- ⑪ **Handwheel**  
Used to manually raise and lower the needle.
- ⑫ **Main power and sewing light switch (page 9)**  
You can turn the main power and sewing light switch on and off.
- ⑬ **Jack/socket connector (page 9)**  
Insert the plug on the power supply cord into the jack/socket connector.
- ⑭ **Foot controller jack/socket (page 10)**  
Plug in the foot controller plug.
- ⑮ **Feed dog position lever (pages 49 and 56)**  
Use the feed dog position lever to lower the feed dogs.
- ⑯ **Presser foot lever (page 17)**  
Used to raise and lower the presser foot.
- ⑰ **Foot controller (page 10)**  
You can use this to control the sewing speed, and to start and stop sewing.
- ⑱ **Handle**  
Carry the sewing machine by its handle when transporting the machine.

## Needle and presser foot section

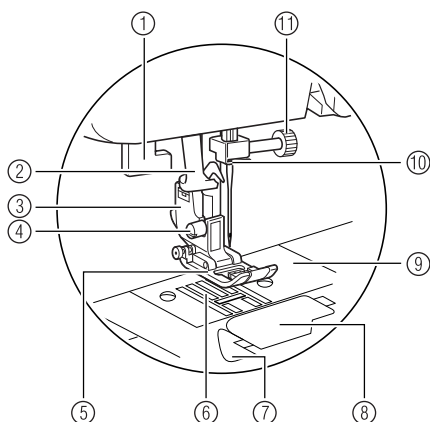



- ① **Buttonhole lever**  
Lower the buttonhole lever when sewing buttonholes and bar tacks.
- ② **Needle threader (for models equipped with the needle threader) (page 18)**
- ③ **Presser foot holder**  
The presser foot is installed onto the presser foot holder.

- ④ **Presser foot holder screw**  
Use the presser foot holder screw to hold the presser foot holder in place.
- ⑤ **Presser foot**  
The presser foot applies pressure consistently on the fabric as the sewing takes place. Attach the appropriate presser foot for the selected stitching.
- ⑥ **Feed dogs**  
The feed dogs feed the fabric in the sewing direction.
- ⑦ **Quick-set bobbin (for models equipped with the quick-set bobbin)**  
You can start sewing without pulling up the bobbin thread.
- ⑧ **Bobbin cover**  
Open the bobbin cover to set the bobbin.
- ⑨ **Needle plate**  
The needle plate is marked with guides for sewing straight seams.
- ⑩ **Needle bar thread guide**  
Pass the upper thread through the needle bar thread guide.
- ⑪ **Needle clamp screw**  
Use the needle clamp screw to hold the needle in place.

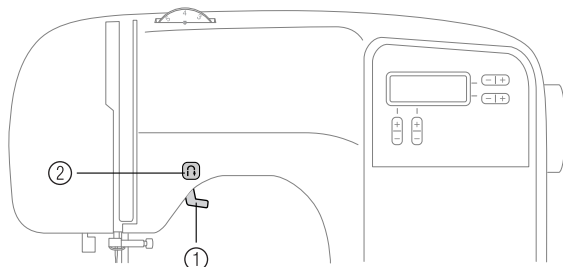

## Operation buttons

The operation buttons help you to easily perform various basic sewing machine operations. The operation buttons differ depending on the sewing machine model.

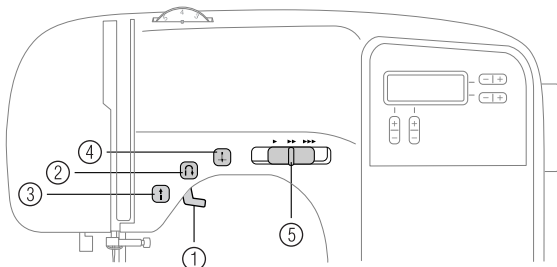

- ① **Presser foot lever**  
Raise and lower the presser foot lever to raise and lower the presser foot.
- ② **Reverse/reinforcement stitch button**   
Press the reverse/reinforcement stitch button to sew reverse stitches. Reverse stitches are sewn by keeping the button pressed down to sew in the opposite direction. For details, refer to “Sewing reinforcement stitches” (page 30).



- **Buttons provided on some models**
- ③ **Start/stop button**  (for models equipped with the start/stop button)  
Press the start/stop button to start or stop sewing. The machine sews at a slow speed at the beginning of sewing while the button is depressed. When sewing is stopped, the needle is lowered in the fabric. For details, refer to “Starting to sew” (page 29).
- ④ **Needle position button**  (for models equipped with the needle position button)  
Press the needle position button to raise or lower the needle. Pressing the button twice sews one stitch.
- ⑤ **Sewing speed controller (for models equipped with the sewing speed controller)**  
Slide the sewing speed controller to adjust the sewing speed.



## Operation panel

The operation panel, located on the front of the sewing machine, allows you to select a stitch and specify how the stitch will be sewn.

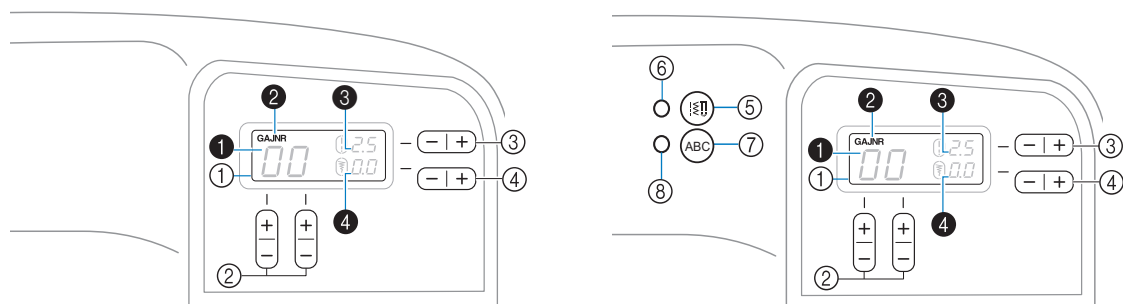

### ① LCD (liquid crystal display)

The number of the selected stitch (①), the presser foot to be used (②), the stitch length (mm) (③), and the stitch width (mm) (④) are displayed here.

### ② Stitch selection keys

Press the stitch selection keys, and then select the number for the stitch that you wish to use. For details, refer to "Selecting a stitch" (page 28).

### ③ Stitch length adjustment key

Press this key to adjust the stitch length.

(For models equipped with the character stitch key)  
Press this key to check the combined characters. For details, refer to "Checking characters" (page 66).

### ④ Stitch width adjustment key

Press this key to adjust the stitch width.

(For models equipped with the character stitch key)  
Press this key to add or delete characters. For details, refer to "SEWING CHARACTERS (for models equipped with character stitches)" (page 64).

### ■ Keys and indicators provided on some models

#### ⑤ Utility stitch key

Press this key to sew utility stitches. For details, refer to "Selecting a stitch" (page 28).

#### ⑥ Utility stitch indicator

This indicator lights up when the utility stitch key is pressed.

#### ⑦ Character stitch key

Press this key to sew character stitches. For details, refer to "SEWING CHARACTERS (for models equipped with character stitches)" (page 64).

#### ⑧ Character stitch indicator

This indicator lights up when the character stitch key is pressed.

## Flat bed attachment

The accessories are stored in a compartment inside the flat bed attachment.

### 1 Slide the flat bed attachment to the left to open it.

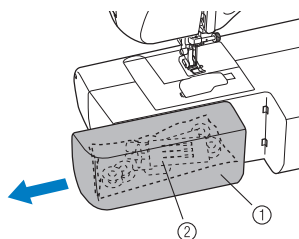

- ① Flat bed attachment
- ② Storage compartment



### Note

- Put the accessories in the bag, and then store the bag inside the compartment. If the accessories are not in a bag, they may fall out, and be lost or damaged.

## ACCESSORIES

The following accessories are stored in the flat bed attachment. We have designed these accessories to help you be able to carry out most sewing tasks.



### Note

(For U.S.A. only)

- Foot controller: Model T  
This foot controller can be used on the following machine models: HS-3000, SQ-9000.
- The screw of the presser foot holder is available through your authorized dealer. (Part code: 132730-122)

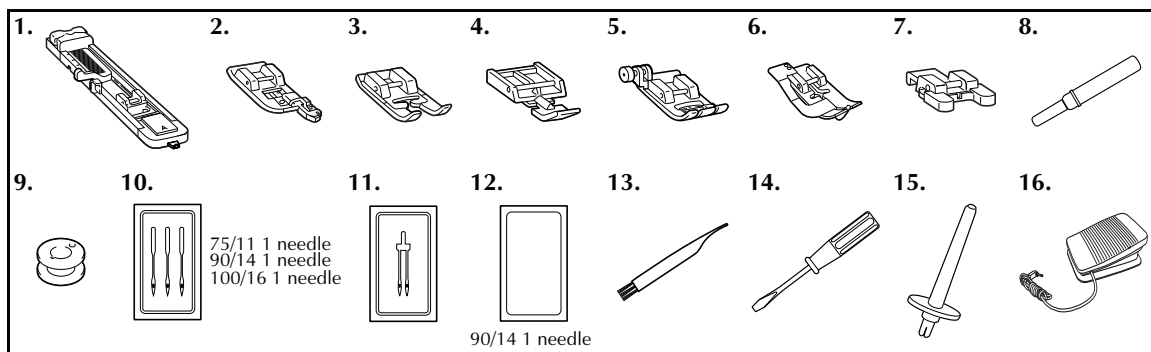

No.	Part Name	Part Code		No.	Part Name	Part Code	
		U.S.A. / Canada	Others			U.S.A. / Canada	Others
1	Buttonhole foot "A"	XC2691-033		9	Bobbin (4)	SA156	XA5539-151
2	Overcasting foot "G"	XC3098-031		10	Needle set	XC8834-021	
3	Monogramming foot "N"	XD0810-031		11	Twin needle	131096-121	
4	Zipper foot "I"	X59370-021		12	Ball point needle (gold colored)	XD0360-021	
5	Zigzag foot "J" (on machine)	XC3021-031		13	Cleaning brush	X59476-021	
6	Blind stitch foot "R"	XC4051-031		14	Screwdriver	XC8349-021	
7	Button fitting foot "M"	XE2137-001		15	Extra spool pin	130920-021	
8	Seam ripper	X54243-051		16	Foot controller	XD0501-021 (EU area) XC8816-021 (Other areas)	

## Optional accessories

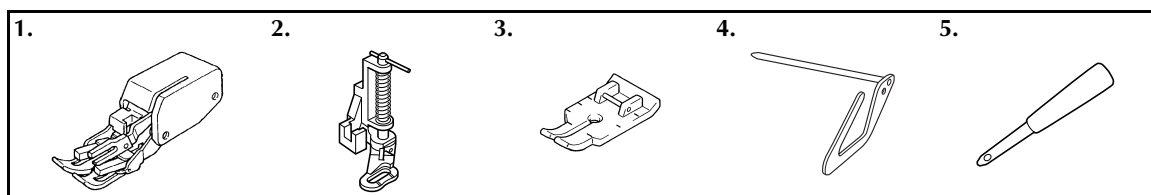

No.	Part Name	Part Code		No.	Part Name	Part Code	
		U.S.A. / Canada	Others			U.S.A. / Canada	Others
1	Walking Foot	SA140	F033N	4	Quilting guide	SA132	F016N
2	Quilting Foot	SA129	F005N	5	Eyelet punch	XZ5051-001	
3	1/4-Inch Quilting Foot	SA125	F001N				

# USING YOUR SEWING MACHINE

## Power supply precautions

Be sure to observe the following precautions concerning the power supply.

### ! WARNING

- Use only regular household electricity for the power source. Using other power sources may result in fire, electric shock, or damage to the machine.
- Make sure that the plugs on the power cord are firmly inserted into the electrical outlet and the power supply jack on the machine.
- Do not insert the plug on the power cord into an electrical outlet that is in poor condition.
- Turn off the main power and remove the plug in the following circumstances:
  - When you are away from the machine
  - After using the machine
  - When the power fails during use
  - When the machine does not operate correctly due to a bad connection or a disconnection
  - During electrical storms

### ! CAUTION

- Use only the power cord included with this machine.
- Do not use extension cords or multi-plug adapters with many other appliances plugged in to them. Fire or electric shock may result.
- Do not touch the plug with wet hands. Electric shock may result.
- When unplugging the machine, always turn off the main power first. Always grasp the plug to remove it from the outlet. Pulling on the cord may damage the cord, or lead to fire or electric shock.
- Do not allow the power cord to be cut, damaged, modified, forcefully bent, pulled, twisted, or bundled. Do not place heavy objects on the cord. Do not subject the cord to heat. These things may damage the cord and cause fire or electric shock. If the cord or plug is damaged, take the machine to your authorized dealer for repairs before continuing use.
- Unplug the power cord if the machine is not to be used for a long period of time. Otherwise a fire may result.

## Turning on the machine

- 1 Insert the plug into a wall outlet.

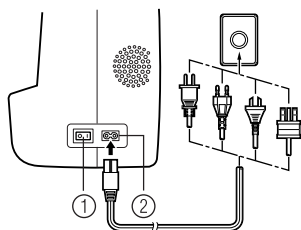

- 1 Main power switch
- 2 Jack/socket connector

- 2 Set the main power switch to "I".

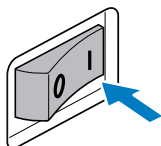

- ▶ The sewing lamp comes on when the machine is turned on.

- 3 To turn off the machine, set the main power switch to "O".

- ▶ The sewing lamp goes off when the machine is turned off.

### Note

- If a power outage occurs while the sewing machine is being operated, turn off the sewing machine and unplug the power supply cord. When restarting the sewing machine, follow the necessary procedure to correctly operate the machine.

(For U.S.A. only)

- This appliance has a polarized plug (one blade wider than the other). To reduce the risk of electric shock, this plug is intended to fit in a polarized outlet only one way. If the plug does not fit fully in the outlet, reverse the plug. If it still does not fit, contact a qualified electrician to install the proper outlet. Do not modify the plug in any way.

## Foot controller

Insert the foot controller plug into its jack/socket on the rear side of the sewing machine.

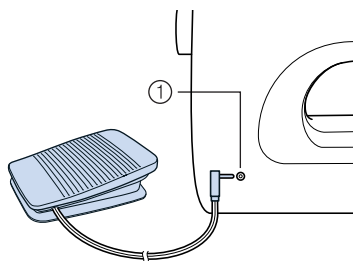

① Foot controller jack/socket

### CAUTION

- When connecting the foot controller, be sure to turn off the sewing machine in order to prevent the machine from accidentally being started.

When you press the foot controller down lightly, the machine will run at a low speed. When you press harder, the machine's speed will increase. When you take your foot off the foot controller, the machine will stop.

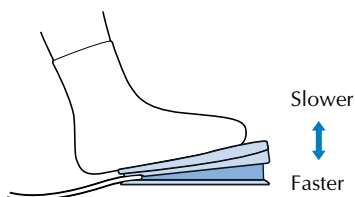

You should make sure that nothing is placed on the foot controller when the machine is not in use.

### CAUTION

- Do not allow pieces of cloth and dust to build up on the foot controller. Doing so could cause a fire or an electric shock.



### Note

- When the foot controller is plugged in, the start/stop button cannot be used to start sewing (only for models equipped with the start/stop button).

## Sewing speed controller (for models equipped with the sewing speed controller)

- 1 Slide the sewing speed controller to the left or right to select the desired sewing speed. Slide the sewing speed controller to the left to sew at a slower speed, or slide the speed controller to the right to sew at a faster speed.

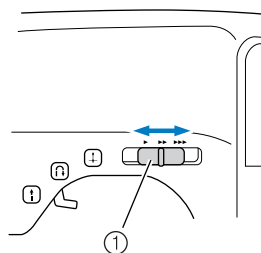

① Sewing speed controller



- The speed set using the sewing speed controller is the foot controller's maximum sewing speed.

## Changing the needle stop position

Normally, the sewing machine is set to leave the needle in the fabric when sewing is stopped. Instead, the machine can be set to leave the needle raised when sewing is stopped.

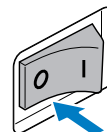
- 1 Turn off the sewing machine.



- 2 Hold down the "-" side of  (stitch selection key) on the left and turn on the sewing machine. After turning on the sewing machine, release the "-" side of  (stitch selection key).

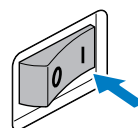
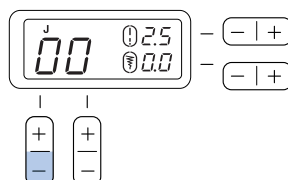

- ▶ The needle stop position changes to the raised position.



### Memo

- Perform the same operation to change the needle stop position to the lowered position.

## Changing the initial needle position

Normally, the straight stitch (left needle position) is automatically selected when the sewing machine is turned on. The machine can be set so that the straight stitch (center needle position) is automatically selected when it is turned on.

### 1 Turn off the sewing machine.

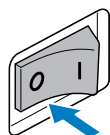

### 2 Hold down the "+" side of (stitch selection key) on the left and turn on the sewing machine.

After turning on the sewing machine, release the "+" side of  (stitch selection key).

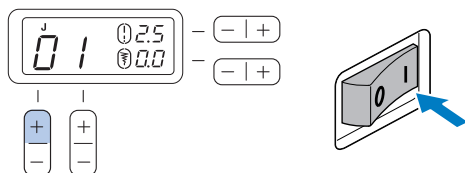

► The initial needle position changes to the center needle position.



### Memo

- The specified initial needle position is maintained even after the machine is turned off.
- Perform the same operation to change the initial needle position to the left needle position.

## Cancelling the operation beep

When the sewing machine is purchased, it is set to beep each time a key is pressed. This setting can be changed so that the machine does not beep.

### 1 Turn off the sewing machine.

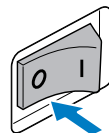

### 2 Hold down the "-" side of (stitch width adjustment key) and turn on the sewing machine.

After turning on the sewing machine, release the "-" side of  (stitch width adjustment key).

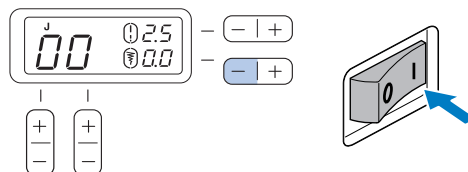

► The machine is now set so that it will not beep.

# THREADING THE MACHINE

## Winding the bobbin

This section describes how to wind the thread onto the bobbin.

- For details on the fast bobbin winding, see page 14.

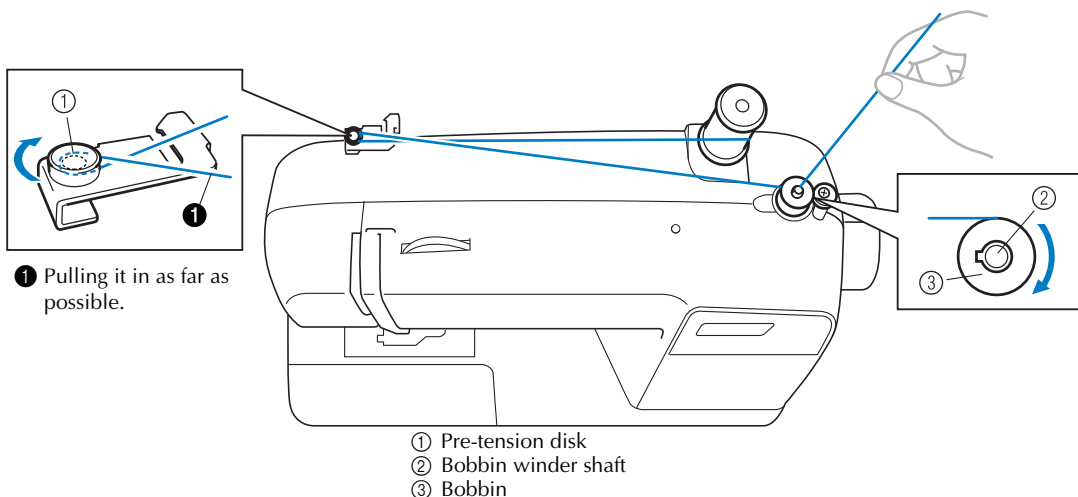

### CAUTION

- Only use bobbins (part code: SA156, SFB) that have been designed for this sewing machine. Using other bobbins may cause damage to the machine.
- We designed the bobbin that comes with this machine. If you use bobbins from other models, the machine will not work properly. Only use the bobbin that comes with this machine or bobbins of the same type (part code: SA156, SFB).

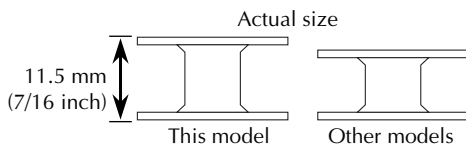

- 1 Pull up the spool pin as far as possible, and then put a spool of thread on this pin.
- 2 Pass the thread around the pre-tension disk.

### CAUTION

- If the spool of thread is not in the right place, the thread may tangle on the spool pin.

- 3 Pass the end of the thread through the hole on the bobbin from the inside of the bobbin.

- 4 Put the bobbin onto the bobbin winder shaft and slide the bobbin winder shaft to the right. Turn the bobbin clockwise, by hand, until the spring on the shaft slides into the groove of the bobbin.

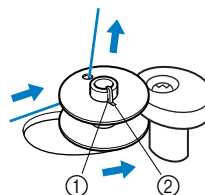

- 5 Turn on the sewing machine.

**6** While holding the end of the thread, gently press the foot controller or press  (start/stop button) (for models equipped with the start/stop button) to wind the thread around the bobbin a few times. Then stop the machine.

 **Note**

- If the sewing machine is to be operated using the foot controller, connect the foot controller before turning on the machine.
- When the foot controller is plugged in, the start/stop button cannot be used to start sewing (only for models equipped with the start/stop button).

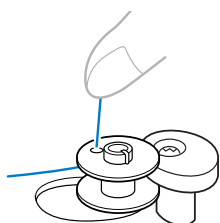

**7** Trim the excess thread above the bobbin.

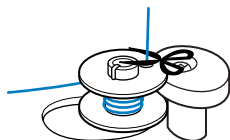

**CAUTION**

- Make sure you follow the instructions carefully. If you do not cut the thread completely, and the bobbin is wound, when the thread runs low it may tangle around the bobbin and cause the needle to break.

**8** Slide the sewing speed controller to the right (to set the speed to fast) (for models equipped with the sewing speed controller).

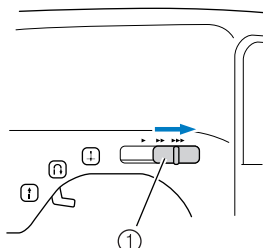

① Sewing speed controller

**9** Press the foot controller or press  (start/stop button) (for models equipped with the start/stop button) to start.

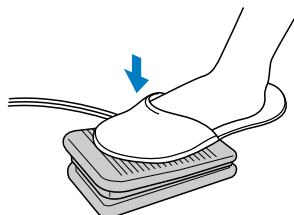

**10** When the bobbin seems full and begins spinning slowly, take your foot off the foot controller or press  (start/stop button) (for models equipped with the start/stop button).

**11** Cut the thread, slide the bobbin winder shaft to the left and remove the bobbin.

**12** Slide the sewing speed controller back to its original position (for models equipped with the sewing speed controller).

 **Memo**

- When the sewing machine is started or the handwheel is turned after winding the thread around the bobbin, the machine will make a clicking sound; this is not a malfunction.
- The needle bar does not move when you slide the bobbin winding shaft to the right.

**CAUTION**

- Not winding the bobbin properly may cause the thread tension to loosen, and may break the needle.

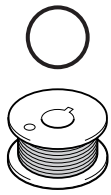

①



②

① Wound evenly  
② Wound poorly

**■ For models equipped with the fast bobbin winding system**

**1** Follow steps ① through ② of the procedure in “Winding the bobbin” to pass the thread around the pre-tension disk (page 12).

**2** Place the bobbin on the bobbin winder shaft so that the spring on the shaft fits into the notch in the bobbin.

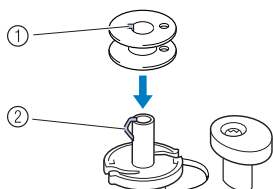

- ① Notch
- ② Bobbin winder shaft spring

**3** Slide the bobbin winder shaft to the right.

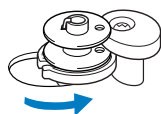

**4** While holding the thread that wraps around the pre-tension disk with your left hand, use your right hand to wind the free end of the thread clockwise around the bobbin five or six times.

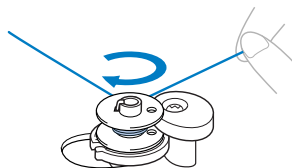

**5** Pull the thread to the right and pass it through the slit in the bobbin winder seat.

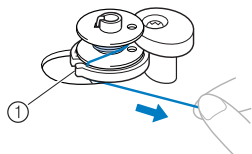

- ① Slit in bobbin winder seat (with built-in cutter)
- ▶ The thread is cut to a suitable length.

**! CAUTION**

● Be sure to cut the thread as described. If the bobbin is wound without cutting the thread using the cutter built into the slit in the bobbin winder seat, the thread may become tangled in the bobbin or the needle may bend or break when the bobbin thread starts to run out.

**6** Slide the sewing speed controller to the right (to set the speed to fast) (for models equipped with the sewing speed controller).

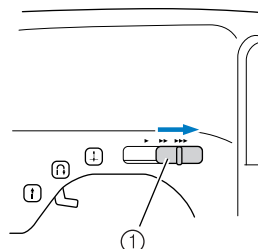

- ① Sewing speed controller

**7** Turn on the sewing machine.

**8** Press the foot controller or press **⏻** (start/stop button) (for models equipped with the start/stop button) to start.

**Note**

- If the sewing machine is to be operated using the foot controller, connect the foot controller before turning on the machine.
- When the foot controller is plugged in, the start/stop button cannot be used to start sewing (only for models equipped with the start/stop button).

**9** When the bobbin begins spinning slowly, take your foot off the foot controller or press **⏻** (start/stop button) (for models equipped with the start/stop button).

**10** Cut the thread, slide the bobbin winder shaft to the left and remove the bobbin.

**11** Slide the sewing speed controller back to its original position (for models equipped with the sewing speed controller).

**! CAUTION**

● Not winding the bobbin properly may cause the thread tension to loosen, and may break the needle.

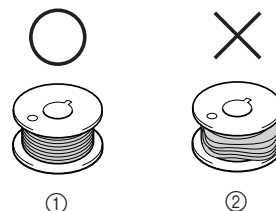

- ① Wound evenly
- ② Wound poorly



## Memo

- When the sewing machine is started or the handwheel is turned after winding the thread around the bobbin, the machine will make a clicking sound; this is not a malfunction.
- The needle bar does not move when you slide the bobbin winding shaft to the right.

## Lower threading

Install the bobbin wound with thread.

- For more details on quick-set bobbin, see page 16.

### CAUTION

- Winding the bobbin improperly may cause the thread tension to loosen, breaking the needle and resulting in injury.

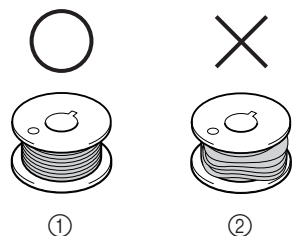

- ① Wound evenly  
② Wound poorly

- The bobbin was designed specifically for this sewing machine. If bobbins from other models are used, the machine will not operate correctly. Use only the enclosed bobbin or bobbins of the same type (part code: SA156, SFB).

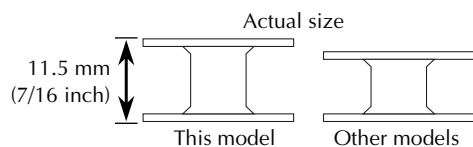

### CAUTION

- Make sure you turn the power off while threading the machine. If you accidentally step on the foot controller and the machine starts to sew, you could be injured.

- 1 Raise the needle to its highest position by turning the handwheel toward you (counterclockwise) or press  (needle position button) (for models equipped with the needle position button), and raise the presser foot lever.

- 2 Slide the button and open the cover.

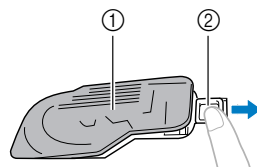

- ① Cover  
② Slide button

- 3 Put the bobbin in so the thread comes out in the direction shown by the arrow.

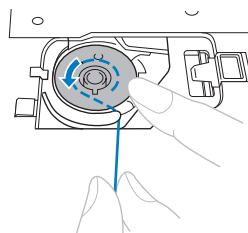

- Only use bobbins that were designed to be used with this machine.

### CAUTION

- Make sure you set the bobbin so the thread unrolls in the right direction. If the thread unrolls in the wrong direction, it may cause the thread tension to be incorrect or break the needle.

- 4 Hold the end of the thread, push the bobbin down with your finger, and then pass the thread through the slit, as shown.
  - If the thread is not correctly inserted through the tension-adjusting spring of the bobbin case, it may cause incorrect thread tension (page 31).

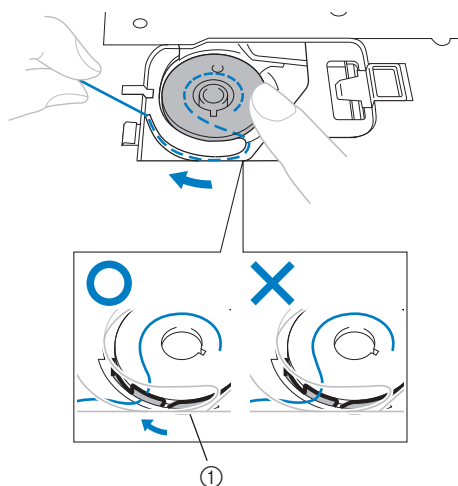

- ① Tension-adjusting spring

- 5** Replace the bobbin cover. Put the left tab in place (see arrow ①), and then press lightly on the right side (see arrow ②) until the cover clicks into place.

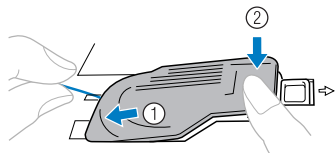

- Replace the cover so that the end of the thread comes out from the left side of the cover (as shown by the line in the diagram).

**■ For models equipped with the quick-set bobbin**

- 1** Raise the needle to its highest position by turning the handwheel toward you (counterclockwise) or press (needle position button) (for models equipped with the needle position button), and raise the presser foot lever.

- 2** Slide the button and open the cover.

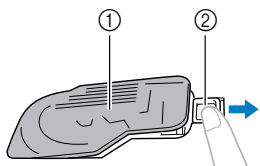

- ① Cover
- ② Slide button

- 3** Put the bobbin in, feed the end of the thread through the slit, and then pull the thread to cut it.

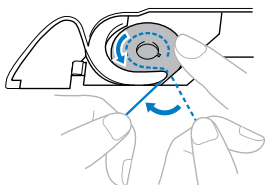

- Only use bobbins that were designed to be used with this machine.

**! CAUTION**

- Make sure you set the bobbin so the thread unrolls in the right direction. If the thread unrolls in the wrong direction, it may cause the thread tension to be incorrect or break the needle.

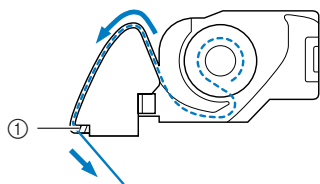

- ① Cutter

- If the thread is not correctly inserted through the tension-adjusting spring of the bobbin case, it may cause incorrect thread tension (page 31).

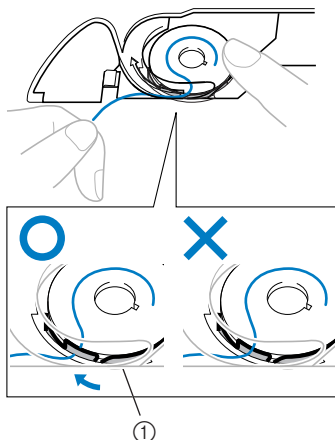

- ① Tension-adjusting spring

**🔔 Memo**

- The order that the bobbin thread should be passed through the bobbin case is indicated by marks around the bobbin case. Be sure to thread the machine as indicated.

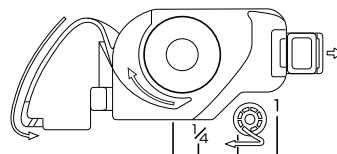

- 4** Replace the bobbin cover. Put the left tab in place (see arrow ①), and then press lightly on the right side (see arrow ②) until the cover clicks into place.

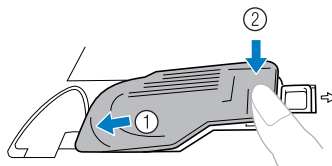

**🔔 Memo**

- You can begin sewing immediately without drawing up the bobbin thread. If you want to draw up the bobbin thread before you start to sew, follow the procedure in “Drawing up the lower thread” (page 20).

## Upper threading

Set the upper thread and thread the needle.

- For details on the needle threader, see page 18.

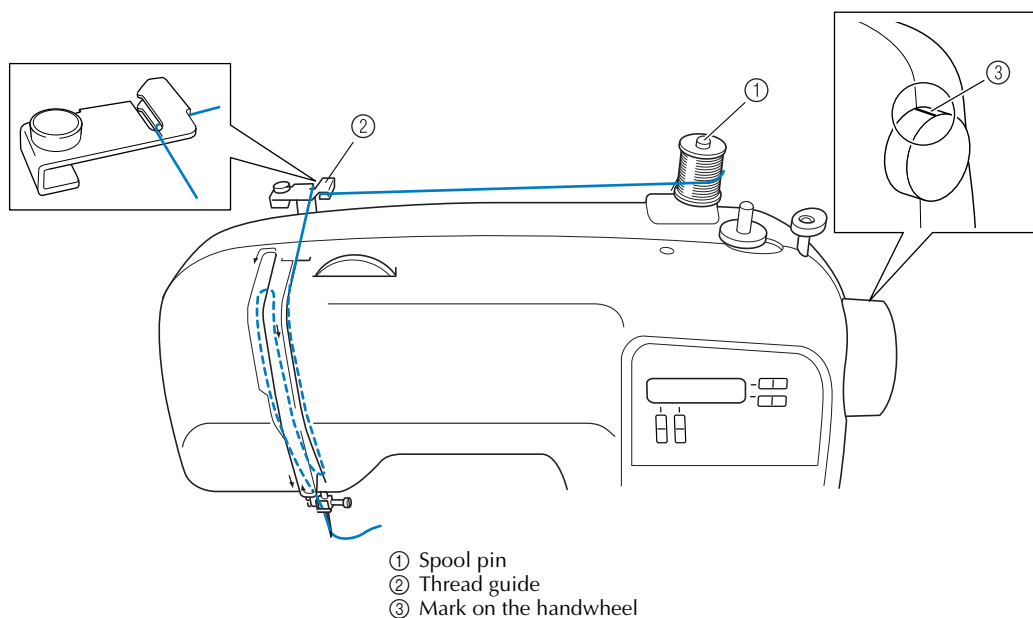

### CAUTION

- Make sure you thread the machine properly. Otherwise, the thread could tangle and break the needle.

- 1 Raise the presser foot using the presser foot lever.

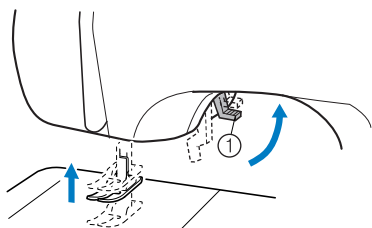

① Presser foot lever

- 2 Raise the needle by turning the handwheel toward you (counterclockwise) so that the mark on the wheel points up, or press  $\oplus$  (needle position button) (for models equipped with the needle position button) once or twice to raise the needle.

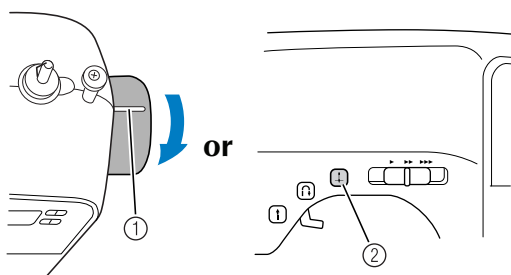

- If the needle is not correctly raised, the sewing machine can not be threaded. Be sure to turn the handwheel so that the mark on the wheel points up before threading the sewing machine.

- 3 Pull up the spool pin as far as possible, and then put a spool of thread on this pin.

**CAUTION**

- If the spool of thread is in the wrong place, or is set incorrectly, the thread may tangle on the spool pin and cause the needle to break.

- 4 Feed the upper thread as shown in the figure on the previous page.
- 5 Make sure you guide the thread through the thread take-up lever from right to left.

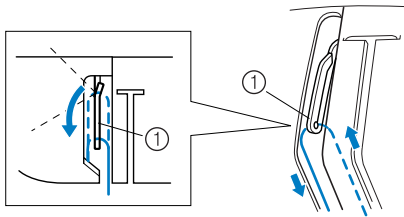

① Thread take-up lever

- 6 Put the thread behind the needle bar thread guide above the needle. The thread can easily be passed behind the needle bar thread guide by holding the thread in your left hand, then feeding the thread with your right hand.

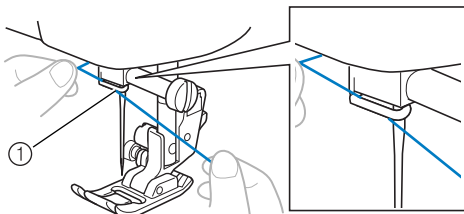

① Needle bar thread guide

- 7 Thread the needle from front to back and pull out about 5 cm (2 inch) of thread.

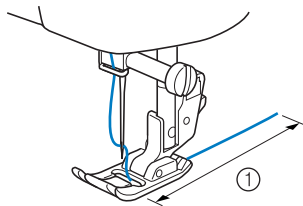

① 5 cm (2 inch)

**Note**

- If the thread take-up lever is lowered, the upper thread cannot be wrapped around the thread take-up lever. Make sure you raise the presser foot lever and the thread take-up lever before you feed the upper thread.
- If you incorrectly feed the thread you may cause sewing problems.

**Using the needle threader (for models equipped with the needle threader)**

**CAUTION**

- The needle threader can only be used with home sewing machine needles size 75/11-100/16. Check the table on page 21 for the appropriate needle and thread combinations. If you are using transparent nylon monofilament thread, you can only use needles in the range of 90/14-100/16.
- You cannot use the needle threader if you are using decorative threads or special needles, such as the twin needle and wing needle. If you are using those types of threads or needles, thread the eye of the needle by hand. Make sure the main power switch is off when threading the needle by hand.

- 1 Follow steps ① through ⑥ of the procedure in "Upper threading" to thread the machine to the needle bar thread guide.
- 2 Lower the presser foot lever.
- 3 While lowering the needle threader lever, hook the thread onto the guide.

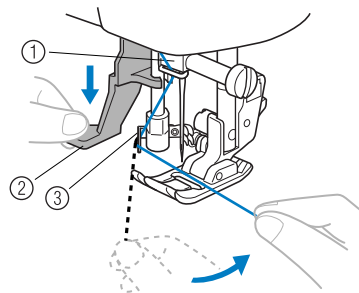

① Needle holder  
② Needle threader lever  
③ Guide

**4** Fully lower the needle threader lever.

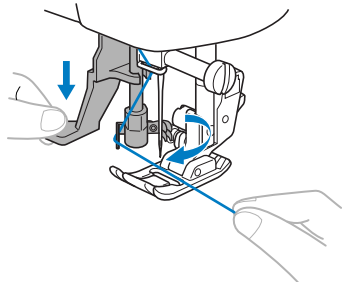

► The end of the needle threader rotates toward you and the hook passes through the eye of the needle.

**5** Catch the thread on the hook as shown below.

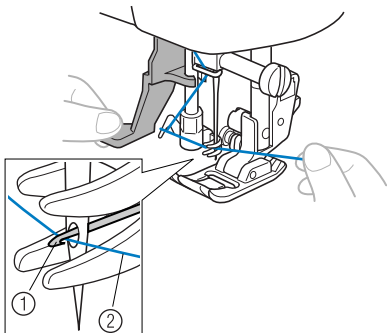

- ① Hook
- ② Thread

**6** While lightly holding the thread, release the needle threader lever. The hook will pull the thread through the needle.

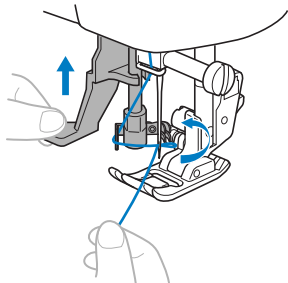

**7** Pull out about 5 cm (2 inch) of thread through the needle toward the back of the sewing machine.

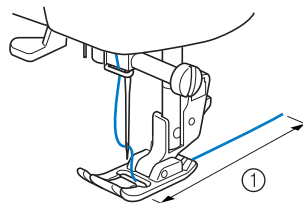
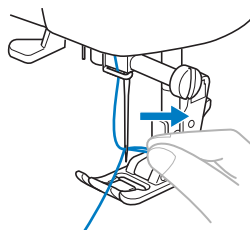

① 5 cm (2 inch)



**Note**

- If you incorrectly feed the thread you may cause sewing problems.

## Drawing up the lower thread

- 1** Lightly hold the end of the upper thread.

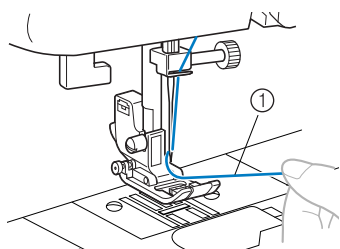

① Upper thread

- 2** While holding the end of the upper thread, raise the needle either by turning the handwheel toward you (counterclockwise) so that the mark on the wheel points up or by pressing  (needle position button) (for models equipped with the needle position button) once or twice.

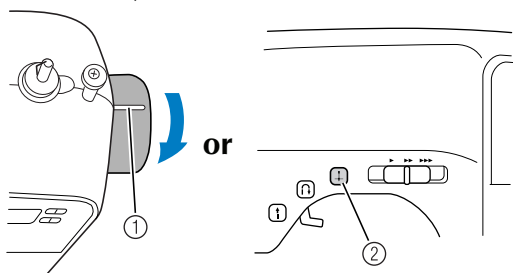

① Mark

② Needle position button

- 3** Pull on the upper thread to draw up the lower thread.

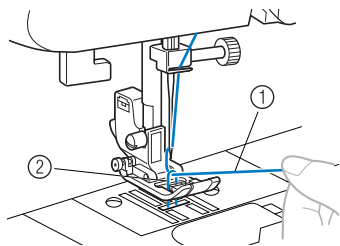

① Upper thread

② Lower thread

- 4** Pull out about 10 cm (4 inch) of both threads and pull them toward the back of the machine under the presser foot.

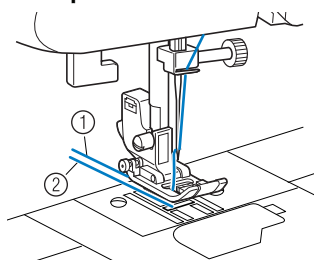

① Upper thread

② Lower thread

### ■ For models equipped with the quick-set bobbin

You can begin sewing immediately without drawing up the bobbin thread. When sewing gathers or darts, you can draw up the lower thread by hand so that some thread will be left over. Before you draw up the lower thread, put the bobbin back in.

- 1** Pass the thread along the slit in the direction of the arrow, and leave it there without cutting it.

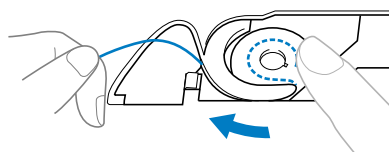

- The bobbin cover should still be removed.

- 2** Draw up the lower thread as described in steps 1 to 4.

- 3** Replace the bobbin cover.

## REPLACING THE NEEDLE

This section provides information on sewing machine needles.

### Needle precautions

Be sure to observe the following precautions concerning the handling of the needle. Failure to observe these precautions is extremely dangerous. Be sure to read and carefully follow the instructions below.

#### CAUTION

- Only use home sewing machine needles. Use of any other needle may bend the needle or damage the machine.
- Never use bent needles. Bent needles can easily break, possibly resulting in injury.

### Needle types and their uses

The sewing machine needle that should be used depends on the fabric and thread thickness. Refer to the following table when choosing the thread and needle appropriate for the fabric that you wish to sew.

Fabric Type/Application		Thread		Size of Needle
		Type	Size	
Medium weight fabrics	Broadcloth	Cotton thread	60–90	75/11–90/14
	Taffeta	Synthetic thread		
	Flannel, Gabardine	Silk thread	50	
Thin fabrics	Lawn	Cotton thread	60–90	65/9–75/11
	Georgette	Synthetic thread		
	Challis, Satin	Silk thread	50	
Thick fabrics	Denim	Cotton thread	30	100/16
			50	
	Corduroy	Synthetic thread	50–60	90/14–100/16
Tweed	Silk thread			
Stretch fabrics	Jersey	Thread for knits	50–60	Ball point needle (gold colored) 75/11–90/14
	Tricot			
Easily frayed fabrics		Cotton thread	50–90	65/9–90/14
		Synthetic thread		
		Silk thread	50	
For top-stitching		Synthetic thread	50	90/14–100/16
		Silk thread		



#### Memo

- The smaller the thread number, the thicker the thread; and the larger the needle number, the thicker the needle.
- Use the ball point needle when sewing on stretch fabrics or fabrics where skipped stitches easily occur.
- Use a 90/14 to 100/16 needle with transparent nylon threads, regardless of the fabric being sewn.
- A 75/11 needle is already installed when the sewing machine is purchased.

**CAUTION**

● The appropriate fabric, thread and needle combinations are shown in the table on the previous page. If the combination of the fabric, thread and needle is not correct, particularly when sewing thick fabrics (such as denim) with thin needles (such as 65/9 to 75/11), the needle may bend or break. In addition, the stitching may be uneven or puckered or there may be skipped stitches.

**Checking the needle**

Sewing with a bent needle is extremely dangerous since the needle may break while the machine is being operated.

Before using the needle, place the flat side of the needle on a flat surface and check that the distance between the needle and the flat surface is even.

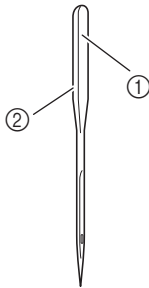

① Flat side  
② Needle type marking

■ **Correct needle**

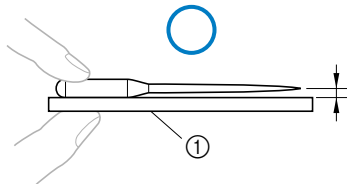

① Flat surface

■ **Incorrect needle**

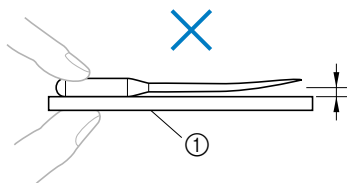

If the distance between the needle and the flat surface is not even, the needle is bent. Do not use a bent needle.



① Flat surface

**Replacing the needle**

Replace the needle as described below. Use the screwdriver and a needle that has been determined to be straight according to the instructions in "Checking the needle".

1 Raise the needle by turning the handwheel toward you (counterclockwise) so that the mark on the wheel points up. (With models equipped with  (needle position button), raise the needle by pressing  once or twice.)

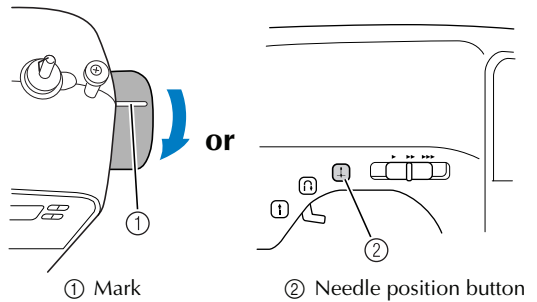

2 Turn off the sewing machine.

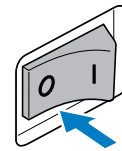

**CAUTION**

● Before replacing the needle, be sure to turn off the sewing machine, otherwise injuries may occur if the foot controller or the start/stop button is accidentally pressed and the machine starts sewing.

3 Lower the presser foot lever.

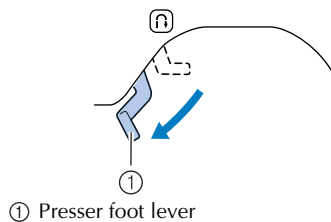



- 4** Hold the needle with your left hand, and then use a screwdriver to turn the needle clamp screw counterclockwise to remove the needle.



**Note**

- The needle can be removed by simply loosening the needle clamp screw about one turn. (If the needle clamp screw is loosened too much, the needle clamp (which holds the needle) may fall off. Therefore, do not loosen the needle clamp screw too much.)

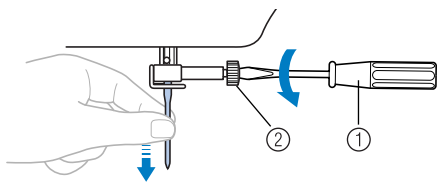

- ① Screwdriver
- ② Needle clamp screw

- Do not apply strong force when loosening or tightening the needle clamp screw, otherwise certain parts of the sewing machine may be damaged.

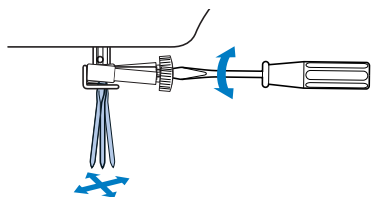

- 5** With the flat side of the needle toward the rear of the machine, insert the needle until it touches the needle stopper.

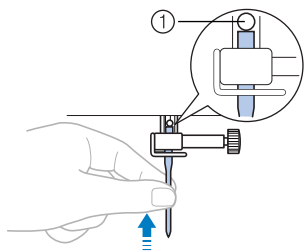

- ① Needle stopper

- 6** While holding the needle with your left hand, use the screwdriver to tighten the needle clamp screw by turning it clockwise.

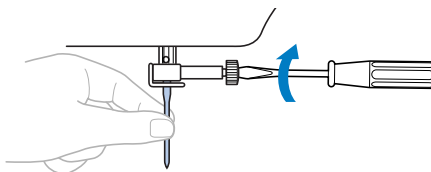

Install the twin needle in the same way.

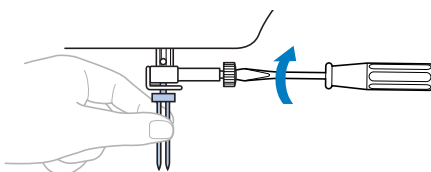

**CAUTION**

- Be sure to insert the needle until it touches the needle stopper and securely tighten the needle clamp screw with the screwdriver, otherwise the needle may break or damage may result.

## Sewing with a twin needle

We have designed your machine so you can sew with this needle and two top threads. You can use the same color or two different colors of thread for making decorative stitches.

For details on the stitches that can be sewn with the twin needle, refer to “STITCH SETTINGS” (page 35).

### CAUTION

- Use only twin needles that have been made for this machine (part code: 131096-121). Other needles could break, and damage the machine.
- Do not sew with bent needles. The needle could break and injure you.
- You can not use the needle threader to thread the twin needle. Instead, thread the twin needle by hand, from front to back. Using the needle threader may damage the machine.
- When using the twin needle, be sure to select an appropriate stitch, otherwise the needle may break or the machine may be damaged.
- Select a stitch width of 5.0 mm (3/16 inch) or less, otherwise the needle may break or the machine may be damaged.
- After adjusting the stitch width, slowly turn the handwheel toward you (counterclockwise) and check that the needle does not touch the presser foot. If the needle hits the presser foot, the needle may bend or break.
- When using the twin needle, be sure to attach zigzag foot “J”, otherwise the needle may break or the machine may be damaged.
- When changing the sewing direction, be sure to raise the needle before turning the fabric. If the fabric is turned while the needle is lowered, the needle may bend or break.

### ■ Twin needle threading

- 1 Attach the twin needle.**  
Attach the twin needle in the same way as a single needle (page 22).
- 2 Attach the extra spool pin.**  
Put the extra spool pin in the hole on the top of the machine. Put the second spool of thread onto the extra spool pin.

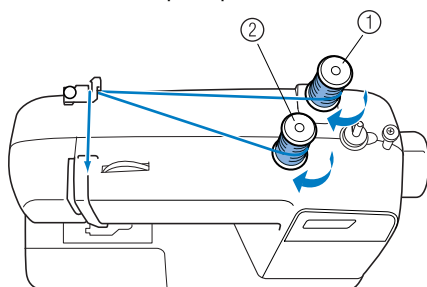

- ① First spool
- ② Second spool

- 3 Use the thread from the first spool to thread the machine to the needle bar thread guide.**  
The path for threading the machine to the needle bar thread guide is the same as for normally threading the machine (for a single needle). See page 18 for more details.
- 4 Thread the left needle from front to back.**
- 5 Use the thread from the second spool to thread the machine to the thread take-up lever.**  
The path for threading the machine to the thread take-up lever is the same as for normally threading the machine (for a single needle). See page 18 for more details.

- 6 Thread the right needle from front to back.**  
Do not pass the thread behind the needle bar thread guide.

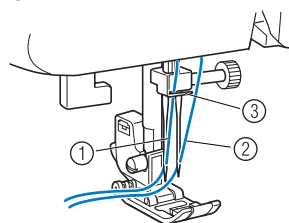

- ① Left needle thread passes through the needle bar thread guide.
- ② Right needle thread passes in front of the needle bar thread guide.
- ③ Needle bar thread guide



### Note

(For models equipped with a needle threader)

- You cannot use the needle threader to thread the twin needle. Instead, thread the twin needle by hand, from front to back. Using the needle threader may damage the machine.

### CAUTION

- When using the twin needle, be sure to attach zigzag foot “J”, otherwise the needle may break or the machine may be damaged.

# REPLACING THE PRESSER FOOT



1

## CAUTION

- Always turn off the power before you change the presser foot. If you leave the power on and step on the controller, the machine will start and you may be injured.
- Always use the correct presser foot for the stitch pattern you have chosen. If you use the wrong presser foot, the needle may strike the presser foot and bend or break, and may cause injury.
- Only use presser feet that have been designed to be used with this machine. Using other any presser feet may cause an accident or injury.

## Replacing the presser foot

Replace the presser foot as described below.

- 1** Raise the needle by turning the handwheel toward you (counterclockwise) so that the mark on the wheel points up. (With models equipped with  (needle position button), raise the needle by pressing  once or twice.)

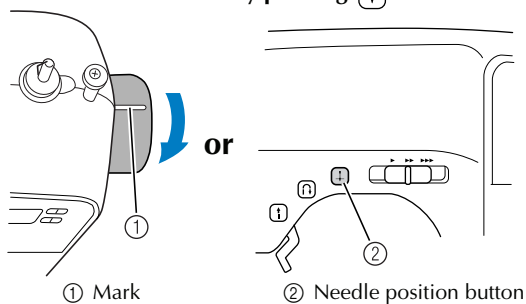

- 2** If the sewing machine has been turned on, turn it off.

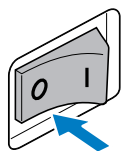

## CAUTION

- Before replacing the presser foot, be sure to turn off the sewing machine, otherwise injuries may occur if the foot controller or the start/stop button is accidentally pressed and the machine starts sewing.

- 3** Raise the presser foot lever.

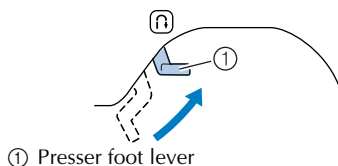

- 4** Press the black button at the back of the presser foot holder to release the presser foot.

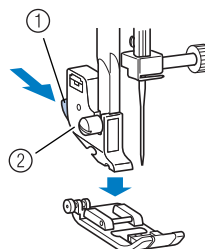

- ① Black button  
② Presser foot holder

- 5** Place a different presser foot below the holder so that the presser foot pin is aligned with the shank in the holder.

Position the presser foot so the letter indicating the presser foot type (J, A, etc.) is positioned to be read.

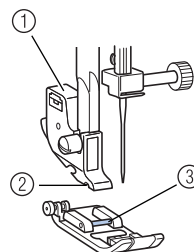

- ① Presser foot holder  
② Shank  
③ Pin



### Note

- The presser foot to be used with each stitch appears in the LCD. To select a stitch, refer to "Selecting a stitch" (page 28).

- 6** Slowly lower the presser foot lever so that the presser foot pin snaps into the shank in the presser foot holder.

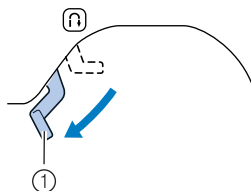

- ① Presser foot lever  
▶ The presser foot is attached.

- 7** Raise the presser foot lever to check that the presser foot is securely attached.

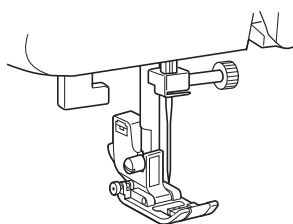

## Removing the presser foot holder

Remove the presser foot holder when cleaning the sewing machine or when installing a presser foot that does not use the presser foot holder, such as the quilting foot. Use the screwdriver to remove the presser foot holder.

### ■ Removing the presser foot holder

- 1** Remove the presser foot.
- For details, refer to “Replacing the presser foot” (page 25).
- 2** Use the screwdriver to loosen the presser foot holder screw.

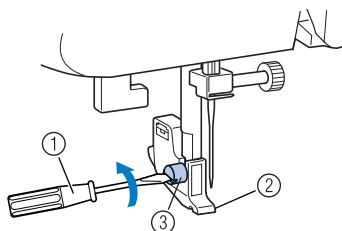

- ① Screwdriver  
② Presser foot holder  
③ Presser foot holder screw

### ■ Attaching the presser foot holder

- 1** Align the presser foot holder with the lower-left side of the presser bar.

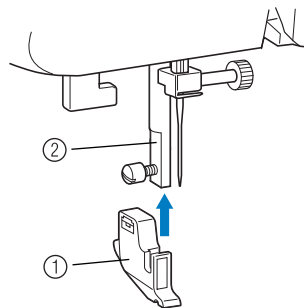

- ① Presser foot holder  
② Presser bar

- 2** Hold the presser foot holder in place with your right hand, and then tighten the screw using the screwdriver in your left hand.

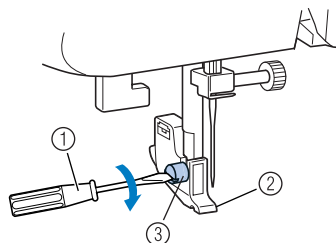

- ① Screwdriver  
② Presser foot holder  
③ Presser foot holder screw



### Note

- If the presser foot holder is not correctly installed, the thread tension will be incorrect.

## 2 SEWING BASICS

### SEWING

Basic sewing operations are described below.

Before operating the sewing machine, read the following precautions.

#### CAUTION

- While the machine is in operation, pay special attention to the needle location. In addition, keep your hands away from all moving parts such as the needle and handwheel, otherwise injuries may occur.
- Do not pull or push the fabric too hard while sewing, otherwise injuries may occur or the needle may break.
- Never use bent needles. Bent needles can easily break, possibly resulting in injuries.
- Make sure that the needle does not strike basting pins, otherwise the needle may break or bend.

### General sewing procedure

Follow the basic procedures below to sew.

**1 Turn on the machine.**

Turn on the sewing machine.  
For details on turning on the machine, refer to "Turning on the machine" (page 9).



**2 Select the stitch.**

Select the stitch appropriate for the area to be sewn.  
For details on selecting a stitch, refer to "Selecting a stitch" (page 28).



**3 Attach the presser foot.**

Attach the presser foot appropriate for the stitch.  
For details on replacing the presser foot, refer to "Replacing the presser foot" (page 25).



**4 Start sewing.**

Position the fabric, and then start sewing. When sewing is finished, cut the threads.  
For details on starting to sew, refer to "Starting to sew" (page 29).

## Selecting a stitch

Using the stitch selection keys, select the desired stitch.

When the sewing machine is turned on, the straight stitch (left needle position) is selected.

### ■ [Example] Selecting stitch (No. 04)

#### 1 Turn on the sewing machine.

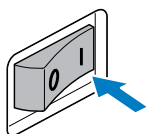

#### 2 (For models equipped with the character stitch key) Confirm that the utility stitch indicator is lit. If it is not lit, press the utility stitch key.

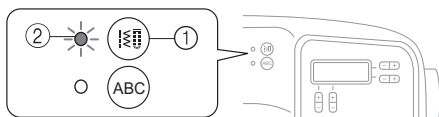

- ① Utility stitch key
- ② Utility stitch indicator

#### 3 Press (stitch selection keys) to select pattern No. 04.

Press the "+" or "-" side of  to increase or reduce the number.

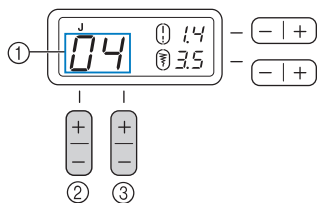

- ① Pattern No. of the selected stitch
- ② Changes the digit on the left.
- ③ Changes the digit on the right.

▶ The stitch is selected.



### Memo

- The mark  appears on the LCD when a stitch that is programmed with the automatic reinforcement stitching setting is selected.

#### 4 Attach the presser foot indicated on the LCD.



- ① The presser foot to use

- For details, refer to "Replacing the presser foot" (page 25).

#### 5 If necessary, press the "+" or "-" side of (stitch length adjustment key) to increase or reduce the stitch length.

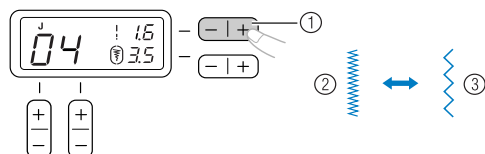

- ① Stitch length adjustment key
- ② Short
- ③ Long



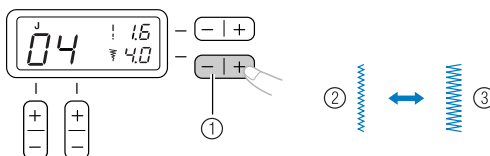



#### 6 If necessary, press the "+" or "-" side of (stitch width adjustment key) to increase or reduce the stitch width.



- ① Stitch width adjustment key
- ② Narrow
- ③ Wide



### Note

- When the stitch length or stitch width is changed from the auto setting, the  around the  or  disappears from the LCD. When the stitch length or stitch width is reset back to the auto setting, the  reappears around  or  on the LCD.
- If the stitch width of the selected stitch cannot be adjusted, "--" appears to the right of the  on the LCD.

## 7 When you have finished making adjustments, start sewing.

- For details, refer to “Starting to sew” (page 29).





### Memo

- For details on selecting character stitches, refer to “Selecting characters” (page 64).

## CAUTION

- After adjusting the stitch width, slowly turn the handwheel toward you (counterclockwise) and check that the needle does not touch the presser foot. If the needle hits the presser foot, the needle may bend or break.
- If the stitches are bunched together, increase the stitch length. Continuing to sew with the stitches bunched together may cause the needle to bend or break.

## Starting to sew

- 1 Raise the needle by turning the handwheel toward you (counterclockwise) so that the mark on the wheel points up. (With models equipped with , raise the needle by pressing  once or twice.)

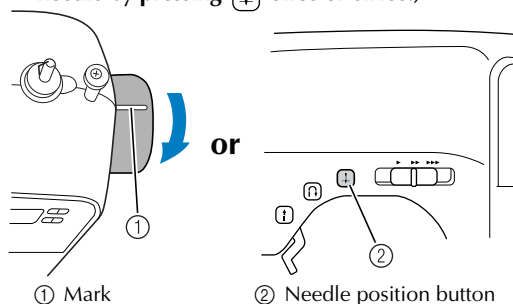

- 2 Raise the presser foot lever.

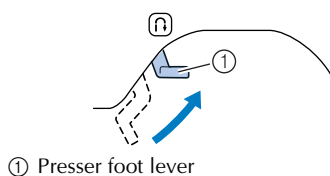

- 3 Place the fabric under the presser foot, pass the thread under the presser foot, and then pull out about 5 cm (2 inch) of thread toward the rear of the machine.

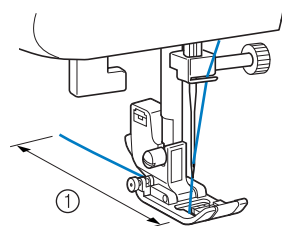

- 4 While holding the end of the thread and the fabric with your left hand, turn the handwheel toward you (counterclockwise) with your right hand to lower the needle to the starting point of the stitching.

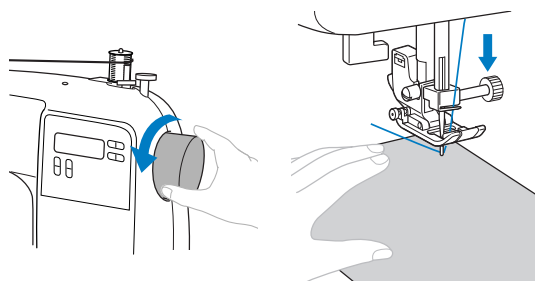

- 5** Lower the presser foot lever.

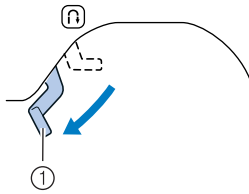

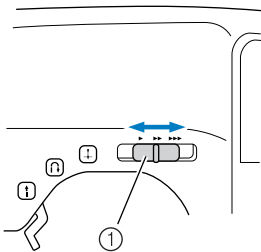

① Presser foot lever

- 6** On models equipped with a sewing speed controller, slide the sewing speed controller to the left or right to adjust the sewing speed. Refer to “Sewing speed controller (for models equipped with the sewing speed controller)” (page 10).



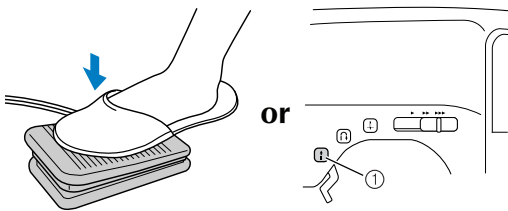

① Sewing speed controller

- 7** Slowly press down on the foot controller. (With models equipped with  (start/stop button), if the foot controller is not connected, press  once.)





① Start/stop button

▶ The machine starts sewing.

- 8** Take your foot off the foot controller, or press  (start/stop button) once (if the machine was started by pressing  (start/stop button)) (for models equipped with the start/stop button).

▶ The machine stops sewing.

- 9** Raise the needle by turning the handwheel toward you (counterclockwise) so that the mark on the wheel points up. (With models equipped with  (needle position button), raise the needle by pressing  once or twice.)

- 10** Raise the presser foot lever.

- 11** Pull the fabric to the left side of the machine, and then pass the threads through the thread cutter to cut them.

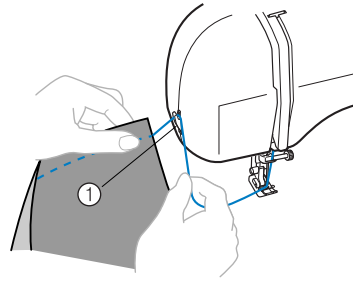

① Thread cutter

### Memo

- When the foot controller is plugged in,  (start/stop button) cannot be used to start sewing.
- When sewing is stopped, the needle remains lowered (in the fabric). The machine can be set so that the needle will stay up when sewing is stopped. For details on setting the machine so that the needles stay up when sewing is stopped, refer to “Changing the needle stop position” (page 10).

### ■ Sewing reinforcement stitches

When sewing stitches other than straight or zigzag stitches that are secured with reverse stitching, pressing  (reverse/reinforcement stitch button) sews reinforcement stitches, 3 to 5 stitches on top of each other.

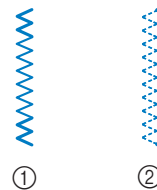

①

②

- ① Reverse stitching
- ② Reinforcement stitching

### Memo

- Whether reverse stitches or reinforcement stitches are sewn depends on the stitch that is selected. For details, refer to “STITCH SETTINGS” (page 35).



## Adjusting thread tension

The thread tension will affect the quality of your stitches. You may need to adjust it when you change fabric or thread.



### Memo

- We recommend that you do a test sample on scrap of a fabric before you start to sew.

### ■ Correct tension

Correct tension is important as too much or too little tension will weaken your seams or cause puckers on your fabric.

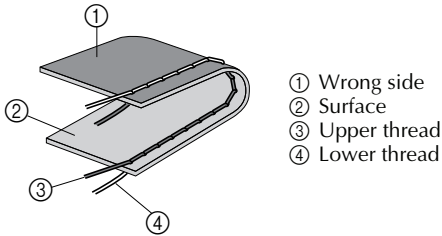

### ■ Upper tension is too tight

Loops will appear on the surface of the fabric.



### Note

- If the bobbin thread was incorrectly threaded, the upper thread may be too tight. In this case, refer to “Lower threading” (page 15) and rethread the bobbin thread.

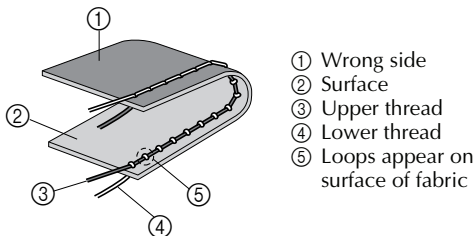

### Solution

Reduce the tension by turning the upper tension-control dial to a lower number.

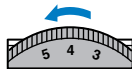

### Memo

- When you finish sewing, remove the bobbin cover and then make sure that the thread is shown as below. If the thread is not shown as below, the thread is not inserted through the tension-adjusting spring of the bobbin case correctly. Reinsert the thread correctly. For details, refer to page 15, 16.

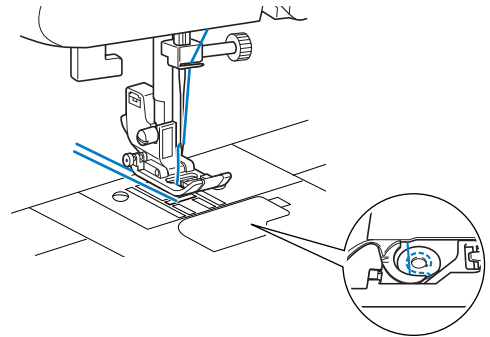

### ■ Upper tension is too loose

Loops appear on the wrong side of the fabric.



### Note

- If the upper thread was incorrectly threaded, the upper thread may be too loose. In this case, refer to “Upper threading” (page 17) and rethread the upper thread.

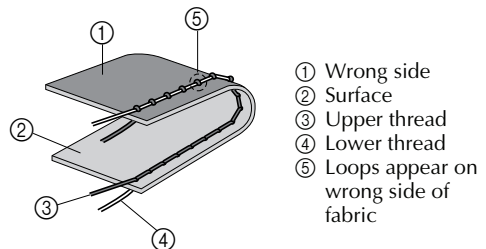

### Solution

Increase the tension by turning the upper tension-control dial to a higher number.

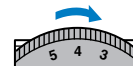

## USEFUL SEWING TIPS

Various ways to achieve better results for your sewing projects are described below. Refer to these tips when sewing your project.

### Trial sewing

After you select a stitch, the machine automatically sets the stitch width and length for the stitch that is selected.

However, a trial piece of fabric should be sewn since, depending on the type of fabric and stitching being sewn, the desired results may not be achieved.

For the trial sewing, use a piece of fabric and thread that are the same as those used for your project, and check the thread tension and stitch length and width. Since the results differ depending on the type of stitching and the number of layers of fabric sewn, perform the trial sewing under the same conditions that will be used with your project.

### Changing the sewing direction

#### 1 When the stitching reaches a corner, stop the sewing machine.

Leave the needle lowered (in the fabric). If the needle was raised, lower the needle either by turning the handwheel toward you (counterclockwise) or by pressing  $\oplus$  (needle position button) once (for models equipped with the needle position button).

#### CAUTION

- When using the twin needle, be sure to raise the needle before changing the sewing direction. If the fabric is turned while the needle is lowered, the needle may bend or break.

#### 2 Raise the presser foot lever, and then turn the fabric.

Turn the fabric using the needle as a pivot.

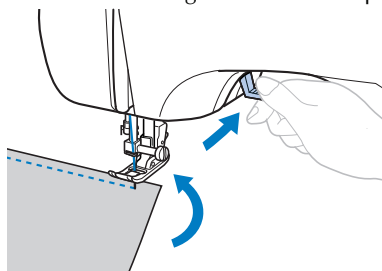

#### 3 Lower the presser foot lever and continue sewing.

### Sewing curves

Stop sewing, and then slightly change the sewing direction to sew around the curve.

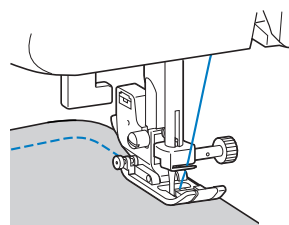

When sewing along a curve while using a zigzag stitch, select a shorter stitch length in order to obtain a finer stitch.

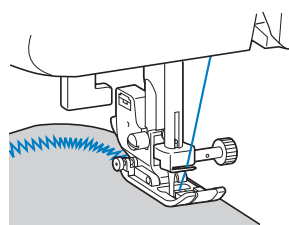

### Sewing thick fabrics

- If the fabric does not fit under the presser foot. If the fabric does not fit easily under the presser foot, raise the presser foot lever even higher to bring the presser foot to its highest position.

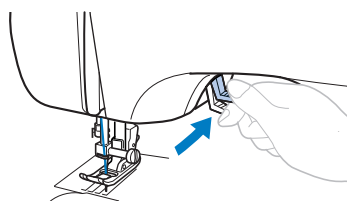

- If thick seams are being sewn and the fabric does not feed at the beginning of stitching Zigzag foot “J” is equipped with a feature that keeps the presser foot level.

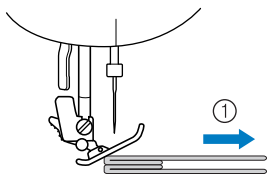

① Sewing direction

- 1 When you encounter a seam that is too thick to feed under the foot, raise the presser foot lever.
- 2 Press the black button on the left side of the foot. Keep the button held in and lower the presser foot.

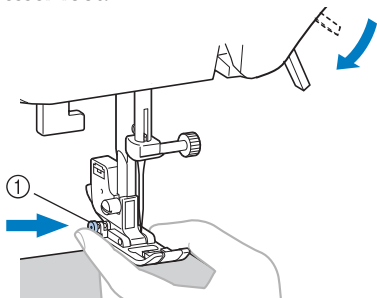

① Black button

- 3 Release the button. The foot will lock in place level with the seam, allowing the fabric to feed.

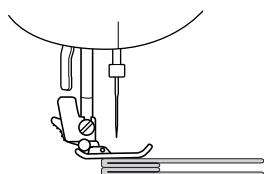

- Once the trouble spot has been passed, the foot will return to its normal position.

### CAUTION

- If fabric more than 6 mm (15/64 inch) thick is sewn or if the fabric is pushed with too much force, the needle may bend or break.

## Sewing hook-and-loop fastener

### CAUTION

- Use only the unglummed hook-and-loop fastener which is for sewing. If the glue is attached to the needle or the bobbin hook race, it may cause malfunction.
- If the hook-and-loop fastener is sewn with the thin needle (65/9-75/11), the needle may bend or break.

### Note

- Before start sewing, baste together the fabric and the hook-and-loop fastener.

Make sure that the needle passes through the hook-and-loop fastener by turning the handwheel and lower the needle into the hook-and-loop fastener before sewing. And then, sew the edge of the hook-and-loop fastener at a slow speed. If the needle does not pass through the hook-and-loop fastener, replace the needle with the needle for thick fabrics (page 21).

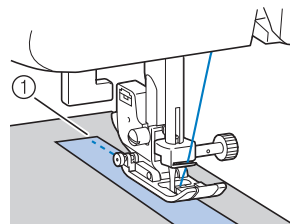

① Edge of the hook-and-loop fastener

## Sewing thin fabrics

When sewing thin fabrics, the stitching may become misaligned or the fabric may not feed correctly. If this occurs, place thin paper or stabilizer material under the fabric and sew it together with the fabric. When you have finished sewing, tear off any excess paper.

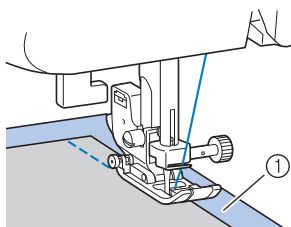

① Stabilizer material or paper

## Sewing stretch fabrics

First, baste the pieces of fabric together, and then sew without stretching the fabric.

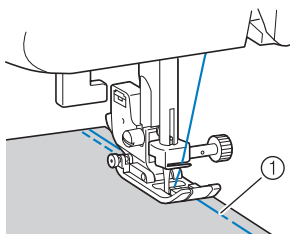

① Basting

## Using a free-arm style

Free-arm sewing is convenient for sewing tubular and hard-to-reach areas. To change your machine to the free-arm style, lift out the flat bed attachment.

- 1 Slide the flat bed attachment to the left to release it.

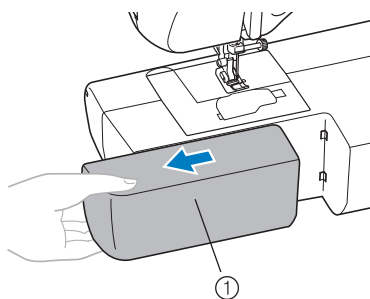

① Flat bed attachment

# 3 VARIOUS STITCHES

## STITCH SETTINGS

Applications, stitch lengths and widths and whether the twin needle can be used are listed for stitches in the following table.

**⚠ CAUTION**

- Select a stitch width of 5.0 mm (3/16 inch) or less, otherwise the needle may break or the machine may be damaged.
- When using the twin needle, be sure to attach zigzag foot “J”, otherwise the needle may break or the machine may be damaged.





















### Utility stitches

















Stitch Name	Pattern	Presser Foot	Pattern No.								Application	Stitch Width [mm (inch.)]	Stitch Length [mm (inch.)]	Twin Needle	Walking Foot	Reverse (Rev.)/ Reinforcement (Rfc.) Stitching		
			100 stitches model	90 stitches model	80 stitches model	70 stitches model	60 stitches model	50 stitches model	40 stitches model	Auto Manual		Auto Manual						
Straight	Left		J	00	00	00	00	00	00	00	00	00	00	0.0 (0) 0.0–7.0 (0–1/4)	2.5 (3/32) 0.2–5.0 (1/64–3/16)	** Yes (J)	Yes*	Rev.
	Center		J	01	01	01	01	01	01	01	01	01	01	3.5 (1/8) 0.0–7.0 (0–1/4)	2.5 (3/32) 0.2–5.0 (1/64–3/16)	** Yes (J)	Yes*	Rev.
Triple stretch stitch		J	J	02	02	02	02	02	02	02	02	02	0.0 (0) 0.0–7.0 (0–1/4)	2.5 (3/32) 1.5–4.0 (1/16–3/16)	** Yes (J)	No	Rfc.	
Stretch stitch		J	J	03	03	03	03	03	03	03	03	03	1.0 (1/16) 1.0–3.0 (1/16–1/8)	2.5 (3/32) 1.0–4.0 (1/16–3/16)	Yes (J)	No	Rfc.	
Zigzag stitch		J	J	04	04	04	04	04	04	04	04	04	3.5 (1/8) 0.0–7.0 (0–1/4)	1.4 (1/16) 0.0–4.0 (0–3/16)	** Yes (J)	Yes*	Rev.	
3-point zig-zag stitch		J	J	05	05	05	05	05	05	05	05	05	5.0 (3/16) 1.5–7.0 (1/16–1/4)	1.0 (1/16) 0.2–4.0 (1/64–3/16)	** Yes (J)	No	Rfc.	
Overcasting stitch		G	G	06	06	06	06	06	06	06	06	06	3.5 (1/8) 2.5–5.0 (3/32–3/16)	2.0 (1/16) 1.0–4.0 (1/16–3/16)	No	No	Rfc.	
		G	G	07	07	07	07	07	07	07	07	07	5.0 (3/16) 2.5–5.0 (3/32–3/16)	2.5 (3/32) 1.0–4.0 (1/16–3/16)	No	No	Rfc.	
		J	J	08	08	08	08	08	08	08	08	08	5.0 (3/16) 0.0–7.0 (0–1/4)	2.5 (3/32) 0.5–4.0 (1/32–3/16)	** Yes (J)	No	Rfc.	
		J	J	09	09	09	-	-	-	-	-	-	5.0 (3/16) 0.0–7.0 (0–1/4)	2.5 (3/32) 0.5–4.0 (1/32–3/16)	** Yes (J)	No	Rfc.	

\*Do not use reverse stitching.



















\*\*Select a stitch width of 5.0 mm (3/16 inch) or less.

Stitch Name	Pattern	Presser Foot	Pattern No.						Application	Stitch Width [mm (inch.)]	Stitch Length [mm (inch.)]	Twin Needle	Walking Foot	Reverse (Rev./ Reinforcement (Rfc.) Stitching	
			100 stitches model	90 stitches model	80 stitches model	70 stitches model	60 stitches model	50 stitches model		40 stitches model	Auto Manual				Auto Manual
Blind hem stitch		R	10	10	10	09	09	09	09	Blind hem stitching on medium weight fabrics	<b>0 (0)</b> -3 ← → 3	<b>2.0 (1/16)</b> 1.0-3.5 (1/16-1/8)	No	No	Rfc.
		R	11	11	11	10	10	10	10	Blind hem stitching on stretch fabrics	<b>0 (0)</b> -3 ← → 3	<b>2.0 (1/16)</b> 1.0-3.5 (1/16-1/8)	No	No	Rfc.
Appliqué stitch		J	12	12	12	11	11	11	11	Appliqué stitching	<b>3.5 (1/8)</b> 2.5-7.0 (3/32-1/4)	<b>2.5 (3/32)</b> 1.6-4.0 (1/16-3/16)	Yes** (J)	No	Rfc.
Shell tuck stitch		J	13	13	13	12	12	12	12	Shell tuck stitching	<b>4.0 (3/16)</b> 0.0-7.0 (0-1/4)	<b>2.5 (3/32)</b> 0.2-4.0 (1/64-3/16)	Yes** (J)	No	Rfc.
Satin scallop stitch		N	14	14	14	13	13	13	13	Scallop stitching	<b>5.0 (3/16)</b> 2.5-7.0 (3/32-1/4)	<b>0.5 (1/32)</b> 0.1-1.0 (1/64-1/16)	Yes** (J)	No	Rfc.
Joining stitch		J	15	15	15	14	14	14	14	Patchwork stitching and decorative stitching	<b>4.0 (3/16)</b> 0.0-7.0 (0-1/4)	<b>1.2 (1/16)</b> 0.2-4.0 (1/64-3/16)	Yes** (J)	No	Rfc.
		J	16	16	16	15	15	15	15	Patchwork stitching, decorative stitching and sewing overcasting on both pieces of fabrics, such as with tricot	<b>5.0 (3/16)</b> 2.5-7.0 (3/32-1/4)	<b>2.5 (3/32)</b> 1.0-4.0 (1/16-3/16)	Yes** (J)	No	Rfc.
		J	17	17	17	16	16	16	16	Patchwork stitching and decorative stitching	<b>5.0 (3/16)</b> 0.0-7.0 (0-1/4)	<b>1.2 (1/16)</b> 0.2-4.0 (1/64-3/16)	Yes** (J)	No	Rfc.
Smocking stitch		J	18	18	18	-	-	-	-	Smocking stitching and decorative stitching	<b>5.0 (3/16)</b> 0.0-7.0 (0-1/4)	<b>1.6 (1/16)</b> 1.0-4.0 (1/16-3/16)	Yes** (J)	No	Rfc.
Fagoting stitch		J	19	19	19	17	17	17	17	Fagoting, smocking and decorative stitching	<b>5.0 (3/16)</b> 0.0-7.0 (0-1/4)	<b>2.5 (3/32)</b> 1.0-4.0 (1/16-3/16)	Yes** (J)	No	Rfc.
		J	20	20	20	18	18	18	18	Fagoting, smocking and decorative stitching	<b>5.0 (3/16)</b> 2.5-7.0 (3/32-1/4)	<b>2.5 (3/32)</b> 1.0-4.0 (1/16-3/16)	Yes** (J)	No	Rfc.
Elastic- attaching stitch		J	21	21	21	-	-	-	-	Attaching elastic to stretch fabrics	<b>4.0 (3/16)</b> 0.0-7.0 (0-1/4)	<b>1.0 (1/16)</b> 0.2-4.0 (1/64-3/16)	Yes** (J)	No	Rfc.
Decorative stitch		J	22	22	22	19	19	19	19	Decorative stitching	<b>4.0 (3/16)</b> 0.0-7.0 (0-1/4)	<b>3.0 (1/8)</b> 2.0-4.0 (1/16-3/16)	No	No	Rfc.
		J	23	23	23	20	20	20	20	Decorative stitching	<b>4.0 (3/16)</b> 0.0-7.0 (0-1/4)	<b>2.5 (3/32)</b> 1.0-4.0 (1/16-3/16)	Yes** (J)	No	Rfc.
		J	24	24	24	21	21	21	-	Decorative stitching	<b>5.5 (7/32)</b> 0.0-7.0 (0-1/4)	<b>1.6 (1/16)</b> 1.0-4.0 (1/16-3/16)	Yes** (J)	No	Rfc.
		N	25	25	25	22	22	22	21	Decorative stitching and elastic-attaching	<b>5.0 (3/16)</b> 1.5-7.0 (1/64-1/4)	<b>1.0 (1/16)</b> 0.2-4.0 (1/64-3/16)	Yes** (J)	No	Rfc.
		N	26	26	26	23	23	23	22	Lace sewing, decorative hemming, heirloom stitching, etc.	<b>3.5 (1/8)</b> 1.5-7.0 (1/16-1/4)	<b>2.5 (3/32)</b> 1.6-4.0 (1/16-3/16)	No	No	Rfc.
		N	27	27	27	24	24	24	23	Decorative hemming, heirloom stitching, etc.	<b>6.0 (15/64)</b> 1.5-7.0 (1/16-1/4)	<b>3.0 (1/8)</b> 1.5-4.0 (1/16-3/16)	No	No	Rfc.

\*\*Select a stitch width of 5.0 mm (3/16 inch) or less.

Stitch Name	Pattern	Presser Foot	Pattern No.							Application	Stitch Width [mm (inch.)]	Stitch Length [mm (inch.)]	Twin Needle	Walking Foot	Reverse (Rev./ Reinforcement (Rfc.) Stitching
			100 stitches model	90 stitches model	80 stitches model	70 stitches model	60 stitches model	50 stitches model	40 stitches model		Auto Manual	Auto Manual			
Decorative stitch		N	28	28	28	25	25	25	-	Decorative hemming on thin, medium weight and plain weave fabrics, heirloom stitching, etc.	<b>5.0 (3/16)</b> 1.5-7.0 (1/16-1/4)	<b>3.5 (1/8)</b> 1.5-4.0 (1/16-3/16)	No	No	Rfc.
		N	29	29	29	26	26	26	24	Decorative hemming on thin, medium weight and plain weave fabrics, heirloom stitching, etc.	<b>5.0 (3/16)</b> 1.5-7.0 (1/16-1/4)	<b>4.0 (3/16)</b> 1.5-4.0 (1/16-3/16)	No	No	Rfc.
		N	30	30	30	27	27	27	-	Decorative hemming on thin, medium weight and plain weave fabrics, heirloom stitching, etc.	<b>5.0 (3/16)</b> 1.5-7.0 (1/16-1/4)	<b>2.5 (3/32)</b> 1.5-4.0 (1/16-3/16)	No	No	Rfc.
		N	31	31	31	28	28	28	-	Decorative hemming on thin, medium weight and plain weave fabrics, heirloom stitching, etc.	<b>5.0 (3/16)</b> 1.5-7.0 (1/16-1/4)	<b>2.0 (1/16)</b> 1.5-4.0 (1/16-3/16)	No	No	Rfc.
		N	32	32	32	-	-	-	-	Decorative stitching, smocking stitching, heirloom stitching, etc.	<b>6.0 (15/64)</b> 1.5-7.0 (1/16-1/4)	<b>1.6 (1/16)</b> 1.0-4.0 (1/16-3/16)	No	No	Rfc.
		N	33	33	33	-	-	-	-	Decorative stitching, smocking stitching, heirloom stitching, etc.	<b>5.0 (3/16)</b> 1.5-7.0 (1/16-1/4)	<b>1.6 (1/16)</b> 1.0-4.0 (1/16-3/16)	No	No	Rfc.
Buttonhole stitch		A	34	34	34	29	29	29	25	Horizontal buttonholes on thin and medium weight fabrics	<b>5.0 (3/16)</b> 3.0-5.0 (1/8-3/16)	<b>0.5 (1/32)</b> 0.2-1.0 (1/64-1/16)	No	No	*** Auto Rfc.
		A	35	35	35	30	30	30	26	Secured buttonholes for fabrics that have backings	<b>5.0 (3/16)</b> 3.0-5.0 (1/8-3/16)	<b>0.5 (1/32)</b> 0.2-1.0 (1/64-1/16)	No	No	*** Auto Rfc.
		A	36	36	36	31	31	31	27	Buttonholes for stretch or knit fabrics	<b>6.0 (15/64)</b> 3.0-6.0 (1/8-15/64)	<b>1.0 (1/16)</b> 0.5-2.0 (1/32-1/16)	No	No	*** Auto Rfc.
		A	37	37	37	32	32	32	28	Buttonholes for stretch fabrics	<b>6.0 (15/64)</b> 3.0-6.0 (1/8-15/64)	<b>1.5 (1/16)</b> 1.0-3.0 (1/16-1/8)	No	No	*** Auto Rfc.
		A	38	38	38	-	-	-	-	Bound buttonholes	<b>5.0 (3/16)</b> 0.0-6.0 (0-15/64)	<b>2.0 (1/16)</b> 0.2-4.0 (1/64-3/16)	No	No	*** Auto Rfc.
		A	39	39	39	33	33	33	29	Keyhole buttonholes for thick or furry fabrics	<b>7.0 (1/4)</b> 3.0-7.0 (1/8-1/4)	<b>0.5 (1/32)</b> 0.3-1.0 (1/64-1/16)	No	No	*** Auto Rfc.
		A	40	40	40	34	34	-	-	Keyhole buttonholes for medium weight and thick fabrics	<b>7.0 (1/4)</b> 3.0-7.0 (1/8-1/4)	<b>0.5 (1/32)</b> 0.3-1.0 (1/64-1/16)	No	No	*** Auto Rfc.
		A	41	41	41	35	35	-	-	Keyhole buttonholes for thick or furry fabrics	<b>7.0 (1/4)</b> 3.0-7.0 (1/8-1/4)	<b>0.5 (1/32)</b> 0.3-1.0 (1/64-1/16)	No	No	*** Auto Rfc.
Bar tack stitch		A	42	42	42	36	36	34	30	Reinforcing openings and areas where the seam easily comes loose	<b>2.0 (1/16)</b> 1.0-3.0 (1/16-1/8)	<b>0.4 (1/64)</b> 0.3-1.0 (1/64-1/16)	No	No	*** Auto Rfc.
Piecing straight stitch		J	43	43	43	37	37	-	-	Piecing straight stitching (with a seam allowance of 6.5mm from the right edge of the presser foot)	<b>5.5 (7/32)</b> 0.0-7.0 (0-1/4)	<b>2.0 (1/16)</b> 0.2-5.0 (1/64-3/16)	No	Yes	Rfc.
		J	44	44	44	38	38	-	-	Piecing straight stitching (with a seam allowance of 6.5mm from the left edge of the presser foot)	<b>1.5 (1/16)</b> 0.0-7.0 (0-1/4)	<b>2.0 (1/16)</b> 0.2-5.0 (1/64-3/16)	No	Yes	Rfc.













\*\*\*Auto Ric.:Automatic Reinforcement

Stitch Name	Pattern	Presser Foot	Pattern No.						Application	Stitch Width [mm (inch.)]	Stitch Length [mm (inch.)]	Twin Needle	Walking Foot	Reverse (Rev./ Reinforcement (Rfc.) Stitching)	
			100 stitches model	90 stitches model	80 stitches model	70 stitches model	60 stitches model	50 stitches model		40 stitches model	Auto Manual				Auto Manual
Hand-look quilting		J	45	45	45	39	39	35	31	Straight stitch quilting that looks hand-sewn	<b>0.0 (0)</b> 0.0–7.0 (0–1/4)	<b>2.5 (3/32)</b> 1.0–4.0 (1/16–3/16)	No	No	Rfc.
Zigzag stitch (for quilting)		J	46	46	46	40	40	-	-	Appliqué quilting, free-motion quilting, satin stitching, button sewing	<b>3.5 (1/8)</b> 0.0–7.0 (0–1/4)	<b>1.4 (1/16)</b> 0.0–4.0 (0–3/16)	No	Yes	Rfc.
Appliqué stitch (for quilting)		J	47	47	47	41	41	-	-	Attaching appliqués and binding	<b>1.5 (1/16)</b> 0.5–3.5 (1/32–1/8)	<b>1.8 (1/16)</b> 1.0–4.0 (1/16–3/16)	No	No	Rfc.
		J	48	48	48	42	42	-	-	Attaching appliqués and binding	<b>1.5 (1/16)</b> 0.5–3.5 (1/32–1/8)	<b>1.8 (1/16)</b> 1.0–4.0 (1/16–3/16)	No	No	Rfc.
Quilting stippling		J	49	49	49	43	43	-	-	Quilting background stitching (stippling)	<b>7.0 (1/4)</b> 1.0–7.0 (1/16–1/4)	<b>1.6 (1/16)</b> 1.0–4.0 (1/16–3/16)	No	No	Rfc.
Decorative stitch		N	50	50	50	-	-	-	-	For decoration, etc.	<b>3.0 (1/8)</b> 0.0–7.0 (0–1/4)	<b>1.0 (1/16)</b> 0.2–4.0 (1/64–3/16)	No	No	Rfc.
		N	51	-	-	-	-	-	-	For decoration, etc.	<b>5.0 (3/16)</b> 0.0–7.0 (0–1/4)	<b>2.0 (1/16)</b> 0.2–4.0 (1/64–3/16)	No	No	Rfc.
		N	52	-	-	-	-	-	-	For decoration, etc.	<b>4.0 (3/16)</b> 0.0–7.0 (0–1/4)	<b>1.6 (1/16)</b> 0.2–4.0 (1/64–3/16)	No	No	Rfc.
		N	53	51	-	-	-	-	-	For decoration, etc.	<b>5.0 (3/16)</b> 0.0–7.0 (0–1/4)	<b>2.5 (3/32)</b> 0.2–4.0 (1/64–3/16)	No	No	Rfc.
		N	54	52	51	-	-	-	-	For decoration, etc.	<b>7.0 (1/4)</b> 0.0–7.0 (0–1/4)	<b>2.5 (3/32)</b> 0.2–4.0 (1/64–3/16)	No	No	Rfc.
		N	55	53	52	44	44	36	32	For decoration, etc.	<b>7.0 (1/4)</b> 0.0–7.0 (0–1/4)	<b>2.5 (3/32)</b> 0.2–4.0 (1/64–3/16)	No	No	Rfc.
		N	56	54	-	-	-	-	-	For decoration, etc.	<b>7.0 (1/4)</b> 0.0–7.0 (0–1/4)	<b>1.4 (1/16)</b> 0.2–4.0 (1/64–3/16)	No	No	Rfc.
		N	57	55	-	-	-	-	-	For decoration, etc.	<b>7.0 (1/4)</b> 0.0–7.0 (0–1/4)	<b>2.5 (3/32)</b> 0.2–4.0 (1/64–3/16)	No	No	Rfc.
		N	58	-	-	-	-	-	-	For decoration, etc.	<b>7.0 (1/4)</b> 0.0–7.0 (0–1/4)	<b>1.6 (1/16)</b> 0.2–4.0 (1/64–3/16)	No	No	Rfc.
		N	59	56	53	45	45	37	33	For decoration, etc.	<b>7.0 (1/4)</b> 0.0–7.0 (0–1/4)	<b>2.0 (1/16)</b> 0.2–4.0 (1/64–3/16)	No	No	Rfc.
		N	60	57	54	46	46	38	-	For decoration, etc.	<b>7.0 (1/4)</b> 0.0–7.0 (0–1/4)	<b>2.5 (3/32)</b> 0.2–4.0 (1/64–3/16)	No	No	Rfc.
		N	61	-	-	-	-	-	-	For decoration, etc.	<b>7.0 (1/4)</b> 0.0–7.0 (0–1/4)	<b>2.5 (3/32)</b> 0.2–4.0 (1/64–3/16)	No	No	Rfc.
	N	62	58	-	-	-	-	-	For decoration, etc.	<b>7.0 (1/4)</b> 0.0–7.0 (0–1/4)	<b>2.0 (1/16)</b> 0.2–4.0 (1/64–3/16)	No	No	Rfc.	



Stitch Name	Pattern	Presser Foot	Pattern No.						Application	Stitch Width [mm (inch.)]	Stitch Length [mm (inch.)]	Twin Needle	Walking Foot	Reverse (Rev./ Reinforcement (Rfc.) Stitching	
			100 stitches model	90 stitches model	80 stitches model	70 stitches model	60 stitches model	50 stitches model		40 stitches model	Auto Manual				Auto Manual
Decorative stitch		N	63	59	55	47	-	-	-	For decoration, etc.	7.0 (1/4) 0.0-7.0 (0-1/4)	2.5 (3/32) 0.2-4.0 (1/64-3/16)	No	No	Rfc.
		N	64	60	-	-	-	-	-	For decoration, etc.	7.0 (1/4) 0.0-7.0 (0-1/4)	1.6 (1/16) 0.2-4.0 (1/64-3/16)	No	No	Rfc.
		N	65	61	56	48	47	39	-	For decoration, etc.	7.0 (1/4) 0.0-7.0 (0-1/4)	2.0 (1/16) 0.2-4.0 (1/64-3/16)	No	No	Rfc.
		N	66	62	57	49	48	40	-	For decoration, etc.	7.0 (1/4) 0.0-7.0 (0-1/4)	2.0 (1/16) 0.2-4.0 (1/64-3/16)	No	No	Rfc.
		N	67	63	58	50	-	-	-	For decoration, etc.	7.0 (1/4) 0.0-7.0 (0-1/4)	1.6 (1/16) 0.2-4.0 (1/64-3/16)	No	No	Rfc.
		N	68	64	59	51	49	41	34	For decoration, etc.	7.0 (1/4) 0.0-7.0 (0-1/4)	2.5 (3/32) 0.2-4.0 (1/64-3/16)	No	No	Rfc.
		N	69	65	60	52	-	-	-	For decoration, etc.	7.0 (1/4) 0.0-7.0 (0-1/4)	2.0 (1/16) 0.2-4.0 (1/64-3/16)	No	No	Rfc.
		N	70	66	61	53	-	-	-	For decoration, etc.	5.0 (3/16) 0.0-7.0 (0-1/4)	2.0 (1/16) 0.2-4.0 (1/64-3/16)	No	No	Rfc.
		N	71	-	-	-	-	-	-	For decoration, etc.	7.0 (1/4) 0.0-7.0 (0-1/4)	1.6 (1/16) 0.2-4.0 (1/64-3/16)	No	No	Rfc.
		N	72	67	62	-	-	-	-	For decoration, etc.	7.0 (1/4) 0.0-7.0 (0-1/4)	2.0 (1/16) 0.2-4.0 (1/64-3/16)	No	No	Rfc.
		N	73	68	-	-	-	-	-	For decoration, etc.	7.0 (1/4) 0.0-7.0 (0-1/4)	2.0 (1/16) 0.2-4.0 (1/64-3/16)	No	No	Rfc.
		N	74	69	63	54	-	-	-	For decoration, etc.	7.0 (1/4) 0.0-7.0 (0-1/4)	2.5 (3/32) 0.2-4.0 (1/64-3/16)	No	No	Rfc.
		N	75	70	64	55	50	-	-	For decoration, etc.	7.0 (1/4) 0.0-7.0 (0-1/4)	1.6 (1/16) 0.2-4.0 (1/64-3/16)	No	No	Rfc.
		N	76	71	65	56	51	-	-	For decoration, etc.	7.0 (1/4) 0.0-7.0 (0-1/4)	1.4 (1/16) 0.2-4.0 (1/64-3/16)	No	No	Rfc.
Satin stitches		N	77	72	66	-	-	-	-	For decoration, etc.	7.0 (1/4) 0.0-7.0 (0-1/4)	0.4 (1/64) 0.1-1.0 (1/64-1/16)	Yes** (J)	No	Rfc.
		N	78	73	67	58	-	-	-	For decoration, etc.	7.0 (1/4) 0.0-7.0 (0-1/4)	0.4 (1/64) 0.1-1.0 (1/64-1/16)	Yes** (J)	No	Rfc.
		N	79	74	-	-	-	-	-	For decoration, etc.	7.0 (1/4) 0.0-7.0 (0-1/4)	0.4 (1/64) 0.1-1.0 (1/64-1/16)	Yes** (J)	No	Rfc.

\*\*Select a stitch width of 5.0 mm (3/16 inch) or less.

Stitch Name	Pattern	Presser Foot	Pattern No.						Application	Stitch Width [mm (inch.)]		Stitch Length [mm (inch.)]		Twin Needle	Walking Foot	Reverse (Rev./Reinforcement (Rfc.) Stitching
			100 stitches model	90 stitches model	80 stitches model	70 stitches model	60 stitches model	50 stitches model		40 stitches model	Auto Manual	Auto Manual				
Satin stitches		N	80	75	68	59	53	43	35	For decoration, etc.	7.0 (1/4) 0.0-7.0 (0-1/4)	0.4 (1/64) 0.1-1.0 (1/64-1/16)	Yes** (J)	No	Rfc.	
		N	81	-	-	-	-	-	-	For decoration, etc.	7.0 (1/4) 0.0-7.0 (0-1/4)	0.4 (1/64) 0.1-1.0 (1/64-1/16)	Yes** (J)	No	Rfc.	
		N	82	76	69	60	54	44	36	For decoration, etc.	7.0 (1/4) 0.0-7.0 (0-1/4)	0.4 (1/64) 0.1-1.0 (1/64-1/16)	Yes** (J)	No	Rfc.	
		N	83	77	70	61	55	45	-	For decoration, etc.	7.0 (1/4) 0.0-7.0 (0-1/4)	0.4 (1/64) 0.1-1.0 (1/64-1/16)	Yes** (J)	No	Rfc.	
		N	84	78	71	62	56	46	37	For decoration, etc.	7.0 (1/4) 0.0-7.0 (0-1/4)	0.4 (1/64) 0.1-1.0 (1/64-1/16)	Yes** (J)	No	Rfc.	
		N	85	79	72	63	-	-	-	For decoration, etc.	7.0 (1/4) 0.0-7.0 (0-1/4)	0.4 (1/64) 0.1-1.0 (1/64-1/16)	Yes** (J)	No	Rfc.	
		N	86	80	73	64	-	-	-	For decoration, etc.	7.0 (1/4) 0.0-7.0 (0-1/4)	0.4 (1/64) 0.1-1.0 (1/64-1/16)	Yes** (J)	No	Rfc.	
		N	87	81	74	57	52	42	-	For decoration, etc.	7.0 (1/4) 0.0-7.0 (0-1/4)	0.4 (1/64) 0.1-1.0 (1/64-1/16)	Yes** (J)	No	Rfc.	
		N	88	82	-	-	-	-	-	For decoration, etc.	7.0 (1/4) 0.0-7.0 (0-1/4)	0.4 (1/64) 0.1-1.0 (1/64-1/16)	Yes** (J)	No	Rfc.	
		N	89	-	-	-	-	-	-	For decoration, etc.	7.0 (1/4) 0.0-7.0 (0-1/4)	0.4 (1/64) 0.1-1.0 (1/64-1/16)	Yes** (J)	No	Rfc.	
		N	90	-	-	-	-	-	-	For decoration, etc.	7.0 (1/4) 0.0-7.0 (0-1/4)	0.4 (1/64) 0.1-1.0 (1/64-1/16)	Yes** (J)	No	Rfc.	
		N	91	-	-	-	-	-	-	For decoration, etc.	7.0 (1/4) 0.0-7.0 (0-1/4)	0.4 (1/64) 0.1-1.0 (1/64-1/16)	Yes** (J)	No	Rfc.	
		N	92	-	-	-	-	-	-	For decoration, etc.	7.0 (1/4) 0.0-7.0 (0-1/4)	0.4 (1/64) 0.1-1.0 (1/64-1/16)	Yes** (J)	No	Rfc.	

\*\*Select a stitch width of 5.0 mm (3/16 inch) or less.

Stitch Name	Pattern	Presser Foot	Pattern No.							Application	Stitch Width [mm (inch.)]	Stitch Length [mm (inch.)]	Twin Needle	Walking Foot	Reverse (Rev.)/ Reinforcement (Rfc.) Stitching
			100 stitches model	90 stitches model	80 stitches model	70 stitches model	60 stitches model	50 stitches model	40 stitches model		Auto Manual	Auto Manual			
Cross- stitches		N	93	83	-	-	-	-	-	For decoration, etc.	<b>6.0 (15/64)</b> 0.0-7.0 (0-1/4)	<b>1.4 (1/16)</b> 0.2-4.0 (1/64-3/16)	No	No	Rfc.
		N	94	84	75	65	-	-	-	For decoration, etc.	<b>7.0 (1/4)</b> 0.0-7.0 (0-1/4)	<b>1.6 (1/16)</b> 0.2-4.0 (1/64-3/16)	No	No	Rfc.
		N	95	85	76	67	57	47	38	For decoration, etc.	<b>6.0 (15/64)</b> 0.0-7.0 (0-1/4)	<b>2.5 (3/32)</b> 0.2-4.0 (1/64-3/16)	No	No	Rfc.
		N	96	86	-	-	-	-	-	For decoration, etc.	<b>6.0 (15/64)</b> 0.0-7.0 (0-1/4)	<b>1.4 (1/16)</b> 0.2-4.0 (1/64-3/16)	No	No	Rfc.
		N	97	87	77	66	-	-	-	For decoration, etc.	<b>6.0 (15/64)</b> 0.0-7.0 (0-1/4)	<b>1.4 (1/16)</b> 0.2-4.0 (1/64-3/16)	No	No	Rfc.
		N	98	88	78	68	58	48	-	For decoration, etc.	<b>6.0 (15/64)</b> 0.0-7.0 (0-1/4)	<b>1.4 (1/16)</b> 0.2-4.0 (1/64-3/16)	No	No	Rfc.
		N	99	89	79	69	59	49	39	For decoration, etc.	<b>6.0 (15/64)</b> 0.0-7.0 (0-1/4)	<b>1.4 (1/16)</b> 0.2-4.0 (1/64-3/16)	No	No	Rfc.

### Character stitches (for models equipped with character stitches)

Stitch Type	Presser Foot	Pattern No.										Twin Needle	Stitch width/ Stitch Length
Character stitches	N	01	02	03	04	05	06	07	08	09	10	No	-
		A	B	C	D	E	F	G	H	I	J		
		11	12	13	14	15	16	17	18	19	20		
		K	L	M	N	O	P	Q	R	S	T		
		21	22	23	24	25	26	27	28	29	30		
		U	V	W	X	Y	Z	&	?	!	_		
31	32	33	34	35	36	37	38	39	40				
0	1	2	3	4	5	6	7	8	9				
41	42	43	44	45	46	47	48	49	50				
,	,	.	(	)	-	Ä	Å	Æ	Ñ				
51	52	53	54	55									
Ö	Ø	Ç	Ü	ß									

# OVERCASTING STITCHES

You can use the overcasting stitches to join together seams and finish them in one operation. They are also useful for sewing stretch materials.

Stitch Name	Pattern	Presser Foot	Pattern No.							Application	Stitch Width [mm (inch.)]	Stitch Length [mm (inch.)]	Twin Needle	Walking Foot	Reverse (Rev./Reinforcement (Rfc.) Stitching)
			100 stitches model	90 stitches model	80 stitches model	70 stitches model	60 stitches model	50 stitches model	40 stitches model		Auto Manual	Auto Manual			
Zigzag stitch		J	04	04	04	04	04	04	04	Overcasting and attaching appliques	3.5 (1/8) 0.0–7.0 (0–1/4)	1.4 (1/16) 0.0–4.0 (0–3/16)	** Yes (1)	*	Rev.
3-point zigzag stitch		J	05	05	05	05	05	05	05	Overcasting on medium weight or stretch fabrics, attaching elastic, darning, etc.	5.0 (3/16) 1.5–7.0 (1/16–1/4)	1.0 (1/16) 0.2–4.0 (1/64–3/16)	** Yes (1)	No	Rfc.
Overcasting stitch		G	06	06	06	06	06	06	06	Overcasting on thin or medium weight fabrics	3.5 (1/8) 2.5–5.0 (3/32–3/16)	2.0 (1/16) 1.0–4.0 (1/16–3/16)	No	No	Rfc.
		G	07	07	07	07	07	07	07	Overcasting on thick fabrics	5.0 (3/16) 2.5–5.0 (3/32–3/16)	2.5 (3/32) 1.0–4.0 (1/16–3/16)	No	No	Rfc.
		J	08	08	08	08	08	08	08	Overcasting on stretch fabrics	5.0 (3/16) 0.0–7.0 (0–1/4)	2.5 (3/32) 0.5–4.0 (1/32–3/16)	** Yes (1)	No	Rfc.
		J	09	09	09	-	-	-	-	Overcasting on thick or stretch fabrics	5.0 (3/16) 0.0–7.0 (0–1/4)	2.5 (3/32) 0.5–4.0 (1/32–3/16)	** Yes (1)	No	Rfc.

\*Do not use reverse stitching.

\*\*Select a stitch width of 5.0 mm (3/16 inch) or less.

**1** Attach overcasting foot “G” or zigzag foot “J”.

**2** Select a stitch.

- For details, refer to “Selecting a stitch” (page 28).

**3** Position the fabric with the edge of the fabric against the guide of the presser foot, and then lower the presser foot lever.

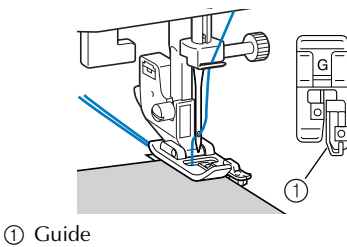

**4** Sew with the edge of the fabric against the presser foot guide.

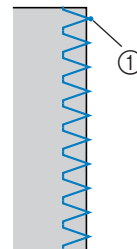

① Needle drop point

## CAUTION

- After adjusting the stitch width, slowly turn the handwheel toward you (counterclockwise) and check that the needle does not touch the presser foot. If the needle hits the presser foot, the needle may bend or break.

# BASIC STITCHING

Straight stitches are used for sewing plain seams. Three stitches are available for basic stitching.

Stitch Name	Pattern	Presser Foot	Pattern No.								Application	Stitch Width [mm (inch.)]	Stitch Length [mm (inch.)]	Twin Needle	Walking Foot	Reverse (Rev.)/ Reinforcement (Rfc.) Stitching	
			100 stitches model	90 stitches model	80 stitches model	70 stitches model	60 stitches model	50 stitches model	40 stitches model	Auto Manual		Auto Manual					
Straight	Left		J	00	00	00	00	00	00	00	00	Basic stitching, sewing gathers or pintucks, etc.	0.0 (0) 0.0–7.0 (0–1/4)	2.5 (3/32) 0.2–5.0 (1/64–3/16)	** Yes (J)	Yes*	Rev.
	Center		J	01	01	01	01	01	01	01	01	Attaching zippers, basic stitching, and sewing gathers or pintucks, etc.	3.5 (1/8) 0.0–7.0 (0–1/4)	2.5 (3/32) 0.2–5.0 (1/64–3/16)	** Yes (J)	Yes*	Rev.
Triple stretch stitch		J	02	02	02	02	02	02	02	02	Attaching sleeves, sewing inseams, sewing stretch fabrics and decorative stitching	0.0 (0) 0.0–7.0 (0–1/4)	2.5 (3/32) 1.5–4.0 (1/16–3/16)	** Yes (J)	No	Rfc.	

\*Do not use reverse stitching.

\*\*Select a stitch width of 5.0 mm (3/16 inch) or less.

## Basic stitching

**1** Baste or pin together the fabric pieces.

**2** Attach zigzag foot “J”.

**3** Select a stitch.

- For details, refer to “Selecting a stitch” (page 28).

**4** Lower the needle into the fabric at the beginning of the stitching.

**5** Start sewing.

- For details, refer to “Starting to sew” (page 29).
- For details on sewing reverse/reinforcement stitches, refer to “Sewing reinforcement stitches” (page 30).

**6** When sewing is finished, cut the thread.

- For details, refer to “Starting to sew” (page 29).



### Changing the needle position

With the straight stitch (left needle position) and the triple stretch stitch, the needle position can be adjusted. Pressing the “+” side of the stitch width adjustment key moves the needle to the right; pressing the “-” side of the stitch width adjustment key moves the needle to the left.

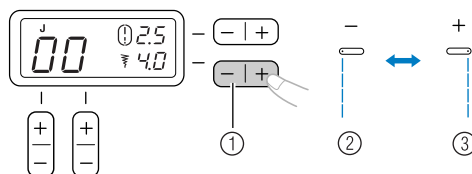

- ① Stitch width adjustment key
- ② Left needle position
- ③ Right needle position

# BLIND HEM STITCHING

You can use the Blind Hem Stitch to finish the edge of a project, like the hem of a pair of trousers, without the stitch showing.

Stitch Name	Pattern	Presser Foot	Pattern No.							Application	Stitch Width [mm (inch.)]	Stitch Length [mm (inch.)]	Twin Needle	Walking Foot	Reverse (Rev./Reinforcement (Rfc.) Stitching
			100 stitches model	90 stitches model	80 stitches model	70 stitches model	60 stitches model	50 stitches model	40 stitches mod		Auto Manual	Auto Manual			
Blind hem stitch		R	10	10	10	09	09	09	09	Blind hem stitching on medium weight fabrics	0 (0) -3←→3	2.0 (1/16) 1.0-3.5 (1/16-1/8)	No	No	Rfc.
		R	11	11	11	10	10	10	10	Blind hem stitching on stretch fabrics	0 (0) -3←→3	2.0 (1/16) 1.0-3.5 (1/16-1/8)	No	No	Rfc.

## 1 Reverse the skirt or pants.



- ① Right side of fabric
- ② Bottom side

## 2 Fold the fabric along the desired edge of the hem, and press.

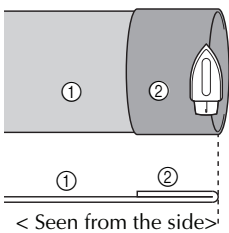

- ① Wrong side of fabric
- ② Right side of fabric

## 3 Use a chalk to mark on the fabric about 5 mm (3/16 inch) from the edge of the fabric, and then baste it.

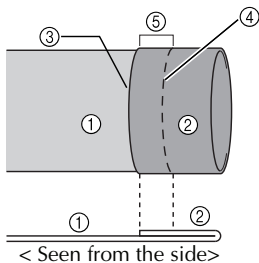

- ① Wrong side of fabric
- ② Right side of fabric
- ③ Edge of fabric
- ④ Basting stitching
- ⑤ 5 mm (3/16 inch)

## 4 Fold back the fabric inside along the basting.

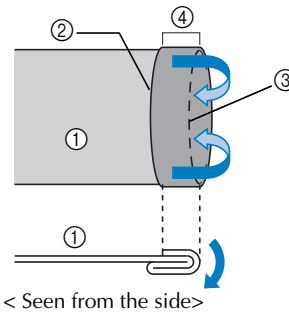

- ① Wrong side of fabric
- ② Edge of fabric
- ③ Basting
- ④ 5 mm (3/16 inch)

## 5 Unfold the edge of fabric, and position the fabric with the wrong side facing up.

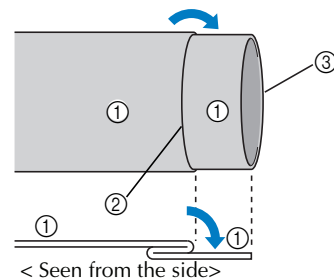

- ① Wrong side of fabric
- ② Basting
- ③ Edge of fabric

## 6 Attach blind hem foot "R".

## 7 Select a stitch.

**8** Remove the flat bed attachment and make free-arm sewing possible.

- For details on free-arm sewing, refer to "Using a free-arm style" (page 34).

**9** Slide the part that you wish to sew onto the arm, make sure that the fabric feeds correctly, and then start sewing.

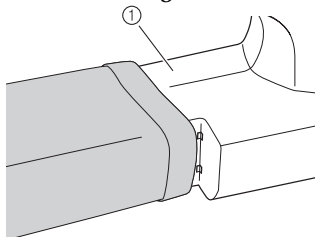

① Arm

**10** Position the fabric with the edge of the folded hem against the guide of the presser foot, and then lower the presser foot lever.

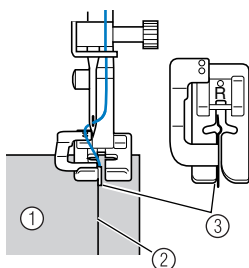

① Wrong side of fabric  
② Fold of hem  
③ Guide

**11** Adjust the stitch width until the needle slightly catches the fold of the hem.

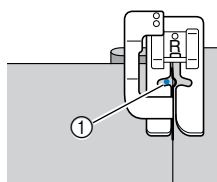

① Needle drop point

When you change the needle drop point, raise the needle, and then change the stitch width.

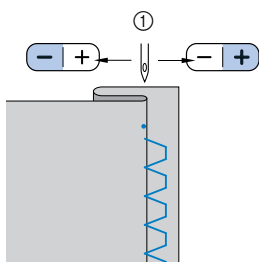

① Stitch width

**■ If the needle catches too much of the hem fold**

If the needle catches too much of the hem fold, adjust the stitch width so that the needle slightly catches the fold by pressing the "+" side of the stitch width adjustment key.

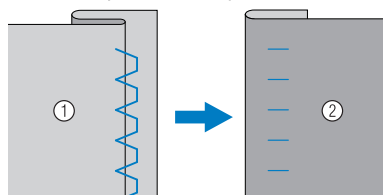

① Wrong side of fabric      ② Right side of fabric

**■ If the needle does not catch the hem fold**

If the needle does not catch the hem fold, adjust the stitch width so that the needle slightly catches the fold by pressing the "-" side of the stitch width adjustment key.

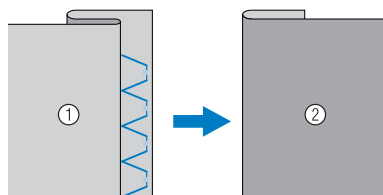

① Wrong side of fabric      ② Right side of fabric

- For details on changing the stitch width, refer to "Selecting a stitch" (page 28).

**12** Sew with the fold of the hem against the presser foot guide.

**13** Remove the basting stitching and turn the fabric right side up.

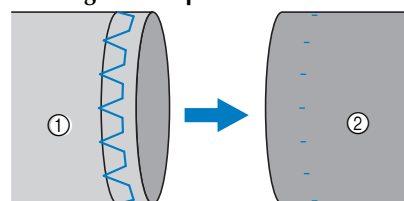

① Wrong side of fabric      ② Right side of fabric

# BUTTONHOLE SEWING

Buttonholes can be sewn and buttons can be sewn on.

Stitch Name	Pattern	Presser Foot	Pattern No.						Application	Stitch Width [mm (inch.)]		Stitch Length [mm (inch.)]		Twin Needle	Walking Foot	Reverse (Rev./ Reinforcement (Rfc.) Stitching)
			100 stitches model	90 stitches model	80 stitches model	70 stitches model	60 stitches model	50 stitches model		40 stitches model	Auto Manual	Auto Manual				
Buttonhole stitch		A	34	34	34	29	29	29	25	Horizontal buttonholes on thin and medium weight fabrics	5.0 (3/16) 3.0-5.0 (1/8-3/16)	0.5 (1/32) 0.2-1.0 (1/64-1/16)	No	No	Auto Rfc.*	
		A	35	35	35	30	30	30	26	Secured buttonholes for fabrics that have backings	5.0 (3/16) 3.0-5.0 (1/8-3/16)	0.5 (1/32) 0.2-1.0 (1/64-1/16)	No	No	Auto Rfc.*	
		A	36	36	36	31	31	31	27	Buttonholes for stretch or knit fabrics	6.0 (15/64) 3.0-6.0 (1/8-15/64)	1.0 (1/16) 0.5-2.0 (1/32-1/16)	No	No	Auto Rfc.*	
		A	37	37	37	32	32	32	28	Buttonholes for stretch fabrics	6.0 (15/64) 3.0-6.0 (1/8-15/64)	1.5 (1/16) 1.0-3.0 (1/16-1/8)	No	No	Auto Rfc.*	
		A	38	38	38	-	-	-	-	Bound buttonholes	5.0 (3/16) 0.0-6.0 (0-15/64)	2.0 (1/16) 0.2-4.0 (1/64-3/16)	No	No	Auto Rfc.*	
		A	39	39	39	33	33	33	29	Keyhole buttonholes for thick or furry fabrics	7.0 (1/4) 3.0-7.0 (1/8-1/4)	0.5 (1/32) 0.3-1.0 (1/64-1/16)	No	No	Auto Rfc.*	
		A	40	40	40	34	34	-	-	Keyhole buttonholes for medium weight and thick fabrics	7.0 (1/4) 3.0-7.0 (1/8-1/4)	0.5 (1/32) 0.3-1.0 (1/64-1/16)	No	No	Auto Rfc.*	
		A	41	41	41	35	35	-	-	Keyhole buttonholes for thick or furry fabrics	7.0 (1/4) 3.0-7.0 (1/8-1/4)	0.5 (1/32) 0.3-1.0 (1/64-1/16)	No	No	Auto Rfc.*	
Zigzag stitch (for quilting)		J	46	46	46	40	40	-	-	Appliqué quilting, free-motion quilting, satin stitching, button sewing	3.5 (1/8) 0.0-7.0 (0-1/4)	1.4 (1/16) 0.0-4.0 (0-3/16)	No	Yes	Rfc.	

\*Auto Rfc.: Automatic Reinforcement

The maximum buttonhole length is about 28 mm (1-1/8 inch) (diameter + thickness of the button). Buttonholes are sewn from the front of the presser foot to the back, as shown below.

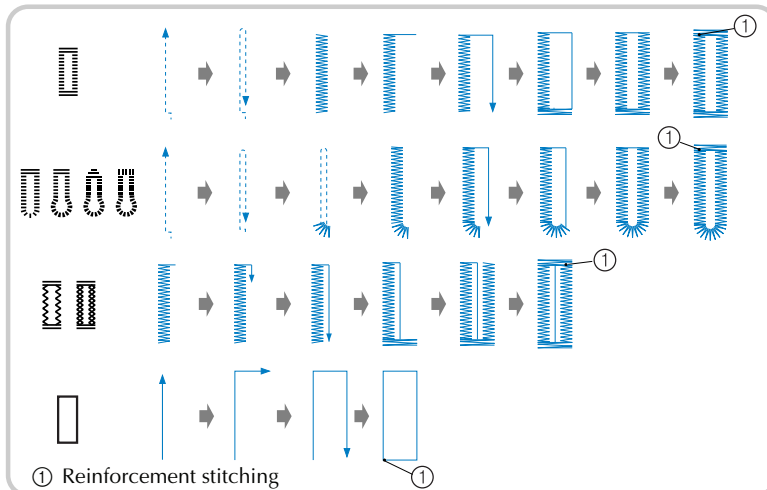



The names of parts of buttonhole foot "A", which is used for sewing buttonholes, are indicated below.

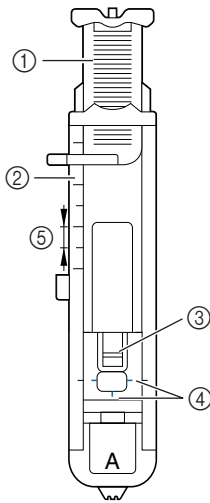

- ① Button guide plate
- ② Presser foot scale
- ③ Pin
- ④ Marks on buttonhole foot
- ⑤ 5 mm (3/16 inch)

**1 Use chalk to mark the position and length of the buttonhole on the fabric.**

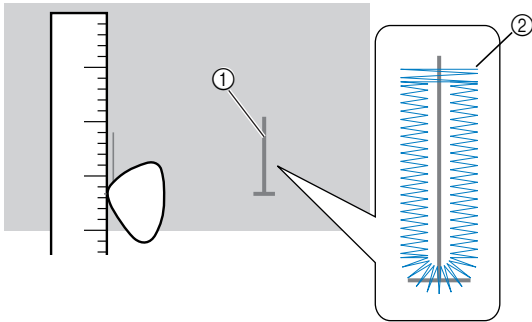

- ① Marks on fabric
- ② Buttonhole sewing

**2 Pull out the button guide plate of buttonhole foot "A", and then insert the button that will be put through the buttonhole.**

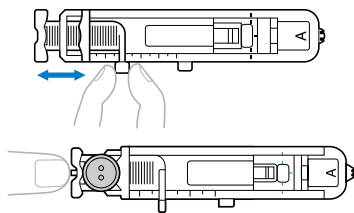

► The size of the buttonhole is set.

**■ If the button does not fit in the button guide plate**

Add together the diameter and thickness of the button, and then set the button guide plate to the calculated length. (The distance between the markings on the presser foot scale is 5 mm (3/16 inch).)

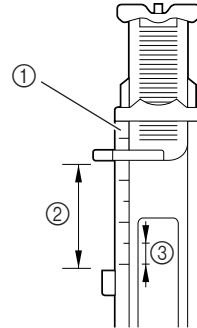

- ① Presser foot scale
- ② Length of buttonhole (Diameter + thickness of button)
- ③ 5 mm (3/16 inch)

Example: For a button with a diameter of 15 mm (9/16 inch) and a thickness of 10 mm (3/8 inch), the button guide plate should be set to 25 mm (1 inch) on the scale.

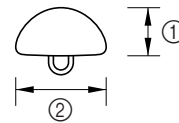

- ① 10 mm (3/8 inch)
- ② 15 mm (9/16 inch)

**3 Attach buttonhole foot "A".**

**4 Select a stitch.**

**5 Position the fabric with the front end of the buttonhole mark aligned with the red marks on the sides of the buttonhole foot, and then lower the presser foot lever.**

Pass the upper thread down through the hole in the presser foot.

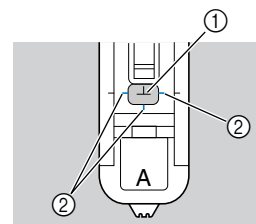

- ① Mark on fabric
- ② Red marks on buttonhole foot

- When lowering the presser foot, do not push in the front of the presser foot, otherwise the buttonhole will not be sewn with the correct size.

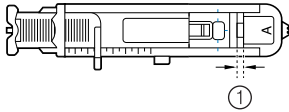
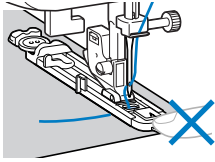

① Do not reduce the gap.

- 6** Pull down the buttonhole lever as far as possible.

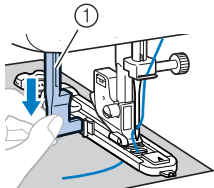

① Buttonhole lever

The buttonhole lever is positioned behind the bracket on the buttonhole foot.

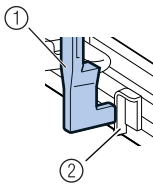

① Buttonhole lever  
② Bracket

- 7** Gently hold the end of the upper thread in your left hand, and then start sewing.

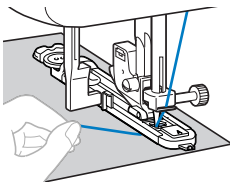

► Once sewing is completed, the machine automatically sews reinforcement stitches, then stops.

- 8** Raise the presser foot lever, remove the fabric, and cut the thread.

- 9** Raise the buttonhole lever to its original position.

- 10** Insert a pin at the end of the buttonhole stitching to prevent the stitching from being cut, and then use a seam ripper to cut towards the pin and open the buttonhole.

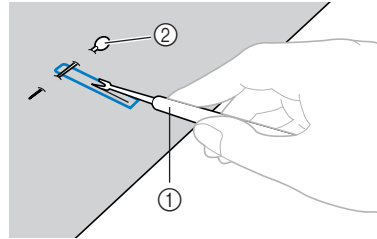

① Seam ripper  
② Pin

For keyhole buttonholes, use a commercial eyelet punch to make a hole in the rounded end of the buttonhole, and then use the seam ripper to cut open the buttonhole.

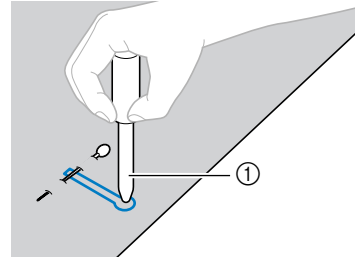

① Eyelet punch

- When using the eyelet punch, place thick paper or some other protective sheet under the fabric before punching the hole in the fabric.

**CAUTION**

- When opening the buttonhole with the seam ripper, do not place your hands in the cutting path, otherwise injuries may result if the seam ripper slips. Do not use the seam ripper in any other way than how it is intended.

**Memo**

- Before sewing buttonholes, check the stitch length and width by sewing a trial buttonhole on a scrap piece of fabric.

## ■ Sewing buttonholes on stretch fabrics

When sewing buttonholes on stretch fabrics, use a gimp thread.

- 1 Hook the gimp thread onto the part of buttonhole foot "A" shown in the illustration so that it fits into the grooves, and then loosely tie it.

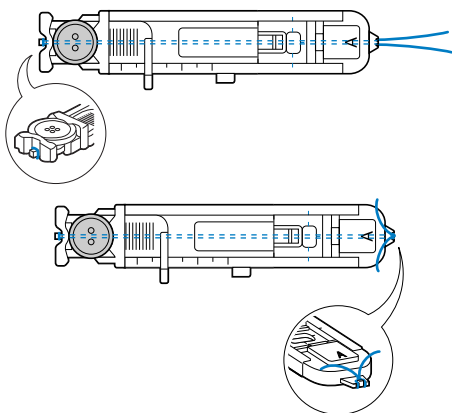

- 2 Attach buttonhole foot "A".

- 3 Select a stitch  or .

- 4 Adjust the stitch width to the thickness of the gimp thread.

- 5 Lower the presser foot lever and the buttonhole lever, and then start sewing.

- 6 When sewing is finished, gently pull the gimp thread to remove any slack.

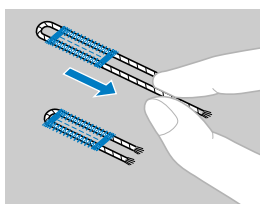

- 7 Use a handsewing needle to pull the gimp thread to the wrong side of the fabric, and then tie it.

- 8 With a seam ripper, cut the middle part of the gimp thread remaining at the top end of the buttonhole.

Trim off any excess of the gimp thread.

## Button sewing

Buttons can be sewn on with the sewing machine. Buttons with 2 or with 4 holes can be attached.

- 1 Measure the distance between the holes in the button to be attached.

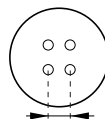

- 2 Raise the presser foot lever, and then slide the feed dog position lever, located at the rear of the machine on the base, to  (to the right as seen from the front of the machine).

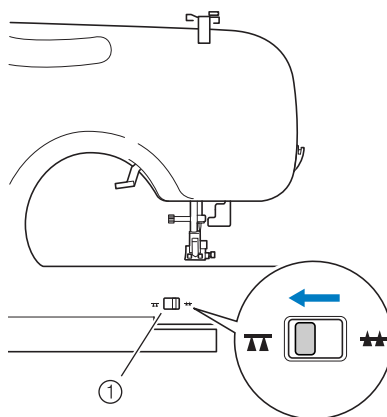

- 1 Feed dog position lever (as seen from the rear of the machine)

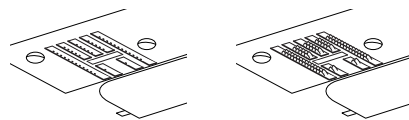

► The feed dogs are lowered.

- 3 Attach presser foot "M".





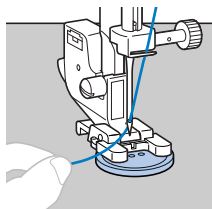

- 1 Button fitting foot "M"

- 4** Place a button between the presser foot and the fabric.

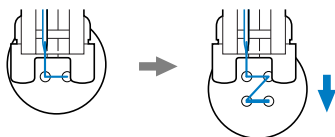

- When attaching four-hole buttons, first sew the two holes closest to you. Then, slide the button so that the needle goes into the two holes toward the rear of the sewing machine, and then sew them in the same way.



- 5** Select a stitch . (With models not provided with stitch , select stitch .)

- 6** Adjust the stitch width so that it is the same as the distance between the holes in the button.

- 7** Set the stitch length to the shortest setting by pressing the stitch length adjustment key.

- 8** Turn the handwheel toward you (counterclockwise) to check that the needle correctly goes into the two holes of the button.

Adjust the stitch width to the distance between the button holes.

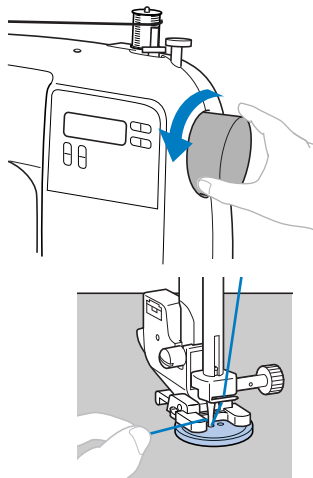

**CAUTION**

- When sewing, be sure that the needle does not touch the button, otherwise the needle may bend or break.

- 9** Start sewing.

- After sewing for about 10 seconds at low speed, press  (reverse/reinforcement stitch button) to sew reinforcement stitches.

- 10** Pull the upper thread at the end of the stitching to the wrong side of the fabric, and then tie it with the bobbin thread.

Use scissors to cut the upper thread and the bobbin thread at the beginning of the stitching.

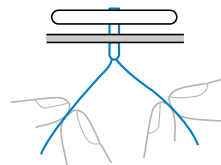

- 11** When you are finished attaching the button, slide the feed dog position lever to  (to the left as seen from the front of the machine) and turn the handwheel to raise the dogs.

- Normally, the feed dog position lever is positioned at .

# ZIPPER INSERTION

You can use the zipper foot to sew different types of zippers, and can easily position it to the right or left side of the needle.

When sewing the right side of the zipper, attach the shank to the left pin of the zipper foot. When sewing the left side of the zipper, attach the shank to the right pin of the zipper foot.

Stitch Name	Pattern	Presser Foot	Pattern No.								Application	Stitch Width	Stitch Length	Twin Needle	Walking Foot	Reverse (Rev.)/ Reinforcement (Rfc.) Stitching
			100 stitches model	90 stitches model	80 stitches model	70 stitches model	60 stitches model	50 stitches model	40 stitches model	[mm (inch.)] Auto Manual		[mm (inch.)] Auto Manual				
Straight stitch (center)	---	I	01	01	01	01	01	01	01	01	Attaching zippers, basic stitching, and sewing gathers or pintucks, etc.	3.5 (1/8) 0.0-7.0 (0-1/4)	2.5 (3/32) 0.2-5.0 (1/64-3/16)	** Yes (1)	Yes*	Rev.

\*Do not use reverse stitching.

\*\*Select a stitch width of 5.0 mm (3/16 inch) or less.

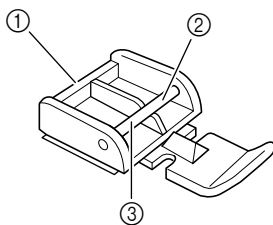

- ① Zipper foot
- ② Right pin for sewing the left side of the zipper
- ③ Left pin for sewing the right side of the zipper

**1** Select stitch

**2** Lower the presser foot lever and fix either the left or right pin of the zipper foot onto the shank.

**3** Fold the edge of the material 2 cm (3/4 inch) and place the zipper under the folded section. Lower the needle into the notch located either on the left or right side of the zipper foot.

## CAUTION

- Turn the handwheel by hand to make sure the needle does not hit the presser foot before you start sewing. If you choose a different stitch, the needle will hit the presser foot and break the needle. You may also be injured.

**4** Sew from the bottom of the zipper toward the top on both sides. The needle should be positioned on the zipper side of the foot for best results.

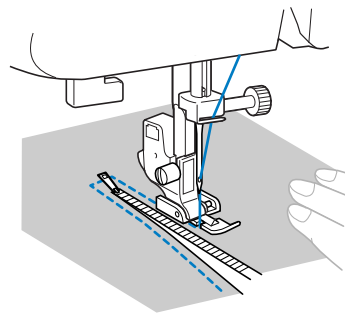

**5** To sew the opposite side of the zipper, release the foot by pressing the button located at the back of the presser foot, fit the zipper foot on the other side of the zipper and continue sewing using the other side notch.

## CAUTION

- Make sure the needle does not hit the zipper during sewing. If the needle hits the zipper, the needle may break and you may be injured.

# SEWING STRETCH FABRICS AND ELASTIC TAPE

Stretch fabrics can be sewn and elastic tape can be attached.

Stitch Name	Pattern	Presser Foot	Pattern No.							Application	Stitch Width [mm (inch.)]	Stitch Length [mm (inch.)]	Twin Needle	Walking Foot	Reverse (Rev./Reinforcement (Rfc.) Stitching
			100 stitches mode	90 stitches mode	80 stitches mode	70 stitches model	60 stitches model	50 stitches model	40 stitches model		Auto Manual	Auto Manual			
Stretch stitch		J	03	03	03	03	03	03	03	Sewing stretch fabrics and decorative stitching	1.0 (1/16) 1.0-3.0 (1/16-1/8)	2.5 (3/32) 1.0-4.0 (1/16-3/16)	Yes (J)	No	Rfc.
3-point zigzag stitch		J	05	05	05	05	05	05	05	Overcasting on medium weight or stretch fabrics, attaching elastic, darning, etc.	5.0 (3/16) 1.5-7.0 (1/16-1/4)	1.0 (1/16) 0.2-4.0 (1/64-3/16)	Yes (J)*	No	Rfc.
Elastic-attaching stitch		J	21	21	21	-	-	-	-	Attaching elastic to stretch fabrics	4.0 (3/16) 0.0-7.0 (0-1/4)	1.0 (1/16) 0.2-4.0 (1/64-3/16)	Yes (J)*	No	Rfc.

\*Select a stitch width of 5.0 mm (3/16 inch) or less.

Observe the corresponding precautions when performing each of the following stitching operations.

## Stretch stitching

- 1 Attach zigzag foot "J".
- 2 Select stitch
- 3 Sew the fabric without stretching it.

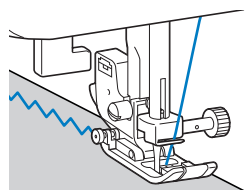

## Elastic attaching

When elastic tape is attached to the cuff or waist of a piece of clothing, the finished dimensions will be that of the stretched elastic tape. Therefore, it is necessary that a suitable length of the elastic tape be used.

- 1 Pin the elastic tape to the wrong side of the fabric.  
Pin the elastic tape to the fabric at a few points to make sure that the tape is uniformly positioned on the fabric.

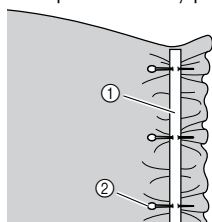

① Elastic tape  
② Pin

- 2 Attach zigzag foot "J".
- 3 Select stitch
- 4 Sew the elastic tape to the fabric while stretching the tape so that it is the same length as the fabric.

While pulling the fabric behind the presser foot with your left hand, pull the fabric at the pin nearest the front of the presser foot with your right hand.

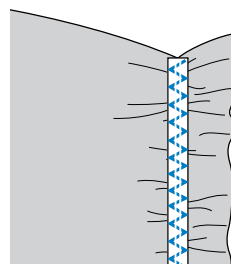
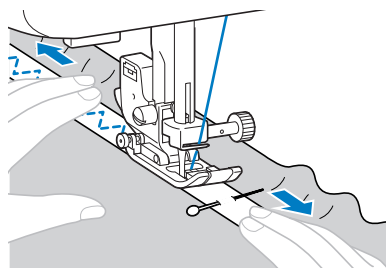













### CAUTION

- When sewing, be sure that the needle does not touch any pins, otherwise the needle may bend or break.

# APPLIQUÉ, PATCHWORK AND QUILT STITCHING

The stitches that can be used for sewing appliqués, patchwork and quilts are described below.

Stitch Name	Pattern	Presser Foot	Pattern No.							Application	Stitch Width	Stitch Length	Twin Needle	Walking Foot	Reverse (Rev./ Reinforcement (Rfc.) Stitching)
			100 stitches mode	90 stitches mode	80 stitches mode	70 stitches model	60 stitches model	50 stitches model	40 stitches model		mm (inch.)	mm (inch.)			
Zigzag stitch		J	04	04	04	04	04	04	04	Overcasting and attaching appliqués	3.5 (1/8) 0.0–7.0 (0–1/4)	1.4 (1/16) 0.0–4.0 (0–3/16)	** Yes (J)	Yes*	Rfc.
Zigzag stitch (for quilting)		J	46	46	46	40	40	-	-	Appliqué quilting, free-motion quilting, satin stitching	3.5 (1/8) 0.0–7.0 (0–1/4)	1.4 (1/16) 0.0–4.0 (0–3/16)	No	Yes	Rfc.
Appliqué stitch		J	12	12	12	11	11	11	11	Appliqué stitching	3.5 (1/8) 2.5–7.0 (3/32–1/4)	2.5 (3/32) 1.6–4.0 (1/16–3/16)	** Yes (J)	No	Rfc.
Appliqué stitch (for quilting)		J	47	47	47	41	41	-	-	Attaching appliqués and binding	1.5 (1/16) 0.5–3.5 (1/32–1/8)	1.8 (1/16) 1.0–4.0 (1/16–3/16)	No	No	Rfc.
		J	48	48	48	42	42	-	-	Attaching appliqués and binding	1.5 (1/16) 0.5–3.5 (1/32–1/8)	1.8 (1/16) 1.0–4.0 (1/16–3/16)	No	No	Rfc.
Piecing straight stitch		J	43	43	43	37	37	-	-	Piecing straight stitching (with a seam allowance of 6.5mm from the right edge of the presser foot)	5.5 (7/32) 0.0–7.0 (0–1/4)	2.0 (1/16) 0.2–5.0 (1/64–3/16)	No	Yes	Rfc.
		J	44	44	44	38	38	-	-	Piecing straight stitching (with a seam allowance of 6.5mm from the left edge of the presser foot)	1.5 (1/16) 0.0–7.0 (0–1/4)	2.0 (1/16) 0.2–5.0 (1/64–3/16)	No	Yes	Rfc.
Joining stitch		J	15	15	15	14	14	14	14	Patchwork stitching and decorative stitching	4.0 (3/16) 0.0–7.0 (0–1/4)	1.2 (1/16) 0.2–4.0 (1/64–3/16)	** Yes (J)	No	Rfc.
		J	16	16	16	15	15	15	15	Patchwork stitching, decorative stitching and sewing overcasting on both pieces of fabrics, such as with tricot	5.0 (3/16) 2.5–7.0 (3/32–1/4)	2.5 (3/32) 1.0–4.0 (1/16–3/16)	** Yes (J)	No	Rfc.
		J	17	17	17	16	16	16	16	Patchwork stitching and decorative stitching	5.0 (3/16) 0.0–7.0 (0–1/4)	1.2 (1/16) 0.2–4.0 (1/64–3/16)	** Yes (J)	No	Rfc.
Hand-look quilting		J	45	45	45	39	39	35	31	Straight stitch quilting that looks hand-sewn	0.0 (0) 0.0–7.0 (0–1/4)	2.5 (3/32) 1.0–4.0 (1/16–3/16)	No	No	Rfc.
Quilting stippling		J	49	49	49	43	43	-	-	Quilting background stitching (stippling)	7.0 (1/4) 1.0–7.0 (1/16–1/4)	1.6 (1/16) 1.0–4.0 (1/16–3/16)	No	No	Rfc.

\*Do not use reverse stitching.

\*\*Select a stitch width of 5.0 mm (3/16 inch) or less.

## Appliqués

You can create an appliqué by cutting a different piece of fabric into a shape and using it as a decoration.

**1** Baste the cut design to the fabric.

**2** Attach zigzag foot “J”.

**3** Select stitch .

- 4** Carefully sew around the edge of the design.

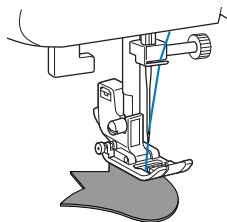

- 5** Cut away any fabric that is left outside the stitching.

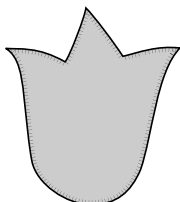

- 6** Remove the basting, if necessary.



**Memo**

- Make reinforcing straight stitches at the beginning and the end of stitching.

**CAUTION**

- Be careful that the needle does not hit a pin during sewing, as the needle can break. You may also be injured.

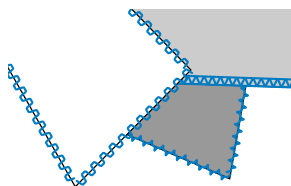
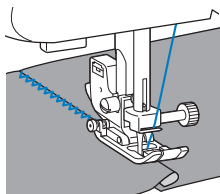

**Patchwork (crazy quilt) stitching**

- 1** Fold the edge of the top piece of fabric and place it over the lower piece.
- 2** Sew the two pieces of fabric together so the pattern spans both pieces.



**Piecing**

Sewing together two pieces of fabric is called "piecing". The fabric pieces should be cut with a 6.5 mm (1/4 inch) seam allowance. Sew a piecing straight stitch 6.5 mm (1/4 inch) from either the right side or the left side of the presser foot.

- 1** Baste or pin along the seam allowance of the fabric that you wish to piece together.
- 2** Attach zigzag foot "J".
- 3** Select stitch  or .
- 4** Sew with the side of the presser foot aligned with the edge of the fabric.

- **For a seam allowance on the right side**  
Align the right side of the presser foot with the edge of the fabric, and sew using stitch .

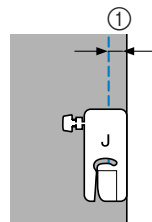

① 6.5 mm (1/4 inch)

- **For a seam allowance on the left side**  
Align the left side of the presser foot with the edge of the fabric, and sew using stitch .

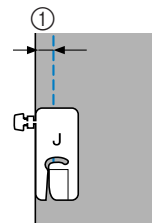

① 6.5 mm (1/4 inch)



**Memo**

- To change the width of the seam allowance (the needle position), adjust the stitch width. For details, refer to "Changing the needle position" (page 43).



## Quilting

Sandwiching batting between the top and bottom layers of fabric is called "quilting". Quilts can easily be sewn using the optional walking foot and the optional quilting guide.



### Note

- Only use the walking foot with straight or zigzag stitches. Do not use other patterns. Reverse stitches cannot be sewn with the walking foot.

- 1 Baste the fabric to be quilted.**
- 2 Remove the presser foot and the presser foot holder.**
  - For details, refer to "Removing the presser foot holder" (page 26).
- 3 Hook the connecting fork of the walking foot onto the needle clamp screw, lower the presser foot lever, and then use the presser foot holder screw to attach the walking foot to the presser bar.**

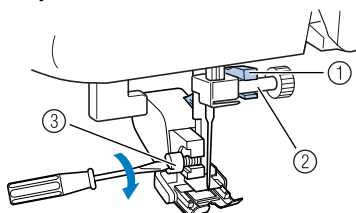

- ① Connecting fork
- ② Needle clamp screw
- ③ Presser foot holder screw

### CAUTION

- Use the screwdriver to tighten the screw securely. If the screw is loose, the needle may strike the presser foot and cause injury.
- Be sure to turn the handwheel toward the front of the machine to check that the needle does not strike the presser foot. If the needle strikes the presser foot, injury may result.

- 4 Select stitch**   or .

- 5 Place one hand on each side of the presser foot, and then evenly guide the fabric while sewing.**

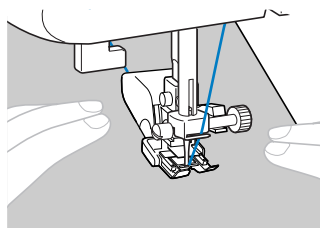

### Note

- When sewing with the walking foot, sew at a speed between slow and medium.

- **Using the optional quilting guide**  
Use the quilting guide to sew parallel stitches that are equally spaced.

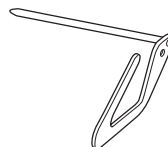

- 1 Insert the stem of the quilting guide into the hole at the rear of the walking foot or presser foot holder.**

- Walking foot

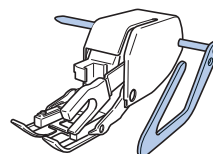

- Presser foot holder

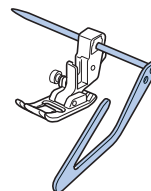

- 2 Adjust the stem of the quilting guide so that the quilt guide aligns with the seam that has already been sewn.**

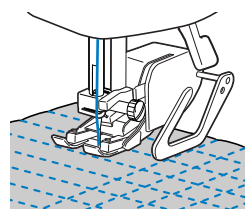

## Free-motion quilting

With free-motion quilting, the feed dogs can be lowered (using the feed dog position lever) so that the fabric can be moved freely in any direction. The optional quilting foot is needed for free-motion quilting.

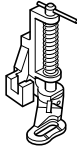

### 1 Remove the presser foot and the presser foot holder.

- For details, refer to “Removing the presser foot holder” (page 26).

### 2 Align the quilting foot with the lower-left side of the presser bar.

The pin on the quilting foot should be positioned over the needle clamp screw.

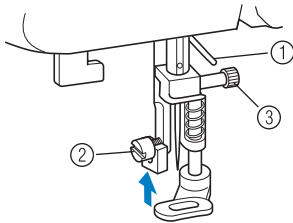

- ① Pin on quilting foot
- ② Presser foot holder screw
- ③ Needle clamp screw

### 3 Hold the quilting foot in place with your right hand, and then tighten the presser foot holder screw using the screwdriver in your left hand.

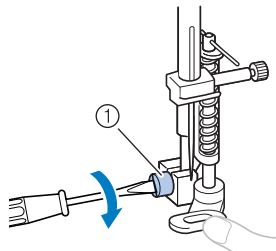

- ① Presser foot holder screw

## ⚠ CAUTION

- Be sure to securely tighten the screws with the screwdriver, otherwise the needle may touch the presser foot, causing it to bend or break.

### 4 Slide the feed dog position lever, located at the rear of the machine on the base, to (to the right as seen from the front of the machine).

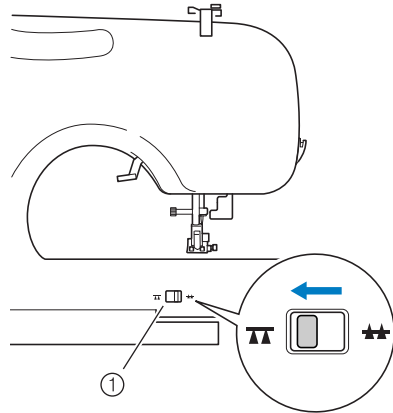

- ① Feed dog position lever (as seen from the rear of the machine)

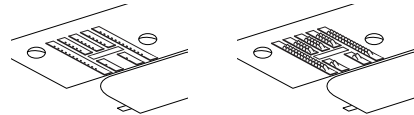

- ▶ The feed dogs are lowered.

### 5 Turn on the sewing machine, and then select a stitch.

### 6 Use both hands to hold the fabric taut, then move the fabric to follow the pattern.

Reinforcement stitches are sewn at the beginning and end of sewing.

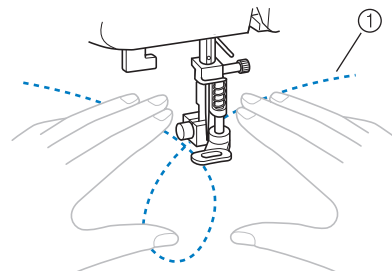



- ① Pattern

### 7 After sewing is finished, slide the feed dog position lever to (to the left as seen from the front of the machine) and turn the handwheel to raise the dogs.

- Normally, the feed dog position lever is positioned at .

# REINFORCEMENT STITCHING

Reinforce points that will be subject to strain, such as sleeve holes, inseams and pocket corners.

Stitch Name	Pattern	Presser Foot	Pattern No.						Application	Stitch Width [mm (inch.)]	Stitch Length [mm (inch.)]	Twin Needle	Walking Foot	Reverse (Rev./) Reinforcement (Rfc.) Stitching			
			100 stitches model	90 stitches model	80 stitches model	70 stitches model	60 stitches model	50 stitches model		40 stitches model	Auto Manual				Auto Manual		
Triple stretch stitch		J	02	02	02	02	02	02	02	02	02	Attaching sleeves, sewing inseams, sewing stretch fabrics and decorative stitching	<b>0.0 (0)</b> 0.0-7.0 (0-1/4)	<b>2.5 (3/32)</b> 1.5-4.0 (1/16-3/16)	** Yes (J)	No	Rfc.
Bar tack stitch		A	42	42	42	36	36	34	30			Reinforcing openings and areas where the seam easily comes loose	<b>2.0 (1/16)</b> 1.0-3.0 (1/16-1/8)	<b>0.4 (1/64)</b> 0.3-1.0 (1/64-1/16)	No	No	Auto Rfc.*

\*Auto Rfc.: Automatic Reinforcement

\*\*Select a stitch width of 5.0 mm (3/16 inch) or less.

## Triple stretch stitching

Use triple stretch stitching to reinforce sleeve holes and inseams.

- 1 Attach zigzag foot "J".
- 2 Select stitch .
- 3 Start sewing.
  - For details, refer to "Starting to sew" (page 29).

## Bar tack stitching

Bar tacks are used to reinforce points subject to strain, such as pocket corners and openings. As an example, the procedure for sewing bar tacks at pocket corners is described below.

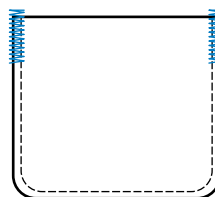

- 1 Determine the desired length of the bar tack. Set the button guide plate on buttonhole foot "A" to the desired length. (The distance between the markings on the presser foot scale is 5 mm (3/16 inch).)

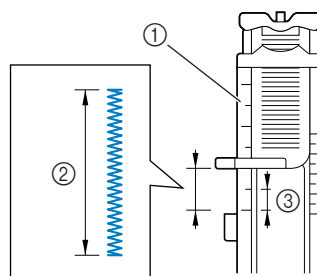

- ① Presser foot scale
- ② Length of bar tack
- ③ 5 mm (3/16 inch)

- A bar tack with a maximum length of about 28 mm (1-1/8 inch) can be sewn.

- 2 Attach buttonhole foot "A".

**3** Select stitch .

**4** Position the fabric so that the opening of the pocket faces toward you, and then lower the presser foot lever so that the needle drops 2 mm (1/16 inch) in front of the pocket opening.

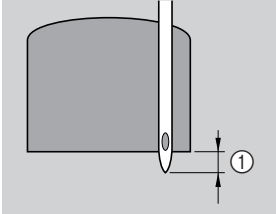

① 2 mm (1/16 inch)

Pass the upper thread down through the hole in the presser foot.

- When lowering the presser foot, do not push in the front of the presser foot, otherwise the bar tack will not be sewn with the correct size.

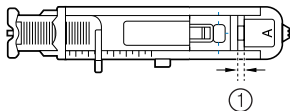
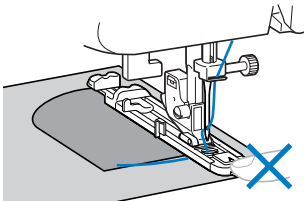

① Do not reduce the gap.

**5** Pull down the buttonhole lever as far as possible.

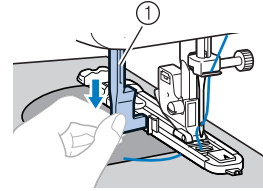

① Buttonhole lever

The buttonhole lever is positioned behind the bracket on the buttonhole foot.

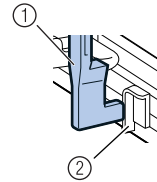

① Buttonhole lever  
② Bracket

**6** Gently hold the end of the upper thread in your left hand, and then start sewing.

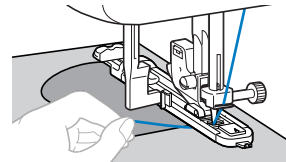

- ▶ Once sewing is completed, the machine automatically sews reinforcement stitches, then stops.

**7** Raise the presser foot lever, remove the fabric, and cut the thread.

**8** Raise the buttonhole lever to its original position.



**Memo**

- If the fabric does not feed, for example, because it is too thick, increase the stitch length. For details, refer to "Selecting a stitch" (page 28).



# DECORATIVE STITCHING

Various decorative stitches can be sewn with this sewing machine.

Stitch Name	Pattern	Presser Foot	Pattern No.							Application	Stitch Width [mm (inch.)]		Stitch Length [mm (inch.)]		Twin Needle	Walking Foot	Reverse (Rev.)/ Reinforcement (Rfc.) Stitching
			100 stitches model	90 stitches model	80 stitches model	70 stitches model	60 stitches model	50 stitches model	40 stitches model		Auto Manual	Auto Manual					
Fagoting stitch		J	19	19	19	17	17	17	17	Fagoting, smocking and decorative stitching	5.0 (3/16) 0.0-7.0 (0-1/4)	2.5 (3/32) 1.0-4.0 (1/16-3/16)	Yes (J)	No	Rfc.		
		J	20	20	20	18	18	18	18	Fagoting, smocking and decorative stitching	5.0 (3/16) 2.5-7.0 (3/32-1/4)	2.5 (3/32) 1.0-4.0 (1/16-3/16)	Yes (J)	No	Rfc.		
Joining stitch		J	15	15	15	14	14	14	14	Patchwork stitching and decorative stitching	4.0 (3/16) 0.0-7.0 (0-1/4)	1.2 (1/16) 0.2-4.0 (1/64-3/16)	Yes (J)	No	Rfc.		
		J	16	16	16	15	15	15	15	Patchwork stitching, decorative stitching and sewing overcasting on both pieces of fabrics, such as with tricot	5.0 (3/16) 2.5-7.0 (3/32-1/4)	2.5 (3/32) 1.0-4.0 (1/16-3/16)	Yes (J)	No	Rfc.		
		J	17	17	17	16	16	16	16	Patchwork stitching and decorative stitching	5.0 (3/16) 0.0-7.0 (0-1/4)	1.2 (1/16) 0.2-4.0 (1/64-3/16)	Yes (J)	No	Rfc.		
Shell tuck stitch		J	13	13	13	12	12	12	12	Sell tuck stitching	4.0 (3/16) 0.0-7.0 (0-1/4)	2.5 (3/32) 0.2-4.0 (1/64-3/16)	Yes (J)	No	Rfc.		
Smocking stitch		J	18	18	18	-	-	-	-	Smocking stitching and decorative stitching	5.0 (3/16) 0.0-7.0 (0-1/4)	1.6 (1/16) 1.0-4.0 (1/16-3/16)	Yes (J)	No	Rfc.		
Satin scallop stitch		N	14	14	14	13	13	13	13	Scallop stitching	5.0 (3/16) 2.5-7.0 (3/32-1/4)	0.5 (1/32) 0.1-1.0 (1/64-1/16)	Yes (J)	No	Rfc.		
Decorative stitch		J	22	22	22	19	19	19	19	Decorative stitching	4.0 (3/16) 0.0-7.0 (0-1/4)	3.0 (1/8) 2.0-4.0 (1/16-3/16)	No	No	Rfc.		
		J	23	23	23	20	20	20	20	Decorative stitching	4.0 (3/16) 0.0-7.0 (0-1/4)	2.5 (3/32) 1.0-4.0 (1/16-3/16)	Yes (J)	No	Rfc.		
		J	24	24	24	21	21	21	-	Decorative stitching	5.5 (7/32) 0.0-7.0 (0-1/4)	1.6 (1/16) 1.0-4.0 (1/16-3/16)	Yes (J)	No	Rfc.		
		N	25	25	25	22	22	22	21	Decorative stitching and elastic-attaching	5.0 (3/16) 1.5-7.0 (1/64-1/4)	1.0 (1/16) 0.2-4.0 (1/64-3/16)	Yes (J)	No	Rfc.		
		N	26	26	26	23	23	23	22	Lace sewing, decorative hemming, heirloom stitching, etc.	3.5 (1/8) 1.5-7.0 (1/16-1/4)	2.5 (3/32) 1.6-4.0 (1/16-3/16)	No	No	Rfc.		
		N	27	27	27	24	24	24	23	Decorative hemming, heirloom stitching, etc.	6.0 (15/64) 1.5-7.0 (1/16-1/4)	3.0 (1/8) 1.5-4.0 (1/16-3/16)	No	No	Rfc.		
		N	28	28	28	25	25	25	-	Decorative hemming on thin, medium weight and plain weave fabrics, heirloom stitching, etc.	5.0 (3/16) 1.5-7.0 (1/16-1/4)	3.5 (1/8) 1.5-4.0 (1/16-3/16)	No	No	Rfc.		
		N	29	29	29	26	26	26	24	Decorative hemming on thin, medium weight and plain weave fabrics, heirloom stitching, etc.	5.0 (3/16) 1.5-7.0 (1/16-1/4)	4.0 (3/16) 1.5-4.0 (1/16-3/16)	No	No	Rfc.		
		N	30	30	30	27	27	27	-	Decorative hemming on thin, medium weight and plain weave fabrics, heirloom stitching, etc.	5.0 (3/16) 1.5-7.0 (1/16-1/4)	2.5 (3/32) 1.5-4.0 (1/16-3/16)	No	No	Rfc.		

\*Select a stitch width of 5.0 mm (3/16 inch) or less.



Stitch Name	Pattern	Presser Foot	Pattern No.							Application	Stitch Width [mm (inch.)]	Stitch Length [mm (inch.)]	Twin Needle	Walking Foot	Reverse (Rev.)/ Reinforcement (Rfc.) Stitching
			100 stitches model	90 stitches model	80 stitches model	70 stitches model	60 stitches model	50 stitches model	40 stitches model		Auto Manual	Auto Manual			
Decorative stitch		N	31	31	31	28	28	28	-	Decorative hemming on thin, medium weight and plain weave fabrics, heirloom stitching, etc.	5.0 (3/16) 1.5-7.0 (1/16-1/4)	2.0 (1/16) 1.5-4.0 (1/16-3/16)	No	No	Rfc.
		N	32	32	32	-	-	-	-	Decorative stitching, smocking stitching, heirloom stitching, etc.	6.0 (15/64) 1.5-7.0 (1/16-1/4)	1.6 (1/16) 1.0-4.0 (1/16-3/16)	No	No	Rfc.
		N	33	33	33	-	-	-	-	Decorative stitching, smocking stitching, heirloom stitching, etc.	5.0 (3/16) 1.5-7.0 (1/16-1/4)	1.6 (1/16) 1.0-4.0 (1/16-3/16)	No	No	Rfc.



## Fagoting

Stitching across an open seam is called “fagoting”. It is used on blouses and children’s clothing. This stitch is more decorative when thicker thread is used.

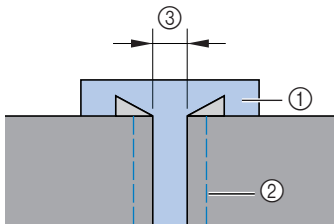
- 1 Use an iron to fold the two pieces of fabric along their seams.
- 2 Baste the two pieces of fabric, separated by about 4.0 mm (3/16 inch), onto thin paper or a sheet of water-soluble stabilizer.



- ① Thin paper or water soluble stabilizer
- ② Basting stitching
- ③ 4 mm (3/16 inch)

- 3 Attach zigzag foot “J”.
- 4 Select stitch  or .
- 5 Set the stitch width to 7.0 mm (1/4 inch).
  - For details, refer to “Selecting a stitch” (page 28).

- 6 Sew with the center of the presser foot aligned along the center of the two pieces of fabric.

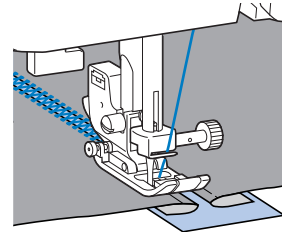
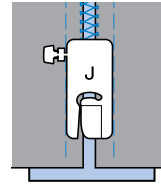

- 7 After sewing is finished, remove the paper.

## Scallop stitching

The wave-shaped repeating pattern that looks like shells is called “scalloping”. It is used on the collars of blouses and to decorate the edges of handkerchiefs.

- 1 Attach monogramming foot “N”.
- 2 Select stitch .
- 3 Stitch along the edge of the fabric, making sure not to sew directly on the edge of the fabric.

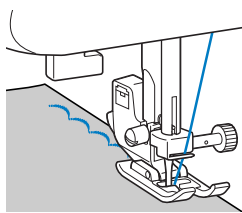

- For better results, apply spray starch onto the fabric and press with a hot iron before it is sewn.

- 4 Trim along the stitches.

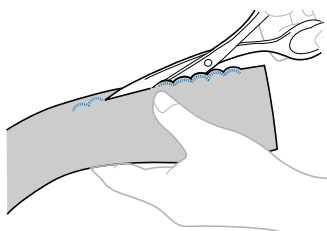

- Be careful not to cut the stitches.

## Smocking

The decorative stitch created by stitching or embroidering over gathers is called “smocking”. It is used to decorate the front of blouses or cuffs. The smocking stitch adds texture and elasticity to fabric.

- 1 Attach zigzag foot “J”.
- 2 Select the straight stitch, and then adjust the stitch length to 4.0 mm (3/16 inch) and loosen the thread tension.

- For details, refer to “Selecting a stitch” (page 28) and “Adjusting thread tension” (page 31).

- 3 Sew parallel stitching at intervals of 1 cm (3/8 inch).

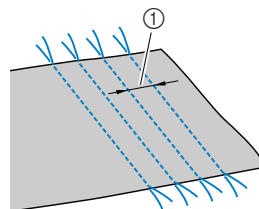



① 1 cm (3/8 inch)

- Do not sew reverse/reinforcement stitches or cut the thread.

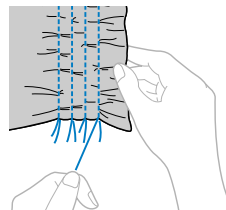
- 4 Pull the bobbin threads to create gathers. Smooth the gathers by ironing them.



- 5 Select stitch  or .

- 6 Stitch between the straight stitches.

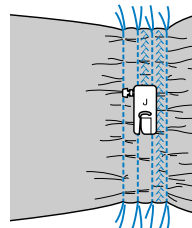

- 7** Pull out the threads for the straight stitches.

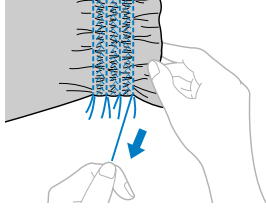

### Shell tuck stitching

The gathers that look like shells are called “shell tucks”. They are used to decorate trims, the front of blouses or cuffs made of thin fabrics.

- 1** Fold the fabric along the bias.

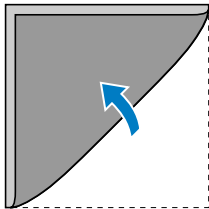

- 2** Attach zigzag foot “J”.

- 3** Select stitch , and then increase the thread tension.

- For details, refer to “Selecting a stitch” (page 28).

- 4** Sew while making sure that the needle drops slightly off the edge of the fabric.

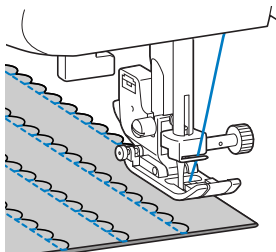
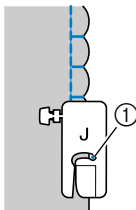

① Needle drop point

- 5** Unfold the fabric, and then iron the tucks down to one side.

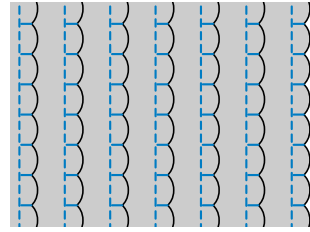

### Joining

Decorative bridging stitches can be sewn over the seam allowance of joined fabrics. This is used when making a crazy quilt.

- 1** Attach zigzag foot “J”.

- 2** Sew together the right sides of the two pieces of fabric, and then open up the seam allowances.

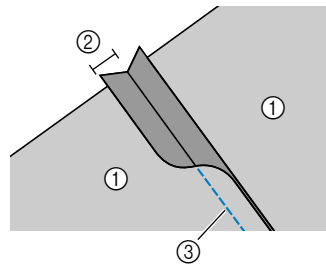

- ① Wrong side of fabric
- ② 6.5 mm (1/4 inch) seam allowance
- ③ Straight stitch

- 3** Select stitch ,  or .

- 4** Turn the fabric over so that the right side faces up, and then sew over the seam with the center of the presser foot aligned with the seam.

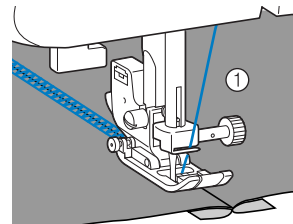

① Right side of fabric



## Heirloom stitching

When sewing with the wing needle, the needle holes are enlarged, creating a lace-like decorative stitch. This is used to decorate hems and tablecloths on thin or medium weight fabrics in addition to plain weave fabrics.

### ⚠ CAUTION

- The needle threader cannot be used with the wing needle, otherwise the sewing machine may be damaged. Manually pass the thread through the eye of the needle from the front to the back. For details, refer to “Upper threading” (page 17).

#### 1 Insert the wing needle.

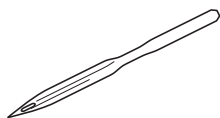

- Use a 130/705H 100/16 wing needle.
- For details on inserting a needle, refer to “Replacing the needle” (page 22).

#### 2 Attach monogramming foot “N”.

#### 3 Select stitch .

### ⚠ CAUTION

- Select a stitch width of 6.0 mm (15/64 inch) or less, otherwise the needle may bend or break.
- After adjusting the stitch width, slowly turn the handwheel toward you (counterclockwise) and check that the needle does not touch the presser foot. If the needle hits the presser foot, the needle may bend or break.

#### 4 Start sewing.

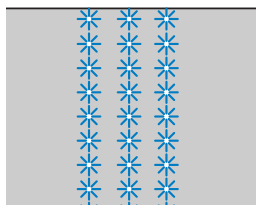

# SEWING CHARACTERS (for models equipped with character stitches)

55 characters can be sewn by following the procedure below.

## Selecting characters

### ■ Selecting a character

[Example] Selecting stitch "C" (No. 03).

- 1 Turn on the sewing machine.

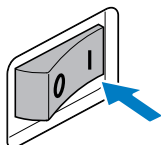

- 2 Press the character stitch key and confirm that the character stitch indicator lights up.

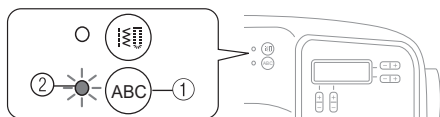

- ① Character stitch key
- ② Character stitch indicator



### Memo

- When you select a character, check that there are no characters in memory.

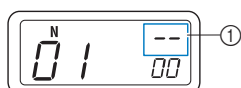

- ① This indicator shows that no character is stored. If there are any characters in memory, delete them. (For details, refer to "Deleting characters" (page 66).)

- 3 Press (stitch selection keys) to select pattern No. 03.

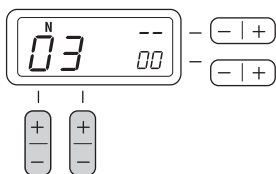

- For details, refer to step 3 of "Selecting a stitch" (page 28).

- 4 Press the "+" side of (stitch width adjustment key) to enter the selected character.

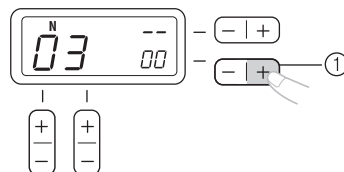

- ① Stitch width adjustment key

- ▶ The following display is shown on the LCD.

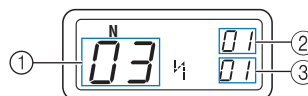

- ① Selected pattern No.
- ② The position of the selected pattern No.
- ③ The total number of entered characters

- 5 Attach the presser foot indicated on the LCD.

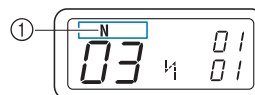

- ① The presser foot to use
- For details, refer to "Replacing the presser foot" (page 25).

- 6 If you would like to only sew this single character, start sewing.  
If you would like to sew a sequence of characters, go to step 1 on "Combining characters" (page 65).

- For details on sewing characters, refer to "Sewing the character stitches" (page 67).

## ■ Combining characters

You can easily sew names, messages, etc. by combining the character stitches. Up to 35 characters can be combined.

**[Example] Selecting stitches "COME"**  
(No. 03)+(No. 15)+(No. 13)+(No. 05)

**1** Follow steps **1** through **5** in "Selecting a character" (page 64) to select the first character "C" (No. 03).

**2** Press  (stitch selection keys) to select the next character, "O" (No. 15).

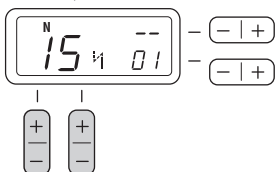

**3** Press the "+" side of  (stitch width adjustment key) to enter the selected character.

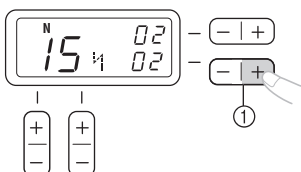

① Stitch width adjustment key

**4** Repeat steps **2** and **3** to add "M" (No. 13) and "E" (No. 05).

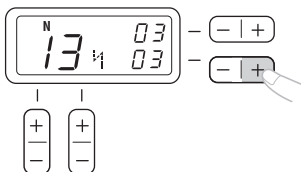

### Memo

- To enter a space, select " \_ " (No. 30).

**5** When you have finished combining characters, check the entered characters and their order.

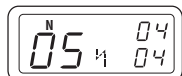

- For details on checking characters, refer to "Checking characters" (page 66).

### Memo

- A new character can only be added next to the last character. You cannot insert a new character between characters or before the first character of the sequence.

**6** After checking the entered characters, start sewing.

- For details on sewing characters, refer to "Sewing the character stitches" (page 67).

### Memo

- The combination of characters will be stored in memory even if you turn off the machine.

## ■ Adding new characters after sewing

After sewing a combination of characters, you can add characters to the combination using the following method.

### Memo

- When you have finished sewing, the pattern No. of the first character in the current combination is shown on the LCD.

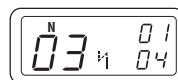

**1** Press the utility stitch key.

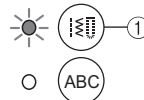

① Utility stitch key

**2** Press the character stitch key.

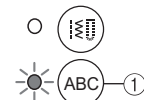

① Character stitch key

**3** Add new characters by following the procedure described in "Combining characters" (page 65).

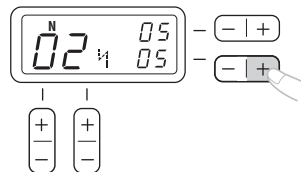

- ▶ New characters are added next to the last character of the combination.

■ Making a new combination of characters after sewing

 **Memo**

- When you have finished sewing, the pattern No. of the first character in the current combination is shown on the LCD.

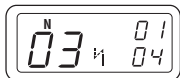

**1** Select the first character of the new combination.

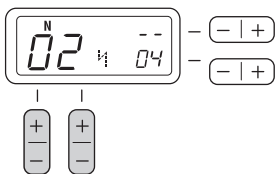

**2** Press the "+" side of  (stitch width adjustment key).

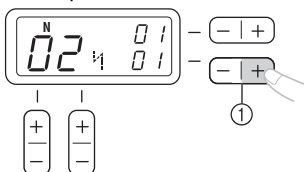

① Stitch width adjustment key

- ▶ The old combination of characters is cleared from memory, and the pattern No. shown in the LCD is entered as the first character of a new combination.

**3** Add characters by following the procedure described in "Combining characters" (page 65).

**Checking characters**

You can check the characters in a combination with following method.

**1** Press the "+" or "-" side of  (stitch length adjustment key) repeatedly.

This will display the characters that have been entered one by one on the LCD.

You can check the pattern No. and position of each character.

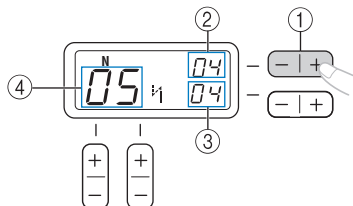

- ① Stitch length adjustment key
- ② The position of the selected pattern No.
- ③ The total number of characters in the combination
- ④ Selected pattern No.

**Deleting characters**

You can delete characters from the combination.

**1** Press "-" side of  (stitch width adjustment key) to delete the last character in the combination.

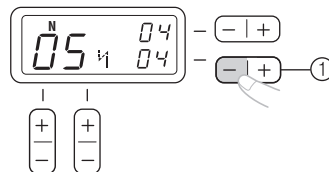

① Stitch width adjustment key

- ▶ The last character will be deleted.

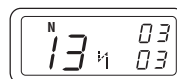

 **Memo**

- Repeat step **1** to delete more characters.
- You can only delete the last character in a combination.

## Sewing the character stitches

All character stitches are sewn with monogramming foot "N".

- 1 Select a character stitch.**
  - For details, refer to "Selecting characters" (page 64)

- 2 Attach monogramming foot "N".**

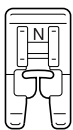

- For details, refer to "Replacing the presser foot" (page 25).

- 3 Start sewing.**

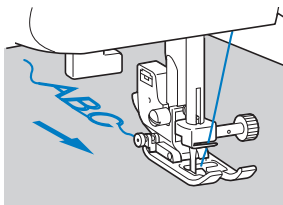

- ▶ The stitch is sewn in the direction indicated by the arrow.



### Memo

- When sewing characters, the machine automatically sews reinforcement stitches for each character.
- While sewing, the LCD shows the pattern No. currently being sewn.

- 4 When you have finished sewing, use scissors to trim off any excess threads at the beginning of the stitching and between the characters.**

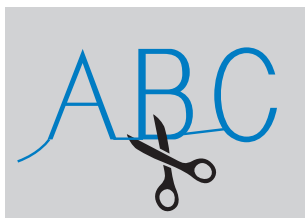

## ADJUSTING STITCHES (for models equipped with character stitches)

Your stitch pattern may sometimes turn out poorly, depending on the type or thickness of fabric, the stabilizer material used, sewing speed, etc. If your sewing does not turn out well, sew trial stitches using the same conditions as the real sewing, and adjust the stitch pattern as shown below.



### Memo

- The character stitches "034" (No. 31 + No. 34 + No. 35) are used for making adjustments.

### 1 Attach monogramming foot "N".

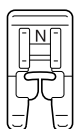

- For details, refer to "Replacing the presser foot" (page 25).

### 2 Combine the character stitches "034" (No. 31 + No. 34 + No. 35).

- For details, refer to "Combining characters" (page 65).
- ▶ When you have finished creating the combination, the following is displayed on the LCD.

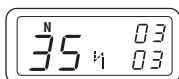

### 3 Sew the combination of characters and check how it turns out.

- For details, refer to "Sewing the character stitches" (page 67).

○ A

× B

× C

A: Correctly sewn  
(with proper spaces between characters)

B: Bunched or shapeless  
(There is no space between characters.)

C: Overstretched  
(The stitch "0" has a gap.)

If the pattern you sewed does not look like A, use the following steps to adjust the stitches.

### 4 Select No. 59 (for making adjustments).

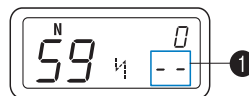

- ▶ The LCD goes into the stitch adjustment mode. The total number of combined characters (1) changes to "--".

### 5 Adjust the character stitches by pressing (stitch length adjustment key).

- Each press of "+" or "-" side of (stitch length adjustment key) widens or narrows the stitches.

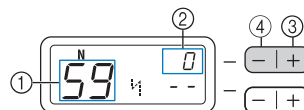

- ① No. for making adjustments
- ② The stitch adjustment level
- ③ Widens the stitches
- ④ Narrows the stitches

#### □ If the pattern is bunched (B)

- Press the "+" side of (stitch length adjustment key) to widen the stitch.

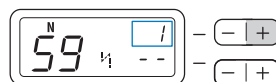

#### □ If the pattern is overstretched (The stitch "0" has a gap.) (C)

- Press the "-" side of (stitch length adjustment key) to narrow the stitch.

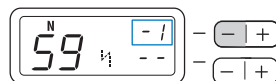

### Memo

- The stitch adjustment level can be set between -9 and 9.
- The setting is saved in memory even if you turn off the machine.

**6** Sew the characters "034" again.



**Memo**

- You can sew when you are in the stitch adjustment mode.

If the stitch pattern still comes out poorly, adjust the stitch again. Adjust the stitch until the stitch pattern comes out correctly.

**7** After you have finished adjusting the pattern, press the utility stitch key once, and then press the character stitch key.

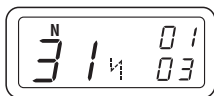

- ▶ The display returns to the normal character stitching mode.

# 4 APPENDIX

## MAINTENANCE

Simple sewing machine maintenance operations are described below.

### Cleaning the machine surface

If the surface of the machine is dirty, lightly soak a cloth in neutral detergent, squeeze it out firmly, and then wipe the surface of the machine. After cleaning it once with a wet cloth, wipe it again with a dry cloth.

#### CAUTION

- Unplug the power supply cord before cleaning the machine, otherwise injuries or an electric shock may occur.

### Cleaning the bobbin case

Sewing performance will suffer if dust collects in the bobbin case; therefore, it should be cleaned periodically.

#### CAUTION

- Make sure you unplug the machine before you clean it. Otherwise, you may get an electric shock or be injured.

- 1 Switch the machine off and unplug it.
- 2 Raise the needle and the presser foot.
- 3 Loosen the presser-foot screw and the needle clamp screw to remove the presser-foot holder and the needle.

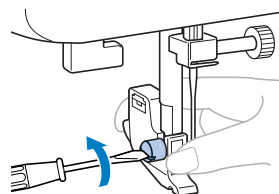

- 4 Grasp both sides of the needle plate cover, and then slide it toward you to remove the needle plate cover.

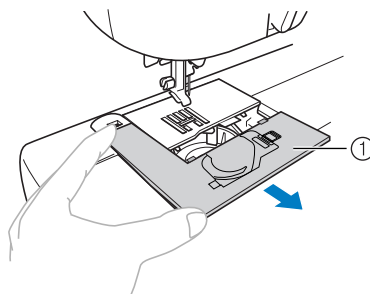

① Needle plate cover



- 5** Remove the bobbin case.  
Grasp the bobbin case, and then pull it out.

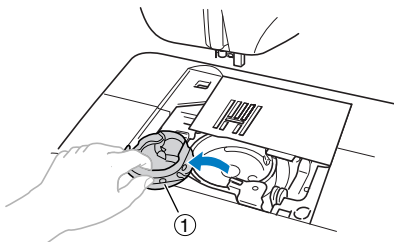

① Bobbin case

- 6** Use the cleaning brush or a vacuum cleaner to remove any dust from the race and its surrounding area.

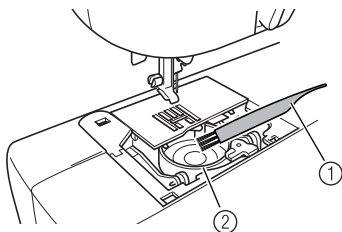

① Cleaning brush  
② Race

- Do not put oil on the bobbin case.

- 7** Insert the bobbin case so that the projection on the bobbin case aligns with the spring.

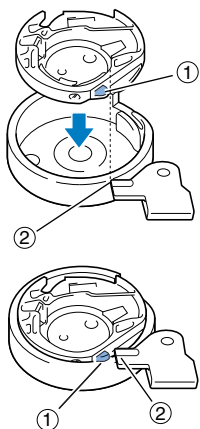

① Projection  
② Spring

- 8** Put the tabs on the needle plate cover into the needle plate, and then slide the cover back on.

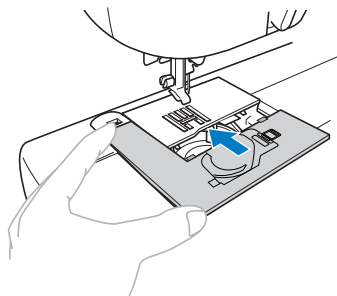

**! CAUTION**

- Never use a bobbin case that is scratched, otherwise the upper thread may become tangled, the needle may break or sewing performance may suffer. For a new bobbin case (part code: XC3152-021), contact your nearest authorized service center.
- Make sure that you fit the bobbin case properly, otherwise the needle may break.



## TROUBLESHOOTING

If the machine stops operating correctly, check the following possible problems before requesting service. You can solve most problems by yourself. If you need additional help, the Brother Solutions Center offers the latest FAQs and troubleshooting tips. Visit us at [<http://solutions.brother.com>].

If the problem persists, contact your dealer or the nearest authorized service center.

Symptom	Possible cause	How to put it right	Reference
<b>The sewing machine does not work.</b>	The machine is not plugged in.	Plug the machine in.	page 9
	The main power switch is turned off.	Turn on the main power switch.	page 9
	The bobbin winder shaft is pushed to the right.	Move the bobbin winder shaft to the left.	page 13, 14
	You have not used the foot controller properly.	Use the foot controller properly.	page 10
<b>The needle breaks.</b>	The needle is not fitted properly.	Fit the needle properly.	page 22
	The needle clamp screw is loose.	Use the screwdriver to firmly tighten the screw.	page 23
	The needle is bent or blunt.	Replace the needle.	page 22
	You have not used the right combination of fabric, thread and needle.	Choose a thread and needle that are appropriate for the type of fabric.	page 21
	The presser foot you are using is not appropriate for the type of stitch that you want to sew.	Attach the presser foot that is correct for the type of stitch that you want to sew.	page 35
	The upper thread tension is too tight.	Loosen the upper thread tension.	page 31
	You are pulling the fabric too much.	Lightly guide the fabric.	–
	The area around the hole in the needle plate is scratched.	Replace the needle plate. Contact your retailer or the nearest authorized service center.	–
	The area around the hole in the presser foot is scratched.	Replace the presser foot. Contact your retailer or the nearest authorized service center.	–
	The bobbin case is scratched.	Replace the bobbin case. Contact your retailer or the nearest authorized service center.	–
	You have not used a bobbin that has been designed for this machine.	Incorrect bobbins will not work properly. Only use a bobbin that has been designed for this machine.	page 12
<b>The upper thread breaks.</b>	You have not threaded the upper thread properly. (for example, you have not fitted the spool properly, or the thread has come out of the guide above the needle.)	Correct the upper threading.	page 17
	There are knots or tangles in the thread.	Remove any knots or tangles.	–
	The needle is not appropriate for the thread you are using.	Choose a needle that is appropriate for the type of stitch.	page 21
	The upper thread tension is too tight.	Loosen the upper thread tension.	page 31
	The thread is tangled, for example, in the bobbin case.	Remove the tangle thread. If the thread is tangled in the bobbin case, clean the bobbin case.	page 70
	The needle is bent or blunt.	Replace the needle.	page 22

Symptom	Possible cause	How to put it right	Reference
<b>The upper thread breaks.</b>	You have not inserted the needle properly.	Insert the needle properly.	page 22
	The area around the hole in the needle plate is scratched.	Replace the needle plate. Contact your retailer or the nearest authorized service center.	–
	The area around the hole in the presser foot is scratched.	Replace the presser foot. Contact your retailer or the nearest authorized service center.	–
	The bobbin case is scratched, or has a burr on it.	Replace the bobbin case. Contact your retailer or the nearest authorized service center.	–
	You have not used a bobbin that has been designed for this machine.	Incorrect bobbins will not work properly. Only use a bobbin that has been designed for this machine.	page 12
<b>The lower thread is tangled or breaks.</b>	You have not wound the bobbin thread properly.	Wind the bobbin thread properly.	page 12
	The bobbin is scratched or does not turn smoothly.	Replace the bobbin.	–
	The thread is tangled.	Remove the tangled thread and clean the bobbin case.	page 70
	You have not used a bobbin that has been designed for this machine.	Incorrect bobbins will not work properly. Only use a bobbin that has been designed for this machine.	page 12
	Bobbin is set incorrectly.	Reset the bobbin thread correctly.	page 15, 16
<b>The thread is tangled on the wrong side of the fabric.</b>	The upper thread was not threaded correctly.	Correct the upper threading.	page 17
<b>The thread tension is incorrect.</b>	You have not threaded the upper thread properly.	Correct the upper threading.	page 17
	You have not wound the bobbin thread properly.	Wind the bobbin thread properly.	page 12
	You have not threaded the right combination of thread and needle for the fabric you are using.	Choose a thread and needle that are appropriate for the type of fabric.	page 21
	You have not attached the presser foot holder properly.	Attach the presser foot holder properly.	page 26
	The thread tension is incorrect.	Adjust the tension of the upper thread.	page 31
	You have not used a bobbin that has been designed for this machine.	Incorrect bobbins will not work properly. Only use a bobbin that has been designed for this machine.	page 12
	Bobbin is set incorrectly.	Reset the bobbin thread correctly.	page 15, 16
<b>The upper thread is too tight.</b>	The bobbin thread is incorrectly installed.	Correctly install the bobbin thread.	page 15
<b>The fabric is wrinkled.</b>	You have not threaded the upper thread properly or fitted the bobbin properly.	Thread the upper thread and wind the bobbin thread properly.	page 15, 16, 17
	You have not fitted the spool properly.	Fit the spool properly.	–
	You have not used the right combination of fabric, thread and needle.	Choose a thread and needle that are appropriate for the type of fabric.	page 21
	The needle is bent or blunt.	Replace the needle.	page 22

Symptom	Possible cause	How to put it right	Reference
<b>The fabric is wrinkled.</b>	If you are sewing thin fabric, the stitch is too thick.	Sew with stabilizer material under the fabric.	page 34
	The thread tension is incorrect.	Adjust the tension of the upper thread.	page 31
<b>Stitches are skipped.</b>	You have not threaded the upper thread properly.	Correct the upper threading.	page 17
	You have not used the right combination of fabric, thread and needle.	Choose a thread and needle that are appropriate for the type of fabric.	page 21
	The needle is bent or blunt.	Replace the needle.	page 22
	You have not inserted the needle properly.	Insert the needle properly.	
	Dust has accumulated under the needle plate or in the bobbin case.	Remove the needle plate cover and clean the plate and the bobbin case.	page 70
<b>There is a high-pitched noise while sewing.</b>	Dust has built up in the feed dogs or in the bobbin case.	Clean the bobbin case.	page 70
	You have not threaded the upper thread properly.	Correct the upper threading.	page 17
	The bobbin case is scratched.	Replace the bobbin case. Contact your retailer or the nearest authorized service center.	–
	You have not used bobbin that has been designed for this machine.	Incorrect bobbins will not work properly. Only use a bobbin that has been designed for this machine.	page 12
<b>The needle threader can not be used.</b>	You have not moved the needle holder to its highest position.	Raise the needle either by turning the handwheel toward you (counterclockwise) so that the mark on the wheel points up or by pressing  (needle position button) once or twice.	page 17
	You have not inserted the needle properly.	Insert the needle properly.	page 22
<b>The stitch is not sewn correctly.</b>	The presser foot that you are using is not correct for the type of stitch.	Attach the presser foot that is correct for the type of stitch that you want to sew.	page 35
	The thread tension is incorrect.	Adjust the tension of the upper thread.	page 31
	The thread is tangled, for example, in the bobbin case.	Remove the tangled thread. If the thread is tangled in the bobbin case, clean the bobbin case.	page 70
	The stitch adjustment level is incorrect.	Adjust the stitch.	page 68
<b>The fabric does not feed.</b>	The feed dogs are lowered.	Slide the feed dog position lever to  .	page 49, 56
	The stitch is too fine.	Lengthen the stitch length.	page 28
	You have not used the right combination of fabric, thread and needle.	Choose a thread and needle that are appropriate for the type of fabric.	page 21
	The thread is tangled, for example, in the bobbin case.	Remove the tangle thread. If the thread is tangled in the bobbin case, clean the bobbin case.	page 70
<b>The sewing light bulb does not come on.</b>	The sewing lamp is damaged.	Contact your retailer or the nearest authorized service center.	–

## ERROR MESSAGES

If an operation is performed incorrectly before the sewing machine is set up, an error message appears on the operation panel. Follow the instructions indicated in the table.

If you press the stitch selection key or do the operation correctly while the error message is displayed, the message disappears.

Error Message	Probable Cause	Solution
E1	The foot controller was pressed (or the start/stop button was pressed if the foot controller is not connected) and the reverse/reinforcement stitch button was pressed while the presser foot is raised.	Lower the presser foot lever before continuing the operation.
E2	A stitch other than the buttonhole or bar tack stitch was selected and the foot controller was pressed (or the start/stop button was pressed if the foot controller is not connected) while the buttonhole lever is lowered.	Raise the buttonhole lever before continuing the operation.
E3	The buttonhole or bar tack stitch was selected and the foot controller was pressed (or the start/stop button was pressed if the foot controller is not connected) while the buttonhole lever is raised.	Lower the buttonhole lever before continuing the operation.
E4	The reverse/reinforcement stitch button or needle position button was pressed while the bobbin winder shaft is moved to the right.	Move the bobbin winder shaft to the left before continuing the operation.
E5	The start/stop button was pressed while the foot controller was connected.	Disconnect the foot controller, and then press the start/stop button. Otherwise, operate the machine by using the foot controller.
E6	The motor locked up because the thread is tangled.	Remove the tangled thread before continuing the operation.



### Note

- If error message “F1” through “F9” appears in the LCD while the sewing machine is being used, the machine may be malfunctioning. Contact your nearest authorized service center.

## Operation beep (for models equipped with the operation beep)

Each time a key is pressed you will hear one beep. If a non-functioning key is pressed or an incorrect operation is performed you will hear two or four beeps (only for models equipped with the operation beep).

### ■ If a key is pressed (correct operation)

One beep sounds.

### ■ If an incorrect operation is performed or a non-functioning key is pressed

Two or four beeps sound.

### ■ If the machine locks up, for example, because the thread is tangled

The sewing machine beeps for four seconds and the machine automatically stops. Be sure to check for the cause of the error, and correct it before continuing to sew.

## INDEX

**Numerics**

3-point zigzag stitch ..... 42

**A**

accessories ..... 8  
 adjusting stitches ..... 68  
 appliqués ..... 53

**B**

bar tack ..... 57  
 basic stitching ..... 43  
 blind hem stitching ..... 44  
 bobbin ..... 15  
 bobbin case ..... 70  
 bobbin cover ..... 6, 15  
 bobbin winder ..... 12, 72, 75  
 button sewing ..... 49  
 buttonhole foot ..... 47  
 buttonhole lever ..... 6, 48, 58  
 buttonhole sewing ..... 46

**C**

character stitch indicator ..... 7, 64  
 character stitch key ..... 7, 64  
 checking characters ..... 66  
 combining characters ..... 65  
 crazy quilt stitching ..... 54

**D**

darning ..... 42, 52  
 deleting characters ..... 66

**E**

elastic tape ..... 52  
 error messages ..... 75  
 extra spool pin ..... 24  
 eyelet punch ..... 48

**F**

fagoting ..... 60  
 feed dog position lever ..... 56  
 feed dogs ..... 6, 56  
 flat bed attachment ..... 7, 34  
 foot controller ..... 8, 30  
 free-arm style ..... 34  
 free-motion quilting ..... 56

**H**

handwheel ..... 5  
 heirloom stitching ..... 63  
 hook-and-loop fastener ..... 33

**J**

joining ..... 62  
 joining stitch ..... 53, 59

**M**

main parts ..... 5  
 main power switch ..... 9  
 monogramming ..... 61, 63

**N**

needle ..... 21  
 needle bar thread guide ..... 6  
 needle clamp screw ..... 6, 23  
 needle plate ..... 6  
 needle plate cover ..... 70  
 needle position ..... 43  
 needle position button ..... 6  
 needle threader ..... 18

**O**

openings ..... 57  
 operation beep ..... 11, 75  
 operation buttons ..... 6  
 operation panel ..... 7  
 optional accessories ..... 8  
 overcasting stitches ..... 42

**P**

patchwork stitching ..... 54  
 piecing ..... 54  
 pocket corners ..... 57  
 presser foot ..... 6, 25  
 presser foot holder ..... 6, 26  
 presser foot lever ..... 6, 17  
 pre-tension disk ..... 12

**Q**

quick-set bobbin ..... 6, 16  
 quilting ..... 55  
 quilting foot ..... 56  
 quilting guide ..... 55

**R**

reinforcement stitching ..... 57  
 reverse/reinforcement stitch button ..... 6

**S**

scallop stitching ..... 61  
 seam ripper ..... 48  
 sewing machine needles ..... 21  
 sewing speed controller ..... 6  
 sewing the character stitches ..... 67  
 sleeve holes ..... 57  
 smocking ..... 61  
 spool pin ..... 12, 17  
 start/stop button ..... 6, 30  
 stitch length ..... 28  
 stitch selection key ..... 7, 28, 65  
 stitch width ..... 28  
 straight stitch ..... 43  
 stretch fabrics ..... 34

<b>T</b>	
thick fabrics.....	32
thin fabrics .....	34
thread cutter.....	30
thread guide .....	17
thread tension .....	31
trial sewing.....	32
triple stretch stitch .....	43
troubleshooting .....	72
twin needle .....	24

<b>U</b>	
upper tension-control dial .....	31
upper threading.....	17
utility stitch indicator.....	7, 28
utility stitch key .....	7, 28

<b>W</b>	
walking foot .....	55
wing needle .....	63

<b>Z</b>	
zigzag stitch .....	32, 42, 53
zipper foot.....	51
zipper Insertion .....	51



