



Multi-Protocol On-board Ethernet Multi-function Print Server

# NETWORK USER'S GUIDE

MFC-9440CN  
DCP-9040CN  
DCP-9045CDN

Please read this manual thoroughly before using this machine on your network. You can view this manual in HTML format from the CD-ROM at any time, please keep the CD-ROM in a convenient place for quick and easy reference at all times. You can also download the manual in PDF format from the Brother Solutions Center (<http://solutions.brother.com>).

The Brother Solutions Center (<http://solutions.brother.com>) is your one stop resource for all your printing needs. Download the latest drivers and utilities for your machine, read FAQs and troubleshooting tips or learn about special printing solutions.

## Definitions of warnings, cautions, and notes

We use the following icon throughout this User's Guide:



Notes tell you how you should respond to a situation that may arise or give tips about how the operation works with other features.

## Trademarks

Brother and the Brother logo are registered trademarks and BRAdmin Professional is a trademark of Brother Industries, Ltd.

UNIX is a registered trademark of The Open Group.

Apple and Macintosh are registered trademarks of Apple Computer, Inc.

HP, Hewlett-Packard, Jetdirect and PCL are registered trademarks of Hewlett-Packard Company.

PostScript is a registered trademark of Adobe Systems Incorporated.

Microsoft, Windows and Windows Server are registered trademarks of Microsoft Corporation in the U.S. and other countries.

Windows Vista is a trademark of Microsoft Corporation in the U.S. and other countries.

Firefox is a registered trademark of the Mozilla Foundation.

All other terms, brand and product names mentioned in this User's Guide are registered trademarks or trademarks of their respective companies.

## Compilation and publication notice

Under the supervision of Brother Industries Ltd., this manual has been compiled and published, covering the latest product's descriptions and specifications.

The contents of this manual and the specifications of this product are subject to change without notice.

Brother reserves the right to make changes without notice in the specifications and materials contained herein and shall not be responsible for any damages (including consequential) caused by reliance on the materials presented, including but not limited to typographical and other errors relating to the publication.

©2007 Brother Industries Ltd.

## IMPORTANT NOTE

- Windows® XP in this document represents Windows® XP Professional, Windows® XP Professional x64 Edition and Windows® XP Home Edition.
- Windows® Server 2003 in this document represents Windows® Server 2003 and Windows® Server 2003 x64 Edition. Go to the Brother Solutions Center (<http://solutions.brother.com>) for more information on Windows® Server 2003 x64 Edition support.

# Brother numbers

## IMPORTANT

For technical and operational assistance, you must call the country where you purchased the machine. Calls must be made **from within** that country.

## For Customer Service

**In USA** 1-800-284-4329  
**In Canada** 1-877-BROTHER  
**In Europe** Visit <http://www.brother.com> for contact information on your local Brother office.

■ Service center locator (USA)

For the location of a Brother authorized service center, call 1-800-284-4357.

■ Service center locations (Canada)

For the location of a Brother authorized service center, call 1-877-BROTHER.

If you have any comments or suggestions, please write to us at:

<b>In USA</b>	Customer Support Brother International Corporation 100 Somerset Corporate Boulevard Bridgewater NJ 08807-0911
<b>In Canada</b>	Brother International Corporation (Canada), Ltd. - Marketing Dept. 1, rue Hôtel de Ville Dollard-des-Ormeaux, PQ, Canada H9B 3H6
<b>In Europe</b>	European Product & Service Support 1 Tame Street Audenshaw Manchester, M34 5JE, UK

## Internet address

Brother Global Web Site: <http://www.brother.com>

For Frequently Asked Questions (FAQs), Product Support, Driver Updates and Utilities:  
<http://www.brother.com>

(In USA Only) For Brother Accessories & Supplies: <http://www.brothermall.com>

## **Brother fax-back system (USA)**

---

Brother has set up an easy-to-use fax-back system so you can get instant answers to common technical questions and information about all our products. This is available 24 hours a day, seven days a week. You can use the system to send the information to any fax machine.

Call the number below and follow the recorded instructions to receive a fax about how to use the system and an Index of the subjects you can get information about.

**In USA only**

1-800-521-2846

# Table of Contents

<b>1</b>	<b>Introduction</b>	<b>1</b>
	Overview.....	1
	Network function features.....	2
	Network printing.....	2
	Network scanning.....	2
	Network PC Fax (Not available for DCP models).....	2
	Management utilities.....	2
	Types of Network Connections.....	4
	Network Connection Example.....	4
	Protocols.....	6
	TCP/IP protocols and functions.....	6
<b>2</b>	<b>Configuring your network printer</b>	<b>8</b>
	Overview.....	8
	IP addresses, subnet masks and gateways.....	8
	IP address.....	8
	Subnet mask.....	9
	Gateway (and router).....	9
	Setting the IP address and subnet mask.....	10
	Using the BRAdmin Light utility to configure your machine for the network printer.....	10
	Using the control panel to configure your machine for a network.....	12
	Using other methods to configure your machine for a network.....	12
	Changing the print server settings.....	13
	Using the BRAdmin Light utility to change the print server settings.....	13
	Using the control panel to change the print server settings.....	13
	Using Web Based Management (web browser) to change the print/scan settings.....	14
	Using the Remote Setup to change the print server settings (for Windows® and Mac OS® X 10.2.4 or greater) (for MFC-9440CN).....	15
<b>3</b>	<b>Control panel setup</b>	<b>16</b>
	LAN menu.....	16
	TCP/IP.....	16
	Ethernet.....	24
	Scan to FTP.....	24
	Printing the Network Configuration List.....	25
	Restoring the network settings to factory default.....	26
<b>4</b>	<b>Driver Deployment Wizard (Windows® only)</b>	<b>27</b>
	Overview.....	27
	Connection methods.....	27
	Peer-to-Peer.....	27
	Network Shared.....	28
	How to install the Driver Deployment Wizard software.....	29
	Using the Driver Deployment Wizard software.....	30

<b>5</b>	<b>Network printing from Windows®: basic TCP/IP Peer-to-Peer printing</b>	<b>32</b>
	Overview.....	32
	For Windows® users (Windows® 2000/XP, Windows Vista™ and Windows Server® 2003) .....	32
	Configuring the standard TCP/IP port .....	32
	Other sources of information .....	33
<b>6</b>	<b>Internet printing for Windows®</b>	<b>34</b>
	Overview.....	34
	IPP printing for Windows® 2000/XP, Windows Vista™ and Windows Server® 2003 .....	34
	For Windows Vista™ .....	34
	For Windows® 2000/XP and Windows Server® 2003 .....	36
	Specifying a different URL.....	38
	Other sources of information .....	38
<b>7</b>	<b>Network printing from Macintosh®</b>	<b>39</b>
	Overview.....	39
	How to select the BR-Script 3 printer driver (TCP/IP).....	39
	Other sources of information .....	41
<b>8</b>	<b>Web Based Management</b>	<b>42</b>
	Overview.....	42
	How to connect to your machine using a Browser.....	43
	Password information .....	43
	Changing the Scan to FTP configuration using a Browser (for MFC-9440CN) .....	43
<b>9</b>	<b>Security features</b>	<b>44</b>
	Overview.....	44
	Security terms.....	44
	Security protocols .....	45
	Security methods for E-mail notification .....	45
	Configuring the protocol settings .....	46
	Managing your network printer securely.....	47
	Secure Management using Web Based Management (web browser) .....	47
	Secure Management using BRAdmin Professional (for Windows®) .....	48
	Printing documents securely using IPPS.....	49
	Specifying a different URL.....	49
	Using E-mail notification with user authentication .....	50
	Creating and installing a certificate.....	52
	Creating and installing a self-signed certificate .....	54
	Creating CSR and installing a certificate .....	66
	Import and export the certificate and private key.....	68

<b>10</b>	<b>Troubleshooting</b>	<b>70</b>
	Overview .....	70
	General problems .....	70
	Network print software installation problems .....	71
	Printing problems .....	72
	Scanning and PC Fax problems .....	74
	Protocol-specific troubleshooting .....	76
	Windows® 2000/XP, Windows Vista™, Windows Server® 2003 IPP troubleshooting .....	76
	Web browser troubleshooting (TCP/IP) .....	76
<b>A</b>	<b>Appendix A</b>	<b>77</b>
	Using services .....	77
	Other ways to set the IP address (for advanced users and administrators) .....	77
	Using DHCP to configure the IP address .....	77
	Using BOOTP to configure the IP address .....	78
	Using RARP to configure the IP address .....	79
	Using APIPA to configure the IP address .....	79
	Using ARP to configure the IP address .....	79
	Using the Telnet console to configure the IP address .....	81
	Installation when using a Network Print Queue or Share (printer driver only) .....	82
<b>B</b>	<b>Appendix B</b>	<b>83</b>
	Print server specifications .....	83
	Ethernet wired network .....	83
	Function table and default factory settings .....	86
	Entering Text .....	88
<b>C</b>	<b>Index</b>	<b>90</b>



# 1 Introduction

## Overview

The Brother machine can be shared on a 10/100 Mb wired Ethernet network using the internal network print server. The print server supports various functions and methods of connection depending on the operating system you are running on a network supporting TCP/IP. These functions include printing, scanning, PC Fax send, PC Fax receive, Remote Setup and Status Monitor. The following chart shows what network features and connections are supported by each operating system.

Operating Systems	Windows® 2000	Windows Server® 2003	Mac OS® X 10.2.4 or greater
	Windows® XP Windows® XP Professional x64 Edition Windows Vista™	Windows Server® 2003 x64 Edition	
10/100BASE-TX Wired Ethernet (TCP/IP)	✓	✓	✓
Printing	✓	✓	✓
BRAdmin Light	✓	✓	✓
BRAdmin Professional <sup>1</sup>	✓	✓	
Web BRAdmin	✓	✓	
Web Based Management (web browser)	✓	✓	✓
Internet Printing (IPP)	✓	✓	
Scanning	✓		✓
PC Fax Send <sup>2</sup>	✓		✓
PC Fax Receive <sup>2</sup>	✓		
Remote Setup	✓		✓
Status Monitor	✓	✓	✓
Driver Deployment Wizard	✓	✓	

<sup>1</sup> BRAdmin Professional is available as a download from <http://solutions.brother.com>.

<sup>2</sup> PC Fax Send, PC Fax Receive and Remote Setup functions are not available for DCP-9040CN and DCP-9045CDN.

To use the Brother machine through a network, you need to configure the print server, and set up the computers you use.

## Network function features

Your Brother machine has the following basic network functions.

### Network printing

---

The print server provides printing services for Windows® 2000/XP, Windows Vista™ and Windows Server® 2003 supporting the TCP/IP protocols and Macintosh® (Mac OS® X 10.2.4 or greater) supporting the TCP/IP protocols.

### Network scanning

---

You can scan documents over the network to your computer (See *Network Scanning* in the Software User's Guide).

### Network PC Fax (Not available for DCP models)

---

You can directly send a PC file as a PC Fax over your network (See *Brother PC-FAX Software for Windows® and Sending a Fax for Macintosh®* in the Software User's Guide for a complete description). Windows® users can also PC Fax receive (See *PC-FAX receiving* in the Software User's Guide).

### Management utilities

---

#### BRAdmin Light

BRAdmin Light is a utility for initial setup of the Brother network connected devices. This utility can search for Brother product on your network, view the status and configure basic network settings, such as IP address from a computer running Windows® systems and Mac OS® X 10.2.4 or greater. For installing BRAdmin Light on Windows®, please see the Quick Setup Guide we provided with the machine. For Macintosh® users, BRAdmin Light will be installed automatically when you install the printer driver. If you have already installed the printer driver, you don't have to install it again.

For more information on BRAdmin Light, visit us at <http://solutions.brother.com>.

#### BRAdmin Professional (for Windows®)

BRAdmin Professional is a utility for more advanced management of network connected Brother devices. This utility can search for Brother products on your network, view the status and configure the network settings from a computer running Windows® system. BRAdmin Professional has additional features from BRAdmin Light.

For more information and downloading, visit us at <http://solutions.brother.com>.

## Web BRAdmin (for Windows®)

Web BRAdmin is a utility for managing network connected Brother devices on your LAN and WAN. This utility can search for Brother product on your network, view its status and configure the network settings. Unlike BRAdmin Professional, which is designed for Windows® only, the Web BRAdmin server utility can be accessed from any client PC with a web browser that supports JRE (Java Runtime Environment). By installing the Web BRAdmin server utility on a PC running IIS <sup>1</sup>, administrators with a web browser can connect to the Web BRAdmin server, which then communicates with the device itself.

For more information and downloading, visit us at <http://solutions.brother.com>.

<sup>1</sup> Internet Information Server 4.0 or Internet Information Service 5.0/5.1

## Remote Setup (Not available for DCP models)

The Remote Setup software allows you to configure network settings from a Windows® or Macintosh® (Mac OS® X 10.2.4 or greater). (See *Remote Setup for Windows®* in the Software User's Guide).

## Web Based Management (web browser)

The Web Based Management allows you to monitor Brother printer's status or change some of its configuration settings.



### Note

---

We recommend Microsoft Internet Explorer 6.0® (or higher) or Firefox® 1.0 (or higher) for Windows® and Safari™ 1.0 for Macintosh®. Please also make sure that JavaScript and Cookies are always enabled in whichever browser you use. We recommend you upgrade to Safari™ 1.2 or higher to enable JavaScript. If a different web browser is used, make sure it is compatible with HTTP 1.0 and HTTP 1.1.

---

# Types of Network Connections

## Network Connection Example

Generally there are two types of network connections. Peer-to-Peer and Network Shared environment.

### Peer-to-Peer printing using TCP/IP

In a Peer-to-Peer environment, each computer directly sends and receives data to each device. There is no central server controlling file access or printer sharing.

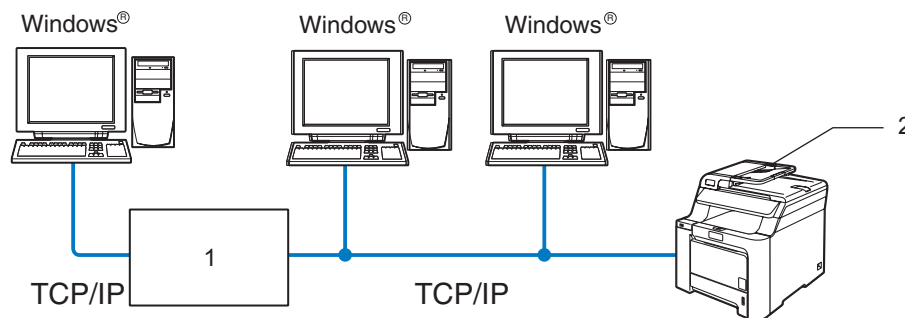

#### 1 Switch or Router

#### 2 Network printer (your machine)

- In a smaller network of 2 or 3 computers, we recommend the Peer-to-Peer printing method as it is easier to configure than the Network Shared Printing method described on the following page. See *Network Shared Printing* on page 5.
- Each computer must use the TCP/IP Protocol.
- The Brother machine needs to have an appropriate IP address configuration.
- If you are using routers, the Gateway address must be configured on the computers and the Brother machine.
- The Brother machine can also communicate with Macintosh®. (TCP/IP compatible operating systems)

## Network Shared Printing

In a Network Shared environment, each computer sends data via a centrally controlled computer. This type of computer is often called a “Server” or a “Print Server”. Its job is to control the printing of all print jobs.

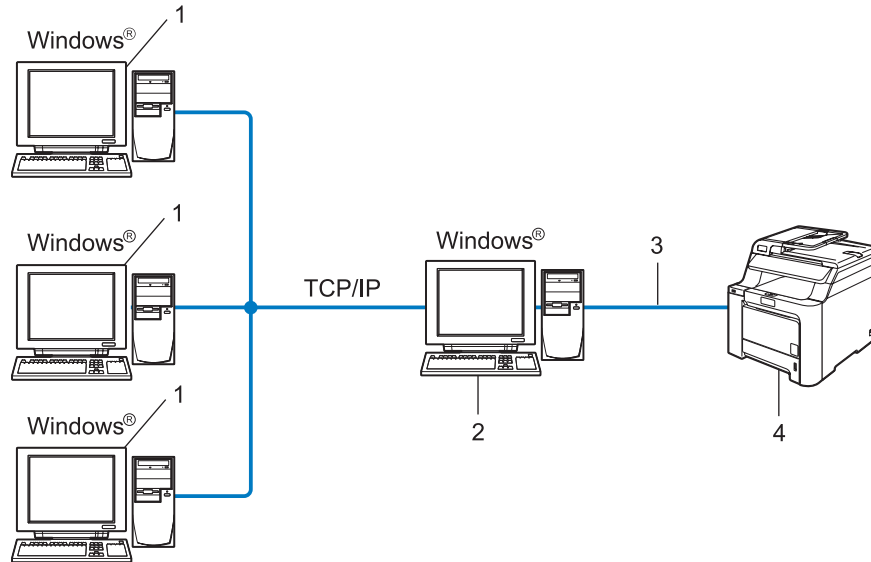

- 1 Client computer
- 2 Also known as “Server” or “Print Server”
- 3 TCP/IP or USB (where available)
- 4 Printer (your machine)

- In a larger network, we recommend a Network Shared printing environment.
- The “Server” or the “Print Server” must use the TCP/IP Print Protocol.
- The Brother machine needs to have an appropriate IP address configuration unless the machine is connected via the USB interface at the server.

# Protocols

## TCP/IP protocols and functions

---

Protocols are the standardized sets of rules for transmitting data on a network. Protocols allow users to gain access to network connected resources.

The print server used on this Brother product supports the TCP/IP (Transmission Control Protocol/Internet Protocol) protocols.

TCP/IP is the most popular set of protocols used for communication such as Internet and E-mail. This protocol can be used in almost all operating systems such as Windows<sup>®</sup>, Macintosh<sup>®</sup> and Linux.

The following TCP/IP protocols are available on this Brother product.



### Note

---

- You can configure the protocol settings by using the HTTP (web browser). See *Using Web Based Management (web browser) to change the print/scan settings* on page 14.
  - For the protocols of security features, see *Security protocols* on page 45.
- 

## DHCP/BOOTP/RARP

By using the DHCP/BOOTP/RARP protocols, the IP address can be automatically configured.



### Note

---

To use the DHCP/BOOTP/RARP protocols, please contact your network administrator.

---

## APIPA

If you do not assign an IP address manually (using the control panel of the machine or the BRAdmin software) or automatically (using a DHCP/BOOTP/RARP server), the Automatic Private IP Addressing (APIPA) protocol will automatically assign an IP address from the range 169.254.1.0 to 169.254.254.255.

## DNS client

The Brother print server supports the Domain Name Service (DNS) client function. This function allows the print server to communicate with other devices by using its DNS name.

## LPR/LPD

Commonly used printing protocols on a TCP/IP network.

## SMTP client

Simple Mail Transfer Protocol (SMTP) client is used to send E-mails via Internet or Intranet.

## Port9100

Another commonly used printing protocol on a TCP/IP network.

## IPP

The Internet Printing Protocol (IPP Version 1.0) allows you to print documents directly to any accessible printer via the internet.

## mDNS

mDNS allows the Brother print server to automatically configure itself to work in a Mac OS® X Simple Network Configured system. (Mac OS® X 10.2.4 or greater).

## Telnet

The Brother print server supports Telnet server for command line configuration.

## SNMP

The Simple Network Management Protocol (SNMP) is used to manage network devices including computers, routers and Brother network ready machines in a TCP/IP network.

## Web server (HTTP)

The Brother print server is equipped with a built in web server that allows you to monitor its status or change some of its configuration settings.



### Note

---

We recommend Microsoft Internet Explorer 6.0® (or higher) or Firefox® 1.0 (or higher) for Windows® and Safari™ 1.0 for Macintosh®. Please also make sure that JavaScript and Cookies are always enabled in whichever browser you use. We recommend you upgrade to Safari™ 1.2 or higher to enable JavaScript. If a different web browser is used, make sure it is compatible with HTTP 1.0 and HTTP 1.1.

---

## FTP

The File Transfer Protocol (FTP) allows the Brother machine to scan black and white or color documents directly to an FTP server located locally on your network or on the internet.

## IPv6

This machine is compatible with the IPv6, the next generation internet protocol. For more information on the IPv6 protocol, visit <http://solutions.brother.com>.

## Overview

Before you can use your Brother machine on your network, you need to install the Brother software and also configure the appropriate TCP/IP network settings on the machine itself. To do this, we recommend that you use the automatic installer on the Brother CD-ROM as this will guide you through the software and network installation.

If you do not wish to use the automatic installer, or you do not understand some of the terms used by the automatic installer, refer to the remainder of this chapter for more information.



### Note

If you do not wish to, or are unable to use the automatic installer or any of Brother's software tools, you can also use the machine's control panel to change network settings. For more information, see *Control panel setup* on page 16.

## IP addresses, subnet masks and gateways

To use the machine in a networked TCP/IP environment, you need to configure its IP address and subnet mask. The IP address you assign to the print server must be on the same logical network as your host computers. If it is not, you must properly configure the subnet mask and the gateway address.

### IP address

An IP address is a series of numbers that identifies each device connected to a network. An IP address consists of four numbers separated by dots. Each number is between 0 and 255.

- Example: In a small network, you would normally change the final number.

192.168.1.1, 192.168.1.2, 192.168.1.3

### How the IP address is assigned to your print server:

If you have a DHCP/BOOTP/RARP server in your network (typically a UNIX<sup>®</sup>/Linux or Windows<sup>®</sup> 2000/XP, Windows Vista<sup>™</sup>, Windows Server<sup>®</sup> 2003 network) the print server will automatically obtain its IP address from the DHCP server and register its name with any RFC 1001 and 1002-compliant dynamic name services.



### Note

On smaller networks, the DHCP server may be the router.

For more information on DHCP, BOOTP and RARP, see *Using DHCP to configure the IP address* on page 77, *Using BOOTP to configure the IP address* on page 78 and *Using RARP to configure the IP address* on page 79.



If you do not have a DHCP/BOOTP/RARP server, the Automatic Private IP Addressing (APIPA) protocol will automatically assign an IP address from the range 169.254.1.0 to 169.254.254.255. For more information on APIPA, see *Using APIPA to configure the IP address* on page 79.

If the APIPA protocol is disabled, the IP address of a Brother print server is 192.0.0.192. However, you can easily change this IP address number to match with the IP address details of your network. For information on how to change the IP address, see *Setting the IP address and subnet mask* on page 10.

## Subnet mask

---

Subnet masks restrict network communication.

■ Example: Computer1 can talk to Computer 2

- Computer 1

IP Address: 192.168.1.2

Subnet Mask: 255.255.255.0

- Computer 2

IP Address: 192.168.1.3

Subnet Mask: 255.255.255.0



### Note

0 denotes that there is no limit to communication at this part of the address.

---

In the above example, we can communicate with anything that has an IP address that begins with 192.168.1.x.

## Gateway (and router)

---

A gateway is a network point that acts as an entrance to another network and sends data transmitted via the network to an exact destination. The router knows where to direct data that arrives at the gateway. If a destination is located at an external network, the router transmits data to the external network. If your network communicates with other networks, you may need to configure the Gateway IP address. If you do not know the Gateway IP address then contact your Network Administrator.

## Setting the IP address and subnet mask

### Using the BRAdmin Light utility to configure your machine for the network printer

#### BRAdmin Light

The BRAdmin Light utility is designed for initial setup of the Brother network connected devices. It also can search for Brother products in a TCP/IP environment, view the status and configure basic network settings, such as IP address. The BRAdmin Light utility is available for Windows® 2000/XP, Windows Vista™, Windows Server® 2003 and Mac OS® X 10.2.4 or greater.

#### How to configure your machine using the BRAdmin Light utility



#### Note

- Please use the BRAdmin Light utility version that was supplied on the CD-ROM of your Brother product. You can also download the latest Brother BRAdmin Light utility version from <http://solutions.brother.com>.
- If you require more advanced printer management, use the latest Brother BRAdmin Professional utility that is available as a download from <http://solutions.brother.com>. This utility is only available for Windows® users.
- If you are using personal Firewall software (e.g. Windows Firewall), disable it. Once you are sure that you can print, re-start your personal Firewall software.
- Node name: Node name appears in current BRAdmin Light. The default Node name of the network card in the printer is “BRNxxxxxx” (“xxxxxx” is the last six digits of Ethernet address.).
- The default password for Brother print server is “**access**”.

#### 1 Start the BRAdmin Light utility.

- For Windows® 2000/XP, Windows Vista™ and Windows Server® 2003 users

Click **Start / All Programs**<sup>1</sup> / **Brother / BRAdmin Light / BRAdmin Light**.

<sup>1</sup> **Programs** for Windows® 2000 users

- For Mac OS® X 10.2.4 or greater users

Double-click **Macintosh HD (Startup Disk) / Library / Printers / Brother / Utilities / BRAdmin Light.jar** file.

#### 2 BRAdmin Light will search for new devices automatically.

3 Double-click the unconfigured device.

Windows®

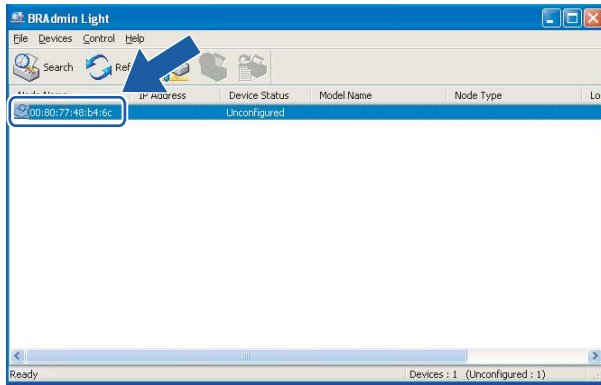

Macintosh®

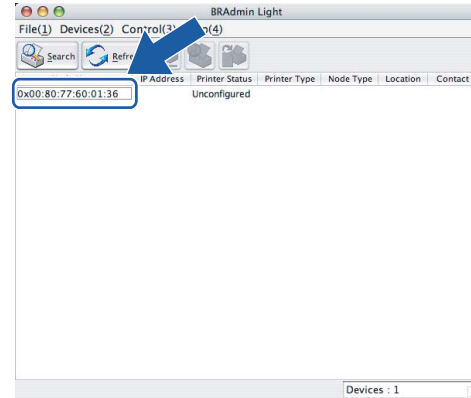

**Note**

- If the print server is set to its factory default settings without using a DHCP/BOOTP/RARP server, the device will appear as **Unconfigured** in the BRAdmin Light utility screen.
- You can find the node name and Ethernet address by printing the Network Configuration List. See *Printing the Network Configuration List* on page 25 for information on how to print the Network Configuration List on your print server.

4 Choose **Static** from **Boot Method**. Enter the **IP address**, **Subnet Mask** and **Gateway** (if needed) of your print server.

Windows®

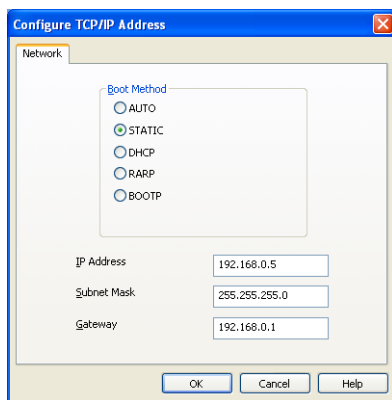

Macintosh®

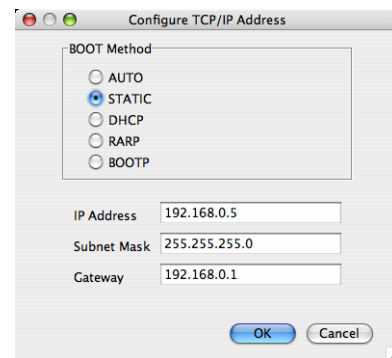

5 Click **OK**.

6 With the correctly programmed IP address, you will see the Brother print server in the device list.

## Using the control panel to configure your machine for a network

---

You can configure your machine for a network using the control panel LAN menu. See *Control panel setup* on page 16.

## Using other methods to configure your machine for a network

---

You can configure your machine for a network using other methods. See *Other ways to set the IP address (for advanced users and administrators)* on page 77.

# Changing the print server settings

## Using the BRAdmin Light utility to change the print server settings

2

- 1 Start the BRAdmin Light utility.
  - For Windows® 2000/XP, Windows Vista™ and Windows Server® 2003 users  
Click **Start / All Programs** <sup>1</sup> / **Brother / BRAdmin Light / BRAdmin Light**.
  - <sup>1</sup> **Programs** for Windows® 2000 users
  - For Mac OS® X 10.2.4 or greater users  
Double-click **Macintosh HD (Startup Disk) / Library / Printers / Brother / Utilities / BRAdmin-Light.jar** file.
- 2 Select the print server which you want to change the settings.
- 3 Select **Network Configuration** from the **Control** menu.
- 4 Enter a password. The default password is “**access**”.
- 5 You can now change the print server settings.

**Note**

If you want to change more advanced settings, use the BRAdmin Professional utility that is available as a download from <http://solutions.brother.com>.

## Using the control panel to change the print server settings

You can configure and change the print server settings using the control panel LAN menu. See *Control panel setup* on page 16.

## Using Web Based Management (web browser) to change the print/scan settings

A standard web browser can be used to change your print server settings using the HTTP (Hyper Text Transfer Protocol).

### Note

- We recommend Microsoft Internet Explorer 6.0<sup>®</sup> (or higher) or Firefox<sup>®</sup> 1.0 (or higher) for Windows<sup>®</sup> and Safari<sup>™</sup> 1.0 for Macintosh<sup>®</sup>. Please also make sure that JavaScript and Cookies are always enabled in whichever browser you use. We recommend you upgrade to Safari<sup>™</sup> 1.2 or higher to enable JavaScript. If a different web browser is used, make sure it is compatible with HTTP 1.0 and HTTP 1.1.
- To use a web browser, you will need to know the IP address of the print server.

- 1 Type “http://printer’s IP address/” into your browser. (where “printer’s IP address” is the printer’s IP address or the node name)

- For example:

http://192.168.1.2/ (if the printer’s IP address is 192.168.1.2.)

http://BRN123456/ (if the printer’s node name is BRN123456.)

### Note

If you have edited the hosts file on your computer or are using Domain Name System (DNS), you can also enter the DNS name of the print server. As the print server supports TCP/IP and NetBIOS names, you can also enter the NetBIOS name of the print server. The NetBIOS name can be seen in the Network Configuration List. To learn how to print the Network Configuration List, see *Printing the Network Configuration List* on page 25. The NetBIOS name assigned is the first 15 characters of the node name and by default it will appear as “BRNxxxxxx” where “xxxxxx” is the last six digits of the Ethernet address.

- 2 Click **Network Configuration**.
- 3 Enter a user name and a password. The default User Name is “**admin**” and the default Password is “**access**”.
- 4 Click **OK**.
- 5 You can now change the printer server settings. If you want to configure the protocol settings, click **Configure Protocol**.

### Note

If you change the protocol settings, restart the printer after clicking **Submit** to activate the configuration.

## Using the Remote Setup to change the print server settings (for Windows® and Mac OS® X 10.2.4 or greater) (for MFC-9440CN)

---

### Remote Setup for Windows®

The Remote Setup application allows you to configure network settings from a Windows® application. When you access this application, the settings on your machine will be downloaded automatically to your PC and displayed on your PC screen. If you change the settings, you can upload them directly to the machine.

- 1 Click the **Start** button, **All Programs**, **Brother**, **MFC-9440CN LAN**, then **Remote Setup**.
- 2 Enter a password. The default Password is “**access**”.
- 3 Click **TCP/IP**.
- 4 You can now change the print server settings.

### Remote Setup for Macintosh®

The Remote Setup application allows you to configure many MFC settings from a Macintosh® application. When you access this application, the settings on your machine will be downloaded automatically to your Macintosh® and displayed on your Macintosh® screen. If you change the settings, you can upload them directly to the machine.

- 1 Double click the **Macintosh HD** icon on your desktop, **Library**, **Printers**, **Brother**, then **Utilities**.
- 2 Double click the **Remote Setup** icon.
- 3 Enter a password. The default Password is “**access**”.
- 4 Click **TCP/IP**.
- 5 You can now change the print server settings.

## LAN menu

Before using your Brother product in a network environment, you need to configure the correct TCP/IP settings. For more information, see *Configuring your network printer* on page 8

In this chapter, you will learn how to configure the network settings using the control panel, located on the front of the machine.

The LAN menu selections of the control panel allow you to set up the Brother machine for your network configuration. Press **Menu**, then press **▲** or **▼** to choose **LAN**. Proceed to the menu selection you wish to configure. See *Function table and default factory settings* on page 86.

Please note that the machine is supplied with the BRAdmin Light utility and Remote Setup applications for Windows<sup>®</sup> and Macintosh<sup>®</sup>, which also can be used to configure many aspects of the network. See *Changing the print server settings* on page 13.

## TCP/IP

---

This menu has ten sections: BOOT Method, IP Address, Subnet Mask, Gateway, Node Name, WINS Config, WINS Server, DNS Server, APIPA and IPv6.

### BOOT Method

This selection controls how the machine obtains the IP address for itself. The default setting is **Auto**.



#### Note

---

- If you do not want your print server configured via DHCP, BOOTP or RARP, you must set the **BOOT Method** to **Static** so that the print server has a static IP address. This will prevent the print server from trying to obtain an IP address from any of these systems. To change the BOOT Method, use the machine's control panel, BRAdmin Professional utility, Remote Setup or Web Based Management (web browser).
  - You cannot change the BOOT method using the BRAdmin Light utility that was supplied on the CD-ROM with your Brother product. Please use the latest BRAdmin Professional utility that is available as a download from <http://solutions.brother.com>. This utility is only available for Windows<sup>®</sup> users.
- 

- 1 Press **Menu**.
- 2 Press **▲** or **▼** to choose **LAN**.  
Press **OK**.
- 3 Press **▲** or **▼** to choose **TCP/IP**.  
Press **OK**.
- 4 Press **▲** or **▼** to choose **BOOT Method**.  
Press **OK**.



- 5 Press ▲ or ▼ to choose `Auto`, `Static`, `RARP`, `BOOTP` or `DHCP`. Press **OK**.
  - If you chose `Auto`, `RARP`, `BOOTP` or `DHCP`, go to 6.
  - If you chose `Static`, go to 7.
- 6 Enter how many times the machine tries to obtain the IP address. We recommend you to enter 3 or more. Press **OK**.
- 7 Press **Stop/Exit**.

### Auto mode

In this mode, the machine will scan the network for a DHCP server, if it can find one, and if the DHCP server is configured to allocate an IP address to the machine, then the IP address supplied by the DHCP server will be used. If no DHCP server is available, then the machine will scan for a BOOTP server. If a BOOTP server is available, and it is configured correctly, the machine will take its IP address from the BOOTP server. If a BOOTP server is not available, the machine will scan for a RARP server. If a RARP server also does not answer, the IP Address is scanned through APIPA facility, see *Using APIPA to configure the IP address* on page 79. After it is initially powered ON, it may take a few minutes for the machine to scan the network for a server.

### Static mode

In this mode the machine's IP address must be manually assigned. Once entered the IP address is locked to the assigned address.

### RARP mode

The Brother print server IP address can be configured using the Reverse ARP (RARP) service on your host computer. For more information on RARP, see *Using RARP to configure the IP address* on page 79. This is done by editing the `/etc/ethers` file (if this file does not exist, you can create it) with an entry similar to the following:

```
00:80:77:31:01:07 BRN310107
```

Where the first entry is the Ethernet address of the print server and the second entry is the name of the print server (the name must be the same as the one you put in the `/etc/hosts` file).

If the `rarp` daemon is not already running, start it (depending on the system the command can be `rarpd`, `rarpd -a`, `in.rarpd -a` or something else; type `man rarpd` or refer to your system documentation for additional information). To verify that the `rarp` daemon is running on a Berkeley UNIX<sup>®</sup> based system, type the following command:

```
ps -ax | grep -v grep | grep rarpd
```

For AT&T UNIX<sup>®</sup> based systems, type:

```
ps -ef | grep -v grep | grep rarpd
```

The Brother print server will get the IP address from the `rarp` daemon when it is powered on.

## BOOTP mode

BOOTP is an alternative to rarp that has the advantage of allowing configuration of the subnet mask and gateway. For more information on BOOTP, see *Using BOOTP to configure the IP address* on page 78. In order to use BOOTP to configure the IP address make sure that BOOTP is installed and running on your host computer (it should appear in the `/etc/services` file on your host as a real service; type `man bootpd` or refer to your system documentation for information). BOOTP is usually started up via the `/etc/inetd.conf` file, so you may need to enable it by removing the “#” in front of the bootp entry in that file. For example, a typical bootp entry in the `/etc/inetd.conf` file would be:

```
#bootp dgram udp wait /usr/etc/bootpd bootpd -i
```



### Note

Depending on the system, this entry might be called “bootps” instead of “bootp”.

In order to enable BOOTP, simply use an editor to delete the “#” (if there is no “#”, then BOOTP is already enabled). Then edit the BOOTP configuration file (usually `/etc/bootptab`) and enter the name, network type (1 for Ethernet), Ethernet address and the IP address, subnet mask and gateway of the print server. Unfortunately, the exact format for doing this is not standardized, so you will need to refer to your system documentation to determine how to enter this information (many UNIX<sup>®</sup> systems also have template examples in the `bootptab` file that you can use for reference). Some examples of typical `/etc/bootptab` entries include:

```
BRN310107 1 00:80:77:31:01:07 192.189.207.3
```

and:

```
BRN310107:ht=ethernet:ha=008077310107:\
ip=192.189.207.3:
```

Certain BOOTP host software implementations will not respond to BOOTP requests if you have not included a download filename in the configuration file; if this is the case, simply create a null file on the host and specify the name of this file and its path in the configuration file.

As with rarp, the print server will load its IP address from the BOOTP server when the printer is powered on.

## DHCP mode

Dynamic Host Configuration Protocol (DHCP) is one of several automated mechanisms for IP address allocation. If you have a DHCP server in your network (typically a UNIX<sup>®</sup>, Windows<sup>®</sup> 2000/XP, Windows Vista<sup>™</sup> network) the print server will automatically obtain its IP address from a DHCP server and register its name with any RFC 1001 and 1002 compliant dynamic name services.

## IP Address

This field displays the current IP address of the machine. If you have selected a BOOT Method of Static, enter the IP address that you wish to assign to the machine (check with your network administrator for the IP address to use). If you have selected a method other than Static, the machine will attempt to determine its IP address using the DHCP or BOOTP protocols. The default IP address of your machine will probably be incompatible with the IP address numbering scheme of your network. We recommend that you contact your network administrator for an IP address for the network the unit will be connected on.

- 1 Press **Menu**.
- 2 Press **▲** or **▼** to choose LAN.  
Press **OK**.
- 3 Press **▲** or **▼** to choose TCP/IP.  
Press **OK**.
- 4 Press **▲** or **▼** to choose IP Address.  
Press **OK**.
- 5 Press **1** to choose Change.
- 6 Enter the IP address.  
Press **OK**.
- 7 Press **Stop/Exit**.

## Subnet Mask

This field displays the current subnet mask used by the machine. If you are not using DHCP or BOOTP to obtain the subnet mask, enter the desired subnet mask. Check with your network administrator for the subnet mask to use.

- 1 Press **Menu**.
- 2 Press **▲** or **▼** to choose LAN.  
Press **OK**.
- 3 Press **▲** or **▼** to choose TCP/IP.  
Press **OK**.
- 4 Press **▲** or **▼** to choose Subnet Mask.  
Press **OK**.
- 5 Press **1** to choose Change.
- 6 Enter the Subnet Mask address.  
Press **OK**.
- 7 Press **Stop/Exit**.

## Gateway

This field displays the current gateway or router address used by the machine. If you are not using DHCP or BOOTP to obtain the gateway or router address, enter the address you wish to assign. If you do not have a gateway or router, leave this field blank. Check with your network administrator if you are unsure.

- 1 Press **Menu**.
- 2 Press **▲** or **▼** to choose LAN.  
Press **OK**.
- 3 Press **▲** or **▼** to choose TCP/IP.  
Press **OK**.
- 4 Press **▲** or **▼** to choose Gateway.  
Press **OK**.
- 5 Press **1** to choose Change.
- 6 Enter the Gateway address.  
Press **OK**.
- 7 Press **Stop/Exit**.

## Node Name

You can register the machine name on the Network. This name is often referred to as a NetBIOS name; it will be the name that is registered by the WINS server on your network. Brother recommends the name BRNxxxxxx (where xxxxxx is the last six digits of the Ethernet address) (up to 15 characters).

- 1 Press **Menu**.
- 2 Press **▲** or **▼** to choose LAN.  
Press **OK**.
- 3 Press **▲** or **▼** to choose TCP/IP.  
Press **OK**.
- 4 Press **▲** or **▼** to choose Node Name.  
Press **OK**.
- 5 Press **1** to choose Change.
- 6 Enter the Node Name.  
Press **OK**.
- 7 Press **Stop/Exit**.

## WINS Config

This selection controls how the machine obtains the IP address of the WINS server.

- 1 Press **Menu**.
- 2 Press **▲** or **▼** to choose LAN.  
Press **OK**.
- 3 Press **▲** or **▼** to choose TCP/IP.  
Press **OK**.
- 4 Press **▲** or **▼** to choose WINS Config.  
Press **OK**.
- 5 Press **▲** or **▼** to choose Auto or Static.  
Press **OK**.
- 6 Press **Stop/Exit**.

### Auto

Automatically uses a DHCP request to determine the IP addresses for the primary and secondary WINS servers. You must set the BOOT Method to Auto for this feature to work.

### Static

Uses a specified IP address for the primary and secondary WINS servers.

## WINS Server

- 1 Press **Menu**.
- 2 Press **▲** or **▼** to choose LAN.  
Press **OK**.
- 3 Press **▲** or **▼** to choose TCP/IP.  
Press **OK**.
- 4 Press **▲** or **▼** to choose WINS Server.  
Press **OK**.
- 5 Press **▲** or **▼** to choose Primary or Secondary.  
Press **OK**.
- 6 Press **1** to choose Change.
- 7 Enter the WINS Server address.  
Press **OK**.
- 8 Press **Stop/Exit**.

### Primary WINS Server IP Address

This field specifies the IP address of the primary WINS (Windows® Internet Naming Service) server. If set to a non-zero value, the machine will contact this server to register its name with the Windows® Internet Name Service.

### Secondary WINS Server IP Address

This field specifies the IP address of the secondary WINS server. It is used as a backup to the Primary WINS server address. If the Primary server is unavailable, the machine still can register itself with a secondary server. If set to a non-zero value, the machine will contact this server to register its name with the Windows® Internet Name Service. If you have a primary WINS server, but no secondary WINS server, simply leave this field blank.

### DNS Server

- 1 Press **Menu**.
- 2 Press **▲** or **▼** to choose LAN.  
Press **OK**.
- 3 Press **▲** or **▼** to choose TCP/IP.  
Press **OK**.
- 4 Press **▲** or **▼** to choose DNS Server.  
Press **OK**.
- 5 Press **▲** or **▼** to choose Primary or Secondary.  
Press **OK**.
- 6 Press **1** to choose Change.
- 7 Enter the DNS Server address.  
Press **OK**.
- 8 Press **Stop/Exit**.

### Primary DNS Server IP Address

This field specifies the IP address of the primary DNS (Domain Name Service) server.

### Secondary DNS Server IP Address

This field specifies the IP address of the secondary DNS server. It is used as a backup to the Primary DNS server address. If the Primary server is unavailable, the machine will contact the Secondary DNS server. If you have a primary DNS server, but no secondary DNS server, simply leave this field blank.

## APIPA

The setting of **On** will cause the print server to automatically allocate a Link-Local IP address in the range (169.254.1.0 - 169.254.254.255) when the print server cannot obtain an IP address through the BOOT Method you have set (see *BOOT Method* on page 16). Selecting **Off** means the IP address doesn't change, when the print server cannot obtain an IP address through the BOOT Method you have set.

- 1 Press **Menu**.
- 2 Press **▲** or **▼** to choose **LAN**.  
Press **OK**.
- 3 Press **▲** or **▼** to choose **TCP/IP**.  
Press **OK**.
- 4 Press **▲** or **▼** to choose **APIPA**.  
Press **OK**.
- 5 Press **▲** or **▼** to choose **On** or **Off**.  
Press **OK**.
- 6 Press **Stop/Exit**.

## IPv6

This machine is compatible with IPv6, the next generation internet protocol. If you want to use the IPv6 protocol, choose **On**. The default setting for IPv6 is **Off**. For more information on the IPv6 protocol, visit <http://solutions.brother.com>.

- 1 Press **Menu**.
- 2 Press **▲** or **▼** to choose **LAN**.  
Press **OK**.
- 3 Press **▲** or **▼** to choose **TCP/IP**.  
Press **OK**.
- 4 Press **▲** or **▼** to choose **IPv6**.  
Press **OK**.
- 5 Press **▲** or **▼** to choose **On** or **Off**.  
Press **OK**.
- 6 Press **Stop/Exit**.

## Ethernet

---

Ethernet link mode. Auto allows the print server to operate in 100BASE-TX full or half duplex, or in 10BASE-T full or half duplex mode by auto negotiation.

100BASE-TX Full Duplex (100B-FD) or Half Duplex (100B-HD) and 10BASE-T Full Duplex (10B-FD) or Half Duplex (10B-HD) fix the print server link mode. This change is valid after the print server has been reset (default is `Auto`).



### Note

If you incorrectly set this value, you may not be able to communicate with your print server.

- 1 Press **Menu**.
- 2 Press **▲** or **▼** to choose LAN.  
Press **OK**.
- 3 Press **▲** or **▼** to choose Ethernet.  
Press **OK**.
- 4 Press **▲** or **▼** to choose `Auto`, `100B-FD`, `100B-HD`, `10B-FD` or `10B-HD`.  
Press **OK**.
- 5 Press **Stop/Exit**.

## Scan to FTP

---

You can choose the default color file type for the Scan to FTP function.

- 1 Press **Menu**.
- 2 Press **▲** or **▼** to choose LAN.  
Press **OK**.
- 3 Press **▲** or **▼** to choose Scan to FTP.  
Press **OK**.
- 4 Press **▲** or **▼** to choose `Color 150 dpi`, `Color 300 dpi`, `Color 600 dpi`, `B&W 200x100 dpi` or `B&W 200 dpi`.  
Press **OK**.
- 5 If you chose `Color 150 dpi`, `Color 300 dpi` or `Color 600 dpi` in 4, press **▲** or **▼** to choose `PDF` or `JPEG`.  
If you chose `B&W 200 dpi` or `B&W 200x100 dpi` in 4, press **▲** or **▼** to choose `PDF` or `TIFF`.  
Press **OK**.
- 6 Press **Stop/Exit**.



### Note

For how to operate Scan to FTP, see *Network Scanning* of the Software User's Guide on the CD-ROM.



# Printing the Network Configuration List



## Note

Node name: Node name appears in the Network Configuration List. The default Node name is "BRNxxxxxx" ("xxxxxx" is the last six digits of Ethernet address).

The Network Configuration List prints a report listing all the current network configuration including the network print server settings.

3

### For MFC-9440CN:

- 1 Press **Menu**.
- 2 Press **▲** or **▼** to choose `Print Reports`. Press **OK**.
- 3 Press **▲** or **▼** to choose `Network Config`. Press **OK**.
- 4 (For US) Press **Black Start** or **Color Start**.  
(For UK) Press **Mono Start** or **Colour Start**.

### DCP-9040CN and DCP-9045CDN:

- 1 Press **Menu**.
- 2 Press **▲** or **▼** to choose `Machine Info`. Press **OK**.
- 3 Press **▲** or **▼** to choose `User Settings`. Press **OK**.
- 4 (For US) Press **Black Start** or **Color Start**.  
(For UK) Press **Mono Start** or **Colour Start**.

## Restoring the network settings to factory default

If you wish to reset the print server back to its default factory settings (resetting all information such as the password and IP address information), please follow these steps:



### Note

This function restores all network settings to the factory default.

- 1 Press **Menu**.
- 2 Press **▲** or **▼** to choose **LAN**.  
Press **OK**.
- 3 Press **▲** or **▼** to choose **Factory Reset**.  
Press **OK**.
- 4 Press **1** to choose **Reset**.
- 5 Press **1** to choose **Yes** for reboot.
- 6 The machine will re-start. You can now reconnect the network cable and configure the network settings to work with your network.

# 4

## Driver Deployment Wizard (Windows<sup>®</sup> only)

### Overview

The Driver Deployment Wizard software can be used to ease the installation or even automate the installation of a locally connected or network connected printers. The Driver Deployment Wizard can also be used to create self running executable files which when run on a remote PC, completely automates the installation of a printer driver. The remote PC does not have to be connected to a network.

4

### Connection methods

The Driver Deployment Wizard supports the two connection methods.

#### Peer-to-Peer

The device is connected to the network but each user prints directly to the printer WITHOUT printing through a central queue.

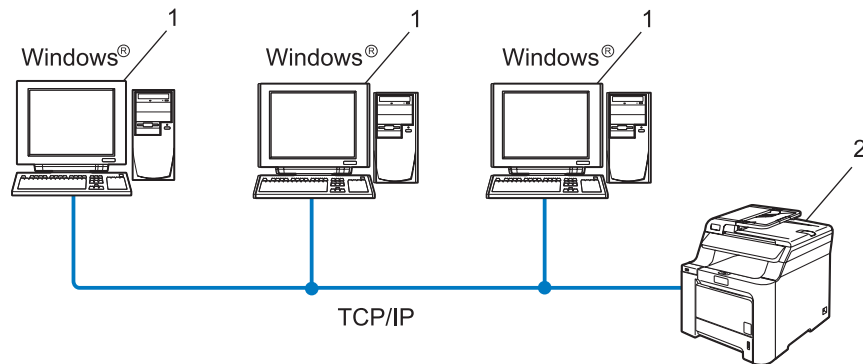

- 1 Client Computer
- 2 Network printer (your machine)

## Network Shared

The device is connected to a network and a central print queue is used to manage all print jobs.

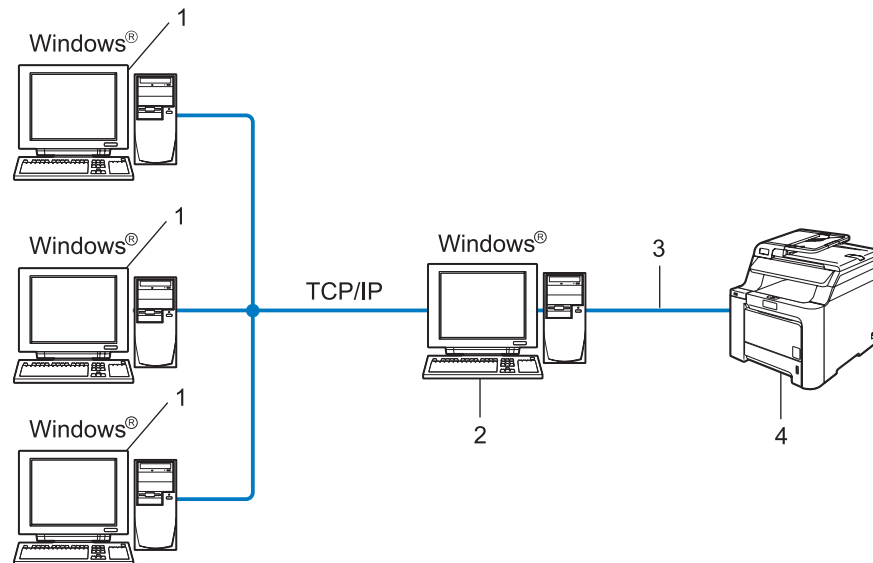

- 1 Client computer
- 2 Also known as “Server” or “Print Server”
- 3 TCP/IP or USB (where available)
- 4 Printer (your machine)

## How to install the Driver Deployment Wizard software

- 1 Put the supplied CD-ROM into your CD-ROM drive. The opening screen will appear automatically.
- 2 Select your language. Then click **Install Other Drivers or Utilities**.
- 3 Select the **Driver Deployment Wizard** installation program.



### Note

---

For Windows Vista™, when the **User Account Control** screen appears, click **Continue**.

---

- 4 Click **Next** in response to the Welcome message.
- 5 Read the license agreement carefully. Then follow the on-screen instructions.
- 6 Click **Finish**. Now the Driver Deployment Wizard software has been installed.

## Using the Driver Deployment Wizard software

- 1 When you run the Wizard for the first time you will see a welcome screen. Click **Next**.
- 2 Choose **Printer**, and then click **Next**.
- 3 Choose your connection type to the printer that you want to print to.
- 4 Choose the option you require, and follow the on-screen instructions. If you choose **Brother Peer-to-Peer Network Printer**, the following screen is displayed.

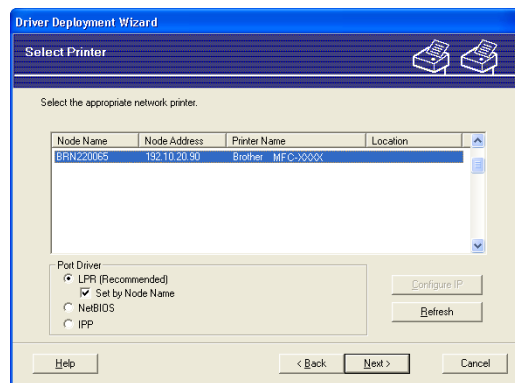

### ■ Setting the IP Address

If the printer does not have an IP address, the Wizard will allow you to change the IP address by selecting the printer from the list and by selecting the **Configure IP** option. A dialogue box then appears which allows you to specify information such as the IP address, subnet mask and also the gateway address.

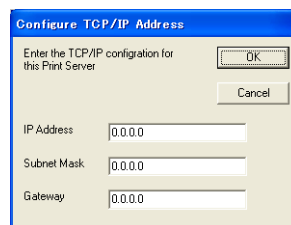

- 5 Choose the printer you wish to install, and then click **Next**. If the driver you wish to use is not installed on your computer, click **Have Disk** and then specify the path of the printer driver.

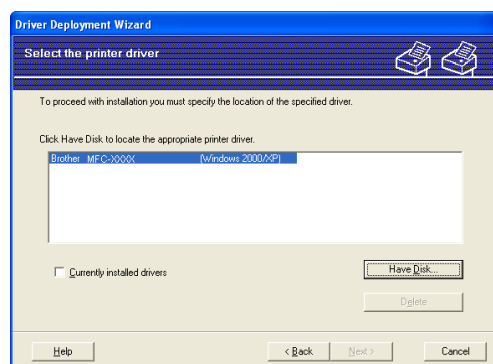

- 6 Click **Next** after you choose the correct driver.
- 7 A summary screen will appear. Confirm the settings of the driver.

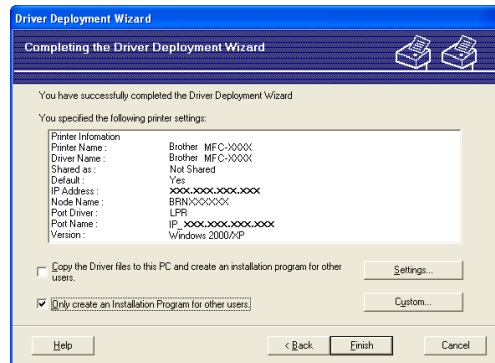

### ■ Creating an executable file

The Driver Deployment Wizard software can also be used to create self running .EXE files. These self-running .EXE files can be saved to the network, copied to a CD-ROM, a floppy disc or even E-mailed to another user. Once run, the driver and its settings are automatically installed without any user intervention.

- **Copy the Driver files to this PC and create an installation program for other users.**

Select this option if you wish to install the driver onto your computer and also create a self-running executable file for use with another computer using the same operating system as your own.

- **Only Create an Installation Program for other users.**

Select this option if the driver is already installed on your computer and you wish to create a self-running executable file without again installing the driver on your own computer.



### Note

If you work in a "queue" based network and you create an executable file for another user who does not have access to the same printer queue that you define into the executable file, the driver when installed on the remote computer will default to LPT1 printing.

- 8 Click **Finish**. The driver is automatically installed to your computer.

## Overview

If you are a Windows<sup>®</sup> user and want to print using the TCP/IP protocol in a Peer-to-Peer environment, please follow the instructions in this chapter. This chapter explains how to install the network software and the printer driver which you will need to be able to print using your network printer.



### Note

- You must configure the IP address on your machine before you proceed with this chapter. If you need to configure the IP address, see *Setting the IP address and subnet mask* on page 10 first.
- Verify the host computer and print server are either on the same subnet, or that the router is properly configured to pass data between the two devices.
- If you are connecting to a Network Print Queue or Share (printing only), see *Installation when using a Network Print Queue or Share (printer driver only)* on page 82 for installation details.
- The default password for Brother print server is “**access**”.

## For Windows<sup>®</sup> users (Windows<sup>®</sup> 2000/XP, Windows Vista<sup>™</sup> and Windows Server<sup>®</sup> 2003)

By default, Windows<sup>®</sup> 2000/XP, Windows Vista<sup>™</sup> and Windows Server 2003 systems install the necessary print software to enable you to print. This section describes the most commonly used configuration, Standard TCP/IP Port printing. These Windows<sup>®</sup> systems can also print via the Internet using the IPP protocol. For more information, see *Internet printing for Windows<sup>®</sup>* on page 34.

If you have already installed the printer driver, jump to *Printer driver already installed* on page 33.

## Configuring the standard TCP/IP port

### Printer driver not yet installed

- 1 Start the CD-ROM installation menu program according to the Quick Setup Guide.
- 2 Select your language (if necessary), and then click **Install Other Drivers or Utilities**.
- 3 Click **Printer Driver (Only)**.
- 4 Click **Next** in response to the Welcome message. Follow the on-screen instructions.
- 5 Select **Standard Installation** and click **Next**.
- 6 Select **Brother Peer-to-Peer Network Printer**, and then click **Next**.



- 7 Follow the on-screen instruction, and then click **OK**.

**Note**

Contact your administrator if you are not sure about the location and name of the printer in the network.

- 8 Continue through the wizard clicking **Finish** when complete.

### Printer driver already installed

If you have already installed the printer driver and wish to configure it for network printing, follow these steps:

- 1 For Windows Vista™:  
Click the **Start** button, **Control Panel**, **Hardware and Sound**, and then **Printers**.  
For Windows® XP and Windows Server® 2003:  
Click the **Start** button and select **Printers and Faxes** windows.  
For Windows® 2000:  
Click the **Start** button and select **Settings** and then **Printers**.
- 2 Right click on the printer driver you wish to configure, and then select **Properties**.
- 3 Click the **Ports** tab and click **Add Port**.
- 4 Select the port that you wish to use. Typically this would be **Standard TCP/IP Port**. Then click the **New Port...** button.
- 5 The **Standard TCP/IP Port Wizard** will start.
- 6 Enter the IP address of your network printer. Click **Next**.
- 7 Click **Finish**.
- 8 Close **Printer Ports** and **Properties** dialog box.

### Other sources of information

See *Configuring your network printer* on page 8 to learn how to configure the IP address of the printer.

## Overview

Windows® 2000/XP, Windows Vista™ and Windows Server® 2003 users can print using TCP/IP using the standard Network Printing software and IPP protocol software built into any Windows® 2000/XP, Windows Vista™ and Windows Server® 2003 installation.



### Note

- You must configure the IP address on your printer before you proceed with this chapter. If you need to configure the IP address, see *Chapter 2* first.
- Verify the host computer and print server are either on the same subnet, or that the router is properly configured to pass data between the two devices.
- The default password for Brother print servers is “**access**”.
- This print sever also supports the IPPS printing, see *Printing documents securely using IPPS* on page 49.

## IPP printing for Windows® 2000/XP, Windows Vista™ and Windows Server® 2003

Use the following instructions if you wish to use the IPP printing capabilities of Windows® 2000/XP, Windows Vista™ and Windows Server® 2003.

### For Windows Vista™

- 1 Click the **Start** button, **Control Panel**, **Hardware and Sound**, and then **Printers**.
- 2 Click **Add a printer**.
- 3 Select **Add a network, wireless or Bluetooth printer**.
- 4 Click **The printer that I want isn't listed**.
- 5 Select **Select a shared printer by name** and then enter the following in the URL field:  
http://printer's IP address:631/ipp (where “printer's IP address” is the printer's IP address or the node name.)



### Note

If you have edited the hosts file on your computer or are using Domain Name System (DNS), you can also enter the DNS name of the print server. As the print server supports TCP/IP and NetBIOS names, you can also enter the NetBIOS name of the print server. The NetBIOS name can be seen in the Network Configuration List. To learn how to print the Network Configuration List, see *Printing the Network Configuration List* on page 25. The NetBIOS name assigned is the first 15 characters of the node name and by default it will appear as “BRNxxxxxx” where “xxxxxx” is the last six digits of the Ethernet address.

- 6 When you click **Next**, Windows Vista™ will make a connection with the URL that you specified.
- If the printer driver has already been installed:
    - 1 You will see the printer selection screen in the **Add Printer Wizard**. Click **OK**.  
If the appropriate printer driver is already installed on your computer, Windows Vista™ will automatically use that driver for use. In this case, you will simply be asked if you wish to make the driver the default printer, after which the Driver installation wizard will complete. You are now ready to print.
    - 2 Go to 11.
  - If the printer driver has NOT been installed:
 

One of the benefits of the IPP printing protocol is that it establishes the model name of the printer when you communicate with it. After successful communication you will see the model name of the printer automatically. This means that you do not need to inform Windows Vista™ about the type of printer driver to be used.

Go to 7.
- 7 If your printer is not in the list of supported printers, click **Have Disk**. You will then be asked to insert the driver disk.
- 8 Click **Browse** and select the appropriate Brother printer driver that is contained in the CD-ROM or in the network share. Click **Open**.
- 9 Click **OK**.
- 10 Specify the model name of the printer. Click **OK**.
-  **Note**
- When the **User Account Control** screen appears, click **Continue**.
  - If the printer driver that you are installing does not have a Digital Certificate you will see a warning message. Click **Install this driver software anyway** to continue with the installation. The **Add Printer Wizard** will then complete.
- 
- 11 You will see the **Type a printer name** screen in the **Add Printer Wizard**. Check the **Set as the default printer** check box if you want to use this printer as the default printer, and then click **Next**.
- 12 To test the printer connection, click **Print a test page**, and then click **Finish** and the printer is now configured and ready to print.

## For Windows® 2000/XP and Windows Server® 2003

---

- 1 For Windows® XP and Windows Sever® 2003:  
Click the **Start** button and select **Printers and Faxes**.  
For Windows® 2000:  
Click the **Start** button and select **Settings** and then **Printers**.
- 2 For Windows® XP:  
Click **Add a printer** to start the **Add Printer Wizard**.  
For Windows® 2000 and Windows Sever® 2003:  
Double click the **Add Printer** icon to start the **Add Printer Wizard**.
- 3 Click **Next** when you see the **Welcome to the Add Printer Wizard** screen.
- 4 For Windows® XP and Windows Sever® 2003:  
Select **A network printer, or a printer attached to another computer**.  
For Windows® 2000:  
Select **Network Printer**.
- 5 Click **Next**.
- 6 For Windows® XP and Windows Server® 2003:  
Select **Connect to a printer on the Internet or on a home or office network** and then enter the following in the URL field:  
http://printer's IP address:631/ipp  
(where "printer's IP address" is the printer's IP address or the node name.)  
For Windows® 2000:  
Select **Connect to a printer on the Internet or on your intranet** and then enter the following in the URL field:  
http://printer's IP address:631/ipp  
(Where "printer's IP address" is the printer's IP address or the node name).



### Note

If you have edited the hosts file on your computer or are using Domain Name System (DNS), you can also enter the DNS name of the print server. As the print server supports TCP/IP and NetBIOS names, you can also enter the NetBIOS name of the print server. The NetBIOS name can be seen in the Network Configuration List. To learn how to print the Network Configuration List, see *Printing the Network Configuration List* on page 25. The NetBIOS name assigned is the first 15 characters of the node name and by default it will appear as "BRNxxxxxx" where "xxxxxx" is the last six digits of the Ethernet address.

---

- 7 When you click **Next**, Windows® 2000/XP and Windows Sever® 2003 will make a connection with the URL that you specified.
- If the printer driver has already been installed:
    - 1 You will see the printer selection screen in the **Add Printer Wizard**.  
If the appropriate printer driver is already installed on your computer, Windows® 2000/XP and Windows Server® 2003 will automatically use that driver for use. In this case, you will simply be asked if you wish to make the driver the default printer, after which the Driver installation wizard will complete. You are now ready to print.
    - 2 Go to 12.
  - If the printer driver has NOT been installed:

One of the benefits of the IPP printing protocol is that it establishes the model name of the printer when you communicate with it. After successful communication you will see the model name of the printer automatically. This means that you do not need to inform Windows® 2000/XP and Windows Sever® 2003 about the type of printer driver to be used.

Go to 8.
- 8 The driver installation starts automatically.

**Note**

If the printer driver that you are installing does not have a Digital Certificate you will see a warning message. Click **Continue Anyway** to continue with the installation.

- 9 Click **OK** when you see the **Insert Disk** screen.
- 10 Click **Browse** and select the appropriate Brother printer driver that is contained in the CD-ROM or in the network share. Click **Open**.
- 11 Click **OK**.
- 12 Check **Yes** if you want to use this printer as the default printer. Click **Next**.
- 13 Click **Finish** and the printer is now configured and ready to print. To test the printer connection, print a test page.

## Specifying a different URL

---

Please note that there are several possible entries that you can enter for the URL field.

`http://printer's IP address:631/ipp`

This is the default URL and we recommend that you use this URL. Please note the **Get More Info** option will not display any printer data.

`http://printer's IP address:631/ipp/port1`

This is for HP® Jetdirect® compatibility. Please note the **Get More Info** option will not display any printer data.

`http://printer's IP address:631/`

If you forget the URL details, you can simply enter the above text (`http://printer's IP address/`) and the printer will still receive and process data.

Where “printer's IP address” is the printer's IP address or the node name.

## Other sources of information

See *Chapter 2* of this User's Guide to learn how to configure the IP address of the printer.

## Overview

This chapter explains how to configure the BR-Script 3 (PostScript® 3™ language emulation) printer driver on a Network. For more information on how to install the Brother standard printer driver on a Network, see the Quick Setup Guide included with the printer.

## How to select the BR-Script 3 printer driver (TCP/IP)

- 1 Turn the power of the machine ON.
- 2 From the **Go** menu, select **Applications**.
- 3 Open the **Utilities** folder.
- 4 Double click the **Printer Setup Utility** icon. (Mac OS® X 10.2.x users, click the **Print Center** icon.)
- 5 Click **Add**.
- 6 (Mac OS® X 10.2.4 to 10.3.x) Select **IP Printing**.  
(Mac OS® X 10.4) Select **IP Printer**.

(Mac OS® X 10.2.4 to 10.3.x)

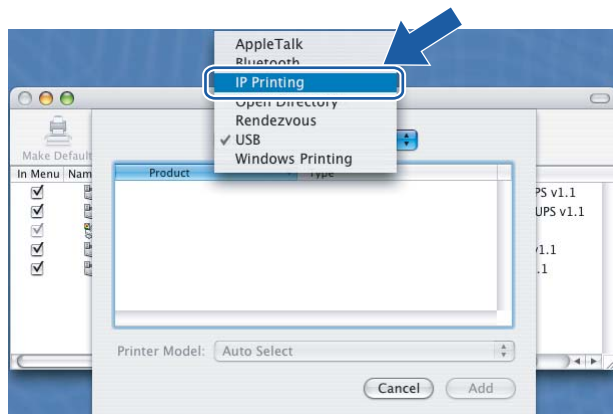

(Mac OS® X 10.4)

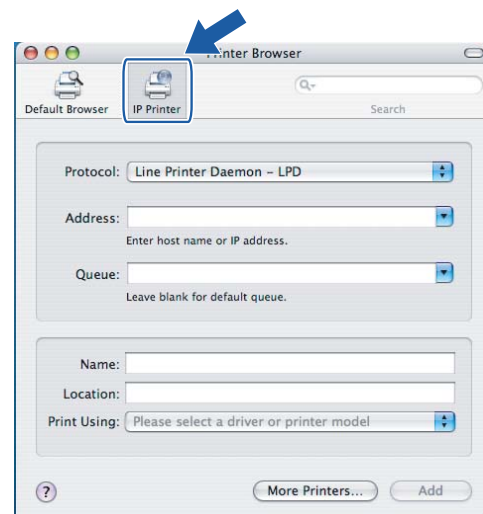

- 7 (Mac OS® X 10.2.4 to 10.3.x) Enter the IP address of the printer into the **Printer Address** box.  
 (Mac OS® X 10.4) Enter the IP address of the printer into the **Address** box.

(Mac OS® X 10.2.4 to 10.3.x)

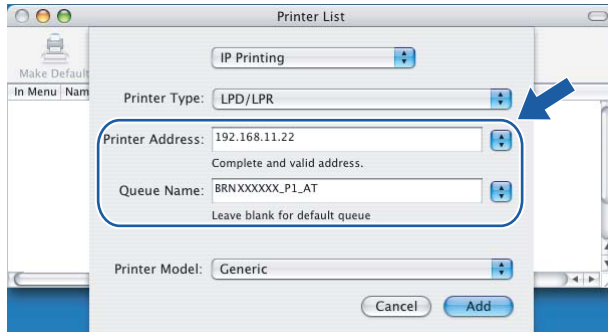

(Mac OS® X 10.4)

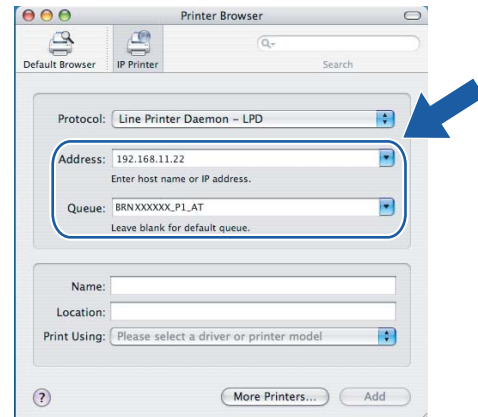

#### Note

- The Network Configuration List will allow you to confirm the IP address. For more information on how to print the configuration page, see *Printing the Network Configuration List* on page 25.
- When specifying the **Queue Name**, use the value `brnxxxxxx_p1_at` where `xxxxxx` are the last 6 digits of the Ethernet address.



- 8 From the **Printer Model** pull-down list select your model. For example, select **Brother MFC-9440CN BR-Script3**.

(Mac OS® X 10.2.4 to 10.3.x)

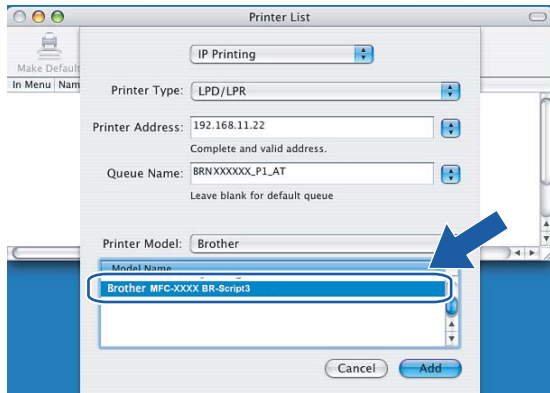

(Mac OS® X 10.4)

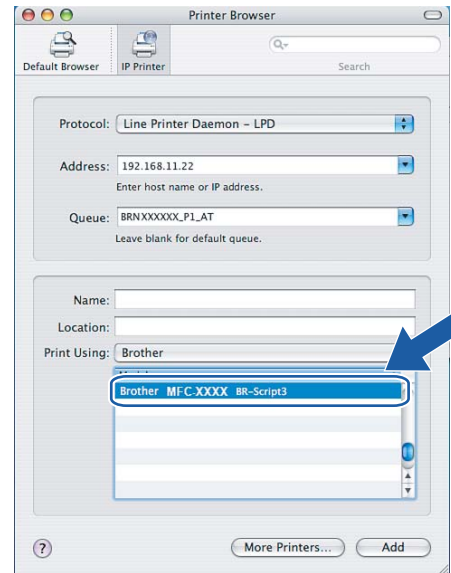

- 9 Click **Add** and the printer will be available from the **Printer List**.

## Other sources of information

See *Chapter 2* of this User's Guide to learn how to configure the IP address of the printer.

## Overview

A standard Web Browser can be used to manage your machine using the HTTP (Hyper Text Transfer Protocol). You can get the following information from a machine on your network using a web browser.

- Printer status information
- Change Fax configuration items, such as General Setup, Quick-Dial settings and Remote Fax
- You can also change network settings such as TCP/IP information.
- Configure Scan to FTP search function
- Software version information of the machine and print server
- Change network and machine configuration details



### Note

---

We recommend Microsoft Internet Explorer 6.0<sup>®</sup> (or higher) or Firefox<sup>®</sup> 1.0 (or higher) for Windows<sup>®</sup> and Safari<sup>™</sup> 1.0 for Macintosh<sup>®</sup>. Please also make sure that JavaScript and Cookies are always enabled in whichever browser you use. We recommend you upgrade to Safari<sup>™</sup> 1.2 or higher to enable JavaScript. If a different web browser is used, make sure it is compatible with HTTP 1.0 and HTTP 1.1.

---

You must use the TCP/IP protocol on your network and have a valid IP address programmed into the print server and your computer.

- To learn how to configure the IP address on your machine, see *Configuring your network printer* on page 8.
- You can use a web browser on most computing platforms, for example, Macintosh<sup>®</sup> and UNIX<sup>®</sup> users are also able to connect to the machine and manage it.
- You can also use the BRAdmin Light and the BRAdmin Professional utilities to manage the printer and its network configuration.

## How to connect to your machine using a Browser

Type “http://printer’s IP address/” into your browser (where “printer’s IP address” is the printer’s IP address or the node name.)(You can also use the NetBIOS name of the printer server, if you are in a Microsoft domain/Workgroup environment). Enter the DNS name of the machine if connecting to a network that uses the DNS protocol.

For Macintosh® users, you can have easy access to Web Based Management System by clicking the machine icon on **Status Monitor** screen. For more information, see *Chapter 7 Status Monitor* of the Software User’s Guide on the CD-ROM.

## Password information

Web Based Management offers two levels of password access. Users are able to access to the General Setup, Fax settings and Lists and Reports. The default user name for User is “**user**” (case sensitive) and the default password is “**access**”.

Administrators are able to access all settings. The login name for the Administrator is “**admin**” (case sensitive) and the default password is “**access**”.

## Changing the Scan to FTP configuration using a Browser (for MFC-9440CN)

You can configure and change the following Scan to FTP settings using a web browser. Click **Administrator Settings** on the MFC-9440CN web page, and then click **Scan to FTP**. See *Chapter 4* of the Software User’s Guide for more details on Scan to FTP.

- **Profile Name** (Up to 15 characters)
- **Host Address** (FTP server address)
- **Username**
- **Password**
- **Store Directory**
- **Quality** (Color 150, Color 300, Color 600, B&W 200 and B&W 200x100)
- **File Type** (PDF, JPEG or TIFF)
- **Passive Mode** (On or Off)
- **Port Number**

## Overview

In today's world there are many security threats to your network and the data that travels over it. Your Brother machine employs some of the latest network security and encryption protocols available today. These network features can be integrated into your overall network security plan to help protect your data and prevent unauthorized access to the machine. This chapter explains the various security protocols supported and how to configure them.

## Security terms

---

### ■ CA (Certificate Authority)

A CA is an entity that issues digital certificates (especially X.509 certificates) and vouches for the binding between the data items in a certificate.

### ■ CSR (Certificate Signing Request)

A CSR is a message sent from an applicant to a CA in order to apply for issue of a certificate. The CSR contains information identifying the applicant, the public key generated by the applicant and the digital signature of the applicant.

### ■ Certificate

A Certificate is the information that binds together a public key with an identity. The certificate can be used to verify that a public key belongs to an individual. The format is defined by the x.509 standard.

### ■ Digital signature

A Digital signature is a value computed with a cryptographic algorithm and appended to a data object in such a way that any recipient of the data can use the signature to verify the data's origin and integrity.

### ■ Public key cryptosystem

A Public key cryptosystem is a modern branch of cryptography in which the algorithms employ a pair of keys (a public key and a private key) and use a different component of the pair for different steps of the algorithm.

### ■ Shared key cryptosystem

A Shared key cryptosystem is a branch of cryptography involving algorithms that use the same key for two different steps of the algorithm (such as encryption and decryption).

## Security protocols

---

The Brother print server supports the following security protocols.

### Note

How to configure the protocol settings, see *Using Web Based Management (web browser) to change the print/scan settings* on page 14.

---

### **SSL (Secure Socket Layer) / TLS (Transport Layer Security)**

These security communication protocols encrypt data to prevent security threats.

### **Web server (HTTPS)**

The internet protocol that the Hyper Text Transfer Protocol (HTTP) uses SSL.

### **IPPS**

The printing protocol that the Internet Printing Protocol (IPP Version 1.0) uses SSL.

## Security methods for E-mail notification

---

The Brother print server supports the following security methods for E-mail notification.

### Note

How to configure the settings of security methods, see *Using Web Based Management (web browser) to change the print/scan settings* on page 14.

---

### **POP before SMTP (PbS)**

The user authentication method for sending E-mail from a client. The client is given permission to use the SMTP server by accessing the POP3 server before sending the E-mail.

### **SMTP-AUTH (SMTP Authentication)**

SMTP-AUTH expands SMTP (the Internet E-mail sending protocol) to include an authentication method that ensures the true identity of the sender is known.

### **APOP (Authenticated Post Office Protocol)**

APOP expands POP3 (the Internet receiving protocol) to include an authentication method that encrypts the password when the client receives E-mail.

## Configuring the protocol settings

---

You can enable or disable the each protocol and security method using Web Based Management (web browser).

### Note

---

We recommend Microsoft Internet Explorer 6.0<sup>®</sup> (or higher) or Firefox<sup>®</sup> 1.0 (or higher) for Windows<sup>®</sup> and Safari™ 1.0 for Macintosh<sup>®</sup>. Please also make sure that JavaScript and Cookies are always enabled in whichever browser you use. We recommend you upgrade to Safari™ 1.2 or higher to enable JavaScript. To use a web browser, you will need to know the IP address of the print server.

---

- 1 Start your web browser.
- 2 Type `http://Common Name/` into your browser (where `Common Name` is the printer's IP address or the node name).
  - For example:  
`http://192.168.1.2/` (If the `Common Name` is the printer's IP address)  
`http://BRN123456/` (If the `Common Name` is the printer's node name)

### Note

---

If you have edited the hosts file on your computer or are using a Domain Name System, you can also enter the DNS name of the print server. As the print server supports TCP/IP and NetBIOS names, you can also enter the NetBIOS name of the print server. The NetBIOS name can be seen on the printer settings page. The NetBIOS name assigned is the first 15 characters of the node name and by default it will appear as "BRNxxxxxxx" for a wired network (where "xxxxxxx" is the last six digits of the Ethernet address).

---

- 3 Click **Network Configuration**.
- 4 Enter a user name and a password. The default User Name is `admin` and the default Password is `access`.
- 5 Click **OK**.
- 6 Click **Configure Protocol**.  
Now you can configure the protocol settings.

### Note

---

If you change the protocol settings, restart the printer after clicking **Submit** to activate the configuration.

---

## Managing your network printer securely

To manage your network printer securely, you need to use the management utilities with security protocols.

### Secure Management using Web Based Management (web browser)

To use the HTTPS protocol, the following printer settings are required.

- A certificate and private key must be installed in the printer. For how to install a certificate and private key, see *Creating and installing a certificate* on page 52.
- The HTTPS protocol must be enabled. To enable the HTTPS protocol, see *Configuring the protocol settings* on page 46.

#### Note

We recommend Microsoft Internet Explorer 6.0<sup>®</sup> (or higher) or Firefox<sup>®</sup> 1.0 (or higher) for Windows<sup>®</sup> and Safari™ 1.0 for Macintosh<sup>®</sup>. Please also make sure that JavaScript and Cookies are always enabled in whichever browser you use. We recommend you upgrade to Safari™ 1.2 or higher to enable JavaScript. To use a web browser, you will need to know the IP address of the print server.

- 1 Start the web browser.
- 2 Type “https://Common Name/” into your browser. (Where “Common Name” is the Common Name that you assigned for the certificate, such as an IP address, node name or domain name. For how to assign a Common Name for the certificate, see *Creating and installing a certificate* on page 52.)

- For example:

`https://192.168.1.2/` (If the Common Name is the printer’s IP address)

`https://BRNxxxxxxx/` (If the Common Name is the printer’s node name)

#### Note

If you have edited the hosts file on your computer or are using a Domain Name System, you can also enter the DNS name of the print server. As the print server supports TCP/IP and NetBIOS names, you can also enter the NetBIOS name of the print server. The NetBIOS name can be seen in the Network Configuration List. To learn how to print the Network Configuration List, see *Printing the Network Configuration List* on page 25. The NetBIOS name assigned is the first 15 characters of the node name and by default it will appear as “BRNxxxxxxx” where “xxxxxxx” is the last six digits of the Ethernet address.

- 3 You can now access the printer using HTTPS.

#### Note

Disable the Telnet, FTP and TFTP protocols. Accessing the machine using these protocols is not secure. For how to configure the protocol settings, see *Using Web Based Management (web browser) to change the print/scan settings* on page 14.

## Secure Management using BRAdmin Professional (for Windows®)

---

To use the BRAdmin Professional utility securely, you need to follow the points below.

- We strongly recommend to use the latest version of the BRAdmin Professional utility or Web BRAdmin that are available as a download from <http://solutions.brother.com>. If you use an older version of BRAdmin <sup>1</sup> to manage your brother devices the user authentication will not be secure.
- If you want to avoid access to your printer from older version of BRAdmin, you need to disable the older versions of BRAdmin from Advanced Setting of SNMP on Configure Protocol page by using Web Based Management (web browser). See *Using Web Based Management (web browser) to change the print/scan settings* on page 14.
- Disable the Telnet, FTP and TFTP protocols. Accessing the machine using these protocols is not secure. For how to configure the protocol settings, see *Using Web Based Management (web browser) to change the print/scan settings* on page 14.
- If you use Web Based Management (web browser), use it with HTTPS protocol. See *Secure Management using Web Based Management (web browser)* on page 47.
- If you are managing a mixed group of older print servers <sup>2</sup> and the new NC-6500h print server with BRAdmin Professional, we recommend using a different password in each group. This will ensure security is maintained on the new NC-6500h print server.

<sup>1</sup> BRAdmin Professional older than Ver. 2.80, Web BRAdmin older than Ver. 1.40, BRAdmin Light for Macintosh® older than Ver. 1.10

<sup>2</sup> NC-2000 series, NC-2100p, NC-3100h, NC-3100s, NC-4100h, NC-5100h, NC-5200h, NC-6100h, NC-6200h, NC-6300h, NC-6400h, NC-8000, NC-100h, NC-110h, NC-120w, NC-130h, NC-140w, NC-8100h, NC-9100h, NC-7100w, NC-7200w, NC-2200w



## Printing documents securely using IPPS

To print documents securely over the internet, you can use the IPPS protocol.



### Note

- Communication using IPPS cannot prevent unauthorized access to the printer server.
- IPPS is available for Windows® 2000/XP, Windows Vista™ and Windows Server® 2003.

To use the IPPS protocol, the following printer settings are required.

- A certificate and private key must be installed in the printer. How to install certificate and private key, see *Creating and installing a certificate* on page 52.
- The HTTPS protocol must be enabled. To enable the HTTPS protocol, see *Using Web Based Management (web browser) to change the print/scan settings* on page 14.

The basic steps for IPPS printing are the same as IPP printing. For detailed information, see *Internet printing for Windows®* in Chapter 6.

## Specifying a different URL

Please note that there are several possible entries that you can enter for the URL field.

`https://Common Name/ipp`

This is the default URL and we recommend that you use this URL. Please note the **Get More Info** option will not display any printer data.

`https://Common Name/ipp/port1`

This is for HP® Jetdirect® compatibility. Please note the **Get More Info** option will not display any printer data.

`https://Common Name/`

If you forget the URL details, you can simply enter the above text (`https://printer's IP address/`) and the printer will still receive and process data.



### Note

If you forget the URL details, you can simply enter the above text (`https://Common Name/`) and the printer will still receive and process data.

Where `Common Name` is that you assigned for the certificate, such as an IP address, node name or domain name. For how to assign a Common Name for the certificate, see *Creating and installing a certificate* on page 52.

- For example:

`https://192.168.1.2/` (If the Common Name is the printer's IP address)

`https://BRNxxxxxx/` (If the Common Name is the printer's node name)

## Using E-mail notification with user authentication

To use the E-mail notification function via secure SMTP server that requires a user authentication, you need to use POP before SMTP and SMTP-AUTH methods. These methods prevent an unauthorized user from accessing the mail server. You can use Web Based Management (web browser), BRAdmin professional and Web BRAdmin to configure these settings.



### Note

You need to match the settings of POP3/SMTP authentication with one of the E-mail servers. Contact your network administrator or your internet service provider about the configuration before using.

How to configure the POP3/SMTP settings using Web Based Management (web browser).

- 1 Start your web browser.
- 2 Type “http://printer’s IP address/” into your browser (where “printer’s IP address” is the printer’s IP address or the node name.).
  - For example:
    - http://192.168.1.2/ (if the printer’s IP address is 192.168.1.2.)
    - http://BRN123456/ (if the printer’s node name is BRN123456.)



### Note

If you have edited the hosts file on your computer or are using Domain Name System, you can also enter the DNS name of the print server. As the print server supports TCP/IP and NetBIOS names, you can also enter the NetBIOS name of the print server. The NetBIOS name can be seen in the Network Configuration List. To learn how to print the Network Configuration List, see *Printing the Network Configuration List* on page 25. The NetBIOS name assigned is the first 15 characters of the node name and by default it will appear as “BRNxxxxxx” where “xxxxxx” is the last six digits of the Ethernet address.

- 3 Click **Network Configuration**.
- 4 Click **Configure Protocol**.
- 5 Click **Advanced Setting** of **POP3/SMTP**.

- 6 You can configure the POP3/SMTP settings on this page.

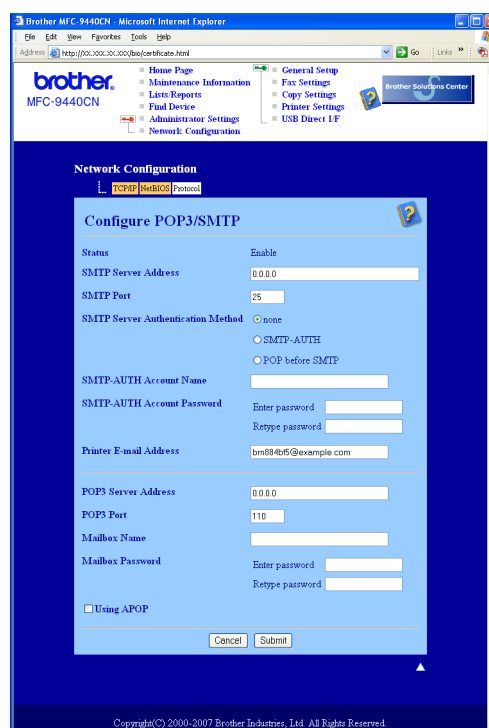

### Note

- You can also change the SMTP port number using Web Based Management. This is useful if your ISP (Internet Service Provider) implements the “Outbound Port 25 Blocking (OP25B)” service, and you are not using the ISP’s SMTP server. By changing the SMTP port number to a specific number which your SMTP server decide (for example, port 587), you can still send an E-mail via the SMTP server you currently use. You will also need to check **SMTP-AUTH** of **SMTP Server Authentication Method** to enable the SMTP server authentication.
- If you can use both POP before SMTP and SMTP-AUTH, we recommend choosing SMTP-AUTH.
- If you choose POP before SMTP for the SMTP Server Authentication Method, you need to configure the POP3 settings. You can also use the APOP method.
- For more information, see the Help text in the Web Based Management.
- You can also confirm whether the E-mail settings are correct after configuration by sending a test E-mail.

- 7 After configuring, click **Submit**. The Test E-mail Send Configuration dialog appears.

- 8 Follow the instruction on-screen, if you want to test with the current settings.

## Creating and installing a certificate

The Brother print server allows you to use SSL/TLS communication by configuring a certificate and corresponding private key. This print server supports two certification methods. A self-signed certificate and a certificate that is issued by a CA (Certificate Authority).

### ■ Using self-signed certificate

This print server issues its own certificate. Using this certificate, you can easily use the SSL/TLS communication without having a certificate from a CA. See *Creating and installing a self-signed certificate* on page 54.

### ■ Using a certificate from a CA

There are two methods for installing a certificate from a CA. If you already have a CA or if you want to use a certificate from an outside trusted CA:

- When using a CSR (Certificate Signing Request) from this print server. See *Creating CSR and installing a certificate* on page 66.
- When importing a certificate and a private key. See *Import and export the certificate and private key* on page 68.



### Note

- If you are going to use SSL/TLS communication, we recommend that you contact your system administrator before using.
- This print server stores only one pair of a certificate and a private key that you installed or previously imported. This printer overwrites the certificate and the private key if you install a new one.
- When you reset the print server back to its default factory settings, the certificate and the private key that are installed will be deleted. If you want to keep the same certificate and the private key after resetting the print server, export them before resetting and re-install them. See *How to export the certificate and private key* on page 69.

This feature can be configured using Web Based Management (web browser) only. Follow these steps to access the configure certificate page using Web Based Management.

- 1 Start your web browser.
- 2 Type “http://printer’s IP address/” into your browser. (where “printer’s IP address” is the printer’s IP address or the node name.)
  - For example:
    - http://192.168.1.2/ (if the printer’s IP address is 192.168.1.2.)
    - http://BRN123456/ (if the printer’s node name is BRN123456.)



### Note

If you have edited the hosts file on your computer or are using Domain Name System, you can also enter the DNS name of the print server. As the print server supports TCP/IP and NetBIOS names, you can also enter the NetBIOS name of the print server. The NetBIOS name can be seen in the Network Configuration List. To learn how to print the Network Configuration List, see *Printing the Network Configuration*

List on page 25. The NetBIOS name assigned is the first 15 characters of the node name and by default it will appear as “BRNxxxxxx” where “xxxxxx” is the last six digits of the Ethernet address.

- 3 Click **Network Configuration**.
- 4 Enter a user name and a password. The default User Name is “**admin**” and the default Password is “**access**”.
- 5 Click **OK**.
- 6 Click **Configure Certificate**.
- 7 You can configure the certificate settings from the screen below.



### Note

- The functions that are grayed and unlinked indicate they are not available.
- For more information on configuration, see the Help text in the Web Based Management.

## Creating and installing a self-signed certificate

### How to create and install a self-signed certificate

- 1 Click **Create Self-Signed Certificate** on the **Configure Certificate** page.
- 2 Enter a **Common Name** and a **Valid Date**, then click **Submit**.



#### Note

- The length of the **Common Name** is less than 64 bytes. Enter an identifier such as an IP address, node name or domain name to use when accessing this printer through SSL/TLS communication. The node name is displayed by default.
  - A warning will pop-up if you enter a different name in URL than the **Common Name** that was used for the self-signed certificate.
- 3 Now the self-signed certificate is created successfully. Check the box on the left of each function you want to disable, and then click **OK**.

By using the configuration that you specified, this printer is enabled in secure communication mode. Changing the configuration of the following functions is recommended for secure communication. Please confirm the items you want to change, and click the 'OK' button. Check the box on the left of the function you would like to disable and click the "OK" button. (See Network User's Guide.)

- Disable Telnet
- Disable FTP
- Disable TFTP
- Disable network management with older versions of BRAdmin

OK



#### Note

- We recommend disabling the Telnet, FTP, TFTP protocols and the network management with older versions of BRAdmin <sup>1</sup> for secure communication. If you enable them, the user authentication is not secure.
- A check box only appears for an individual protocol or the older BRAdmin utility if they are already enabled.

<sup>1</sup> BRAdmin Professional older than Ver. 2.80, Web BRAdmin older than Ver. 1.40, BRAdmin Light for Macintosh® older than Ver. 1.10.

- 4 Restart the printer to activate the configuration.
- 5 Now the self-signed certificate is saved in your printer memory. To use SSL/TLS communication, the self-signed certificate also needs to be installed on your computer. Proceed to the next section.

## How to install the certificate to your printer

### Note

The following steps are for Microsoft Internet Explorer. If you use another web browser, follow the help text of the web browser itself.

### For Windows Vista™ users that have administrator rights

- 1 Log on your computer with Administrator rights. Click **Start** and **All Programs**.
- 2 Right click **Internet Explorer**, and then click **Run as administrator**.

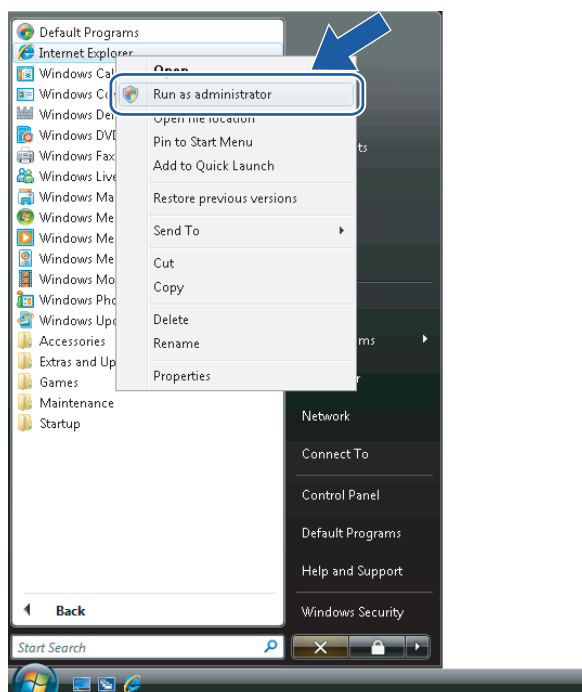

- 3 Click **Allow**.

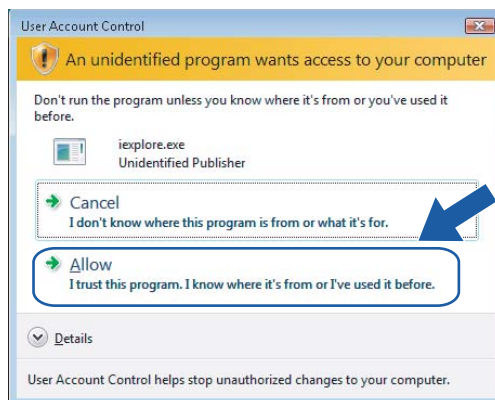

- 4 Type “https://printer’s IP address/” into your browser to access your printer (where “printer’s IP address” is the printer’s IP address or the node name). Then, click **Continue to this website (not recommended)**.

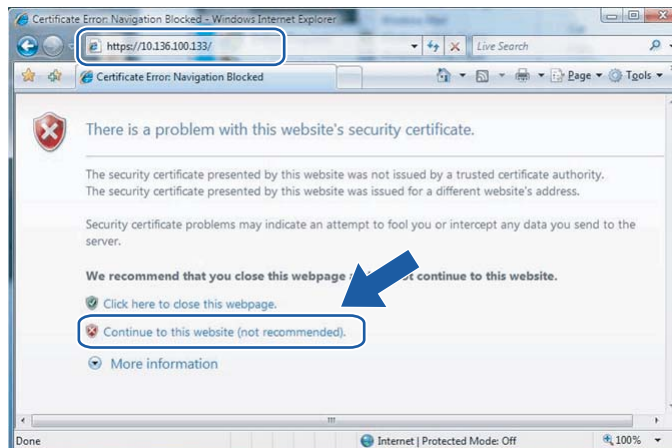

- 5 Click **Certificate Error**, and then click **View certificates**. For the rest of the instructions, follow the steps from 4 on page 63.

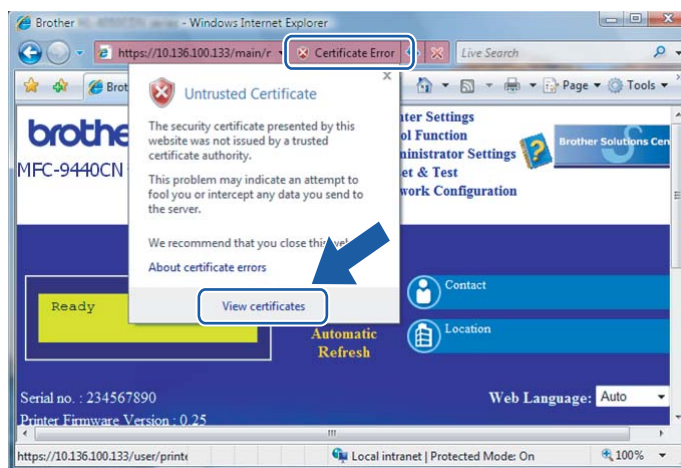



## For Windows Vista™ users that do not have administrator rights

- 1 Click **Start** and **All Programs**.
- 2 Right click **Internet Explorer**, and then click **Run as administrator**.

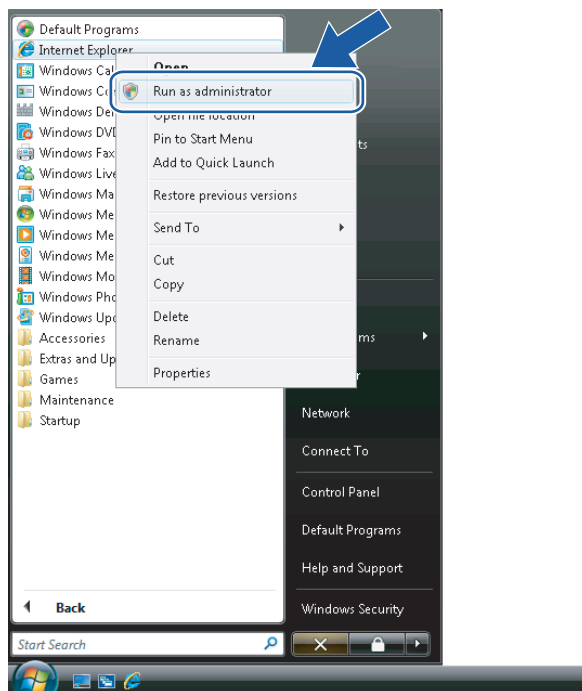

- 3 Choose the Administrator that you want to install with and enter the administrator password, and then click **OK**.

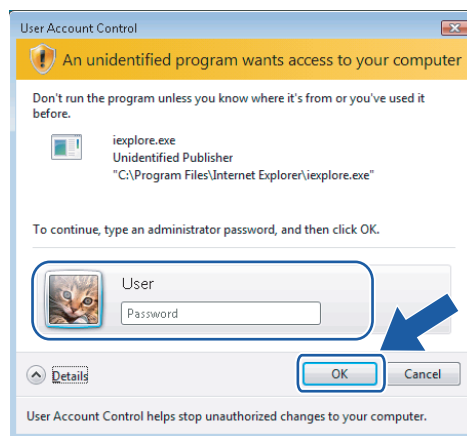

- 4 Type “https://printer’s IP address/” into your browser to access your printer (where “printer’s IP address” is the printer’s IP address or the node name). Then, click **Continue to this website (not recommended)**.

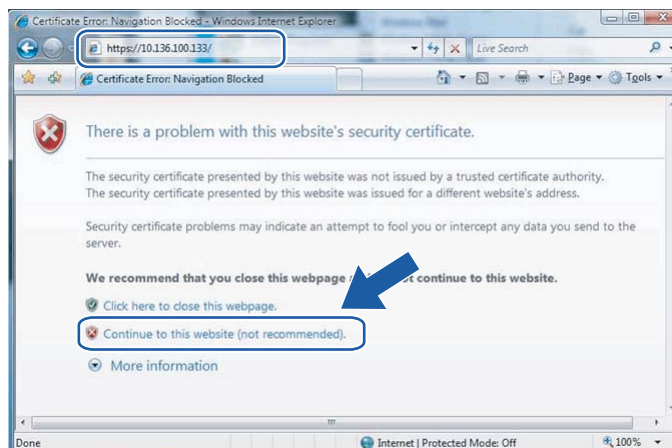

- 5 Click **Certificate Error**, and then click **View certificates**.

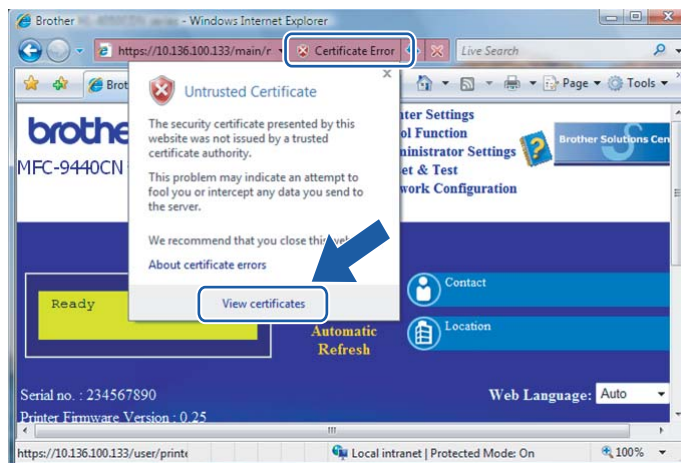

- 6 Choose the **Details** tab, and then click **Copy to File...**

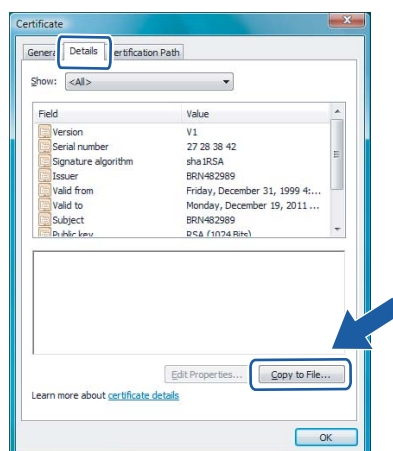

7 Click **Next**.



8 Make sure that **DER encoded binary X.509 (.CER)** is chosen, and then click **Next**.

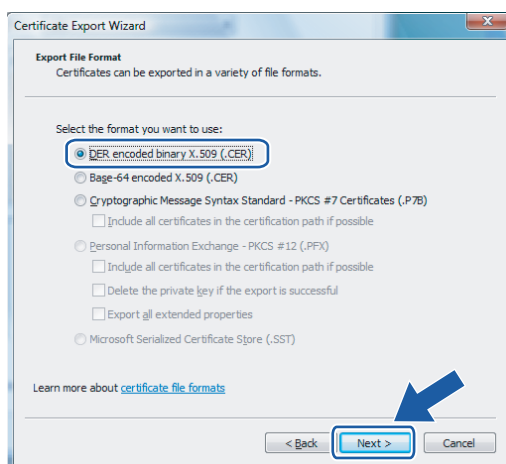

9 Click **Browse...**

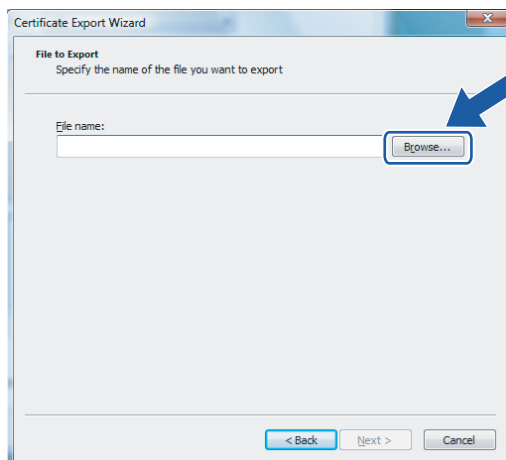

- 10 Click **Browse Folders**.

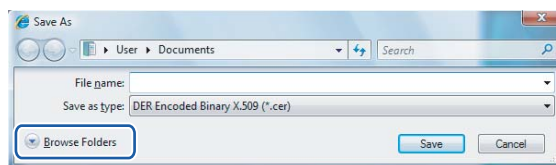

- 11 Choose a folder you want to save the certificate file in and enter a file name, and then click **Save**.

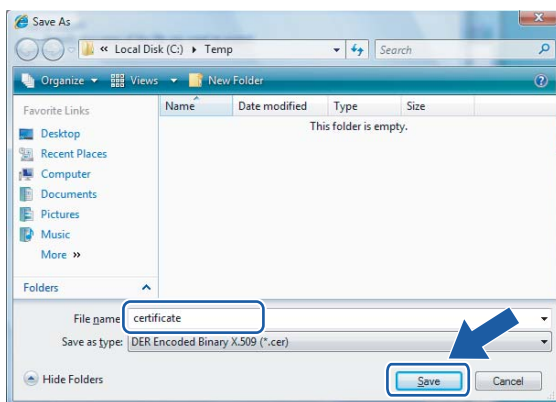
**Note**

If you choose **Desktop**, the certificate file is saved to the Desktop of Administrator that you chose.

- 12 Click **Next**.

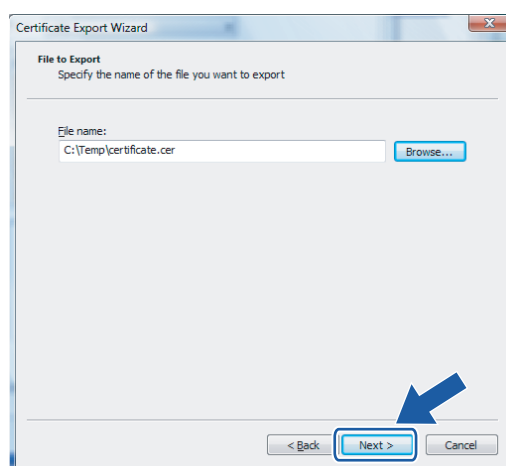

- 13 Click **Finish**.

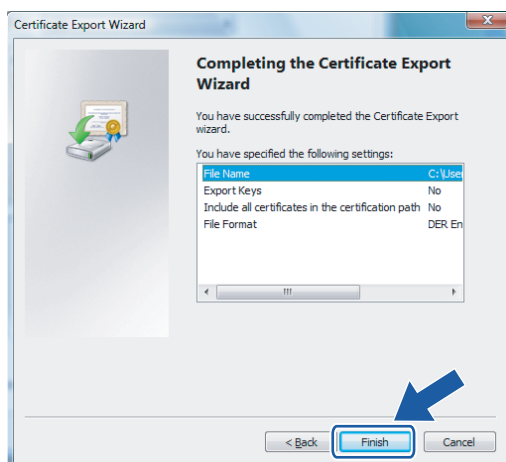

- 14 Click **OK**.

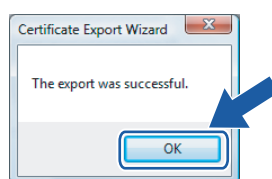

- 15 Click **OK**.

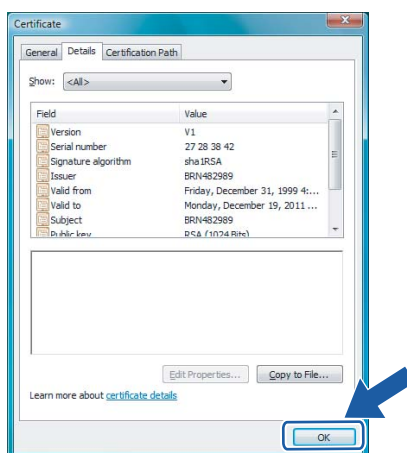

- 16 Open the folder that you saved the certificate file in 11 and double-click the certificate file. For the rest of the instructions, follow the steps from 4 on page 63.

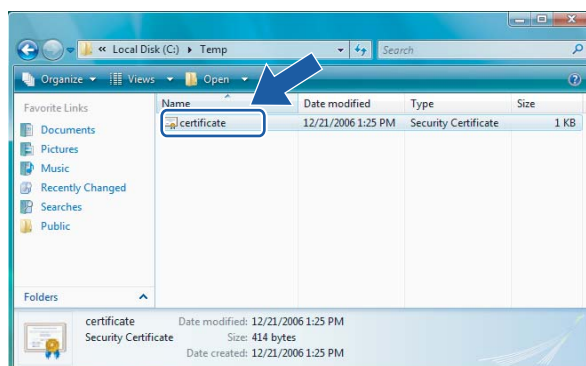

### For Windows® 2000/XP and Windows Server® 2003 users

- 1 Start the web browser.
- 2 Type “https://printer’s IP address/” into your browser to access your printer (where “printer’s IP address” is the IP address or the print Common Name that you assigned for the certificate).
- 3 When the following dialog appears, click **View Certificate**.

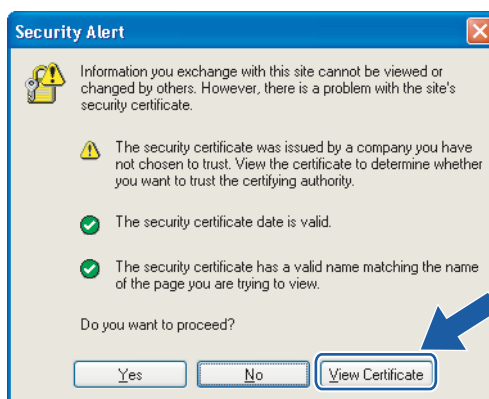

- 4 Click **Install Certificate...** from the **General** tab.

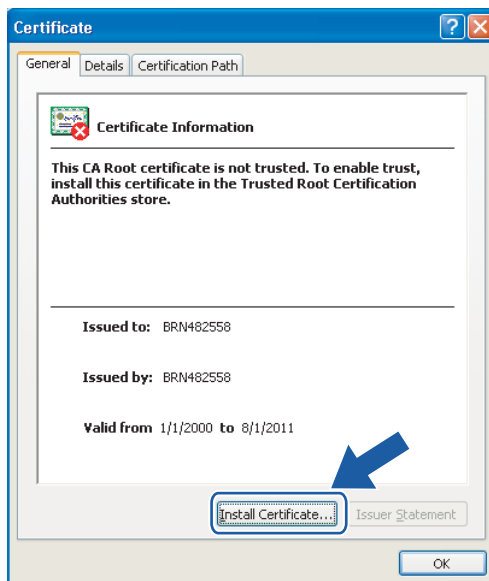

- 5 When the **Certificate Import Wizard** appears, click **Next**.

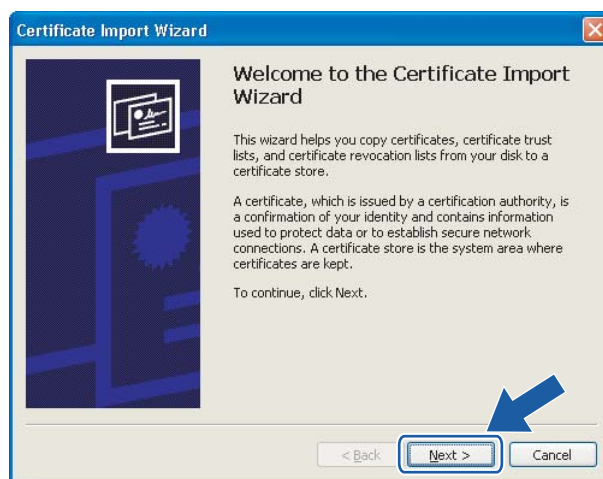

- 6 Choose **Place all certificates in the following store** and then, click **Browse...**

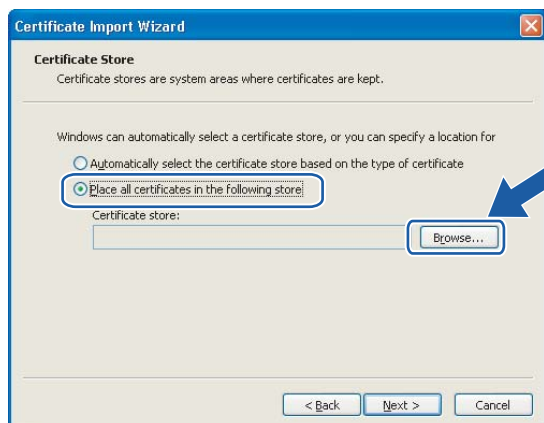

- 7 Choose **Trusted Root Certification Authorities** and then, click **OK**.



- 8 Click **Next**.

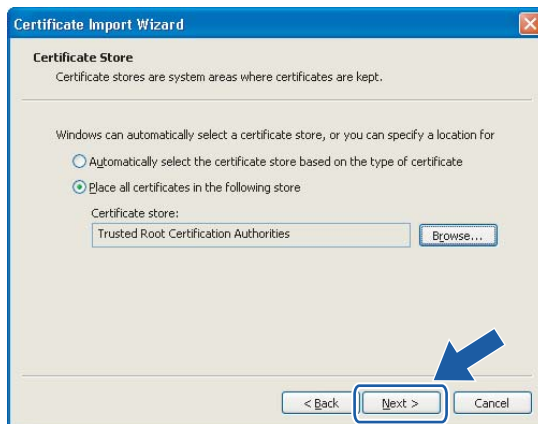

- 9 Click **Finish**.

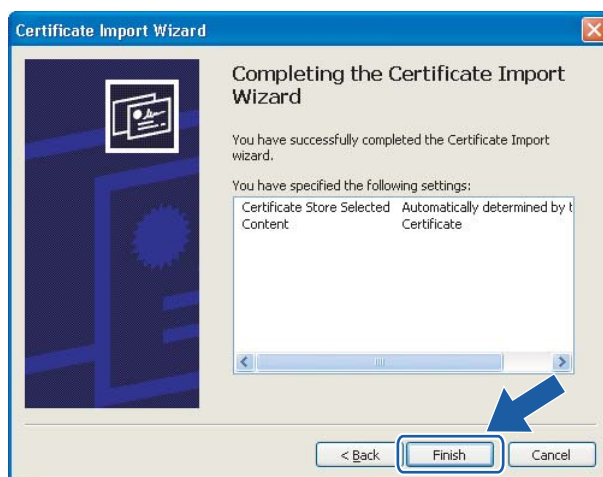



- Click **Yes**, if the fingerprint (thumbprint) is correct.

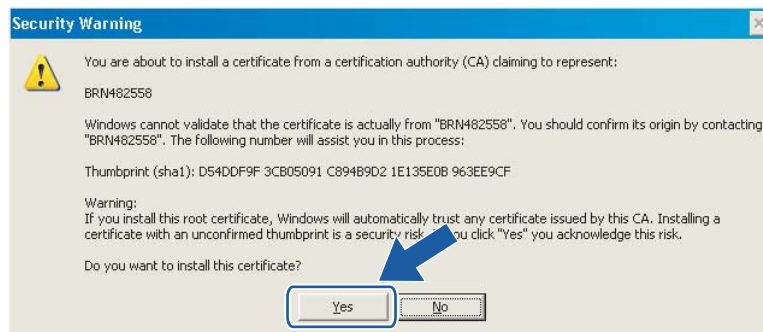

 **Note**

The fingerprint (thumbprint) is printed on the Network Configuration List. To learn how to print the Network Configuration List, see *Printing the Network Configuration List* on page 25.

- Click **OK**.



- Now the self-signed certificate is installed on your computer, and the SSL/TLS communication is available.

## Creating CSR and installing a certificate

---

### How to create the CSR

- 1 Click **Create CSR** on the **Configure Certificate** page.
- 2 Enter a **Common Name** and your information, such as **Organization**. Then click **Submit**.



#### Note

---

- We recommend that the Root Certificate from the CA be installed on your computer before creating the CSR.
- The length of the **Common Name** is less than 64 bytes. Enter an identifier such as an IP address, node name or domain name to use when accessing this printer through SSL/TLS communication. The node name is displayed by default. The **Common Name** is required.
- A warning will pop-up if you enter a different name in the URL than the **Common Name** that was used for the certificate.
- The length of the **Organization**, the **Organization Unit**, the **City/Locality** and the **State/Province** is less than 64 bytes.
- The **Country/Region** should be an ISO 3166 country code composed of two characters.

- 3 When the contents of the CSR appear, click **Save** to save the CSR file to your computer.
- 4 Now the CSR is created.



#### Note

---

- Follow your CA policy regarding the method to send a CSR to your CA.
  - If you are using **Enterprise root CA** of Windows Server<sup>®</sup> 2003, we recommend using the **Web Server Certificate Template** when creating the certificate. For more information, visit us at <http://solutions.brother.com>.
-

## How to install the certificate to your printer

When you receive the certificate from a CA, follow the steps below to install it into the print server.



### Note

Only a certificate issued with this printer's CSR can be installed.

- 1 Click **Install Certificate** on the **Configure Certificate** page.
- 2 Specify the file of the certificate that has been issued by a CA, and then click **Submit**.
- 3 Now the certificate is created successfully. Check the box on the left of each function you want to disable, and then click **OK**.

By using the configuration that you specified, this printer is enabled in secure communication mode. Changing the configuration of the following functions is recommended for secure communication. Please confirm the items you want to change, and click the 'OK' button. Check the box on the left of the function you would like to disable and click the "OK" button. (See Network User's Guide.)

- Disable Telnet
- Disable FTP
- Disable TFTP
- Disable network management with older versions of BRAdmin

OK



### Note

- We recommend disabling the Telnet, FTP, TFTP protocols and the network management with older versions of BRAdmin <sup>1</sup> for secure communication. If you enable them, the user authentication is not secure.
- A check box only appears for an individual protocol or the older BRAdmin utility if they are already enabled.

<sup>1</sup> BRAdmin Professional older than Ver. 2.80, Web BRAdmin older than Ver. 1.40, BRAdmin Light for Macintosh® older than Ver. 1.10.

- 4 Restart the printer to activate the configuration.
- 5 Now the certificate is saved in your printer. To use SSL/TLS communication, the Root Certificate from the CA needs to be installed on your computer. Contact your network administrator about installation.

## Import and export the certificate and private key

### How to import the certificate and private key

- 1 Click **Import Certificate and Private Key** on the **Configure Certificate** page.
- 2 Specify the file that you want to import.
- 3 Enter the password if the file is encrypted, and then click **Submit**.
- 4 Now the certificate and private key are imported successfully. Check the box on the left of each function you want to disable, and then click **OK**.

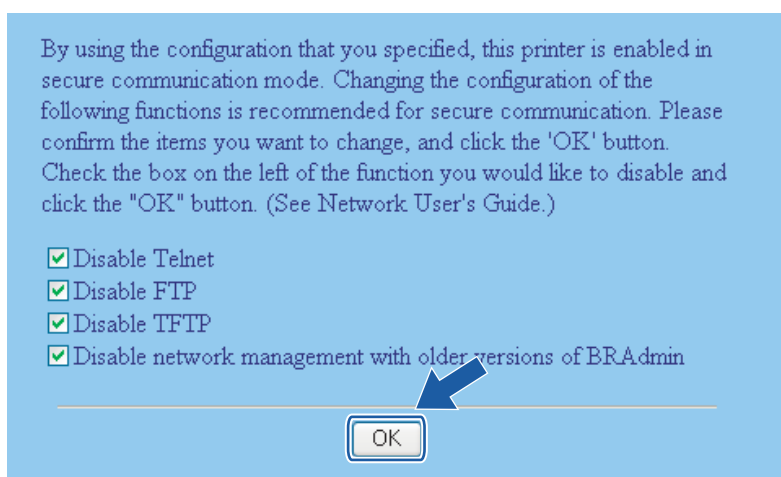

#### Note

- We recommend disabling the Telnet, FTP, TFTP protocols and the network management with older versions of BRAdmin <sup>1</sup> for secure communication. If you enable them, the user authentication is not secure.
- A check box only appears for an individual protocol or the older BRAdmin utility if they are already enabled.

<sup>1</sup> BRAdmin Professional older than Ver. 2.80, Web BRAdmin older than Ver. 1.40, BRAdmin Light for Macintosh® older than Ver. 1.10.

- 5 Restart the printer to activate the configuration.
- 6 Now the certificate and private key are imported to your printer. To use SSL/TLS communication, the Root Certificate from the CA needs to also be installed on your computer. Contact your network administrator about the installation.

## How to export the certificate and private key

- 1 Click **Export Certificate and Private Key** on the **Configure Certificate** page.
- 2 Enter the password if you want to encrypt the file.

**Note**

---

If a blank password is used, the output is not encrypted.

---

- 3 Enter the password again for confirmation, and then click **Submit**.
- 4 Specify the location where you want to save the file.
- 5 Now the certificate and private key are exported to your computer.

**Note**

---

You can import the file that you exported.

---

## Overview

This chapter explains how to resolve typical network problems you may encounter when using the machine. If, after reading this chapter, you are unable to resolve your problem, please visit the Brother Solutions Center at: <http://solutions.brother.com>

This chapter is divided into the following sections:

- General problems
- Network print software installation problems
- Printing problems
- Scanning and PC Fax problems
- Protocol-specific troubleshooting

## General problems

### CD-ROM is inserted, but does not start automatically

If your computer does not support Autorun, the menu will not start automatically after inserting the CD-ROM. In this case, execute **setup.exe** in the root directory of the CD-ROM.

### My computer cannot find the machine/print server

#### My machine/print server does not appear in the window of Remote Setup, BRAdmin Light or BRAdmin Professional

- For Windows®

Firewall on your computer may be blocking the necessary network connection to the machine. In this case, you will need to disable the Firewall on your computer and re-install the drivers.

#### Windows® XP SP2 users:

- 1 Click the **Start** button, **Control Panel**, **Network and Internet Connections**.
- 2 Double click **Windows Firewall**.
- 3 Click the **General** tab. Make sure that **Off (not recommended)** is selected.
- 4 Click **OK**.



#### Note

After the Brother software package is installed, enable again your Firewall.

**Windows Vista™ users:**

- 1 Click the **Start** button, **Control Panel**, **Network and Internet**, **Windows Firewall** and click **Change settings**.
- 2 When the **User Account Control** screen appears, do the following.
  - Users who have administrator rights: Click **Continue**.
  - For users who do not have administrator rights: Enter the administrator password and click **OK**.
- 3 Click the **General** tab. Make sure that **Off (not recommended)** is selected.
- 4 Click **OK**.

**Note**

---

After the Brother software package is installed, enable again your Firewall.

---

- For Macintosh®

Re-select your machine in the DeviceSelector application located in Macintosh **HD/Library/Printers/Brother/Utilities** or from the model pull-down list of ControlCenter3.

## Network print software installation problems

The Brother print server is not found during setup of the network print software installation or from the printer driver of the Brother machine in Windows®.

10

The Brother print server is not found using the Simple Network Configuration capabilities of Mac OS® X.

Make sure you have completed the IP address setting of the Brother print server according to Chapter 2 of this User's Guide before installing the network print software or printer driver.

Check the following:

- 1 Make sure that the machine is powered on, is on-line and ready to print.
- 2 Check to see if there is any LED activity. Brother print servers have two LEDs on the back panel of the machine. The upper green LED shows Link/Activity (Received/Transmit) status. The lower orange LED shows Speed status.
  - No light: If the upper LED is off, then the print server is not connected to the network.
  - The upper LED is green: The Link/Activity LED will be green if the print server is connected to a Ethernet network.
  - The lower LED is orange: The Speed LED will be orange if the print server is connected to a 100BASE-TX Fast Ethernet network.
  - The lower LED is off: The Speed LED will be off if the print server is connected to a 10BASE-T Ethernet network.

- 3 Print the Network Configuration List and check if the settings such as IP address settings are correct for your network. The problem may be the result of mismatched or duplicate IP address. Verify that the IP address is correctly loaded into the print server. And make sure that no other nodes on the network have this IP address. For information on how to print the Network Configuration List, see *Printing the Network Configuration List* on page 25.
- 4 Verify that the print server is on your network as follows:
  - **For Windows®**

Try pinging the print server from the host operating system command prompt with the command:

```
ping ipaddress
```

Where `ipaddress` is the print server IP address (note that in some instances it can take up to two minutes for the print server to load its IP address after setting the IP address).
  - **For Mac OS® X 10.2.4 or greater**
    - 1 From the **Go** menu, select **Applications**.
    - 2 Open the **Utilities** folder.
    - 3 Double click the **Terminal** icon.
    - 4 Try pinging the print server from the Terminal window:
 

```
ping ipaddress
```

Where `ipaddress` is the print server IP address (note that in some instances it can take up to two minutes for the print server to load its IP address after setting the IP address).
- 5 If you have tried 1 to 4 above and it does not work, then reset the print server back to the default factory settings and try from the initial setup again. For information how to reset to the default factory settings, see *Restoring the network settings to factory default* on page 26.
- 6 Check the following:
 

If the installation failed, the Firewall on your computer may be blocking the necessary network connection to the machine. In this case, you will need to disable the Firewall on your computer and re-install the drivers. For more information, see *General problems* on page 70. If you are using a personal Firewall software, see the User's Guide for your software or contact the software manufacturer.

## Printing problems

### Print job is not printed

Make sure the status and configuration of the print server. Check following:

- 1 Make sure that the machine is powered on, is on-line and ready to print.
- 2 Print the Network Configuration List of the machine and check if the settings such as IP address settings are correct for your network. The problem may be the result of mismatched or duplicate IP address. Verify that the IP address is correctly loaded into the print server. And make sure that no other nodes on the network have this IP address. For information on how to print the Network Configuration List, see *Printing the Network Configuration List* on page 25.



### 3 Verify that the print server is on your network as follows:

#### ■ For Windows®

- 1 Try pinging the print server from the host operating system command prompt with the command:

```
ping ipaddress
```

Where `ipaddress` is the print server IP address (note that in some instances it can take up to two minutes for the print server to load its IP address after setting the IP address).

- 2 If a successful response is received, then proceed to *Windows® 2000/XP*, *Windows Vista™*, *Windows Server® 2003 IPP troubleshooting* on page 76. Otherwise, proceed to 4.

#### ■ For Mac OS® X 10.2.4 or greater

- 1 From the **Go** menu, select **Applications**.
- 2 Open the **Utilities** folder.
- 3 Double click the **Terminal** icon.
- 4 Try pinging the print server from the Terminal window:

```
ping ipaddress
```

Where `ipaddress` is the print server IP address (note that in some instances it can take up to two minutes for the print server to load its IP address after setting the IP address).

- 4 If you have tried 1 to 3 above and it does not work, then reset the print server back to the default factory settings and try from the initial setup again. For information how to reset to the default factory settings, see *Restoring the network settings to factory default* on page 26.

### Error during printing

If you try to print while other users are printing large amounts of data (e.g. many pages or color pages with high resolution), the printer is unable to accept your print job until the ongoing printing is finished. If the waiting time of your print job exceeds a certain limit, a time out situation occurs, which causes the error message. In such situations, execute the print job again after the other jobs are completed.

## Scanning and PC Fax problems

**The network scanning feature does not work in Windows®**

**The network PC Fax feature does not work in Windows®**

Firewall setting on your PC may be rejecting the necessary network connection. Follow the instructions below to disable the Firewall. If you are using a personal Firewall software, see the User's Guide for your software or contact the software manufacturer.

**Windows® XP SP2 users:**

- 1 Click the **Start** button, **Control Panel**, **Network and Internet Connections** and then **Windows Firewall**. Make sure that **Windows Firewall** on the **General** tab is set to On.
- 2 Click the **Advanced** tab and **Settings...** button of **Network Connection Settings**.
- 3 Click the **Add** button.
- 4 To add port 54925 for network scanning, enter the information below:
  1. In **Description of service**: Enter any description, for example, "Brother Scanner".
  2. In **Name or IP address (for example 192.168.0.12) or the computer hosting this service on your network**: Enter "Localhost".
  3. In **External Port Number for this service**: Enter "54925".
  4. In **Internal Port Number for this service**: Enter "54925".
  5. Make sure **UDP** is selected.
  6. Click **OK**.
- 5 Click the **Add** button.
- 6 To add port 54926 for network PC Fax, enter the information below:
  1. In **Description of service**: Enter any description, for example, "Brother PC Fax".
  2. In **Name or IP address (for example 192.168.0.12) or the computer hosting this service on your network**: Enter "Localhost".
  3. In **External Port Number for this service**: Enter "54926".
  4. In **Internal Port Number for this service**: Enter "54926".
  5. Make sure **UDP** is selected.
  6. Click **OK**.
- 7 If you still have trouble with your network connection, click the **Add** button.
- 8 To add port 137 for network scanning, network printing and network PC Fax receiving, enter the information below:
  1. In **Description of service**: Enter any description, for example, "Brother PC Fax receiving".
  2. In **Name or IP address (for example 192.168.0.12) or the computer hosting this service on your network**: Enter "Localhost".
  3. In **External Port Number for this service**: Enter "137".
  4. In **Internal Port Number for this service**: Enter "137".
  5. Make sure **UDP** is selected.
  6. Click **OK**.

- 9 Make sure if the new setting is added and is checked, and then click **OK**.

**Note**

---

After the Brother software package is installed, enable again your Firewall.

---

**Windows Vista™ users:**

- 1 Click the **Start** button, **Control Panel**, **Network and Internet**, **Windows Firewall** and click **Change settings**.
- 2 When the **User Account Control** screen appears, do the following.
  - Users who have administrator rights: Click **Continue**.
  - For users who do not have administrator rights: Enter the administrator password and click **OK**.
- 3 Make sure that **on (recommended)** is selected on the **General** tab.
- 4 Click the **Exceptions** tab.
- 5 Click the **Add port...** button.
- 6 To add port 54925 for network scanning, enter the information below:
  1. In **Name**: Enter any description, for example, "Brother Scanner".
  2. In **Port number**: Enter "54925".
  3. Make sure **UDP** is selected.
  4. Click **OK**.
- 7 Click the **Add port...** button.
- 8 To add port 54926 for network PC Fax, enter the information below:
  1. In **Name**: Enter any description, for example, "Brother PC Fax".
  2. In **Port number**: - Enter "54926".
  3. Make sure **UDP** is selected.
  4. Click **OK**.
- 9 Make sure that the new setting is added and is checked, and then click **Apply**.
- 10 If you still have trouble with your network connection such as network scanning or printing, check **File and Printer Sharing** box in the **Exceptions** tab and then click **Apply**.

**Note**

---

After the Brother software package is installed, enable again your Firewall.

---

## Protocol-specific troubleshooting

### Windows® 2000/XP, Windows Vista™, Windows Server® 2003 IPP troubleshooting

---

#### I want to use a different Port number other than 631.

If you are using Port 631 for IPP printing, you may find that your firewall may not let the print data through. If this is the case, use a different port number (port 80), or configure your Firewall to allow Port 631 data through.

To send a print job using IPP to a printer using Port 80 (the standard HTTP port) enter the following when configuring your Windows® 2000/XP, Windows Vista™ and Windows Server® 2003 system.

```
http://ipaddress/ipp
```

#### The “Go to printer’s Web site” option in Windows® XP and Windows Vista™ is not working The “Get More Info” option in Windows® 2000 and Windows Server® 2003 is not working

If you are using a URL of:

```
http://ipaddress:631 or http://ipaddress:631/ipp,
```

the **Get More Info** option in Windows® 2000/XP, Windows Vista™ and Windows Server® 2003 will not function. If you wish to use the **Get More Info** option, use the following URL:

```
http://ipaddress
```

This will then force Windows® 2000/XP, Windows Vista™ and Windows Server® 2003 to use Port 80 to communicate with the Brother print server.

### Web browser troubleshooting (TCP/IP)

---

- 1 If you can not connect to the print server using your web browser it may be worth checking the Proxy Settings of your browser. Looking in the Exceptions setting and if necessary, type in the IP address of the print server. This will stop your PC from trying to connect to your ISP or proxy server every time you wish to look at the print server.
- 2 Make sure that you are using the proper web browser, we recommend Microsoft Internet Explorer 6.0® (or higher) or Firefox® 1.0 (or higher) for Windows® and Safari™ 1.0 for Macintosh®. Please also make sure that JavaScript and Cookies are always enabled in whichever browser you use. We recommend you upgrade to Safari™ 1.2 or higher to enable JavaScript. If a different web browser is used, make sure it is compatible with HTTP 1.0 and HTTP 1.1.

## Using services

A service is a resource that can be accessed by computers that wish to print to the Brother print server. The Brother print server provides the following predefined services (do a SHOW SERVICE command in the Brother print server remote console to see a list of available services): Enter HELP at the command prompt for a list of supported commands.

Service (Example)	Definition
BINARY_P1	TCP/IP binary, NetBIOS service
TEXT_P1	TCP/IP text service (adds carriage return after each line feed)
PCL_P1	PCL <sup>®</sup> service (switches PJL-compatible printer to PCL <sup>®</sup> mode)
BRNxxxxxx_P1	TCP/IP binary
BRNxxxxxx_P1_AT	PostScript <sup>®</sup> service for Macintosh <sup>®</sup>
POSTSCRIPT_P1	PostScript <sup>®</sup> service (switches PJL-compatible printer to PostScript <sup>®</sup> mode)

Where xxxxxxx is the last six digits of the Ethernet address (for example, BRN310107\_P1).

## Other ways to set the IP address (for advanced users and administrators)

For information on how to configure your machine for a network using the BRAdmin Professional utility, see *Setting the IP address and subnet mask* on page 10.

### Using DHCP to configure the IP address

The Dynamic Host Configuration Protocol (DHCP) is one of several automated mechanisms for IP address allocation. If you have a DHCP server in your network, the print server will automatically obtain its IP address from DHCP server and register its name with any RFC 1001 and 1002-compliant dynamic name services.



#### Note

If you do not want your print server configured via DHCP, BOOTP or RARP, you must set the BOOT Method to static so that the print server has a static IP address. This will prevent the print server from trying to obtain an IP address from any of these systems. To change the BOOT Method, use the machine's control panel, BRAdmin Professional utility, Remote Setup or Web Based Management (web browser).

## Using BOOTP to configure the IP address

---

BOOTP is an alternative to rarp that has the advantage of allowing configuration of the subnet mask and gateway. In order to use BOOTP to configure the IP address make sure that BOOTP is installed and running on your host computer (it should appear in the `/etc/services` file on your host as a real service; type `man bootpd` or refer to your system documentation for information). BOOTP is usually started up via the `/etc/inetd.conf` file, so you may need to enable it by removing the “#” in front of the bootp entry in that file. For example, a typical bootp entry in the `/etc/inetd.conf` file would be:

```
#bootp dgram udp wait /usr/etc/bootpd bootpd -i
```

Depending on the system, this entry might be called “bootps” instead of “bootp”.



### Note

---

In order to enable BOOTP, simply use an editor to delete the “#” (if there is no “#”, then BOOTP is already enabled). Then edit the BOOTP configuration file (usually `/etc/bootptab`) and enter the name, network type (1 for Ethernet), Ethernet address and the IP address, subnet mask and gateway of the print server. Unfortunately, the exact format for doing this is not standardized, so you will need to refer to your system documentation to determine how to enter this information (many UNIX<sup>®</sup> systems also have template examples in the `bootptab` file that you can use for reference). Some examples of typical `/etc/bootptab` entries include: (“BRN” below is “BRW” for a wireless network.)

```
BRN310107 1 00:80:77:31:01:07 192.168.1.2
```

and:

```
BRN310107:ht=ethernet:ha=008077310107:\
```

```
ip=192.168.1.2:
```

Certain BOOTP host software implementations will not respond to BOOTP requests if you have not included a download filename in the configuration file. If this is the case, simply create a null file on the host and specify the name of this file and its path in the configuration file.

As with rarp, the print server will load its IP address from the BOOTP server when the printer is powered on.

## Using RARP to configure the IP address

---

The Brother print server's IP address can be configured using the Reverse ARP (RARP) facility on your host computer. This is done by editing the `/etc/ethers` file (if this file does not exist, you can create it) with an entry similar to the following: ("BRN" below is "BRW" for a wireless network.)

```
00:80:77:31:01:07    BRN310107
```

Where the first entry is the Ethernet address of the print server and the second entry is the name of the print server (the name must be the same as the one you put in the `/etc/hosts` file).

If the `rarpd` daemon is not already running, start it (depending on the system the command can be `rarpd`, `rarpd -a`, `in.rarpd -a` or something else; type `man rarpd` or refer to your system documentation for additional information). To verify that the `rarpd` daemon is running on a Berkeley UNIX<sup>®</sup> based system, type the following command:

```
ps -ax | grep -v grep | grep rarpd
```

For AT&T UNIX<sup>®</sup>-based systems, type:

```
ps -ef | grep -v grep | grep rarpd
```

The Brother print server will get the IP address from the `rarpd` daemon when the printer is powered on.

## Using APIPA to configure the IP address

---

The Brother print server supports the Automatic Private IP Addressing (APIPA) protocol. With APIPA, DHCP clients automatically configure an IP address and subnet mask when a DHCP server is not available. The device chooses its own IP address in the range 169.254.1.0 through to 169.254.254.255. The subnet mask is automatically set to 255.255.0.0 and the gateway address is set to 0.0.0.0.

By default, the APIPA protocol is enabled. If you want to disable the APIPA protocol, you can disable it using control panel of the machine. For more information, see *APIPA* on page 23.

If the APIPA protocol is disabled, the default IP address of a Brother print server is 192.0.0.192. However, you can easily change this IP address number to match with the IP address details of your network.

## Using ARP to configure the IP address

---

If you are unable to use the BRAdmin application and your network does not use a DHCP server, you can also use the ARP command. The ARP command is available on Windows<sup>®</sup> systems that have TCP/IP installed as well as UNIX<sup>®</sup> systems. To use `arp` enter the following command at the command prompt:

```
arp -s ipaddress ethernetaddress
```

```
ping ipaddress
```

Where `ethernetaddress` is the Ethernet address (MAC address) of the print server and `ipaddress` is the IP address of the print server. For example:

### ■ Windows® systems

Windows® systems require the dash “-” character between each digit of the Ethernet address.

```
arp -s 192.168.1.2 00-80-77-31-01-07  
ping 192.168.1.2
```

### ■ UNIX®/Linux systems

Typically, UNIX® and Linux systems require the colon “:” character between each digit of the Ethernet address.

```
arp -s 192.168.1.2 00:80:77:31:01:07  
ping 192.168.1.2
```



#### Note

---

You must be on the same Ethernet segment (that is, there cannot be a router between the print server and operating system) to use the arp -s command.

If there is a router, you may use BOOTP or other methods described in this chapter to enter the IP address. If your Administrator has configured the system to deliver IP addresses using BOOTP, DHCP or RARP your Brother print server can receive an IP address from any one of these IP address allocation systems. In which case, you will not need to use the ARP command. The ARP command only works once. For security reasons, once you have successfully configured the IP address of a Brother print server using the ARP command, you cannot use the ARP command again to change the address. The print server will ignore any attempts to do this. If you wish to change the IP address again, use a web browser, Telnet (using the SET IP ADDRESS command) or factory reset the print server (which will then allow you to use the ARP command again).

---



## Using the Telnet console to configure the IP address

---

You can also use the Telnet command to change the IP address.

Telnet is an effective method to change the machine's IP address. But a valid IP address must already be programmed into print server.

Type `Telnet ipaddress` at the command prompt of the system prompt, where `ipaddress` is the IP address of the print server. When you are connected, push the Return or Enter key to get the “#” prompt. Enter a password if you have set it.

You will be prompted for a user name. Enter anything in response to this prompt.

You will then get the `Local>` prompt. Type `SET IP ADDRESS ipaddress`, where `ipaddress` is the desired IP address you wish to assign to the print server (check with your network administrator for the IP address to use). For example:

```
Local> SET IP ADDRESS 192.168.1.3
```

You will now need to set the subnet mask by typing `SET IP SUBNET subnet mask`, where `subnet mask` is the desired subnet mask you wish to assign to the print server (check with your network administrator for the subnet mask to use). For example:

```
Local> SET IP SUBNET 255.255.255.0
```

If you do not have any subnets, use one of the following default subnet masks:

255.0.0.0 for class A networks

255.255.0.0 for class B networks

255.255.255.0 for class C networks

The leftmost group of digits in your IP address can identify the type of network you have. The value of this group ranges from 1 through 127 for Class A networks (e.g., 13.27.7.1), 128 through 191 for Class B networks (e.g., 128.10.1.30), and 192 through 255 for Class C networks (e.g., 192.168.1.4).

If you have a gateway (router), enter its address with the command `SET IP ROUTER routeraddress`, where `routeraddress` is the desired IP address of the gateway you wish to assign to the print server. For example:

```
Local> SET IP ROUTER 192.168.1.4
```

Type `SET IP METHOD STATIC` to set the method of IP access configuration to static.

To verify that you have entered the IP information correctly, type `SHOW IP`.

Type `EXIT` or Ctrl-D (i.e., hold down the control key and type “D”) to end the remote console session.

## Installation when using a Network Print Queue or Share (printer driver only)



### Note

---

- You must configure the IP address on your machine before you proceed with this section. If you have not configured the IP address, see *Configuring your network printer* on page 8 first.
  - Verify the host computer and print server are either on the same subnet, or that the router is properly configured to pass data between the two devices.
  - Before installation, if you are using personal Firewall software (e.g. Windows Firewall), disable it. Once you are sure that you can print, re-start your personal Firewall software.
- 

- 1 Start the CD-ROM installation menu program according to the Quick Setup Guide.
- 2 Select the model name and your language (if necessary), and then click **Install Other Drivers or Utilities**.
- 3 Click **Printer Driver (Only)**.
- 4 Click **Next** in response to the Welcome message. Follow the on-screen instructions.
- 5 Select **Standard Installation** and click **Next**.
- 6 Select **Network Shared Printer**, and then click **Next**.
- 7 Select your printer's queue, and then click **OK**.



### Note

---

Contact your administrator if you are not sure about the location and name of the printer in the network.

---

- 8 Click **Finish**.

## Print server specifications

### Ethernet wired network

---

Model name	NC-6500h
Operating system support	Windows® 2000, Windows® XP, Windows® XP Professional x64 Edition, Windows Vista™, Windows Server® 2003 (print only via network) and Windows Server® 2003 x64 Edition (print only via network)
	Mac OS® X 10.2.4 or greater
Protocol support	TCP/IP: IPv4    ARP, RARP, BOOTP, DHCP, APIPA (Auto IP), WINS, NetBIOS name resolution, DNS resolver, mDNS, LPR/LPD, Custom Raw Port/Port9100, IPP, IPPS, FTP server, SSL/TLS, POP before SMTP, SMTP-AUTH, Telnet, SNMPv1, HTTP/HTTPS server, TFTP client and server, SMTP client, APOP, LLTD responder, Raw Port (PC scanner), FTP client
	TCP/IP: IPv6    (Turned off as default) NDP, RA, DNS, mDNS, LPR/LPD, Custom Raw Port/Port9100, IPP, IPPS, FTP server, SSL/TLS, POP before SMTP, SMTP-AUTH, Telnet, SNMPv1, HTTP/HTTPS server, TFTP client and server, SMTP client, APOP, LLTD responder, Raw Port (PC scanner)
Network type	10/100BASE-TX Ethernet network
Network printing	Windows® 2000/XP/XP Professional x64 Edition, Windows Vista™ and Windows Server® 2003 TCP/IP printing
	Macintosh® printing (Mac OS® X 10.2.4 or greater supporting TCP/IP)
Network PC Fax	Windows® 2000/XP/XP Professional x64 Edition and Windows Vista™
	Mac OS® X 10.2.4 or greater (Send only)
Network scanning	Windows® 2000/XP/XP Professional x64 Edition and Windows Vista™
	Mac OS® X 10.2.4 or greater

Windows® Computer requirements (for drivers, BRAdmin Light and Peer-to-Peer software)	Processor	Intel® Pentium® or equivalent for Windows® 2000/XP
	Minimum Speed	Intel® Pentium® 4 or equivalent 64-bit supported CPU for Windows Vista™
		Intel® Pentium® III or equivalent for Windows Server® 2003 AMD Opteron™, AMD Athlon™64, Intel® Xeon® with Intel® EM64T, Intel® Pentium® 4 with Intel® EM64T or equivalent for Windows® XP Professional x64 Edition and Windows Server® 2003 x64 Edition
	Minimum RAM	64 MB for Windows® 2000 128 MB for Windows® XP 256 MB for Windows® XP Professional x64 Edition, Windows Server® 2003 and Windows Server® 2003 x64 Edition 512 MB for Windows Vista™
	Recommended RAM	256 MB for Windows® 2000/XP 512 MB for Windows® XP Professional x64 Edition, Windows Server® 2003 and Windows Server® 2003 x64 Edition 1 GB for Windows Vista™

Macintosh® Computer requirements	Computer	Ethernet ready Power Macintosh®
	Processor	PowerPC G4/G5, Intel® Core™ Solo/Duo
	Minimum Speed	Processor PowerPC G3 350MHz
	Minimum RAM	128MB for Mac OS® X 10.2.4 or greater
	Recommended RAM	160MB for Mac OS® X 10.2.4 or greater
Management utilities	BRAdmin Light <sup>1</sup>	Windows® 2000, Windows® XP, Windows® XP Professional x64 Edition, Windows Vista™, Windows Server® 2003 and Windows Server® 2003 x64Edition  Mac OS® X 10.2.4 or greater
	BRAdmin Professional <sup>1</sup>	Windows® 2000, Windows® XP, Windows® XP Professional x64 Edition, Windows Vista™, Windows Server® 2003 and Windows Server® 2003 x64Edition
	Web BRAdmin <sup>1</sup>	Windows® 2000 Professional  Windows Server® 2003 Advanced Server  Windows® XP Professional (IIS)

<sup>1</sup> BRAdmin Professional and Web BRAdmin are available as a download from <http://solutions.brother.com>.

## Function table and default factory settings

Main Menu	Submenu	Menu Selections	Options	Page	
4.LAN (DCP-9040CN) 5.LAN (DCP-9045CDN) 7.LAN (MFC-9440CN)	1.TCP/IP	1.BOOT Method	<b>Auto*</b> Static RARP BOOTP DHCP  (If you choose Auto, RARP, BOOTP or DHCP, you will be asked to enter how many times the machine tries to obtain the IP address.)	16	
		2.IP Address	[000-255]. [000-255]. [000-255]. [000-255]  <b>[000]. [000]. [000]. [000]*<sup>1</sup></b>	19	
		3.Subnet Mask	[000-255]. [000-255]. [000-255]. [000-255]  <b>[000]. [000]. [000]. [000]*<sup>1</sup></b>	19	
		4.Gateway	[000-255]. [000-255]. [000-255]. [000-255]  <b>[000]. [000]. [000]. [000]*<sup>1</sup></b>	20	
		5.Node Name	BRNXXXXXX (up to 15 characters)	20	
		6.WINS Config	<b>Auto*</b> Static	21	
		7.WINS Server	Primary	[000-255]. [000-255]. [000-255]. [000-255]  <b>[000]. [000]. [000]. [000]*<sup>1</sup></b>	21
			Secondary	[000-255]. [000-255]. [000-255]. [000-255]  <b>[000]. [000]. [000]. [000]*<sup>1</sup></b>	
		8.DNS Server	Primary	[000-255]. [000-255]. [000-255]. [000-255]  <b>[000]. [000]. [000]. [000]*<sup>1</sup></b>	22
Secondary	[000-255]. [000-255]. [000-255]. [000-255]  <b>[000]. [000]. [000]. [000]*<sup>1</sup></b>				
9.APIPA		<b>On*</b> Off	23		

Main Menu	Submenu	Menu Selections	Options	Page
4.LAN (DCP-9040CN)	1.TCP/IP (continued)	0.IPv6	On <b>off*</b>	23
5.LAN (DCP-9045CDN) 7.LAN (MFC-9440CN) (continued)	2.Ethernet		<b>Auto*</b> 100B-FD 100B-HD 10B-FD 10B-HD	24
	3.Scan to FTP		<b>Color 150 dpi*</b> Color 300 dpi Color 600 dpi B&W 200 dpi B&W 200x100 dpi	24
	0.Factory Reset	1.Reset	1.Yes 2.No	26
		2.Exit	—	

The factory settings are shown in Bold with an asterisk.

<sup>1</sup> On connection to the network, the machine will automatically set the IP address and Subnet Mask to value appropriate for your network.

## Entering Text

When setting certain menu selections, such as the Station ID, you will need to type text characters. The dial pad keys have letters printed on them. The keys: **0**, **#** and **\*** do not have printed letters because they are used for special characters.

Press the appropriate dial pad key the required number of times to access the characters below:

Press Key	one time	two times	three times	four times
2	A	B	C	2
3	D	E	F	3
4	G	H	I	4
5	J	K	L	5
6	M	N	O	6
7	P	Q	R	S
8	T	U	V	8
9	W	X	Y	Z

### Inserting spaces

To enter a space in a fax number, press ► once between numbers. To enter a space in a name, press ► twice between characters.

### Making corrections

If you entered a letter incorrectly and want to change it, press ◀ to move the cursor under the incorrect character, and then press **Clear/Back**.

### Repeating letters

To enter a character on the same key as the previous character, press ► to move the cursor right before pressing the key again.



## Special characters and symbols

Press **\***, **#** or **0**, and then press **◀** or **▶** to move the cursor to the symbol or character you want.

Press **OK** to choose it. The symbols and characters below will appear depending on your menu selection.

Press <b>*</b>	for	(space) ! " # \$ % & ' ( ) * + , - . / €
Press <b>#</b>	for	: ; < = > ? @ [ ] ^ _ ¥ ~ `   { }
Press <b>0</b>	for	(For MFC-9440CN and DCP-9040CN) É À È Ê Î Ç Ë Ö 0 (For US and Canada) Ä Ë Ö Ü À Ç È É 0 (For UK) (For DCP-9045CDN) Á À Ã Ä Ç È É Ê Ë Ì Í Î Ï Ó Ô Õ Ö Ø Ù Ú Û Ü 0 (For US) À Á Ç È É Ê Ë Ì Í Î Ï Ò Ó Ù Ú Û Ü 0 (For Canada) Ä Ë Ö Ü À Ç È É 0 (For UK)

# C

# Index

## A

APIPA .....	6, 23, 79
APOP .....	45
ARP .....	79

## B

BINARY_P1 .....	77
BOOTP .....	6, 18, 78
BRAdmin Light .....	1, 2
BRAdmin Professional .....	1, 2, 10, 13, 48
BRNxxxxx_P1 .....	77
BRNxxxxx_P1_AT .....	77
Brother Solutions Center .....	10

## C

CA .....	44, 52
Certificate .....	44, 52
Control panel .....	13
CSR .....	44

## D

DHCP .....	6, 18, 77
Digital signature .....	44
DNS Client .....	6
DNS Server .....	22
Domain .....	34, 36, 46, 47, 50, 52
Driver Deployment Wizard .....	1, 27

## F

Factory default .....	26
Firewall .....	70, 72, 74

## G

Gateway .....	20
---------------	----

## H

HTTPS .....	45, 47
-------------	--------

## I

Internet printing .....	1, 34
IP address .....	8, 19
IPP .....	7, 34
IPPS .....	45, 49

IPv6 .....	7, 23
------------	-------

## L

LPR/LPD .....	6
---------------	---

## M

Macintosh printing .....	39
mDNS .....	7

## N

Network Configuration List .....	25
Network printing .....	32
Network shared printing .....	5
Node name .....	20

## O

Operating systems .....	1
-------------------------	---

## P

Password .....	34
PCL_P1 .....	77
Peer-to-Peer .....	4
Ping .....	72, 73
POP before SMTP .....	45, 50
Port9100 .....	6
POSTSCRIPT_P1 .....	77
Print server setting .....	13
private key .....	52
Protocol .....	6
Public key cryptosystem .....	44

## R

RARP .....	6, 17, 79
Remote Setup .....	1, 15
Restoring the network settings .....	26
RFC 1001 .....	77

## S

Security terms .....	44
Service .....	77
Shared key cryptosystem .....	44
Simple Network Configuration for Mac OS® X .....	71
SMTP client .....	6
SMTP-AUTH .....	45, 50

SNMP .....	7
Specifications .....	83
SSL/TLS .....	45, 52
Status Monitor .....	1
Subnet mask .....	9, 19

## T

---

TCP/IP .....	6, 16
TCP/IP printing .....	32
TELNET .....	81
Telnet .....	7
Text	
entering .....	88
special characters .....	89
TEXT_P1 .....	77
Trademarks .....	i

## W

---

Web Based Management (web browser) .....	46, 47
Web BRAdmin .....	3
Web browser (HTTP) .....	14
Web server (HTTP) .....	7
Web server (HTTPS) .....	45
Windows Server® 2003 printing .....	32
Windows Vista™ printing .....	32
Windows® 2000/XP printing .....	32
Windows® XP printing .....	32
WINS Config .....	21
WINS Server .....	21