

AV Receiver

# DTR-30.4

**Instruction Manual**

**Integra**



**WARNING:**

TO REDUCE THE RISK OF FIRE OR ELECTRIC SHOCK, DO NOT EXPOSE THIS APPARATUS TO RAIN OR MOISTURE.

**CAUTION:**

TO REDUCE THE RISK OF ELECTRIC SHOCK, DO NOT REMOVE COVER (OR BACK). NO USER-SERVICEABLE PARTS INSIDE. REFER SERVICING TO QUALIFIED SERVICE PERSONNEL.



The lightning flash with arrowhead symbol, within an equilateral triangle, is intended to alert the user to the presence of uninsulated “dangerous voltage” within the product’s enclosure that may be of sufficient magnitude to constitute a risk of electric shock to persons.



The exclamation point within an equilateral triangle is intended to alert the user to the presence of important operating and maintenance (servicing) instructions in the literature accompanying the appliance.



9. Do not defeat the safety purpose of the polarized or grounding-type plug. A polarized plug has two blades with one wider than the other. A grounding type plug has two blades and a third grounding prong. The wide blade or the third prong are provided for your safety. If the provided plug does not fit into your outlet, consult an electrician for replacement of the obsolete outlet.
10. Protect the power cord from being walked on or pinched particularly at plugs, convenience receptacles, and the point where they exit from the apparatus.
11. Only use attachments/accessories specified by the manufacturer.
12. Use only with the cart, stand, tripod, bracket, or table specified by the manufacturer, or sold with the apparatus. When a cart is used, use caution when moving the cart/apparatus combination to avoid injury from tip-over.
13. Unplug this apparatus during lightning storms or when unused for long periods of time.
14. Refer all servicing to qualified service personnel. Servicing is required when the apparatus has been damaged in any way, such as power-supply cord or plug is damaged, liquid has been spilled or objects have fallen into the apparatus, the apparatus has been exposed to rain or moisture, does not operate normally, or has been dropped.
15. Damage Requiring Service  
Unplug the apparatus from the wall outlet and refer servicing to qualified service personnel under the following conditions:
  - A. When the power-supply cord or plug is damaged,
  - B. If liquid has been spilled, or objects have fallen into the apparatus,
  - C. If the apparatus has been exposed to rain or water,

PORTABLE CART WARNING



- D. If the apparatus does not operate normally by following the operating instructions. Adjust only those controls that are covered by the operating instructions as an improper adjustment of other controls may result in damage and will often require extensive work by a qualified technician to restore the apparatus to its normal operation,
  - E. If the apparatus has been dropped or damaged in any way, and
  - F. When the apparatus exhibits a distinct change in performance this indicates a need for service.
16. Object and Liquid Entry  
Never push objects of any kind into the apparatus through openings as they may touch dangerous voltage points or short-out parts that could result in a fire or electric shock.  
The apparatus shall not be exposed to dripping or splashing and no objects filled with liquids, such as vases shall be placed on the apparatus.  
Don't put candles or other burning objects on top of this unit.
17. Batteries  
Always consider the environmental issues and follow local regulations when disposing of batteries.
18. If you install the apparatus in a built-in installation, such as a bookcase or rack, ensure that there is adequate ventilation.  
Leave 20 cm (8") of free space at the top and sides and 10 cm (4") at the rear. The rear edge of the shelf or board above the apparatus shall be set 10 cm (4") away from the rear panel or wall, creating a flue-like gap for warm air to escape.

**Important Safety Instructions**

1. Read these instructions.
2. Keep these instructions.
3. Heed all warnings.
4. Follow all instructions.
5. Do not use this apparatus near water.
6. Clean only with dry cloth.
7. Do not block any ventilation openings. Install in accordance with the manufacturer's instructions.
8. Do not install near any heat sources such as radiators, heat registers, stoves, or other apparatus (including amplifiers) that produce heat.

# Precautions

1. **Recording Copyright**—Unless it's for personal use only, recording copyrighted material is illegal without the permission of the copyright holder.
2. **AC Fuse**—The AC fuse inside the unit is not user-serviceable. If you cannot turn on the unit, contact your Onkyo dealer.
3. **Care**—Occasionally you should dust the unit all over with a soft cloth. For stubborn stains, use a soft cloth dampened with a weak solution of mild detergent and water. Dry the unit immediately afterwards with a clean cloth. Don't use abrasive cloths, thinners, alcohol, or other chemical solvents, because they may damage the finish or remove the panel lettering.

## 4. Power

### WARNING

BEFORE PLUGGING IN THE UNIT FOR THE FIRST TIME, READ THE FOLLOWING SECTION CAREFULLY.

AC outlet voltages vary from country to country. Make sure that the voltage in your area meets the voltage requirements printed on the unit's rear panel (e.g., AC 230 V, 50 Hz or AC 120 V, 60 Hz).

The power cord plug is used to disconnect this unit from the AC power source. Make sure that the plug is readily operable (easily accessible) at all times.

For models with [Power] button, or with both

[Power] and [On/Standby] buttons:

Pressing the [Power] button to select OFF mode does not fully disconnect from the mains. If you do not intend to use the unit for an extended period, remove the power cord from the AC outlet.

For models with [On/Standby] button only:

Pressing the [On/Standby] button to select Standby mode does not fully disconnect from the mains. If you do not intend to use the unit for an extended period, remove the power cord from the AC outlet.

## 5. Preventing Hearing Loss

### Caution

Excessive sound pressure from earphones and headphones can cause hearing loss.

## 6. Batteries and Heat Exposure

### Warning

Batteries (battery pack or batteries installed) shall not be exposed to excessive heat as sunshine, fire or the like.

7. **Never Touch this Unit with Wet Hands**—Never handle this unit or its power cord while your hands are wet or damp. If water or any other liquid gets inside this unit, have it checked by your Onkyo dealer.

## 8. Handling Notes

- If you need to transport this unit, use the original packaging to pack it how it was when you originally bought it.
- Do not leave rubber or plastic items on this unit for a long time, because they may leave marks on the case.
- This unit's top and rear panels may get warm after prolonged use. This is normal.
- If you do not use this unit for a long time, it may not work properly the next time you turn it on, so be sure to use it occasionally.

## For U.S. models

### FCC Information for User

#### CAUTION:

The user changes or modifications not expressly approved by the party responsible for compliance could void the user's authority to operate the equipment.

#### NOTE:

This equipment has been tested and found to comply with the limits for a Class B digital device, pursuant to Part 15 of the FCC Rules. These limits are designed to provide reasonable protection against harmful interference in a residential installation.

This equipment generates, uses and can radiate radio frequency energy and, if not installed and used in accordance with the instructions, may cause harmful interference to radio communications. However, there is no guarantee that interference will not occur in a particular installation. If this equipment does cause harmful interference to radio or television reception, which can be determined by turning the equipment off and on, the user is encouraged to try to correct the interference by one or more of the following measures:

- Reorient or relocate the receiving antenna.
- Increase the separation between the equipment and receiver.
- Connect the equipment into an outlet on a circuit different from that to which the receiver is connected.
- Consult the dealer or an experienced radio/TV technician for help.

## For Canadian Models

**NOTE:** THIS CLASS B DIGITAL APPARATUS COMPLIES WITH CANADIAN ICES-003.

For models having a power cord with a polarized plug:

**CAUTION:** TO PREVENT ELECTRIC SHOCK, MATCH WIDE BLADE OF PLUG TO WIDE SLOT, FULLY INSERT.

## Modèle pour les Canadien

**REMARQUE:** CET APPAREIL NUMÉRIQUE DE LA CLASSE B EST CONFORME À LA NORME NMB-003 DU CANADA.

Sur les modèles dont la fiche est polarisée:

**ATTENTION:** POUR ÉVITER LES CHOCS ÉLECTRIQUES, INTRODUIRE LA LAME LA PLUS LARGE DE LA FICHE DANS LA BORNE CORRESPONDANTE DE LA PRISE ET POUSSER JUSQU'AU FOND.

# Supplied Accessories

Make sure you have the following accessories:

**Indoor FM antenna** (→ page 18)

**AM loop antenna** (→ page 18)

**Power cord** (→ page 18)

**Speaker cable labels** (→ page 12)

**Speaker setup microphone** (→ page 33)

**Remote controller (RC-838M) and two batteries (AA/R6)**

\* In catalogs and on packaging, the letter at the end of the product name indicates the color. Specifications and operations are the same regardless of color.

## ■ Installing the batteries

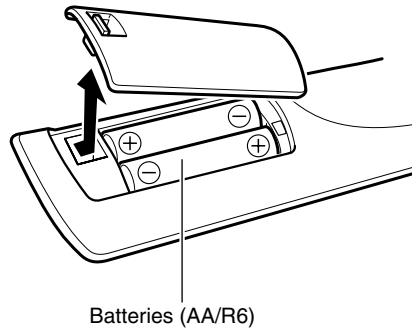

### Note

- If the remote controller doesn't work reliably, try replacing the batteries.
- Don't mix new and old batteries or different types of batteries.
- If you intend not to use the remote controller for a long time, remove the batteries to prevent damage from leakage or corrosion.
- Remove expired batteries as soon as possible to prevent damage from leakage or corrosion.

## ■ Aiming the remote controller

To use the remote controller, point it at the AV receiver's remote control sensor, as shown below.

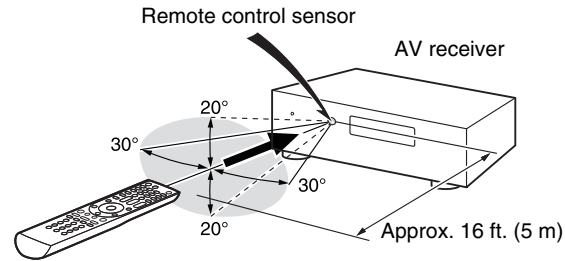

Thank you for purchasing an Integra AV receiver. Please read this manual thoroughly before making connections and plugging in the unit. Following the instructions in this manual will enable you to obtain optimum performance and listening enjoyment from your new AV receiver. Please retain this manual for future reference.

# Table of Contents

## Safety Information and Introduction

|  |    |
|--|----|
| <b>Important Safety Instructions</b> ..... | 2  |
| <b>Precautions</b> .....                   | 3  |
| <b>Supplied Accessories</b> .....          | 4  |
| <b>Table of Contents</b> .....             | 5  |
| <b>Features</b> .....                      | 6  |
| <b>Front &amp; Rear Panels</b> .....       | 7  |
| Front Panel.....                           | 7  |
| Display .....                              | 8  |
| Rear Panel .....                           | 9  |
| <b>Remote Controller</b> .....             | 10 |
| Controlling the AV Receiver .....          | 10 |

## Connections

|  |    |
|--|----|
| <b>Connecting the AV Receiver</b> .....      | 11 |
| Connecting Your Speakers .....               | 11 |
| About AV Connections .....                   | 14 |
| Connecting Components with HDMI .....        | 15 |
| Connecting Your Components .....             | 16 |
| Connecting Integra/Onkyo RI Components ..... | 17 |
| Connecting the Antennas .....                | 18 |
| Connecting the Power Cord .....              | 18 |

## Turning On & Basic Operations

|   |    |
|---|----|
| <b>Turning On/Off the AV Receiver</b> ..... | 19 |
| Turning On .....                            | 19 |
| Turning Off .....                           | 19 |
| <b>Initial Setup</b> .....                  | 20 |
| Selecting the Language                      |    |
| for the Onscreen Setup Menus.....           | 20 |
| Audyssey 2EQ: Auto Setup.....               | 20 |
| Source Connection.....                      | 21 |
| Remote Mode Setup .....                     | 21 |
| Network Connection .....                    | 21 |
| Terminating the Initial Setup .....         | 21 |

|   |    |
|---|----|
| <b>Playback</b> .....                               | 22 |
| Playing the Connected Component .....               | 22 |
| Controlling Contents of USB or Network Devices..... | 23 |
| Understanding Icons on the Display .....            | 24 |
| Playing an iPod/iPhone via USB.....                 | 24 |
| Playing a USB Device.....                           | 25 |
| Listening to vTuner Internet Radio .....            | 25 |
| Registering Other Internet Radio .....              | 26 |
| Changing the Icon Layout                            |    |
| on the Network Service Screen .....                 | 27 |
| Playing Music Files on a Server .....               | 27 |
| Remote Playback.....                                | 28 |
| Listening to AM/FM Radio .....                      | 29 |
| Playing Audio and Video from Separate Sources.....  | 31 |
| <b>Using Basic Functions</b> .....                  | 32 |
| Using the Automatic Speaker Setup .....             | 32 |
| Using the Listening Modes .....                     | 35 |
| Using the Home Menu .....                           | 42 |
| Using the Sleep Timer .....                         | 43 |
| Setting the Display Brightness .....                | 43 |
| Displaying Source Information .....                 | 43 |
| Changing the Input Display .....                    | 43 |
| Using the Whole House Mode .....                    | 44 |
| Muting the AV Receiver .....                        | 44 |
| Using Headphones .....                              | 44 |

## Advanced Operations

|   |    |
|---|----|
| <b>On-screen Setup</b> .....                  | 45 |
| Using the Quick Setup .....                   | 45 |
| Using the Audio Settings of Quick Setup ..... | 46 |
| Using the Setup Menu (Home) .....             | 48 |
| About the Hybrid Standby indicator .....      | 49 |
| Setup menu items .....                        | 49 |
| Input/Output Assign .....                     | 50 |
| Speaker Setup .....                           | 52 |
| Audio Adjust.....                             | 55 |
| Source Setup .....                            | 57 |
| Listening Mode Preset .....                   | 61 |
| Miscellaneous .....                           | 62 |
| Hardware Setup .....                          | 64 |
| Remote Controller Setup .....                 | 67 |
| Lock Setup.....                               | 67 |

|   |    |
|---|----|
| <b>Multi Zone</b> .....                 | 68 |
| Making Multi Zone Connections .....     | 68 |
| Setting the Zone 2/3 Out .....          | 69 |
| Controlling Multi Zone Components ..... | 69 |
| Using the 12V Triggers.....             | 70 |
| Using the Remote Controller in Zone 2/3 |    |
| and Multiroom Control Kits.....         | 71 |

## Controlling Other Components

|  |    |
|--|----|
| <b>iPod/iPhone Playback via Onkyo Dock</b> ..... | 72 |
| Using the Onkyo Dock.....                        | 72 |
| Controlling Your iPod/iPhone .....               | 73 |
| <b>Controlling Other Components</b> .....        | 74 |
| Preprogrammed Remote Control Codes .....         | 74 |
| Looking up for Remote Control Codes .....        | 74 |
| Entering Remote Control Codes.....               | 75 |
| Remapping Colored Buttons .....                  | 75 |
| Remote Control Codes for Integra/Onkyo           |    |
| Components Connected via RI .....                | 76 |
| Resetting the Remote Mode Buttons.....           | 76 |
| Resetting the Remote Controller .....            | 76 |
| Controlling Other Components.....                | 76 |

## Appendix

|  |    |
|--|----|
| <b>Troubleshooting</b> .....                       | 79 |
| <b>Firmware Update</b> .....                       | 85 |
| <b>Connection Tips and Video Signal Path</b> ..... | 89 |
| <b>Using an RIHD-compatible TV, Player,</b>        |    |
| <b>or Recorder</b> .....                           | 92 |
| <b>About HDMI</b> .....                            | 94 |
| <b>Network/USB Features</b> .....                  | 95 |
| <b>License and Trademark Information</b> .....     | 98 |
| <b>Specifications</b> .....                        | 99 |

To reset the AV receiver to its factory defaults, turn it on and, while holding down CBL/SAT, press  On/Standby (→ page 79).

# Features

## Amplifier

---

- 100 Watts/Channel @ 8 ohms (FTC)
- 160 Watts/Channel @ 6 ohms (IEC)
- 175 Watts/Channel @ 6 ohms (JEITA)
- Optimum Gain Volume Circuitry
- H.C.P.S. (High Current Power Supply) Massive High Power Transformer
- 3 Stage Inverted Darlington Amplifier Design

## Processing

---

- THX Select2 Plus Certified
- Incorporates Qdeo™ technology for HDMI Video Upscaling (to 4K Compatible)
- HDMI (Audio Return Channel, 3D, DeepColor, x.v.Color, LipSync, DTS-HD Master Audio, DTS-HD High Resolution Audio, Dolby TrueHD, Dolby Digital Plus, DSD and Multi-CH PCM)
- Dolby Pro Logic IIz and Audyssey DSX®
- Non-Scaling Configuration
- A-Form Listening Mode Memory
- Direct Mode
- Music Optimizer for Compressed Digital Music files
- 192 kHz/24-bit D/A Converters
- Powerful and Highly Accurate 32-bit Processing DSP
- Jitter Cleaning Circuit Technology

## Connections

---

- 8 HDMI Inputs (1 on front panel) and 2 Outputs
- Integra/Onkyo **RIHD** for System Control
- 4 Digital Inputs (2 Optical/2 Coaxial)
- Component Video Switching (2 Inputs/1 Output)
- Banana Plug-Compatible Speaker Posts
- Powered Zone 2
- Zone 2/3 Pre/Line Out
- IR Input/Output and 12 V Triggers
- RS232 Port for Interface Control
- Bi-Amping Capability for FL/FR with SBL/SBR
- Internet Radio Connectivity
- Network Capability for Streaming Audio Files
- 2 USB Inputs (Front/Rear) for Memory Devices and iPod®/iPhone® models (Enables Display of Album Artwork)
  - \* Only the front-panel USB input is compatible with iPod/iPhone.
- MHL-Enabled AUX Front Input

## Miscellaneous

---

- 40 FM/AM Presets
- Audyssey 2EQ® to correct room acoustic problems
- Audyssey Dynamic EQ® for loudness correction
- Audyssey Dynamic Volume® to maintain optimal listening level and dynamic range
- Crossover Adjustment (40/45/50/55/60/70/80/90/100/110/120/130/150/200 Hz)
- A/V Sync Control Function (up to 800 ms)
- Auto Standby Function
- On-Screen Display via HDMI
- Preprogrammed **RI**-Compatible Remote

# Front & Rear Panels

## Front Panel

(North American models)

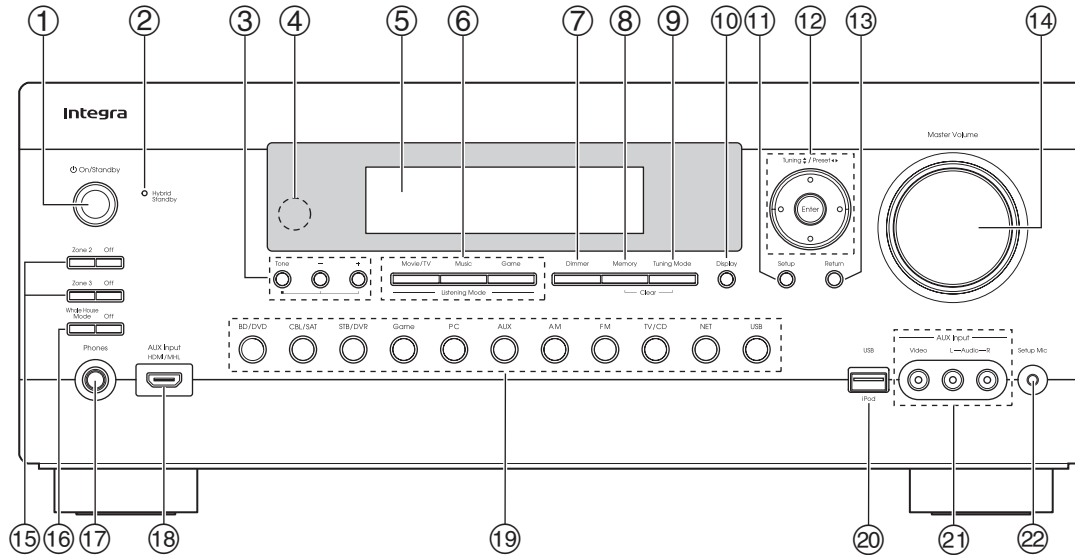

For detailed information, see the pages in parentheses.

- ① On/Standby button (19)
- ② Hybrid Standby indicator (49)
- ③ Tone and Tone Level buttons (46, 70)
- ④ Remote control sensor (4)
- ⑤ Display (8)
- ⑥ Listening Mode buttons (35)
- ⑦ Dimmer button (North American models) (43)
- ⑧ Memory button (30)
- ⑨ Tuning Mode button (29)
- ⑩ Display button (43)

- ⑪ Setup button (48)
- ⑫ Tuning ▲/▼ (29), Preset ◀/▶ (30), cursor and Enter buttons
- ⑬ Return button
- ⑭ Master Volume control (22)
- ⑮ Zone 2/Zone 3 and Off buttons (69)
- ⑯ Whole House Mode and Off buttons (44)
- ⑰ Phones jack (44)
- ⑱ AUX Input HDMI/MHL jack (15)
- ⑲ Input selector buttons (22)
- ⑳ USB port (16)

(Australian models)

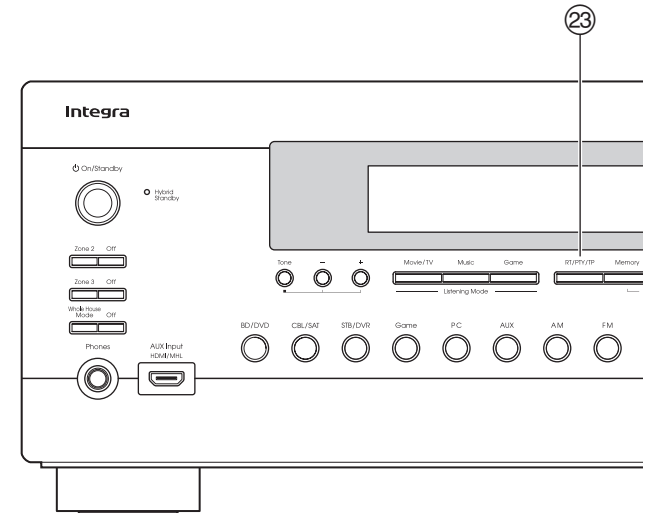

- ⑳ AUX Input Video/Audio jacks (16)
- ㉑ Setup Mic jack (33)
- ㉒ RT/PTY/TP button (Australian models) (30)

## Display

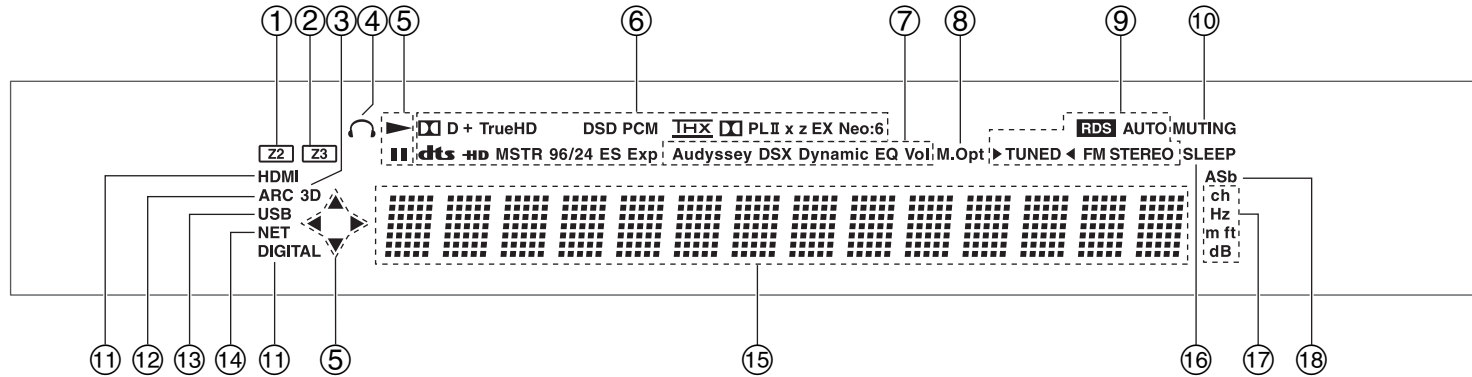

For detailed information, see the pages in parentheses.

- ① **Z2 (Zone 2) indicator (69)**
- ② **Z3 (Zone 3) indicator (69)**
- ③ **3D indicator**  
This lights when a 3D input signal is detected.
- ④ **Headphone indicator (44)**
- ⑤ **▶, || and cursor indicators (24)**
- ⑥ **Listening mode and format indicators (35)**
- ⑦ **Audyssey indicator (32, 57)**  
Audyssey DSX indicator (39)  
Dynamic EQ indicator (57)  
Dynamic Vol indicator (58)
- ⑧ **M.Opt indicator (47)**
- ⑨ **Tuning indicators**  
RDS indicator (excluding North American models) (30)  
AUTO indicator (29)  
TUNED indicator (29)  
FM STEREO indicator (29)
- ⑩ **MUTING indicator (44)**
- ⑪ **Input indicators (90)**  
HDMI indicator (64)  
DIGITAL indicator
- ⑫ **ARC indicator (65)**
- ⑬ **USB indicator (24, 25)**
- ⑭ **NET indicator (25 to 28, 66)**
- ⑮ **Message area**
- ⑯ **SLEEP indicator (43)**
- ⑰ **Channel/Unit indicators**  
ch indicator  
Hz indicator  
m/ft indicator  
dB indicator
- ⑱ **ASb indicator (66)**



Rear Panel

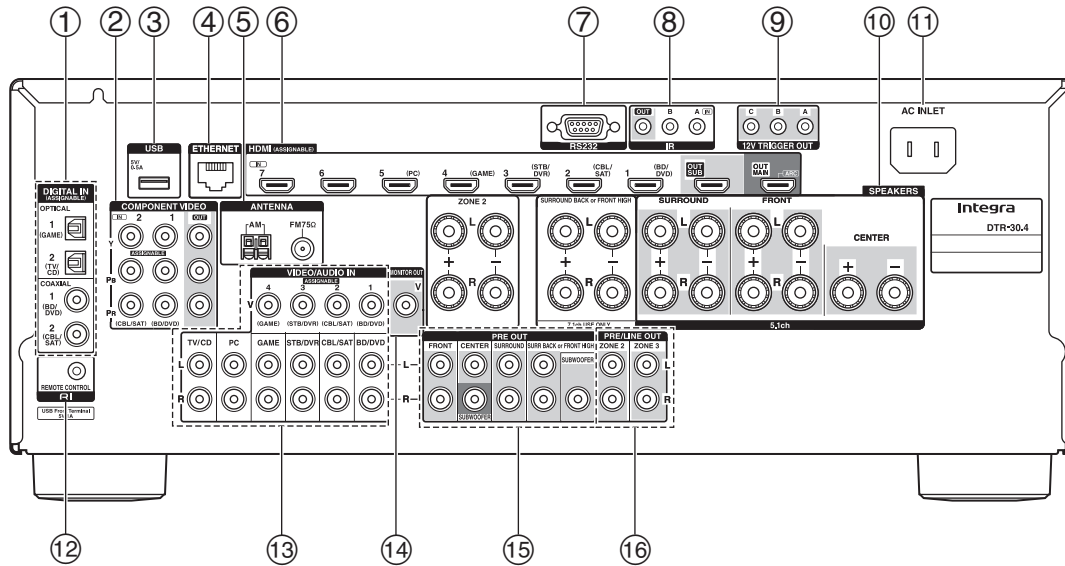

- ① **DIGITAL IN COAXIAL and OPTICAL** jacks
- ② **COMPONENT VIDEO IN and OUT** jacks
- ③ **USB** port
- ④ **ETHERNET** port
- ⑤ **FM ANTENNA** jack and **AM ANTENNA** terminal
- ⑥ **HDMI IN** and **HDMI output (HDMI OUT MAIN and HDMI OUT SUB)** jacks
- ⑦ **RS232** port  
Terminal for control.
- ⑧ **IR IN A/B** and **OUT** jacks
- ⑨ **12V TRIGGER OUT A/B/C** jacks
- ⑩ **SPEAKERS** terminals  
(**CENTER, FRONT, SURROUND, SURROUND BACK or FRONT HIGH, ZONE 2**)
- ⑪ **AC INLET**
- ⑫ **RI REMOTE CONTROL** jack
- ⑬ Composite video and analog audio jacks  
(**BD/DVD IN, CBL/SAT IN, STB/DVR IN, GAME IN, PC IN, TV/CD IN**)
- ⑭ **MONITOR OUT V** jack
- ⑮ **PRE OUT** jacks  
(**CENTER, FRONT, SURROUND, SURR BACK or FRONT HIGH, ZONE 2 or FRONT HIGH, SUBWOOFER**)
- ⑯ **ZONE 2 and ZONE 3 PRE/LINE OUT** jacks

See “Connecting the AV Receiver” for connection (→ pages 11 to 18).

# Remote Controller

## Controlling the AV Receiver

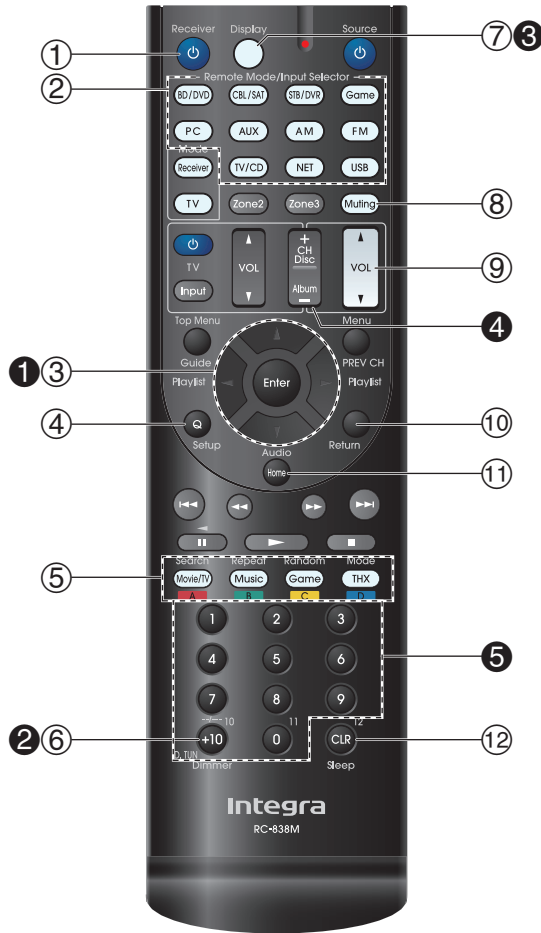

To control the AV receiver, press **Receiver** to select Receiver mode.

You can also use the remote controller to control Integra/Onkyo Blu-ray Disc/DVD player, CD player, and other components.

See “Entering Remote Control Codes” for more details (→ page 75).

For detailed information, see the pages in parentheses.

- ① **Receiver button (19)**
- ② **Remote Mode/Input Selector buttons (22)**
- ③ **▲/▼/◀/▶ and Enter buttons**
- ④ **Q Setup button (45)**
- ⑤ **Listening Mode buttons (35)**
- ⑥ **Dimmer button (43)**
- ⑦ **Display button (43)**
- ⑧ **Muting button (44)**
- ⑨ **VOL ▲/▼ button (22)**
- ⑩ **Return button**
- ⑪ **Home button (42)**
- ⑫ **Sleep button (43)**

### ■ Controlling the tuner

To control the AV receiver’s tuner, press **AM** or **FM** (or **Receiver**).

- ① **▲/▼ buttons (29)**
- ② **D.TUN button (29)**
- ③ **Display button**
- ④ **CH +/- button (30)**
- ⑤ **Number buttons (29)**

# Connecting the AV Receiver

## Connecting Your Speakers

### Speaker Configuration

The following table indicates the channels you should use depending on the number of speakers that you have.

No matter how many speakers you use, a powered subwoofer is recommended for a really powerful and solid bass.

To get the best from your surround sound system, you need to set the speaker settings automatically (→ [page 32](#)) or manually (→ [page 52](#)).

| Number of speakers        | 2 | 3 | 4 | 5 | 6 | 7 | 7 |
|---------------------------|---|---|---|---|---|---|---|
| Front speakers            | ✓ | ✓ | ✓ | ✓ | ✓ | ✓ | ✓ |
| Center speaker            |   |   | ✓ | ✓ | ✓ | ✓ | ✓ |
| Surround speakers         |   |   | ✓ | ✓ | ✓ | ✓ | ✓ |
| Surround back speaker*1*2 |   |   |   |   | ✓ |   |   |
| Surround back speakers*2  |   |   |   |   |   | ✓ |   |
| Front high speakers*2     |   |   |   |   |   |   | ✓ |

\*1 If you're using only one surround back speaker, connect it to the **SURROUND BACK or FRONT HIGH L** terminals.

\*2 Front high and surround back speakers cannot be used at the same time.

### Connecting the Speaker Cables

The following illustration shows how to connect the speakers to each pair of terminals. If you're using only one surround back speaker, connect it to the **SURROUND BACK or FRONT HIGH L** terminals.

#### Tip

- You can specify whether surround back or front high speakers are connected in the "Speaker Configuration" menu (→ [page 52](#)) or during Audyssey 2EQ® Room Correction and Speaker Setup (→ [page 32](#)).

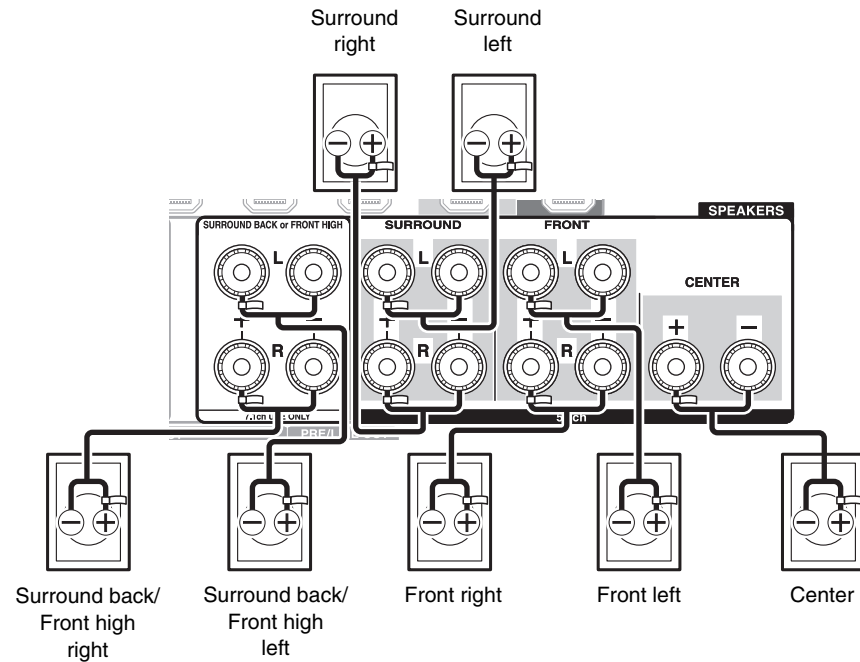

#### ■ Screw-type speaker terminals

Strip 1/2" to 5/8" (12 to 15 mm) of insulation from the ends of the speaker cables, and twist the bare wires tightly, as shown.

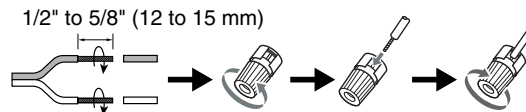

#### ■ Banana Plugs (North American models)

- If you are using banana plugs, tighten the speaker terminal before inserting the banana plug.
- Do not insert the speaker code directly into the center hole of the speaker terminal.

## Attaching the Speaker Cable Labels

The speaker terminals are color-coded for identification purpose.

| Speaker                                     | Color |
|---|-------|
| Front left, Front high left, Zone 2 left    | White |
| Front right, Front high right, Zone 2 right | Red   |
| Center                                      | Green |
| Surround left                               | Blue  |
| Surround right                              | Gray  |
| Surround back left                          | Brown |
| Surround back right                         | Tan   |

The supplied speaker cable labels are also color-coded and you should attach them to the positive (+) side of each speaker cable in accordance with the table above. Then all you need to do is to match the color of each label to the corresponding speaker terminal.



## Speaker Connection Precautions

Read the following before connecting your speakers:

- **(North American models)** You can connect speakers with an impedance of between 6 and 16 ohms. If you use speakers with a lower impedance, and use the amplifier at high volume levels for a long period of time, the built-in amp protection circuit may be activated.
- **(Australian models)** You can connect speakers with an impedance of between 4 and 16 ohms. If the impedance of any of the connected speakers is 4 ohms or more, but less than 6 ohms, be sure to set the minimum speaker impedance to “4ohms” (→ page 52). If you use speakers with a lower impedance, and use the amplifier at high volume levels for a long period of time, the built-in protection circuit may be activated.
- Disconnect the power cord from the wall outlet before making any connections.

- Read the instructions supplied with your speakers.
- Pay close attention to speaker wiring polarity. In other words, connect positive (+) terminals only to positive (+) terminals, and negative (–) terminals only to negative (–) terminals. If you get them the wrong way around, the sound will be out of phase and will sound unnatural.
- Unnecessarily long, or very thin speaker cables may affect the sound quality and should be avoided.
- Be careful not to short the positive and negative wires. Doing so may damage the AV receiver.
- Make sure the metal core of the wire does not have contact with the AV receiver’s rear panel. Doing so may damage the AV receiver.

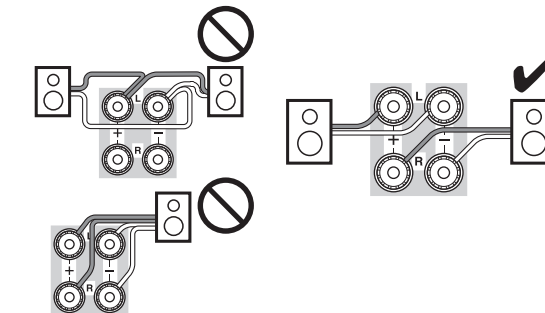
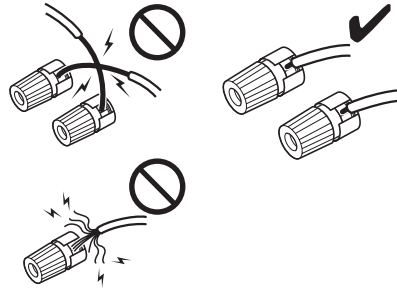

## Using Dipole Speakers

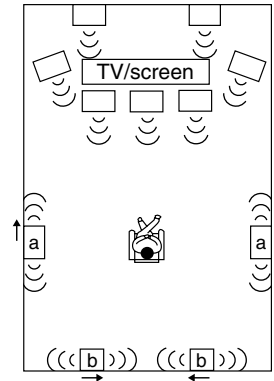

You can use dipole speakers for the surround and surround back speakers. Dipole speakers output the same sound in two directions.

Dipole speakers typically have an arrow printed on them to indicate how they should be positioned. The surround dipole speakers (a) should be positioned so that their arrows point toward the TV/screen, while the surround back dipole speakers (b) should be positioned so that their arrows point toward each other, as shown.

- Don't connect more than one cable to each speaker terminal. Doing so may damage the AV receiver.
- Don't connect one speaker to several terminals.

## Using Powered Subwoofers

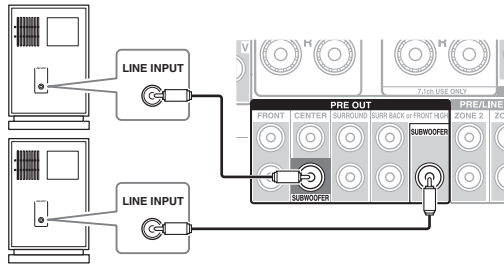

Powered subwoofer

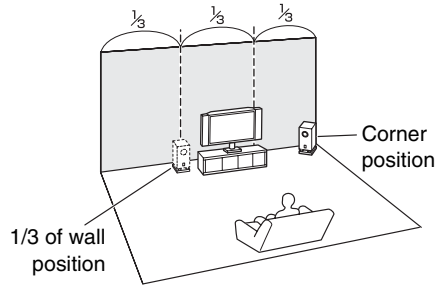

To find the best position for your subwoofer, while playing a movie or some music with good bass, experiment by placing your subwoofer at various positions within the room, and choose the one that provides the most satisfying results.

You can connect the powered subwoofer with two **SUBWOOFER PRE OUT** jacks respectively.

The same signal is output from each jack.

### Tip

- If your subwoofer is unpowered and you're using an external amplifier, connect the subwoofer pre out jack to an input on the amplifier.

## Bi-amping the Front Speakers

### Important:

- When making the bi-amping connections, be sure to remove the jumper bars that link the speakers' tweeter (high) and woofer (low) terminals.
- Bi-amping can be used only with speakers that support bi-amping. Refer to your speaker manual.

Bi-amping provides improved bass and treble performance. When bi-amping is used, the AV receiver is able to drive up to a 5.1 speaker system in the main room. Once you've completed the bi-amping connections as shown and turned on the AV receiver, you must set the speaker setting to enable bi-amping (→ [page 52](#)).

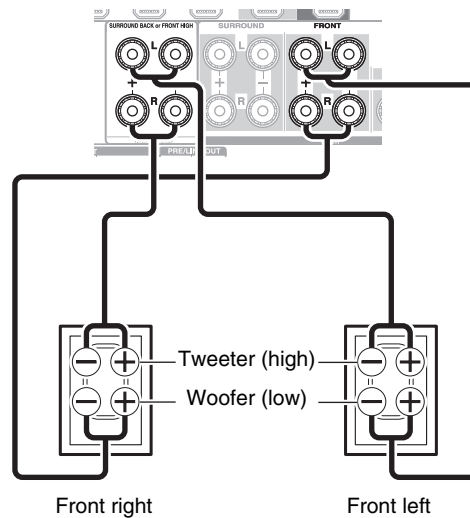

## Connecting a Power Amplifier

If you want to use a more powerful power amplifier, you can use the AV receiver as a preamp. Connect all speaker outputs to the power amplifier. See the manuals supplied with your amplifier for details.

### Note

- Specify "None" for the channel that you don't want to output (→ [page 52](#)).

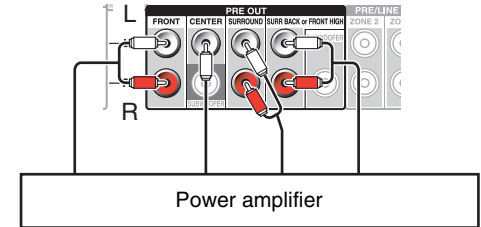

## About AV Connections

### Connecting AV components

#### HDMI cable

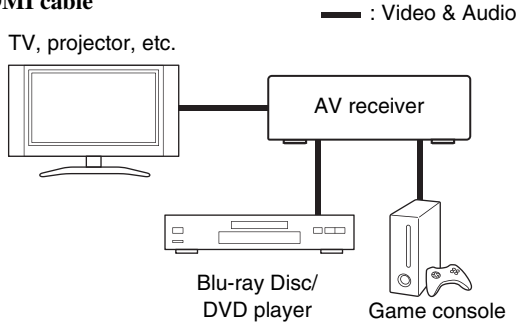

#### Other cables

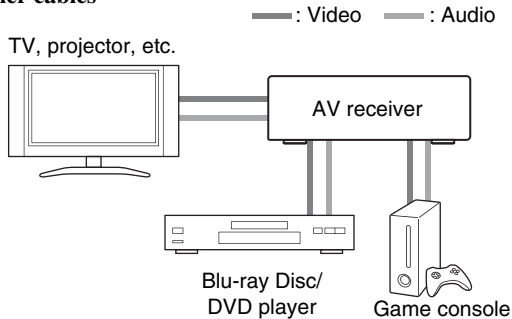

- Before making any AV connections, read the manuals supplied with your AV components.
- Don't connect the power cord until you've completed and double-checked all AV connections.
- Push plugs in all the way to make good connections (loose connections can cause noise or malfunctions).
- To prevent interference, keep audio and video cables away from power cords and speaker cables.

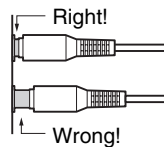

### AV Cables and Jacks

#### HDMI

HDMI connections can carry digital video and audio.



#### Component video

Component video separates the luminance (Y) and color difference signals (Pb, Pr), providing the best picture quality (some TV manufacturers label their component video sockets slightly differently).

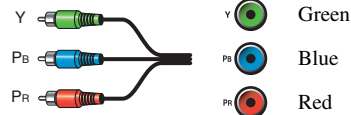

#### Composite video

Composite video is commonly used on TVs, DVDs, and other video equipment.



#### Optical digital audio

Optical digital connections allow you to enjoy digital sound such as PCM\*1, Dolby Digital or DTS. The audio quality is the same as coaxial.



#### Coaxial digital audio

Coaxial digital connections allow you to enjoy digital sound such as PCM\*1, Dolby Digital or DTS. The audio quality is the same as optical.



#### Analog audio (RCA)

Analog audio connections (RCA) carry analog audio.



\*1 For PCM signals, the supported sampling rates are 32/44.1/48/88.2/96 kHz. With HDMI connections, 176.4 and 192 kHz are also supported.

#### Note

- The AV receiver does not support SCART plugs.
- The AV receiver's optical digital jacks have shutter-type covers that open when an optical plug is inserted and close when it's removed. Push plugs in all the way.

#### Caution

- To prevent shutter damage, hold the optical plug straight when inserting and removing.

## Connecting Components with HDMI

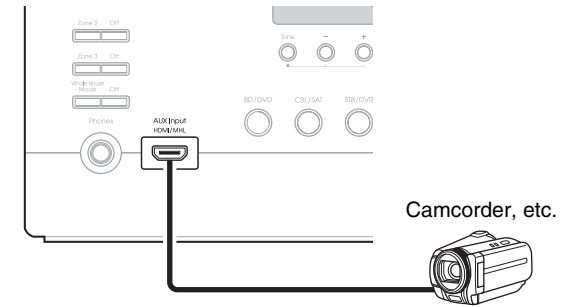
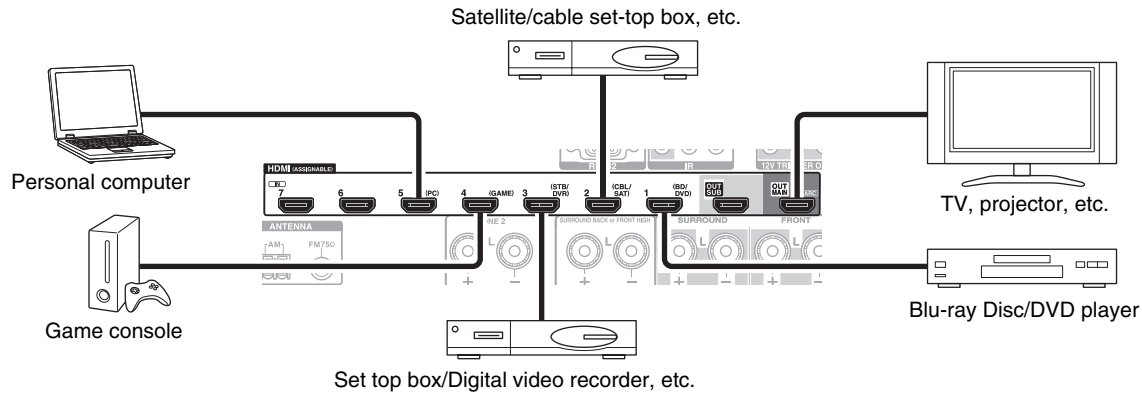

- \* If your TV doesn't support Audio Return Channel (ARC), you need to connect an optical digital cable together with the HDMI cable to the AV receiver.
- \* When listening to an HDMI component through the AV receiver, set the HDMI component so that its video can be seen on the TV screen (on the TV, select the input of the HDMI component connected to the AV receiver). If the TV power is off or the TV is set to another input source, this may result in no sound from the AV receiver or the sound may be cut off.

Connect your components to the appropriate jacks. The default input assignments are shown below.

✓: Assignment can be changed (→ page 50).

| Jack     | Components                               |   |
|----------|--|---|
| IN1      | Blu-ray Disc/DVD player                  | ✓ |
| IN2      | Satellite/cable set-top box, etc.        | ✓ |
| IN3      | Set top box/Digital video recorder, etc. | ✓ |
| IN4      | Game console                             | ✓ |
| IN5      | Personal computer                        | ✓ |
| IN6      | Other components                         | ✓ |
| IN7      | Other components                         | ✓ |
| Front    | Camcorder, etc.                          |   |
| OUT MAIN | TV                                       |   |
| OUT SUB  | Projector, etc.                          |   |

See also:

- “Connection Tips and Video Signal Path” (→ page 89)
- “Using an RIHD-compatible TV, Player, or Recorder” (→ page 92)
- “About HDMI” (→ page 94)

### Tip

- To listen to the audio of a component connected via HDMI through your TV's speakers, enable “HDMI Through” (→ page 64) and set the AV receiver to standby mode.

### Note

- In the case of Blu-ray Disc/DVD players, if no sound is output despite following the above-mentioned procedure, set your Blu-ray Disc/DVD player's HDMI audio settings to PCM.

### ■ Audio Return Channel (ARC) function

The Audio Return Channel (ARC) function enables an HDMI capable TV to send the audio stream to **HDMI OUT MAIN** on the AV receiver.

- This function can be used when:
  - Your TV is ARC capable, and
  - The **TV/CD** input selector is selected, and
  - “HDMI Control(RIHD)” is set to “On”(→ page 64), and
  - “Audio Return Channel” is set to “Auto” (→ page 65).

### ■ MHL (Mobile High-Definition Link)

With its support for MHL (Mobile High-Definition Link), the AUX (Front) input allows you to deliver high-definition video from a connected mobile device.

## Connecting Your Components

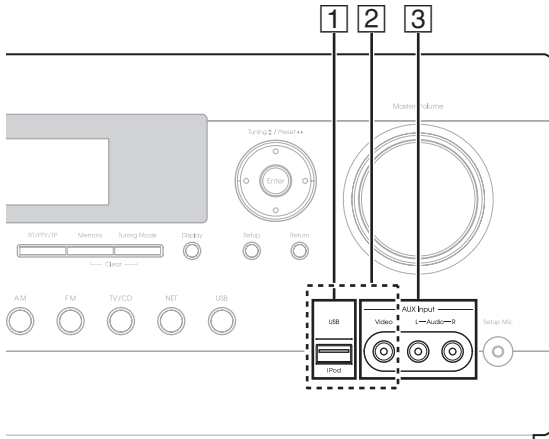

The on-screen menus appear only on a TV that is connected to **HDMI OUT MAIN**. If your TV is connected to other video outputs, use the AV receiver's display when changing settings.

✓: Assignment can be changed (→ page 51, 52).

| No. | Jack/Port              | Components                                   |
|-----|------------------------|--|
| 1   | USB*1*2                | iPod/iPhone, MP3 player, USB flash drive     |
| 2   | USB, AUX Input Video*3 | iPod/iPhone (video playback)                 |
| 3   | AUX Input              |  |
|     | Video                  | Camcorder, etc                               |
|     | Audio L/R              |  |
| 4   | DIGITAL IN             |  |
|     | OPTICAL 1 (GAME)       | Game consoles ✓                              |
|     | OPTICAL 2 (TV/CD)      | TV, CD player ✓                              |
|     | COAXIAL 1 (BD/DVD)     | Blu-ray Disc/DVD player ✓                    |
|     | COAXIAL 2 (CBL/SAT)    | Satellite/cable set-top box, RI dock, etc. ✓ |
| 5   | COMPONENT VIDEO        |  |
|     | IN 1 (BD/DVD)          | Blu-ray Disc/DVD player, RI dock ✓           |
|     | IN 2 (CBL/SAT)         | Satellite/cable set-top box, RI dock, etc. ✓ |
|     | OUT                    | TV, projector, etc.                          |
| 6   | ETHERNET               | Router                                       |
| 7   | VIDEO IN               |  |
|     | IN 1 (BD/DVD)          | Blu-ray Disc/DVD player ✓                    |
|     | IN 2 (CBL/SAT)         | Satellite/cable set-top box, etc. ✓          |
|     | IN 3 (STB/DVR)         | Set top box/Digital video recorder, etc ✓    |
|     | IN 4 (GAME)            | Game console, RI dock ✓                      |

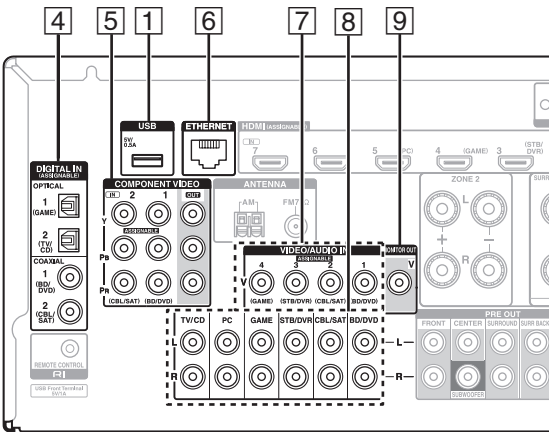

Connect your components to the appropriate jacks. The default input assignments are shown below. See “Connection Tips and Video Signal Path” for more information (→ page 89).

| No. | Jack/Port   | Components  |
|-----|-------------|---|
| 8   | AUDIO IN    |   |
|     | BD/DVD IN   | Blu-ray Disc/DVD player   |
|     | CBL/SAT IN  | Satellite/cable set-top box, etc.                                 |
|     | STB/DVR IN  | Set top box/Digital video recorder, etc                           |
|     | GAME IN     | Game console, RI dock   |
|     | PC IN       | Personal computer   |
|     | TV/CD IN    | TV, CD player, cassette tape deck, MD, CD-R, Turntable*4, RI dock |
| 9   | MONITOR OUT | TV, projector, etc.   |

### Note

- \*1 Do not connect the AV receiver's **USB** port to a USB port on your computer. Music on your computer cannot be played through the AV receiver in this way.
  - \*2 Only the front-panel USB input is compatible with iPod/iPhone.
  - \*3 When the **USB** input is selected, you can input video signals from the **AUX Input Video** jack. Video signals input from **AUX Input Video** will be output from the **MONITOR OUT** and **HDMI** output jacks.
  - \*4 Connect a turntable (MM) that has a phono preamp built-in. If your turntable (MM) doesn't have it, you'll need a commercially available phono preamp. If your turntable has a moving coil (MC) type cartridge, you'll need a commercially available MC head amp or MC transformer as well as a phono preamp. See your turntable's manual for details.
- With connection 4, you can enjoy Dolby Digital and DTS. (To listen in Zone 2/3 as well, use 4 and 8.)
  - With connection 8, you can enjoy audio from external components while you are in Zone 2/3.
  - With connection 8, if your Blu-ray Disc/DVD player has both the main stereo and multichannel outputs, be sure to connect the main stereo.



## Connecting Integra/Onkyo RI Components

- 1 Make sure that each Integra/Onkyo component is connected with an analog audio cable (connection 8 in the hookup examples) (→ page 16).
- 2 Make the **RI** connection (see the illustration).
- 3 If you're using an RI Dock, or cassette tape deck, change the Input Display (→ page 43).

With **RI** (Remote Interactive), you can use the following special functions:

### ■ System On/Auto Power On

When you start playback on a component connected via **RI**, while the AV receiver is on standby, the AV receiver will automatically turn on and select that component as the input source.

### ■ Direct Change

When playback is started on a component connected via **RI**, the AV receiver automatically selects that component as the input source.

### ■ Remote Control

You can use the AV receiver's remote controller to control your other **RI**-capable Integra/Onkyo components, pointing the remote controller at the AV receiver's remote control sensor instead of the component. You must enter the appropriate remote control code first (→ page 76).

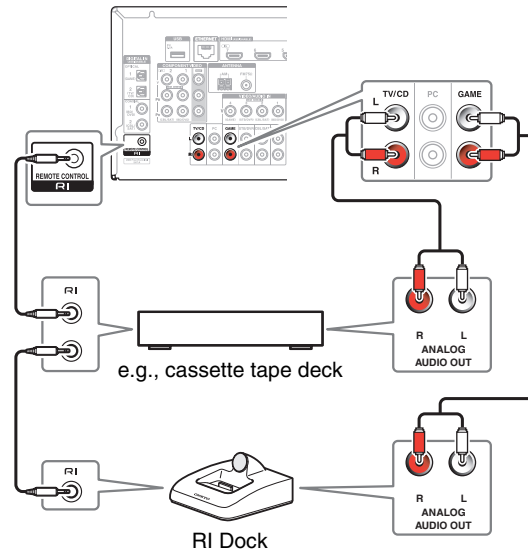

### Note

- Use only **RI** cables for **RI** connections. **RI** cables are supplied with Integra/Onkyo components.
- Some components have two **RI** jacks. You can connect either one to the AV receiver. The other jack is for connecting additional **RI**-capable components.
- Connect only Integra/Onkyo components to **RI** jacks. Connecting other manufacturer's components may cause a malfunction.
- Some components may not support all **RI** functions. Refer to the manuals supplied with your Integra/Onkyo components.
- While Zone 2/3 is on, the System On/Auto Power On and Direct Change **RI** functions do not work.

## Connecting the Antennas

This section explains how to connect the supplied indoor FM antenna and AM loop antenna. The AV receiver won't pick up any radio signals without any antenna connected, so you must connect the antenna to use the tuner.

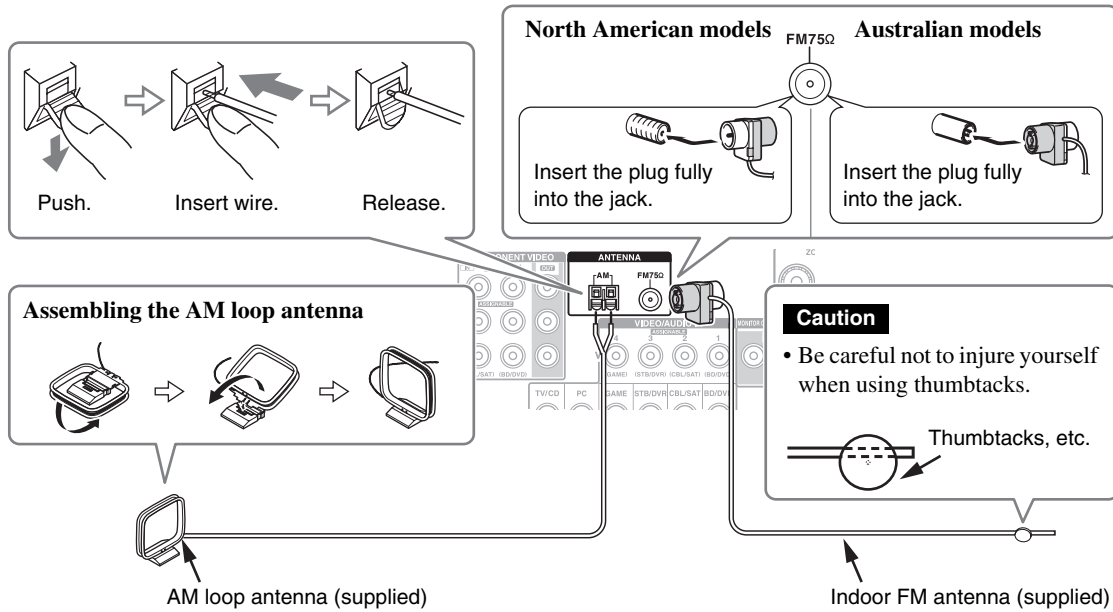

### Note

- Once your AV receiver is ready for use, you'll need to tune into a radio station and position the antenna to achieve the best possible reception.
- Keep the AM loop antenna as far away as possible from your AV receiver, TV, speaker cables, and power cords.

### Tip

- If you cannot achieve good reception with the supplied indoor FM antenna, try a commercially available outdoor FM antenna instead.
- If you cannot achieve good reception with the supplied indoor AM loop antenna, try using it with a commercially available outdoor AM antenna.

## Connecting the Power Cord

- 1 Connect the supplied power cord to the AV receiver's AC INLET.

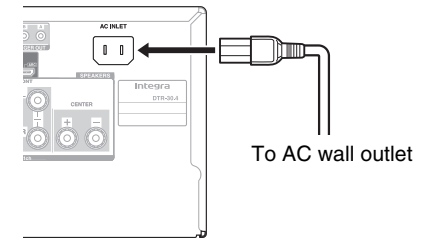

- 2 Plug the power cord into an AC wall outlet.

### Note

- Before connecting the power cord, connect all of your speakers and AV components.
- Turning on the AV receiver may cause a momentary power surge that might interfere with other electrical equipment on the same circuit. If this is a problem, plug the AV receiver into a different branch circuit.
- Do not use a power cord other than the one supplied with the AV receiver. The supplied power cord is designed exclusively for use with the AV receiver and should not be used with any other equipment.
- Never disconnect the power cord from the AV receiver while the other end is still plugged into a wall outlet. Doing so may cause an electric shock. Always disconnect the power cord from the wall outlet first, and then the AV receiver.

# Turning On/Off the AV Receiver

⏻ On/Standby

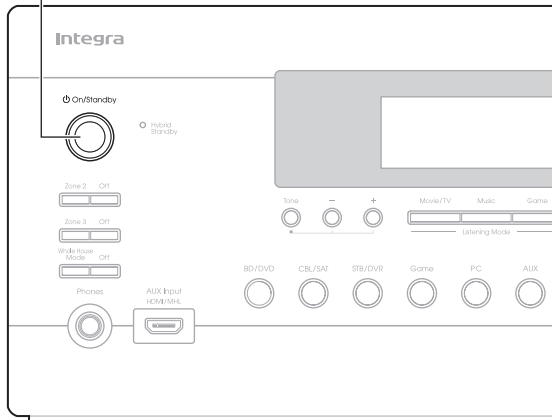

## Turning On

- 1 Press **⏻ On/Standby** on the front panel.  
or

Press **Receiver** followed by **⏻ Receiver** on the remote controller.

The AV receiver comes on and its display lights.

## Turning Off

- 1 Press **⏻ On/Standby** on the front panel.  
or

Press **Receiver** followed by **⏻ Receiver** on the remote controller.

The AV receiver will enter standby mode. To prevent any loud surprises when you turn on the AV receiver, always turn down the volume before you turn it off.

### Tip

- The **Hybrid Standby** indicator may light depending on the status of settings (→ [page 49](#)).
- For details on power management settings, see “Auto Standby” (→ [page 66](#)).

## Smooth Operation in a Few Easy Steps (Initial Setup)

To ensure smooth operation, here’s a few easy steps to help you configure the AV receiver before you use it for the very first time. These settings only need to be made once. See “Initial Setup” for details (→ [page 20](#)).

## If the “Firmware Update Available” window appears.

When a new version of the firmware is available, the notification window “**Firmware Update Available**” pops up. This notification only appears when the AV receiver is connected to your home network (→ [page 95](#)). To perform the firmware update, follow the instructions on screen.

Use **▲/▼** and **Enter** on the AV receiver or remote controller to select one of the options.

### ▶ Update Now:

Starts the firmware update.

Refer to “Firmware Update” (→ [page 85](#)).

### ▶ Remind me Later:

The update notification will pop up again the next time you turn the AV receiver on.

### ▶ Never Remind me:

Disables the automatic update notification.

### Tip

- The update notification window can be enabled or disabled in “Update Notice” (→ [page 66](#)).

# Initial Setup

This section explains the settings that we recommend you to make before using the AV receiver for the very first time. A setup wizard is launched upon first-time use to let you perform those settings.

**The on-screen menus appear only on a TV that is connected to HDMI OUT MAIN.**

## Selecting the Language for the Onscreen Setup Menus

This step determines the language used for the onscreen setup menus. See “**Language**” in “**OSD Setup**” (→ **page 63**).

### Tip

- Pressing **Home** will close the setup wizard. To restart the initial setup, select “**Initial Setup**” in the “**Hardware Setup**” menu (→ **page 66**).

After selecting the language for on-screen setup menus, a welcome screen is displayed.

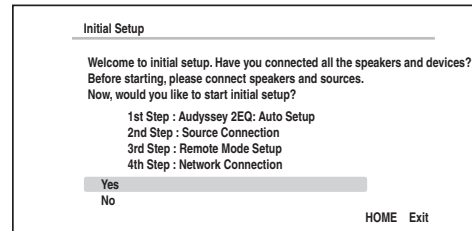

- Use **▲/▼** on the AV receiver or remote controller to select one of the following options, and then press **Enter**.

#### ► Yes:

Continues to “**Audyssey 2EQ: Auto Setup**”.

#### ► No:

Skips the settings and terminates the initial setup. The setup wizard goes to “Terminating the Initial Setup” (→ **page 21**). You can always restart the initial setup by selecting “**Initial Setup**” in the “**Hardware Setup**” menu (→ **page 66**).

## Audyssey 2EQ: Auto Setup

This step performs the automatic speaker setup.

- Use **▲/▼** to select one of the following options, and then press **Enter**.

#### ► Do it Now:

The automatic speaker setup is performed following instructions on screen. Refer to step 2 of “Using the Automatic Speaker Setup” (→ **page 32**). When this setting is complete, the setup wizard continues to “**Source Connection**”.

#### ► Do it Later:

Skips this setting.

Press **Enter** and continue to “**Source Connection**”.

## Source Connection

This step checks the connection of source components.

- 1 Use ▲/▼ to select one of the following options, and then press **Enter**.**
  - ▶ **Yes, Continue:**  
Performs the checkings.
  - ▶ **No, Skip:**  
Skips this step and continues to “**Remote Mode Setup**”.
- 2 Select the input selector for which you want to check the connection and press **Enter**.**  
The picture of the corresponding source should appear on screen with a verification prompt.
- 3 When prompted, use ▲/▼ to select one of the following options and then press **Enter**.**
  - ▶ **Yes:**  
Confirms that the source is properly displayed.
  - ▶ **No:**  
Displays an error report. Follow the troubleshooting instructions and recheck the source.
- 4 Use ▲/▼ to select one of the following options, and then press **Enter**.**
  - ▶ **Yes:**  
Returns to step 2.
  - ▶ **No, Done Checking:**  
The setup wizard continues to “**Remote Mode Setup**”.

## Remote Mode Setup

With this step, you can enter remote control codes for the components you want to operate.

- 1 Use ▲/▼ to select one of the following options, and then press **Enter**.**
  - ▶ **Yes:**  
Performs the remote control code input. Refer to step 5 of “Looking up for Remote Control Codes” (→ page 74).
  - ▶ **No, Skip:**  
Skips this step and continues to “**Network Connection**”.
- 2 When you’re finished, select one of the following options and press **Enter**.**
  - ▶ **Yes, Done:**  
The setup wizard continues to “**Network Connection**”.
  - ▶ **No, not yet:**  
You can enter other remote control codes.

## Network Connection

This step checks your network connection.

- 1 Use ▲/▼ to select one of the following options, and then press **Enter**.**
    - ▶ **Yes:**  
Performs the checkings.
    - ▶ **No, Skip:**  
Skips this step and terminates the initial setup.
- Note**
- If you use both wired and wireless network connections, the wireless will take priority.  
For further details, see the instruction manual provided with your wireless device.
- 2 Follow the instructions on screen to perform the network checking.**  
The checking is complete when the message “**Successfully connected.**” appears at the middle of the screen. Press **Enter** to terminate the initial setup.
  - 3 If an error message appears, select one of the following options and press **Enter**.**
    - ▶ **Retry:**  
Performs the checking again.
    - ▶ **No, Do it Later:**  
Skips this step and terminates the initial setup. The setup wizard goes to “Terminating the Initial Setup”.

## Terminating the Initial Setup

This step ends the initial setup process.

- 1 Press **Enter**.**  
To restart the initial setup, select “**Initial Setup**” in the “**Hardware Setup**” menu (→ page 66).

# Playback

The on-screen menus appear only on a TV that is connected to HDMI OUT MAIN. If your TV is connected to other video outputs, use the AV receiver's display when changing settings.

This section describes the procedure for using the remote controller, unless otherwise specified.

## Playing the Connected Component

### ■ Operating with the remote controller



- 1** Press **Receiver** followed by an **Input Selector** button.
- 2** Start playback on the source component.  
See also:
  - “Playing an iPod/iPhone via USB” (→ [page 24](#))
  - “Playing a USB Device” (→ [page 25](#))
  - “Listening to vTuner Internet Radio” (→ [page 25](#))
  - “Registering Other Internet Radio” (→ [page 26](#))
  - “Playing Music Files on a Server” (→ [page 27](#))
  - “Remote Playback” (→ [page 28](#))
  - “Listening to AM/FM Radio” (→ [page 29](#))
  - “Playing Audio and Video from Separate Sources” (→ [page 31](#))
  - “iPod/iPhone Playback via Onkyo Dock” (→ [page 72](#))
  - “Controlling Other Components” (→ [page 74](#))
- 3** To adjust the volume, use **VOL ▲/▼**.

### **4** Select a listening mode and enjoy!

See also:

- “Using the Listening Modes” (→ [page 35](#))

### ■ Operating on the AV receiver

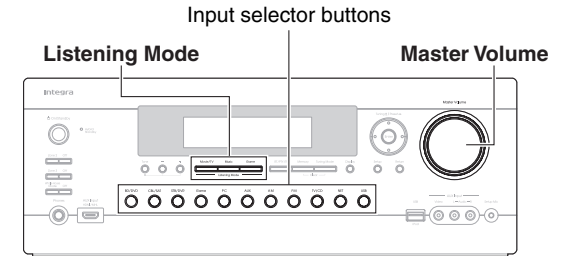

- 1** Use the input selector buttons to select the input source.
- 2** Start playback on the source component.
- 3** To adjust the volume, use the **Master Volume** control.
- 4** Select a listening mode and enjoy!

#### ■ Screen Saver

If there is no video signal on the current input source and no operation for a specific time (three minutes by default), a screen saver automatically comes on.

#### Tip

- The time until the screen saver activates itself can be changed in the “Screen Saver” setting (→ [page 63](#)).
- The screen will return to its previous state if the AV receiver is operated.

## Controlling Contents of USB or Network Devices

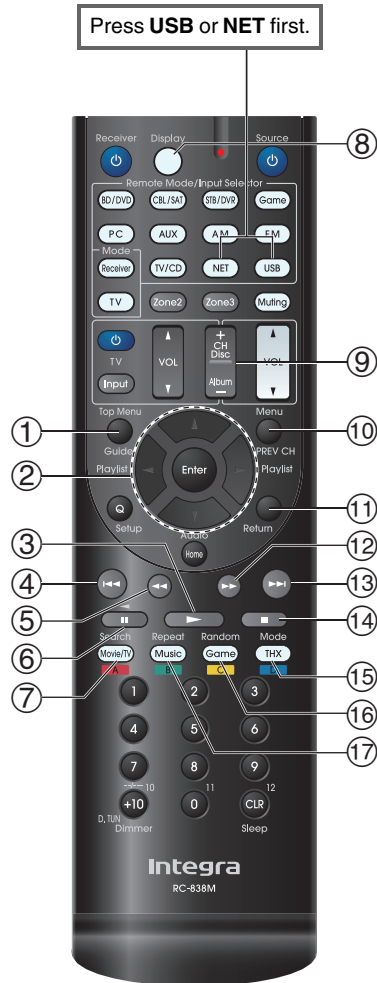

- ① **Top Menu**  
This button displays the top menu for each media or service.
- ② **▲/▼ and Enter**  
These buttons navigate through the menus.  
◀/▶  
This button cycles through pages.  
**Playlist** ◀/▶  
In Standard Mode (iPod/iPhone), this button selects playlists.
- ③ ▶  
This button starts playback.
- ④ ◀◀  
This button selects the beginning of the current song. Pressing this button twice selects the previous song.
- ⑤ ◀◀  
This button fast-reverses the current song.
- ⑥ ||  
This button pauses playback.
- ⑦ **Search**  
You can toggle between the playback screen and the list screen during playback.
- ⑧ **Display**  
This button switches between song information during playback. Press this button while the list screen is displayed to return to the playback screen.
- ⑨ **Album +/-**  
In Standard Mode (iPod/iPhone), this button selects albums.
- ⑩ **Menu**  
This button displays the menu of Internet radio services.
- ⑪ **Return**  
This button returns to the previous menu.
- ⑫ ▶▶  
This button fast-forwards the current song.
- ⑬ ▶▶▶  
This button selects the next song.

- ⑭ ■  
This button stops playback.
- ⑮ **Mode**  
You can switch between Standard Mode and Extended Mode.
- ⑯ **Random**  
This button performs random playback.
- ⑰ **Repeat**  
Press this button repeatedly to cycle through the repeat modes.

### Tip













- See “Controlling Other Components” about the operation of other components (→ **page 74**).

### Note

- The buttons you can use will differ depending on the devices and media used for playback.

## Understanding Icons on the Display

This section describes icons that appear on the AV receiver's display during media playback.

| Icon   | Description                 |
|--|-----------------------------|
|  | Folder                      |
|  | Track                       |
|  | Playback                    |
|  | Pause                       |
|  | Fast Forward                |
|  | Fast Reverse                |
|  | Artist                      |
|  | Album                       |
|  | Repeat One Track            |
|  | Repeat Folder (USB Device)  |
|  | Repeat                      |
|  | Shuffle                     |
|  | Shuffle Album (iPod/iPhone) |

## Playing an iPod/iPhone via USB

The on-screen menus appear only on a TV that is connected to HDMI OUT MAIN.

This section explains how to play music/video files on the iPod/iPhone.

Compatible iPod/iPhone models

Made for:

iPod touch (1st, 2nd, 3rd and 4th generation), iPod classic, iPod nano (2nd, 3rd, 4th, 5th and 6th generation), iPhone 4S, iPhone 4, iPhone 3GS, iPhone 3G, iPhone

### 1 Press **USB** repeatedly to select the “USB(Front)” input.

#### Tip

- The same operation can be done by selecting “USB” in the Home menu.

### 2 Connect the USB cable that comes with the iPod/iPhone to the USB port on the front of the AV receiver.

While reading the contents of your iPod/iPhone, the message “**Connecting...**” appears on the AV receiver's display.

The **USB** indicator lights. It will flash if the AV receiver cannot read the iPod/iPhone.

#### Tip

- When connecting your iPod/iPhone with a USB cable, we recommend you use an official USB cable from Apple Inc.

### 3 Press **Mode** repeatedly to switch to Extended Mode (Music) or Extended Mode (Video).

A list of your iPod/iPhone model's contents appears.

#### Tip

- If you want to operate using the iPod/iPhone or the remote controller, press **Mode** repeatedly to switch to Standard mode.
- When you disconnect the iPod/iPhone, the AV receiver remembers the current mode. This means that if you disconnect when in Extended Mode (Music), the AV receiver will start in Extended Mode (Music) the next time you connect the iPod/iPhone.

### 4 Use **▲/▼** to select a folder, and then press **Enter** to open it.

#### Tip

- You can also use the **▲/▼**, **Enter** and **Tuning Mode** buttons on the front panel. **Tuning Mode** allows you to switch modes.

### 5 Use **▲/▼** to select a music/video file, and press **Enter** or **▶** to start playback.

#### Note

- While the message “**Connecting...**” appears on the AV receiver's display, do not disconnect the USB cable supplied with your iPod/iPhone or the USB device from the **USB** port.
- If you connect an iPod or iPhone to the **USB** port, no sound will be output from the headphones jack.



## Extended Mode (Music) Control

The music content information is displayed (lists are displayed), and you can control the music content while looking at the screen.

Top screen list:

Playlists, Artists, Albums, Genres, Songs, Composers, Shuffle Songs, Now Playing.

### Note

- In this mode, video contents are not displayed, even if they are input from the **AUX Input Video** jack on the AV receiver's front panel.

## Extended Mode (Video) control

The video content information is displayed (lists are displayed), and you can control the video content while looking at the screen.

Top screen list:

Movies, Music Videos, TV Shows, Video Podcasts, Rentals.

### Note

- To view the video contents of your iPod/iPhone, connect it to the **USB** port and **AUX Input Video** jack on the AV receiver's front panel, using the official Apple Composite AV Cable.
- Depending on your iPod/iPhone model and generation, the displayed items may vary and the support for Extended Mode (Video) is not guaranteed.

## Standard Mode Control

The content information is not displayed, but can be operated using the iPod/iPhone or the remote controller.

## Playing a USB Device

The on-screen menus appear only on a TV that is connected to **HDMI OUT MAIN**.

This section explains how to play music files from a USB device (e.g., USB flash drives and MP3 players).

See also:

- “Network/USB Features” (→ page 95).

- 1 Press **USB** repeatedly to select the “USB(Front)” or “USB(Rear)” input.
- 2 Plug your USB device into the AV receiver's **USB** port.  
The **USB** indicator lights. It will flash if the AV receiver cannot read the USB device.
- 3 Press **Enter**.  
A list of the device's contents appears. To open a folder, use **▲/▼** to select it, and then press **Enter**.
- 4 Use **▲/▼** to select a music file, and press **Enter** or **▶** to start playback.

### Note

- While the message “**Connecting...**” appears on the AV receiver's display, do not disconnect the USB cable supplied with your iPod/iPhone or the USB device from the **USB** port.

## Listening to vTuner Internet Radio

You need to connect the AV receiver to your home network (→ page 95). The on-screen menus appear only on a TV that is connected to **HDMI OUT MAIN**.

The vTuner Internet Radio Service is a portal site featuring radio stations from all over the world.

You can search for stations by categories such as genre or location. The AV receiver is preinstalled with this service.

- 1 Press **NET**.  
The network service screen appears, and the **NET** indicator lights. If it flashes, verify that the Ethernet cable is firmly connected to the AV receiver.
- Tip**
- The same operation can be done by selecting “**Network Service**” in the Home menu.
- 2 Use **▲/▼/◀/▶** to select “vTuner Internet Radio” and then press **Enter**.
  - 3 Use **▲/▼** to select a program and then press **Enter**.  
Playback starts.

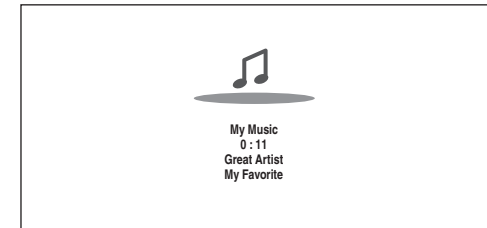

### Tip

- You can find stations similar to the one being played. During playback, press **Menu** on the remote controller, select “**Stations like this**” and press **Enter**.

## ■ Adding vTuner Internet Radio Stations to Favorites

There are two ways you can register specific Internet radio stations (programs) from the vTuner Internet Radio.

### Adding to My Favorites

The selected program will be added to “My Favorites” on the network service screen, which appears when pressing **NET** on the remote controller.

1. Press **Menu** with the station selected or while a station is playing.
2. Use **▲/▼** to select “Add to My Favorites”, and press **Enter**.
3. Use **▲/▼/◀/▶** to select “OK”, and press **Enter**.

#### Tip

- You can rename the stations saved in “My Favorites” (→ page 26).

### Adding to vTuner Internet Radio’s Favorites

Select “vTuner Internet Radio” and press **Enter** to display the “Favorites” folder that appears on the same screen as “Stations By Genre”, “Stations By Location”, etc. This is where your favorite Internet radio bookmarks will be stored.

To register your favorite stations using a personal computer, you need to connect your PC to the same network as the AV receiver. Enter the ID# (MAC address) of your unit on the <http://integra.vtuner.com/>. You can then register your favorite radio programs. The ID# is shown at the bottom of the “vTuner Internet Radio” top menu, and the AV receiver’s MAC address is shown on “Network” of the Setup menu (→ page 66).

## Registering Other Internet Radio

**You need to connect the AV receiver to your home network (→ page 95). The on-screen menus appear only on a TV that is connected to HDMI OUT MAIN.**

Internet radio URLs in the following formats are supported: PLS, M3U, and podcast (RSS). However, depending on the type of data or audio format used by the Internet radio station, you may not be able to listen to some stations.

To listen to other Internet radio stations, you must register your station in “My Favorites” of the network service screen, as described below.

#### Note

- Services available may vary depending on the region. See the separate instructions for more information.

- 1 Select “Network” on the Setup menu to verify your IP address (→ page 66).**  
Take a note of the IP address.
- 2 On your computer, start your web browser.**
- 3 Enter the AV receiver’s IP address in the browser’s Internet address (URL) field.**  
If you are using Internet Explorer®, you can also enter the URL by selecting “Open...” on the “File” menu. Information on the AV receiver is then shown on your Internet browser (Web Setup).
- 4 Click on the “My Favorites” tab, and enter the Internet radio station’s name and URL.**

## 5 Click “Save” to save the Internet radio station.

The Internet radio station is then added to “My Favorites”. To play the registered station, press **NET**, and then select “My Favorites” on the network service screen. A list of registered Internet radio stations appears. Select the one that you saved and press **Enter**.

#### Tip

- If you want to add a new station directly from “My Favorites”, select an empty slot in the list and press **Menu**. Then, select “Create New Station” and press **Enter**. Pressing **Enter** again will display the keyboard screen. Use that keyboard to enter the station’s name and URL respectively, and then press **Enter**.
- If you want to delete a station saved in “My Favorites”, press **Menu** with the station selected or while the station is playing. Then, use **▲/▼** to select “Delete from My Favorites” and press **Enter**. You can also delete stations from the Web Setup.
- If you want to rename a station, select the desired station and press **Menu**. Then, use **▲/▼** to select “Rename this station” and press **Enter**.
- You can save up to 40 Internet radio stations.

## Changing the Icon Layout on the Network Service Screen

The layout of icons can be customized by switching their positions on the network service screen.

### 1 Press NET.

The network service screen appears, and the NET indicator lights. If it flashes, verify that the Ethernet cable is firmly connected to the AV receiver.

#### Tip

- The same operation can be done by selecting “Network Service” in the Home menu.

### 2 Press Mode/D (blue) on the remote controller.

### 3 Use ▲/▼/◀/▶ to select an icon to move, and then press Enter.

### 4 Use ▲/▼/◀/▶ to select another icon as the destination, and then press Enter.

The icons switch positions and the message “Completed!” appears.

## Playing Music Files on a Server

You need to connect the AV receiver to your home network (→ page 95). The on-screen menus appear only on a TV that is connected to HDMI OUT MAIN.

This section explains how to play music files on a computer or media server through the AV receiver (Server Playback).

### 1 Start your computer or media server.

### 2 Press NET.

The network service screen appears. The NET indicator lights. If it flashes, confirm the network connection.

#### Tip

- The same operation can be done by selecting “Network Service” in the Home menu.

### 3 Use ▲/▼/◀/▶ to select “DLNA”, and press Enter.

#### Tip

- To go back to the previous screen, press Return.

### 4 Use ▲/▼ to select a server, and then press Enter.

The menu is displayed according to the server functions.

#### Note

- The search function does not work with media servers which do not support this function.
- Photos and movies stored on a media server cannot be accessed from the AV receiver.
- Depending on the sharing settings in the media server, the AV receiver may not be able to access the content. See the instruction manual of the media server.

### 5 Use ▲/▼ to select an item, and then press Enter or ▶ to start playback.

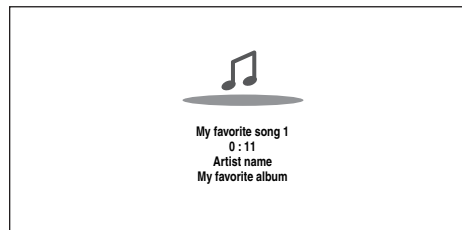

#### Note

- Depending on the media server, ◀◀/▶▶/|| may not work.
- If the message “No Item.” appears, this means that no information can be retrieved from the server. In this case, check your server, network, and AV receiver connections.

## Windows Media Player 11 Setup

This section explains how to configure Windows Media Player 11 so that the AV receiver can play the music files stored on your computer.

### 1 Start Windows Media Player 11.

### 2 On the “Library” menu, select “Media Sharing”.

The “Media Sharing” dialog box appears.

### 3 Select the “Share my media” check box, and then click “OK”.

A list of the supported devices appears.

### 4 Select the AV receiver in the list, and then click “Allow”.

The corresponding icon will be checked.

### 5 Click “OK” to close the dialog box.

This completes the Windows Media Player 11 configuration.

You can now play the music files in your Windows Media Player 11 library through the AV receiver.

#### Tip

- Windows Media Player 11 can be downloaded for free from the Microsoft web site.

## Remote Playback

**You need to connect the AV receiver to your home network (→ page 95). The on-screen menus appear only on a TV that is connected to HDMI OUT MAIN.**

Remote Playback means you can play the music files stored on a media server or personal computer with the AV receiver by operating the controller device in the home network.

### Windows Media Player 12 Setup

This section explains how to configure Windows Media Player 12 so that the AV receiver can play the music files stored on your personal computer.

#### 1 Start Windows Media Player 12.

#### 2 On the “Stream” menu, select “Turn on media streaming”.

A dialog box appears.

##### Tip

- If the media streaming is already activated, clicking on “More streaming options...” in the “Stream” menu will display a list of the playback devices connected to the network. You can skip step 3.

#### 3 Move your cursor and click on “Turn on media streaming”.

A list of media server appears. Wording may vary slightly depending on the network location.

#### 4 On the “Media streaming options”, select the AV receiver and confirm that it is set to “Allow”.

#### 5 Click “OK” to close the dialog box.

This completes the Windows Media Player 12 configuration.

You can now play the music files in your Windows Media Player 12 library.

##### Tip

- On the “Stream” menu, confirm that “Allow remote control of my Player...” is checked.

### Using Remote Playback

#### 1 Turn on the AV receiver.

#### 2 Start Windows Media Player 12.

To enable remote playback, you must first configure Windows Media Player 12.

#### 3 On Windows Media Player 12, right-click on a music file.

The right-click menu appears.

##### Tip

- For selecting another media server, select the desired media server from the “Other Libraries” menu on Windows Media Player 12.

#### 4 Select the AV receiver in “Remote playback”.

The “Play to” window appears and playback on the AV receiver starts. Operations during remote playback can be made from the “Play to” window of Windows 7 on your personal computer.

A playback screen will be displayed on the connected TV.

#### 5 Adjusting the Volume.

You can adjust the volume by adjusting the volume bar in the “Remote playback” window. The default maximum volume level is 82 (0dB). If you wish to change this, enter the value from the Web Setup in your browser. Refer to step 3 of “Registering Other Internet Radio” for details (→ page 26).

The volume value of the remote window and the volume value of the AV receiver may not always match.

Adjustments you make to the volume in the AV receiver will not be reflected in the “Remote playback” window.

##### Note

- Remote playback cannot be used in any of the following cases:
  - Network services are being used.
  - Contents are being played from a USB device or iPod/iPhone.
  - Zones are turned on.

## Listening to AM/FM Radio

This section describes the procedure of using the buttons on the front panel, unless otherwise specified.

### Using the Tuner

With the built-in tuner you can enjoy AM and FM radio stations. You can store your favorite stations as presets for quick selection.

You can also change the frequency steps (→ page 64).

- 1 Press **AM** or **FM** to select either “AM” or “FM”.  
In this example, FM has been selected.

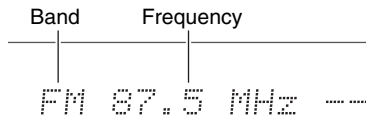

(Actual display depends on the country.)

## Tuning into Radio Stations

### Auto tuning mode

- 1 Press **Tuning Mode** so that the **AUTO** indicator lights on the AV receiver's display.
- 2 Press **Tuning ▲/▼**.  
Searching stops when a station is found.

When tuned into a station, the **TUNED** indicator lights. When tuned into a stereo FM station, the **FM STEREO** indicator lights as shown.



### Tip

#### • Tuning into weak FM stereo stations

If the signal from a stereo FM station is weak, it may be impossible to get good reception. In this case, switch to manual tuning mode and listen to the station in mono.

### Manual tuning mode

In manual tuning mode, FM stations will be in mono.

- 1 Press **Tuning Mode** so that the **AUTO** indicator goes off on the AV receiver's display.
- 2 Press and hold **Tuning ▲/▼**.  
The frequency stops changing when you release the button.  
Press the buttons repeatedly to change the frequency one step at a time.

### Tuning into stations by frequency

You can tune into AM and FM stations directly by entering the appropriate frequency.

- 1 On the remote controller, press **AM** or **FM** to select “AM” or “FM”, followed by **D.TUN**.

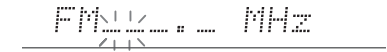

(Actual display depends on the country.)

- 2 Within 8 seconds, use the number buttons to enter the frequency of the radio station.

For example, to tune to 87.5 (FM), press **8, 7, 5** or **8, 7, 5, 0**.

If you have entered the wrong number, you can retry after 8 seconds.

## Presetting AM/FM Stations

You can store a combination of up to 40 of your favorite AM/FM radio stations as presets.

### 1 Tune into the AM/FM station that you want to store as a preset.

See the previous section.

### 2 Press Memory.

The preset number flashes.

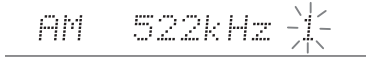

(Actual display depends on the country.)

### 3 While the preset number is flashing (about 8 seconds), use Preset ◀/▶ to select a preset from 1 through 40.

### 4 Press Memory again to store the station or channel.

The station or channel is stored and the preset number stops flashing.

Repeat this procedure for all of your favorite AM/FM radio stations.

## ■ Selecting Presets

### 1 To select a preset, use Preset ◀/▶ on the AV receiver, or the remote controller's CH +/-.

#### Tip

- You can also use the remote controller's number buttons to select a preset directly.

## ■ Deleting Presets

### 1 Select the preset that you want to delete.

See the previous section.

### 2 While holding down Memory, press Tuning Mode.

The preset is deleted and its number disappears from the AV receiver's display.

## Using RDS (excluding North American models)

**RDS works only in areas where RDS broadcasts are available.**

When tuned into an RDS station, the **RDS** indicator lights. When the station is broadcasting text information, the text can be displayed.

### ■ What is RDS?

RDS stands for Radio Data System and is a method of transmitting data in FM radio signals. It was developed by the European Broadcasting Union (EBU) and is available in most European countries. Many FM stations use it these days. In addition to displaying text information, RDS can also help you find radio stations by type (e.g., news, sport, rock, etc.).

The AV receiver supports four types of RDS information: **PS (Program Service)**

When tuned to an RDS station that's broadcasting PS information, the station's name will be displayed. Pressing **Display** will display the frequency for 3 seconds.

#### **RT (Radio Text)**

When tuned to an RDS station that's broadcasting text information, the text will be shown on the AV receiver's display as described in the next section.

#### **PTY (Program Type)**

This allows you to search for RDS radio stations by type (→ page 31).

## TP (Traffic Program)

This allows you to search for RDS radio stations that broadcast traffic information (→ page 31).

#### Note

- In some cases, the text characters displayed on the AV receiver may not be identical to those broadcast by the radio station. Also, unexpected characters may be displayed when unsupported characters are received. This is not a malfunction.
- If the signal from an RDS station is weak, RDS data may be displayed intermittently or not at all.

## ■ Displaying Radio Text (RT)

### 1 Press RT/PTY/TP once.

The RT information scrolls across the AV receiver's display.

#### Note

- The message "**Waiting**" may appear while the AV receiver waits for the RT information.
- If the message "**No Text Data**" appears, no RT information is available.

## ■ Finding Stations by Type (PTY)

You can search for radio stations by type.

- 1 Press RT/PTY/TP twice.**  
The current program type appears on the AV receiver's display.
- 2 Use Preset ◀/▶ to select the type of program you want.**  
See the table shown later in this chapter.
- 3 To start the search, press Enter.**  
The AV receiver searches until it finds a station of the type you specified, at which point it stops briefly before continuing with the search.
- 4 When a station you want to listen to is found, press Enter.**  
If no stations are found, the message "Not Found" appears.

## ■ Listening to Traffic News (TP)

You can search for stations that broadcast traffic news.

- 1 Press RT/PTY/TP three times.**  
If the current radio station is broadcasting TP (Traffic Program), "[TP]" will appear on the AV receiver's display. If "TP" without square brackets appears, this means that the station is not broadcasting TP.
- 2 To locate a station that is broadcasting TP, press Enter.**  
The AV receiver searches until it finds a station that's broadcasting TP.  
If no stations are found, the message "Not Found" appears.

## RDS program types (PTY)

| Type                     | Display  |
|--------------------------|----------|
| None                     | None     |
| News reports             | News     |
| Current affairs          | Affairs  |
| Information              | Info     |
| Sport                    | Sport    |
| Education                | Educate  |
| Drama                    | Drama    |
| Culture                  | Culture  |
| Science and technology   | Science  |
| Varied                   | Varied   |
| Pop music                | Pop M    |
| Rock music               | Rock M   |
| Middle of the road music | Easy M   |
| Light classics           | Light M  |
| Serious classics         | Classics |
| Other music              | Other M  |
| Weather                  | Weather  |
| Finance                  | Finance  |
| Children's programmes    | Children |
| Social affairs           | Social   |
| Religion                 | Religion |
| Phone in                 | Phone In |
| Travel                   | Travel   |
| Leisure                  | Leisure  |
| Jazz music               | Jazz     |
| Country music            | Country  |
| National music           | Nation M |
| Oldies music             | Oldies   |
| Folk music               | Folk M   |
| Documentary              | Document |
| Alarm test               | TEST     |
| Alarm                    | Alarm!   |

## Playing Audio and Video from Separate Sources

You can listen to the audio of one input source while watching the video of another. This function takes advantage of the fact that when an audio-only input source (**BD/DVD, CBL/SAT, STB/DVR, Game, PC, TV/CD**) is selected, the video input source remains unchanged. The following procedure shows how to listen to a CD player's audio source connected to **TV/CD IN** while watching a Blu-ray Disc/DVD player's video source connected to **BD/DVD**.

### Tip

- To use an analog audio input as audio-exclusive, you must set "Composite Video Input" to "-----" (→ **page 51**).

- 1 Press BD/DVD.**
- 2 Press TV/CD.**  
The audio output changes to the CD source, but the video of previously-selected **BD/DVD** is retained.
- 3 Start playback on your Blu-Ray Disc/DVD and CD players.**  
You can now enjoy watching your Blu-ray Disc/DVD with the sound of your CD player.

# Using Basic Functions

## Using the Automatic Speaker Setup

With the supplied calibrated microphone, Audyssey 2EQ® automatically determines the number of speakers connected, their size for purposes of bass management, optimum crossover frequencies to the subwoofer (if present), and distances from the primary listening position. Audyssey 2EQ then removes the distortion caused by room acoustics by capturing room acoustical problems over the listening area in both the frequency and time domain. The result is clear, well-balanced sound for everyone.

Audyssey 2EQ can be used with Audyssey Dynamic EQ® and Audyssey Dynamic Volume® (→ [page 57](#)).

Before using this function, connect and position all of your speakers.

Audyssey 2EQ offers two ways of measuring: the “**Audyssey Quick Start**” and “**Audyssey 2EQ Full Calibration**”.

- “**Audyssey Quick Start**” uses the measurement from one position to perform the speaker setting only.
- “**Audyssey 2EQ Full Calibration**” uses the measurement from three positions to correct room response in addition to the speaker setting.

The more positions are used in measuring, the better the listening environment will become. We recommend using a measurement from three positions to create the best listening environment.

The Quick Start takes 2 minutes and Full Calibration takes about 10 minutes.

Total measurement time varies depending on the number of speakers.

## Measurement procedure

To create a listening environment in your home theater that all listeners will enjoy, Audyssey 2EQ takes measurements at up to three positions within the listening area. Position the microphone at ear height of a seated listener with the microphone tip pointed directly at the ceiling using a tripod. Do not hold the microphone in your hand during measurements as this will produce inaccurate results.

### ① First measurement position

Also referred to as the Main Listening Position, this refers to the most central position where one would normally sit within the listening environment. Audyssey 2EQ uses the measurements from this position to calculate speaker distance, level, polarity, and the optimum crossover value for the subwoofer.

### ② Second measurement position

The right side of the listening area.

### ③ Third measurement position

The left side of the listening area.

The distances from position ① to ② and ① to ③ must be at least 1 meter (3.3 ft.).

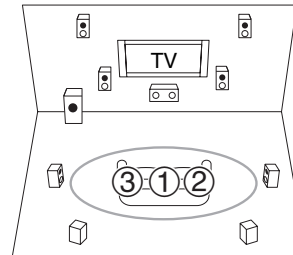

○ : Listening area

① to ③: Listening position

## Note

- Make the room as quiet as possible. Background noise and Radio Frequency Interference (RFI) can disrupt the room measurements. Close windows, televisions, radios, air conditioners, fluorescent lights, home appliances, light dimmers, or other devices. Turn off the cell phone (even if it is not in use) or place it away from all audio electronics.
- The microphone picks up test tones played through each speaker as Audyssey 2EQ Room Correction and Speaker Setup runs.
- Audyssey 2EQ Room Correction and Speaker Setup cannot be performed while a pair of headphones is connected.



**1 Turn on the AV receiver and the connected TV.**  
On the TV, select the input to which the AV receiver is connected.

**2 Set the speaker setup microphone at the Main Listening Position ①, and connect it to the Setup Mic jack.**

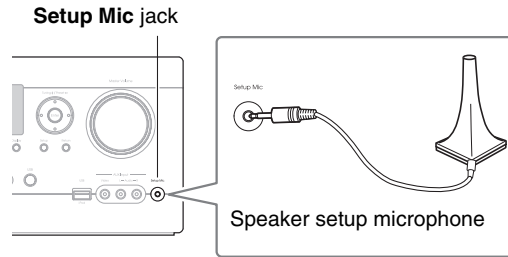

The speaker setting menu appears.

#### Note

- The on-screen menus appear only on a TV that is connected to **HDMI OUT MAIN**. If your TV is connected to other video outputs, use the AV receiver's display when changing settings.

**3 When you've finished making the settings, press Enter.**

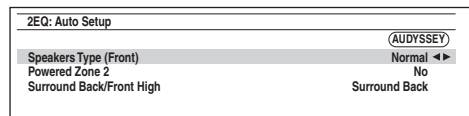

Perform the "Speaker Setup" according to your speaker configuration:

- **Speakers Type (Front)** (→ page 52)
- **Powered Zone 2** (→ page 52)
- **Surround Back/Front High** (→ page 53)

**4 Use ▲/▼ to select "Audyssey Quick Start" or "Audyssey 2EQ Full Calibration", and then press Enter.**

**5 Press Enter.**  
Audyssey 2EQ® Room Correction and Speaker Setup starts.

Test tones are played through each speaker as Audyssey 2EQ Room Correction and Speaker Setup runs. This process takes a few minutes. Please **refrain from talking** during measurements and **do not stand** between speakers and the microphone.

Do not disconnect the speaker setup microphone during Audyssey 2EQ Room Correction and Speaker Setup, unless you want to cancel the setup.

If you select "**Audyssey Quick Start**", you will go to step 8.

**6 Place the speaker setup microphone at the next position, and then press Enter.**

Audyssey 2EQ performs more measurements. This takes a few minutes.

**7 When prompted, repeat step 6.**

**8 Use ▲/▼ to select an option, and then press Enter.**

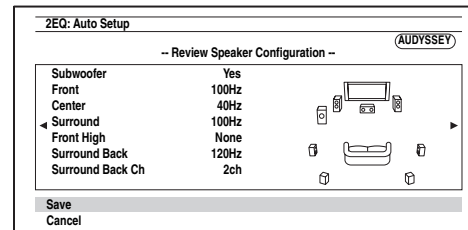

The options are:

- ▶ **Save:**  
Save the calculated settings and exit Audyssey 2EQ Room Correction and Speaker Setup.
- ▶ **Cancel:**  
Cancel Audyssey 2EQ Room Correction and Speaker Setup.

#### Tip

- You can view the calculated settings for the speaker configuration, speaker distances, and speaker levels by using ◀/▶.

**9 Use ▲/▼ to select a target, and use ◀/▶ to change the setting.**

After the results of Audyssey 2EQ have been saved, the menu will display the "Audyssey" (→ page 57), "Dynamic EQ" (→ page 57), "Dynamic Volume" (→ page 58) settings.

#### Note

- When "**Audyssey Quick Start**" has been used for measurement, "Audyssey" cannot be selected.
- These settings are applied to all input selectors.

**10 Press Enter.**

**11 Disconnect the speaker setup microphone.**

#### Note

- You can cancel Audyssey 2EQ Room Correction and Speaker Setup at any point in this procedure simply by disconnecting the setup microphone.
- Do not connect or disconnect any speakers during Audyssey 2EQ Room Correction and Speaker Setup.
- If the AV receiver is muted, it will be unmuted automatically when Audyssey 2EQ Room Correction and Speaker Setup starts.
- Changes to the room after Audyssey 2EQ Room Correction and Speaker Setup requires you run Audyssey 2EQ Room Correction and Speaker Setup again, as room EQ characteristics may have changed.

## Error Messages

While Audyssey 2EQ® Room Correction and Speaker Setup is in progress, one of the error messages below may appear.

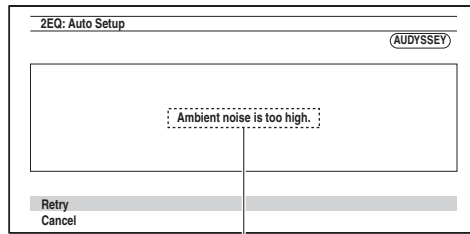

Error message

The options are:

▶ **Retry:**

Try again.

▶ **Cancel:**

Cancel Audyssey 2EQ Room Correction and Speaker Setup.

• **Ambient noise is too high.**

The background noise is too loud. Remove the source of the noise and try again.

• **Speaker Matching Error!**

The number of speakers detected was different from that of the first measurement. Check the speaker connection.

• **Writing Error!**

This message appears if saving fails. Try saving again. If this message appears after 2 or 3 attempts, contact your Onkyo dealer.

• **Speaker Detect Error**

This message appears if a speaker is not detected. “No” means that no speaker was detected.

**Tip**

- See “Speaker Configuration” for appropriate settings (→ page 11).

## Changing the Speaker Setup Manually

You can manually make changes to the settings found during Audyssey 2EQ Room Correction and Speaker Setup.

See also:

- “Speaker Configuration” (→ page 52)
- “Speaker Distance” (→ page 53)
- “Level Calibration” (→ page 54)
- “Equalizer Settings” (→ page 54)

**Note**

- Please note that THX recommends any THX main speakers be set to “80Hz(THX)”. If you set up your speakers using Audyssey 2EQ Room Correction and Speaker Setup, please make sure manually that any THX speakers are set to “80Hz(THX)” crossover (→ page 52).
- Sometimes due to the electrical complexities of subwoofers and the interaction with the room, THX recommends setting the level and the distance of the subwoofer manually.
- Sometimes due to interaction with the room, you may notice irregular results when setting the level and/or distance of the main speakers. If this happens, THX recommends setting them manually.

## Using a Powered Subwoofer

If you’re using a powered subwoofer and it outputs very low-frequency sound at a low volume level, it may not be detected by Audyssey 2EQ Room Correction and Speaker Setup.

If the “Subwoofer” appears on the “Review Speaker Configuration” screen as “No”, increase the subwoofer’s volume to the half-way point, set it to its highest crossover frequency, and then try running Audyssey 2EQ Room Correction and Speaker Setup again. Note that if the volume is set too high and the sound distorts, detection issues may occur, so use an appropriate volume level. If the subwoofer has a low-pass filter switch, set it to Off or Direct. Refer to your subwoofer’s instruction manual for details.

## Using the Listening Modes

### Selecting Listening Modes

See “About Listening Modes” for detailed information about the listening modes (→ [page 36](#)).

#### ■ Listening Mode Buttons

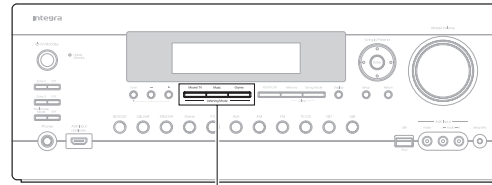
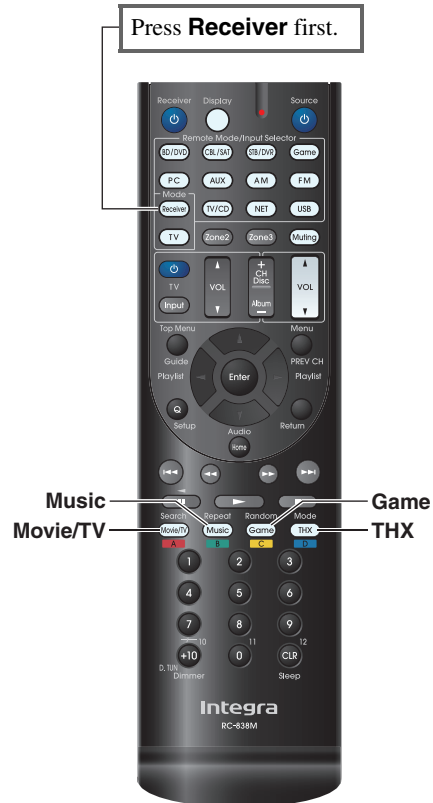

**Movie/TV, Music, Game**

#### **Movie/TV button**

This button selects the listening modes intended for use with movies and TV.

#### **Music button**

This button selects the listening modes intended for use with music.

#### **Game button**

This button selects the listening modes intended for use with video games.

#### **THX button**

This button selects the THX listening modes.

- The Dolby Digital and DTS listening modes can only be selected if your Blu-ray Disc/DVD player is connected to the AV receiver with a digital audio connection (coaxial, optical, or HDMI).
- The listening modes you can select depends on the format of the input signal. To check the format, see “Displaying Source Information” (→ [page 43](#)).
- While a pair of headphones is connected, you can select the following listening modes: Mono, Direct, and Stereo.

## About Listening Modes

The AV receiver's listening modes can transform your listening room into a movie theater or concert hall, with high fidelity and stunning surround sound.

### ■ Explanatory Notes

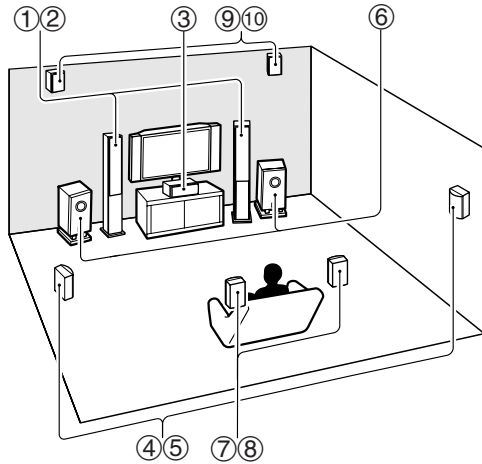

- ① ② Front speakers
- ③ Center speaker
- ④ ⑤ Surround speakers
- ⑥ Subwoofer(s)
- ⑦ ⑧ Surround back speakers
- ⑨ ⑩ Front high speakers

### Input Source

The following audio formats are supported by the listening modes.

|                         |   |
|-------------------------|---|
| <b>MONO</b>             | This is mono (monophonic) sound.  |
| <b>STEREO</b>           | This is stereo (stereophonic) sound. Two independent audio signal channels are reproduced through two speakers.   |
| <b>5.1ch</b>            | This is 5.1-channel surround sound. This surround system has five main channels of sound and a sixth subwoofer channel (called the point-one channel).  |
| <b>7.1ch</b>            | This is 7.1-channel surround sound. This is a further sound enhancement to 5.1-channel sound with two additional speakers that provide greater sound envelopment and more accurate positioning of sounds. |
| <b>DTS-ES</b>           | This is DTS-ES surround sound. This surround system can produce a discrete or a matrix-encoded sixth channel from existing DTS 5.1 encoded material.  |
| <b>Dolby Digital EX</b> | This is Dolby Digital EX surround sound. This provides a center back surround channel from 5.1-channel sources.   |

### Speaker Layout

The illustration shows which speakers are activated in each channel. See "Speaker Configuration" for the speaker setup (→ [page 52](#)).

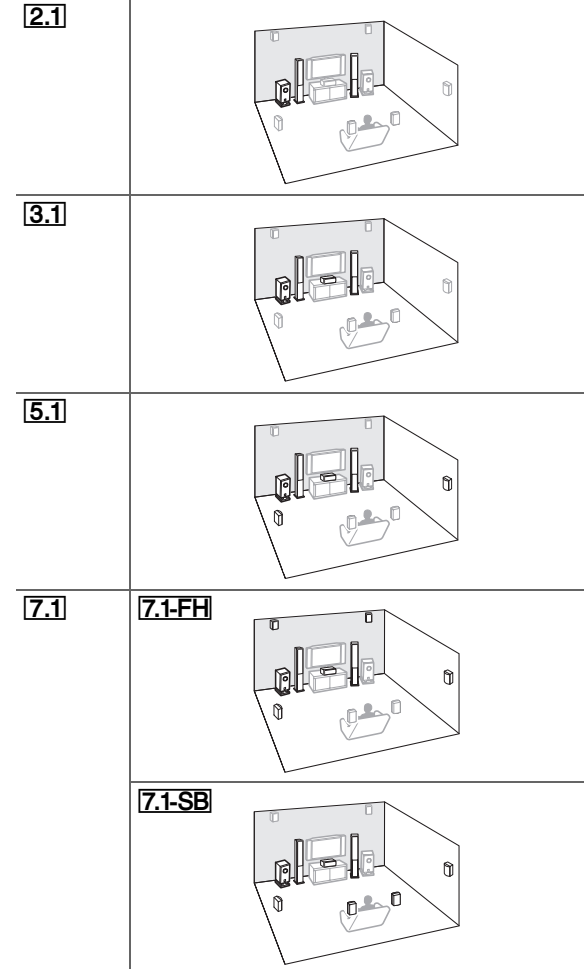

## ■ Onkyo-Original DSP Listening Modes

| Listening Mode                               | Description   | Input Source   | Speaker Layout                   |
|--|---|--|----------------------------------|
| <b>Orchestra</b><br><i>Orchestra</i>         | Suitable for classical or operatic music, this mode emphasizes the surround channels in order to widen the stereo image, and simulates the natural reverberation of a large hall. | <b>MONO</b><br><b>STEREO</b><br><b>5.1ch</b><br><b>7.1ch</b><br><b>DTS-ES</b><br><b>DJEX</b> | <b>5.1</b> <b>7.1</b>            |
| <b>Unplugged</b><br><i>Unplugged</i>         | Suitable for acoustic instruments, vocals and jazz, this mode emphasizes the front stereo image, giving the impression of being right in front of the stage.                      |  |                                  |
| <b>Studio-Mix</b><br><i>Studio-Mix</i>       | Suitable for rock or pop music, listening to music in this mode creates a lively sound field with a powerful acoustic image, like being at a club or rock concert.                |  |                                  |
| <b>TV Logic</b><br><i>TV Logic</i>           | This mode adds realistic acoustics to TV shows produced in a TV studio, surround effects to the entire sound, and clarity to voices.  |  |                                  |
| <b>Game-RPG</b><br><i>Game-RPG</i>           | In this mode, the sound has a dramatic feel with a similar atmosphere to Orchestra mode.  |  |                                  |
| <b>Game-Action</b><br><i>Game-Action</i>     | In this mode, sound localization is distinct with emphasis on bass.   |  |                                  |
| <b>Game-Rock</b><br><i>Game-Rock</i>         | In this mode, sound pressure is emphasized to heighten live feel.   |  |                                  |
| <b>Game-Sports</b><br><i>Game-Sports</i>     | In this mode, reverberation is increased and sound localization decreased slightly.   |  |                                  |
| <b>All Ch Stereo</b><br><i>All Ch Stereo</i> | Ideal for background music, this mode fills the entire listening area with stereo sound from the front, surround, and surround back speakers.                                     |  | <b>3.1</b> <b>5.1</b> <b>7.1</b> |
| <b>Full Mono</b><br><i>Full Mono</i>         | In this mode, all speakers output the same sound in mono, so the sound you hear is the same regardless of where you are within the listening room.                                |  |                                  |

| Listening Mode                                 | Description  | Input Source   | Speaker Layout                                 |
|--|--|--|--|
| <b>T-D (Theater-Dimensional)</b><br><i>T-D</i> | With this mode you can enjoy a virtual surround sound even with only two or three speakers. This works by controlling how sounds reach the listener's left and right ears. Good results may not be possible if there's too much reverb, so we recommend that you use this mode in an environment with little or no natural reverb. | <b>MONO</b><br><b>STEREO</b><br><b>5.1ch</b><br><b>7.1ch</b><br><b>DTS-ES</b><br><b>DJEX</b> | <b>2.1</b> <b>3.1</b> <b>5.1</b><br><b>7.1</b> |

## ■ Listening Modes

| Listening Mode  | Description  | Input Source                 | Speaker Layout   |
|---|--|------------------------------|--|
| <b>Direct</b><br><i>Direct</i>                            | In this mode, audio from the input source is output without surround-sound processing. The speaker configuration (presence of speakers) and speaker distance settings are enabled, but much of the processing set via the audio setup is disabled. See “On-screen Setup” for more details (→ page 45).       | <b>MONO</b>                  | <b>2.1</b> <b>3.1</b> <b>5.1</b>   |
|   |  | <b>STEREO</b>                | <b>7.1</b> <sup>*1</sup>   |
|   |  | <b>5.1ch</b>                 |  |
|   |  | <b>7.1ch</b>                 |  |
|   |  | <b>DTS-ES</b>                |  |
|   |  | <b>DJEX</b>                  |  |
| <b>Stereo</b><br><i>Stereo</i>                            | Sound is output from the front left and right speakers and subwoofer.  |                              | <b>2.1</b> <b>3.1</b> <b>5.1</b><br><b>7.1</b>                                     |
| <b>Mono</b><br><i>Mono</i>                                | Use this mode when watching an old movie with a mono soundtrack, or use it with the foreign language soundtracks recorded in the left and right channels of some movies. It can also be used with DVDs or other sources containing multiplexed audio, such as karaoke DVDs.                                  |                              |  |
| <b>Multichannel</b><br><i>Multich</i>                     | This mode is for use with PCM multichannel sources.  | <b>5.1ch</b><br><b>7.1ch</b> | <b>3.1</b> <b>5.1</b> <b>7.1</b>   |
| <b>DSD<sup>2</sup></b><br><i>DSD</i>                      | In this mode, audio from the input source is output without surround-sound processing. The speaker configuration (presence of speakers), crossover frequency, speaker distance, A/V Sync and much of the processing set via the audio setup are enabled. See “On-screen Setup” for more details (→ page 45). | <b>5.1ch</b>                 | <b>3.1</b> <b>5.1</b> <b>7.1</b>   |
| <b>Dolby Digital</b><br><i>Dolby D</i>                    |  |                              |  |
| <b>Dolby Digital Plus<sup>3</sup></b><br><i>Dolby D +</i> |  | <b>5.1ch</b>                 | <b>3.1</b> <b>5.1</b> <b>7.1</b>   |
|   |  | <b>7.1ch</b>                 | <b>3.1</b> <b>5.1</b> <b>7.1</b> <sup>*1</sup>                                     |
| <b>Dolby TrueHD</b><br><i>Dolby TrueHD</i>                |  | <b>5.1ch</b><br><b>7.1ch</b> | <b>3.1</b> <b>5.1</b> <b>7.1</b><br><b>3.1</b> <b>5.1</b> <b>7.1</b> <sup>*1</sup> |

| Listening Mode   | Description  | Input Source  | Speaker Layout   |
|--|--|---|--|
| <b>DTS</b><br><i>DTS</i>                                 | In this mode, audio from the input source is output without surround-sound processing. The speaker configuration (presence of speakers), crossover frequency, speaker distance, A/V Sync and much of the processing set via the audio setup are enabled. See “On-screen Setup” for more details (→ page 45).   | <b>5.1ch</b>  | <b>3.1</b> <b>5.1</b> <b>7.1</b>   |
| <b>DTS-HD High Resolution Audio</b><br><i>DTS-HD HR</i>  |  | <b>5.1ch</b><br><b>7.1ch</b>  | <b>3.1</b> <b>5.1</b> <b>7.1</b><br><b>3.1</b> <b>5.1</b> <b>7.1</b> <sup>*1</sup> |
| <b>DTS-HD Master Audio</b><br><i>DTS-HD MSTR</i>         |  | <b>5.1ch</b><br><b>7.1ch</b>  | <b>3.1</b> <b>5.1</b> <b>7.1</b><br><b>3.1</b> <b>5.1</b> <b>7.1</b> <sup>*1</sup> |
| <b>DTS Express</b><br><i>DTS Express</i>                 |  | <b>5.1ch</b>  | <b>3.1</b> <b>5.1</b> <b>7.1</b>   |
| <b>DTS 96/24<sup>4</sup></b><br><i>DTS 96/24</i>         |  | This mode is for use with DTS 96/24 sources. This is high-resolution DTS with a 96 kHz sampling rate and 24-bit resolution, providing superior fidelity. Use it with DVDs that bear the DTS 96/24 logo. | <b>5.1ch</b>   |
| <b>DTS-ES Discrete<sup>5</sup></b><br><i>ES Discrete</i> | This mode is for use with DTS-ES Discrete soundtracks, which use a discrete surround back channel for true 6.1/7.1-channel playback. The seven totally separate audio channels provide better spatial imaging and 360-degree sound localization, perfect for sounds that pan across the surround channels. Use it with DVDs that bear the DTS-ES logo, especially those with a DTS-ES Discrete soundtrack. | <b>DTS-ES</b>   | <b>7.1-SB</b>  |
| <b>DTS-ES Matrix<sup>5</sup></b><br><i>ES Matrix</i>     | This mode is for use with DTS-ES Matrix soundtracks, which use a matrix-encoded back-channel for 6.1/7.1-channel playback. Use it with DVDs that bear the DTS-ES logo, especially those with a DTS-ES Matrix soundtrack.   | <b>DTS-ES</b>   | <b>7.1-SB</b>  |

| Listening Mode   | Description  | Input Source  | Speaker Layout                   |
|--|--|---|----------------------------------|
| <b>Dolby Pro Logic IIx<sup>6</sup><br/>Dolby Pro Logic II</b><br><i>PLII Movie</i><br><i>PLII Music</i><br><i>PLII Game</i><br><i>PLIIx Movie</i><br><i>PLIIx Music</i><br><i>PLIIx Game</i> | <p><b>Dolby Pro Logic IIx</b> expands any 2-channel source for 7.1-channel playback. It provides a very natural and seamless surround-sound experience that fully envelops the listener. As well as music and movies, video games can also benefit from the dramatic spatial effects and vivid imaging.</p> <p>If you're not using any surround back speakers, <b>Dolby Pro Logic II</b> will be used instead of Dolby Pro Logic IIx.</p> <ul style="list-style-type: none"> <li>• <b>Dolby PLIIx Movie</b><br/>Use this mode with any stereo or Dolby Surround (Pro Logic) movie (e.g., TV, DVD, VHS).</li> <li>• <b>Dolby PLIIx Music</b><br/>Use this mode with any stereo or Dolby Surround (Pro Logic) music source (e.g., CD, radio, cassette, TV, VHS, DVD).</li> <li>• <b>Dolby PLIIx Game</b><br/>Use this mode with video games, especially those that bear the Dolby Pro Logic II logo.</li> </ul> <ul style="list-style-type: none"> <li>• <b>Dolby PLIIx Movie</b></li> <li>• <b>Dolby PLIIx Music</b><br/>These modes use the Dolby Pro Logic IIx modes to expand 5.1-channel sources for 7.1-channel playback.</li> </ul> | <b>STEREO</b>   | <b>3.1</b> <b>5.1</b> <b>7.1</b> |
| <b>Dolby Pro Logic IIz Height</b><br><i>PLIIz Height</i>   | <p><b>Dolby Pro Logic IIz Height</b> is designed to more effectively use existing program material when height channel speaker outputs are present. <b>Dolby Pro Logic IIz Height</b> can be used to upmix a variety of sources from movies and music, but are particularly well-suited to upmix game content.</p>   | <b>STEREO</b><br><b>5.1ch</b><br><b>7.1ch</b><br><b>DTS-ES</b><br><b>DJEX</b> | <b>7.1-FH</b>                    |
| <b>Dolby EX</b><br><i>Dolby EX</i><br><i>Dolby D EX</i>  | <p>These modes expand 5.1-channel sources for 6.1/7.1-channel playback. They're especially suited to Dolby EX soundtracks that include a matrix-encoded surround back channel. The additional channel adds an extra dimension and provides an enveloping surround sound experience, perfect for rotating and fly-by sound effects.</p>   | <b>5.1ch</b><br><b>DJEX</b>   | <b>7.1-SB</b>                    |

| Listening Mode  | Description   | Input Source   | Speaker Layout                   |
|---|---|--|----------------------------------|
| <b>DTS Neo:6</b><br><i>Neo:6 Cinema</i><br><i>Neo:6 Music</i><br><i>Neo:6</i> | <p>This mode expands any 2-channel source for up to 7.1-channel playback. It uses seven full-bandwidth channels of matrix decoding for matrix-encoded material, providing a very natural and seamless surround sound experience that fully envelops the listener.</p> <ul style="list-style-type: none"> <li>• <b>DTS Neo:6 Cinema</b><br/>Use this mode with any stereo movie (e.g., TV, DVD, VHS).</li> <li>• <b>DTS Neo:6 Music</b><br/>Use this mode with any stereo music source (e.g., CD, radio, cassette, TV, VHS, DVD).</li> </ul> <ul style="list-style-type: none"> <li>• <b>DTS Neo:6</b><br/>This mode uses DTS Neo:6 to expand 5.1-channel sources for 6.1/7.1-channel playback.</li> </ul> | <b>STEREO</b>  | <b>3.1</b> <b>5.1</b> <b>7.1</b> |
| <b>Audyssey DSX<sup>7</sup></b><br><i>Audyssey DSX</i>                        | <ul style="list-style-type: none"> <li>• <b>Audyssey DSX</b><br/>Audyssey DSX<sup>®</sup> is a scalable system that adds new speakers to improve surround impression. Starting with a 5.1 system Audyssey DSX adds only height channels in this deployment. The pair of Height channels reproduce important acoustical and perceptual cues, which greatly enhance the surround experience. In addition to these new Height channels, Audyssey DSX applies Surround Envelopment Processing to enhance the blend between the front and surround channels.</li> </ul>  | <b>5.1ch</b><br><b>7.1ch</b><br><b>DTS-ES</b><br><b>DJEX</b> | <b>7.1-FH</b>                    |
| <i>PLII Movie DSX</i><br><i>PLII Music DSX</i><br><i>PLII Game DSX</i>        | <ul style="list-style-type: none"> <li>• <b>Dolby Pro Logic II Movie + Audyssey DSX</b></li> <li>• <b>Dolby Pro Logic II Music + Audyssey DSX</b></li> <li>• <b>Dolby Pro Logic II Game + Audyssey DSX</b><br/>The combination of Dolby Pro Logic II and Audyssey DSX modes can be used. The <b>PLII</b> and <b>Audyssey DSX</b> indicators light on the AV receiver's display.</li> </ul>  | <b>STEREO</b>  | <b>7.1-FH</b>                    |

| Listening Mode    | Description  | Input Source   | Speaker Layout        |
|-------------------|--|--|-----------------------|
| <b>THX</b>        | Founded by George Lucas, THX develops stringent standards that ensure movies are reproduced in movie theaters and home theaters just as the director intended. THX Modes carefully optimize the tonal and spatial characteristics of the soundtrack for reproduction in the home-theater environment. They can be used with 2-channel matrixed and multichannel sources. Surround back speaker output depends on the source material and the selected listening mode.  |  |                       |
| <i>THX Cinema</i> | <ul style="list-style-type: none"> <li>• <b>THX Cinema</b><br/>THX Cinema mode corrects theatrical soundtracks for playback in a home theater environment. In this mode, THX Loudness Plus is configured for cinema levels and Re-EQ, Timbre Matching, and Adaptive Decorrelation are active.</li> <li>• <b>THX Music</b><br/>THX Music mode is tailored for listening to music, which is typically mastered at significantly higher levels than movies. In this mode, THX Loudness Plus is configured for music playback and only Timbre Matching is active.</li> <li>• <b>THX Games</b><br/>THX Games mode is meant for spatially accurate playback of game audio, which is often mixed similarly to movies but in a smaller environment. THX Loudness Plus is configured for game audio levels, with Timbre Matching active.</li> </ul> | <b>5.1ch</b><br><b>7.1ch</b><br><b>DTS-ES</b><br><b>DJEX</b> | <b>5.1</b> <b>7.1</b> |
| <i>THX Music</i>  |  |  |                       |
| <i>THX Games</i>  |  |  |                       |

| Listening Mode | Description  | Input Source  | Speaker Layout        |
|----------------|--|---|-----------------------|
|                | <ul style="list-style-type: none"> <li>• <b>Dolby Pro Logic II/IIx Movie + THX Cinema</b></li> <li>• <b>Dolby Pro Logic II/IIx Music + THX Music</b></li> <li>• <b>Dolby Pro Logic II/IIx Game + THX Games</b></li> </ul> <p>The combination of Dolby Pro Logic II/IIx*6 and THX Cinema/Music/Games modes can be used. The <b>PLII/PLIIx</b> and <b>THX</b> indicators light on the AV receiver's display.</p> | <b>STEREO</b>   | <b>5.1</b> <b>7.1</b> |
|                | <ul style="list-style-type: none"> <li>• <b>Dolby Pro Logic IIx Movie + THX Cinema</b></li> <li>• <b>Dolby Pro Logic IIx Music + THX Music</b></li> </ul> <p>The combination of Dolby Pro Logic IIx and THX Cinema/Music modes can be used. The <b>PLIIx</b> and <b>THX</b> indicators light on the AV receiver's display.</p>   | <b>5.1ch</b><br><b>DJEX</b>   | <b>7.1-SB</b>         |
|                | <ul style="list-style-type: none"> <li>• <b>Dolby Pro Logic IIz Height + THX Cinema</b></li> <li>• <b>Dolby Pro Logic IIz Height + THX Music</b></li> <li>• <b>Dolby Pro Logic IIz Height + THX Games</b></li> </ul> <p>The combination of Dolby Pro Logic IIz Height and THX Cinema/Music/Games modes can be used. The <b>PLIIz</b> and <b>THX</b> indicators light on the AV receiver's display.</p>         | <b>STEREO</b><br><b>5.1ch</b><br><b>7.1ch</b><br><b>DTS-ES</b><br><b>DJEX</b> | <b>7.1-FH</b>         |



| Listening Mode       | Description  | Input Source                    | Speaker Layout        |
|----------------------|--|---------------------------------|-----------------------|
|                      | <ul style="list-style-type: none"> <li>• <b>DTS Neo:6 Cinema + THX Cinema</b></li> <li>• <b>DTS Neo:6 Music + THX Music</b></li> </ul>   | <b>STEREO</b>                   | <b>5.1</b> <b>7.1</b> |
|                      | <ul style="list-style-type: none"> <li>• <b>DTS Neo:6 + THX Cinema</b></li> <li>• <b>DTS Neo:6 + THX Music</b></li> <li>• <b>DTS Neo:6 + THX Games</b></li> </ul> <p>The combination of DTS Neo:6 and THX Cinema/Music/Games modes can be used. The <b>Neo:6</b> and <b>THX</b> indicators light on the AV receiver's display.</p>   | <b>5.1ch</b><br><b>Dolby EX</b> | <b>7.1-SB</b>         |
| <i>THX S2 Cinema</i> | <ul style="list-style-type: none"> <li>• <b>THX Select2 Cinema</b></li> </ul> <p>This mode expands 5.1-channel sources for 7.1-channel playback. It does this by analyzing the composition of the surround source, optimizing the ambient and directional sounds to produce the surround back channel output.</p> <ul style="list-style-type: none"> <li>• <b>THX Select2 Music</b></li> </ul> <p>This mode is designed for use with music. It expands 5.1-channel sources for 7.1-channel playback.</p> <ul style="list-style-type: none"> <li>• <b>THX Select2 Games</b></li> </ul> <p>This mode is designed for use with video games. It can expand 5.1-channel sources for 6.1/7.1-channel playback.</p> | <b>5.1ch</b>                    | <b>7.1-SB</b>         |
| <i>THX S2 Music</i>  |  |                                 |                       |
| <i>THX S2 Games</i>  |  |                                 |                       |
| <i>THX Surr EX</i>   | <ul style="list-style-type: none"> <li>• <b>THX Surround EX</b></li> </ul> <p>This mode expands 5.1-channel sources for 6.1/7.1-channel playback. It's especially suited to Dolby Digital EX sources. THX Surround EX, also known as Dolby Digital Surround EX, is a joint development between Dolby Laboratories and THX Ltd.</p>   | <b>5.1ch</b><br><b>Dolby EX</b> | <b>7.1-SB</b>         |
|                      | <ul style="list-style-type: none"> <li>• <b>Dolby Pro Logic II Game + THX Select2 Games</b></li> </ul> <p>The combination of Dolby Pro Logic II Game and THX Select2 Games modes can be used. The <b>PLII</b> and <b>THX</b> indicators light on the AV receiver's display.</p>  | <b>STEREO</b>                   | <b>7.1-SB</b>         |

**Note**

- \*1 Based on the audio channel signal contained in the source, the corresponding speakers will output the sound.
  - \*2 The AV receiver can input the DSD signal from HDMI IN. Depending on the player, setting the output on the player side to PCM might bring better sound.
  - \*3 For the Blu-ray Discs, Dolby Digital is used in a 3.1/5.1-channel speaker system.
  - \*4 DTS is used depending on the configuration of the AV receiver.
  - \*5 If there are no surround back speakers, DTS is used.
  - \*6 If there are no surround back speakers, Dolby Pro Logic II is used.
  - \*7 This listening mode can be selected only when all the following conditions are satisfied:
    - Center speaker is connected.
    - Front high speakers is connected.
- The listening modes cannot be selected with some source formats.

**Dialogue Normalization**

Dialogue Normalization (DialogNorm) is a feature of Dolby Digital, which is used to keep the programs at the same average listening level so the user does not have to change the volume control between Dolby Digital, Dolby Digital Plus and Dolby TrueHD programs. When playing back software which has been encoded in Dolby Digital, Dolby Digital Plus and Dolby TrueHD, sometimes you may see a brief message in the front panel display which will read “**DialogNorm: X dB**” (X being a numeric value). The display is showing how the program level relates with THX calibration level. If you want to play the program at calibrated theatrical levels, you may wish to adjust the volume. For example, if you see the following message: “**DialogNorm: + 4 dB**” in the front panel display, to keep the overall output level at THX calibrated loudness, just turn down the volume control by 4 dB. However, unlike a movie theater where the playback loudness is preset, you can choose your preferred volume setting for best enjoyment.

## Using the Home Menu

The Home menu provides quick access to frequently used menus.

**The Home menu appears only on a TV that is connected to HDMI OUT MAIN. If your TV is connected to other video outputs, use the AV receiver's display when changing settings.**

### 1 Press Receiver followed by Home.

The Home menu will be superimposed on the TV screen.

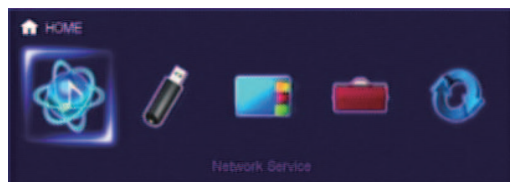

### 2 Use ◀/▶ or ▲/▼ and Enter to make the desired selection.

Press **Home** to close the menu.

## ■ Network Service

**You need to connect the AV receiver to your home network (→ page 95).**

▶ With this selection, you can use various Internet radio services or play the contents stored in media connected to your home network (DLNA) (→ pages 25 to 28). Note that this selection will be grayed out for a short while after the AV receiver is turned on. Please wait until it becomes operable.

Press **Enter** to display the network service screen. If you want to use the Internet radio services, use ▲/▼/◀/▶ to select the desired service. Pressing **Enter** again switches to that selection. If you want to play music files on a server, use ▲/▼/◀/▶ to select “DLNA” and then press **Enter**.

## ■ USB

▶ With this selection, you can play contents of portable players (iPod, etc.) and USB storage devices connected to the AV receiver's **USB** port (→ pages 24, 25). Note that this selection will be grayed out for a short while after the AV receiver is turned on. Please wait until it becomes operable.

First, press **USB** repeatedly to select the “**USB(Front)**” or “**USB(Rear)**” input.

Then, press **Enter** to select a drive or browse the contents of the media connected, followed by ▲/▼ to select the desired folder or track. Pressing **Enter** as a track is selected will start playback.

### Note

- Only the front-panel USB input is compatible with iPod/iPhone.

## ■ InstaPrevew

▶ With this selection, you can preview audio/video streams coming from HDMI inputs (**HDMI IN 1/2/3/4/AUX Input**). Even with multiple components connected through HDMI, you can easily switch between inputs as their previews are displayed on a single screen.

Press **Enter** to display the main preview (currently selected HDMI input) and the additional previews (other HDMI inputs). Using ▲/▼ or ◀/▶ to select a preview thumbnail and pressing **Enter** will switch the AV receiver to that input source.

### Tip

- If no video signals are present, the thumbnails will be filled in black.
- You can specify the number of preview thumbnails as well as their positioning on screen (→ page 65).

### Note

- This function cannot be selected when:
  - **HDMI IN 5/6/7** is the current HDMI input source, or
  - No signal is present on the current input source.
- Depending on video signals, the picture may not be properly rendered on the preview thumbnails of InstaPrevew.

## ■ Setup

▶ With this selection, you can access the common settings of the on-screen Setup menu.

Press **Enter** to display the Setup menu (→ page 48).

### Tip

- You can also access frequently used settings from Quick Setup (→ page 45).

## ■ Firmware Update

▶ With this selection, you can update the firmware of the AV receiver. Note that this selection will be grayed out for a short while after the AV receiver is turned on. Please wait until it becomes operable.

Press **Enter** to start the procedure (→ page 85).

## Using the Sleep Timer

With the sleep timer, you can set the AV receiver to turn off automatically after a specified period.

### 1 Press Receiver once followed by Sleep repeatedly to select the required sleep time.

The sleep time can be set from 90 to 10 minutes in 10 minute steps.

The **SLEEP** indicator lights on the AV receiver's display when the sleep timer has been set. The specified sleep time appears for about 5 seconds, then the previous display reappears.

#### Tip

- If you need to cancel the sleep timer, press **Sleep** repeatedly until the **SLEEP** indicator goes off.
- To check the time remaining until the AV receiver sleeps, press **Sleep**. Note that if you press again on **Sleep** as the time being displayed is 10 minutes or less, the sleep timer will go off.

## Setting the Display Brightness

You can adjust the brightness of the AV receiver's display.

### 1 Press Receiver once followed by Dimmer repeatedly to switch between: normal, dim, or dimmer brightness.

#### Tip

- (North American models) Alternatively, you can use **Dimmer** on the AV receiver.

## Displaying Source Information

You can display various information about the current input source as follows.

### 1 Press Receiver once followed by Display repeatedly to cycle through the available information.

#### Tip

- Alternatively, you can use **Display** on the AV receiver.

The following information can be typically displayed.

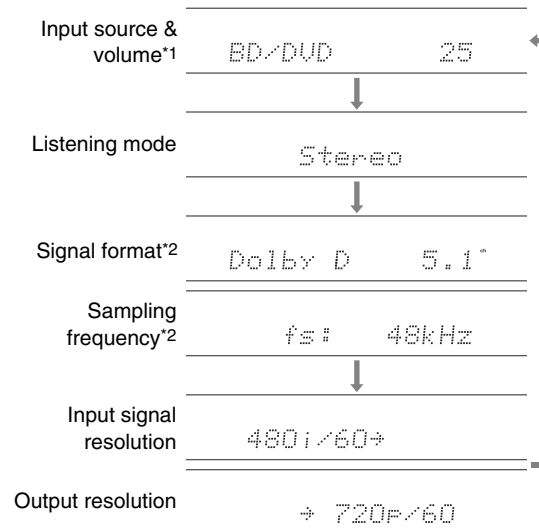

\*1 When AM or FM radio is used, the band, preset number, and frequency are displayed.

\*2 If the input signal is digital, the signal format is displayed. Information is displayed for about three seconds, then the previously displayed information reappears.

## Changing the Input Display

When you connect an **RI**-capable Integra/Onkyo component, you must configure the input display so that **RI** can work properly.

This setting can be done only from the front panel.

### 1 Press TV/CD or Game.

“TV/CD” or “GAME” appears on the AV receiver's display.

### 2 Press and hold down the same button (about 3 seconds) to change the input display.

Repeat this step to select the desired input display.

■ **TV/CD:** TV/CD → DOCK  
 ↑ TAPE ←

■ **Game:** GAME ↔ DOCK

#### Note

- “DOCK” can be selected for the “TV/CD” or “GAME” input selector, but not at the same time.
- Enter the appropriate remote control code before using the remote controller for the first time (→ page 76).

## Using the Whole House Mode

The Whole House Mode is useful when you want to add extra background music to your home party; this allows you to enjoy the same stereo music as the main room in separate rooms (Zone 2/3).

The Whole House Mode selects the same input source for Multi Zone as the main room's.

See also:

- “Speaker Setup” (→ **page 52**)
- “Multi Zone” (→ **page 68**)

### 1 Press Whole House Mode on the front panel.

To cancel the Whole House Mode, press **Off**, change the input source for the main room, or select a listening mode (→ **page 35**).

#### Note

- The Whole House Mode only supports analog audio.
- To adjust the volume of Multi Zone, switch the AV receiver to Multi Zone control. See “Adjusting the Volume for Zone 2/3” (→ **page 69**) for the volume adjustment of Multi Zone.
- The Whole House Mode is not available in either of the following cases:
  - The “**Audio TV Out**” setting is set to “**On**” (→ **page 65**).
  - “**HDMI Control(RIHD)**” is set to “**On**” (→ **page 64**) and you're listening through your TV speakers.

## Muting the AV Receiver

You can temporarily mute the output of the AV receiver.

### 1 Press Receiver followed by Muting.

The output is muted and the **MUTING** indicator flashes on the AV receiver's display.

#### Tip

- To unmute, press **Muting** again or adjust the volume.
- Muting is automatically cancelled when the AV receiver is set to standby.

## Using Headphones

### 1 Connect a pair of stereo headphones with a standard plug (1/4 inch or 6.3 mm) to the Phones jack.

While the headphones plug is inserted in the **Phones** jack,  indicator lights.

#### Note

- Always turn down the volume before connecting your headphones.
- While the headphones plug is inserted in the **Phones** jack, the speakers are turned off. (The Powered Zone 2 speakers are not turned off.)
- When you connect a pair of headphones, the listening mode is set to Stereo, unless it's already set to Stereo, Mono, Direct.
- If you connect an iPod or iPhone to the **USB** port on the AV receiver, no sound will be output from the headphones jack.

# On-screen Setup

With the AV receiver connected to a TV, there are two ways of changing the settings on-screen: using the Quick Setup or the Setup Menu (**Home**).

## ■ Quick Setup

The Quick Setup provides quick access to frequently used settings. You can change settings and view the current information.

## ■ Setup menu (Home)

The Setup menu (**Home**) provides a convenient way to change the AV receiver's various settings. Settings are organized into 9 categories.

The on-screen menus appear only on a TV that is connected to **HDMI OUT MAIN**. If your TV is connected to other video outputs, use the AV receiver's display when changing settings.

This section describes the procedure for using the remote controller unless otherwise specified.

## Using the Quick Setup



- 1 Press Receiver followed by Q Setup.**  
The Quick Setup will be superimposed on the TV screen.
- 2 Use ▲/▼ and Enter to make the desired selection.**  
Press **Q Setup** to close the menu.  
Press **Return** to return to the previous menu.

### Explanatory Notes

- ① — ■ **Music Optimizer**
- ② — Off  
    — **On**

- ① Setting target
- ② Setting options (default setting underlined)

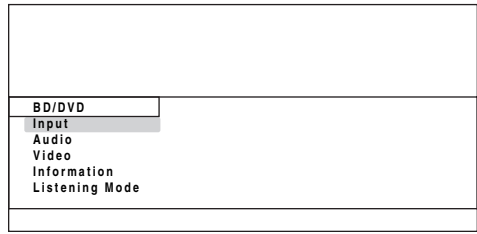

## ■ Input

- ▶ You can select input sources and view the following information: the name of input selectors, input assignments, radio information, and ARC function setting.  
In addition, previews of the video streams coming from HDMI inputs (**HDMI IN 1/2/3/4/AUX Input**) are displayed.<sup>1</sup>  
“**EXTRA1**” and “**EXTRA2**” can only be selected if they are assigned to HDMI, component, composite, coaxial, or optical inputs.  
Use ▲/▼ to select an input source and view the related information. Pressing **Enter** switches to the selected input source.

## ■ Audio (→ page 46)

- ▶ You can change the following settings: “**Bass**”, “**Treble**”, “**Subwoofer Level**”, “**Center Level**”, “**Audyssey**”, “**Dynamic EQ**”<sup>2</sup>, “**Dynamic Volume**”<sup>2</sup>, “**Late Night**”, “**Music Optimizer**”, “**Re-EQ**” and “**Re-EQ(THX)**”.

## ■ Video<sup>3</sup>

- ▶ You can change the following settings: “**Wide Mode**” and “**Picture Mode**”<sup>4</sup>.  
See also:
  - “**Picture Adjust**” (→ page 59)

## ■ Information<sup>5</sup>

- ▶ You can view the information of the following items: “**Audio**”, “**Video**” and “**Tuner**”.

## ■ Listening Mode<sup>6</sup>

- ▶ You can select the listening modes that are grouped in the following categories: “**MOVIE/TV**”, “**MUSIC**”, “**GAME**”, and “**THX**”.  
Use ▲/▼ to select the category and ◀/▶ to select the listening mode. Press **Enter** to switch to the selected listening mode.

↳ **To be continued**

**Note**

- \*1 • The video preview is not displayed when:
  - **HDMI IN 5/6/7** is the current HDMI input source, or
  - No signal is present on the current input source.
- The video of the currently-selected input is displayed on the main screen, not on a preview thumbnail.
- \*2 “**Dynamic EQ**” and “**Dynamic Volume**” cannot be selected when any of the THX listening modes is selected, with “**Loudness Plus**” set to “**On**” or “**Preserve THX Settings**” set to “**Yes**” (→ **page 55**).
- \*3 When the “**Monitor Out**” setting is set to “**Sub**”, “**Video**” cannot be selected (→ **page 50**).
- \*4 Only when you have selected “**Custom**” in the “**Picture Mode**” (→ **page 60**), pressing **Enter** allows you to adjust the following items via the Quick Setup: “**Brightness**”, “**Contrast**”, “**Hue**” and “**Saturation**”. Press **Return** to return to the “**Picture Mode**” setting.
- \*5 Depending on the input source and listening mode, not all channels shown here output the sound.
- \*6 • This setting is not available in either of the following cases:
  - The “**Audio TV Out**” setting is set to “**On**” (→ **page 65**).
  - “**HDMI Control(RIHD)**” is set to “**On**” (→ **page 64**) and you’re listening through your TV speakers.

## Using the Audio Settings of Quick Setup

You can change various audio settings from the Quick Setup (→ **page 45**).

**Note**

- These settings are not available in either of the following cases:
  - The “**Audio TV Out**” setting is set to “**On**” (→ **page 65**).
  - “**HDMI Control(RIHD)**” is set to “**On**” (→ **page 64**) and you’re listening through your TV speakers.

## Tone Control

### ■ Bass

▶ **-10dB** to **0dB** to **+10dB** in 2 dB steps

You can boost or cut low-frequency sounds output from the front speakers.

### ■ Treble

▶ **-10dB** to **0dB** to **+10dB** in 2 dB steps

You can boost or cut high-frequency sounds output from the front speakers.

You can adjust the bass and treble for the front speakers, except when the Direct or THX listening mode is selected.

## Operating on the AV receiver

- 1** Press **Tone** repeatedly to select either “**Bass**” or “**Treble**”.
- 2** Use **-** and **+** to adjust.

## Speaker Levels

### ■ Subwoofer Level

▶ **-15dB** to **0dB** to **+12dB** in 1 dB steps

### ■ Center Level

▶ **-12dB** to **0dB** to **+12dB** in 1 dB steps

You can adjust the volume of each speaker while listening to an input source.

These temporary adjustments are cancelled when the AV receiver is set to standby. To save the setting you made here, go to “**Level Calibration**” (→ **page 54**) before setting the AV receiver to standby.

**Note**

- You cannot use these function while the AV receiver is muted.
- These settings cannot be used while a pair of headphones is connected.
- Speakers that are set to “**No**” or “**None**” in “**Speaker Configuration**” (→ **page 52**) cannot be adjusted.

## Audyssey®

---

### ■ Audyssey

See “Audyssey” in “Source Setup” (→ [page 57](#)).

### ■ Dynamic EQ

See “Dynamic EQ” in “Source Setup” (→ [page 57](#)).

### ■ Dynamic Volume

See “Dynamic Volume” in “Source Setup” (→ [page 58](#)).

#### Note

- These technologies can be used when all the following conditions are met:
  - Room Correction and Speaker Setup is completed. Note that “Audyssey” requires the “Audyssey 2EQ Full Calibration” method.
  - Any listening mode other than Direct is selected.
  - A pair of headphones is not connected.
- The setting is stored individually for each input selector.
- “Dynamic EQ” and “Dynamic Volume” cannot be selected when any of the THX listening modes is selected, with “Loudness Plus” set to “On” or “Preserve THX Settings” set to “Yes” (→ [page 55](#)).

## Late Night

---

### ■ Late Night

For **Dolby Digital** and **Dolby Digital Plus** sources, the options are:

- ▶ **Off**
- ▶ **Low:**
  - Small reduction in dynamic range.
- ▶ **High:**
  - Large reduction in dynamic range.

For **Dolby TrueHD** sources, the options are:

- ▶ **Auto:**
  - The Late Night function is set to “On” or “Off” automatically.
- ▶ **Off**
- ▶ **On**

Turn this setting on to reduce the dynamic range of Dolby Digital material so that you can still hear quiet parts even when listening at low volume levels—ideal for watching movies late at night when you don’t want to disturb anyone.

#### Note

- The effect of the Late Night function depends on the material that you are playing and the intention of the original sound designer, and with some material there will be little or no effect when you select the different options.
- The Late Night function can be used only when the input source is Dolby Digital, Dolby Digital Plus, or Dolby TrueHD.
- The Late Night function is set to “Off” when the AV receiver is set to standby. For Dolby TrueHD sources, it will be set to “Auto”.
- With Dolby TrueHD sources, the Late Night function cannot be used when “TrueHD Loudness Management” is set to “Off”.

## Music Optimizer

---

### ■ Music Optimizer

- ▶ **Off**
- ▶ **On**

The Music Optimizer function enhances the sound quality of compressed music files. When set to “On”, the **M.Opt** indicator lights on the AV receiver’s display.

#### Note

- The Music Optimizer function only works with PCM digital audio input signals with a sampling rate below 48 kHz and analog audio input signals.
- The Music Optimizer is disabled when the Direct listening mode is selected.
- The setting is stored individually for each input selector.

## Re-EQ

---

With the Re-EQ function, you can compensate a soundtrack whose high-frequency content is too harsh, making it more suitable for home theater viewing.

### ■ Re-EQ

- ▶ **Off**
- ▶ **On**

This function can be used with the following listening modes: Dolby Digital, Dolby Digital Plus, Dolby TrueHD, Multichannel, DTS, DTS-HD High Resolution Audio, DTS-HD Master Audio, DTS Express, DSD, Dolby EX, Dolby Pro Logic IIz Height, Dolby PLIIx Movie, DTS Neo:6 Cinema and 5.1-channel source + Neo:6.

### ■ Re-EQ(THX)

- ▶ **Off**
- ▶ **On**

This function can be used with the following listening modes: THX Cinema, THX Surround EX, and THX Select2 Cinema.

#### Note

- These settings are stored individually for each input selector. In THX listening mode however, the setting will return to “On” when the AV receiver is turned off.
- These settings cannot be used while a pair of headphones is connected.

## Using the Setup Menu (Home)



### ■ Screen Saver

If there is no video signal on the current input source and no operation for a specific time (three minutes by default), a screen saver automatically comes on.

#### Tip

- The time until the screen saver activates itself can be changed in the “Screen Saver” setting (→ [page 63](#)).
- The screen will return to its previous state if the AV receiver is operated.

- 1 Press **Receiver** followed by **Home**.
- 2 Use **◀/▶** to select “Setup”, and then press **Enter**.
- 3 Use **▲/▼** to select a main menu item, and then press **Enter**.
- 4 Use **▲/▼** to select a sub menu item, and then press **Enter**.
- 5 Use **▲/▼** to select a setting target, and use **◀/▶** to change the setting.  
Press **Home** to close the menu.  
Press **Return** to return to the previous menu.

#### Note

- This procedure can also be performed on the AV receiver by using **Setup**, the cursor buttons, and **Enter**.
- During Audyssey 2EQ® Room Correction and Speaker Setup, messages, etc., that are displayed on the TV screen will appear on the AV receiver’s display.

## Explanatory Notes

- ① **Main Menu** **Speaker Setup**
  - ② **Speaker Configuration**
  - ③ **Subwoofer**
  - ④ **Yes**  
**No**
- ① Main Menu  
② Sub Menu  
③ Setting target  
④ Setting options (default setting underlined)

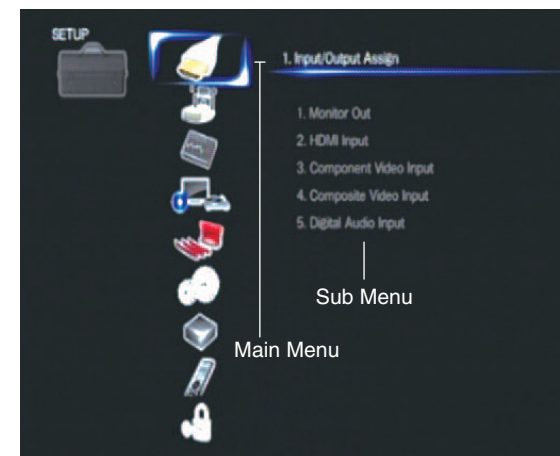



### About the Hybrid Standby indicator

By way of optimized circuitry, this function reduces power consumption when the AV receiver is in standby mode. The **Hybrid Standby** indicator will light in either of the following conditions:

- “**HDMI Through**” is enabled (the **HDMI** indicator is off).
- “**Network Standby**” is enabled (the **NET** indicator is off).

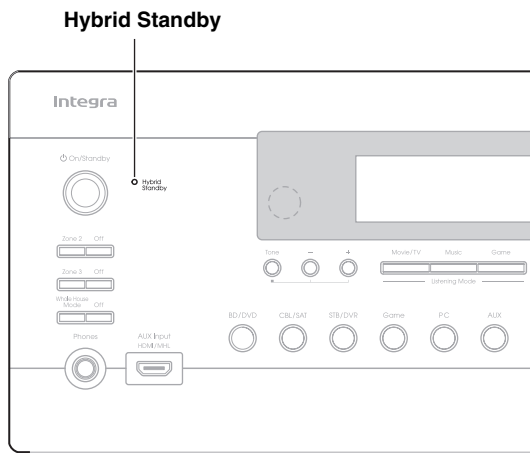

**Note**

- If Zones are turned on or, if a mobile device connected to the Front Input (MHL) is charging, the **Hybrid Standby** indicator won't light.

### Setup menu items

| Main menu item                            | Sub menu item         |
|---|-----------------------|
| <b>Input/Output Assign</b><br>(→ page 50) | Monitor Out           |
|   | HDMI Input            |
|   | Component Video Input |
|   | Composite Video Input |
|   | Digital Audio Input   |
| <b>Speaker Setup</b><br>(→ page 52)       | Speaker Settings      |
|   | Speaker Configuration |
|   | Speaker Distance      |
|   | Level Calibration     |
|   | Equalizer Settings    |
|   | THX Audio Setup       |
|   | Multiplex/Mono        |
|   | Dolby                 |
| <b>Audio Adjust</b><br>(→ page 55)        | DTS                   |
|   | Audyssey DSX          |
|   | Theater-Dimensional   |
|   | LFE Level             |
|   | Audyssey              |
|   | IntelliVolume         |
|   | A/V Sync              |
| <b>Source Setup</b><br>(→ page 57)        | Name Edit             |
|   | Picture Adjust        |
|   | Audio Selector        |

| Main menu item                                | Sub menu item       |
|---|---------------------|
| <b>Listening Mode Preset</b><br>(→ page 61)   | BD/DVD              |
|   | CBL/SAT             |
|   | STB/DVR             |
|   | GAME                |
|   | PC                  |
|   | AUX                 |
|   | TUNER               |
|   | TV/CD               |
|   | NET                 |
|   | USB                 |
| <b>Miscellaneous</b><br>(→ page 62)           | EXTRA1              |
|   | EXTRA2              |
|   | Volume Setup        |
|   | OSD Setup           |
|   | 12V Trigger A Setup |
| <b>Hardware Setup</b><br>(→ page 64)          | 12V Trigger B Setup |
|   | 12V Trigger C Setup |
|   | Multi Zone          |
|   | Tuner               |
| <b>Remote Controller Setup</b><br>(→ page 67) | HDMI                |
|   | Auto Standby        |
|   | Network             |
|   | Initial Setup       |
| <b>Lock Setup</b><br>(→ page 67)              | Remote ID           |
|   | Remote Mode Setup   |
|   | Setup               |

## Input/Output Assign



Main Menu

Input/Output Assign

### Monitor Out

On the “**Monitor Out**” settings, you can select whether or not to have the video sources’ images output through the HDMI output.

If you connect your TV to HDMI output, “**Monitor Out**” setting is automatically set and composite video and component video sources are upconverted\* and output.

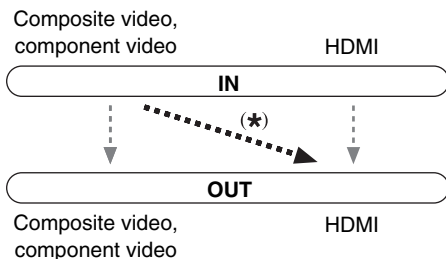

#### Note

- See “Video Connection Formats” (→ page 89) for charts showing how the “**Monitor Out**” and “**Resolution**” settings affect the video signal flow through the AV receiver.

### Monitor Out

#### ▶ Main:

Select this if your TV is connected to **HDMI OUT MAIN**.

#### ▶ Sub:

Select this if your TV is connected to **HDMI OUT SUB**.

#### ▶ Both:

Select this if your TVs are connected to **HDMI OUT MAIN** and **HDMI OUT SUB**. Video signals are

output from both HDMI outputs at the resolution supported by both TVs.

### Resolution

#### ▶ Through:

Select this to pass video through the AV receiver at the same resolution and with no conversion.

#### ▶ Auto:

Select this to have the AV receiver automatically convert video at resolutions supported by your TV.

#### ▶ 480p (480p/576p), 720p, 1080i, 1080p:

Select the desired output resolution.

#### ▶ 1080p/24:

Select this for 1080p output at 24 frames per second.

#### ▶ 4K Upscaling:

Select this for an output resolution four times that of 1080p. Depending on the resolution supported by your TV, it will result in either 3840 × 2160 or 4096 × 2160 pixels.

You can specify the output resolution for **HDMI OUT MAIN** and have the AV receiver upconvert the picture resolution as necessary to match the resolution supported by your TV.

#### Tip

- You can see the picture by pressing **Enter** to check the “**Resolution**” setting (excluding **NET** input source).

#### Note

- Depending on the incoming video signal, the video playback may not be smooth or the vertical resolution may be lowered. In this case select anything other than “**1080p/24**”.
- With some TVs, there may be no picture when this setting is set to “**4K Upscaling**”.
- If the “**Monitor Out**” setting is set to “**Sub**”, this setting is fixed to “**Through**”.
- If the “**Monitor Out**” setting is set to “**Both**”, this setting is fixed to “**Auto**”.

## HDMI Input

If you connect a video component to an HDMI input, you must assign that input to an input selector. For example, if you connect your Blu-ray Disc/DVD player to **HDMI IN 2**, you must assign “**HDMI2**” to the “**BD/DVD**” input selector.

If you’ve connected your TV to the AV receiver with an HDMI cable, composite video and component video sources can be upconverted\* and output by the HDMI output. You can set this for each input selector by selecting the “- - - -” option, but the video signal coming from the HDMI output depends on the assignments of “**Component Video Input**” and “**Composite Video Input**”. See “Video Connection Formats” for more information on video signal flow and upconversion (→ page 89).

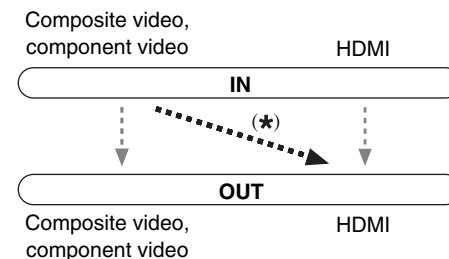

Here are the default assignments.

| Input selector | Default assignment   |
|----------------|----------------------|
| <b>BD/DVD</b>  | <b>HDMI1</b>         |
| <b>CBL/SAT</b> | <b>HDMI2</b>         |
| <b>STB/DVR</b> | <b>HDMI3</b>         |
| <b>GAME</b>    | <b>HDMI4</b>         |
| <b>PC</b>      | <b>HDMI5</b>         |
| <b>AUX</b>     | <b>FRONT (Fixed)</b> |
| <b>TV/CD</b>   | - - - -              |
| <b>EXTRA1</b>  | - - - -              |
| <b>EXTRA2</b>  | - - - -              |

↳ To be continued

## ■ BD/DVD, CBL/SAT, STB/DVR, GAME, PC, TV/CD, EXTRA1, EXTRA2

### ▶ HDMI1, HDMI2, HDMI3, HDMI4, HDMI5, HDMI6, HDMI7:

Select the input to which the component has been connected.

### ▶ - - - - -:

Output composite video and component video sources from the HDMI output. The video signal coming from the HDMI output depends on the assignments of “**Component Video Input**” and “**Composite Video Input**”.

Each HDMI input cannot be assigned to two input selectors or more. When **HDMI1 - HDMI7** have already been assigned, you must first set any unused input selectors to “- - - - -” or you will be unable to assign **HDMI1 - HDMI7** to other input selectors.

### Tip

- “**EXTRA1**” and “**EXTRA2**” can be selected as input sources in “**Input**” of “**Quick Setup**” (→ [page 45](#)).

### Note

- If no video component is connected to HDMI output (even if the HDMI input is assigned), the AV receiver selects the video source based on the setting of “**Component Video Input**” and “**Composite Video Input**”.
- When an **HDMI IN** is assigned to an input selector as explained here, the same **HDMI IN** will be set as a priority in the “**Digital Audio Input**”. In this case, if you want to use the coaxial or optical audio input, make the appropriate selection in the “**Audio Selector**” setting (→ [page 61](#)).
- Do not assign an **HDMI IN** to the **TV/CD** selector while “**HDMI Control(RIHD)**” is set to “**On**” (→ [page 64](#)), otherwise appropriate CEC (Consumer Electronics Control) operation will not be guaranteed.
- If you assign “- - - - -” to an input selector that is currently selected in “**HDMI Through**” (→ [page 64](#)), the “**HDMI Through**” setting will be automatically switched to “**Off**”.
- “**AUX**” is used only for input from the front panel.

## Component Video Input

If you connect a video component to a component video input, you must assign that input to an input selector. For example, if you connect your Blu-ray Disc/DVD player to **COMPONENT VIDEO IN 2**, you must assign “**IN2**” to the “**BD/DVD**” input selector.

Here are the default assignments.

| Input selector | Default assignment |
|----------------|--------------------|
| BD/DVD         | IN1                |
| CBL/SAT        | IN2                |
| STB/DVR        | - - - - -          |
| GAME           | - - - - -          |
| PC             | - - - - -          |
| AUX            | - - - - -          |
| TV/CD          | - - - - -          |
| EXTRA1         | - - - - -          |
| EXTRA2         | - - - - -          |

## ■ BD/DVD, CBL/SAT, STB/DVR, GAME, PC, AUX, TV/CD, EXTRA1, EXTRA2

### ▶ IN1, IN2:

Select the input to which the component has been connected.

### ▶ - - - - -:

Output composite video sources from the HDMI output. The upconverted output from HDMI depends on the assignment of “**Composite Video Input**”.

### Tip

- “**EXTRA1**” and “**EXTRA2**” can be selected as input sources in “**Input**” of “**Quick Setup**” (→ [page 45](#)).

### Note

- When composite video and component video sources are upconverted for **HDMI OUT SUB**, only signals with a resolution of 480i/576i are output and the resolution remains the same. If your TV doesn't support this resolution, there will be no picture (→ [page 91](#)).

## Composite Video Input

If you connect a component to a composite video input, you must assign that input to an input selector.

If you switch the input to “**TV/CD**” with its default assignment, the audio of “**TV/CD**” is output while the video of the previously-selected source is displayed.

Here are the default assignments.

| Input selector | Default assignment |
|----------------|--------------------|
| BD/DVD         | IN1                |
| CBL/SAT        | IN2                |
| STB/DVR        | IN3                |
| GAME           | IN4                |
| PC             | - - - - -          |
| AUX            | FRONT (Fixed)      |
| TV/CD          | - - - - -          |
| EXTRA1         | - - - - -          |
| EXTRA2         | - - - - -          |

## ■ BD/DVD, CBL/SAT, STB/DVR, GAME, PC, TV/CD, EXTRA1, EXTRA2

### ▶ IN1, IN2, IN3, IN4:

Select the input to which the component has been connected.

### ▶ - - - - -:

The composite video is not input.

### Tip

- “**EXTRA1**” and “**EXTRA2**” can be selected as input sources in “**Input**” of “**Quick Setup**” (→ [page 45](#)).

### Note

- “**AUX**” is used only for input from the front panel.
- Using these inputs as audio-exclusive allows you to enjoy audio and video from separate inputs. Refer to “Playing Audio and Video from Separate Sources” for details (→ [page 31](#)).

## Digital Audio Input

If you connect a component to a digital audio input, you must assign that input to an input selector. For example, if you connect your CD player to the **OPTICAL IN 1**, you must assign “**OPTICAL1**” to the “**TV/CD**” input selector. Here are the default assignments.

| Input selector | Default assignment |
|----------------|--------------------|
| BD/DVD         | COAXIAL1           |
| CBL/SAT        | COAXIAL2           |
| STB/DVR        | -----              |
| GAME           | OPTICAL1           |
| PC             | -----              |
| AUX            | -----              |
| TV/CD          | OPTICAL2           |
| EXTRA1         | -----              |
| EXTRA2         | -----              |

### ■ BD/DVD, CBL/SAT, STB/DVR, GAME, PC, AUX, TV/CD, EXTRA1, EXTRA2

#### ▶ COAXIAL1, COAXIAL2, OPTICAL1, OPTICAL2:

Select the input to which the component has been connected.

#### ▶ -----:

Select if the component is connected to an analog audio input.

### Tip

- “**EXTRA1**” and “**EXTRA2**” can be selected as input sources in “**Input**” of “**Quick Setup**” (→ page 45).

### Note

- When an **HDMI IN** is assigned to an input selector in “**HDMI Input**” (→ page 50), the same **HDMI IN** will be set as a priority in this assignment. In this case, if you want to use the coaxial or optical audio input, make the appropriate selection in the “**Audio Selector**” (→ page 61).
- Supported sampling rates for PCM signals (stereo/mono) from a digital input (optical and coaxial) are 32/44.1/48/88.2/96 kHz/16, 20, 24 bit.

## Speaker Setup



### Main Menu Speaker Setup

Some of the settings in this section are set automatically by Audyssey 2EQ® Room Correction and Speaker Setup (→ page 32).

Here you can check the settings made by Audyssey 2EQ Room Correction and Speaker Setup function, or set them manually, which is useful if you change one of the connected speakers after using Audyssey 2EQ Room Correction and Speaker Setup function.

## Speaker Settings

**If you change these settings, you must run Audyssey 2EQ Room Correction and Speaker Setup again (→ page 32).**

If you bi-amp the front speakers, you must change the “**Speakers Type (Front)**” setting. For details on speaker wire connection, see “**Bi-amping the Front Speakers**” (→ page 13).

### Note

- When bi-amping is used, the AV receiver is able to drive up to 5.1 speakers in the main room.
- Before you change these settings, turn down the volume.

### ■ Speaker Impedance (Australian models)

#### ▶ 4ohms:

Select if the impedance of any speaker is 4 ohms or more but less than 6.

#### ▶ 6ohms:

Select if the impedances of all speakers are between 6 and 16 ohms.

### Note

- (North American models) Speakers with an impedance of less than 6 ohms are not supported.

### ■ Speakers Type (Front)

#### ▶ Normal:

Select this if you’ve connected your front speakers normally.

#### ▶ Bi-Amp:

Select this if you’ve bi-amped your front speakers.

### ■ Powered Zone 2

#### ▶ No

#### ▶ Yes:

Zone 2 speakers can be used. (Powered Zone 2 enabled).

### Note

- If the “**Speakers Type (Front)**” setting is set to “**Bi-Amp**”, Powered Zone 2 cannot be used.
- When the “**Powered Zone 2**” setting is set to “**Yes**” and Zone 2 is turned on, the surround back and front high speakers cannot be used.

## Speaker Configuration

This setting is set automatically by Audyssey 2EQ Room Correction and Speaker Setup (→ page 32).

With these settings, you can specify which speakers are connected and a crossover frequency for each speaker. Specify “**Full Band**” for speakers that can output low frequency bass sounds adequately, for example, speakers with a good sized woofer. For smaller speakers, specify a crossover frequency. Sounds below the crossover frequency will be output by the subwoofer instead of the speaker. Refer to your speaker’s manuals to determine the optimum crossover frequencies. If you set up your speakers using Audyssey 2EQ Room Correction and Speaker Setup, please make sure manually that any THX speakers are set to “**80Hz(THX)**” crossover.

## ■ Subwoofer

- ▶ Yes
- ▶ No

## ■ Front

### ▶ Full Band

- ▶ 40Hz, 45Hz, 50Hz, 55Hz, 60Hz, 70Hz, 80Hz(THX), 90Hz, 100Hz, 110Hz, 120Hz, 130Hz, 150Hz, 200Hz

### Note

- If the “Subwoofer” setting is set to “No”, the “Front” setting is fixed at “Full Band”.

## ■ Center\*1, Surround\*1

### ▶ Full Band

- ▶ 40Hz, 45Hz, 50Hz, 55Hz, 60Hz, 70Hz, 80Hz(THX), 90Hz, 100Hz, 110Hz, 120Hz, 130Hz, 150Hz, 200Hz

### ▶ None

## ■ Front High\*1\*2\*3\*4

### ▶ Full Band

- ▶ 40Hz, 45Hz, 50Hz, 55Hz, 60Hz, 70Hz, 80Hz(THX), 90Hz, 100Hz, 110Hz, 120Hz, 130Hz, 150Hz, 200Hz

### ▶ None

## ■ Surround Back\*1\*2\*3\*5

### ▶ Full Band

- ▶ 40Hz, 45Hz, 50Hz, 55Hz, 60Hz, 70Hz, 80Hz(THX), 90Hz, 100Hz, 110Hz, 120Hz, 130Hz, 150Hz, 200Hz

### ▶ None

### Note

- \*1 “Full Band” can be selected only when “Full Band” is selected in the “Front” setting.
- \*2 If the “Surround” setting is set to “None”, this setting cannot be selected.
- \*3 If the “Speakers Type (Front)” setting is set to “Bi-Amp”, or the “Powered Zone 2” setting is set to “Yes” together with Zone 2 turned on, this setting cannot be selected.
- \*4 If anything else than “None” is selected in “Surround Back”, this setting is automatically set to “None”.
- \*5 If anything else than “None” is selected in “Front High”, this setting is automatically set to “None”.

## ■ Surround Back Ch

### ▶ 1ch:

Select if only one surround back speaker L is connected.

### ▶ 2ch:

Select if two (left and right) surround back speakers are connected.

### Note

- If the “Surround Back” setting is set to “None”, this setting cannot be selected.
- If the “Powered Zone 2” setting is set to “Yes” and Zone 2 is turned on, this setting cannot be selected.

## ■ LPF of LFE

### (Low-Pass Filter for the LFE Channel)

#### ▶ 80Hz, 90Hz, 100Hz, 110Hz, 120Hz

#### ▶ Off:

Low-Pass Filter is not applied.

With this setting, you can specify the cutoff frequency of the LFE channel’s low-pass filter (LPF), which can be used to filter out unwanted hum. The LPF only applies to sources that use the LFE channel.

### Note

- If you’re using THX-certified speakers, select “80Hz”.

## ■ Double Bass

This setting is **NOT** set automatically by Audyssey 2EQ® Room Correction and Speaker Setup (→ [page 32](#)).

#### ▶ On

#### ▶ Off(THX)

Turn this setting on to boost bass output by feeding bass sounds from the front left, right, and center channels to the subwoofer.

### Note

- When the “Subwoofer” setting is set to “No” or the “Front” setting to anything other than “Full Band”, this setting is fixed to “- - -”.
- This setting is set to “On” automatically when the “Subwoofer” and “Front” settings are set for the first time to “Yes” and “Full Band” respectively.
- If you’re using THX-certified speakers, select “Off(THX)”.

## Speaker Distance

This setting is set automatically by Audyssey 2EQ Room Correction and Speaker Setup (→ [page 32](#)).

Here you can specify the distance from each speaker to the listening position so that the sound from each speaker arrives at the listener’s ears as the sound designer intended.

## ■ Unit

### ▶ feet:

Distances can be set in feet. Range: **0.2ft** to **30.0ft** in 0.2 foot steps.

### ▶ meters:

Distances can be set in meters. Range: **0.06m** to **9.00m** in 0.06 meter steps.

(The default setting varies from country to country.)

## ■ Left, Front High Left, Center, Front High Right, Right, Surround Right, Surround Back Right, Surround Back Left, Surround Left, Subwoofer

▶ Specify the distance from each speaker to your listening position.

### Note

- Speakers that you set to “No” or “None” in “Speaker Configuration” cannot be selected (→ [page 52](#)).
- When the “Powered Zone 2” setting is set to “Yes” and Zone 2 is turned on, the surround back and front high speakers cannot be used.

## Level Calibration

This setting is set automatically by Audyssey 2EQ® Room Correction and Speaker Setup (→ [page 32](#)).

Here you can adjust the level of each speaker with the built-in test tone so that the volume of each speaker is the same at the listening position.

### Note

- These settings cannot be calibrated in either of the following cases:
  - The “Audio TV Out” setting is set to “On” (→ [page 65](#)).
  - “HDMI Control(RIHD)” is set to “On” (→ [page 64](#)) and you’re listening through your TV speakers.
  - The AV receiver is muted.

### ■ Left, Front High Left, Center<sup>1</sup>, Front High Right, Right, Surround Right, Surround Back Right, Surround Back Left, Surround Left

▶ **-12dB** to **0dB** to **+12dB** in 1 dB steps.

### ■ Subwoofer<sup>1</sup>

▶ **-15dB** to **0dB** to **+12dB** in 1 dB steps.

### Note

- Speakers that you set to “No” or “None” in “Speaker Configuration” cannot be selected (→ [page 52](#)).
- When the “Powered Zone 2” setting is set to “Yes” and Zone 2 is turned on, the surround back and front high speakers cannot be used.
- The test tone is output at the standard level for THX, which is 0 dB (absolute volume setting 82). If you normally listen at volume settings below this, be careful because the test tone will be much louder.

<sup>1</sup> For the center speaker and subwoofer, the level settings made by using the Quick Setup are saved in this menu (→ [page 46](#)).

### Tip

- If you’re using a handheld sound level meter, adjust the level of each speaker so that it reads 75 dB SPL at the listening position, measured with C-weighting and slow reading.

## Equalizer Settings

With the Equalizer settings, you can adjust the tone of speakers individually with a 5-band equalizer. The volume of each speaker can be set.

### ■ Manual Equalizer

#### ▶ On:

You can adjust the equalizer for each speaker manually. Continue with the following procedure:

**1** Press **▼** to select “Channel”, and then use **◀/▶** to select a speaker.

**2** Use **▲/▼** to select a frequency, and then use the **◀/▶** to adjust the level at that frequency.

The volume at each frequency can be adjusted from **-6dB** to **0dB** to **+6dB** in 1 dB steps.

#### Tip

- You can select: “63Hz”, “250Hz”, “1000Hz”, “4000Hz”, or “16000Hz”. And for the subwoofer, “25Hz”, “40Hz”, “63Hz”, “100Hz”, or “160Hz”.
- Low frequencies (e.g., 63Hz) affect bass sounds; high frequencies (e.g., 16000Hz) affect treble sounds.

**3** Use **▲** to select “Channel”, and then use **◀/▶** to select another speaker.

Repeat steps 1 and 2 for each speaker.

You cannot select speakers that you set to “No” or “None” in the “Speaker Configuration” (→ [page 52](#)).

#### ▶ Off:

Tone off, response flat.

### Note

- When the Direct listening mode is selected, the equalizer settings have no effect.
- If “Audyssey” is enabled, it prevails over this setting (→ [page 57](#)).

## THX Audio Setup

### ■ Surr Back Speaker Spacing

- ▶ **<1ft (<0.3m)**
- ▶ **1ft-4ft (0.3m-1.2m)**
- ▶ **>4ft (>1.2m)**

You can specify the distance between your surround back speakers.

### Note

- Cannot be set if:
  - “Surround Back” is set to “None” (→ [page 53](#)).
  - “Surround Back Ch” is set to “1ch” (→ [page 53](#)).
  - “Powered Zone 2” is set to “Yes” (→ [page 52](#)) and Zone 2 turned on (→ [page 69](#)).

### ■ THX Ultra2/Select2 Subwoofer

- ▶ **No**
- ▶ **Yes**

If you’re using a THX-certified subwoofer, set this setting to “Yes”.

### Note

- If the “Subwoofer” setting is set to “No”, this setting cannot be selected (→ [page 53](#)).

### ■ BGC

- ▶ **Off**
- ▶ **On**

You can apply THX’s Boundary Gain Compensation (BGC) to compensate the perceived exaggeration of low frequencies for listeners sitting very close to a room boundary (i.e., wall).

### Note

- This setting is only available if “THX Ultra2/Select2 Subwoofer” is set to “Yes”.
- If the “Subwoofer” setting is set to “No”, this setting cannot be selected (→ [page 53](#)).

## ■ Loudness Plus

### ▶ Off

### ▶ On

When the “**Loudness Plus**” setting is set to “**On**”, it is possible to enjoy even subtle nuances of audio expression at low volume. This is only available when the THX listening mode is selected.

## ■ Preserve THX Settings

### ▶ Yes

### ▶ No

If this setting is set to “**Yes**”, Dynamic EQ and Dynamic Volume have no effect in THX listening mode.

### Note

- This setting is fixed at “**Yes**” if “**Loudness Plus**” is set to “**On**”.

## ■ Metadata Compatible

### ▶ On:

When Metadata Compatible is set to “**On**”, valid metadata is transmitted via the HDMI connections, and can be used by other devices in the system.

### ▶ Off:

When Metadata Compatible is set to “**Off**”, metadata is not transmitted via the HDMI connections.

The HDMI connection in your system is used to deliver uncompressed digital audio and video information from one device to the next. There is also additional information about this digital content that can be delivered. Such additional information is referred to as “metadata”.

Metadata Compatible mode should be used when there are home theater components in your system, such as Blu-ray disc players, set top boxes and displays that use this additional metadata. For example, Metadata Compatible mode should be set to ON when there are THX Media Director™ Enabled devices in the system. This ensures that this additional information can be received by your Integra AVR and can be sent to other devices that are connected in your home theater system, with no interruption.

## THX Loudness Plus

THX Loudness Plus is a new volume control technology featured in THX Ultra2 Plus™ and THX Select2 Plus™ Certified receivers. With THX Loudness Plus, home theater audiences can now experience the rich details in a surround mix at any volume level. A consequence of turning the volume below Reference Level is that certain sound elements can be lost or perceived differently by the listener. THX Loudness Plus compensates for the tonal and spatial shifts that occur when the volume is reduced by intelligently adjusting ambient surround channel levels and frequency response. This enables users experience the true impact of soundtracks regardless of the volume setting. THX Loudness Plus is automatically applied when listening in any THX listening mode. The new THX Cinema, THX Music, and THX Games modes are tailored to apply the proper THX Loudness Plus settings for each type of content.

## Audio Adjust



### Main Menu

### Audio Adjust

With the Audio Adjust functions and settings, you can adjust the sound and listening modes as you like.

## Multiplex/Mono

### ■ Multiplex

#### Input Channel

##### ▶ Main

##### ▶ Sub

##### ▶ Main/Sub

This setting determines which channel of a stereo multiplex source is output. Use it to select audio channels

or languages with multiplex sources, multilingual TV broadcasts, and so on.

### ■ Mono

#### Input Channel

##### ▶ Left + Right

##### ▶ Left

##### ▶ Right

This setting specifies the channel to be used for playing any 2-channel digital source such as Dolby Digital, or 2-channel analog/PCM source in the Mono listening mode.

#### Output Speaker

##### ▶ Center:

Mono audio is output by the center speaker.

##### ▶ Left / Right:

Mono audio is output by the front left and right speakers.

This setting determines which speakers output mono audio when the Mono listening mode is selected.

### Note

- If the “**Center**” setting is set to “**None**” (→ [page 53](#)), this setting cannot be selected.

## Dolby

---

### ■ PL IIX Music (2ch Input)

These settings apply to only 2-channel stereo sources.

If you're not using any surround back speakers, these settings apply to Dolby Pro Logic II, not Dolby Pro Logic IIX.

#### Panorama

- ▶ **On**
- ▶ **Off**

With this setting, you can broaden the width of the front stereo image when using the Dolby Pro Logic IIX Music listening mode.

#### Dimension

- ▶ **-3** to **0** to **+3**

With this setting, you can move the sound field forward or backward when using the Dolby Pro Logic IIX Music listening mode. Higher settings move the sound field backward. Lower settings move it forward.

If the stereo image feels too wide, or there's too much surround sound, move the sound field forward to improve the balance. Conversely, if the stereo image feels like it's in mono, or there's not enough surround sound, move it backward.

#### Center Width

- ▶ **0** to **3** to **7**

With this setting, you can adjust the width of the sound from the center speaker when using the Dolby Pro Logic IIX Music listening mode. Normally, if you're using a center speaker, the center channel sound is output from only the center speaker. (If you're not using a center speaker, the center channel sound will be distributed to the front left and right speakers to create a phantom center). This setting controls the front left, right, and center mix, allowing you to adjust the weight of the center channel sound.

### ■ PL IIZ Height Gain

- ▶ **Low**
- ▶ **Mid**
- ▶ **High**

The Height Gain Control in Dolby Pro Logic IIZ enables the listener to select how much gain is applied to the front high speakers. There are three settings, "**Low**", "**Mid**" and "**High**", and the front high speakers are accentuated in that order. While "**Mid**" is the default listening setting, the listener may adjust the Height Gain Control to their personal preference.

#### Note

- If the "**Front High**" setting is set to "**None**" (→ **page 53**), this setting cannot be selected.
- If the "**Powered Zone 2**" setting is set to "**Yes**" and Zone 2 is turned on, this setting cannot be selected.

### ■ Dolby EX

#### ▶ **Auto:**

If the source signal contains a Dolby EX flag, the Dolby EX or THX Surround EX listening mode is used.

#### ▶ **Manual:**

You can select any available listening mode.

This setting determines how Dolby EX encoded signals are handled. This setting is unavailable if no surround back speakers are connected. This setting is effective with Dolby Digital, Dolby Digital Plus and Dolby TrueHD only.

#### Note

- If the "**Surround Back**" setting is set to "**None**" (→ **page 53**), this setting cannot be selected.
- If the "**Powered Zone 2**" setting is set to "**Yes**" and Zone 2 is turned on, this setting cannot be selected.

### ■ TrueHD Loudness Management

- ▶ **Off**
- ▶ **On**

This setting specifies whether or not to apply the Late Night processing on a Dolby TrueHD source.

#### Note

- When this setting is set to "**Off**", the Late Night function for Dolby TrueHD sources is automatically fixed to "**Off**".
- When this setting is set to "**Off**", the Dialogue Normalization information is not available for Dolby TrueHD sources.

## DTS

---

### ■ Neo:6 Music

#### Center Image

- ▶ **0** to **2** to **5**

The DTS Neo:6 Music listening mode creates 6-channel surround sound from 2-channel stereo sources. With this setting, you can specify by how much the front left and right channel output is attenuated in order to create the center channel.

Changing the value from "0" to "5" will spread the sound of the center channel to left and right (outwards).

### Audyssey DSX®

---

### ■ Soundstage

- ▶ **-3dB** to **Reference** to **+3dB**

With this setting, you can adjust the sound stage when using Audyssey DSX.

#### Note

- This listening mode can be selected only when all the following conditions are satisfied:
  - The center speaker is connected.
  - The front high speakers are connected.
  - Powered Zone 2 is not in use.



## Theater-Dimensional

### ■ Listening Angle

#### ▶ **Wide:**

Select if the listening angle is greater than 30 degrees.

#### ▶ **Narrow:**

Select if the listening angle is less than 30 degrees.

With this setting, you can optimize the Theater-Dimensional listening mode by specifying the angle of the front left and right speakers relative to the listening position. Ideally, the front left and right speakers should be equidistant from the listening position and at an angle close to one of the two available settings.

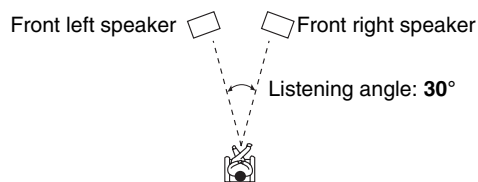

#### Note

- For best results, we recommend setting “**Narrow**” to 20° and “**Wide**” to 40°.

## LFE Level

### ■ Dolby Digital<sup>\*1</sup>, DTS<sup>\*2</sup>, Multich PCM, Dolby TrueHD, DTS-HD Master Audio, DSD<sup>\*3</sup>

#### ▶ $-\infty$ dB, -20dB, -10dB, or 0dB

With these settings, you can set the level of the LFE (Low Frequency Effects) channel individually for each input sources.

If you find that low-frequency effects are too loud when using one of these sources, change the setting to -20 dB or  $-\infty$  dB.

\*1 Dolby Digital and Dolby Digital Plus sources

\*2 DTS and DTS-HD High Resolution sources

\*3 DSD (Super Audio CD) sources

## Source Setup



### Main Menu

### Source Setup

Items can be set individually for each input selector.

### Preparation

Press the input selector buttons to select an input source.

## Audyssey®

The tone for each speaker is set automatically by Audyssey 2EQ<sup>®</sup> Room Correction and Speaker Setup. To enable the following settings, you must first perform the Room Correction and Speaker Setup (→ [page 32](#)).

- These technologies cannot be used when:
  - a pair of headphones is connected, or
  - Direct listening mode is selected.

### ■ Audyssey

#### ▶ **Off**

#### ▶ **Movie:**

Select this setting for movie material.

The **Audyssey** indicator will light.

#### ▶ **Music:**

Select this setting for music material.

The **Audyssey** indicator will light.

#### Note

- When “**Audyssey Quick Start**” has been used for measurement, “**Audyssey**” cannot be selected.
- Audyssey equalizing does not work with DSD sources.

### ■ Dynamic EQ

#### ▶ **Off**

#### ▶ **On:**

Audyssey Dynamic EQ<sup>®</sup> becomes active.

The **Dynamic EQ** indicator will light.

With Audyssey Dynamic EQ, you can enjoy great sound even when listening at low volume levels.

Audyssey Dynamic EQ solves the problem of deteriorating sound quality as volume is decreased by taking into account human perception and room acoustics. It does so by selecting the correct frequency response and surround volume levels moment-by-moment so that the content sounds the way it was created at any volume level — not just at reference level.

### ■ Reference Level

#### Audyssey Dynamic EQ Reference Level Offset

#### ▶ **0dB:**

This should be selected for movie contents.

#### ▶ **5dB:**

Select this setting for content that has a very wide dynamic range, such as classical music.

#### ▶ **10dB:**

Select this setting for jazz or other music that has a wider dynamic range. This setting should also be selected for TV content as that is usually mixed at 10 dB below film reference.

#### ▶ **15dB:**

Select this setting for pop/rock music or other program material that is mixed at very high listening levels and has a compressed dynamic range.

Movies are mixed in rooms calibrated for film reference.

To achieve the same reference level in a home theater system each speaker level must be adjusted so that -30 dBFS band-limited (500 Hz to 2000 Hz) pink noise produces 75 dB sound pressure level at the listening position. A home theater system automatically calibrated by Audyssey 2EQ will play at reference level when the master volume control is set to the 0 dB position. At that level you can hear the mix as the mixers heard it.

↳ To be continued

Audyssey Dynamic EQ® is referenced to the standard film mix level. It makes adjustments to maintain the reference response and surround envelopment when the volume is turned down from 0 dB. However, film reference level is not always used in music or other non-film content.

Audyssey Dynamic EQ Reference Level Offset provides three offsets from the film level reference (5 dB, 10 dB, and 15 dB) that can be selected when the mix level of the content is not within the standard.

#### Note

- If “**Dynamic EQ**” setting is set to “**Off**”, this technology cannot be used.

### ■ Dynamic Volume

#### ▶ Off

#### ▶ Light:

Activates Light Compression Mode.

#### ▶ Medium:

Activates Medium Compression Mode.

#### ▶ Heavy:

Activates Heavy Compression Mode. This setting affects volume the most. It quiets the loud parts, such as explosions, and boosts the quiet parts so they can be heard.

#### Note

- If you want to use Audyssey Dynamic EQ or Audyssey Dynamic Volume® with THX listening modes, set the “**Loudness Plus**” setting to “**Off**” and set “**Preserve THX Settings**” to “**No**” (→ page 55).
- If you make Dynamic Volume active, “**Dynamic EQ**” is set to “**On**”. The **Dynamic Vol** indicator will light.
- When “**Dynamic EQ**” is set to “**Off**”, “**Dynamic Volume**” is automatically switched to “**Off**”.

### About Audyssey Dynamic EQ®

Audyssey Dynamic EQ solves the problem of deteriorating sound quality as volume is decreased by taking into account human perception and room acoustics. Dynamic EQ selects the correct frequency response and surround levels moment-by-moment at any user-selected volume setting. The result is bass response, tonal balance, and surround impression that remain constant despite changes in volume. Dynamic EQ combines information from incoming source levels with actual output sound levels in the room, a prerequisite for delivering a loudness correction solution.

Audyssey Dynamic EQ works well by itself. However, if Audyssey 2EQ® is on, the two technologies work in tandem to provide well-balanced sound for every listener at any volume level.

### About Audyssey Dynamic Volume®

Audyssey Dynamic Volume solves the problem of large variations in volume level between television programs, commercials, and between the soft and loud passages of movies. Dynamic Volume looks at the preferred volume setting by the user and then monitors how the volume of program material is being perceived by listeners in real time to decide whether an adjustment is needed.

Whenever necessary, Dynamic Volume makes the necessary rapid or gradual adjustments to maintain the desired playback volume level while optimizing the dynamic range. Audyssey Dynamic EQ is integrated into Dynamic Volume so that as the playback volume is adjusted automatically, the perceived bass response, tonal balance, surround impression and dialog clarity remain the same whether watching movies, flipping between television channels or changing from stereo to surround sound content.

## IntelliVolume

### ■ IntelliVolume

▶ **-12dB** to **0dB** to **+12dB** in 1 dB steps.

With IntelliVolume, you can set the input level for each input selector individually. This is useful if one of your source components is louder or quieter than the others.

Use ◀▶ to set the level.

If a component is noticeably louder than the others, use ◀ to reduce its input level. If it’s noticeably quieter, use ▶ to increase its input level.

#### Note

- IntelliVolume does not work for Zone 2/3.

## A/V Sync

### ■ A/V Sync

▶ **0msec** to **800msec** in 5 msec steps

When using progressive scanning on your Blu-ray Disc/DVD player, you may find that the picture and sound are out of sync. With this setting, you can correct this by delaying the audio signals.

To view the TV picture while setting the delay, press **Enter**.

To return to the previous screen, press **Return**.

The range of values you can adjust will depend on whether your TV or display supports HDMI Lip Sync and if the “**LipSync**” setting is set to “**On**” or not (→ page 65).

#### Note

- A/V Sync is disabled when the Direct listening mode is used with an analog input source.
- This setting cannot be used with the **NET** input selector.

## Name Edit

You can enter a custom name for each individual input selector and radio preset for easy identification. When entered, the custom name will appear on the display. The custom name is edited using the keyboard screen.

### ■ Name

- 1 Use ▲/▼/◀/▶ to select a character, and then press **Enter**.  
Repeat this step to enter up to 10 characters.
- 2 To store a name when you're done, be sure to select "OK" by using ▲/▼/◀/▶, and then press **Enter**.

Name input area

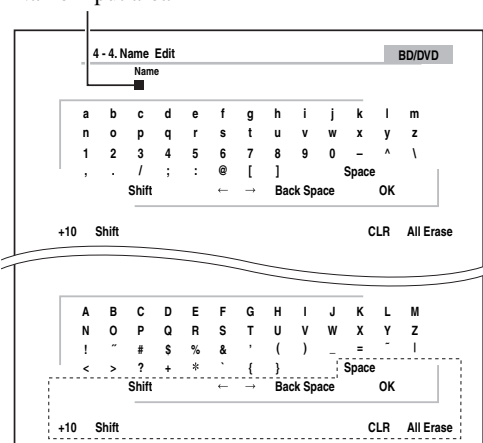

### Space:

Enters a space character.

### Shift\*1:

Toggles between lower and upper case characters.

← (Left)/ → (Right):

Moves the cursor left or right in the Name input area.

### Back Space\*2:

Moves the cursor backward and deletes one character.

### OK:

Confirms your entry.

### Tip

- \*1 This can also be performed by using **+10** on the remote controller.
- \*2 Press **CLR** on the remote controller to delete all the characters you have input.

### Tip

- To name a radio preset, select **AM** or **FM**, and then select the preset (→ page 30).
- To restore a name to its default, erase all characters with **CLR**, select "OK" and then press **Enter**.

### Note

- This setting cannot be used for the **NET** and **USB** input selectors.

## Picture Adjust

Using Picture Adjust, you can adjust the picture quality and reduce any noise appearing on the screen.

To view the TV picture while setting, press **Enter**. To return to the previous screen, press **Return**.

### ■ Wide Mode\*1\*6

This setting determines the aspect ratio.

#### ▶ 4:3:

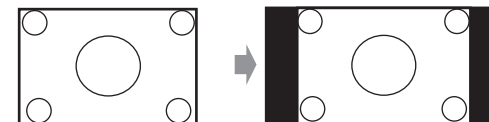

#### ▶ Full:

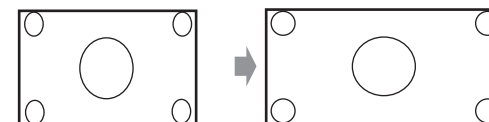

#### ▶ Zoom:

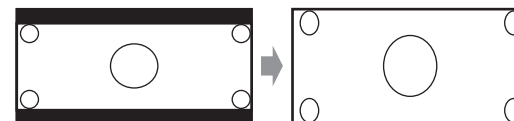

#### ▶ Wide Zoom:

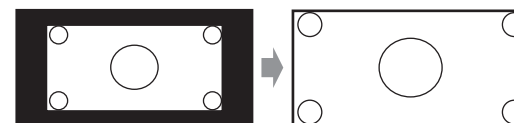

#### ▶ Auto:

According to the input signals and monitor output setting, the AV receiver automatically selects the "4:3", "Full", "Zoom" or "Wide Zoom" mode. See "Monitor Out" for details on the monitor output setting (→ page 50).

## ■ Picture Mode\*1\*7

### ▶ **Custom:**

All settings can be performed manually.

### ▶ **Cinema:**

Select when the picture source is a movie or alike.

### ▶ **Game:**

Select when the video source is a game console.

### ▶ **Through:**

Does not adjust picture quality (changes resolution).

### ▶ **Direct:**

Does not adjust picture quality (does not change resolution). The video coming from an analog input and output by HDMI output(s) is processed in the same way as “Through”.

With “Picture Mode”, you can change the following settings to be suitable for the movie or game screen by one operation; “Game Mode”, “Film Mode”, “Edge Enhancement”, “Noise Reduction”, “Brightness”, “Contrast”, “Hue”, “Saturation” or “Color Temperature”.

## ■ Game Mode\*2\*3\*4

### ▶ **Off**

### ▶ **On**

If video signal delay occurs during playback on a video component (i.e., game console), select the corresponding input source and set the “Game Mode” setting to “On”. The delay will decrease but in return the picture quality will become poor.

## ■ Film Mode\*2\*4

### ▶ **Video:**

“Film Mode” detection is not applied and the input signal is handled as a video source.

### ▶ **Auto:**

Detects whether the input signal is a video or a movie. If it is a movie, the appropriate conversion is applied.

The AV receiver will adjust to the picture source, automatically converting it to the appropriate progressive signal and reproducing the natural quality of the original picture.

## ■ Edge Enhancement\*2\*4\*5

### ▶ **Off**

### ▶ **Low**

### ▶ **Mid**

### ▶ **High**

With this setting, you can make the picture appear sharper.

## ■ Noise Reduction\*2\*4\*5

### ▶ **Off**

### ▶ **Low**

### ▶ **Mid**

### ▶ **High**

With this setting, you can reduce noise appearing on the screen. Select the desired level.

## ■ Brightness\*1\*2\*4

### ▶ **-50 to 0 to +50**

With this setting, you can adjust the picture brightness. “-50” is the darkest. “+50” is the brightest.

## ■ Contrast\*1\*2\*4

### ▶ **-50 to 0 to +50**

With this setting, you can adjust contrast. “-50” is the least. “+50” is the greatest.

## ■ Hue\*1\*2\*4

### ▶ **-50 to 0 to +50**

With this setting, you can adjust the color hue between “-50” and “+50”.

## ■ Saturation\*1\*2\*4

### ▶ **-50 to 0 to +50**

With this setting, you can adjust saturation. “-50” is the weakest color. “+50” is the strongest color.

## ■ Color Temperature\*2\*4

### ▶ **Warm**

### ▶ **Normal**

### ▶ **Cool**

With this setting, you can adjust the color temperature.

### Note

- “Picture Adjust” cannot be used when:
  - The **NET** input selector is selected, or
  - “Monitor Out” is set to “Sub”.

- \*1 This procedure can also be performed on the remote controller by using the Quick Setup (→ page 45).
- \*2 When the “Picture Mode” setting is set to anything other than “Custom”, this setting cannot be used.
- \*3 If the “Resolution” setting is set to “4K Upscaling” (→ page 50), this setting is fixed at “Off”.
- \*4 Press **CLR** if you want to reset to the default value.
- \*5 If the “Game Mode” setting is set to “On”, this setting is fixed at “Off”.
- \*6 When a 3D video source is input, “Wide Mode” is fixed to “Full”.
- \*7 When “Metadata Compatible” is enabled, “Picture Mode” is fixed to “Direct” (→ page 55).

## Audio Selector

### ■ Audio Selector

#### ▶ ARC:

The audio signal from your TV tuner can be sent to **HDMI OUT MAIN** of the AV receiver.\*<sup>1</sup>

With this selection, the TV's audio can be automatically selected as a priority among other assignments.

#### ▶ HDMI:

This can be selected when **HDMI IN** has been assigned as an input source. If both HDMI (**HDMI IN**) and digital audio inputs (**COAXIAL IN** or **OPTICAL IN**) have been assigned, HDMI input is automatically selected as a priority.

#### ▶ COAXIAL:

This can be selected when **COAXIAL IN** has been assigned as an input source. If both coaxial and HDMI inputs have been assigned, coaxial input is automatically selected as a priority.

#### ▶ OPTICAL:

This can be selected when **OPTICAL IN** has been assigned as an input source. If both optical and HDMI inputs have been assigned, optical input is automatically selected as a priority.

#### ▶ Analog:

The AV receiver always outputs analog signals.

You can set priorities of audio output when there are both digital and analog inputs.

#### Note

- This setting can be made only for an input source that is assigned to **HDMI IN**, **COAXIAL IN**, or **OPTICAL IN**.
  - This setting cannot be used with the **NET** and **USB** input selectors.
  - When using the Whole House Mode, “**Audio Selector**” is fixed to “**Analog**”.
- \*<sup>1</sup> You can select “**ARC**” if you select the **TV/CD** input selector. But you cannot if you've selected “**Off**” in the “**Audio Return Channel**” setting (→ **page 65**).

## Setting the Incoming Digital Signal (Fixed Mode)

### ■ Fixed Mode

#### ▶ Off:

The format is detected automatically. If no digital input signal is present, the corresponding analog input is used instead.

#### ▶ PCM:

Only 2-channel PCM format input signals will be heard. If the input signal is not PCM, the **PCM** indicator will flash and noise may also be produced.

#### ▶ DTS:

Only DTS (but not DTS-HD) format input signals will be heard. If the input signal is not DTS, the **dts** indicator will flash and there will be no sound.

When “**HDMI**”, “**COAXIAL**” or “**OPTICAL**” is selected in the “**Audio Selector**” setting, you can then specify the signal type in “**Fixed Mode**”.

Normally, the AV receiver detects the signal format automatically. However, if you experience either of the following issues when playing PCM or DTS material, you can manually set the signal format to PCM or DTS.

- If the beginnings of tracks from a PCM source are cut off, try setting the format to PCM.
- If noise is produced when fast forwarding or reversing a DTS CD, try setting the format to DTS.

#### Note

- The setting will be reset to “**Off**” when you change the setting in “**Audio Selector**”.

## Listening Mode Preset



### Main Menu

### Listening Mode Preset

You can assign a default listening mode to each input source that will be selected automatically when you select each input source. For example, you can set the default listening mode to be used with Dolby Digital input signals. You can select other listening modes during playback, but the mode specified here will be resumed once the AV receiver has been set to standby.

### 1 Use ▲/▼ to select the input source that you want to set, and then press Enter.

The following menu appears.

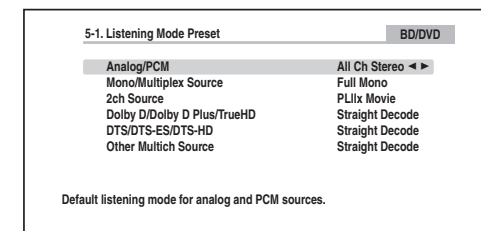

## 2 Use ▲/▼ to select the signal format that you want to set, and then use ◀/▶ to select a listening mode.

Only listening modes that can be used with each input signal format can be selected (→ **pages 35 to 41**).

The “**Last Valid**” option means that the listening mode selected last will be used.

The “**Straight Decode**” option means that straight decoding listening mode (Dolby Digital, DTS, etc.) is selected.

### Note

- For the “**AM**” or “**FM**” input selector, only “**Analog**” will be available.
- For the “**NET**” or “**USB**” input selector, only “**Digital**” will be available.

### ■ Analog/PCM/Digital

With this setting, you can specify the listening mode used when an analog (CD, TV, LD, VHS, MD, turntable, radio, cassette, cable, satellite, etc.) or PCM digital (CD, DVD, etc.) audio signal is played.

### ■ Mono/Multiplex Source

With this setting, you can specify the listening mode used when a mono digital audio signal is played (DVD, etc.).

### ■ 2ch Source

With this setting, you can specify the listening mode used when 2-channel (2/0) stereo digital sources, such as Dolby Digital or DTS, are played.

### ■ Dolby D/Dolby D Plus/TrueHD

With this setting, you can specify the listening mode used when Dolby Digital or Dolby Digital Plus format digital audio signals are played (DVD, etc.). Specifies the default listening mode for Dolby TrueHD sources, such as Blu-ray or HD DVD (input via HDMI).

### ■ DTS/DTS-ES/DTS-HD

With this setting, you can specify the listening mode used when DTS or DTS-HD High Resolution format digital audio signals are played (DVD, LD, CD, etc.). Specifies the default listening mode for DTS-HD Master Audio sources, such as Blu-ray or HD DVD (input via HDMI).

### ■ Other Multich Source

Specifies the default listening mode for multichannel PCM sources from **HDMI IN** such as DVD-Audio, and DSD multichannel sources such as Super Audio CD.

## Miscellaneous



### Main Menu

### Miscellaneous

## Volume Setup

### ■ Volume Display

#### ▶ Absolute:

Displayed range is **Min, 1 to 99, Max**.

#### ▶ Relative (THX):

Displayed range is **-∞dB, -81dB to +18dB**.

With this setting, you can choose how the volume level is displayed.

The absolute value 82 is equivalent to the relative value 0 dB.

### Note

- If the absolute value is set to 82, “**82Ref**” will appear on the display and the **THX** indicator will flash.

### ■ Muting Level

▶ **-∞dB** (fully muted), **-50dB** to **-10dB** in 10 dB steps.

This setting determines how much the output is muted when the muting function is used (→ **page 44**).

### ■ Maximum Volume

▶ **Off, 50 to 99** (Absolute display)

▶ **Off, -32dB to +17dB** (Relative display)

With this setting, you can limit the maximum volume.

To disable this setting, select “**Off**”.

## ■ Power On Volume

▶ **Last**, **Min**, **1** to **99** or **Max** (Absolute display)

▶ **Last**,  $-\infty$ **dB**, **-81dB** to **+18dB** (Relative display)

With this preference, you can specify the volume setting to be used each time the AV receiver is turned on.

To use the same volume level that was used when the AV receiver was turned off, select “**Last**”.

The “**Power On Volume**” setting cannot be set higher than the “**Maximum Volume**” setting.

## ■ Headphone Level

▶ **-12dB** to **0dB** to **+12dB**

With this setting, you can specify the headphone volume relative to the main volume. This is useful if there’s a volume difference between your speakers and your headphones.

## OSD Setup

---

### ■ On Screen Display

▶ **On**

▶ **Off**

This preference determines whether operation details are displayed on-screen when an AV receiver function is adjusted.

Even when “**On**” is selected, operation details may not be output if the input source is connected to an **HDMI IN**.

### ■ Language

▶ **English**, **Deutsch**, **Français**, **Español**, **Italiano**,  
**Nederlands**, **Svenska**, **中文**

This setting determines the language used for the on-screen menus.

### ■ Screen Saver

▶ **3min**, **5min**, **10min**

▶ **Off**

With this setting, you can set the time until the screen saver activates itself. Once active, the screen saver will go off and the screen will return to its previous state if the AV receiver is operated in any way.

## 12V Trigger A/B/C Setup

---

Depending on their type, when some components are turned by using triggers A, B, and C, a large amount of current may be drawn at once. To prevent this, you can delay each trigger signal individually. Another application of trigger delay is to eliminate the “thump” noise that’s sometimes heard when a source component is turned on. You can accomplish this by delaying the trigger signal for your power amplifier, so that it’s the last component to be turned on.

### ■ Delay

▶ **0sec**, **1sec**, **2sec**, **3sec**:

When “**0sec**” is selected, the trigger signal is output as soon as the input source is changed.

### Note

- By default, “**12V Trigger A Setup**” is set to “**0sec**”, “**12V Trigger B Setup**” to “**1sec**”, and “**12V Trigger C Setup**” to “**2sec**”.
- Use a miniplug cable to connect the AV receiver’s **12V TRIGGER OUT A, B, or C** jack to the 12 V trigger input of a connected component.

### ■ BD/DVD, CBL/SAT, STB/DVR, GAME, PC, AUX, TUNER, TV/CD, NET, USB, EXTRA1, EXTRA2

▶ **Off**:

No trigger signal is output.

A 12-volt trigger signal is output when the connected component is selected as the source for:

▶ **Main**, **Zone 2**, **Main/Zone 2**, **Zone 3**, **Main/Zone 3**,  
**Zone 2/Zone 3**, **All**

### Tip

- “**EXTRA1**” and “**EXTRA2**” can only be selected if they are assigned.
- “**EXTRA1**” and “**EXTRA2**” can be selected as input sources in “**Input**” of “**Quick Setup**” (→ page 45).

### Note

- Except for “**EXTRA1**” and “**EXTRA2**” which are set to “**Off**”, all input sources on the “**12V Trigger A Setup**” menu are set to “**Main**”, those on “**12V Trigger B Setup**” are set to “**All**”, and those on “**12V Trigger C Setup**” are set to “**Zone 2**” by default.

## Hardware Setup



Main Menu

Hardware Setup

## Multi Zone

### ■ Zone 2 Out, Zone 3 Out

#### ▶ Fixed:

The Zone 2/3 volume must be set on the amp in that zone.

#### ▶ Variable:

The Zone 2/3 volume can be set on the AV receiver.

If you've connected your Zone 2/3 speakers to an amp with no volume control, set the "Zone 2 Out" and "Zone 3 Out" setting, respectively, to "Variable" so that you can set the volume, balance, and tone of zone 2 and volume of zone 3 on the AV receiver.

### ■ Zone 2 Maximum Volume, Zone 3 Maximum Volume

#### ▶ Off, 50 to 99 (Absolute display)

#### ▶ Off, -32dB to +17dB (Relative display)

With this setting, you can limit the maximum volume for Zone 2/3.

### ■ Zone 2 Power On Volume, Zone 3 Power On Volume

#### ▶ Last, Min, 1 to 99 or Max (Absolute display)

#### ▶ Last, ∞dB, -81dB to +18dB (Relative display)

This setting determines what the volume will be for Zone 2/3 each time the AV receiver is turned on.

To use the same volume level as when the AV receiver was last turned off, select "Last".

The "Zone 2 Power On Volume" and "Zone 3 Power On Volume" cannot be set higher than the "Zone 2 Maximum Volume" and "Zone 3 Maximum Volume" setting.

## Tuner

### ■ AM/FM Frequency Step (North American models)

#### ▶ 10kHz/200kHz:

#### ▶ 9kHz/50kHz:

Select the frequency step according to your area.

### ■ AM Frequency Step (Australian models)

#### ▶ 10kHz:

#### ▶ 9kHz:

Select the frequency step according to your area.

For AM/FM tuning to work properly, you must specify the AM/FM frequency step used in your area.

#### Note

- When this setting is changed, all radio presets will be deleted.

## HDMI

### ■ HDMI Control(RIHD)

#### ▶ Off

#### ▶ On

Turn this setting on to allow **RIHD**-compatible components connected via HDMI to be controlled by the AV receiver (→ page 92).

#### Note

- When the setting is set to "On" and the menu is closed, the names of connected **RIHD**-compatible components and "RIHD On" are displayed on the AV receiver. "Search..." → "(name)" → "RIHD On"  
When the AV receiver cannot receive the name of the component, it is displayed as "Player\*" or "Recorder\*", etc. ("\*" shows up and indicates the number of components, when two or more are received).
- When an **RIHD**-compatible component is connected to the AV receiver via an HDMI cable, the name of the connected component is displayed on the AV receiver display. For example, while you are watching TV broadcasting, if you operate a Blu-ray Disc/DVD player (being powered on) with the remote control of

the AV receiver, the name of the Blu-ray Disc/DVD player will be displayed on the AV receiver.

- Set it to "Off" when a connected piece of equipment is not compatible or it is unclear whether the equipment is compatible or not.
- If operation is not normal when set to "On", change the setting to "Off".
- Refer to the connected component's instruction manual for details.
- When the "HDMI Control(RIHD)" setting is set to "On", the power consumption on standby mode slightly increases. (Depending on the TV status, the AV receiver will enter standby mode as usual.)
- The **RIHD** control does not support **HDMI OUT SUB**. Use **HDMI OUT MAIN** instead.
- When the source equipment is connected with the **RI** connection, it may malfunction if "HDMI Control(RIHD)" is set to "On".

### ■ HDMI Through

#### ▶ Off

#### ▶ BD/DVD, CBL/SAT, STB/DVR, GAME, PC, AUX, TV/CD, EXTRA1, EXTRA2:

Selects the input source for which the HDMI Through function is enabled.

#### ▶ Last:

The HDMI Through function is activated on the input source selected at the time of setting the AV receiver to standby mode.

When enabling the HDMI Through function, regardless of whether the AV receiver is on or in standby, both audio and video streams from an HDMI input will be output to the TV or other components via HDMI connection. The **HDMI** indicator will be dimly-lit in standby mode. Note that the indicator may not light under certain conditions (→ page 49).

This setting is fixed to "Auto" automatically when the above "HDMI Control(RIHD)" setting is set to "On", resulting in automatic input source selection.

↳ To be continued



**Note**

- Only an input source assigned to an **HDMI IN** via “**HDMI Input**” setting is enabled (→ **page 50**).
- The power consumption in standby mode will increase during the HDMI Through function; however in the following cases, the power consumption can be saved:
  - The TV is in standby mode.
  - You are watching a TV program.
- Refer to the connected component’s instruction manual for details.
- Depending on the connected component, the correct input source may not be selected with the setting fixed to “**Auto**”.
- This setting is set to “**Off**” automatically when the “**HDMI Control(RIHD)**” setting is set to “**Off**”.

**Audio TV Out**

- ▶ **Off**
- ▶ **On**

This preference determines whether the incoming audio signal is output from the HDMI output. You may want to turn this preference on if your TV is connected to the HDMI output and you want to listen to the audio from a connected component through your TV’s speakers. Normally, this should be set to “**Off**”.

**Note**

- If “**On**” is selected and the audio can be output from the TV, the AV receiver will output no sound through its speakers. In this case, “**TV Speaker**” appears on the AV receiver’s display by pressing **Display**.
- When “**HDMI Control(RIHD)**” is set to “**On**”, this setting is fixed to “**Auto**”.
- With some TVs and input signals, no sound may be output even when this setting is set to “**On**”.
- When “**Audio TV Out**” or “**HDMI Control(RIHD)**” is set to “**On**” and you’re listening through your TV’s speakers (→ **page 15**), turning up the AV receiver’s volume control will make the sound be output from the AV receiver’s front left and right speakers. To stop the AV receiver’s speakers producing sound, change the settings, change your TV’s settings, or turn down the AV receiver’s volume.
- Listening mode cannot be changed when this setting is set to “**On**” and the input source is not HDMI.

**Audio Return Channel (ARC)**

- ▶ **Off**
- ▶ **Auto:**

The audio signal from your TV tuner can be sent to **HDMI OUT MAIN** of the AV receiver.

The audio return channel (ARC) function allows an ARC capable TV to send the audio stream to **HDMI OUT MAIN** of the AV receiver. To use this function, you must select the **TV/CD** input selector and your TV must be ARC capable. The **ARC** indicator will light when the audio signal is detected. Default setting: “- - -”

**Note**

- This setting is fixed to “- - -” when the “**HDMI Control(RIHD)**” setting is set to “**Off**”.
- This setting is set to “**Auto**” automatically when the “**HDMI Control(RIHD)**” setting is set to “**On**” for the first time.
- If you set “**Audio Return Channel**” to “**Auto**”, the “**Audio Selector**” settings of the **TV/CD** input selector will be automatically switched to “**ARC**” (→ **page 61**).

After changing the settings of the “**HDMI Control(RIHD)**”, “**HDMI Through**” or “**Audio Return Channel**”, turn off the power on all connected pieces of equipment and then turn them on again. Refer to the user’s manuals for all connected pieces of equipment.

**LipSync**

- ▶ **Off**
- ▶ **On**

This function allows the AV receiver to automatically correct any delay between the video and the audio, based on the data from the connected monitor.

**Note**

- This function works only if your HDMI-compatible TV supports HDMI Lip Sync.

**InstaPrevue**

These settings apply to “**InstaPrevue**” of the Home menu (→ **page 42**) and specify the preview display of HDMI video streams.

**Sub Window**

- ▶ **Multi:**  
Displays preview thumbnails all at once.
- ▶ **Single:**  
Displays preview thumbnails one-by-one.

With this setting, you can set the number of preview thumbnails displayed.

**Position**

(with “**Sub Window**” set to “**Multi**”)

- ▶ **Top, Bottom, Left, Right**

(with “**Sub Window**” set to “**Single**”)

- ▶ **Upper Left, Upper Right, Lower Left, Lower Right**

With this setting, you can set the position of preview thumbnails on the TV screen.

**Note**

- Depending on video signals, the picture may not be properly rendered on the preview thumbnails of InstaPrevue.

## Auto Standby

---

### ■ Auto Standby

▶ Off

▶ On

When “**Auto Standby**” is set to “**On**”, the **ASb** indicator lights and the AV receiver will automatically enter standby mode if there is no operation for 30 minutes with no audio and no video signal input.

“**Auto Standby**” will appear on the AV receiver’s display and OSD 30 seconds before the Auto Standby comes on.

Default setting: **On (Australian models)**, **Off (North American models)**

#### Note

- Set to “**On**”, the Auto Standby function may activate itself during playback with some sources.
- The Auto Standby function does not work when Zone 2/3 is on.

## Network

---

After modifying the network settings, you must confirm the changes by executing “**Save**”.

This section explains how to configure the AV receiver’s network settings manually.

If your router’s DHCP server is enabled, you don’t need to change any of these settings, as the AV receiver is set to use DHCP to configure itself automatically by default (i.e., DHCP is set to “**Enable**”). If, however, your router’s DHCP server is disabled (you’re for example using static IP), you’ll need to configure these settings yourself, in which case, a knowledge of Ethernet networking is essential.

### What’s DHCP?

DHCP (Dynamic Host Configuration Protocol) is used by routers, computers, the AV receiver, and other devices to automatically configure themselves on a network.

### What’s DNS?

The DNS (Domain Name System) translates domain names into IP addresses. For example, when you enter a domain name such as *www.onkyousa.com* in your Web browser, before accessing the site, your browser uses DNS to translate this into an IP address, in this case 63.148.251.142.

### ■ MAC Address

This is the AV receiver’s MAC (Media Access Control) address. This address cannot be changed.

### ■ DHCP

▶ Enable

▶ Disable

This setting determines whether or not the AV receiver uses DHCP to automatically configure its IP Address, Subnet Mask, Gateway, and DNS Server settings.

#### Note

- If you select “**Disable**”, you must configure the “**IP Address**”, “**Subnet Mask**”, “**Gateway**”, and “**DNS Server**” settings yourself.

### ■ IP Address

▶ Class A:

“**10.0.0.0**” to “**10.255.255.255**”

▶ Class B:

“**172.16.0.0**” to “**172.31.255.255**”

▶ Class C:

“**192.168.0.0**” to “**192.168.255.255**”

Enter a static IP address provided by your Internet Service Provider (ISP).

Most routers use Class C IP addresses.

### ■ Subnet Mask

Enter the subnet mask address provided by your ISP (typically **255.255.255.0**).

### ■ Gateway

Enter the gateway address provided by your ISP.

### ■ DNS Server

Enter the DNS server address provided by your ISP.

### ■ Proxy URL

To use a Web proxy, enter its URL here.

### ■ Proxy Port

If you’re using a Web proxy, enter a proxy port number here.

### ■ Network Standby

▶ On

▶ Off

This setting enables or disables control over the network. When enabled, the **NET** indicator will be dimly-lit while the AV receiver is in standby mode. Note that the indicator may not light under certain conditions (→ [page 49](#)).

#### Note

- When set to “**On**”, the power consumption slightly increases in standby mode.

### ■ Update Notice

▶ Enable

▶ Disable

When this setting is enabled, you will be notified if a firmware update via network is available.

#### Note

- Selecting “**Never Remind me**” on the notification window will switch this setting to “**Disable**” (→ [page 19](#)).
- For details on the update notification, see “If the “Firmware Update Available” window appears.” (→ [page 19](#)).

## Initial Setup

---

If you skipped the initial setup wizard, for example on first-time use, you can reaccess it from here.

See “**Initial Setup**” (→ [page 20](#)).

## Remote Controller Setup



Main Menu

Remote Controller Setup

### Remote ID

#### ■ Remote ID

▶ 1, 2, or 3

When several Integra/Onkyo components are used in the same room, their remote ID codes may overlap. To differentiate the AV receiver from other components, you can change its remote ID from "1", to "2" or "3".

#### Note

- If you do change the AV receiver's remote ID, be sure to change the remote controller to the same ID (see below), otherwise, you won't be able to control it with the remote controller.

### Changing the remote controller's ID

- 1** While holding down **Receiver**, press and hold down **Q Setup** until the remote indicator lights (about 3 seconds).
- 2** Use the number buttons to enter ID 1, 2, or 3.  
The remote indicator flashes twice.

### Remote Mode Setup

See "Looking up for Remote Control Codes"  
(→ page 74).

## Lock Setup



Main Menu

Lock Setup

With this preference, you can protect your settings by locking the setup menus.

#### ■ Setup

▶ **Locked**

▶ Unlocked

When "**Locked**" is selected, the setup menus will be locked and you cannot change any setting.

# Multi Zone

In addition to the main listening room, you can also enjoy playback in the other room, or as we call Multi Zone. And, you can select a different source for each room.

## Making Multi Zone Connections

There are two ways you can connect Zone speakers:

1. Connect them directly to the AV receiver.
2. Connect them to an additional amplifier.

### Connecting Your Zone 2 Speakers Directly to the AV receiver

This setup allows you to select different sources for Main room and Zone 2. This is called Powered Zone, as the Zone 2 speakers are powered by the AV receiver.

**To use this setup, you must activate the Powered Zone 2 setting (→ page 52).**

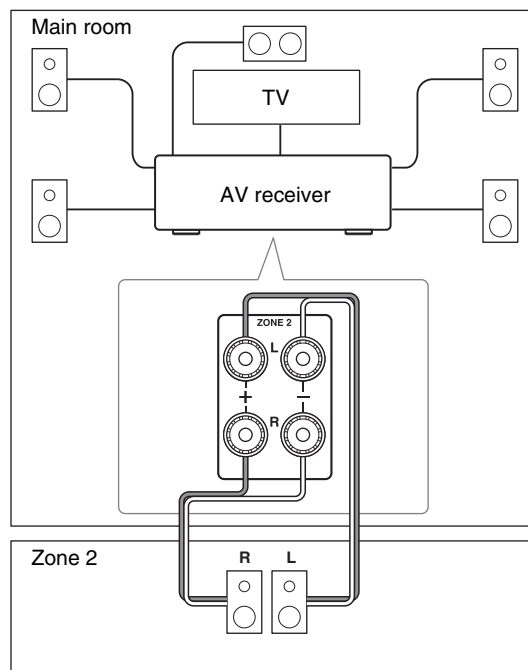

#### Note

- With this setup, the volume of Zone 2 is controlled by the AV receiver.
- When Powered Zone 2 is used, playback in the main room is reduced to 5.1 channels.

### Connecting the Zone Speakers to an Additional Amplifier

This setup allows 7.1-channel playback in your main listening room and 2-channel stereo playback in Zone 2/3.

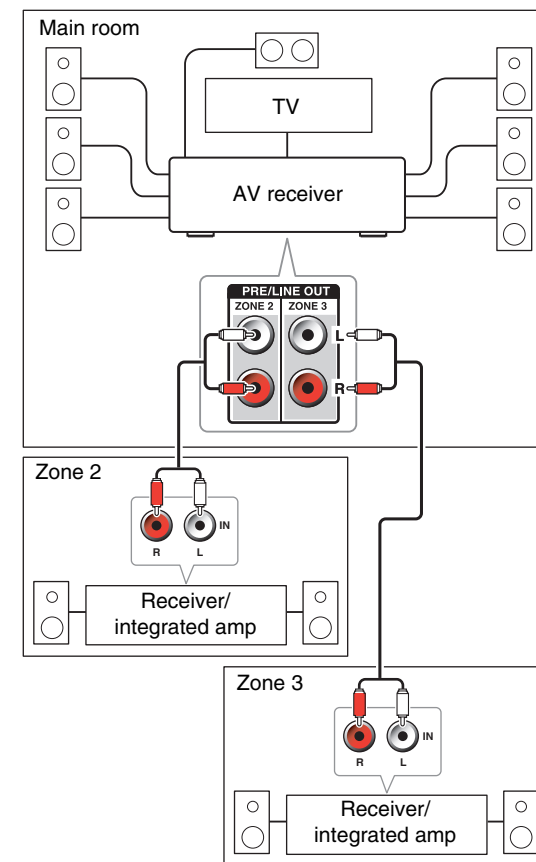

#### Note

- With the default settings, the Zone 2/3 volume must be set on the Zone 2/3 amplifier. If your Zone 2/3 amplifier has no volume control, change the setting so that you can set the Zone 2/3 volume on the AV receiver. See “Multi Zone” (→ page 64).

## Setting the Zone 2/3 Out

See “Multi Zone” (→ page 64).

## Controlling Multi Zone Components

### ■ Operating on the AV receiver

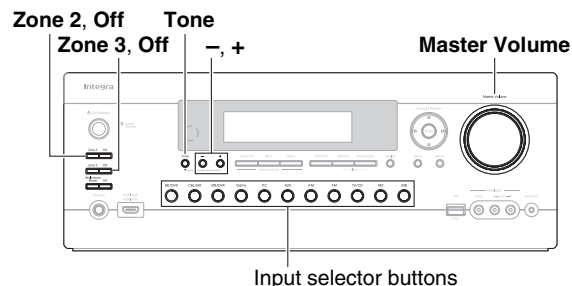

#### Tip

- The Whole House Mode function shares the input source of main room with Multi Zone (→ page 44).

- 1 To turn on Zone 2/3 and select an input source, press Zone 2 or Zone 3 followed by an input selector button within 8 seconds.**

Zone 2/3 turns on, the **Z2** or **Z3** indicator lights on the AV receiver's display.

#### Tip

- The corresponding trigger output goes high (+12 V).

To select the same source as the main room's, press **Zone 2** or **Zone 3** twice. “**Z2 Sel: Source**” or “**Z3 Sel: Source**” appears on the AV receiver's display.

- 2 To turn off Zone 2/3, press Off for each Zone.**

The zone is turned off.

#### Tip

- The corresponding trigger output goes low (0 volts).

### ■ Operating on the remote controller

To control Zone 2/3, you must press **Zone2** or **Zone3** on the remote controller first.

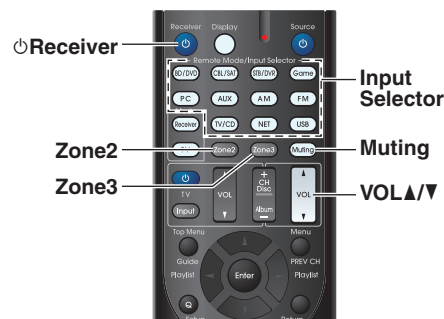

- 1 Press Zone2 or Zone3, then point the remote controller at the AV receiver and press **Receiver**.**

Zone 2/3 turns on, the **Z2** or **Z3** indicator lights on the AV receiver's display.

#### Tip

- The corresponding trigger output goes high (+12 V).

- 2 To select an input source for Zone 2/3, press Zone2 or Zone3, followed by an Input Selector button.**

- 3 To turn off Zone 2/3, press Zone2 or Zone3, followed by **Receiver**.**

The zone is turned off.

#### Tip

- The corresponding trigger output goes low (0 volts).

## Adjusting the Volume for Zone 2/3

### ■ Operating on the remote controller

- 1 Press Zone2 or Zone3.**

- 2 Use VOL ▲/▼.**

### ■ Operating on the AV receiver

- 1 Press Zone 2 or Zone 3 (the Z2 or Z3 indicator on the AV receiver's display flash).**

- 2 Use Master Volume control within 8 seconds.**

If your Zone 2/3 speakers are connected to a receiver or integrated amplifier in Zone 2/3, use its volume control to adjust the volume.

## Muting Zone 2/3

### ■ Operating on the remote controller

- 1 Press Zone2 or Zone3 followed by Muting.**

#### Tip

- To unmute, press **Zone2** or **Zone3** followed by **Muting** again. Zone can also be unmuted by adjusting the volume.

## Adjusting the Tone and Balance of Zone 2

- 1 On the AV receiver, press **Zone 2**.
- 2 Press the AV receiver's **Tone** repeatedly to select "Bass", "Treble" or "Balance".
- 3 Use **–** or **+** to adjust the bass, treble or balance.
  - You can boost or cut the bass or treble from  $-10$  dB to  $+10$  dB in 2 dB steps.
  - You can adjust the balance from 0 in the center to  $+10$  dB to the right or  $+10$  dB to the left in 2 dB steps.

### Note

- Only analog input sources are output from the **ZONE 2/ZONE 3 PRE/LINE OUT** jacks and **ZONE 2 L/R** terminals. Digital input sources are not output. If no sound is heard when an input source is selected, verify that the source is connected to an analog input.
- You cannot select different AM or FM radio stations for your main room and Zone 2/3. The same AM/FM radio station will be heard in each room. Namely, if you have selected an FM station for the main room, that station will also be output in Zone 2/3.
- When you have selected **NET** or **USB** as input selector, the last selector selected will be set for Main room and Zone 2/3.
- When Zone 2/3 is activated and its input selector is selected, the power consumption of standby mode slightly increases.
- While Zone 2/3 is on, **RI** functions will not work.
- When setting the AV receiver to standby mode while Zone 2/3 is active, the **Z2** or **Z3** indicator is dimly lit.
- The Zone 2 level, balance, and tone functions have no effect on the **ZONE 2 PRE/LINE OUT** jacks when the "Zone 2 Out" setting is set to "Fixed" (→ page 64).
- The Zone 3 volume function has no effect on **ZONE 3 PRE/LINE OUT** when the "Zone 3 Out" setting is set to "Fixed" (→ page 64).

## Using the 12V Triggers

The 12V triggers A, B, and C can be used to turn on 12V trigger-capable components automatically when they are selected as the input source. The triggers can be set so that they activate themselves once a connected component is selected as the input source for the main room, Zone 2, Zone 3, or any combination of rooms. When triggered, the output from a **12V TRIGGER OUT** goes high ( $+12$  volts and 150 milliamperes max. at **12V TRIGGER OUT A**;  $+12$  volts and 25 milliamperes max. at **12V TRIGGER OUT B** and **C**).

See "12V Trigger A/B/C Setup" (→ page 63).

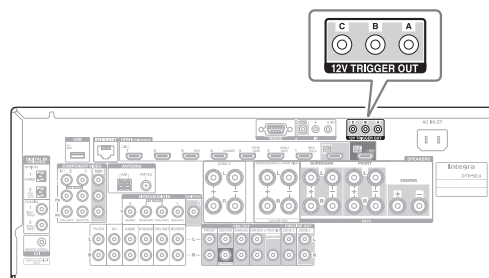

### Hookup

- Use a miniplug cable to connect the AV receiver's **12V TRIGGER OUT A, B, or C** jack to the 12 V trigger input of a connected component.

## Using the Remote Controller in Zone 2/3 and Multiroom Control Kits

To control the AV receiver with the remote controller while you're in the Zone 2/3 room, you'll need a commercially available multiroom remote control kit.

Multiroom kits are made by Niles and Xantech.

These kits can also be used when there isn't a clear line of sight to the AV receiver's remote sensor, such as when it's installed inside a cabinet.

### Using a Multiroom Kit with Zone 2/3

In this setup, the IR receiver in Zone 2/3 picks up the infrared signals from the remote controller and feeds them through to the AV receiver in the main room via the connecting block.

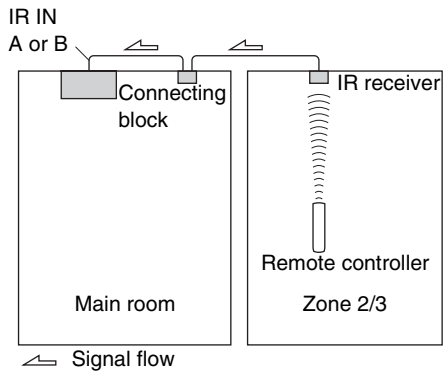

The miniplug cable from the connecting block should be connected to the AV receiver's **IR IN A** or **B** jack, as shown below. The **IR IN A** and **B** jacks are identical. Up to two IR receivers can be connected.

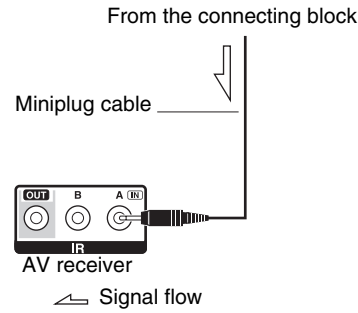

### Using a Multiroom Kit with a Cabinet

In this setup, the IR receiver picks up the infrared signals from the remote controller and feeds them to the AV receiver located in the cabinet via the connecting block.

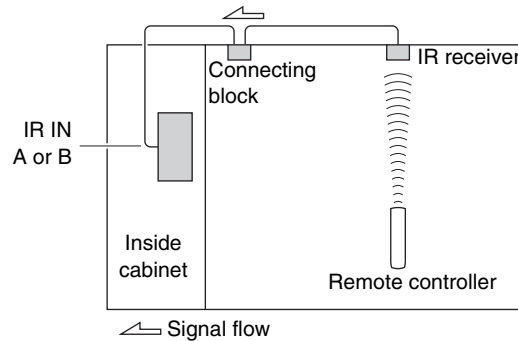

## Using a Multiroom Kit with Other Components

In this setup, an IR emitter is connected to the AV receiver's **IR OUT** jack and placed in front of the other component's remote control sensor. Infrared signals received at the AV receiver's **IR IN A** or **B** jack are fed through to the other component via the IR emitter. Signals picked up by the AV receiver's remote control sensor are not output.

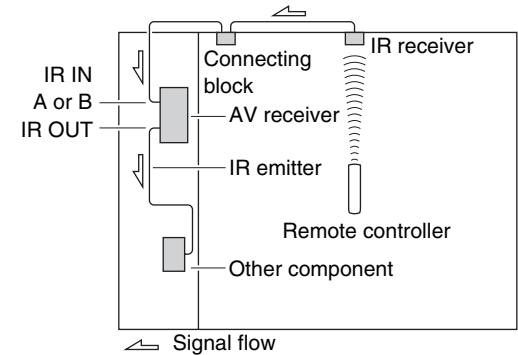

The IR emitter should be connected to the AV receiver's **IR OUT** jack, as shown below.

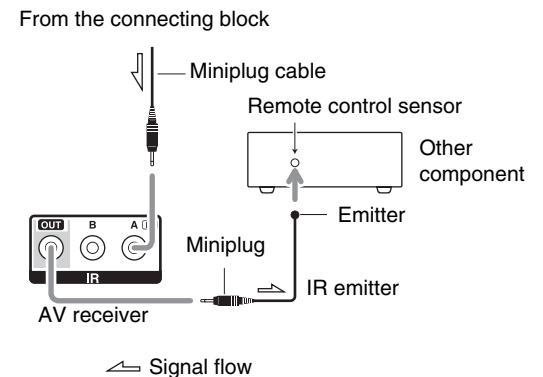

# iPod/iPhone Playback via Onkyo Dock

## Using the Onkyo Dock

The Dock is sold separately. Models sold are different depending on the region.

For the latest information on the Onkyo Dock components, see the Onkyo web site at:

<http://www.onkyo.com>

Before using the Onkyo Dock components, update your iPod/iPhone with the latest software, available from the Apple web site.

For supported iPod/iPhone models, see the instruction manual of the Onkyo Dock.

## RI Dock

With the RI Dock, you can easily play the music of your iPod/iPhone, or watch the slideshows and videos of your iPod/iPhone on a TV. In addition, the on-screen display (OSD) allows you to view, navigate, and select your iPod/iPhone model's contents on your TV, and with the supplied remote controller, you can control your iPod/iPhone from the comfort of your sofa. You can even use the AV receiver's remote controller to operate your iPod/iPhone.

### Note

- Enter the appropriate remote control code before using the AV receiver's remote controller for the first time (→ [page 75](#)).
- Connect the RI Dock to the AV receiver with an **RI** cable (→ [page 17](#)).
- Set the RI Dock's RI MODE switch to "HDD" or "HDD/DOCK".
- Set the AV receiver's Input Display to "DOCK" (→ [page 43](#)).

### System Function

Depending on your iPod/iPhone model and generation, some of the linked operations may not be available.

### System On

When you turn on the AV receiver, the RI Dock and iPod/iPhone turn on automatically. In addition, when RI Dock and iPod/iPhone are on, the AV receiver can be turned on by pressing **Source**.

### Auto Power On

If you press the remote controller's **▶** (Playback) while the AV receiver is on standby, the AV receiver will automatically turn on, select your iPod/iPhone as the input source, and your iPod/iPhone will start playback.

### Direct Change

If you start iPod/iPhone playback while listening to another input source, the AV receiver will automatically switch to the input to which the RI Dock is connected.

## Other Remote Operations

You can use the remote controller that came with the AV receiver to control other iPod/iPhone functions. The available functionality depends on the AV receiver.

### Note

- If you use your iPod/iPhone with any other accessories, iPod/iPhone playback detection may not work.
- The System On function may not work depending on the RI Dock.

### iPod Alarm

If you use the Alarm function on your iPod to start playback, the AV receiver will turn on at the specified time and select your iPod as the input source automatically.

### Note

- This linked operation won't work while a video is being played or when the sound set for the alarm is a built-in sound (Beep).
- This linked operation won't work with models on which music files cannot be used to set the alarm sound.

### Operating Notes

- Use the AV receiver's volume control to adjust the playback volume.
- While your iPod/iPhone is inserted in the RI Dock, its volume control has no effect.
- If you do adjust the volume control on your iPod/iPhone while it's inserted in the RI Dock, be careful that it's not set too loud before you reconnect your headphones.



## Controlling Your iPod/iPhone

By pressing the **Remote Mode** button that's been programmed with the remote control code for your Dock, you can control your iPod/iPhone in the Dock with the buttons described further in this section.

See "Entering Remote Control Codes" for details on entering a remote control code (→ [page 75](#)).

See the Dock's instruction manual for more information.

### RI Dock

- Set the RI Dock's RI MODE switch to "HDD" or "HDD/DOCK".
- **Source** may not work with a remote control code (without **RI**). In this case, make an **RI** connection and enter the remote control code **81993** (with **RI**).

#### ■ With the RI Control

Make an **RI** connection and enter the remote control code **81993** (with **RI**).

- Set the AV receiver's Input Display to "DOCK" (→ [page 43](#)).

#### ■ Without the RI Control

You must enter the remote control code **82990** first (→ [page 76](#)).

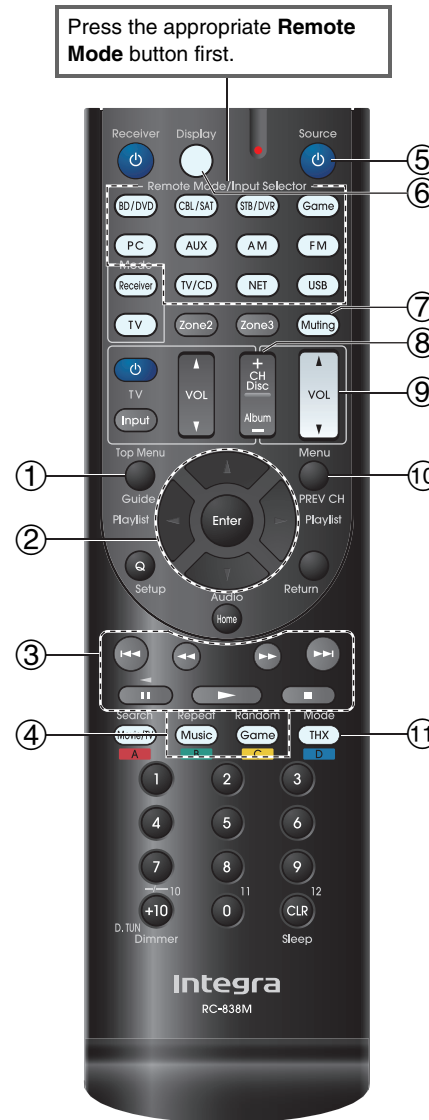

### ■ RI Dock operation

| Available buttons |                          |   |                       |
|-------------------|--------------------------|---|-----------------------|
| ①                 | Top Menu* <sup>1</sup>   | ⑤ | Source* <sup>2</sup>  |
| ②                 | ▲/▼/◀/▶, Enter           | ⑥ | Display* <sup>3</sup> |
|                   | Playlist ◀/▶             | ⑦ | Muting                |
| ③                 | ▶, II, ■, ◀◀, ▶▶, ◀◀, ▶▶ | ⑧ | Album +/-             |
|                   |                          | ⑨ | VOL ▲/▼               |
| ④                 | Repeat                   | ⑩ | Menu                  |
|                   | Random                   | ⑪ | Mode* <sup>4</sup>    |

- With some iPod/iPhone models, generations and RI Docks, certain buttons may not work as expected.
- For detailed operation of iPod/iPhone, please refer to the instruction manual of the RI Dock.

\*<sup>1</sup> **Top Menu** works as the mode button when used with the DS-A2 RI Dock.

\*<sup>2</sup> This button does not turn the Onkyo DS-A2 or DS-A2X RI Dock on or off. Also, your iPod/iPhone may not respond the first time you press this button, in which case you should press it again. This is because the remote controller transmits the On and Standby commands alternately, so if your iPod/iPhone is already on, it will remain on when the remote controller transmits the On command. Similarly, if your iPod/iPhone is already off, it will remain off when the remote controller transmits the Off command.

\*<sup>3</sup> **Display** turns on the backlight for a few seconds.

\*<sup>4</sup> **Resume mode**

With the Resume function, you can resume playback of the song that was playing when you removed your iPod/iPhone from the Onkyo DS-A2 RI Dock.

# Controlling Other Components

You can use the AV receiver's remote controller to control your other AV components. This section explains how to enter the remote control code for a component that you want to control: DVD, TV, CD, etc.

## Preprogrammed Remote Control Codes

The following **Remote Mode** buttons are preprogrammed with remote control codes for controlling the components listed. You do not need to enter a remote control code to control these components.

For details on controlling these components, see the indicated pages.

**BD/DVD** Integra/Onkyo Blu-ray Disc player  
(→ [page 77](#))

**TV/CD** Integra/Onkyo CD player (→ [page 76](#))

**STB/DVR** Apple TV

## Looking up for Remote Control Codes

You can look up for an appropriate remote control code from the on-screen menu.

### Note

- This can only be carried out using the on-screen menu.

- 1 Press Receiver followed by Home.**
- 2 Use ◀/▶ to select "Setup", and then press Enter.**
- 3 Use ▲/▼ to select "Remote Controller Setup", and then press Enter.**
- 4 Use ▲/▼ to select "Remote Mode Setup", and then press Enter.**
- 5 Use ▲/▼ to select a remote mode, and then press Enter.**  
The menu of category selection appears.
- 6 Use ▲/▼ to select a category, and then press Enter.**  
The keyboard screen for brand name input appears.
- 7 Use ▲/▼/◀/▶ to select a character, and then press Enter.**  
Repeat this step for the first three characters of the brand name.  
When you have entered the 3rd character, select **"Search"** and press **Enter**.  
A list of brand names is retrieved.  
**If the desired brand name is not found:**  
**Use ▶ to select "Not Listed", and then press Enter.**  
The keyboard screen for brand name input appears.
- 8 Use ▲/▼ to select a brand, and then press Enter.**  
A remote control code with its instructions are displayed. Follow the procedure.

- 9 If you can control the component, use ▲/▼ to select "OK", and then press Enter.**

The on-screen menu returns to the **"Remote Mode Setup"** front screen.

- If you cannot control the component, use ▲/▼ to select "Try Next Code" and press Enter.**

The next code is displayed.

## Entering Remote Control Codes

You'll need to enter a code for each component that you want to control.

### 1 Look up the appropriate remote control code in the separate Remote Control Codes list.

The codes are organized by category (e.g., DVD player, TV, etc.).

### 2 While holding down the Remote Mode button to which you want to assign a code, press and hold down Display (about 3 seconds).

The remote indicator lights.

#### Note

- Remote control codes cannot be entered for **Receiver** and the multi zone button.
- Only TV remote control codes can be entered for **TV**.
- Except for **Receiver**, **TV**, and the multi zone button, remote control codes from any category can be assigned for the **Remote Mode** buttons. However, these buttons also work as input selector buttons (→ page 22), so choose a **Remote Mode** button that corresponds with the input to which you connect your component. For example, if you connect your CD player to the CD input, choose **TV/CD** when entering its remote control code.

### 3 Within 30 seconds, use the number buttons to enter the 5-digit remote control code.

The remote indicator flashes twice.

If the remote control code is not entered successfully, the remote indicator will flash once slowly.

#### Note

- Though the provided remote control codes are correct at the time of release, they are subject to change.

## Remapping Colored Buttons

You can change the configuration of colored buttons, with which **Remote Mode** buttons are preset.

### 1 While holding down the Remote Mode button that you want to program, press and hold down A (Red) until the remote indicator lights (about 3 seconds).

You can only change colored buttons for components whose codes belong to categories of the Remote Control Codes list (BD/DVD player, TV, cable set-top box, etc).

### 2 Within 30 seconds, press the colored buttons in the order that you want to reassign them.

The button presses are assigned to each button from left to right. The remote indicator flashes twice, indicating that the sequence has been successfully assigned. If the sequence is not successfully assigned, the remote indicator will flash once slowly.

#### Tip

- To reset the **Remote Mode** buttons to their default settings, see "Resetting the Remote Mode Buttons" (→ page 76).

#### Note

- If any other button than the colored buttons is pressed, the operation will be cancelled.
- This operation cannot be done while the AV receiver is in Receiver mode or when Zone 2/3 is active.

## Remote Control Codes for Integra/Onkyo Components Connected via RI

Integra/Onkyo components that are connected via **RI** are controlled by pointing the remote controller at the AV receiver, not the component. This allows you to control components that are out of view, in a rack, for example.

- 1 Make sure the Integra/Onkyo component is connected with an RI cable and an analog audio cable (RCA).**  
See “Connecting Integra/Onkyo RI Components” for details (→ page 17).
- 2 Enter the appropriate remote control code for a Remote Mode button, by referring to the previous section.**
  - ▶ **42157:**  
Onkyo cassette tape deck with **RI**
  - ▶ **81993:**  
Onkyo Dock with **RI**
- 3 Press the Remote Mode button, point the remote controller at the AV receiver, and operate the component.**

### Controlling Integra/Onkyo components without RI

If you want to control an Integra/Onkyo component by pointing the remote controller directly at it, or you want to control an Integra/Onkyo component that’s not connected via **RI**, use the following remote control codes:

- ▶ **30627:**  
Integra/Onkyo DVD player without **RI**
- ▶ **71817:**  
Integra/Onkyo CD player without **RI**
- ▶ **32900/33100/33500:**  
Integra/Onkyo Blu-ray Disc player
- ▶ **32901/33104/33504:**  
Integra/Onkyo HD DVD player

- ▶ **70868:**  
Onkyo MD recorder without **RI**
- ▶ **71323:**  
Onkyo CD recorder without **RI**
- ▶ **82990:**  
Onkyo Dock without **RI**

## Resetting the Remote Mode Buttons

You can reset a **Remote Mode** button to its default remote control code.

- 1 While holding down the Remote Mode button that you want to reset, press and hold down Home until the remote indicator lights (about 3 seconds).**
- 2 Within 30 seconds, press the Remote Mode button again.**  
The remote indicator flashes twice, indicating that the button has been reset.  
Each **Remote Mode** button is preprogrammed with a remote control code. When a button is reset, its preprogrammed code is restored.

## Resetting the Remote Controller

You can reset the remote controller to its default settings.

- 1 While holding down Receiver, press and hold down Home until the remote indicator lights (about 3 seconds).**
- 2 Within 30 seconds, press Receiver again.**  
The remote indicator flashes twice, indicating that the remote controller has been reset.

## Controlling Other Components

By pressing the **Remote Mode** button that’s been programmed with the remote control code for your component, you can control your component as described below.

For details on entering a remote control code for other components, see “Entering Remote Control Codes” (→ page 75).

### Controlling a TV

**TV** is preprogrammed with the remote control code for controlling a TV that supports the **RIHD**\*1 (limited to some models). The TV must be able to receive remote control commands via **RIHD** and be connected to the AV receiver via HDMI. If controlling your TV via **RIHD** doesn’t work very well, program your TV’s remote control code into **TV** and use the TV remote mode to control your TV.

Use the following remote control codes:

- ▶ **11807/13100/13500:**  
TV with **RIHD**

### Controlling Apple TV

By programming the supplied remote controller with the appropriate remote control code, you can use it to operate your Apple TV.

Use the following remote control codes:

- ▶ **02615:**  
Apple TV

## Controlling MHL-Enabled Mobile Device

By programming the supplied remote controller with the appropriate remote control code, you can use it to operate your MHL-enabled mobile device.

Connect your MHL-enabled mobile device to the **AUX Input MHL** jack. We advise you to program the remote control code on the **AUX** button.

Use the following remote control codes:

(North American models)

▶ **33101:**

MHL-enabled mobile device

(Australian models)

▶ **32910:**

MHL-enabled mobile device

### Note

- With some mobile devices, reliable operation cannot be guaranteed.

## Controlling a Blu-ray Disc/DVD Player, HD DVD Player or DVD Recorder

**BD/DVD** is preprogrammed with the remote control code for controlling a component that supports the **RIHD**\*1 (limited to some models). The component must be able to receive remote control commands via **RIHD** and be connected to the AV receiver via HDMI.

Use the following remote control codes:

▶ **32910/33101/33501/31612:**

Blu-ray Disc/DVD player with **RIHD**

\*1 The **RIHD** supported by the AV receiver is the CEC system control function of the HDMI standard.

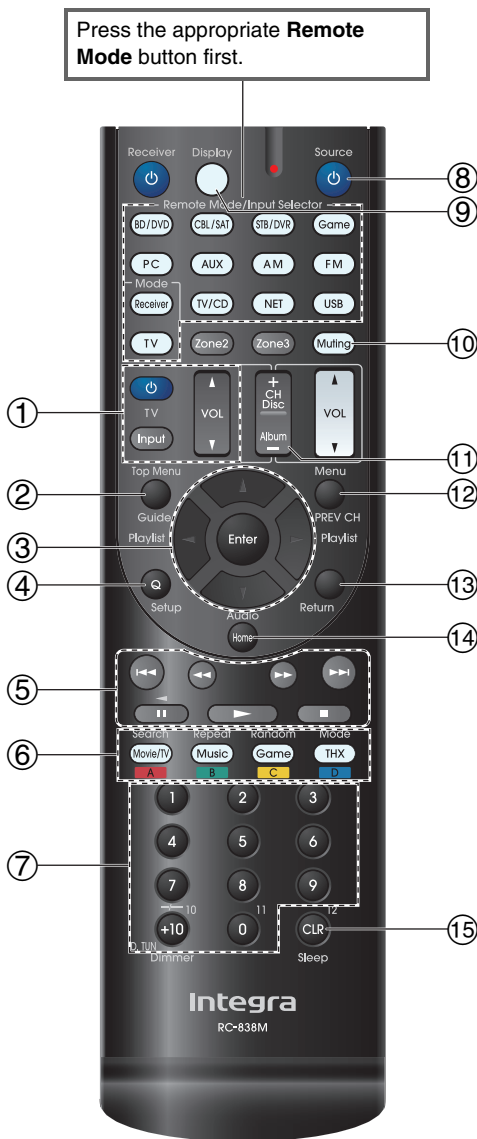

## TV operation

### Available buttons

|   |                           |   |                   |
|---|---------------------------|---|-------------------|
| ① | Power, Input, TV VOL ▲/▼  | ⑦ | Number: 1 to 9, 0 |
| ② | Guide                     | ⑧ | Number: +10*1     |
| ③ | ▲/▼/◀/▶                   | ⑨ | Display           |
| ④ | Enter                     | ⑩ | Muting            |
| ⑤ | Setup                     | ⑪ | CH +/-            |
| ⑥ | ▶, II, ■, ◀, ▶▶, ◀◀, ▶▶*1 | ⑫ | PREV CH           |
|   |                           | ⑬ | Return            |
|   | A (Red)*1                 | ⑭ | Audio*1           |
|   | B (Green)*1               | ⑮ | CLR               |
|   | C (Yellow)*1              |   |                   |
|   | D (Blue)*1                |   |                   |

## Blu-ray Disc player / HD DVD player operation

### Available buttons

|   |                           |   |              |
|---|---------------------------|---|--------------|
| ② | Top Menu                  | ⑧ | Power/Source |
| ③ | ▲/▼/◀/▶                   | ⑨ | Display      |
| ④ | Enter                     | ⑩ | Muting       |
| ⑤ | Setup                     | ⑪ | CH +/-       |
| ⑥ | ▶, II, ■, ◀, ▶▶, ◀◀, ▶▶*1 | ⑫ | Disc +/-     |
|   | A (Red)                   | ⑬ | Menu         |
|   | B (Green)                 | ⑭ | Return       |
|   | C (Yellow)                | ⑮ | Audio*1      |
|   | D (Blue)                  |   | CLR          |
| ⑦ | Number: 1 to 9, 0         |   |              |
|   | Number: +10*1             |   |              |

Press the appropriate **Remote Mode** button first.

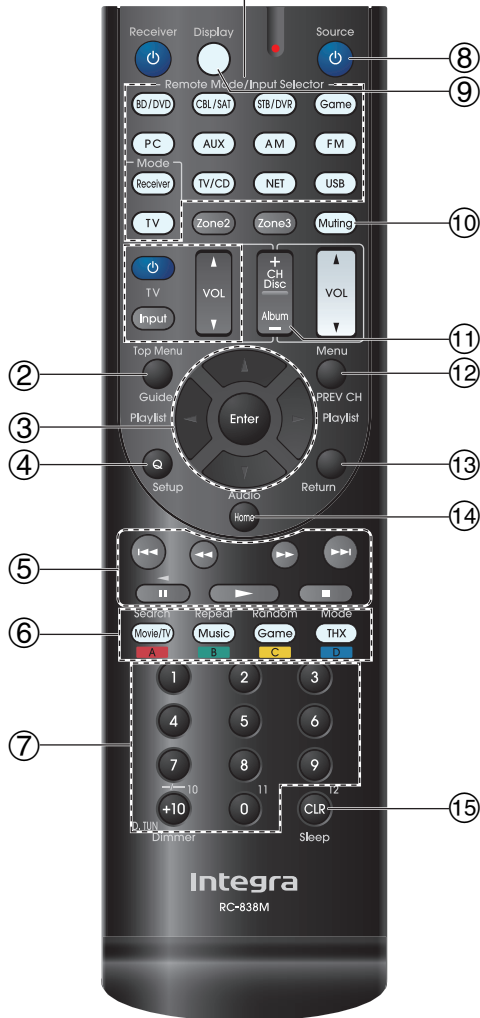

### ■ DVD player / DVD recorder operation

| Available buttons   |  |
|---|--|
| ② Top Menu  | ⑧ $\phi$ Source                                      |
| ③ $\blacktriangle/\blacktriangledown/\blacktriangleleft/\blacktriangleright$<br>Enter   | ⑨ Display  |
| ④ Setup   | ⑩ Muting   |
| ⑤ $\blacktriangleright$ , $\blacksquare$ , $\blacktriangleleft$ , $\blacktriangleright$ ,<br>$\blacktriangleleft$ , $\blacktriangleright$ | ⑪ CH +/-   |
| ⑥ A (Red)*1<br>B (Green)<br>C (Yellow)*1<br>D (Blue)*1  | ⑫ Disc +/-<br>⑬ Menu<br>⑭ Return<br>⑮ Audio*1<br>CLR |
| ⑦ Number: 1 to 9, 0<br>Number: +10*1  |  |

### ■ VCR/PVR operation

| Available buttons   |                                |
|---|--------------------------------|
| ② Guide   | ⑧ $\phi$ Source                |
| ③ $\blacktriangle/\blacktriangledown/\blacktriangleleft/\blacktriangleright$<br>Enter   | ⑨ Display                      |
| ④ Setup   | ⑩ Muting                       |
| ⑤ $\blacktriangleright$ , $\blacksquare$ , $\blacktriangleleft$ , $\blacktriangleright$ ,<br>$\blacktriangleleft$ , $\blacktriangleright$ | ⑪ CH +/-                       |
| ⑥ Number: 1 to 9, 0<br>Number: +10  | ⑫ PREV CH<br>⑬ Return<br>⑮ CLR |

### ■ Cassette tape deck operation

| Available buttons  |                             |
|--|-----------------------------|
| ⑤ $\blacktriangleright$ , $\blacktriangleleft$ (Reverse Playback), $\blacksquare$ , $\blacktriangleleft$ , $\blacktriangleright$ ,<br>$\blacktriangleleft$ , $\blacktriangleright$ | ⑧ $\phi$ Source<br>⑩ Muting |

### ■ Satellite receiver / Cable receiver operation

| Available buttons   |   |
|---|---|
| ② Guide   | ⑦ Number: 1 to 9, 0<br>Number: +10        |
| ③ $\blacktriangle/\blacktriangledown/\blacktriangleleft/\blacktriangleright$<br>Enter   | ⑧ $\phi$ Source                           |
| ④ Setup   | ⑨ Display                                 |
| ⑤ $\blacktriangleright$ , $\blacksquare$ , $\blacktriangleleft$ , $\blacktriangleright$ ,<br>$\blacktriangleleft$ , $\blacktriangleright$ | ⑩ Muting<br>⑪ CH +/-                      |
| ⑥ A (Red)<br>B (Green)<br>C (Yellow)<br>D (Blue)  | ⑫ PREV CH<br>⑬ Return<br>⑭ Audio<br>⑮ CLR |

### ■ CD player / CD recorder / MD recorder operation

| Available buttons   |                                    |
|---|------------------------------------|
| ③ $\blacktriangle/\blacktriangledown/\blacktriangleleft/\blacktriangleright$<br>Enter   | ⑦ Number: 1 to 9, 0<br>Number: +10 |
| ④ Setup   | ⑧ $\phi$ Source                    |
| ⑤ $\blacktriangleright$ , $\blacksquare$ , $\blacktriangleleft$ , $\blacktriangleright$ ,<br>$\blacktriangleleft$ , $\blacktriangleright$ | ⑨ Display<br>⑩ Muting              |
| ⑥ Search<br>Repeat<br>Random<br>Mode  | ⑪ Disc +/-<br>⑮ CLR                |

#### Note

- With some components, certain buttons may not work as expected, and some may not work at all.
- See “Controlling Your iPod/iPhone” about the operation of iPod/iPhone (→ [page 73](#)).

\*1 The **RIHD** function is not supported. The **RIHD** supported by the AV receiver is the CEC system control function of the HDMI standard.

# Troubleshooting

If you have any trouble using the AV receiver, look for a solution in this section. If you can't resolve the issue yourself, contact the dealer from whom you purchased this unit.

If you can't resolve the issue yourself, try resetting the AV receiver before contacting the dealer from whom you purchased this unit.

**To reset the AV receiver to its factory defaults, turn it on and, while holding down CBL/SAT, press On/Standby. "Clear" will appear on the AV receiver's display and the AV receiver will enter standby mode.**



Note that resetting the AV receiver will delete your radio presets and custom settings.

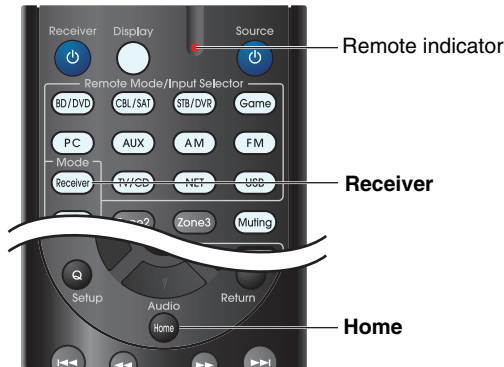

To reset the remote controller to its factory defaults, while holding down **Receiver**, press and hold down **Home** until the remote indicator lights (about 3 seconds). Within 30 seconds, press **Receiver** again.

**The on-screen menus appear only on a TV that is connected to HDMI OUT MAIN. If your TV is connected to other video outputs, use the AV receiver's display when changing settings.**

## Power

### Can't turn on the AV receiver

Make sure that the power cord is properly plugged into the wall outlet. —

Unplug the power cord from the wall outlet, wait five seconds or more, then plug it in again. —

### The AV receiver turns off unexpectedly

The AV receiver will automatically enter standby mode when Auto Standby has been set and launches. **66**

### The AV receiver turns off and after restoring the power, it turns off again

The protection circuit has been activated. Remove the power cord from the wall outlet immediately. Make sure that all speaker cables and input sources are properly connected, and leave the AV receiver with its power cord disconnected for 1 hour. After that, reconnect the power cord and turn the power on. If the AV receiver turns off again, unplug the power cord and contact the dealer from whom you purchased this unit. **12**

Caution: If "CHECK SP WIRE" appears on the AV receiver's display, the speaker cables may be shorting.

## WARNING

If smoke, smell or abnormal noise is produced by the AV receiver, unplug the power cord from the wall outlet immediately and contact the dealer from whom you purchased this unit.

## Audio

### There's no sound, or it's very quiet

Make sure that the digital input source is selected properly. **52**

Make sure that all audio connecting plugs are pushed in all the way. **14**

Make sure that the inputs and outputs of all components are connected properly. **15-17**

Make sure that the polarity of the speaker cables is correct, and that the bare wires are in contact with the metal part of each speaker terminal. **12**

Make sure that the input source is properly selected. **22**

Make sure that the speaker cables are not shorting. **12**

Check the volume. The AV receiver is designed for home theater enjoyment. It has a wide volume range, allowing precise adjustment. —

If the **MUTING** indicator is flashing on the AV receiver's display, press the remote controller's **Muting** button to unmute the AV receiver. **44**

When a pair of headphones is connected to the **Phones** jack, no sound is output from the speakers. **44**

If there's no sound from a DVD player connected to an **HDMI IN**, check the DVD player's output settings, and be sure to select a supported audio format. —

Check the digital audio output setting on the connected device. On some game consoles, such as those that support DVD, the default setting is off. —

With some DVD-Video discs, you need to select an audio output format from a menu. —

If your turntable uses an MC cartridge, you must connect an MC head amp, or an MC transformer. —

Make sure that none of the connecting cables are bent, twisted, or damaged. —

Not all listening modes use all speakers. **35**

Specify the speaker distances and adjust the individual speaker levels. **53**

Make sure that the speaker setup microphone is not still connected. —

- If the input signal format is set to “PCM” or “DTS”. **61**  
Set it to “Off”.
- **Only the front speakers produce sound**
- When the Stereo or Mono listening mode is selected, **38**  
only the front speakers and subwoofer produce  
sound.
- In the Mono listening mode, only the front speakers **55**  
output sound if the “Output Speaker” setting is set  
to “Left / Right”.
- Check the Speaker Configuration. **52**
- **Only the center speaker produces sound**
- If you use the Dolby Pro Logic IIx Movie, Dolby Pro **—**  
Logic IIx Music, or Dolby Pro Logic IIx Game  
listening mode with a mono source, such as an AM  
radio station or mono TV program, the sound is  
concentrated in the center speaker.
- In the Mono listening mode, only the center speaker **55**  
output sound if the “Output Speaker” setting is set  
to “Center”.
- Make sure the speakers are configured correctly. **52**
- **The surround speakers produce no sound**
- When the T-D (Theater-Dimensional), Stereo or **—**  
Mono listening mode is selected, the surround  
speakers produce no sound.
- Depending on the source and current listening mode, **35**  
not much sound may be produced by the surround  
speakers. Try selecting another listening mode.
- Make sure the speakers are configured correctly. **52**
- **The center speaker produces no sound**
- When the Stereo or Mono listening mode is selected, **—**  
the center speaker produces no sound.
- In the Mono listening mode, only the front speakers **55**  
output sound if the “Output Speaker” setting is set  
to “Left / Right”.
- Make sure the speakers are configured correctly. **52**
- **The front high and surround back speakers produce no sound**
- Depending on the current listening mode, no sound **36**  
may be produced by the front high and surround back  
speakers. Select another listening mode.
- Depending on the sources, the sound produced by the **—**  
front high and surround back speakers may be weak.
- Make sure the speakers are configured correctly. **52**
- When Powered Zone 2 is used, playback in the main **—**  
room is reduced to 5.1 channels and the front high and  
surround back speakers produce no sound.
- **The subwoofer produces no sound**
- When you play source material that contains no **—**  
information in the LFE channel, the subwoofer  
produces no sound.
- Make sure the speakers are configured correctly. **52**
- **There’s no sound with a certain signal format**
- Check the digital audio output setting on the **—**  
connected device. On some game consoles, such as  
those that support DVD, the default setting is off.
- With some DVD-Video discs, you need to select an **—**  
audio output format from a menu.
- Depending on the input signal, some listening modes **35-41**  
cannot be selected.
- **Can’t get 6.1/7.1 playback**
- If no surround back speakers and front high speakers **—**  
are connected, or the Zone 2 speakers are being used,  
6.1/7.1 playback is not possible.
- Depending on the number of connected speakers, it is **35-41**  
not always possible to select all of the listening  
modes.
- **The speaker volume cannot be set as required**
- Check to see if a maximum volume has been set. **62**
- If the volume level of each individual speaker has **32, 54**  
been adjusted to high positive values, then the  
maximum master volume possible may be reduced.  
Note that the individual speaker volume levels are set  
automatically after the Audyssey 2EQ® Room  
Correction and Speaker Setup has been performed.
- **Noise can be heard**
- Using cable ties to bundle audio cables with power **—**  
cords, speaker cables, and the like may degrade the  
audio performance, so refrain from doing it.
- An audio cable may be picking up interference. Try **—**  
repositioning your cables.
- **The Late Night function doesn’t work**
- Make sure the source material is Dolby Digital, **47**  
Dolby Digital Plus, and Dolby TrueHD.
- Make sure that the “TrueHD Loudness **56**  
Management” setting is not set to “Off”. The Late  
Night function doesn’t work when this setting is  
disabled.
- **About DTS signals**
- When DTS program material ends and the DTS **—**  
bitstream stops, the AV receiver remains in DTS  
listening mode and the **dts** indicator remains on. This  
is to prevent noise when you use the pause, fast  
forward, or fast reverse function on your player. If  
you switch your player from DTS to PCM, you may  
not hear any sound because the AV receiver does not  
switch formats immediately. In such case, you should  
stop your player for about three seconds and then  
resume playback.
- With some CD and LD players, you won’t be able to **—**  
playback DTS material properly even though your  
player is connected to a digital input on the AV  
receiver. This is usually because the DTS bitstream  
has been processed (e.g., output level, sampling rate,  
or frequency response changed) and the AV receiver  
doesn’t recognize it as a genuine DTS signal. In such  
cases, you may hear noise.



Playing DTS program material, using the pause, fast forward, or fast reverse function on your player may produce a short audible noise. This is not a malfunction.

### ■ The beginning of audio received by an HDMI IN can't be heard

Since it takes longer to identify the format of an HDMI signal than it does for other digital audio signals, audio output may not start immediately.

### ■ There's no sound during Whole House Mode

Make sure you've selected an analog audio input. **52**

## Video

### ■ There's no picture

Make sure that all video connecting plugs are pushed in all the way. **14**

Make sure that each video component is properly connected. **15, 16**

If your TV is connected to the HDMI output(s), select “- - - -” in the “**HDMI Input**” setting to watch composite video, and component video sources. **50**

If the video source is connected to a component video input, you must assign that input to an input selector, and your TV must be connected to either the HDMI output(s) or **COMPONENT VIDEO OUT**. **16, 51**

If the video source is connected to a composite video input, your TV must be connected to the HDMI output(s) or the corresponding composite video output. **16**

If the video source is connected to an HDMI input, you must assign that input to an input selector, and your TV must be connected to the HDMI output(s). **15, 50**

On your TV, make sure that the video input to which the AV receiver is connected is selected.

### ■ There's no picture from a source connected to an HDMI IN

Reliable operation with an HDMI-to-DVI adapter is not guaranteed. In addition, video signals from a PC are not guaranteed. **94**

When the resolution is set to any resolution not supported by the TV, no video is output from the HDMI outputs. **50**

If the message “**Resolution Error**” appears on the AV receiver's display, this indicates that your TV does not support the current video resolution and you need to select another resolution on your DVD player.

### ■ The on-screen menus don't appear

On your TV, make sure that the video input to which the AV receiver is connected is selected.

When the AV receiver is not connected to a TV via **HDMI OUT MAIN**, on-screen menus are not displayed.

### ■ The on-screen display does not appear

Depending on the input signal, the on screen display may not appear when the input signal from **HDMI IN** is output to a device connected to **HDMI OUT MAIN**. **45**

## Tuner

### ■ Reception is noisy, FM stereo reception is noisy, or the FM STEREO indicator doesn't light

Relocate your antenna. —

Move the AV receiver away from your TV or computer. —

Listen to the station in mono. **29**

When listening to an AM station, operating the remote controller may cause noise. —

Passing cars and airplanes can cause interference. —

Concrete walls weaken radio signals. —

If nothing improves the reception, install an outdoor antenna. —

## Remote Controller

### ■ The remote controller doesn't work

Before operating this unit, be sure to press **Receiver**. —

Make sure that the batteries are installed with the correct polarity. **4**

Install new batteries. Don't mix different types of batteries, or old and new batteries. **4**

Make sure that the remote controller is not too far away from the AV receiver, and that there's no obstruction between the remote controller and the AV receiver's remote control sensor. **4**

Make sure that the AV receiver is not subjected to direct sunshine or inverter-type fluorescent lights. Relocate if necessary. —

If the AV receiver is installed in a rack or cabinet with colored-glass doors, the remote controller may not work reliably when the doors are closed. —

Make sure you've selected the correct remote controller mode. **10, 76**

When using the remote controller to control other manufacturers' AV components, some buttons may not work as expected. —

Make sure you've entered the correct remote control code. **75**

Make sure to set the same ID on both the AV receiver and remote controller. **67**

### ■ Can't control other components

If it's an Integra/Onkyo component, make sure that the **RI** cable and analog audio cable are connected properly. Connecting only an **RI** cable won't be enough. **17**

Make sure you've selected the correct remote controller mode. **10, 76**

If you've connected an cassette tape deck to the **TV/CD IN** jack, or an RI Dock to the **TV/CD IN** or **GAME IN** jacks, for the remote controller to work properly, you must set the input display appropriately. **43**

If you cannot operate it, you will need to enter the appropriate remote control code. **74**

To control another manufacturer's component, point the remote controller at that component. **75**

To control an Integra/Onkyo component that's connected via **RI**, point the remote controller at the AV receiver. Be sure to enter the appropriate remote control code first. **76**

To control an Integra/Onkyo component that's not connected via **RI**, point the remote controller at the component. Be sure to enter the appropriate remote control code first. **76**

The entered remote control code may not be correct. If more than one code is listed, try each one. —

## RI Dock for iPod/iPhone

### There's no sound

Make sure your iPod/iPhone is actually playing. —

Make sure your iPod/iPhone is properly inserted in the Dock. —

Make sure the AV receiver is turned on, the correct input source is selected, and the volume is turned up. —

Make sure the plugs are pushed in all the way. —

Try resetting your iPod/iPhone. —

### There's no video

Make sure that your iPod/iPhone model's TV OUT setting is set to On. —

Make sure the correct input is selected on your TV or the AV receiver. —

Some versions of the iPod/iPhone do not output video. —

### The AV receiver's remote controller doesn't control my iPod/iPhone

Make sure your iPod/iPhone is properly inserted in the Dock. If your iPod/iPhone is in a case, it may not connect properly to the Dock. Always remove your iPod/iPhone from the case before inserting it into the Dock. —

The iPod/iPhone cannot be operated while it's displaying the Apple logo. —

Make sure you've selected the right remote mode. **73**

When you use the AV receiver's remote controller, point it toward your AV receiver. —

If you still can't control your iPod/iPhone, start playback by pressing your iPod/iPhone model's Play button. Remote operation should then be possible. —

Try resetting your iPod/iPhone. —

Depending on your iPod/iPhone, some buttons may not work as expected. —

### The AV receiver unexpectedly selects my iPod/iPhone as the input source

Always pause iPod/iPhone playback before selecting a different input source. If playback is not paused, the Direct Change function may select your iPod/iPhone as the input source by mistake during the transition between tracks. —

### iPod/iPhone doesn't work properly

Try reconnecting your iPod/iPhone. —

## Zone 2/3

### There's no sound

Only components connected to analog inputs can be played in Zone 2/3. —

### The Zone 2 speakers produce no sound

Powered Zone 2 cannot be used if "Speakers Type (Front)" is set to "Bi-Amp". **52**

## Music Server and Internet Radio

### Can't access the server or Internet radio

Check the network connection between the AV receiver and your router or switch. **95**

Make sure that your modem and router are properly connected, and make sure they are both turned on. —

Make sure the server is up and running and compatible with the AV receiver. **96**

Check the "Network" settings. **66**

### Playback stops while listening to music files on the server

Make sure your server is compatible with the AV receiver. **96**

If you download or copy large files on your computer, playback may be interrupted. Try closing any unused programs, use a more powerful computer, or use a dedicated server. —

If the server is serving large music files to several networked devices simultaneously, the network may become overloaded and playback may be interrupted. Reduce the number of playback devices on the network, upgrade your network, or use a switch instead of a hub. —

### Can't connect to the AV receiver from a Web browser

If you're using DHCP, your router may not always allocate the same IP address to the AV receiver, so if you find that you can't connect to a server or Internet radio station, recheck the AV receiver's IP address on the "Network" screen. **66**

Check the "Network" settings. **66**

## USB Device Playback

### ■ Can't access the music files on a USB device

- Make sure the USB device is plugged in properly. —
- The AV receiver supports USB devices that support the USB mass storage device class. However, playback may not be possible with some USB devices even if they conform to the USB mass storage device class. **96**
- USB memory devices with security functions cannot be played. —

## Others

### ■ Standby power consumption

- In the following cases, the power consumption in standby mode may reach up to a maximum of 8.3 W: **64, 66**
- The “**HDMI Control(RIHD)**” setting is set to “**On**”. (Depending on the TV status, the AV receiver will enter standby mode as usual.)
  - The “**HDMI Through**” setting is set to other than “**Off**”.
  - The “**Network Standby**” setting is set to “**On**”.
- If an MHL-enabled mobile device is connected to the AUX (front) input, the power consumption in standby mode will increase. **15**

### ■ The sound changes when I connect my headphones

- When a pair of headphones is connected, the listening mode is set to Stereo, unless it's already set to Stereo, Mono or Direct. —

### ■ The speaker distance cannot be set as required

- The values entered may be automatically adjusted with values best-suited for your home theater. —

### ■ How do I change the language of a multiplex source

- Use the “**Multiplex**” setting in the “**Audio Adjust**” menu to select “**Main**” or “**Sub**”. **55**

### ■ The RI functions don't work

- To use **RI**, you must make an **RI** connection and an analog audio connection (RCA) between the component and AV receiver, even if they are connected digitally. **17**
- While Zone 2/3 is selected, the **RI** functions don't work. **17**

### ■ The functions System On/Auto Power On and Direct Change don't work for components connected via RI

- These functions don't work when Zone 2/3 is turned on. **17**

### ■ When performing Automatic Speaker Setup, the measurement fails and the message “Ambient noise is too high.” is displayed.

- This can be caused by a malfunction in your speaker unit. Check if the unit produces normal sounds. —

### ■ The following setting can be made for composite video inputs

#### • Video Attenuation

- If you have a game console connected to the composite video input, and the picture isn't very clear, you can attenuate the gain.

**Video ATT :Off:** (default).

**Video ATT :On:** Gain is reduced by 2 dB.

To make this setting, you must use the buttons on the AV receiver.

Press the input selector button for the source that you want to set, simultaneously with **Setup**. Note that the input selector must be assigned to a composite video input. While holding down the input selector button,

press **Setup** until “**Video ATT :On**” appears on the AV receiver's display. Then, release both buttons. To turn the setting off, repeat the above process so that “**Video ATT :Off**” appears on the AV receiver's display, and release the buttons.

### ■ If the picture on your TV/monitor connected to the HDMI output(s) is unstable, try switching the DeepColor function off

To turn off the DeepColor function, simultaneously press the **STB/DVR** and **On/Standby** buttons on the AV receiver. While holding down **STB/DVR**, press **On/Standby** until “**Deep Color:Off**” appears on the AV receiver's display. Then, release both buttons. To reactivate the DeepColor function, repeat the above process until “**Deep Color:On**” appears on the AV receiver's display and release the buttons.

The AV receiver contains a microcomputer for signal processing and control functions. In very rare situations, severe interference, noise from an external source, or static electricity may cause it to lockup. In the unlikely event that this happens, unplug the power cord from the wall outlet, wait at least five seconds, and then plug it back in.

Onkyo is not responsible for damages (such as CD rental fees) due to unsuccessful recordings caused by the unit's malfunction. Before you record important data, make sure that the material will be recorded correctly.

Before disconnecting the power cord from the wall outlet, set the AV receiver to standby.

### Important Note Regarding Video Playback

The AV receiver can upconvert component video and composite video sources for display on a TV connected to the HDMI output(s). However, if the picture quality of the source is poor, upconversion may make the picture worse or disappear altogether.

In this case, try the following:

**1 If the video source is connected to a component video input, connect your TV to **COMPONENT VIDEO OUT**.**

If the video source is connected to a composite video input, connect your TV to **MONITOR OUT V**.

**2 On the main menu, select “Input/Output Assign”, and then select “Component Video Input” (→ page 51).**

If the video source is connected to **COMPONENT VIDEO IN 1**, select the relevant input selector, and assign it to “**IN1**”.

If the video source is connected to **COMPONENT VIDEO IN 2**, select the relevant input selector, and assign it to “**IN2**”.

If the video source is connected to a composite video input, select the relevant input selector, and assign it to “**- - - - -**”.

#### Tip

- To by-pass the upconversion, set the “**Picture Mode**” setting to “**Direct**” (→ page 60).

# Firmware Update

To update the firmware of the AV receiver, you can choose from the following two methods: update via network, or update via USB storage. Choose the one that best suits your environment. Before proceeding with the update, please read the corresponding explanations carefully.

## ■ Update via network

You need a wired Internet connection to update the firmware.

## ■ Update via USB storage (→ page 87)

Please prepare a USB storage device such as a USB flash memory stick. You need at least 32 MB of available space to update the firmware.

### Note

- Check the network connection before updating.
- Do not touch any cable or device connected to the AV receiver during the update process.
- Do not attempt to access the AV receiver from your PC while it is being updated.
- Do not shutdown the power of the AV receiver while it is being updated.
- The storage media in the USB card reader may not work.
- If the USB device is partitioned, each section will be treated as an independent device.
- If the USB device contains a lot of data, the AV receiver may take a while to read it.
- Operation is not guaranteed for all USB devices, which includes the ability to power them.
- Onkyo takes no responsibility whatsoever for the loss or damage of data resulting from the use of a USB device with the AV receiver. Onkyo recommends that you back up your important music files beforehand.
- If you connect a USB hard disk drive to the USB port, Onkyo recommends that you use its AC adapter to power it.
- USB hubs and USB devices with hub functions are not supported. Do not connect your USB device via a USB hub.
- USB devices with security functions are not supported.

### Limitation of liability

The program and accompanying online documentation are furnished to you for use at your own risk. Onkyo will not be liable and you will have no remedy for damages for any claim of any kind whatsoever concerning your use of the program or the accompanying online documentation, regardless of legal theory, and whether arising in tort or contract. In no event will Onkyo be liable to you or any third party for any special, indirect, incidental, or consequential damages of any kind, including, but not limited to, compensation, reimbursement or damages on account of the loss of present or prospective profits, loss of data, or for any other reason whatsoever.

**See the Integra web site for latest information.**

## Updating the Firmware via Network

The AV receiver allows you to update the firmware using network connection on the rear panel.

### Note

- Make sure your AV receiver and TV are turned on and an Ethernet cable is connected to the rear panel of the AV receiver.
- Never unplug or turn off the AV receiver while it is being updated.
- Never plug or unplug an HDMI or Ethernet cable during the update process.
- Do not attempt to access the AV receiver from your PC while it is being updated.
- Never unplug the power cord during the update process.
- It takes up to 60 minutes to complete the firmware update.
- The AV receiver will retain all your settings after the update is finished.

## Before Starting

- Set the “**HDMI Control(RIHD)**” setting to “**Off**” (→ page 64).
- Turn off the controller device connected via RS232 and Ethernet cable.
- Turn off Multi Zone if this function is present.
- Stop playback of contents from Internet Radio, iPod/iPhone, USB or servers, etc.

↳ **To be continued**

## Update Procedure

### 1 Press **Receiver** followed by **Home** on the remote controller.

The Home menu appears on the TV screen.

### 2 Select **“Firmware Update”** and press **ENTER**.

Note that the **“Firmware Update”** option will be grayed out for a short while after the AV receiver is turned on. Please wait until it becomes operable.

### 3 Select **“Update via NET”** and press **ENTER**.

Note that this option will not be available if there is no firmware file newer than the currently installed version.

### 4 Select **“Update”** and press **ENTER**.

The update process will begin.

During the update process, the on-screen display may disappear depending on the updated program. When this occurs, you can still view the update progress on the AV receiver’s display. The on-screen display will reappear after the update is complete, and upon turning the AV receiver off and on again.

### 5 The message **“Completed!”** appears on the AV receiver’s display, indicating that the update has been completed.

### 6 Turn off the AV receiver using **⏻On/Standby** on the front panel.

Do not use **⏻RECEIVER** on the remote controller. Once turned off, the AV receiver will automatically turn on again.

Congratulations! You now have the latest firmware installed on your Integra AV receiver.

## Troubleshooting

### Case 1:

If an error occurs, **“Error!! \*.\*”** is displayed on the AV receiver’s display. (Alpha-numeric characters on the front display are denoted by asterisks.) Refer to the following table and take appropriate action.

### ■ Errors during an update via network

| Error Code             | Description  |
|------------------------|--|
| *-10, *-20             | The Ethernet cable was not detected. Reconnect the cable properly.   |
| *-11, *-13, *-21, *-28 | Internet connection error. Check the following items: <ul style="list-style-type: none"> <li>• Make sure the IP address, subnet mask, gateway address, and DNS server are configured properly.</li> <li>• Make sure the router is turned on.</li> <li>• Make sure the AV receiver and the router are connected with an Ethernet cable.</li> <li>• Make sure your router is configured properly. See the instruction manual of the router.</li> <li>• If your network allows only one client connection and there is any other device already connected, the AV receiver will not be able to access the network. Consult your Internet Service Provider (ISP).</li> <li>• If your modem does not function as a router, you will need a router. Depending on your network, you may need to configure the proxy server if necessary. See the document provided by your ISP. If you are still unable to access the Internet, the DNS or proxy server may be temporarily down. Contact your ISP.</li> </ul> |
| Others                 | Retry the update procedure from the beginning. If the error persists, please contact Integra Support (→ <b>page 88</b> ) and provide the error code.   |

### Case 2:

If an error occurs during the update process, disconnect then reconnect the AC power cord and try again.

### Case 3:

If you do not have an Internet connection to the network, please contact Integra Support (→ **page 88**).

## Updating the Firmware via USB

The AV receiver allows you to update the firmware using a USB device.

### Note

- Never unplug or turn off the AV receiver during the update process.
- Never plug or unplug an HDMI cable or a USB device during the update process.
- Never unplug the USB storage device containing the firmware file or the AC power cord during the update process.
- Do not attempt to access the AV receiver from your PC while it is being updated.
- It takes up to 60 minutes to complete the firmware update.
- The AV receiver will retain all your settings after the update is finished.

### Before Starting

- Set the “**HDMI Control(RIHD)**” setting to “**Off**” (→ **page 64**).
- Turn off the controller device connected via RS232 and Ethernet cable.
- Turn off Multi Zone if this function is present.
- Stop playback of contents from Internet Radio, iPod/iPhone, USB or servers, etc.
- If there is any data in the USB device, remove it first.

## Update Procedure

- 1 Connect a USB device to your PC. If there is any data in the USB device, remove it first.**
- 2 Download the firmware file from the Integra web site. The file name is as follows:**  
**ONKA VR\*\*\*\*\_\*\*\*\*\*.zip**  
**Unzip the downloaded file. The following three files are created:**  
**ONKA VR\*\*\*\*\_\*\*\*\*\*.of1**  
**ONKA VR\*\*\*\*\_\*\*\*\*\*.of2**  
**ONKA VR\*\*\*\*\_\*\*\*\*\*.of3**
- 3 Copy the extracted files to the USB device. Be careful not to copy the zip file.**
- 4 Remove the USB device from your PC and connect it to the USB port on the AV receiver.**  
 When the AV receiver has two USB ports, you can use either one.
- 5 Make sure the AV receiver and TV are turned on.**  
 If the AV receiver is in standby mode, press **⏻On/Standby** on the AV receiver to light up the front display.
- 6 Select the USB input source.**  
 “**Now Initializing...**” appears on the AV receiver’s display and then the name of the USB device is displayed. It takes 20 to 30 seconds to recognize the USB device.
- 7 Press Receiver followed by Home on the remote controller.**  
 The Home menu appears on the TV screen.
- 8 Select “Firmware Update” and press ENTER.**
- 9 Select “Update via USB” and press ENTER.**  
 Note that this option will not be available if there is no firmware file newer than the currently installed version.

- 10 Select “Update” and press ENTER.**

The update process will begin.

During the update process, the on-screen display may disappear depending on the updated program. When this occurs, you can still view the update progress on the AV receiver’s display. The on-screen display will reappear after the update is complete, and upon turning the AV receiver off and on again.

Do not turn off the AV receiver and do not remove the USB device during the update process.

- 11 The message “Completed!” appears on the AV receiver’s display, indicating that the update has been completed.**

**Remove the USB device.**

- 12 Turn off the AV receiver using **⏻On/Standby** on the front panel.**

Do not use **⏻RECEIVER** on the remote controller. Once turned off, the AV receiver will automatically turn on again.

Congratulations! You now have the latest firmware installed on your Integra AV receiver.

## Troubleshooting

---

### Case 1:

If an error occurs, “**Error!! \*-\*\***” is displayed on the AV receiver’s display. (Alpha-numeric characters on the front display are denoted by asterisks.) Refer to the following table and take appropriate action.

#### ■ Errors during an update via USB

| Error Code | Description   |
|------------|---|
| *-10, *-20 | The USB device was not detected. Make sure the USB flash memory or USB cable is properly connected to the USB port. If the USB storage device has its own power supply, use it to power the USB device.   |
| *-14       | The firmware file was not found in the root folder of the USB device, or the firmware file is for another model. Retry and download the file on the support page of the web site, following the on-site instructions. If the error persists, please contact Integra Support and provide the error code. |
| Others     | Retry the update procedure from the beginning. If the error persists, please contact Integra Support and provide the error code.  |

### Case 2:

If an error occurs during the update process, disconnect then reconnect the AC power cord and try again.

---

#### The Americas

Integra Division of  
**Onkyo U.S.A. Corporation**  
 18 Park Way, Upper Saddle River, N.J. 07458, U.S.A.  
 Tel: 800-225-1946, 201-818-9200  
 Fax: 201-785-2650  
 Hours: M-F 9am-8pm/Sat-Sun 10am-8pm ET  
<http://www.integrahometheater.com>

#### Europe

Integra Division of  
**Onkyo Europe Electronics GmbH**  
 Liegnitzerstrasse 6, 82194 Groebenzell, GERMANY  
 Tel: +49-8142-4401-0 Fax: +49-8142-4401-555  
<http://www.integra.eu>

#### China

Integra Division of  
**Onkyo China PRC**  
 1301, 555 Tower, No.555 West NanJin Road, Jin an,  
 Shanghai, China 200041  
 Tel: 86-21-52131366 Fax: 86-21-52130396  
<http://www.integra.com.cn>

#### Asia, Oceania, Middle East, Africa

Please contact an Integra distributor referring to  
 Integra Worldwide web site.  
<http://www.integraworldwide.com>

Integra Division of  
**Onkyo Sound & Vision Corporation**  
 2-1, Nisshin-cho, Neyagawa-shi, OSAKA 572-8540, JAPAN  
<http://www.integraworldwide.com>

The above-mentioned information is subject to change without prior notice. Visit the Integra web site for the latest update.

---



# Connection Tips and Video Signal Path

The AV receiver supports several connection formats for compatibility with a wide range of AV equipment. The format you choose will depend on the formats supported by your components. Use the following sections as a guide.

**The on-screen menus appear only on a TV that is connected to HDMI OUT MAIN. If your TV is connected to other video outputs, use the AV receiver's display when changing settings.**

## Video Connection Formats

Video components can be connected by using any one of the following video connection formats: composite video, component video, or HDMI, the latter offering the best picture quality.

### Tip

- For optimal video performance, THX recommends that video signals pass through the system without upconversion (e.g., component video input passing through to component video output).
- To by-pass the upconversion, set the “Picture Mode” setting to “Direct” (→ page 60).

### ■ “Monitor Out” set to “Main” or “Sub”

Video input signals flow through the AV receiver as shown, with composite video and component video sources all being upconverted for the HDMI output. Use these settings if you connect either **HDMI OUT MAIN** or **HDMI OUT SUB** of the AV receiver to your TV.

The composite video and component video outputs pass through their respective input signals as they are.

When you connect a video component to an HDMI, COMPONENT or COMPOSITE input, you must assign that input to an input selector (→ page 50, 51).

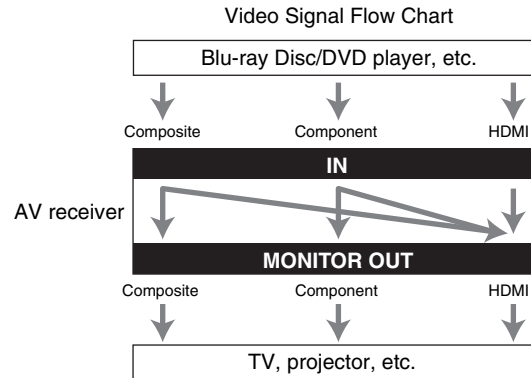

### Note

- When composite video and component video sources are upconverted for **HDMI OUT SUB**, only signals with a resolution of 480i/576i are output and the resolution remains the same. If your TV doesn't support this resolution, there will be no picture (→ page 91).

### ■ “Monitor Out” set to “Both”

Video input signals flow through the AV receiver as shown, with composite video and component video sources all being upconverted for both HDMI outputs. Use **this setting if you connect both HDMI OUT MAIN and HDMI OUT SUB of the AV receiver to your TV.**

Note that video signals are output from both HDMI outputs at the resolution supported by both TVs.

The composite video and component video outputs pass through their respective input signals as they are.

When you connect a video component to an HDMI, COMPONENT or COMPOSITE input, you must assign that input to an input selector (→ page 50, 51).

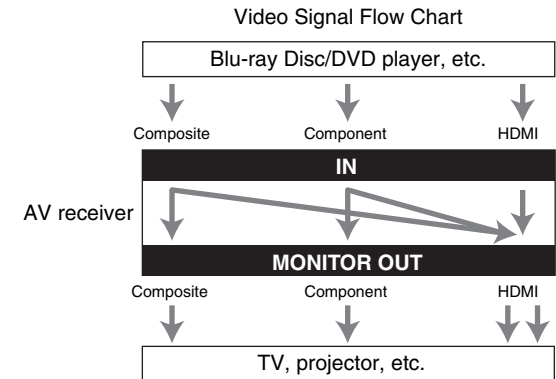

### Note

- When “Monitor Out” is set to “Both”, the “Resolution” setting cannot be selected.

## ■ Signal Selection

If signals are present at more than one input, the inputs will be selected automatically in the following order of priority: HDMI, component video, composite video.

However, for component video only, regardless of whether a component video signal is actually present, if a component video input is assigned to the input selector, that component video input will be selected. And if no component video input is assigned to the input selector, this will be interpreted as no component video signal being present.

In the Signal Selection Example shown below, video signals are present at both the HDMI and composite video inputs. However, the HDMI signal is automatically selected as the source and the video is output by the HDMI outputs.

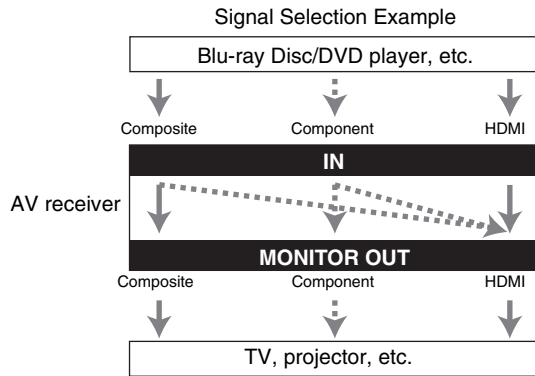

## Audio Connection Formats

Audio components can be connected by using any of the following audio connection formats: analog, optical, coaxial, or HDMI.

When choosing a connection format, bear in mind that the AV receiver does not convert digital input signals for analog line outputs and vice versa.

If signals are present at more than one input, the inputs will be selected automatically in the following order of priority: HDMI, digital, analog.

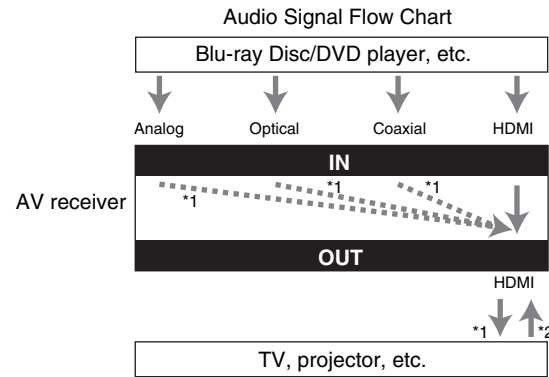

\*1 Depends on the “Audio TV Out” setting (→ page 65).

\*2 This is possible when “Audio Return Channel” is set to “Auto” (→ page 65), the TV/CD input selector is selected, and your TV is ARC capable.

### Tip

- When a signal is input via HDMI and the corresponding input selector is selected, the **HDMI** indicator lights. In the case of an optical or coaxial connection, the **DIGITAL** indicator lights. In the case of an analog connection, neither of the **HDMI** and **DIGITAL** indicators light.

## Video Resolution Chart

The following tables show how video signals at different resolutions are output by the AV receiver.

### NTSC/PAL

✓: Output available

| Input     | Output    | HDMI             |                 |                 |                 |                 |                 |                 | Component |       |      |           |           | Composite |
|-----------|-----------|------------------|-----------------|-----------------|-----------------|-----------------|-----------------|-----------------|-----------|-------|------|-----------|-----------|-----------|
|           |           | 4K <sup>*1</sup> | 1080p/24        | 1080p           | 1080i           | 720p            | 480p/576p       | 480i/576i       | 1080p     | 1080i | 720p | 480p/576p | 480i/576i | 480i/576i |
| HDMI      | 1080p/24  | ✓                | ✓ <sup>*2</sup> |                 |                 |                 |                 |                 |           |       |      |           |           |           |
|           | 1080p     | ✓                | ✓               | ✓ <sup>*2</sup> |                 |                 |                 |                 |           |       |      |           |           |           |
|           | 1080i     | ✓                | ✓               | ✓               | ✓ <sup>*2</sup> | ✓               |                 |                 |           |       |      |           |           |           |
|           | 720p      | ✓                | ✓               | ✓               | ✓               | ✓ <sup>*2</sup> |                 |                 |           |       |      |           |           |           |
|           | 480p/576p | ✓                | ✓               | ✓               | ✓               | ✓               | ✓ <sup>*2</sup> |                 |           |       |      |           |           |           |
|           | 480i/576i | ✓                | ✓               | ✓               | ✓               | ✓               | ✓               | ✓ <sup>*2</sup> |           |       |      |           |           |           |
| Component | 1080p     |                  |                 |                 |                 |                 |                 |                 | ✓         |       |      |           |           |           |
|           | 1080i     |                  |                 |                 |                 |                 |                 |                 |           | ✓     |      |           |           |           |
|           | 720p      |                  |                 |                 |                 |                 |                 |                 |           |       | ✓    |           |           |           |
|           | 480p/576p |                  |                 |                 |                 |                 |                 |                 |           |       |      | ✓         |           |           |
|           | 480i/576i | ✓                | ✓               | ✓               | ✓               | ✓               | ✓               | ✓ <sup>*2</sup> |           |       |      |           | ✓         |           |
| Composite | 480i/576i | ✓                | ✓               | ✓               | ✓               | ✓               | ✓               | ✓ <sup>*2</sup> |           |       |      |           |           | ✓         |

\*1 Supported resolutions: [3840 × 2160 24/25/30 Hz], [4096 × 2160 24 Hz]

\*2 Supported resolutions for **HDMI OUT SUB**.

# Using an RIHD-compatible TV, Player, or Recorder

**RIHD**, which stands for Remote Interactive over HDMI, is the name of the system control function found on Integra/Onkyo components. The AV receiver can be used with CEC (Consumer Electronics Control), which allows system control over HDMI and is part of the HDMI standard. CEC provides interoperability between various components, however, operation with components other than **RIHD**-compatible components cannot be guaranteed.

## About RIHD-compatible components

The following components are **RIHD**-compatible (As of January 2012).

### ■ TV

- Toshiba TV
- Sharp TV

### ■ Players/Recorders

- Onkyo and Integra **RIHD**-compatible players
- Toshiba players and recorders
- Sharp players and recorders (only when used together with Sharp TV)

\* Models other than those mentioned above may have some interoperability if compatible with CEC, which is part of the HDMI Standard, but operation cannot be guaranteed.

### Note

- For proper linked operations, do not connect more **RIHD**-compatible components than the quantities specified below, to the HDMI input terminal.
  - Blu-ray Disc/DVD players: up to three.
  - Blu-ray Disc/DVD recorders/Digital Video Recorders: up to three.
  - Cable/Satellite Set-top boxes: up to four.
- Do not connect the AV receiver to another AV receiver/AV amplifier via HDMI.
- Proper linked operations are not guaranteed when more **RIHD**-compatible components than the above-mentioned quantities are connected.

## Operations that can be performed with RIHD connection

### ■ For RIHD-compatible TV

The following linked operations are enabled by connecting the AV receiver to an **RIHD**-compatible TV.

- The AV receiver will enter standby mode when the TV is set to standby.
- You can set on the menu screen of the TV to either output the audio from the speakers connected to the AV receiver, or from the speakers of the TV.
- It is possible to output the audio coming from the tuner or auxiliary input of your TV to the speakers of the AV receiver. (A connection such as an optical digital cable or similar is required in addition to the HDMI cable.)
- Input to the AV receiver can be selected with the remote controller of the TV.
- Operations such as volume adjustment or similar for the AV receiver can be performed from the remote controller of the TV.

### ■ For RIHD-compatible players/recorders

The following linked operations are enabled by connecting the AV receiver to an **RIHD**-compatible player/recorder.

- When playback is started on the player/recorder, AV receiver will switch to the HDMI input of the player/recorder that is playing back.
- Operation of the player/recorder is possible using the remote controller supplied with the AV receiver.

\* Depending on the model used, not all operations may be available.

↳ To be continued

## ■ How to connect and setup

### 1 Confirm the connection and settings.

1. Connect the **HDMI OUT MAIN** jack to the HDMI input jack of the TV.

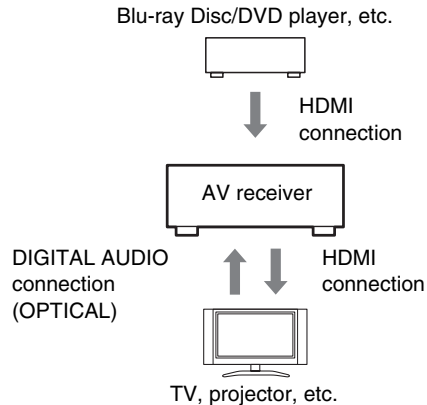

2. Connect the audio output from the TV to the **OPTICAL IN 2** jack of the AV receiver using an optical digital cable.

#### Note

- When the audio return channel (ARC) function is used with an ARC capable TV, this connection is not necessary (→ page 65).
3. Connect the HDMI output of the Blu-ray Disc/DVD player/recorder to the **HDMI IN 1** jack of the AV receiver.

#### Note

- It is necessary to assign the HDMI input when connecting the Blu-ray Disc/DVD player/recorder to other jacks (→ page 50). Do not assign an HDMI IN to the TV/CD selector at this time, otherwise appropriate CEC (Consumer Electronics Control) operation will not be guaranteed.

### 2 Change each item in the “HDMI” menu according to the following settings:

- **HDMI Control(RIHD): On**
- **Audio Return Channel (ARC): Auto**

See details of each setting (→ pages 64, 65).

### 3 Confirm the settings.

1. Turn on the power for all connected components.
2. Turn off the power of the TV, and confirm that the power of the connected components is turned off automatically with the link operation.
3. Turn on the power of the Blu-ray Disc/DVD player/recorder.
4. Start playback on the Blu-ray Disc/DVD player/recorder, and verify the following:
  - The AV receiver automatically turns on, and selects the input to which the Blu-ray Disc/DVD player/recorder is connected.
  - The TV automatically turns on, and selects the input to which the AV receiver is connected.
5. Following the operating instructions of the TV, select “Use the TV speakers” from the menu screen of the TV, and confirm that the audio is output from the speakers of the TV, and not from the speakers connected to the AV receiver.
6. Select “Use the speakers connected from the AV receiver” from the menu screen of the TV, and confirm that the audio is output from the speakers connected to the AV receiver, and not from the TV speakers.

#### Note

- Perform the above operations when you use the AV receiver for the first time, when the settings of each component are changed, when the main power of each component is turned off, when the power cable is disconnected from the power supply, or when there has been a power outage.

### 4 Operate with the remote controller.

For buttons that can be operated (→ page 77).

#### Note

- Audio from DVD-Audio or Super Audio CD may not output from the TV speakers. You will be able to output the audio from the TV speakers by setting the audio output of the DVD player to 2ch PCM. (It may not be possible depending on the player models.)
- Even if you set to output audio on the TV speakers, audio will be output from the speakers connected to the AV receiver when you adjust the volume or switch the input on the AV receiver. To output audio from the TV speakers, redo the corresponding operations on the TV.
- In case of an **RIHD** connection with **RI** and **RI** audio control compatible components, do not connect the **RI** cable at the same time.
- On the TV, when you select anything other than the HDMI jack to which the AV receiver is connected, the input on the AV receiver will be switched to “TV/CD”.
- The AV receiver will automatically power on in conjunction when it determines it to be necessary. Even if the AV receiver is connected to an **RIHD** compatible TV or player/recorder, it will not power on if it is not necessary. It may not power on in conjunction when the TV is set to output audio from the TV.
- Linked functions with the AV receiver may not work depending on the component model connected. In such cases, operate the AV receiver directly.

## About HDMI

Designed to meet the increased demands of digital TV, HDMI (High Definition Multimedia Interface) is a new digital interface standard for connecting TVs, projectors, Blu-ray Disc/DVD players, set-top boxes, and other video components. Until now, several separate video and audio cables have been required to connect AV components.

With HDMI, a single cable can carry control signals, digital video, and up to eight channels of digital audio (2-channel PCM, multichannel digital audio, and multichannel PCM).

The HDMI video stream (i.e., video signal) is compatible with DVI (Digital Visual Interface)\*1, so TVs and displays with a DVI input can be connected by using an HDMI-to-DVI adapter cable. (This may not work with some TVs and displays, resulting in no picture.)

The AV receiver uses HDCP (High-bandwidth Digital Content Protection)\*2, so only HDCP-compatible components can display the picture.

The AV receiver's HDMI interface is based on the following:

Audio Return Channel, 3D, x.v.Color, DeepColor, LipSync, DTS-HD Master Audio, DTS-HD High Resolution Audio, Dolby TrueHD, Dolby Digital Plus, DSD and Multichannel PCM.

### Supported Audio Formats

- 2-channel linear PCM (32–192 kHz, 16/20/24 bit)
- Multichannel linear PCM (up to 7.1 ch, 32–192 kHz, 16/20/24 bit)
- Bitstream (DSD, Dolby Digital, Dolby Digital Plus, Dolby TrueHD, DTS, DTS-HD High Resolution Audio, DTS-HD Master Audio)

Your Blu-ray Disc/DVD player must also support HDMI output of the above audio formats.

### About Copyright Protection

The AV receiver supports HDCP (High-bandwidth Digital Content Protection)\*2, a copy-protection system for digital video signals. Other devices connected to the AV receiver via HDMI must also support HDCP.

\*1 DVI (Digital Visual Interface): The digital display interface standard set by the DDWG\*3 in 1999.

\*2 HDCP (High-bandwidth Digital Content Protection): The video encryption technology developed by Intel for HDMI/DVI. It's designed to protect video content and requires a HDCP-compatible device to display the encrypted video.

\*3 DDWG (Digital Display Working Group): Lead by Intel, Compaq, Fujitsu, Hewlett Packard, IBM, NEC, and Silicon Image, this open industry group's objective is to address the industry's requirements for a digital connectivity specification for high-performance PCs and digital displays.

### Note

- The HDMI video stream is compatible with DVI (Digital Visual Interface), so TVs and displays with a DVI input can be connected by using an HDMI-to-DVI adapter cable. (Note that DVI connections only carry video, so you'll need to make a separate connection for audio.) However, reliable operation with such an adapter is not guaranteed. In addition, video signals from a PC are not supported.
- The HDMI audio signal (sampling rate, bit length, etc.) may be restricted by the connected source component. If the picture is poor or there's no sound from a component connected via HDMI, check its setup. Refer to the connected component's instruction manual for details.

# Network/USB Features

## Connecting to the Network

The following diagram shows how you can connect the AV receiver to your home network. In this example, it's connected to a LAN port on a router, which has a 4-port 100Base-TX switch built-in.

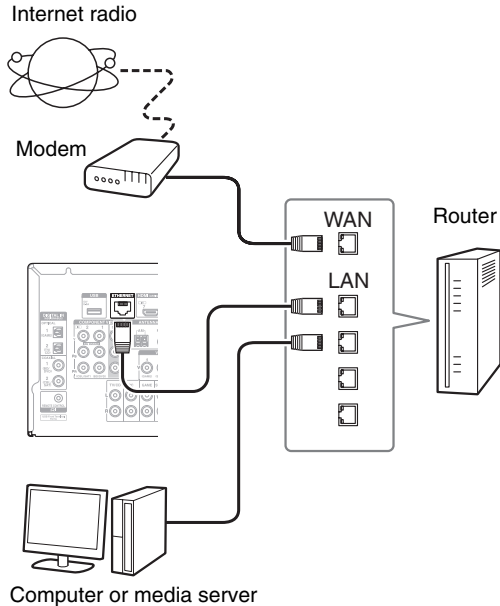

## Network Requirements

### ■ Ethernet Network

For the best results, a 100Base-TX switched Ethernet network is recommended. Although it's possible to play music on a computer that's connected to the network wirelessly, playback may be unreliable, so it is recommended to use wired connections.

### ■ Ethernet Router

A router manages the network, data-routing and supplying of IP addresses. Your router must support the following:

- NAT (Network Address Translation). NAT allows several networked computers to access the Internet simultaneously via a single Internet connection. The AV receiver needs Internet access for Internet radio.
- DHCP (Dynamic Host Configuration Protocol). DHCP supplies IP addresses to the network devices, allowing them to configure themselves automatically.
- A router with a built-in 100Base-TX switch is recommended.

Some routers have a built-in modem, and some Internet Service Providers (ISP) require you to use specific routers. Please consult your ISP or computer dealer if you're unsure.

### ■ CAT5 Ethernet cable

Use a shielded CAT5 Ethernet cable (straight-type) to connect the AV receiver to your home network.

### ■ Internet Access (for Internet radio)

To receive Internet radio, your Ethernet network must have Internet access. A narrowband Internet connection (e.g., 56K modem, ISDN) will not provide satisfactory results, so a broadband connection is strongly recommended (e.g., cable modem, xDSL modem, etc.). Please consult your ISP or computer dealer if you're unsure.

### Note

- To receive Internet radio with the AV receiver, your broadband Internet connection must be working and able to access the Web.

Consult your ISP if you have any problems with your Internet connection.

- The AV receiver uses DHCP to configure its network settings automatically. If you want to configure these settings manually, see "Network" (→ page 66).
- The AV receiver does not support PPPoE settings, so if you have a PPPoE-type Internet connection, you must use a PPPoE-compatible router.
- Depending on your ISP, you may need to specify a proxy server to use Internet radio. If your computer is configured to use a proxy server, use the same settings for the AV receiver (→ page 66).

## Server Requirements

### ■ Server playback

The AV receiver can play digital music files stored on a computer or media server and supports the following technologies:

- Windows Media Player 11
- Windows Media Player 12
- Windows Media Connect 2.0
- DLNA-certified media server

If the operating system of your computer is Windows Vista, Windows Media Player 11 is already installed. Windows Media Player 11 for Windows XP can be downloaded for free from the Microsoft web site.

- The computer or media server must be on the same network as the AV receiver.
- Up to 20,000 folders can be displayed, and folders may be nested up to 16 levels deep.

### Note

- Depending on the media server, the AV receiver may not recognize it, or may not be able to play its music files.

### Minimum system requirements for Windows Media Player 11 on Windows XP

#### Operating system

Windows XP Home Edition (SP2), Windows XP Professional (SP2), Windows XP Tablet PC Edition (SP2), Update Rollup 2 for Windows XP Media Center Edition 2005 (KB900325), October 2006 Update Rollup for Windows XP Media Center Edition (KB925766)

**Processor:** 233 MHz Intel Pentium II, Advanced Micro Devices (AMD), etc.

**Memory:** 64 MB

**Hard disk:** 200 MB of free space

**Drive:** CD or DVD drive

**Modem:** 28.8 kbps

**Sound card:** 16-bit sound card

**Monitor:** Super VGA (800 x 600)

**Video card:** 64 MB VRAM, DirectX 9.0b

**Software:** Microsoft ActiveSync (only when using a Windows Mobile-based Pocket PC or smartphone)

**Web browser:** Microsoft Internet Explorer 6 or Netscape 7.1

### ■ Remote playback

- Windows Media Player 12
- DLNA-certified (within DLNA Interoperability Guidelines version 1.5) media server or controller device. The setting varies depending on the media server or controller devices. Refer to your devices' instruction manual for details.

If the operating system of your personal computer is Windows 7, Windows Media Player 12 is already installed. For more information, see the Microsoft web site.

## USB Device Requirements

- USB mass storage device class (but not always guaranteed).
- FAT16 or FAT32 file system format.
- If the storage device has been partitioned, each section will be treated as an independent device.
- Up to 20,000 folders can be displayed, and folders may be nested up to 16 levels deep.
- USB hubs and USB devices with hub functions are not supported.

### Note

- If the media you connect is not supported, the message “**No Storage**” will be displayed.
- If you connect a USB hard disk drive to the AV receiver's **USB** port, we recommend that you use its AC adapter to power it.
- The AV receiver supports USB MP3 players that support the USB Mass Storage Class standard, which allows USB devices to be connected to computers without the need for special drivers or software. Note that not all USB MP3 players support the USB Mass Storage Class standard. Refer to your USB MP3 player's instruction manual for details.
- Protected WMA music files on an MP3 player cannot be played.
- Onkyo accepts no responsibility whatsoever for the loss or damage to data stored on a USB device when that device is used with the AV receiver. We recommend that you back up your important music files beforehand.
- MP3 players containing music files that are managed with special music software are not supported.
- Operation is not guaranteed for all USB devices, which includes the ability to power them.
- Do not connect your USB device via a USB hub. The USB device must be connected directly to the AV receiver's **USB** port.
- If the USB device contains a lot of data, the AV receiver may take a while to read it.
- USB devices with security functions cannot be played.



## Supported Audio File Formats

For server playback and playback from a USB device, the AV receiver supports the following music file formats. Variable bit-rate (VBR) files are supported. However, playback times may not display correctly.

### Note

- With remote playback, the AV receiver does not support the following music file formats: FLAC and Ogg Vorbis.
- In the case of server playback, the above-mentioned file formats may not be played depending on the server type.

### ■ MP3 (.mp3 or .MP3)

- MP3 files must be MPEG-1/MPEG-2 Audio Layer 3 format with sampling rates of 8 kHz, 11.025 kHz, 12 kHz, 16 kHz, 22.05 kHz, 24 kHz, 32 kHz, 44.1 kHz, 48 kHz and bitrates of between 8 kbps and 320 kbps. Incompatible files cannot be played.

### ■ WMA (.wma or .WMA)

WMA stands for Windows Media Audio and is an audio compression technology developed by Microsoft Corporation. Audio can be encoded in WMA format by using Windows Media® Player.

- WMA files must have the copyright option turned off.
- Sampling rates of 8 kHz, 11.025 kHz, 12 kHz, 16 kHz, 22.05 kHz, 24 kHz, 32 kHz, 44.1 kHz, 48 kHz, bitrates of between 5 kbps and 320 kbps, and WMA DRM are supported.
- WMA Pro/Voice formats are not supported.

### ■ WMA Lossless (.wma or .WMA)

- Sampling rates of 44.1 kHz, 48 kHz, 88.2 kHz, 96 kHz are supported.
- Quantization bit: 16 bit, 24 bit

### ■ WAV (.wav or .WAV)

WAV files contain uncompressed PCM digital audio.

- Sampling rates of 8 kHz, 11.025 kHz, 12 kHz, 16 kHz, 22.05 kHz, 24 kHz, 32 kHz, 44.1 kHz, 48 kHz, 64 kHz, 88.2 kHz, 96 kHz, 176.4 kHz and 192 kHz are supported.
- Quantization bit: 8 bit, 16 bit, 24 bit

### ■ AAC

**(.aac/.m4a/.mp4/.3gp/.3g2/.AAC/.M4A/.MP4/.3GP or .3G2)**

AAC stands for MPEG-2/MPEG-4 Audio.

- Sampling rates of 8 kHz, 11.025 kHz, 12 kHz, 16 kHz, 22.05 kHz, 24 kHz, 32 kHz, 44.1 kHz, 48 kHz, 64 kHz, 88.2 kHz, 96 kHz and bitrates of between 8 kbps and 320 kbps are supported.

### ■ FLAC (.flac or .FLAC)

FLAC is a file format for lossless audio data compression.

- Sampling rates of 8 kHz, 11.025 kHz, 12 kHz, 16 kHz, 22.05 kHz, 24 kHz, 32 kHz, 44.1 kHz, 48 kHz, 64 kHz, 88.2 kHz, 96 kHz, 176.4 kHz and 192 kHz are supported.
- Quantization bit: 8 bit, 16 bit, 24 bit

### ■ Ogg Vorbis (.ogg or .OGG)

- Sampling rates of 8 kHz, 11.025 kHz, 12 kHz, 16 kHz, 22.05 kHz, 24 kHz, 32 kHz, 44.1 kHz, 48 kHz and bitrates of between 48 kbps and 500 kbps are supported. Incompatible files cannot be played.

### ■ LPCM (Linear PCM)

- Sampling rates of 8 kHz, 11.025 kHz, 12 kHz, 16 kHz, 22.05 kHz, 24 kHz, 32 kHz, 44.1 kHz, 48 kHz, 64 kHz, 88.2 kHz, 96 kHz, 176.4 kHz and 192 kHz are supported.
- Quantization bit: 8 bit, 16 bit, 24 bit
- \* Only for playback via network.

## About DLNA

The Digital Living Network Alliance is an international, cross-industry collaboration. Members of DLNA develop a concept of wired and wireless interoperable networks where digital content such as photos, music, and videos can be shared through consumer electronics, personal computers, and mobile devices in and beyond the home. The AV receiver complies with the DLNA Interoperability Guidelines version 1.5.

# License and Trademark Information

“x.v.Color” is a trademark of Sony Corporation.



Manufactured under license under U.S. Patent Nos: 5,956,674; 5,974,380; 6,226,616; 6,487,535; 7,212,872; 7,333,929; 7,392,195; 7,272,567 & other U.S. and worldwide patents issued & pending. DTS-HD, the Symbol, & DTS-HD and the Symbol together are registered trademarks & DTS-HD Master Audio is a trademark of DTS, Inc. Product includes software. © DTS, Inc. All Rights Reserved.



Manufactured under license from Dolby Laboratories. Dolby, Pro Logic, Surround EX and the double-D symbol are trademarks of Dolby Laboratories.

Music Optimizer™ is a trademark of Onkyo Corporation.



“HDMI, the HDMI Logo, and High-Definition Multimedia Interface are trademarks or registered trademarks of HDMI Licensing LLC in the United States and other countries.”



InstaPrevue and the InstaPrevue logo are trademarks or registered trademarks of Silicon Image, Inc. in the United States and other countries.



THX and the THX logo are trademarks of THX Ltd. which may be registered in some jurisdictions. All rights reserved.

## THX Select2 Plus

Before any home theater component can be THX Select2 Plus certified, it must pass a rigorous series of quality and performance tests. Only then can a product feature the THX Select2 Plus logo, which is your guarantee that the Home Theater products you purchase will give you superb performance for many years to come. THX Select2 Plus requirements define hundreds of parameters, including power amplifier performance, and pre-amplifier performance and operation for both digital and analog domains. THX Select2 Plus receivers also feature proprietary THX technologies (e.g., THX Mode) which accurately translate movie soundtracks for home theater playback.

Made for



iPhone, iPod, iPod classic, iPod nano, iPod shuffle, and iPod touch are trademarks of Apple Inc., registered in the U.S. and other countries.

“Made for iPod” and “Made for iPhone” mean that an electronic accessory has been designed to connect specifically to iPod or iPhone, respectively, and has been certified by the developer to meet Apple performance standards. Apple is not responsible for the operation of this device or its compliance with safety and regulatory standards.

Please note that the use of this accessory with iPod or iPhone may affect wireless performance.

Apple TV is a trademark of Apple Inc., registered in the U.S. and other countries.



Manufactured under license from Audyssey Laboratories™, Inc. U.S. and foreign patents pending. Audyssey 2EQ®, Audyssey Dynamic EQ®, Audyssey Dynamic Volume® and Audyssey DSX® are registered trademarks of Audyssey Laboratories, Inc.

“DLNA®, the DLNA Logo and DLNA CERTIFIED™ are trademarks, service marks, or certification marks of the Digital Living Network Alliance.”

Windows and the Windows logo are trademarks of the Microsoft group of companies.

Qdeo and QuietVideo are trademarks of Marvell or its affiliates.

“Xantech” is a registered trademark of Xantech Corporation.

“Niles” is a registered trademark of Niles Audio Corporation.

Re-Equalization and the “Re-EQ” logo are trademarks of THX Ltd.



“MHL, the MHL Logo, and Mobile High-Definition Link are trademark or registered trademarks of MHL LLC in the United States and other countries.”

# Specifications

## Amplifier Section

---

### Rated Output Power

All channels: (North American)  
**100 watts minimum continuous power per channel, 8 ohm loads, 2 channels driven from 20 Hz to 20 kHz, with a maximum total harmonic distortion of 0.08% (FTC)**  
 (Others)  
 7 ch × 160 W at 6 ohms, 1 kHz, 1 ch driven of 1% (IEC)

### Maximum Effective Output Power

(Others)  
 7 ch × 175 W at 6 ohms, 1 kHz, 1 ch driven (JEITA)

### Dynamic Power\*

\* IEC60268-Short-term maximum output power

240 W (3 Ω, Front)  
 210 W (4 Ω, Front)  
 120 W (8 Ω, Front)

### THD+N (Total Harmonic Distortion+Noise)

0.08% (20 Hz - 20 kHz, half power)

**Damping Factor** 60 (Front, 1 kHz, 8 Ω)

### Input Sensitivity and Impedance (Unbalance)

200 mV/47 kΩ (LINE)

### Rated RCA Output Level and Impedance

200 mV/2.2 kΩ (LINE OUT)

### Maximum RCA Output Level and Impedance

2 V/2.2 kΩ (LINE OUT)

**Frequency Response** 5 Hz - 100 kHz/+1 dB, -3 dB (DSP bypass)

### Tone Control Characteristics

±10 dB, 30 Hz (BASS)  
 ±10 dB, 20 kHz (TREBLE)

**Signal to Noise Ratio** 106 dB (LINE, IHF-A)

**Speaker Impedance** (North American)  
 6 Ω - 16 Ω  
 (Others) 4 Ω - 16 Ω

## Video Section

---

### Input Sensitivity/Output Level and Impedance

1 V<sub>p-p</sub>/75 Ω (Component Y)  
 0.7 V<sub>p-p</sub>/75 Ω (Component Pb/Cb, Pr/Cr)  
 1 V<sub>p-p</sub>/75 Ω (Composite)

### Component Video Frequency Response

5 Hz - 100 MHz/+0 dB, -3 dB

## Tuner Section

---

### FM Tuning Frequency Range

(North American) 87.5 MHz - 107.9 MHz  
 (Others) 87.5 MHz - 108.0 MHz, RDS

### AM Tuning Frequency Range

522/530 kHz - 1611/1710 kHz

**Preset Channel** 40

## General

---

**Power Supply** (North American)  
 AC 120 V, 60 Hz  
 (Others)  
 AC 220 - 240 V, 50/60 Hz

**Power Consumption** (North American) 6.3 A  
 (Others) 620 W

**No-sound Power Consumption**  
 (North American) 85 W  
 (Others)  
 80 W (230 V)  
 85 W (240 V)

**Stand-by Power Consumption**  
 (North American) 0.15 W  
 (Others) 0.2 W

**Dimensions (W × H × D)**  
 435 mm × 174.5 mm × 326.5 mm  
 17-1/8" × 6-7/8" × 12-7/8"

**Weight** 11.5 kg (25.4 lbs.)

### ■ HDMI

**Input** IN 1, IN 2, IN 3, IN 4, IN 5, IN 6, IN 7,  
 AUX INPUT

**Output** OUT MAIN, OUT SUB

**Video Resolution** 1080p

**Audio Format** Dolby TrueHD, DTS-HD Master Audio,  
 DVD-Audio, DSD

**Supported** 3D, Audio Return Channel, DeepColor,  
 x.v.Color, LipSync, CEC (RIHD)

### ■ Video Inputs

**Component** IN 1, IN 2  
**Composite** IN 1, IN 2, IN 3, IN 4, AUX

### ■ Video Outputs

**Component** OUT  
**Composite** MONITOR OUT

### ■ Audio Inputs

**Digital** Optical: 2  
 Coaxial: 2  
**Analog** BD/DVD, CBL/SAT, STB/DVR, GAME,  
 PC, TV/CD, AUX

### ■ Audio Outputs

**Analog** ZONE2 PRE/LINE OUT, ZONE3  
 PRE/LINE OUT

### Multichannel Pre Outputs

7 (L, R, C, SL, SR, SBL or FHL, SBR or  
 FHR)

### Subwoofer Pre Outputs

2

**Speaker Outputs** Main (L, R, C, SL, SR, SBL/FHL,  
 SBR/FHR) + ZONE2 (L, R)

**Phones** 1 (6.3 φ)

### ■ Others

**Setup Mic** 1  
**RI** 1  
**RS232** 1  
**USB** 1 (Front)/1 (Rear)  
**Ethernet** 1  
**IR Input/Output** 2/1  
**12 V Trigger Out** A, B, C

Specifications and features are subject to change  
 without notice.

# Integra®

Integra Division of

## Onkyo U.S.A. Corporation

18 park Way, Upper Saddle River, N.J. 07458, U.S.A.  
Tel: 800-225-1946, 201-818-9200 Fax: 201-785-2650  
<http://www.integrahometheater.com>

Integra Division of

## Onkyo Europe Electronics GmbH

Liegnitzerstrasse 6, 82194 Groebezell, GERMANY  
Tel: +49-8142-4401-0 Fax: +49-8142-4208-213  
<http://www.integra.eu>

Integra Division of

## Onkyo China PRC

1301, 555 Tower, No.555 West NanJin Road, Jin an, Shanghai,  
China 200041, Tel: 86-21-52131366 Fax: 86-21-52130396  
<http://www.integra.com.cn>

Integra Division of

## Onkyo Sound & Vision Corporation

2-1, Nisshin-cho, Neyagawa-shi, OSAKA 572-8540, JAPAN  
Tel: 072-831-8023 Fax: 072-831-8163  
<http://www.integraworldwide.com>

SN 29401043

(C) Copyright 2012 Onkyo Sound & Vision Corporation Japan. All rights reserved.



Y1203-1



\* 2 9 4 0 1 0 4 3 \*