

MOBILE RADIO
UV-50X3 SERIES
OPERATING MANUAL

FCC Statements:

Any Changes or modifications not expressly approved by the party responsible for compliance could void the user's authority to operate the equipment.

RF Exposure Compliance and Control Guidelines and Operating Instructions

To control your exposure and ensure compliance with the occupational/controlled environment exposure limits always adhere to the following procedures.

Guidelines:

Do not remove the RF Exposure Label from the device.

User awareness instructions should accompany device when transferred to other users.

Do not use this device if the operational requirements described herein are not met.

In order to comply with the FCC RF exposure requirements, the antenna installation must comply with following: The radio antenna must be installed so as to provide a minimum separation distance of 70cm between the antenna and persons within the area. This antenna should with gain less than 3.5dBi, VSWR \leq 1.5:1, ZO=50ohms)

Transmit no more than the rated duty factor of 50% of the time. To transmit (talk), push the Push-To-Talk (PTT) button.

To receive calls, release the PTT button. Transmitting 50 % of the time, or less, is important because this radio generates measurable RF energy exposure only when transmitting (in terms of measuring for standards compliance).

NOTICE: This radio is intended for use in occupational/controlled conditions, where users have full knowledge of their exposure and can exercise control over their exposure to meet FCC limits. This radio device is NOT authorized for general population, consumer, or any other use.

CONTENTS

Front Panel Controls & Switches	1	Menu Navigation Chart	13
Timer Page Operation	2	DTMF Operation	15
Radio Page Basic Operation	3	Manual DTMF Tone Generation	15
[SMART FUNCTION] Key	5	DTMF Autodialer	15
General	5	Miscellaneous Setting (Set Mode Operation)	16
[SMART FUNCTION] Key Command Details	5	AUDIO Group	16
Memory Operation	7	TX/RX Group	17
Memory Storage	7	DISPLAY Group	18
Storing Independent Transmit Frequency	7	MEMORY Group	18
Memory Recall	8	SCAN Group	19
Memory Edit	9	SYSTEM Group	19
Labeling Memories	9	TIMER/CLOCK Group	21
Copying Memories	9	SIGNALING Group	21
Deleting Memories	9	PKT Group	22
AF Dual Operation	10	Installation	24
CTCSS/DCS Operation	11	Preliminary Inspection	24
CTCSS Operation	11	Installation Tips	24
DCS Operation	11	Safety Information	27
Scan Operation	12	Special Function Menu	28
VFO Scan	12	Accessories & Options	29
Memory Scan	12	Trouble Shooting	30
Programmable Memory Scan (PMS)	12	Specification	32

FRONT PANEL CONTROLS & SWITCHES

[POWER] Switch

Press and hold this key for two seconds to toggle the transceiver's power on and off. Press this key while the transceiver is turned on to toggle the on/off state of the lockout function.

[FWD]/[BCK] Keys

Press these briefly to select the operating function pages. The available pages are "Radio" page and "CLOCK" page. Press and hold these keys to toggle the "DUAL" band and "MONO" band mode.

[DIAL] Knob

- Rotate this knob to select the operating frequency (or memory channel) of the leftside receiver.
- Press and hold this knob for one second to enable tuning of the VFO frequency in 1 MHz step.
- When the leftside receiver is set to "Sub" band, press this knob briefly to change the leftside receiver to "Main" band.

While using "Mono" band operating mode:

- When the leftside receiver is set to "Sub" band, press and hold this knob to toggle "Sub" band operation "on" and "off".

DIAL ILLUMINATION

[PTT] Key

Press this key to transmit.

MICROPHONE

[B](BAND) Key

Press this key to change the Main operating band. Available bands are:
 Left Band: AM Radio, FM Radio, 144 MHz Band, 430 MHz Band, and Audio Line-In
 Right Band: 144 MHz Band and 430 MHz Band
 You may invoke additional operating bands by setting Mode item "B05: RX EXPANSION". See page 14.

[F](FUNCTION) Key

Press this key to change the current functions of the [SMART FUNCTION] keys.

DIAL ILLUMINATION

[VOL] Knob

Adjust the audio volume of the rightside receiver.

[VOL] Knob

Adjust the audio volume of the leftside receiver.

[SET](SET MODE) Key

Press this key to access to the Set Mode.

[SMART FUNCTION] Keys

These four keys control most of operating features of this transceiver. When changing the operating function page or pressing the [FUNCTION] key, the current function of these keys will be change and the function will appear above each key.

[DIAL] Knob

- Rotate this knob to select the operating frequency (or memory channel) of the rightside receiver.
 - Press and hold this knob for one second to enable tuning of the VFO frequency in 1 MHz step.
 - When the right side receiver is set to "Sub" band, press this knob briefly to change the rightside receiver to "Main" band.
- While using "Mono" band operating mode:
- When the rightside receiver is set to "Sub" band, press and hold this knob to toggle "Sub" band operation "on" and "off".

CLOCK PAGE OPERATION

CLOCK

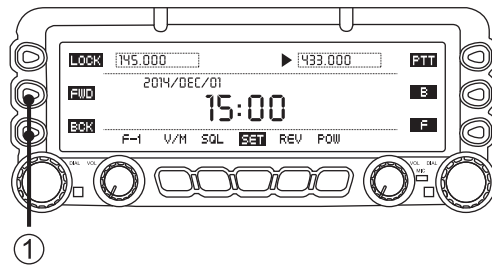

- ① Press the [FWD] or [BCK] key repeatedly, until the “Clock Page” appears.

To return to the “Radio” page, press the [FWD] or [BCK] key repeatedly, until the “Radio” Page appears.

The transceiver’s clock is set up from the Set mode item “G01 DATA&TIME ADJUST” in the “CLOCK” group. See page 21 for details.

RADIO PAGE BASIC OPERATION

The basic operations are listed numerically in the illustration below.

Receiving Mode:
“A”--AUTO
“W”--WIDE(12.5KHz)
“N”--NARROW (6.25KHz)
“AM”--AM

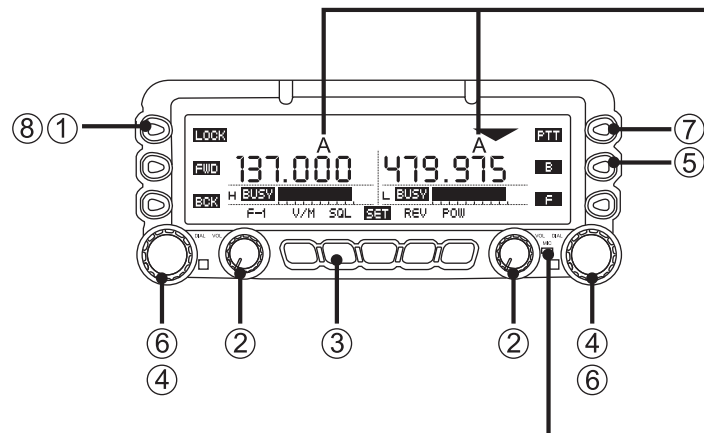

Internal Microphone with VOX

- ① Press and hold the **[POWER]** key for two seconds to turn the transceiver on.
- ② Rotate the **[VOL]** knob to adjust the audio volume level.
- ③ Press the **[SQL]** key briefly and rotate the **[DIAL]** knob carefully to adjust the squelch threshold level.
- ④ Press the **[DIAL]** knob briefly to set the “Main” band.
- ⑤ Press the **[B]** key to select the operating band of the “Main” band.
- ⑥ Rotate the **[DIAL]** knob to select the operating frequency.
- ⑦ Press and hold the **[PTT]** key, and speak into the internal microphone in a normal volume.
- ⑧ Press and hold the **[POWER]** key for two seconds to turn the transceiver off.

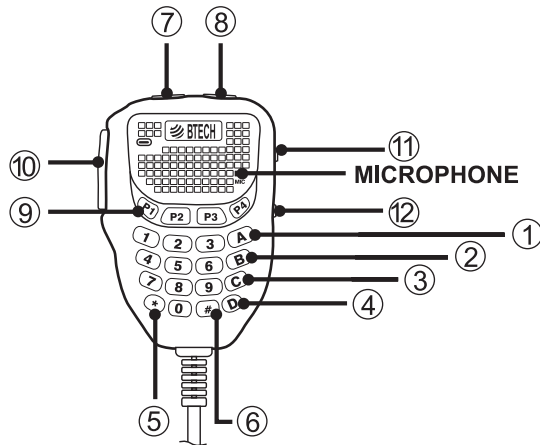

- ① Press the **[A]** key to switch frequency control between the “**VFO**” and “**Memory**” System.
- ② Press the **[B]** key to change the Main operating band.
- ③ Press the **[C]** key to enable tuning of the **VFO** frequency in 1 MHz step.
- ④ Press the **[D]** key to activate the Squelch threshold level.
- ⑤ Press the **[*]** key to change the left side receiver to “**Main**” band.
- ⑥ Press the **[#]** key to change the right side receiver to “**Main**” band.
- ⑦ Press the **[DOWN]** key to lower the operating frequency, Memory Channel number, Menu Number, etc. Hold down to repeat the action. Also press to switch between values for functions with multiple choices.
- ⑧ Press the **[UP]** key to raise the operating frequency, Memory Channel number, Menu Number, etc. Hold down to repeat the action. Also press to switch between values for functions with multiple choices.
- ⑨ MIC P key. See page 20 for details.
- ⑩ Press and hold the **[PTT]** key, and speak into the microphone in a normal volume.
- ⑪ **LOCK**
- ⑫ **LAMP**

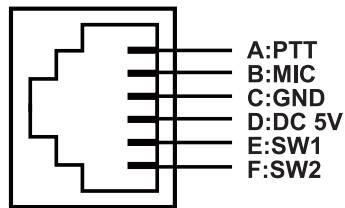

MIC JACK

[SMART FUNCTION] KEY

GENERAL

The UV-50X3 Series Transceiver operations are performed using the **[SMART FUNCTION]** keys. The various functions of the keys are changed by pressing the **[F]** key.

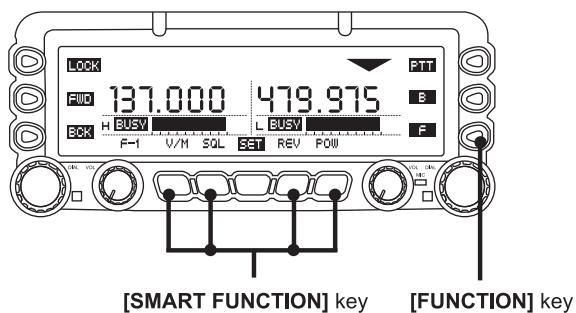

⊙ Default

F-1	V/M	SQL	SET	REV	POW
F-2	SCAN	DW	SET	SKIP ^{*1}	FM ^{*2}

⊙ Press and hold the **[F]** key for two seconds.

SQL	TYPE	T-FRQ	SET	D-COD
-----	------	-------	-----	-------

* 1: The **[SKIP]** command appears only in memory mode.

* 2: You may change the **[FM]** command to another command with Set Mode item "F05: F KEY". See page 20.

Pressing the **[F]** key repeatedly will change the function command of each **[SMART FUNCTION]** key as shown in the following tables. It is easy to recall and perform a desired operation. The current function of each key is shown in the display above the button.

[SMART FUNCTION] KEY COMMAND DETAILS

F-1	V/M	Press Key	To Switch frequency control between the "VFO" and "Memory System".
		Press & Hold Key	To Activate the "Memory Write" mode (for memory channel storage).
	SQL	Press Key	To Activate the Squelch threshold level.
		Press & Hold Key	No Action.
	SET	Press Key	To Access to the Menu Item
		Press & Hold Key	No Action.
	REV	Press Key	To Reverse transmitting and received frequencies while working through a repeater.
		Press & Hold Key	No Action.
	POW	Press Key	To Select the desired transmitting power output level ("LOW", "MID", and "HIGH").
		Press & Hold Key	No Action.
F-2	SCAN	Press Key	To Activate the Scanner.
		Press & Hold Key	No Action.
	DW	Press Key	To Activate the Dual Watch feature.
		Press & Hold Key	No Action.
	SET	Press Key	To Access to the Menu Item
		Press & Hold Key	No Action.
	SKIP	Press Key	To Select the "scan flag" to the current memory channel.
		Press & Hold Key	No Action.
	FM	Press Key	To Activate the FM function.
		Press & Hold Key	No Action.
SQL	TYPE	Press Key	To Select the Squelch type.
		Press & Hold Key	No Action.
	T•FRQ	Press Key	To Select the CTCSS Tone frequency.
		Press & Hold Key	No Action.
	SET	Press Key	To Access to the Menu Item.
		Press & Hold Key	No Action.
	D•COD	Press Key	To Select the DCS code.
		Press & Hold Key	No Action.

MEMORY OPERATION

MEMORY STORAGE

Select the desired received frequency while operating in the “Main” band VFO. Set up any desired CTCSS or DCS tones, as well as any repeater offset. The power level setting is also stored in the memory.

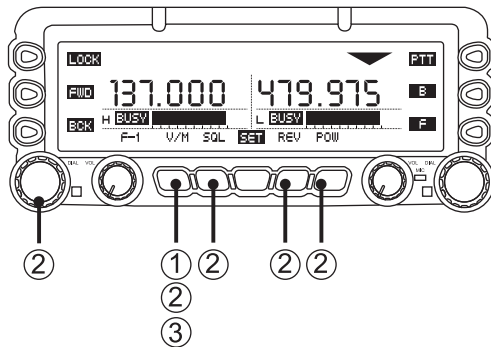

- ① Press and hold the **[V/M]** key for two seconds to display the “Memory Edit” window.
- ② If you wish to append an Alpha/numeric “Tag” to this channel, press and hold the **[V/M]** key for two seconds. Then enter the desired name “Tag” (be 8 characters or less). One of the methods is shown in the following examples. Otherwise, skip to the next step.

Example 1: Enter the characters/numbers by pressing the microphone keypad buttons; or use the microphone **[UP]/[DWN]** keys to select them. Press the **[B]** key to move the cursor to the next digit. Press the **[A]** key to backspace the cursor, and press the

[C] key to delete all data after the cursor. You may change the character (capital, lowercase, numeric, or symbol) by pressing the **[*]** key.

Example 2: Rotate the leftside **[DIAL]** knob to select a character/number and press the **[→]** key to move the cursor to the digit. Press the **[←]** key to backspace the cursor. You may change the character (capital, small, numeric, or symbol) by pressing the **[FONT]** key.

- ③ Press the **[V/M]** key to store the frequency and settings into memory.

Important Note

On rare occasions the stored data may become corrupted by misoperation or static electricity. When it is being repaired, memory may be lost. Please be sure to record the memory data information, so you will be able to restore it if needed.

STORING INDEPENDENT TRANSMITTING FREQUENCY (“ODD SPLIT”)

All memories can store an independent transmitting frequency, for operation on repeaters with non-standard shift.

To store the “**Odd Split**” transmitting frequency, first store the received frequency using the method already described on the previous page. Then follow the below procedures:

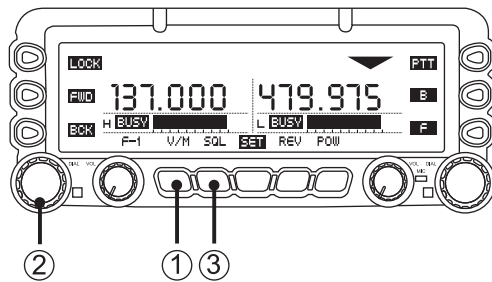

- ① Tune the desired transmitting frequency on the “Main” band, then press and hold the **[V/M]** key for two seconds.
- ② Rotate the leftside **[DIAL]** knob to select the same memory channel number as used in step 1.
- ③ Press the **[TXIN]** key to store the independent transmitting frequency into the memory.

MEMORY RECALL

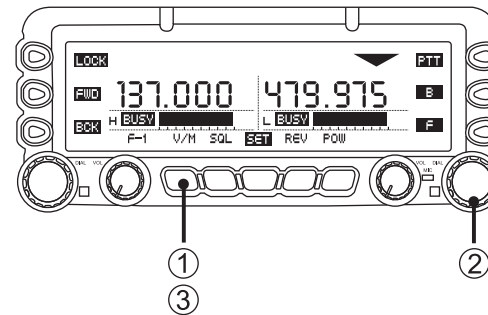

- ① Press the **[V/M]** key to set the “Main” band to the memory mode.
 - ② Rotate the **[DIAL]** knob to select the desired memory channel.
 - ③ Press the **[V/M]** key to return to the **VFO** mode.
- When the radio is in the memory mode, you may recall a memory to the main memory display by entering the memory number using the microphone keypad.
For example, to recall memory channel #14, press **[0]→[1]→[4]**.
 - When an “**Odd Split**” memory channel is recalled, the “**OS**” indication will appear in the display.
 - When a “**Tagged**” memory channel is displayed with the Alpha/numeric “**Tag**”, a small frequency indication will also be shown. You may change the display between “**Tag**” indication and “**Frequency**” indication via Set Mode item “**D01 MEMORY DISPLAY**” in the “**MEMORY**” group.

MEMORY EDIT

The memory channels may be edited using Set Mode item "**D02 MEMORY EDIT**" in the "**MEMORY**" group.

LABELING MEMORIES

1. Rotate the leftside **[DIAL]** knob to select a memory channel to append or change the label.
2. Press the **[V/M]** key for two seconds, and then append or change the label in the same manner as step 2 of the "**Memory Storage**" procedure (see page 7).

COPYING MEMORIES

1. Rotate the leftside **[DIAL]** knob to select the memory channel to be copied.
2. Press the **[SEL]** key
3. Rotate the leftside **[DIAL]** knob to select a memory channel to store the data.
4. Press the **[CPY]** key to copy the memory channel data.
5. Press the **[SEL]** key to save the data.

DELETING MEMORIES

1. Rotate the leftside **[DIAL]** knob to select the memory channel to delete.
2. Press the **[SEL]** key.
3. Press the **[DEL]** key to delete the memory channel data.

CTCSS/DCS OPERATION

CTCSS OPERATION

1. Press and hold the **[F]** key for two seconds to change the **[SMART FUNCTION]** key category to the “**SQL**” functions.
2. Press the **[TYPE]** key repeatedly, until the “**TONE SQL**” notation appears; this activates the CTCSS operation.
3. Press the **[T·FRQ]** key, then rotate the “**Main**” band’s **[DIAL]** knob to select the desired CTCSS frequency.
4. Press the **[BCK]** key to save the new setting and exit to normal operation.
5. To end the CTCSS operation, press the **[TYPE]** key repeatedly, until the “**OFF**” notation appears.

You may customize the CTCSS operation so that a ringing “**bell**” sound alerts you when a call is coming in. Use Set Mode item “**H01 BELL RINGER**” in the “**SIGNALING**” group. See page 21 for details.

DCS OPERATION

1. Press and hold the **[F]** key for two seconds to change the **[SMART FUNCTION]** key category to the “**SQL**” functions.
2. Press the **[TYPE]** key repeatedly, until the “**DCS**” notation appears; this activates the DCS operation.
3. Press the **[D·COD]** key, then rotate the **[DIAL]** knob of “**Main**” band to select the desired DCS code.
4. Press the **[BCK]** key to save the new setting and exit to normal operation.
5. To end the DCS operation, press the **[TYPE]** key repeatedly, until the “**OFF**” notation appears.

You may customize the DCS operation so that a ringing “**bell**” sound alerts you when a call is coming in. Use Set Mode item “**H01 BELL RINGER**” in the “**SIGNALING**” group. See page 21 for details.

SCAN OPERATION

VFO SCAN

1. Press the **[F]** key repeatedly until the **[SMART FUNCTION]** keys “**F-1**” category is displayed. Then, if necessary, set the “**Main**” band to VFO mode by pressing the **[V/M]** key on the “**F-1**” category.
2. Press the **[F]** key briefly to change the **[SMART FUNCTION]** keys to the “**F-2**” category.
3. Press the **[SCAN]** key on the “**F-2**” category to initiate the VFO scan.
4. Press the **[SCAN]** key again to stop the VFO scan.

You may customize the functions of the VFO Scan using the following Set Mode items: “**E02 SCAN DIRECTION**”, “**E03 SCAN RESUME**”, “**E04 SCAN STOP BEEP**” in the “**SCAN**” group and “**F07 RX COVERAGE**” in the “**SYSTEM**” group.

MEMORY SCAN

1. Press the **[F]** key repeatedly until the **[SMART FUNCTION]** keys change to the “**F-1**” category. Then, if necessary, set the “**Main**” band to memory mode by pressing the **[V/M]** key.
2. Press the **[F]** key briefly to change the **[SMART FUNCTION]** key category to “**F-2**”.
3. Press the **[SCAN]** key on the “**F-2**” category to initiate the memory scan.
4. Press the **[SCAN]** key again to stop the memory scan.

You may customize the functions of the Memory Scan using the following Set Mode items “**D03 MEMORY SCAN TYPE**” in the “**MEMORY**” group, “**D04 MEMORY SKIP/SELCT**”, “**E03 SCAN RESUME**”, “**E04 SCAN STOP BEEP**” in the “**SCAN**” group, and “**F07 RX COVERAGE**” in the “**SYSTEM**” group.

PRIORITY CHANNEL SCAN (DUAL WATCH)

This feature is a two-channel scanning function, which allows operation on a VFO or Memory channel, while periodically checking the “**Priority**” memory channel “**000**” for activity.

1. Store the frequency which you wish to check periodically into the “**Priority**” memory channel “**000**”.
2. Press the **[F]** key repeatedly until the **[SMART FUNCTION]** keys change to the “**F-2**” category.
3. Press the **[DW]** key in the “**F-2**” category to initiate the Dual Watch feature. A “**P**” icon will appear on the display when Dual Watch is activated.
4. Press the **[DW]** key again to stop the Dual Watch feature.

You may customize the functions of the Dual Watch feature using the following Set Mode items “**E01 DUAL WATCH STOP**” and “**E03 SCAN RESUME**” in the “**SCAN**” group.

MENU NAVIGATION CHART

SET MODE	AUDIO	A01	AF TONE CONTROL	LOW-3, LOW-2, LOW-1, NORMAL, HIGH-1 , HIGH-2
		A02	SPEAKER	OFF, FRONT, REAR, FRONT+REAR
		A03	STEREO/MONO	MONAURAL , STEREO
		A04	SUB BAND MUTE	OFF, TX MUTE, RX MUTE , TRX MUTE
	TX/RX	B01	MIC GAIN	MIN, LOW, NORMAL, HIGH , MAX
		B02	PTT MODE	MOMENTARY, TOGGLE
		B03	RPT SHIFT DIREC	SHIFT OFF, SHIFT- , SHIFT+
		B04	RPT SHIFT FREQ	0.00 - 99.95 MHz (50 kHz/ step)
		B05	RX EXPANSION	GENERAL , WIDE COVERAGE
		B06	VOX	OFF,REAR HAND-MIC, FRONT HAND-MIC , INTERNAL MIC
		B07	VOX SENSITIVITY	MIN, LOW, NORMAL, HIGH , MAX
		B08	AUTO/WIDE/NARROW	AUTO, WIDE(25KHz), NARROW FM(12.5KHz) , AM
	DISPLAY	C01	DISPLAY SELECT	FREQUENCY: ON , OFF TIMER/CLOCK: ON , OFF
		C02	LCD BRIGHTNESS	MIN, 2, 3, 4, 5, 6, 7, MAX
		C03	LCD COLOR	WHITE-BLUE, SKY-BLUE, MARINE-BLUE, GREEN, YELLOW-GREEN, ORANGE, UMBER, WHITE
		C04	LCD CONTRAST	MIN, 2, 3, 4, 5, 6, MAX
		C05	LCD BACKLIGHT TIME	1, 2, 3,...60, CONSTANT
		C06	KEY BRIGHTNESS	MIN, 2, 3, 4, 5, 6, 7, MAX
	MEMORY	D01	MEMORY DISPLAY	FREQUENCY, ALPHA
		D02	MEMORY EDIT	
		D03	MEMORY SCAN TYPE	ALL MEMORY, SELECT MEMORY
		D04	MEMORY SKIP/SELCT	OFF, SKIP , SELECT
	SCAN	E01	DUAL WATCH STOP	AUTO , HOLD
		E02	SCAN DIRECTION	UP START , DOWN START
E03		SCAN RESUME	BUSY, HOLD, TIME 1 sec, TIMES 3 sec , TIMES 5 sec	
E04		SCAN STOP BEEP	ON , OFF	

SET MODE	SYSTEM	F01	APO	OFF, 0.5 hour, 1.0 hour, 1.5 hour, 2.0 hour ~ 12.0 hour
		F02	ARS	ON , OFF
		F03	AUTO STEP	AUTO, 2.5kHz, 5.00 kHz, 6.25 kHz, 8.33 kHz, 9.00 kHz, 10.00kHz, 12.50 kHz, 15.00 kHz, 20.00 kHz, 25.00 kHz, 50.00 kHz, 100.00kHz, 200.00 kHz
		F04	BEEP	OFF, LOW , HIGH
		F05	F KEY	MHz, AF DUAL 1 (LINE-IN), AF DUAL 2 (AM), AF DUAL 3 (FM), PA, SQL OFF, T-CALL
		F06	MIC P KEY	OFF, SQL OFF, TX POWER, SCAN, RPT SHIFT, REVERSE , T-CALL.
		F07	OPERATION MODE	A , B
		F08	RX COVERAGE	VFO: IN BAND , ALL MEMORY : IN BAND , ALL
		F09	TOT	OFF, 5min, 10min, 15min, 20min, 30min
	TIMER/CLOCK	G01	DATE&TIME ADJUST	
		G02	DATE&TIME FORMAT	DATE : yyyy/mm/dd, yyyy/dd/mm, mm/dd/yyyy , dd/mm/yyyy TIME : 12 hour , 24 hour
		G03	TIME SIGNAL	OFF , ON
		G04	TIME ZONE	UTC-14:00 ~ UTC+14:00 (0.5H / step)
	SIGNALING	H01	BELL RINGER	OFF, 1 time, 3 times, 5 times, 8 times , CONTINUOUS
		H02	DTMF ENCODE MEMORY	
		H03	DTMF MODE	OFF , ON
		H04	DTMF DECODE MEMORY	
		H05	DTMF BAND SELECT	A , B
		H06	SQL EXPANSION	OFF , ON
	PKT	I01	DATA BAND SELECT	DATA: MAIN BAND, DATA: SUB BAND, DATA: L BAND FIX , DATA: R-BAND FIX
		I02	DATA SPEED	DATA: 1200bps , DATA: 9600bps
		I03	DATA SQUELCH	BUSY/TX, BUSY , TX

DTMF OPERATION

MANUAL DTMF TONE GENERATION

1. Press the microphone **PTT** switch to start transmission.
2. While transmitting, press the desired number keys on the microphone.
3. When you have sent all the digits desired, release the **PTT** switch.

DTMF AUTODIALER

1. To store a telephone number to a DTMF memory register, press the **[SET]** key and choose the **"SIGNALING"** group, then choose item **"H02 DTMF ENCODE MEMORY"**. Choose a DTMF register and dial the telephone number. See page 18.
2. Then Set Mode item **"H03 DTMF MODE"** in the **"SIGNALING"** group to **"ON"**. Press the leftside **[DIAL]** key to activate the DTMF Autodialer.
3. Press the **[ESC]** key twice exit from the Set Mode.
4. To send the telephone number, perform the following procedure while pressing the PTT switch:
 - 1) Press the **[DTMF]** key (located at the leftside of the **[SET]** key while transmitting).
 - 2) Rotate the **[DIAL]** knob to select the DTMF memory register corresponding to the telephone number you wish to send.
 - 3) Press the **[DTMF]** key again to transmit the telephone number.
5. To disable the DTMF Autodialer, select the **"OFF"** selection in the Set Mode item **"H03 DTMF MODE"**.

You may send a corresponding telephone number to the DTMF memory by pressing the microphone numeric keys from **[1]** to **[9]**.

MISCELLANEOUS SETTING (SET MODE OPERATION)

The UV-50X3 Series Transceiver offers 47 items in the Set Mode, and they are arranged in 9 groups (A-I). You are able to select the group by rotating the leftside **[DIAL]** knob. Then briefly press the leftside **[DIAL]** knob and rotate it again to select the desired operating item. When you have finished your adjustment, press the **[ESC]** key repeatedly, until the transceiver returns to normal operation.

The groups are as follows.

A: AUDIO, see page 16.

B: TX/RX, see page 17.

C: DISPLAY, see page 18.

D: MEMORY, see page 18.

E: SCAN, see page 19.

F: SYSTEM, see page 19.

G: TIMER/CLOCK, see page 21.

H: SIGNALING, see page 21.

I: PKT, see Page 22.

AUDIO GROUP

A01: AF TONE CONTROL

Function: Select the tone pitch of the received audio.

Available Values: LOW-3, LOW-2, LOW-1, NORMAL, HIGH-1 or HIGH-2

Default: NORMAL

LOW-3: The received audio is enhanced in the low frequency range with a high level effect.

LOW-2: The received audio is enhanced in the low frequency range with a medium level effect.

LOW-1: The received audio is enhanced in the low frequency range with a low level effect.

NORMAL: The received audio does not pass through the tone pitch control.

HIGH-1: The received audio is enhanced in the high frequency range with a low level effect.

HIGH-2: The received audio is enhanced in the high frequency range with a high level effect.

A02: SPEAKER

Function: Select the speaker to be used:

Available Values: FRONT+REAR, FRONT, OFF, or REAR

Default: FRONT+REAR

FRONT+REAR: Receiver audio is routed through the FRONT (located in the front panel) and REAR (located in the transceiver body) speakers.

FRONT: Output the received audio from the FRONT speaker.

OFF: Disable the FRONT and REAR speakers.

REAR: Output the received audio from the REAR speaker.

A03: STEREO/MONO

Function: Select audio output mode.

Available Values: MONAURAL or STEREO

Default: MONAURAL

A04: SUB BAND MUTE

Function: Select the operation method of the MUTE function during dual receive operation.

Available Values: OFF, TX MUTE, RX MUTE, or TRX MUTE

Default: OFF

OFF: Disable the MUTE function.

TX MUTE: Disable the sub band's receiver audio output while transmitting on the main band.

RX MUTE: Disable the sub band's receiver audio output when receiving a signal on the main band.

TRX MUTE: Disable the sub band's receiver audio output while transmitting and received a signal on the main band.

TX/RX GROUP

B01: MIC GAIN

Function: Adjust the microphone gain level.

Available Values: MIN, LOW, NORMAL, HIGH, or MAX

Default: NORMAL

B02: PTT MODE

Function: Select the front panel's PTT key function.

Available Values: MOMENTARY/TOGGLE

Default: MOMENTARY

B03: RPT SHIFT DIREC

Function: Set the repeater shift direction.

Available Values: SHIFT OFF, SHIFT-, or SHIFT+

Default: OFF

B04: RPT SHIFT FREQ

Function: Set the magnitude of the repeater shift.

Available Values: 0.00 - 99.95 MHz (50KHz/step)

Default: Depends on the operating band.

B05: VOX

Function: Enable/Disable VOX operation.

Available Values: OFF, REAR HAND-MIC, FRONT HAND-MIC, or INTERNAL MIC

Default: OFF

OFF:Disable VOX operation.

REAR HAND-MIC: Enable VOX operation for the microphone that is connected to the rear panel MIC jack (located in the transceiver's body).

FRONT HAND-MIC: Enable VOX operation for the microphone that is connected to the front panel MIC jack (located in the control head).

INTERNAL MIC: Enable VOX operation for the microphone that is connected to the front panel microphone.

B06: VOX SENSITIVITY

Function: Set the VOX sensitivity.

Available Values: MIN, LOW, NORMAL, HIGH, or MAX

Default: NORMAL

B07: WIDE/NARROW/AM

Function: Select the receiving mode.

Available Values: AUTO, WIDE(25KHz), NARROW(12.5KHz) or AM

Default: AUTO

Select the desired receiving modes, then the LCD will display "A","W","N","AM".

DISPLAY GROUP

C01: DISPLAY SELECT

Function: Enable/Disable the operating function pages recalled with the [FWD]/[BCK] key.

Available Values:FREQUENCY: ON or OFF,
TIMER/CLOCK: ON or OFF,

Default:FREQUENCY: ON,
TIMER/CLOCK: ON,

C02: LCD BRIGHTNESS

Function: Set the displays illumination level.

Available Values: MIN, 2, 3, 4, 5, 6, 7, or MAX

Default: MAX

C03: LCD COLOR

Function: Select the displays backlight color.

Available Values: WHITE-BLUE, SKY-BLUE, MARINE-BLUE, GREEN,
YELLOW-GREEN, ORANGE, AMBER or WHITE

Default: SKY-BLUE

C04: LCD CONTRAST

Function: Set the display's contrast level.

Available Values: MIN, 2, 3, 4, 5, 6, or MAX

Default: 4

C05 :LCD BACKLIGHT TIME

Function: Set the backlight time of LCD

Available Value: 1,2,3,....60, or Constant.

Default: Always

C06:KEY BRIGHTNESS

Function: Set the key's brightness level

Available Value: MIN,2,3,4,5,6,7 or MAX

Default: 4

MEMORY GROUP

D01: MEMORY DISPLAY

Function: Select the memory channel indication between the "Frequency" and the channel's "Alpha-numeric Tag".

Available Values: FREQUENCY or ALPHA

Default: FREQUENCY

D02: MEMORY EDIT

Function: Access to the memory edit window.

D03: MEMORY SCAN TYPE

Function: Select the operation performed on a "flagged" memory channel.

Available Values: ALL MEMORY or SELECT MEMORY

Default: ALL MEMORY

ALL MEMORY: The scanner will "skip" the flagged (SKIP) channels during scanning.

SELECT MEMORY: The scanner will "only scan" the flagged (SELECT) channels during scanning.

D04: MEMORY SKIP / SELECT

Function: Select the “scan flag” to the current memory channel.

Available Values: OFF, SKIP, or SELECT

Default: OFF

OFF: All memory channels will be scanned

SKIP: The current memory channel is set to scan “SKIP” channel.

SELECT: The current memory channel is set to scan “SELECT” channel.

SCAN GROUP

E01: DUAL WATCH STOP

Function: Select the Dual Watch resume mode.

Available Values: AUTO or HOLD

Default: AUTO

AUTO: The Dual Watch feature will stop when a signal is received on the priority channel. When the signal drops, the Dual Watch will resume.

HOLD: The Dual Watch feature will stop when a signal is received on the priority channel. It will not restart automatically.

E02: SCAN DIRECTION

Function: Select the scan start direction while initiating the scanner using the scan command by pressing the [SCAN] key.

Available Values: UP START or DOWN START

Default: UP START

E03: SCAN RESUME

Function: Select the scan resume mode.

Available Values: BUSY, HOLD, TIME 1 sec, TIME 3 sec, or TIME 5 sec.

Default: TIME 5 sec

BUSY:The scanner will stop when a signal is received, and the scanner will resume after the signal drops.

HOLD:The scanner will stop when a signal is received, not resume automatically.

TIME 1 sec:The scanner will stop when a signal is received, and the scanner will resume after one second.

TIME 3 sec:The scanner will stop when a signal is received, and the scanner will resume after three second.

TIME 5 sec:The scanner will stop when a signal is received, and the scanner will resume after five second.

E04: SCAN STOP BEEP

Function: Enable/Disable the scan stop beep.

Available Values: ON or OFF

Default: OFF

SYSTEM GROUP

F01: APO

Function: Set the Automatic Power-Off time.

Available Values: OFF, 0.5 hour, 1.0 hour, 1.5 hour, 2.0 hour ~ 12.0 hour (1.0 hour/step)

Default: OFF

F02: ARS

Function: Enable/Disable the Automatic Repeater Shift function.

Available Values: ON or OFF

Default: ON

F03: AUTO STEP

Function: Select the DIAL frequency step.

Available Values: AUTO, 2.5KHz, 5.00KHz, 6.25KHz, 8.33KHz, 9.00 kHz, 10.00KHz, 12.50KHz, 15.00KHz, 20.00KHz, 25.00KHz, 50.00KHz, 100.00KHz, or 200.00KHz

Default: AUTO

F04: BEEP

Function: Adjust the beep volume level.

Available Values: OFF, LOW, or HIGH

Default: LOW

F05: F KEY

Function: Select the function of the front panel “F-2” key that is located in the rightside end of the “F-2” category [SMART FUNCTION] keys.

Available Values: MHz, AF DUAL 1 (LINE-IN), AF DUAL 2 (AM), AF DUAL 3 (FM), PA, SQL OFF, T-CALL

Default: AF DUAL 3 (FM)

MHz: Enable tuning of the operating frequency in 1 MHz steps using the [DIAL] knob.

AF DUAL 1 (LINE-IN): Activate the AF Dual function while listening to the Line-In audio.

AF DUAL 2 (AM): Activate the AF Dual function while receiving an AM broadcast station.

AF DUAL 3 (FM): Activate the AF Dual function while receiving an FM broadcast station.

PA: Activate the PA (Public Address) function which sends your voice audio (microphone input) to the transceiver’s speaker.

SQL OFF: Disable the SQL temporarily.

T-CALL: Activate a 1750 Hz burst tone, used for repeater access in

many countries (especially in Europe).

F06: MIC P KEY

Function: Select the function of the microphone’s [P1]/[P2]/[P3]/[P4] programmable keys.

Available Values: OFF, SQL OFF, TX POWER, SCAN, RPT SHIFT, REVERSE, T-CALL.

Default: P1: SQL OFF, P2: TX POWER, P3: PRT SHIFT, P4: REVERSE

OFF: Not active.

SQL OFF: Disable the SQL temporarily.

TX POWER: Select the desired transmit power output level.

SCAN: Activates the scanner.

RPT SHIFT: Select the repeater shift direction.

REVERSE: Reverse transmit and receive frequencies while working through a repeater.

T-CALL: Activate a 1750 Hz burst tone, used for repeater access in many countries (especially in Europe).

F07: OPERATION MODE

Function: Change the frequency of CPU clock.

Available Values: A or B

Default: A

This Set Mode item is only used to move a spurious response “birdie”, should it fall on a desired frequency.

F08: RX COVERAGE

Function: Enable or disable band limiting for the VFO frequency selection and memory channel recalling.

Available Values: VFO: IN BAND or ALL, MEMORY: IN BAND or ALL

Default: VFO: IN BAND, MEMORY: ALL

VFO IN BAND: When the VFO frequency reaches the high band edge

of the current band, the VFO frequency will jump to the low band edge of the current band (vice versa).

VFO ALL: When the VFO frequency reaches the high band edge of the current band, the VFO frequency will jump to the low band edge of the next band (vice versa).

MEMORY IN BAND: Recall only the memory channels, which are stored in the same band with the current memory channel.

MEMORY ALL: Recall all memory channels regardless of the band.

F09: TOT

Function: Set the TOT time. When your transmission time reaches the selected time, the transceiver returns to the RX mode automatically.

Available Values: OFF, 5 min, 10 min, 15min, 20 min, or 30 min

Default: OFF

TIMER/CLOCK GROUP

G01: DATE&TIME ADJUST

Function: Set the clock time.

1. Press the leftside **[DIAL]** knob to enable the adjustment of this item.
2. Input your local time using the 24-hour system. Use the **[←]** / **[→]** key to navigate to each column, then rotate the leftside **[DIAL]** knob to select the desired numbers in each column.
3. Press the leftside **[DIAL]** knob again to save the new setting.

G02: DATE&TIME FORMAT

Function: Select the display format for date and time.

Available Values: DATE: yyyy/mm/dd, yyyy/dd/mm, mm/dd/yyyy, or dd/mm/yyyy TIME: 12 hour or 24hour

Default: DATE: mm/dd/yyyy, TIME: 24hour

G03: TIME SIGNAL

Function: Enable/Disable the Timer Signal “on” and “off”.

Available Values: OFF or ON

Default: OFF

G04: TIME ZONE

Function: Set the time offset between local time and UTC.

Available Values: UTC–14:00 ~ UTC+14:00 (0.5H/step)

Default: UTC±0:00 LONDON

SIGNALING GROUP

H01: BELL RINGER

Function: Enable/Disable the Bell ringer function and select Bell ringer repetitions.

Available Values: OFF, 1 time, 3 times, 5 times, 8 times, or CONTINUOUS

Default: OFF

When this item is enabled, the transceiver emits a “bell” sound when a signal is received that contains a CTCSS tone, DCS code or CTCSS tone pair that matches the setting of the decoder.

H02: DTMF ENCODE MEMORY

Function: Program the ENCODE DTMF string used in the DTMF autodialer. There are nine memories available.

1. Rotate the leftside **[DIAL]** knob to select the DTMF memory register (1-9) into which you wish to store.
2. Press the leftside **[DIAL]** knob briefly.
3. Rotate the leftside **[DIAL]** knob, or press one of the microphone’s keypad buttons, to select the first digit of the DTMF string.
4. When you have selected the first digit of the DTMF string using the left side DIAL knob, press the **[→]** key to move to the next digit.
5. Repeat steps 3 and 4 to program the remainder of the DTMF string.
6. You may backspace the cursor by pressing the **[←]** key. And delete the current characters
7. Press the **[DIAL]** key to save the setting.

H03: DTMF MODE

Function: Enable/Disable the DTMF autodialer feature. See page 12 for details.

Available Values: OFF or ON

Default: OFF

H04: DTMF DECODE MEMORY

Function: Program the ENCODE DTMF string used in the DTMF autodialer. There are nine memories available.

The operation method is the same as "H02: DTMF ENCODE MEMORY".

H05:DTMF BAND SELECT(DTMF DECODE SELECTION)

Function: Set the DTMF decoding path

Available Value: A,B

Default: A

A: Main-band

B: Sub-band

H06: SQL EXPANSION

Function: Enable/Disable the split CTCSS/DCS coding.

Available Values: OFF or ON

Default: OFF

When this item is set to "ON", the following parameters are added to the squelch selections available when pressing the [TYPE] key in the SQL category buttons.

DCS ENC: DCS Encoder only. "DC" icon will appear while operating.

TONE DCS: Encode a CTCSS tone and decodes a DCS code. "T-D" icon will appear while operating.

DCS TSQL: Encode a DCS code and decodes a CTCSS tone. "D-T" icon will appear while operating.

PKT(Data Transmission)

I01: DATA BAND SELECTION

Function: Set the data transmission path for transceiving

Available Value: DATA: MAIN BAND, DATA:SUBBAND,DATA:L-BAND FIX, DATA:R-BAND FIX

Default: R-BAND FIX

MAIN BAND: Only for transceiving transmission in Main Band

SUB BAND: Only for transceiving transmission in Sub Band

L-BAND FIX: Fix to transceiving transmission in the left part

R-BAND FIX: Fix to transceiving transmission in the right part

I02: DATA SPEED

Function: Set the data transmission rates for transceiving

Available Value: DATA:1200bps, DATA: 9600bps

Default: DATA: 1200bps

1200: transmission rates at 1200 bps

9600: transmission rates at 9600 bps

I03: DATA SQUELCH

Function: Set the squelch level state

Available Value: BUSY/TX, BUSY, TX

Default: BUSY/TX

BUSY/TX: The squelch level when receiving the effective signal and effectively transmitting

BUSY: The squelch level when receiving the effective signal

TX: The squelch level when effectively transmitting

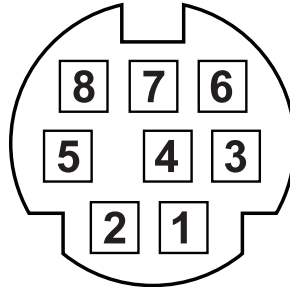

Pin No.	Pin Name	Input / Output	Function
1	PKD	Input	Packet data input TX data from TNC to transceiver (775mVrms)
2	GND	----	Ground for PKD
3	PKS	Input	“L” is transmitted and microphone is muted
4	RX9600	Output	Output of detected 9600bps data (150mVrms)
5	RX1200	Output	Output of detected 1200bps data (100mVrms)
6	PKSQL	Output	Squelch control signal Open squelch: +5V (High) Closed squelch: 0V (L)
7	TXD	Output	PC serial data output RS-232C level / Polarity
8	RXD	Input	PC serial data Input RS-232C level / Polarity

INSTALLATION

This chapter describes the installation procedure for integrating the transceiver into a typical amateur radio station. It is presumed that you possess technical knowledge and conceptual understanding consistent with your status as a licensed radio amateur. Please take some extra time to make certain that the important safety and technical requirements detailed in this chapter are followed closely.

PRELIMINARY INSPECTION

Inspect the transceiver visually immediately upon opening the packing carton. Confirm that all controls and switches work freely, and inspect the cabinet for any damage. Gently shake the transceiver to verify that no internal components have been shaken loose during shipping.





If any evidence of damage is discovered, document it thoroughly and contact the shipping company (or your local dealer, if the unit was purchased over-the-counter) so as to get instructions regarding the prompt resolution of the damage situation. Be certain to save the shipping carton, especially if there are any punctures or other evidence of damage incurred during shipping. If it is necessary to return the unit for service or replacement, use the original packing materials. Then put the entire package inside another packing carton to preserve the evidence of shipping damage for insurance purposes.

INSTALLATION TIPS

To ensure long life of the components, be certain to provide adequate ventilation around the cabinet of the transceiver.

Do not install the transceiver on top of another heat-generating device (such as a power supply or amplifier) and in a location exposed to dust and/or high humidity. Avoid heating vents and window locations that

could expose the transceiver to excessive direct sunlight, especially in hot climates. This transceiver should not be used in an environment where the ambient temperature exceeds +140 °F (+60 °C).

-  This transceiver is designed for a 13.8 V power source. Never use a 24 V battery to power the transceiver.
-  The vehicle battery must have a nominal rating of 12 V. Never connect the transceiver to a 24 V battery. Be sure to use a 12 V vehicle battery that has sufficient current capacity. If the current to the transceiver is insufficient, the display may darken during transmission, or transmit output power may drop excessively.
-  If you use the transceiver for a long period when the vehicle battery is not fully charged, or when the engine is OFF, the battery may become discharged, and will not have sufficient reserves to start the vehicle. Avoid using the transceiver under these conditions.
-  Transmitting without first connecting an antenna or other matched load will damage will transceiver. Always connect the antenna to the transceiver before applying power or transmitting.

The installation of the mounting bracket for front panel.

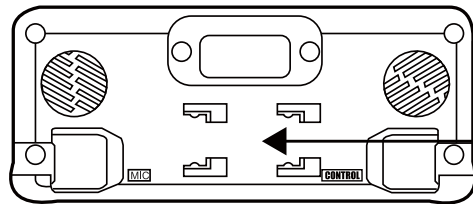

Mounting Bracket Connector

1. Inserted into the connector
2. Slide to the left

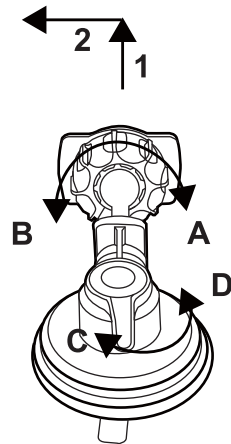

- A: Screw
- B: Unscrew
(Adjust the tightness of rotation by A/B)
- C: Unlock
- D: Lock

The newly designed 360 degree suction cup mounting bracket allows for superior suction and durability in the roughest environments. The bracket also allows you to remove the display for use or storage when required. All without the use of permanent mounting screws.

The installation of the mounting bracket for main transceiver.

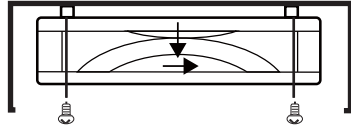

Figure 1

Important Note:

1. Please follow figure 1 to properly installed the bracket that houses the cooling fan.
2. Ensure that the transceiver is installed in the bracket in such a way that the fan will cool the heat sink side of transceiver, not the speaker side.
3. The fan will automatically turn on when its temperature is beyond a defined temperature.

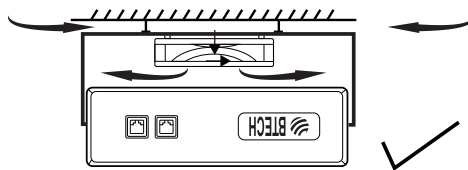

Figure 2

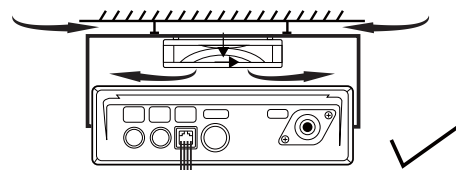

Figure 3

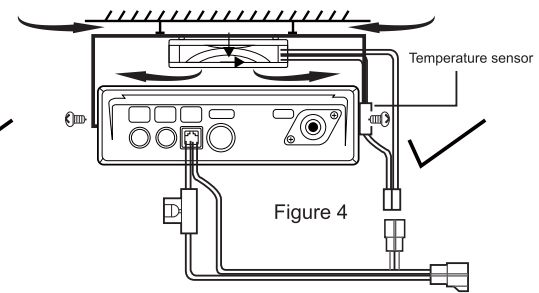

Figure 4

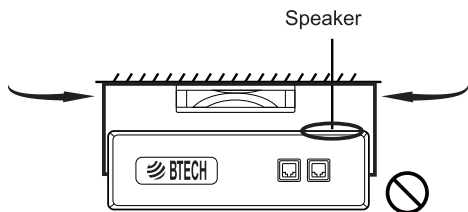

Figure 5

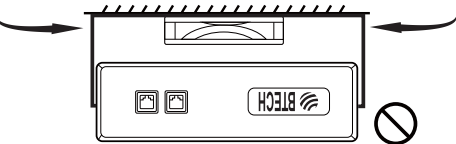

Figure 6

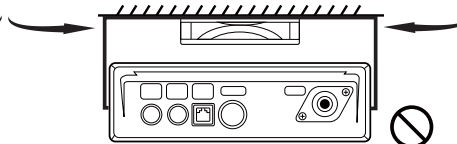



Figure 7

*The figure 5, 6, 7 Incorrect installation method.

SAFETY INFORMATION

This transceiver is an electrical apparatus, as well as a generator of High RF (Radio Frequency) energy. You should exercise all safety precautions that are appropriate for this type of device. These safety tips apply to any device installed in a well-designed amateur radio station.

 Never allow unsupervised children to play in the vicinity of your transceiver or antenna installation.

 Be certain to wrap any wire or cable splices thoroughly with insulating electrical tape, to prevent short circuits.

 Do not route cables or wires through doorjambs or other locations where they may become frayed and shorted to ground or to each other.

 Do not stand in front of a directional antenna while you are transmitting into that antenna.

 Do not install a directional antenna in any location where humans or pets may walk in the main directional lobe of the antenna's radiation pattern.

 In mobile installations, it is preferable to mount the antenna on top of the vehicle, if feasible, this will utilize the car body as a counterpoise and raise the radiation pattern as far away from passengers as possible.

 During mobile operation when stopped (in a parking lot, for example), make it a practice to switch to Low power if there are people walking nearby.

 Never wear dual-earmuff headphones while driving a vehicle. Do not attempt to drive your vehicle while making a telephone or auto patch call.

 While using the optional DTMF microphone. Pull over to the side of the road, whether dialing manually or using the auto-dial feature.

 Do not connect the modular connector of the telephone line to MIC jack.

 **Warning!:** High RF voltage is present in the TX RF section of the transceiver while transmitting. Do not touch the TX RF section while transmitting.

SPECIAL FUNCTION MENU

Static electricity may occasionally cause erratic or unpredictable operation of the microprocessor. If this happens, resetting of the microprocessor may restore normal operation. Note that resetting the microprocessor will erase all memories.

1. Turn the radio "Off".
2. Press and hold the key located on the [POWER] and [SET] switch while turning the radio on, to enter the "Special Function" mode.
3. Rotate the left side [DIAL] knob to select one of the following items:
 - ① **ALL RESET**: Clear all storage setting and other setting to restore the factory setting.
 - ② **SYSTEM RESET**: Restore the setting mode (except PKT group) to the factory default value.
 - ③ **XBAND REPEATER**: Activate cross band Repeater operation. Set the right band to a 144MHz frequency and the left band to a 430MHz frequency (or vice versa) before beginning this procedure.

4. Once you have made your selection in step 3, press the leftside [DIAL] knob and confirm that (OK?) is displayed on the LCD. Press the leftside [DIAL] knob once more to procedure.

*1:Repeat the steps above to exit XBAND REPEATER.

Important Note

1. When operating this transceiver in XBAND Repeater mode, Avoid Using 3rd Harmonic Frequencies in the UHF Mode. For example VHF 144 and UHF 432 would not work and may cause de-sensing of the UHF Band in the transceiver.
2. Always use the lowest power setting required (Low/Mid) while using the XBAND Repeater mode. Failure to follow this recommendation may damage the transceiver and void any warranty. If you require a high power repeater, please consider purchasing Professional repeater Product.

RESET PROCEDURE

This feature will reset the transceiver to "Factory Default" Which means all setting will be returned to default values & all channels will be erased. Please ensure you have recorded all your setting & frequencies before attempting this procedure.

1. Turn the radio "off".
2. Press and hold the key located on the [POWER] and [SET] switch while turning the radio on, to enter the "Special Function" mode.
3. Rotate the leftside [DIAL] knob to select "ALL RESET".
4. Press the leftside [DIAL] knob and confirm that (OK?) is displayed on the LCD.
5. Press the leftside [DIAL] knob once more to complete the reset procedure.

ACCESSORIES & OPTIONS

SUPPLIED ACCESSORIES

DTMF Microphone (HM-68)	1
Mobile Mounting Bracket for Front Panel (MMB-66A)	1
Mobile Mounting Bracket for Rear Chassis (MMB-66B)	1
DC Power Cable W/Fuse	1
Control Cable (5m)	1
Spare Fuse (15A, 32V)	1
UV-50X3 Series Operating Manual	1

OPTIONAL ACCESSORIES

Bluetooth TNC & GPS APRS	BTG-50X3A1
Programming cable	PC05

TROUBLE SHOOTING

The problems described in the following tables are commonly encountered operational malfunctions. These types of difficulties are usually caused by improper hook-up, accidental incorrect control settings, or operator error due to incomplete programming. These problems are usually not caused by circuit failure. Please review these tables and the appropriate section(s) of this instruction manual before assuming your transceiver is defective.

Problem	Probable Cause	Corrective Action
The transceiver will not power up after connecting a 13.8 V DC power supply and pressing the [] (Power) switch. Nothing appears on the display.	<ol style="list-style-type: none"> 1.The power cable was connected backwards. 2.One or more of the power cable fuses are open. 	<ol style="list-style-type: none"> 1. Connect the supplied DC power cable correctly: Red → (+); Black → (-). 2. Look for the cause of the blown fuse(s). After inspecting and correcting any problems, install a new fuse(s) with the same ratings.
The display is too dim, even though you selected a high brightness level.	The supply voltage is too low.	The supply voltage requirement is 13.8 V DC 15% (11.7 V to 15.8 V DC). If the input voltage is outside this range, adjust your regulated power supply and/or check all power cable connections.
The frequency cannot be selected by turning the [DIAL] knob or by pressing Mic [UP] / [DWN] .	Memory Recall was selected.	Press [VM].
Most buttons/keys and the [DIAL] knob do not function.	One of the Lock functions is ON.	Unlock all of the Lock functions.

Problem	Probable Cause	Corrective Action
The LCD displays abnormally.	The keys was wrongly pressed or wrongly combined.	Pull up the plug of the transceiver, then re-plug it.
You cannot transmit even though you press Mic [PTT]	<ol style="list-style-type: none"> 1. You selected a transmit band that places the transmit frequency outside the allowable transmit frequency range. 2. The transmitting frequency is beyond the allowable scope because of wrongly selecting the RPT SHIFT DIREC and RPT SHIFT FREQUENCY. 3. The microphone plug was not inserted completely into the front panel connector.. Or the plug cable of the microphone is disconnect. 	<ol style="list-style-type: none"> 1. Select the allowable transmitting frequency. 2. Select the proper RPT SHIFT DIRE and RPT SHIFT FREQUENCY. 3 Switch OFF the power, then insert the microphone plug until the locking tab clicks in place. Otherwise, replace the microphone.
The voice of RX signal is abnormal.	The AUTO/WIDE/NARROW/AM does not confirm to the operating frequency features.	Correctly set the AUTO/WIDE/NARROW/AM to confirm the operating frequency

SPECIFICATIONS

General

Frequency Range:	VHF:136-174MHz UHF: 400-480MHz
Antenna Gain:	3.5dBi
Channel Step:	2.5, 5, 6.25, 10, 12.5, 15, 20, 25, 50, 100, 200KHz.
Frequency Stability:	± 1 ppm (+14°F to +140°F [-10°C to +60°C])
Repeater Shift:	±600KHz (144MHz) ±1.6 / 5.0 / 7.6 MHz (430MHz)
Emission Type:	F3E
Antenna Impedance:	50 Ω
Supply Voltage:	Nominal: 13.8V DC, Negative Ground Operating: 11.7 - 15.8V, Negative Ground
Current Consumption:	0.5A (Receive) 10A (TX, 144 MHz 50W) 12A (TX, 430 MHz 50W)
Operating Temperature:	-22°F to +140°F (-30°C to +60°C)
Case Size (WxHxD):	Panel: 6.3" x 2.6" x 1.3" (157 x 66 x 33.5 mm) Panel w/o knob connectors Panel: 5.5" x 1.8" x 6.0" (140 x 46 x150mm) Panel w/o knob connectors
Weight (Approx)	4.6 lbs (2.1kg) Rear Chassis.

Transmitter

RF Power Output:	12.5 kHz Rated Output Power:VHF&UHF: High: 50W, Middle:20W Low: 5W 6.25 kHz Rated Output Power:VHF&UHF: 1W
Modulation Type:	Variable Reactance F1, F2, F3
Channel Spacing:	6.25 kHz , 12.5kHz
Spurious Emission:	At least 60dB below
Microphone Impedance:	2KΩ

Receiver											
Circuit Type:	Double-Conversion Super heterodyne (FM/AM) Single-Conversion Super heterodyne (Radio)										
Intermediate Frequencies:	1st: 49.950kHz (A Band) 2nd: 450KHz ("Left Side" Band, FM/AM) 1st: 45.450KHz (B Band) 2nd: 450KHz ("Right Side" Band, FM/AM)										
Sensitivity:	<table border="0"> <tr> <td>1st: 50KHz (AM Radio)</td> <td>1μV TYP for 12dB SINAD</td> </tr> <tr> <td>5μV TYP for 10dB SN</td> <td>0.8μV TYP for 10dB SN</td> </tr> <tr> <td>2μV TYP for 12dB SINAD</td> <td>0.25μV TYP for 12dB SINAD</td> </tr> <tr> <td>0.8μV TYP for 10dB SN</td> <td>0.2μV for 12dB SINAD</td> </tr> <tr> <td>0.2μV for 12dB SINAD</td> <td>0.5μV TYP for 12dB SINAD</td> </tr> </table>	1st: 50KHz (AM Radio)	1 μ V TYP for 12dB SINAD	5 μ V TYP for 10dB SN	0.8 μ V TYP for 10dB SN	2 μ V TYP for 12dB SINAD	0.25 μ V TYP for 12dB SINAD	0.8 μ V TYP for 10dB SN	0.2 μ V for 12dB SINAD	0.2 μ V for 12dB SINAD	0.5 μ V TYP for 12dB SINAD
1st: 50KHz (AM Radio)	1 μ V TYP for 12dB SINAD										
5 μ V TYP for 10dB SN	0.8 μ V TYP for 10dB SN										
2 μ V TYP for 12dB SINAD	0.25 μ V TYP for 12dB SINAD										
0.8 μ V TYP for 10dB SN	0.2 μ V for 12dB SINAD										
0.2 μ V for 12dB SINAD	0.5 μ V TYP for 12dB SINAD										
Squelch Sensitivity:	0.13 μ V (144/430MHz Band)										
Selectivity (Typical):	<table border="0"> <tr> <td>(Wide)</td> <td>More than 10KHz/6dB</td> </tr> <tr> <td></td> <td>Less than 30.KHz/60dB</td> </tr> <tr> <td>(Narrow)</td> <td>More than 6KHz/6dB</td> </tr> <tr> <td></td> <td>Less than 20.KHz/60dB</td> </tr> </table>	(Wide)	More than 10KHz/6dB		Less than 30.KHz/60dB	(Narrow)	More than 6KHz/6dB		Less than 20.KHz/60dB		
(Wide)	More than 10KHz/6dB										
	Less than 30.KHz/60dB										
(Narrow)	More than 6KHz/6dB										
	Less than 20.KHz/60dB										
AF Output:	8W @ 4 Ω for 10% THD (@ 13.8 V) BTL EXP SP 4W @ 4 Ω for 10% THD (@ 13.8V) Normal EXP SP										
AF Output Impedance:	4-16 Ω										