



# CASTLES TECHNOLOGY

*UPT1000*

---

*Book 2*

***User Manual***

**Confidential**

*Version 1.1*

*Jan. 2017*

**Castles Technology Co., Ltd.**

6F, No. 207-5, Sec. 3, Beixin Rd., Xindian District,  
New Taipei City 23143, Taiwan R.O.C.

<http://www.castech.com.tw>

# WARNING

Information in this document is subject to change without prior notice.

No part of this publication may be reproduced, transmitted, stored in a retrieval system, nor translated into any human or computer language, in any form or by any means, electronic, mechanical, magnetic, optical, chemical, manual, or otherwise, without the prior written permission of **Castles Technology Co., Ltd.**

All trademarks mentioned are proprietary of their respective owners.

## Revision History

| <i>Version</i> | <i>Date</i>  | <i>Descriptions</i>                  | <i>Author</i> |
|----------------|--------------|--------------------------------------|---------------|
| 1.0            | Dec 19, 2016 | Initial creation.                    | Jeff          |
| 1.1            | Jan 11, 2017 | Add "7. Appinex" and "7.1 Cautions". | Jeff          |
|                |              |                                      |               |
|                |              |                                      |               |
|                |              |                                      |               |
|                |              |                                      |               |
|                |              |                                      |               |
|                |              |                                      |               |
|                |              |                                      |               |

# Contents

|                                     |           |
|-------------------------------------|-----------|
| <b>1. Introduction</b> .....        | <b>6</b>  |
| <b>2. Hardware Setup</b> .....      | <b>7</b>  |
| 2.1. Parts of the UPT1000 .....     | 7         |
| 2.2. Communication Support .....    | 8         |
| <b>3. Basic Operation</b> .....     | <b>9</b>  |
| 3.1. Program Manager.....           | 9         |
| 3.2. Download AP .....              | 10        |
| 3.3. System Info.....               | 11        |
| 3.4. Memory Status .....            | 12        |
| 3.5. System Settings.....           | 13        |
| 3.6. Test Utility.....              | 16        |
| 3.7. Factory Reset .....            | 18        |
| 3.8. Power Off .....                | 19        |
| 3.9. FK PWD Change .....            | 20        |
| 3.10. Share Object Management.....  | 21        |
| 3.11. Embedded TMS.....             | 22        |
| 3.12. Font Mng .....                | 23        |
| 3.13. Debug Tools .....             | 24        |
| 3.14. ULD Key Hash.....             | 25        |
| 3.15. HW Detect .....               | 26        |
| 3.16. Bluetooth Setup .....         | 27        |
| 3.17. Plug-in Mng .....             | 28        |
| 3.18. Key Injection .....           | 29        |
| <b>4. Secure File Loading</b> ..... | <b>30</b> |
| 4.1. ULD Key System .....           | 30        |
| 4.1.1. ULD Manufacturer Key.....    | 30        |
| 4.1.2. ULD User Key .....           | 32        |
| 4.1.3. Key Change .....             | 32        |
| 4.2. File Signing.....              | 33        |
| 4.2.1. Signing Kernel Module .....  | 33        |
| 4.2.2. Signing User Files .....     | 35        |
| 4.3. File Loading .....             | 39        |
| 4.3.1. Download by User Loader..... | 39        |

|   |           |
|---|-----------|
| 4.3.2. Download by Removable Media..... | 42        |
| 4.4. Changing ULD User Key.....         | 44        |
| <b>5. Font Management .....</b>         | <b>51</b> |
| 5.1. Loading New Font.....              | 51        |
| 5.2. Custom Font.....                   | 54        |
| 5.3. Using TrueType Font (TTF) .....    | 62        |
| <b>6. Technical Notes .....</b>         | <b>64</b> |
| 6.1. Serial Cable PIN Assignment.....   | 64        |
| <b>7. Appendix .....</b>                | <b>65</b> |
| 7.1. Cautions .....                     | 65        |

# 1. Introduction

This document provides a guideline on operating and configuring Castles UPT1000 .

The scope of this document includes setting up the UPT1000, basic operation, application life cycle, and some advance features.

## 2. Hardware Setup

### 2.1. Parts of the UPT1000

*Front*



UPT1000

- |                            |                                  |
|----------------------------|----------------------------------|
| 1. LCD Display (Color TFT) | 7. Cancel Key                    |
| 2. Keypad                  | 8. Magnetic Stripe Reader        |
| 3. Smart Card Reader       | 9. Contactless Card Landing Zone |
| 4. Enter Key               | 10. LED indicator                |
| 5. Return Key (RFU)        |                                  |
| 6. Clear Key               |                                  |

Rear

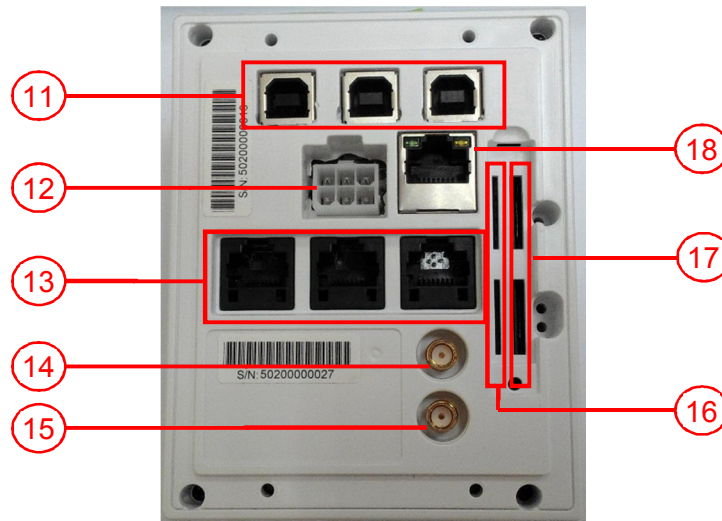

UPT1000

- 11. USB port 1~3
- 12. MDB (power connector)
- 13. RS232 port 1~3
- 14. BT antenna socket
- 15. GPRS antenna socket
- 16. GSM SIM Card Slots 1~2
- 17. SAM Card Slots 1~4
- 18. LAN port

## 2.2. Communication Support

- 1. Ethernet
- 2. BT
- 3. UMTS 850/1900
- 4. GPRG 850/1900



## 3. Basic Operation

### 3.1. Program Manager

Once the power is on in normal status, UPT1000 will enter Program Manager if no default application selected. All user applications are listed in Program Manager. Users can select an application and run the application, view the application info, delete the application, or set application to the default one to run once the power is on. Users may enter System Menu to configure UPT1000 settings.

#### Program Manager

```
Program Manager
-----01/02
1.App1
2.App2

0:Download
```

- Press [0] button to enter System Menu.
- Press [1] button to toggle default application selection.
- Press [2] button to delete application.
- Press [3] button to view application info.
- Press [OK] button to run application.
- Press [↑] or [↓] as the up and down button to select application.

#### System Menu

*Page 1*

```
System Menu
1.Download AP
2.System Info
3.Memory Status
4.Sys Settings
5.Test Utility
6.Factory Reset
7.Power Off
```

- Press [↓] button to page 2.

### Page 2

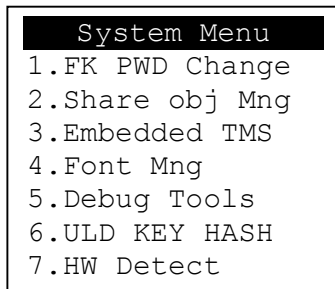

- Press [↑] button to page1.
- Press [↓] button to page3.

### Page 3

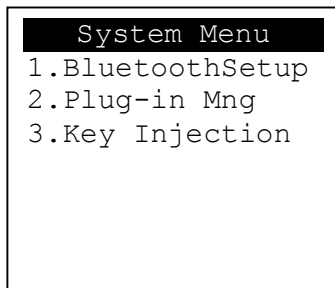

- Press [↑] button to page2.

## 3.2. Download AP

Download user application or kernel modules firmware.

### System Menu

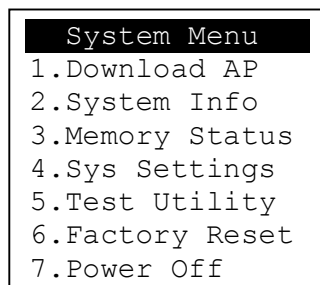

- Press [1] button to enter Download AP menu.

### Download AP Menu

```

Download EX
1.RS232 or USB
2.USB Disk
3.SD Card

Select DW Source

```

Select download source:

- Press [1] button to select source as RS232 or USB connection and enter ULD download mode.
- Press [2] button to select source as USB disk.
- Press [3] button to select source as SD card. (Not support)

### 3.3. System Info

View kernel module firmware information.

#### System Menu

```

System Menu
1.Download AP
2.System Info
3.Memory Status
4.Sys Settings
5.Test Utility
6.Factory Reset
7.Power Off

```

- Press [2] button to enter System Info menu.

#### System Info Menu

Page 1

```

SYSTEM INFO
---Kernel Ver---
BIOS      :VR0024
SULD      :VRF010
LINUXKNL :VR0024
ROOTFS    :VR0010

```

Page 2

```

SYSTEM INFO
--- KOver ---
SECURITY :VR0025
KMS      :VR0027
DRV      :VR0046
USB      :N/A
CIF      :VR0025
SAM      :VR0034

```

Page 3

```

SYSTEM INFO
--- KOver2 ---
CL       :VR0018
SC       :VR0011

```

- Press [↓] button to next page.

Page 4

```

SYSTEM INFO
----- SOVer-----
UART      :VR0017
USBH      :VR0011
MODEM     :VR0019
ETHERNET  :VR0035
FONT      :VR0032
LCD       :VR0042

```

Page 5

```

SYSTEM INFO
----- SO Ver2 ---
PRT       :VR0025
RTC       :VR0013
ULDPM     :VR0029
PPPMODEM :VR0031
KMS       :VR0032
FS        :VR0016

```

Page 6

```

SYSTEM INFO
--- SO Ver3 ---
GSM       :VR0029
BARCODE   :VR0013
TLS       :VR0014
CLVW     :VR0024
CTOSAPI   :VR0039

```

Page 8

```

SYSTEM INFO
--- HWMVer ---
CRDL/ETHE:ONCHIP
CLM-MP    : N/A
--- APVer ---
ULDPM     :VR0036

```

Page 9

```

SYSTEM INFO
HUSBID:0CA6A050
CUSBID:N/A
--Factory S/N---
FFFFFFFFFFFFFFFF

```

Page 10

```

SYSTEM INFO
--EXT SO Ver P.1--
CACLMDL   :VR0008
CACLENTY  :VR0008
CAMPP     :VR0007
CAVPW     :VR0019
CAAEP     :VR0004
CAJCT     :VR0007

```

### 3.4. Memory Status

View flash memory and RAM information.

#### System Menu

```

System Menu
1.Download AP
2.System Info
3.Memory Status
4.Sys Settings
5.Test Utility
6.Factory Reset
7.Power Off

```

- Press [3] button to enter Memory Status menu.

#### Memory Status Menu

```

MEMORY STATUS
--FLASH Memory--
Total: 130688KB
Used : 44644KB

--SDRAM Memory--
Total: 65408KB
Used : 32384KB

```

### 3.5. System Settings

View or change system settings.

| <b>Setting</b> | <b>Descriptions</b>  |
|----------------|--|
| Key Sound      | Enable (Y) or disable (N) the beep sound when pressing any key.                              |
| Exec DFLT AP   | Enable (Y) or disable (N) execution of default selected application.                         |
| USB CDC Mode   | Enable (Y) or disable (N) USB CDC mode.  |
| FunKey PWD     | Enable (Y) or disable (N) password protection to access function key "0" in Program Manager. |
| PMEnter PWD    | Enable (Y) or disable (N) password protection to enter Program Manager.                      |
| SET USB Host   | Enable (Y) or disable (N) USB host mode.   |
| Base USB CDC   | Enable (Y) or disable (N) USB CDC mode in base unit. (Not support)                           |
| List SHR Lib   | Enable (Y) or disable (N) to list all shared libraries in Program Manager.                   |
| Key MNG Mode   | <TBC>  |
| BATThreshld    | Battery charging threshold value. (Not support)  |
| Null Cradle    | Enable (Y) if base is Type Acradle. (Not support)  |
| Debug Mode     | Enable (Y) or disable (N) console debug mode.  |
| Debug Port     | Serial port for console debug.   |
| Mobil AutoON   | Enable (Y) or disable (N) to auto turn on GSM module after boot up.                          |
| Bklit Auto Off | Enable (Y) or disable (N) Auto Off LCD Backlight   |
| Bklit Off Time | Threshold of Auto Off LCD Backlight  |
| PWR KEY OFF    | Power keyfunction, power off (Y) or reboot(N)  |
| GDB Mode       | Enable (Y) or disable (N) GDB (GNU Debugger) mode. (Needs to download GDB plugin FW first.)  |
| GDB Timeout    | Set GDB connection timeout.  |
| GDB Channel    | Set GDB connection channel.  |
| ETHER IP/PORT  | GDB Ethernet connection setting.   |
| RTC Time Zone  | Set Time Zone of RTC (Real Time Clock).  |

|                  |  |
|------------------|--|
| NTP Enable       | Enable (Y) or disable (N) NTP (Network Time Protocol) function.                |
| NTP Update Freq  | Frequency of Network Time Protocol updating.                                   |
| Halt Timeout     | Set timeout of AP to get back to Program Manager whenever AP is in halt state. |
| PWM Auto         | Enable (Y) or disable (N) power saving mode.                                   |
| PWM Mode         | Select (STB) standby mode or (SLP) sleep mode for power saving mode.           |
| PWM Time         | Set time period to make machine enter power saving mode from idle state.       |
| BAT PROTECT MODE | Set battery protect mode. (Not support)  |

### System Menu

|                    |
|--------------------|
| <b>System Menu</b> |
| 1.Download AP      |
| 2.System Info      |
| 3.Memory Status    |
| 4.Sys Settings     |
| 5.Test Utility     |
| 6.Factory Reset    |
| 7.Power Off        |

- Press [4] button to enter System Settings menu.

### System Settings Menu

#### *Page 1*

|                     |     |
|---------------------|-----|
| <b>SYS SETTINGS</b> |     |
| Key Sound           | : Y |
| Exec DFLT AP        | : Y |
| -Default AP Name    |     |
| USB CDC Mode        | : Y |
| FunKey PWD          | : N |
| PMEnter PWD         | : N |
| 2: Next Page        |     |

#### *Page 2*

|                     |         |
|---------------------|---------|
| <b>SYS SETTINGS</b> |         |
| SET USB Host        | : N     |
| Base USB CDC        | : X     |
| List SHR Lib        | : N     |
| Key MNG Mode        | : 0     |
| Bat Threshld        | : X     |
| Null Cradle         | : X     |
| 1: Prev             | 2: Next |

#### *Page 3*

|                     |         |
|---------------------|---------|
| <b>SYS SETTINGS</b> |         |
| Debug Mode          | : N     |
| Debug Port          | : X     |
| Mobil AutoON        | : N     |
| Bklit Auto Off      | : N     |
| BklitOff Time       | : X     |
| PWR KEY OFF         | : N     |
| 1: Prev             | 2: Next |

#### *Page 4*

|                     |         |
|---------------------|---------|
| <b>SYS SETTINGS</b> |         |
| GDB Mode            | : GMT   |
| GDB Timeout         | : N     |
| GDB Channel         | : X     |
| ETHER IP/PORT       |         |
| 1: Prev             | 2: Next |

*Page 5*

```

  SYS SETTINGS
RTC Time Zone   : GMT
NTP Enable     : N
NTP Update Freq : X

1: Prev       2: Next

```

*Page 6*

```

  SYS SETTINGS
Halt Timeout   : 0
PWM Auto       : X
PWM Mode       : X
PWM Time       : X
BAT PROTECT MODE : X

1: Prev Page

```

- Press [↑] or [↓] button to select setting.
- Press [OK] button to change the setting value.
- Press [<] button to toggle Y ⇒ N ⇒ Y.
- Press [1] button to previous page.
- Press [2] button to next page.

## 3.6. Test Utility

Perform hardware components diagnosis.

### System Menu

```
System Menu
1.Download AP
2.System Info
3.Memory Status
4.Sys Settings
5.Test Utility
6.Factory Reset
7.Power Off
```

- Press [5] button to enter Test Utility menu.

### Test Utility Menu

*Page 1*

```
Main Menu 9123
1.LCD
2.Keyboard
3.Flash
4.Smart Card
5.Backlight
6.MSR
-> 1/3
```

- Press [1] and [OK] to diagnose LCD.
- Press [2] and [OK] to diagnose keyboard.
- Press [3] and [OK] to diagnose flash memory.
- Press [4] and [OK] to diagnose smart card module.
- Press [5] and [OK] to diagnose backlight.
- Press [6] and [OK] to diagnose magnetic stripe card reader.
- Press [↓] button to page 2.



*Page 2*

```
Main Menu 9123
7.LED
8.RTC
9.Printer
10.Font
11.CL Transparent
12.CL Card Test
-> 2/3
```

- Press [7] and [OK] to diagnose LED.
- Press [8] and [OK] to diagnose RTC.
- Press [9] and [OK] to check Printer.
- Press [10] and [OK] to check FONT file in UPT1000.
- Press [11] and [OK] to check CL transparent.
- Press [12] and [OK] to test Contactless Card.
- Press [↑] button to page 1.
- Press [↓] button to page 3.

*Page 3*

```
Main Menu 9123
13.SD Card Test
14.Wi-Fi Test
15.Power Saving
16.Comm Menu
17.BT Test
-> 3/3
```

- Press [13] and [OK] to execute SD Card Test. (Not support)
- Press [14] and [OK] to test functionality of WiFi.
- Press [15] and [OK] to test functionality of power saving.
- Press [16] and [OK] to test functionality of multiple communication ways.
- Press [17] and [OK] to test functionality of Bluetooth.
- Press [↑] button to page 2.

## 3.7. Factory Reset

Perform factory reset, all user application, fonts and data will be deleted.

### System Menu

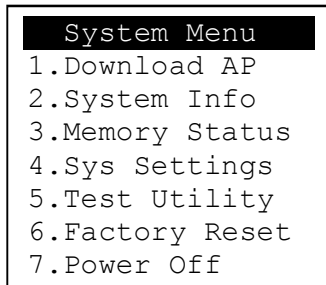

- Press [6] button to enter Factory Reset menu.

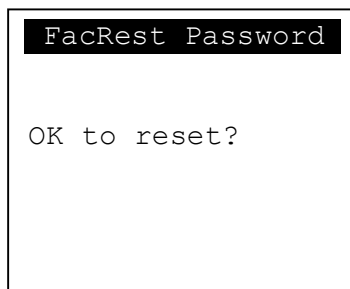

- Press [OK].

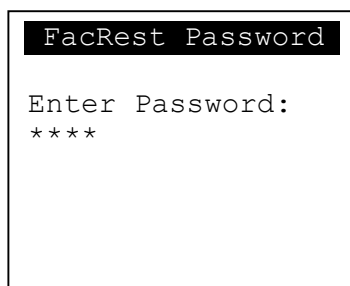

- Enter password and press [OK].
- Enter factory reset password. (**Default password: 8418**)

```
FacRestPassword
Enter Password:
****
Erasing...
```

- Start erasing, and then go back to Program Manager.

### 3.8. Power Off

Power off the machine.

#### System Menu

```
System Menu
1.Download AP
2.System Info
3.Memory Status
4.Sys Settings
5.Test Utility
6.Factory Reset
7.Power Off
```

- Press [7] button to power off the machine.

### 3.9. FK PWD Change

Change the keyin password.

#### System Menu (Page 2)

```
System Menu
1.FK PWD Change
2.Share obj Mng
3.Embedded TMS
4.Font Mng
5.Debug Tools
6.ULD KEY HASH
7.HW Detect
```

- Press [1] button to enter Password Manager Menu.

```
FunKey Password
Enter Password:
****
```

- Enter current password. (**Default password is "0000"**)

```
FunKey Password
New Password:
****
Confirm Password
****
PWD Changed OK
```

- Enter new password.
- Enter new password again to confirm.

User must have to change the Default key to user own key at the first time.  
The Default Key Value in Password Manager is as below:

|                     |             |
|---------------------|-------------|
| <b>Function Key</b> | <b>0000</b> |
| <b>PMEnter Key</b>  | <b>0000</b> |
| <b>Factory Key</b>  | <b>8418</b> |

## 3.10. Share Object Management

View share object in machine .

### System Menu (Page 2)

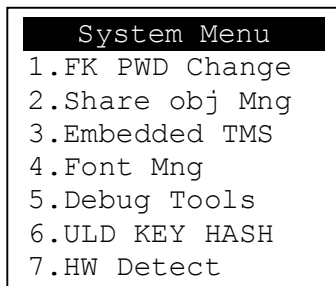

- Press [2] button to enter Share Object Management menu.

### Share Object Management Menu

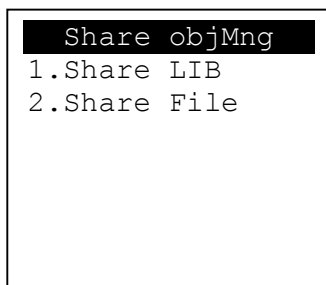

- Press [1] button to view shared libraries.
- Press [2] button to view shared files.

## 3.11. Embedded TMS

TMS (Terminal Management System) setting menu.

### System Menu (Page 2)

```
System Menu
1.FK PWD Change
2.Share obj Mng
3.Embedded TMS
4.Font Mng
5.Debug Tools
6.ULD KEY HASH
7.HW Detect
```

- Press [3] button to enter TMS setting menu.

### CASTLES TMS

```
CASTLES TMS
1.Connect Server
2.System Config
3.Reset Config
4.CompatibleConfig
```

- Press [1] button to connect server.
- Press [2] button to enter system config menu.
- Press [3] button to reset config.
- Press [4] button to set compatible config.

## 3.12. Font Mng

View Font Management.

### System Menu (Page 2)

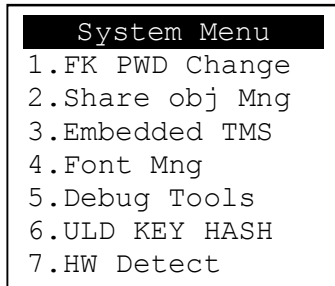

- Press [4] button to view Font Management.

### FontManagment

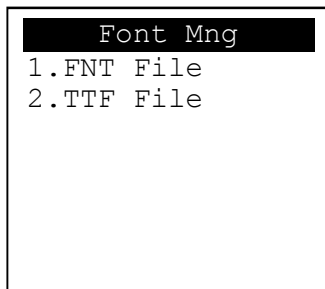

- Press [1] button to view FNT Font list.
- Press [2] button to view TTF Font list.

### 3.13. Debug Tools

Get core dump or debug log.

#### System Menu (Page 2)

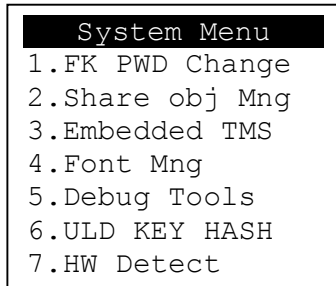

- Press [5] button to enter Debug Tools menu.

#### Debug Tools

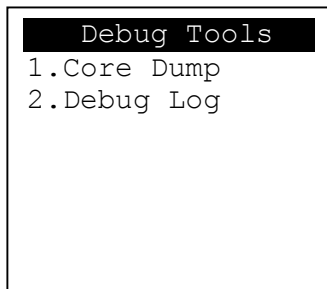

- Press [1] button to enter core dump menu.
- Press [2] button to enter debug log menu.



## 3.14. ULD Key Hash

View ULD user key hash value.

### System Menu (Page 2)

```
System Menu
1.FK PWD Change
2.Share obj Mng
3.Embedded TMS
4.Font Mng
5.Debug Tools
6.ULD KEY HASH
7.HW Detect
```

- Press [6] button to view hash value.

```
USER ENV KEY
DA9C91FE668DF4B6D637
CDBCCEC201444AA2C7FF
USER SIGN KEY
D52F36A1B569B5ABBA4F
EAEFB34BEC000101D58C
```

### 3.15. HW Detect

Run hardware detection.

#### System Menu (Page 2)

```
System Menu
1.FK PWD Change
2.Share obj Mng
3.Embedded TMS
4.Font Mng
5.Debug Tools
6.ULD KEY HASH
7.HW Detect
```

- Press [7] button to run HW detection.

```
HW TYPE
Original
HW-TYPE : EGCB

New
HW-TYPE : EGCB

Please Any Key.
```

- Press any key to reboot system.

## 3.16. Bluetooth Setup

Setup Bluetooth config.

System Menu (Page 2)

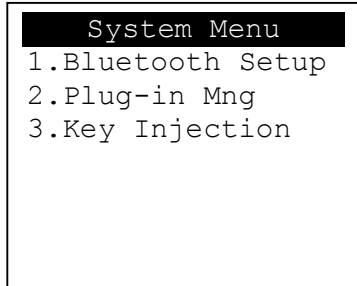

- Press [1] button to enter Bluetooth setting menu.

Bluetooth Setup

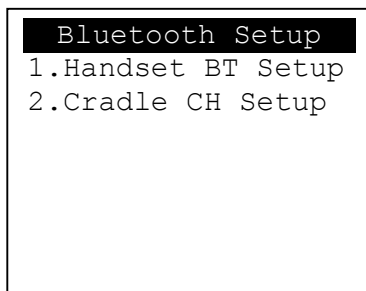

- Press [1] button to enter Handset BT Setup menu.
- Press [2] button to enter Cradle CH Setup menu.

## 3.17. Plug-in Mng

View Plug-in Management.

### System Menu (Page 2)

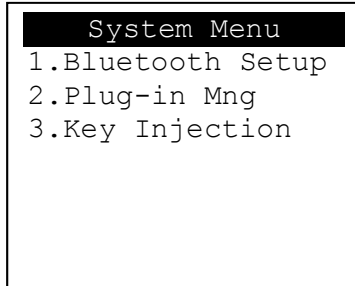

- Press [2] button to view Plug-in Management.

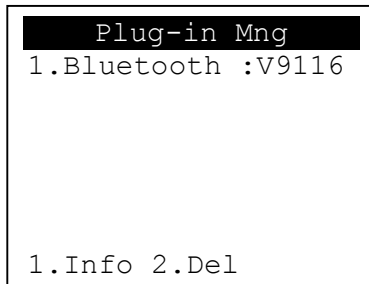

- Press [↑] or [↓] button to select item.
- Press [1] button to get item information.
- Press [2] button to delete item.

## 3.18. Key Injection

Key Injection function. (Factory use only.)

System Menu (Page 3)

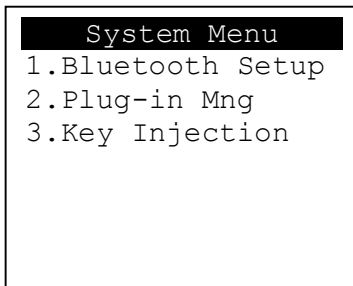

- Press [3] button to view Key Injection.

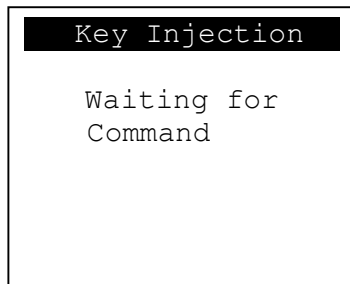

## 4. Secure File Loading

Castles implemented an interface named User Loader(ULD) to provide secure file loading to system memory. Loading of user application, kernel firmware, font and others must use User Loader.

The loading process is secure by signing the files using ULD Key System.

### 4.1. ULD Key System

The ULD Key System uses two key sets for securely managing the kernel updating and application downloading. Each key set contains two RSA key pairs. One is used for key encryption and the other is used for signature. These two key sets are specified as below:

#### **ULD Manufacturer Key Set**

- ULD Manufacturer Key Encryption Key (RSA)
- ULD Manufacturer Signature Key (RSA)

#### **ULD User Key Set**

- ULD User Key Encryption Key (RSA)
- ULD User Signature Key (RSA)

*For UPT1000, the RSA key length is 2048bits.*

#### **4.1.1. ULD Manufacturer Key**

The system consists of several kernel modules. These kernel modules are provided by the Manufacturer, and released in CAP format file with encryption and signing via ULD Manufacturer Keys.

The ULD Manufacturer keys are managed and maintained by the manufacturer. The manufacturer uses these keys to generate kernel CAP files for updating the system. However, the system is not permitted to be updated with these kernel CAP files directly generated by the manufacturer. This is because only the user can have the privilege to decide whether the system is to be updated. Therefore, before system

updating, the kernel CAP files must be “signed” via ULD User Key to get the user permission. For simple expression, we call the kernel CAP files generated by the manufacturer as “unsigned kernel CAP(s)” and call the kernel CAP files “signed” by the user later as “signed kernel CAP(s)”.

**Notes:**

1. The kernel modules are encrypted by a random-generated 3DES key, which is retrieved from the Key Encryption Block of the CAP by ULD Manufacturer Key Encryption Key, not directly encrypted by ULD RSA Key.
2. The “sign” action via ULD User Keys actually is done by” the second encryption”. “The second encryption” is done by using the random-generated 3DES key, which is encrypted by ULD User Key Encryption Key, to perform Triple DES encryption again on the cipher data segment of the kernel CAP files. This ensures that the system cannot retrieve the correct data from the kernel CAPs without the user permission.

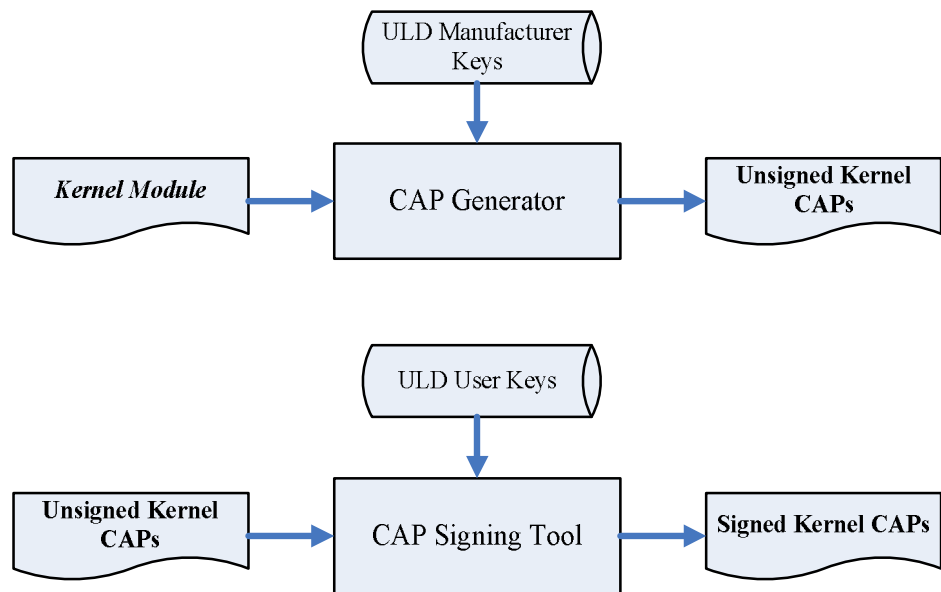

### 4.1.2. ULD User Key

ULD User Key are used to encrypt and sign the user/shared applications. In addition, they are as goalkeepers to prevent the system updating without user permission. This is done by the kernel CAPs which are encrypted and signed by the manufacturer having to perform the “signed” action via ULD User Keys.

*Notes: Applications are encrypted by a random-generated 3DES key, which is retrieved from the Key Encryption Block of the CAP by ULD User Key Encryption Key, not directly encrypted by ULD RSA Key.*

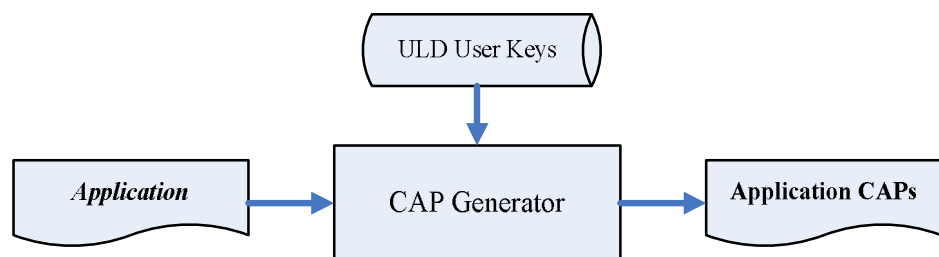

### 4.1.3. Key Change

The ULD RSA Keys are able to be changed. The system uses a special CAP file, KEY CAP, for the manufacturer and user to change their own keys. The KEY CAP contains a new set of ULD keys (Key Encryption Key and Signature Key). These new keys are encrypted and signed via the original keys. In other words, if the user would like to change the ULD User Keys, they have to use their original ULD User Keys with the new ULD User Keys to generate a KEY CAP.

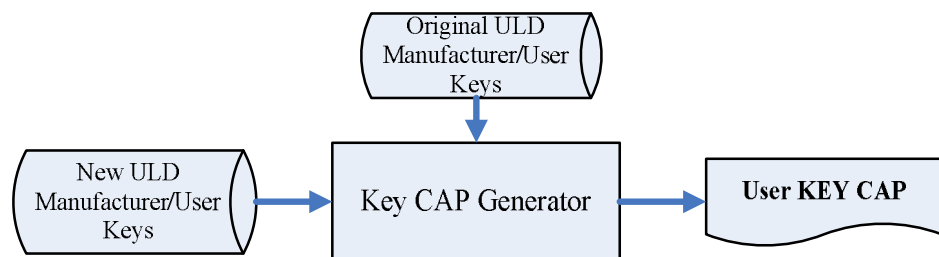



## 4.2. File Signing

### 4.2.1. Signing Kernel Module

Castles will release new version of kernel module in “unsigned” form. This files required to sign with ULD User Key before it can load to UPT1000.

Castles Technology provides a tool named “CAP Signing Tool” to perform this task.

The CAP Signing Tool is located at:

C:\Program Files\Castles\UPT1000\tools\Signing Tool

- Run CAP Signing Tool

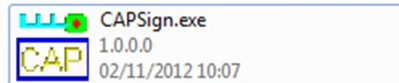

- Insert Key Card and select smart card reader

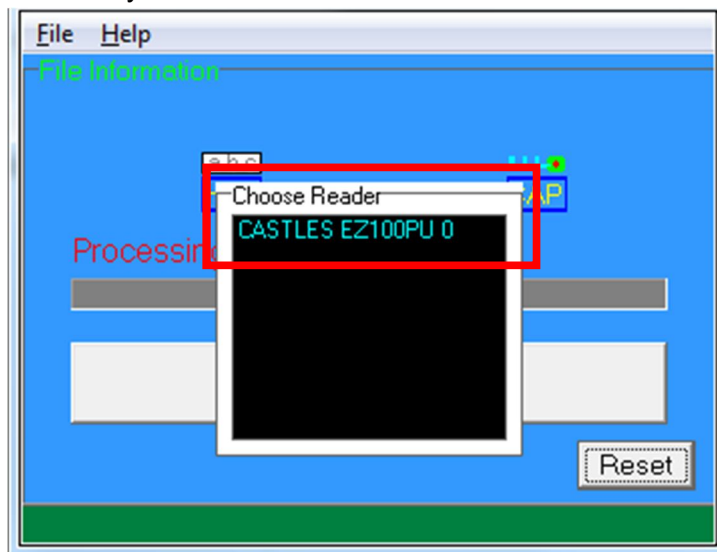

- Enter Key Card PIN

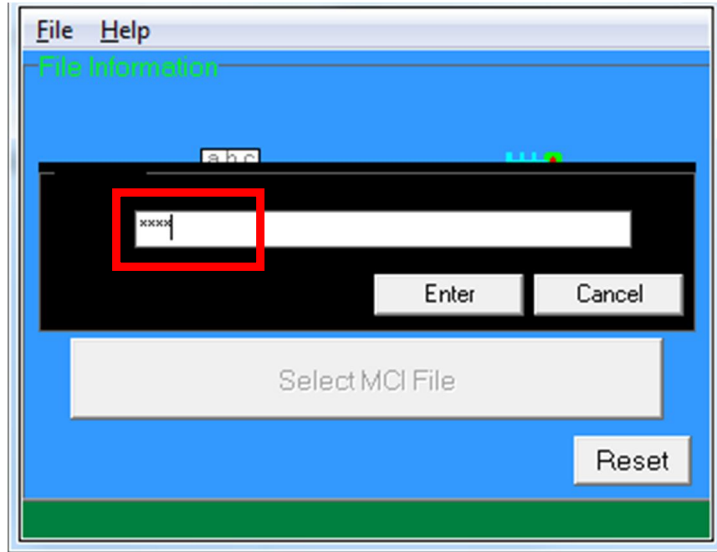

- CAP Signing Tool is ready, press "Select MCI File" button to browse the file.

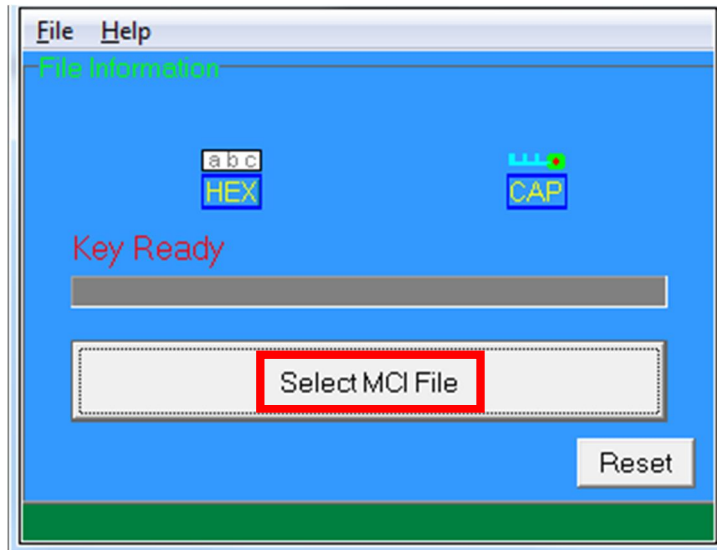

- Output file will be located in "signed" folder.

## 4.2.2. Signing User Files

Following files are required to sign before load to UPT1000. This is to ensure the application data and codes confidential and integrity. The output file will be “CAP” file which format is defined by Castles.

- User application
- User application data files
- User application library
- Font file
- Share library
- Share files
- System setting
- Key CAP (Manufacturer ULD Key Set)

Castles Technology provided a tool named “CAP Generator” to perform this task.

The CAP Generator is located at:

C:\Program Files\Castles\UPT1000\tools\CAPG (KeyCard)

- Run CAP Generator

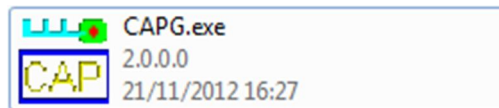

- Insert Key Card and select smart card reader

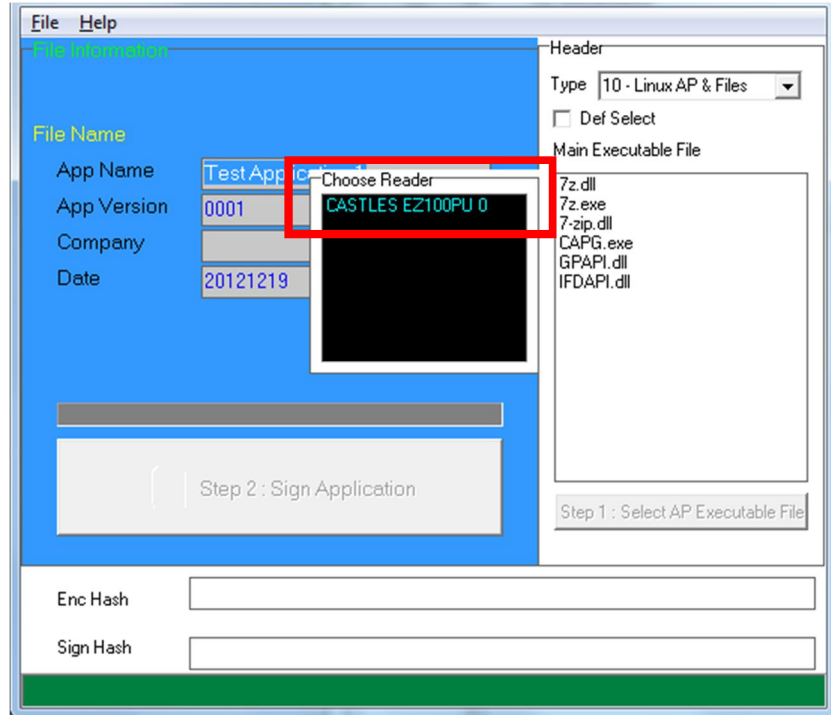

- Enter Key Card PIN

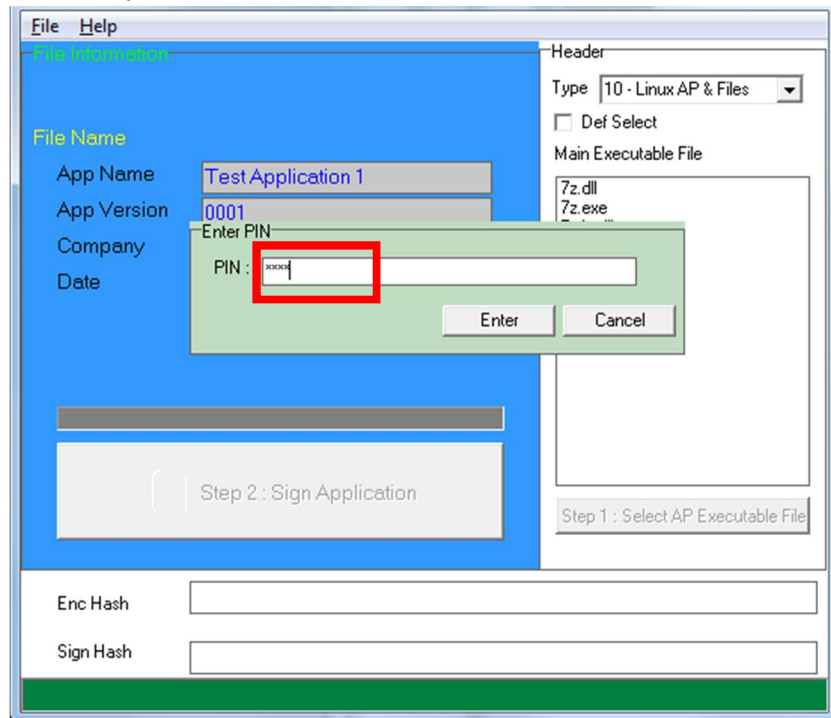

- CAP Generator is ready, select the correct Type from the list.

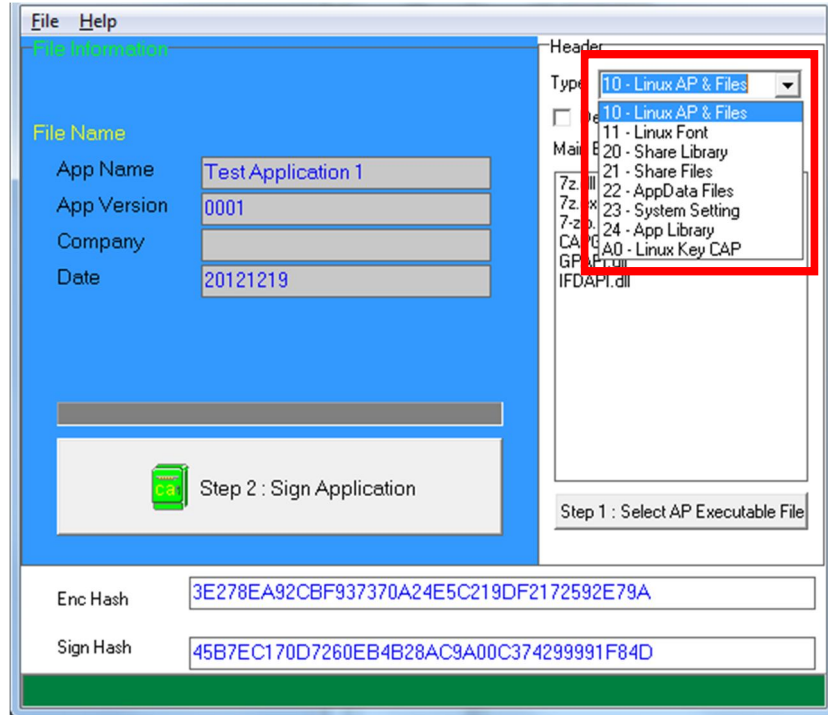

- Press “Step 1: Select AP Executable File” to select file to sign. This is valid for all the files to sign.

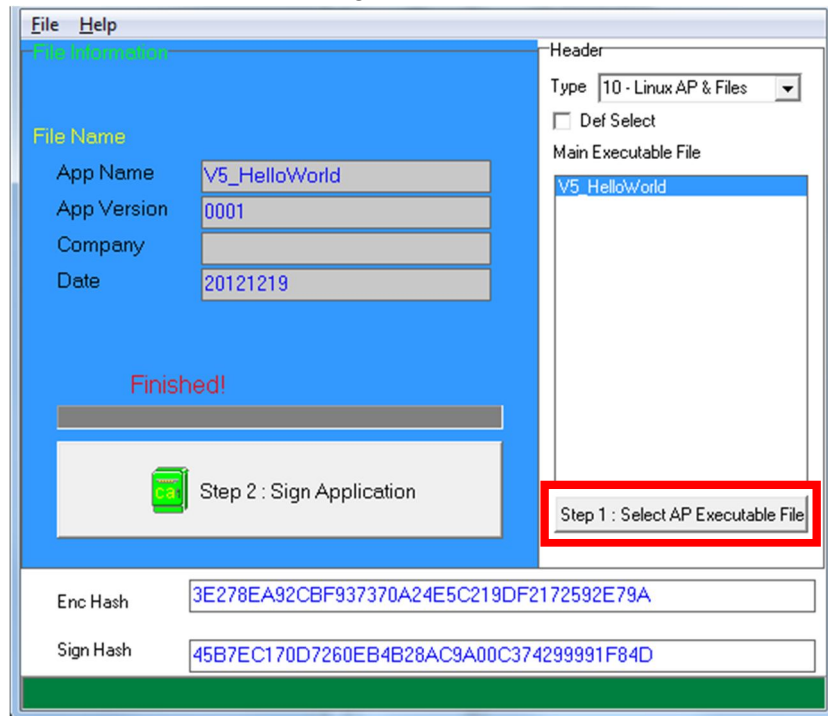

- Enter file details and press “Step 2: Sign Application” to sign the file. This is valid for all the files to sign.

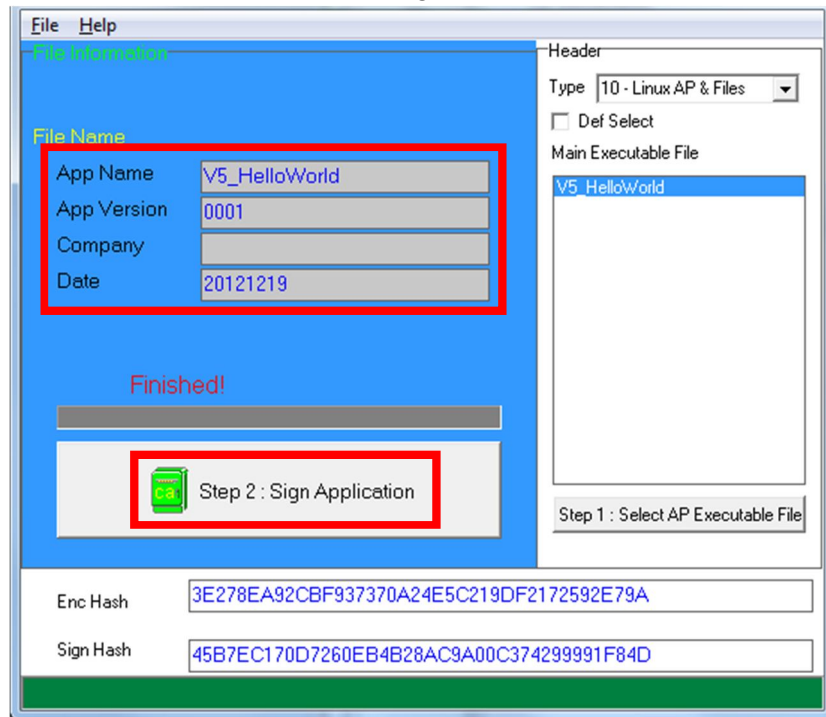

- The output file will be in a set. A “mci” file with one or more “CAP” files. CAP file contents the signed file binaries, where MCI file contents the list of CAP files.



Note: If user would like to load multiple set of signed file, create a new file with extension of “mmci”. Then put the mmci file contents with the list of mci file.



## 4.3. File Loading

There are several ways of loading file to UPT1000.

- Download by User Loader
- Download by removable media
- Download by user application
- Download by Castles TMS

User Loader is a tool provided by Castles Technology. It's the formal way to download file to UPT1000.

User may implement their own ways of updating application or files using CTOS API provided, **CTOS\_UpdateFromMMCI()**.

Castles TMS (CTMS or CASTLES Terminal Management System) is provided by Castles Technology. It uses to perform remote download via Ethernet, GPRS/UMTS or modem.

### 4.3.1. Download by User Loader

The User Loader works for UPT1000.

The Loader is located at:

C:\Program Files\Castles\UPT1000\tools\Loader

- Run User Loader

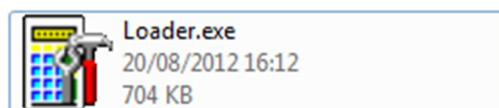

- Select COM port

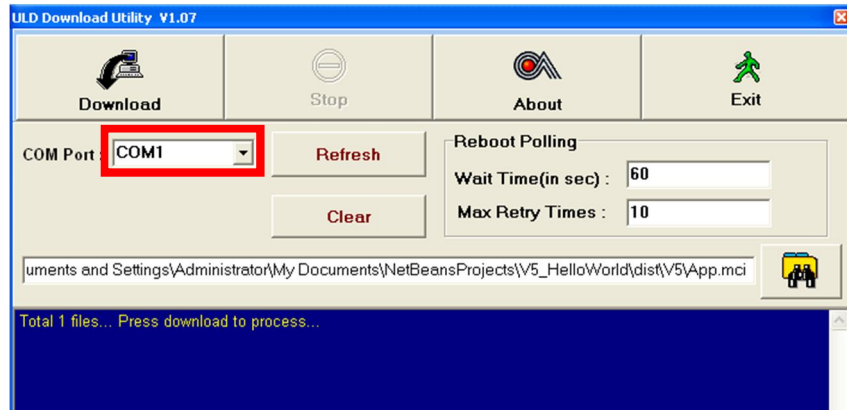

- Browse and select mci file or mmci file

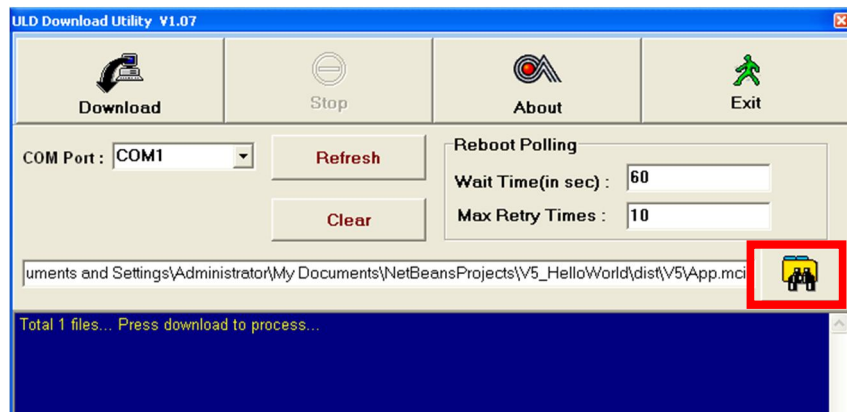

- Setup UPT1000 to enter download mode
  - Press [0] button in Program Manager (PM)
  - Press [1] button to select "1. Download AP"
  - Press [1] button again to select download via RS232 or USB



- Press “Download” button to start.

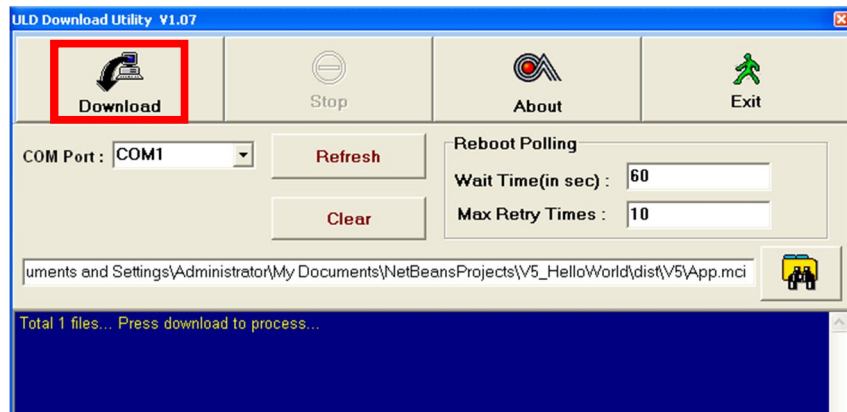

*Note: To download using USB cable, UPT1000 must enable CDC mode. Set USB CDC Mode to Y.*

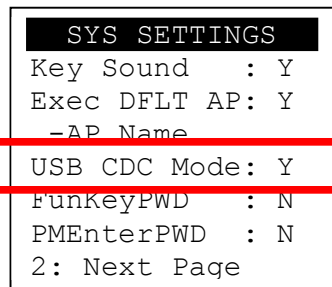

### 4.3.2. Download by Removable Media

The file download process can be achieved without PC by using removable media, USB flash drive. We recommend don't put unwanted file to removable media, as it will increase the time during detection.

- Create a folder name "vxupdate" under root directory.

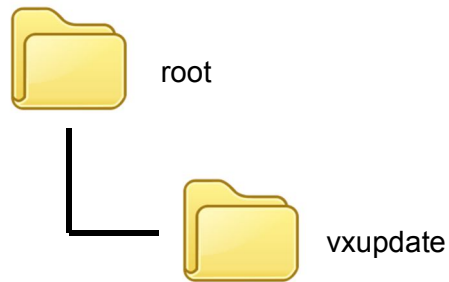

- Place the mci file and cap file to "vxupdate" folder.

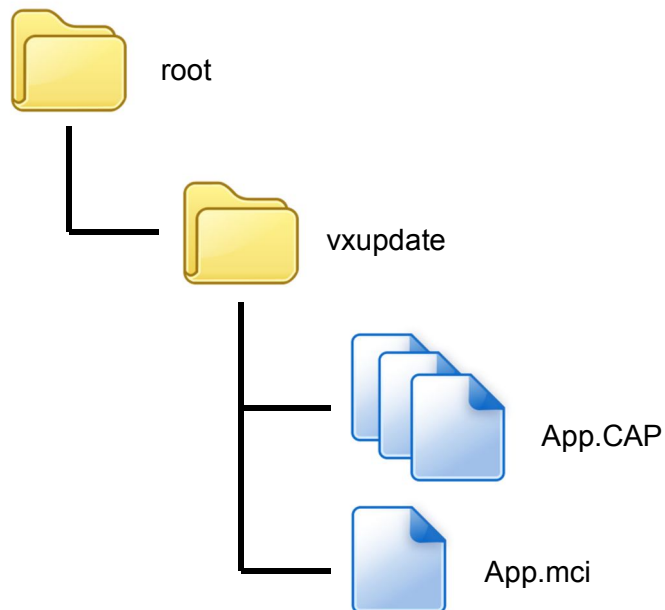

Note: If user would like to load multiple application, create a new file with extension of "mmci". Then put the mmci file contents with the list of mci file.



- Insert removable media to UPT1000, and select the removable media type in “Download AP” menu.

#### Download AP Menu

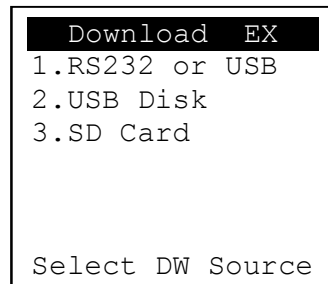

- Press [2] button to select USB flash drive.
  - Press [3] button to select MicroSD card. (Not support)
- 
- Finally, UPT1000 will process the file in “vxupdate” folder.

## 4.4. Changing ULD User Key

User may change their ULD User Key Set stored in Key Card. Castles Technology provided a tool named “Secure Key Generator” to perform this task.

- Run Secure Key Generator

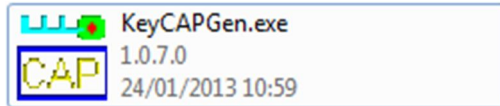

- Insert Key Card and select smart card reader

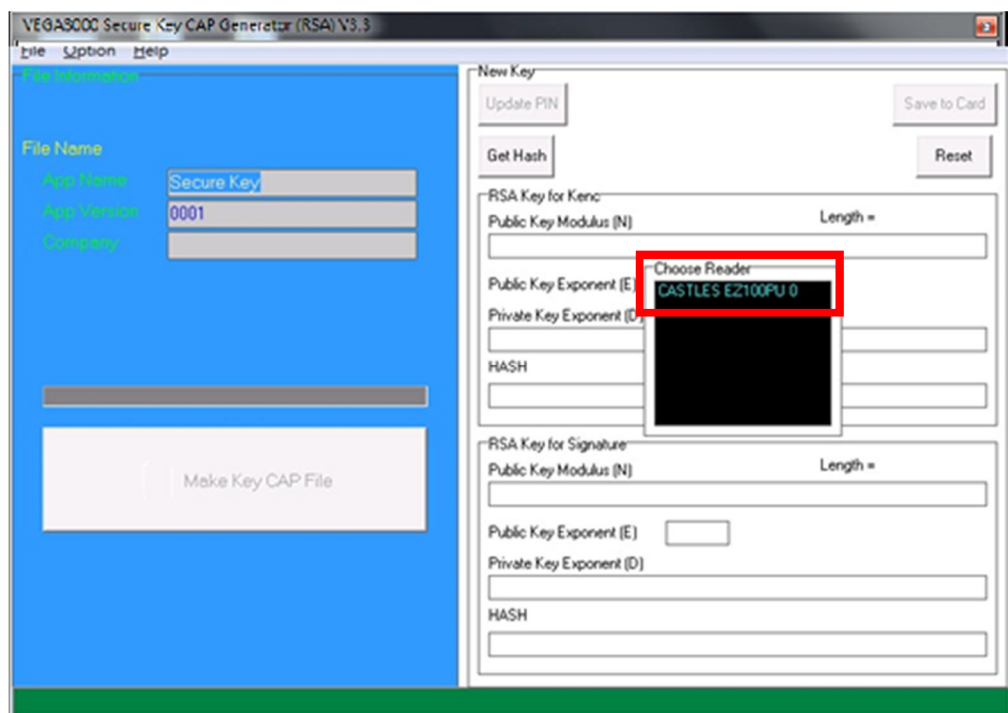

- Enter Key Card PIN, default PIN is “1234”.

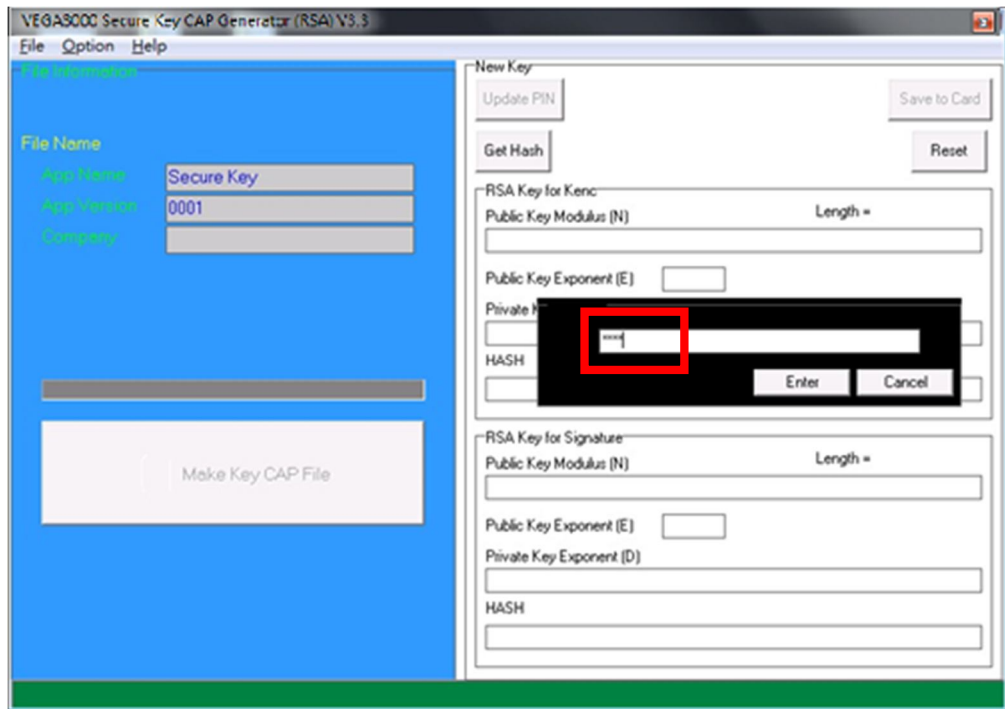

- To change Key Card PIN, press “Update PIN” button. If not, please skip this steps.

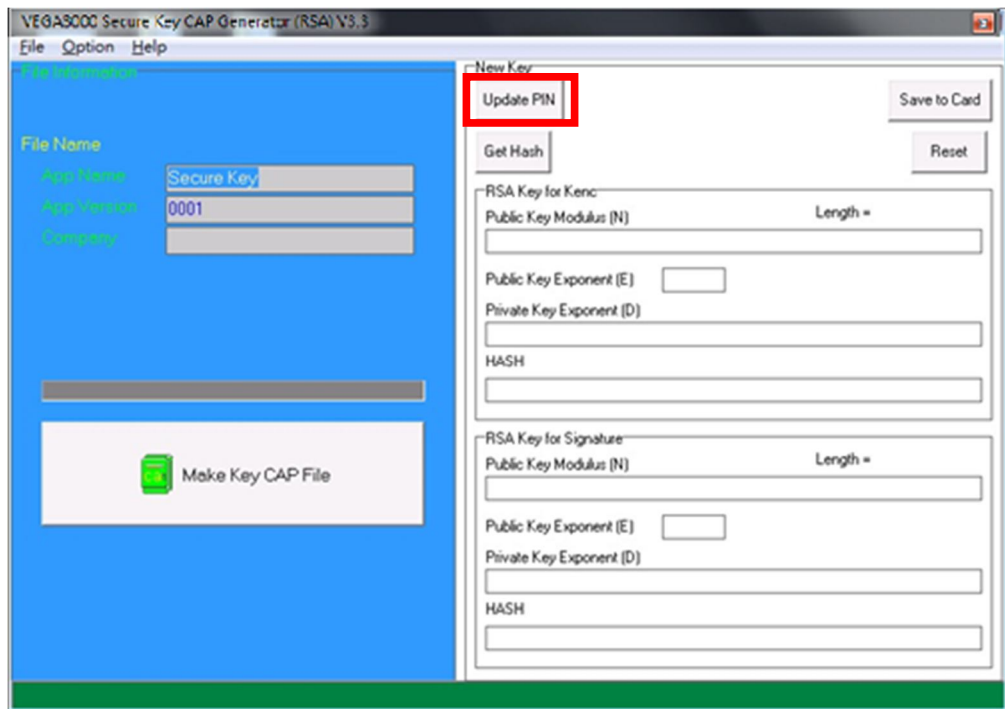

- Enter new PIN, enter new PIN again to confirm, then press [Enter] button to change PIN in Key Card.

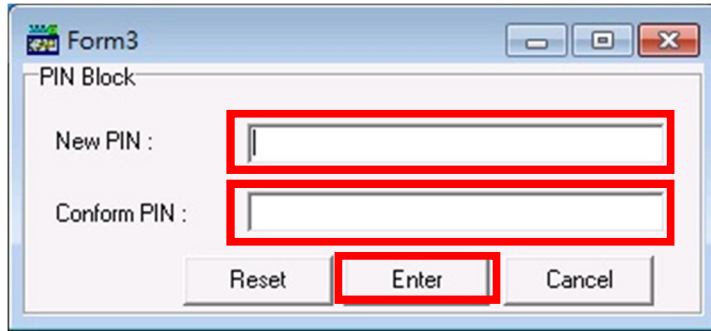

- To view current key set hash value, goto “Option” and select key.

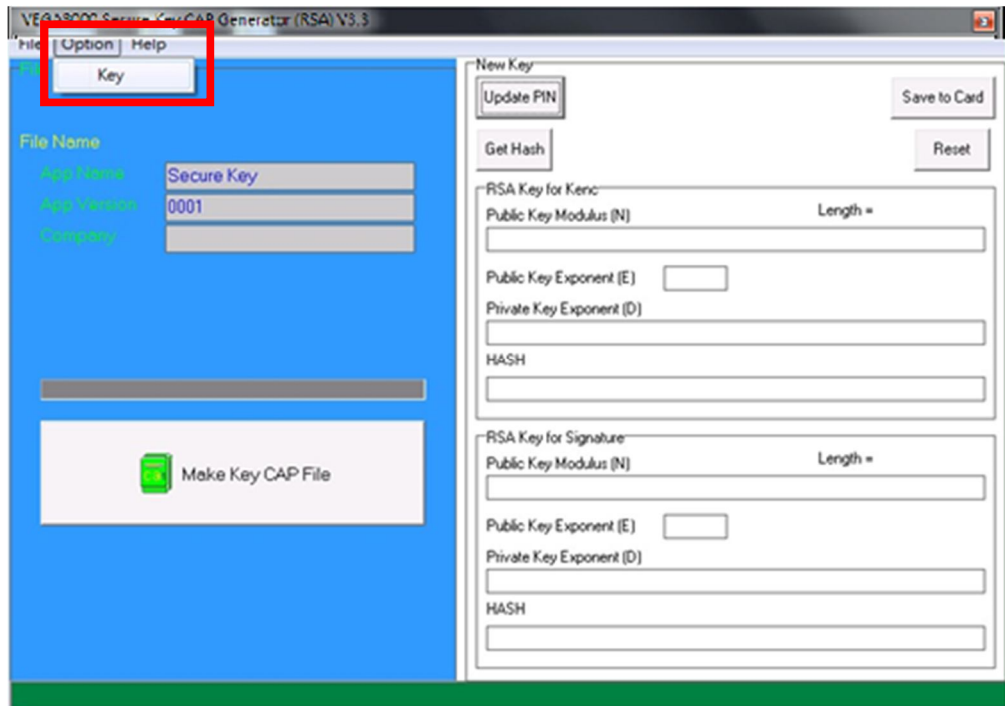

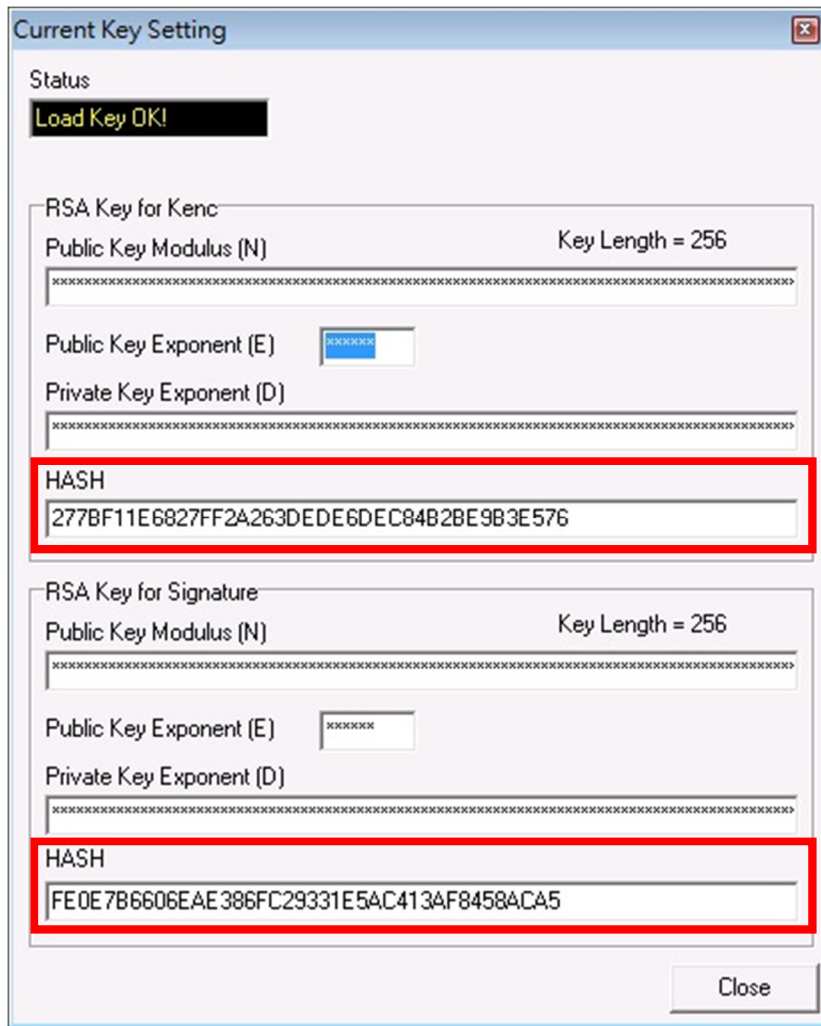

- To generate new user key set
  - Please generate the RSA key by yourself, the length of the RSA key set should be 2048 (bits).
  - Copy RSA key components to RSA Key for Kenc in Secure Key Generator.

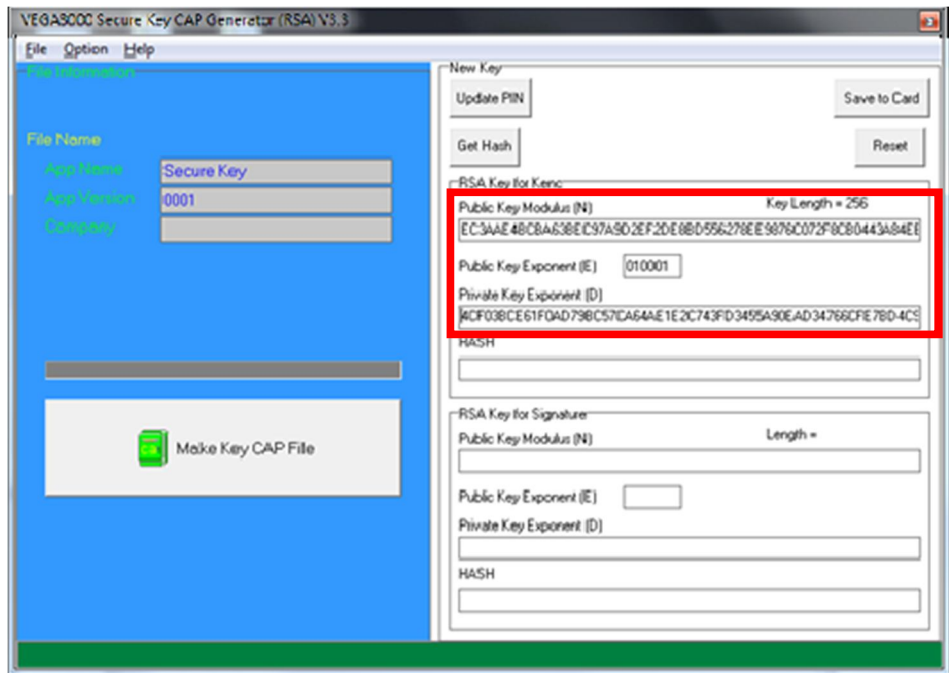

- Generate second RSA key set for Signature.

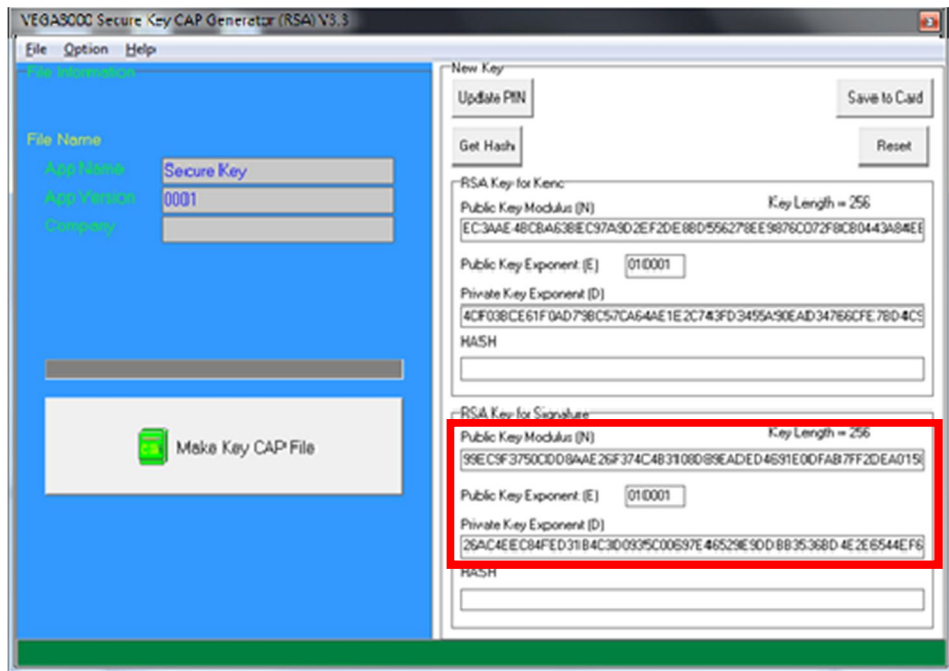



- Click [Get Hash] button to calculate the hash value for key sets.

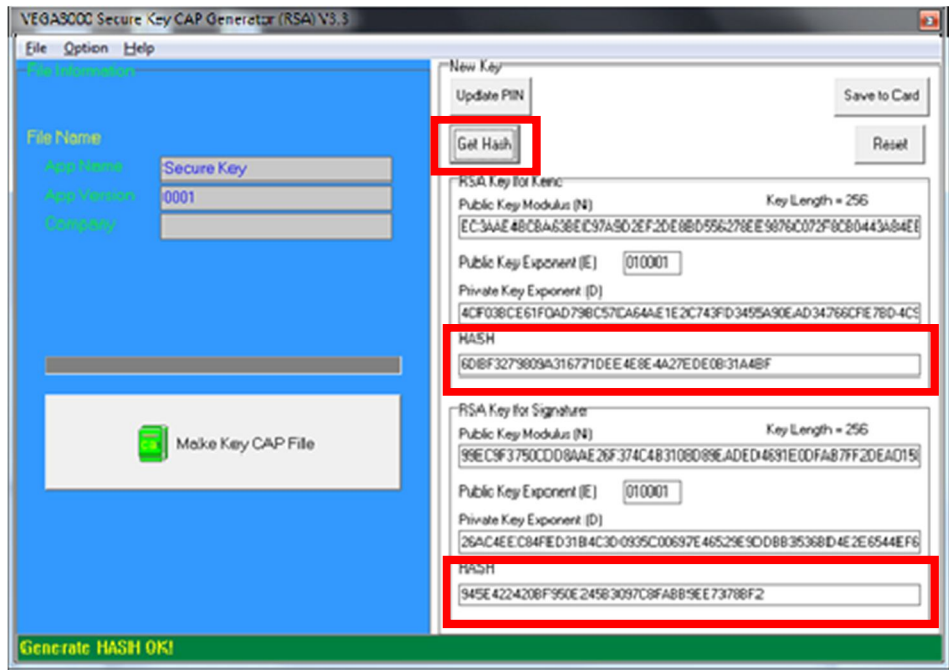

- Please copy down all the values into a text file and keep in a safe place. You will need this if you need to create duplicate Key Card.
- To generate the key CAP for the newly generated user key set, press [Make Key CAP File] button.

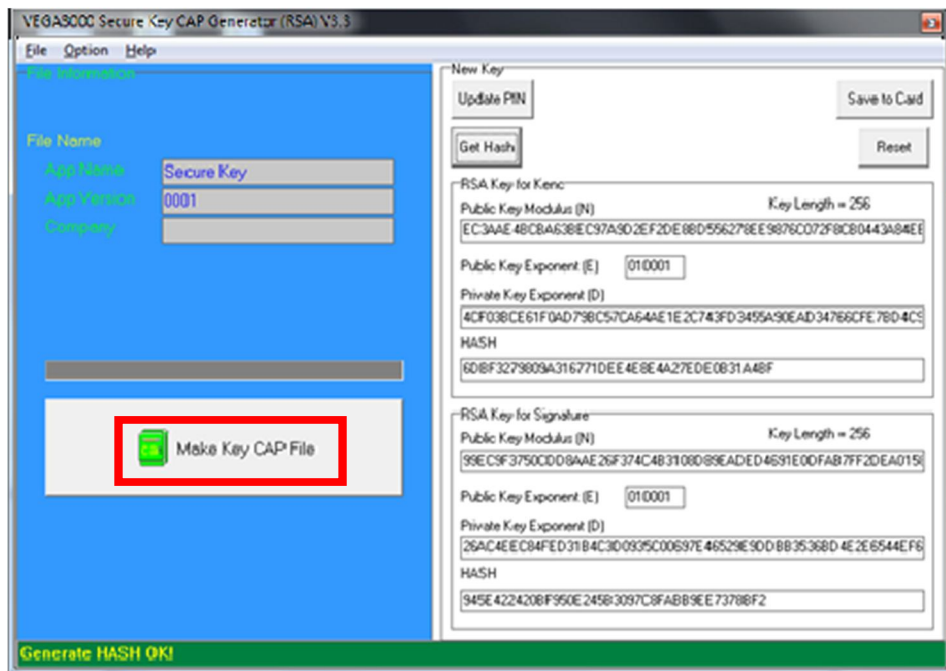

- The output file will be located in the Secure Key Generator folder.

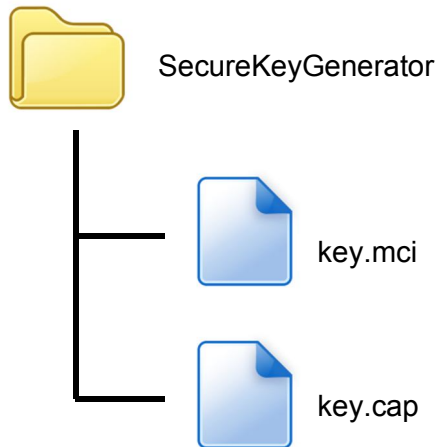

- To update the newly generated key set to Key Card, press [Save to Card] button to write the key set to Key Card.

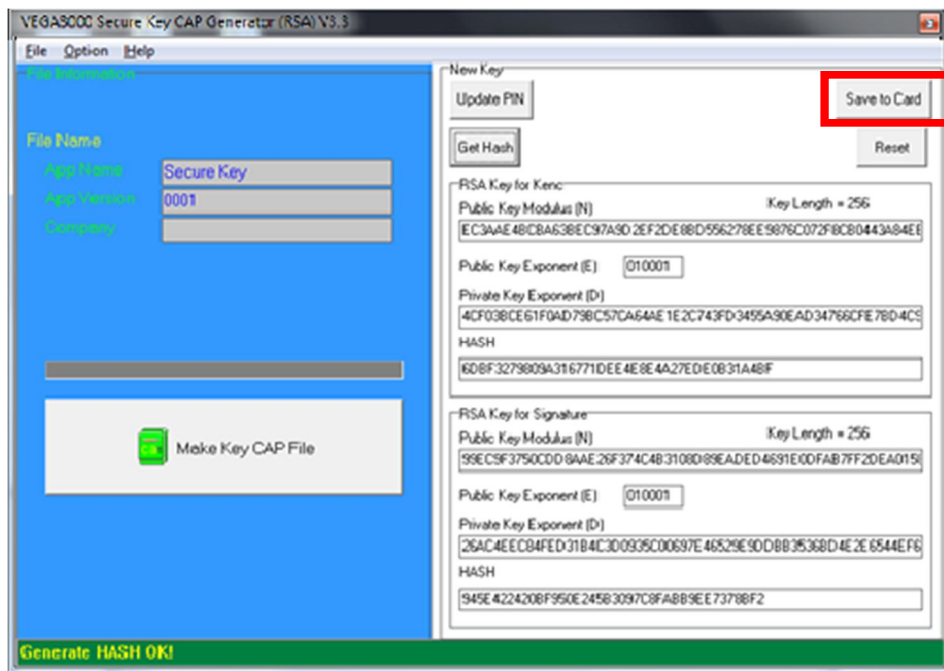

# 5. Font Management

## 5.1. Loading New Font

- Run FontManager.exe

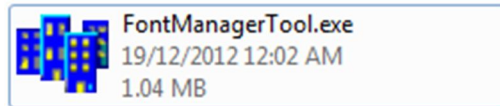

Located at C:\Program Files\Castles\Font Manager

- Select font to download

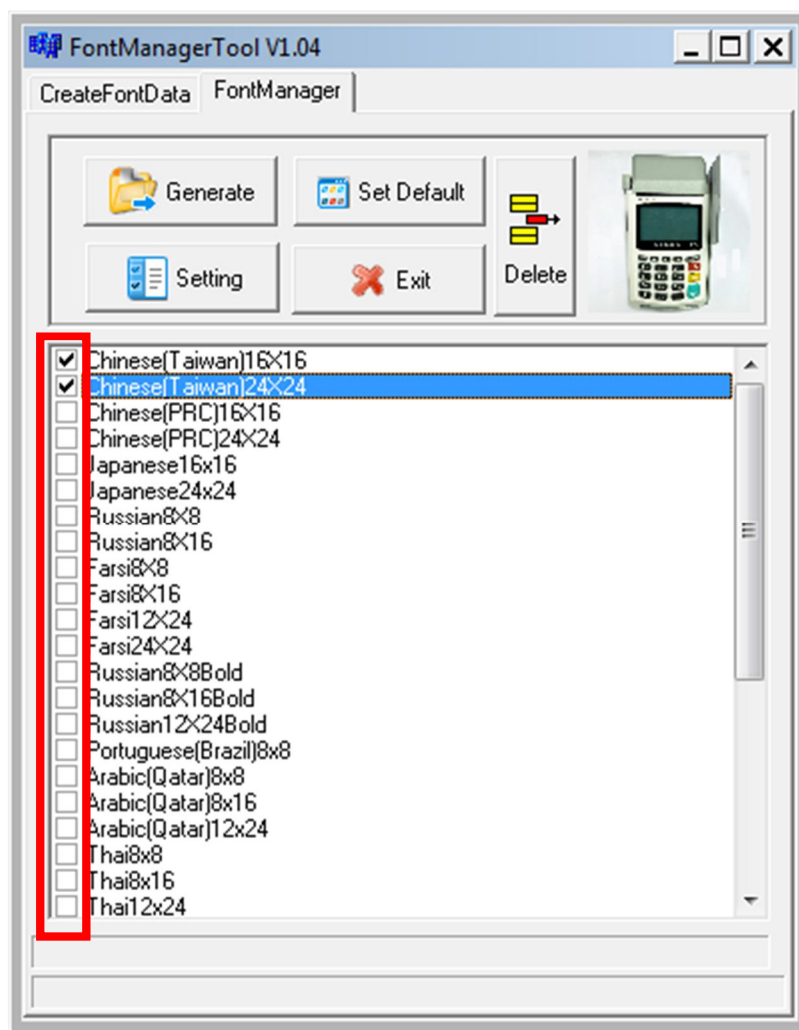

- Press [Setting] button to configure the type.

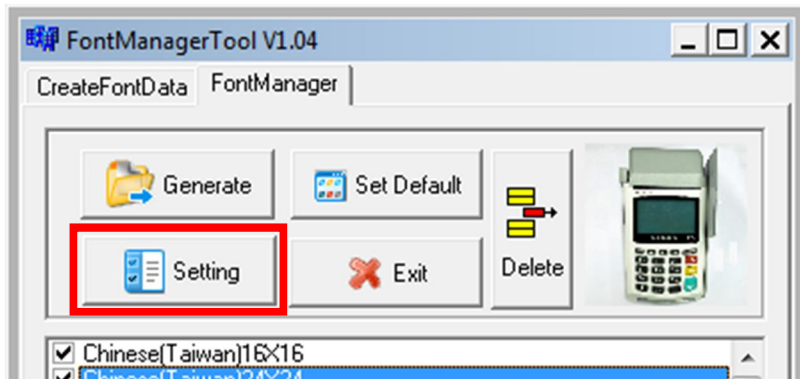

- Select **VEGA5000**, press [Save] button to save and return font manager.

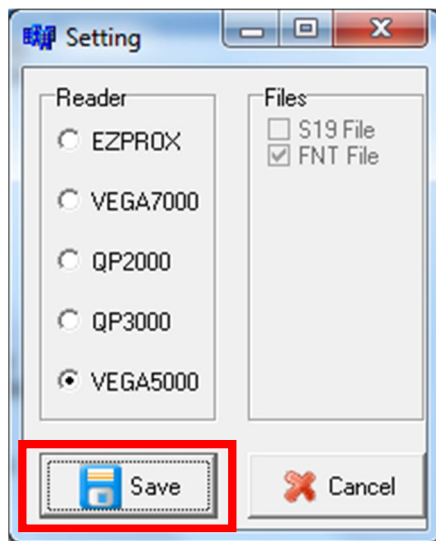

- Press [Generate] to create the font file.

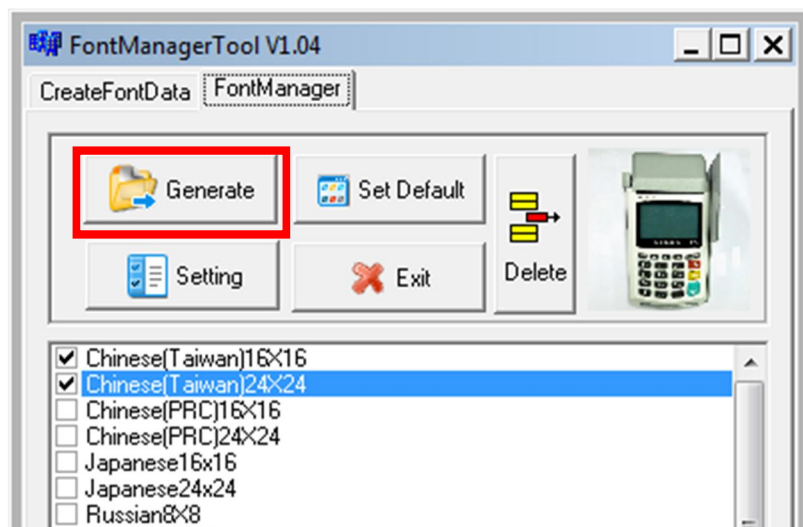

- Output file “Font.FNT” will be located at sub-directory named “Font” in “Font Manager” folder.

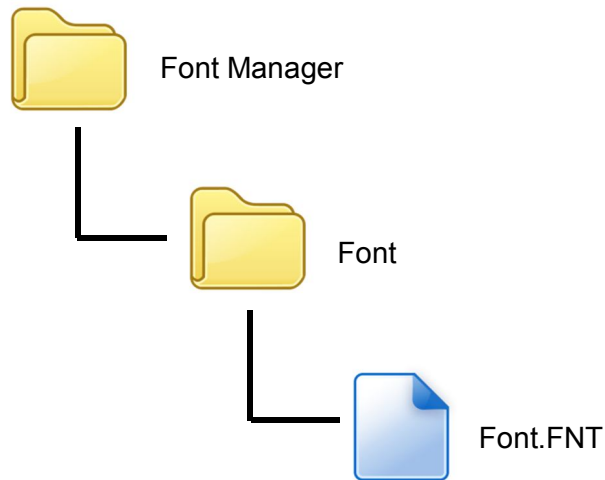

- Sign the file using CAP Generator, the type must set to “11 – Linux Font”.

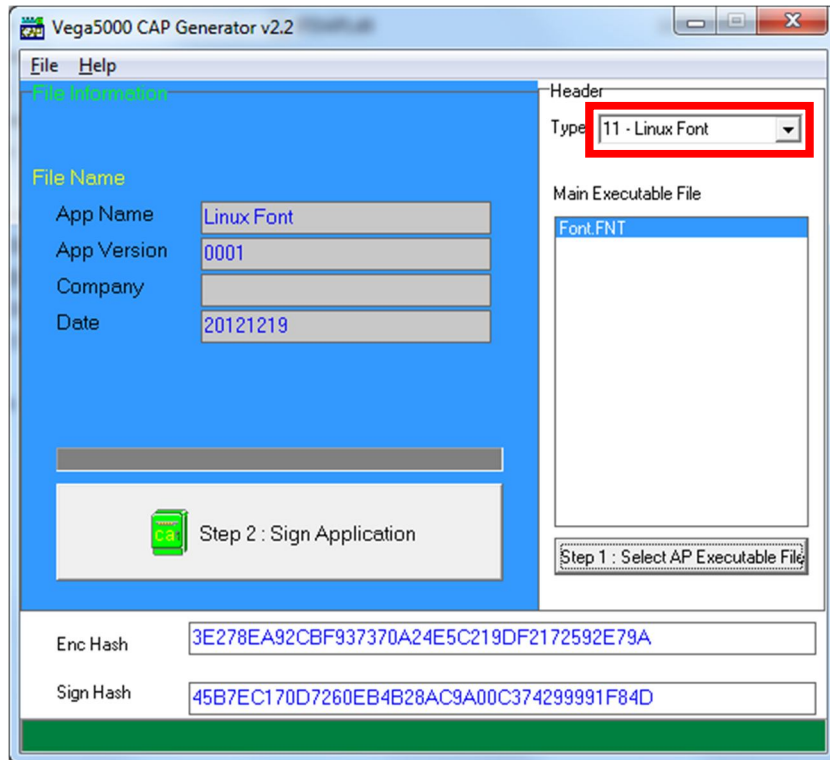

- Lastly, download the signed file (CAP file) to UPT1000 using Loader.

## 5.2. Custom Font

User may create font they preferred for displaying or printing on UPT1000.

There are two zone defined:

Zone 0x00 ~ 0x7F – ASCII characters, you may replace with the font type preferred or your own language character set.

Zone 0x80 ~ 0xFF – Free to use, you may use for symbols.

### **Following steps demonstrate how to create a 12x24 font.**

- Run GLCD Font Creator

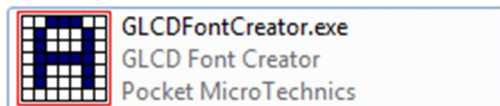

- Select [File] ⇒ [New Font] ⇒ [Import An Existing System Font]

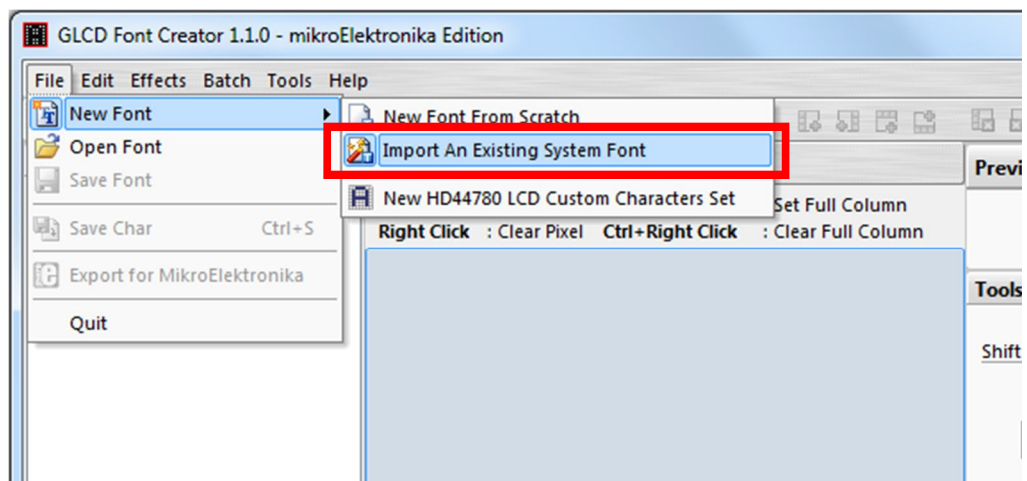

- Select the font needed, simply choose a font size. The final value of font size should be determine by the minimum pixel width. You may need to repeat this steps few times to find the best fit font size.

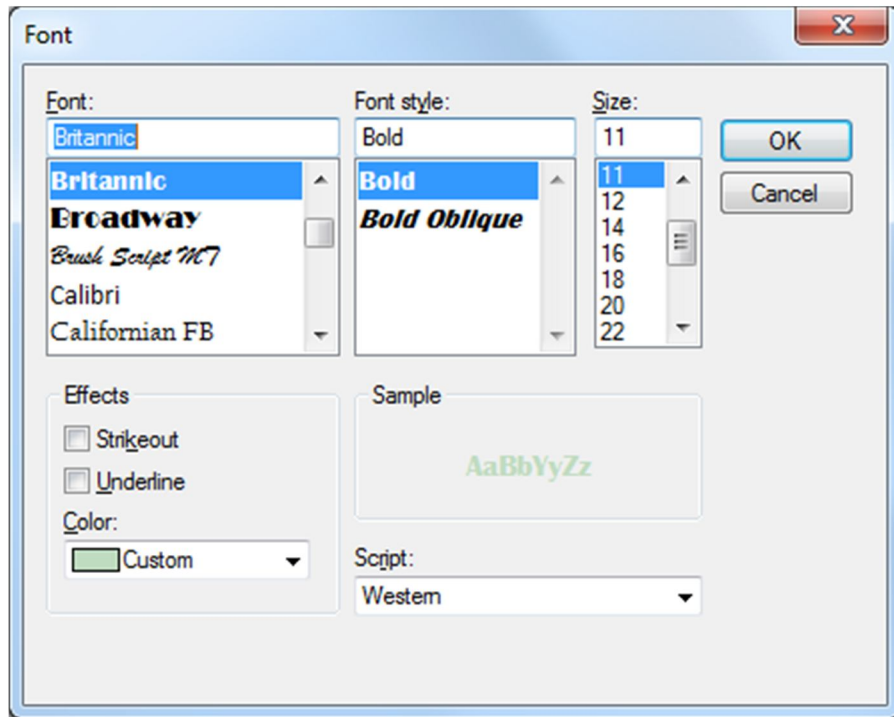

- Set the import range from 0 to 127.

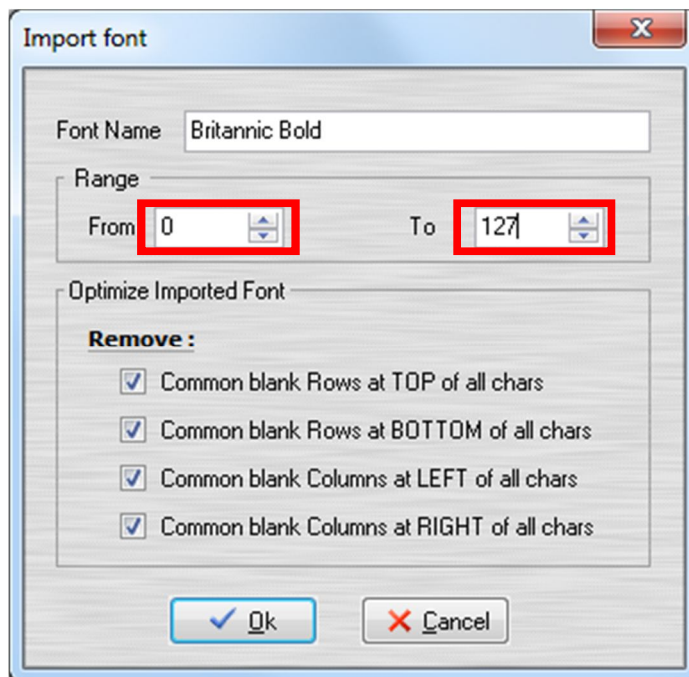

- Check the minimum pixel width and height.

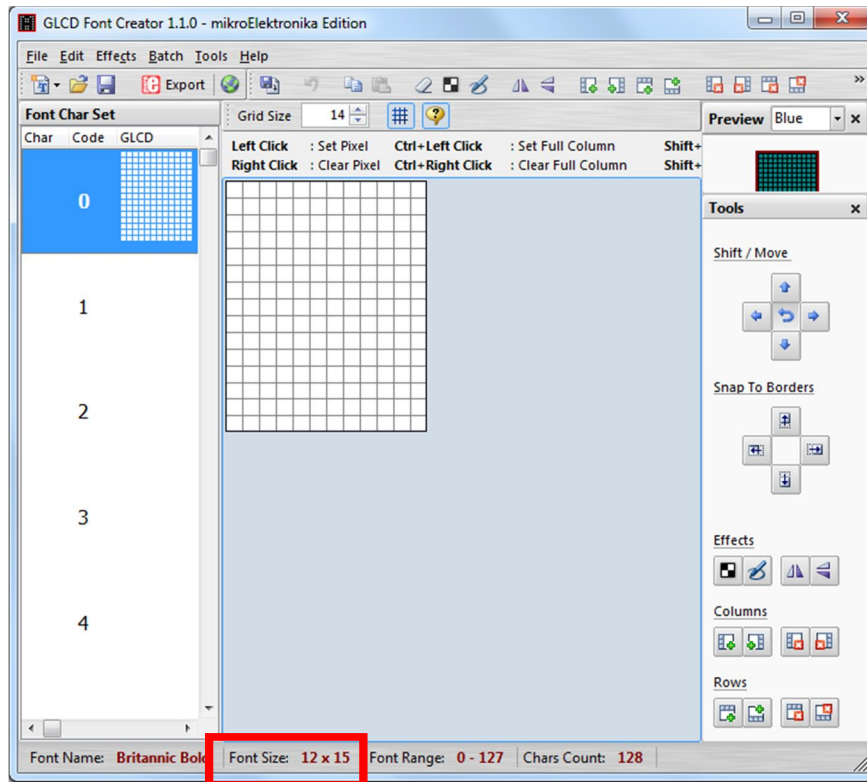

- If the pixel width of the font size is larger than expected, then you have to repeat the previous steps to import font with smaller size.
- Use the following buttons to adjust the font size to match with expected font size.

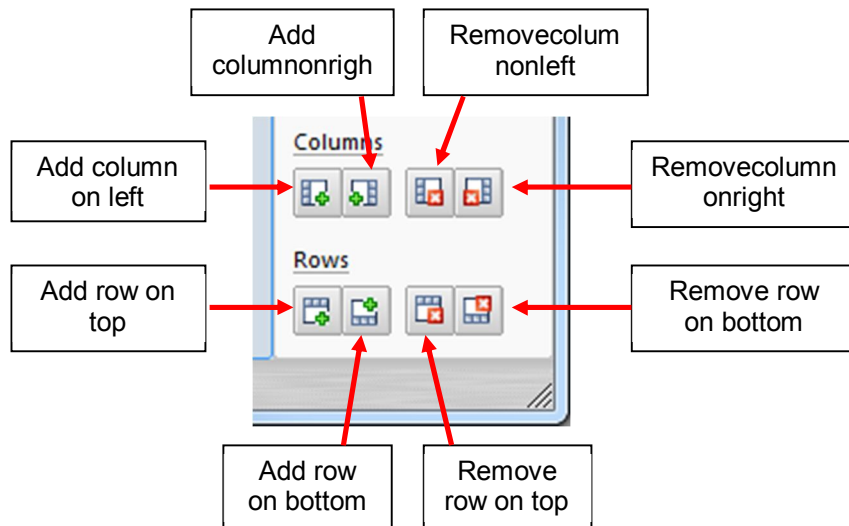



- After adjust font size, select [File] ⇒ [Export for MikroElektronika].

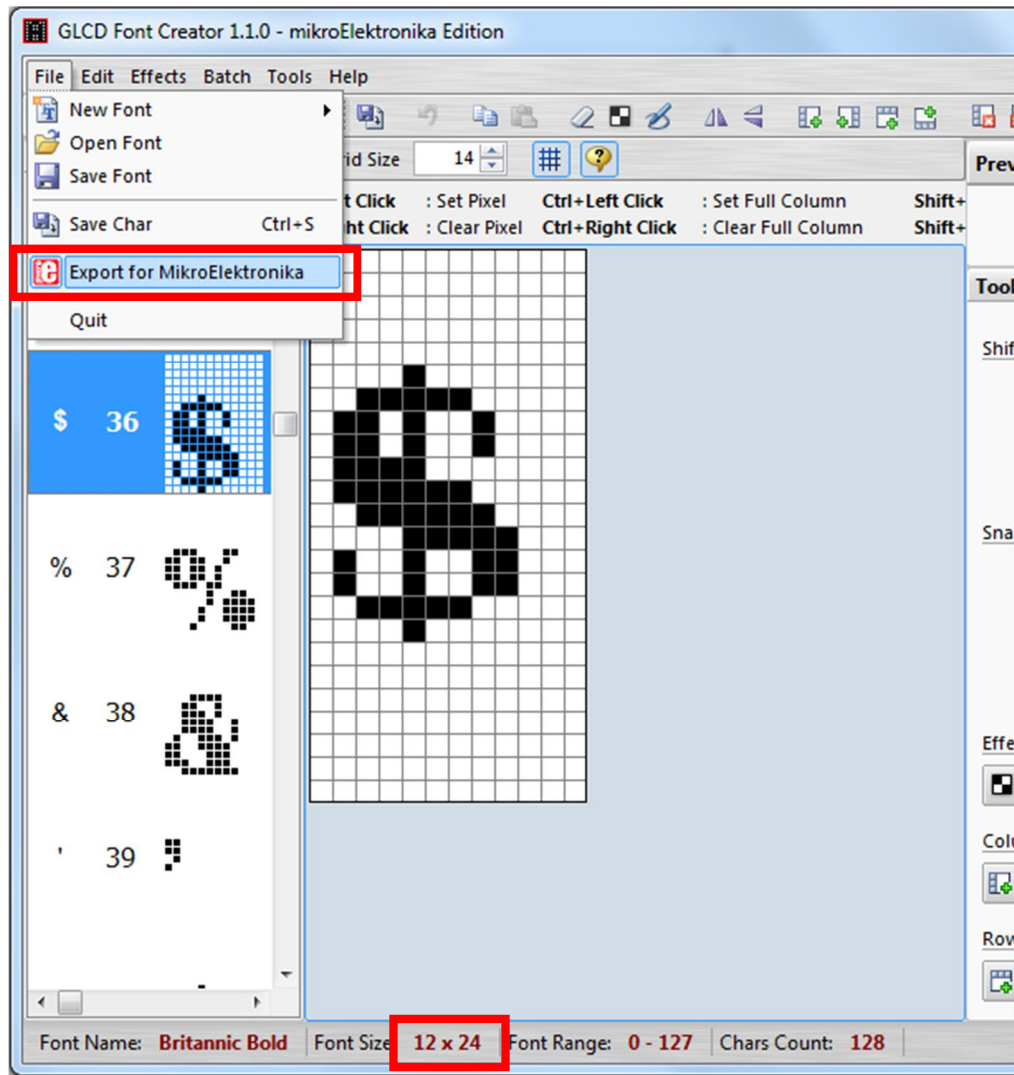

- Select output format as [mikroC].



- Remove comment "// Code for char" from offset 0x00 to 0x1F. Remove empty line if found. Then click [Save] button to save to file.

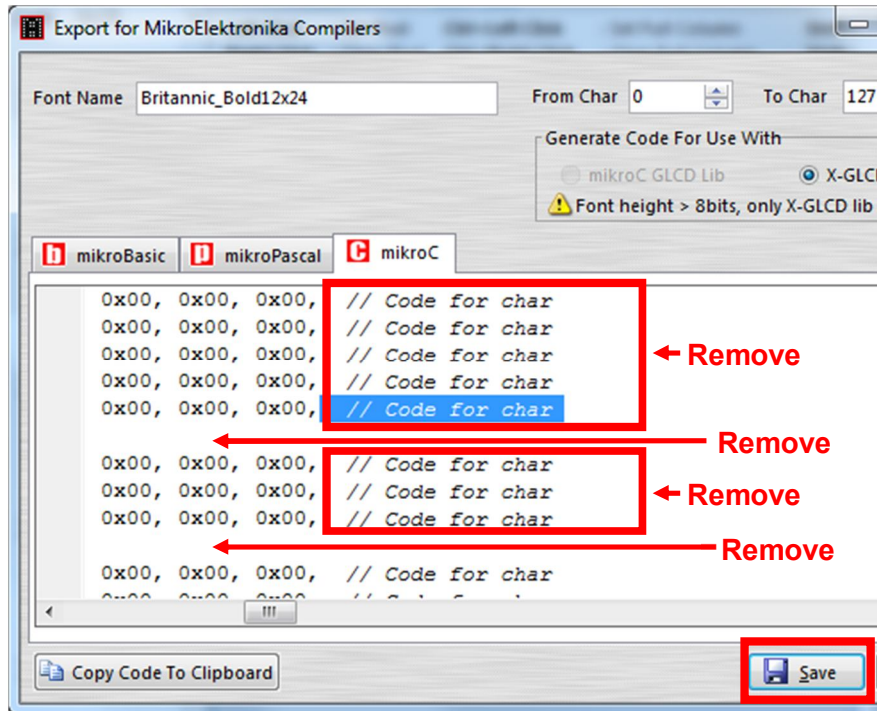

- Run Font Manager Tool.

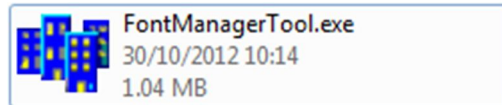

- Click [Setting] button

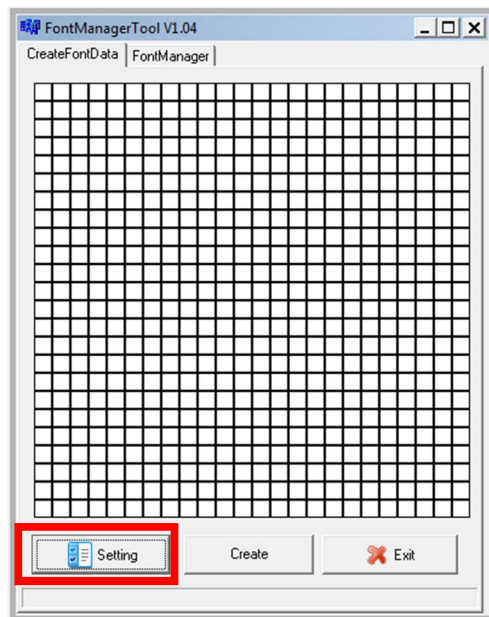

- Enter the file name, font id, and select the size.

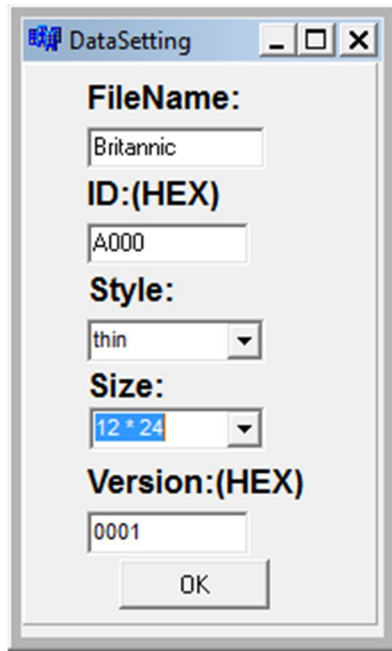

- Click [Create] button, and select the C file previously created using GLCD Font Generator.

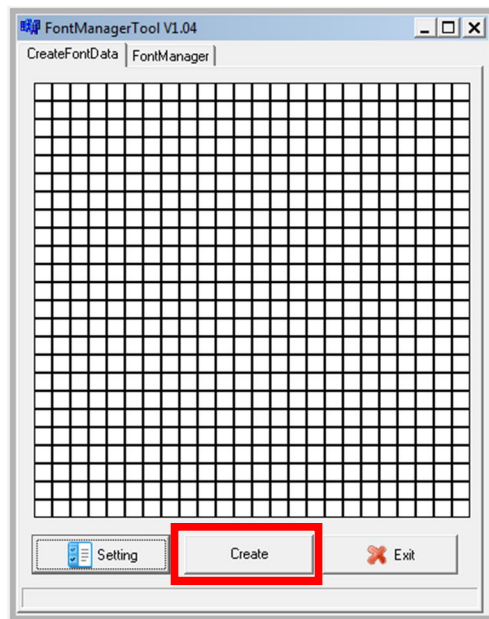

- Select [Font Manager] tab and tick the newly created font, and press [Generate] button to export to FNT file.

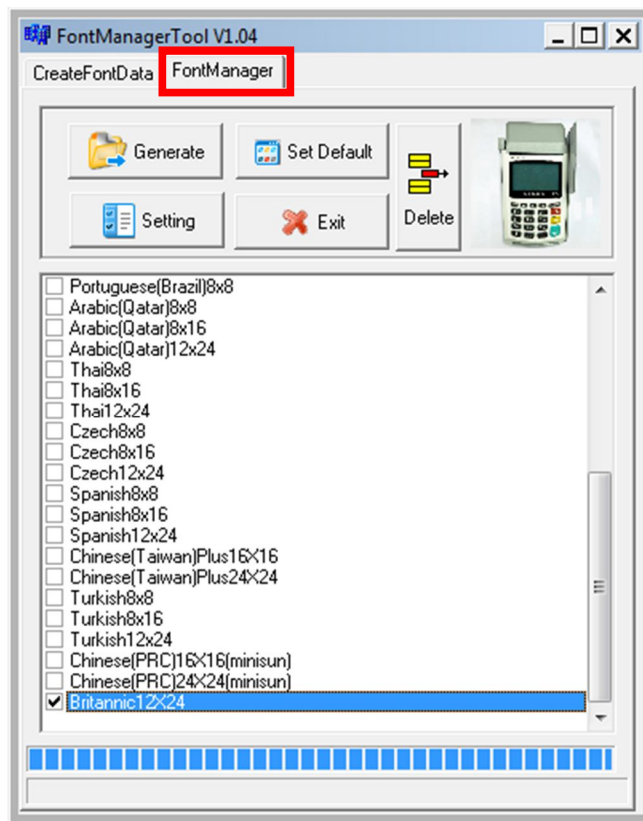

- Use CAP Generator to convert the FNT file to CAP.  
Set type to [11 – Linux Font], press [Step 1] button select the FNT file. Then press [Step 2] to generate CAP file.

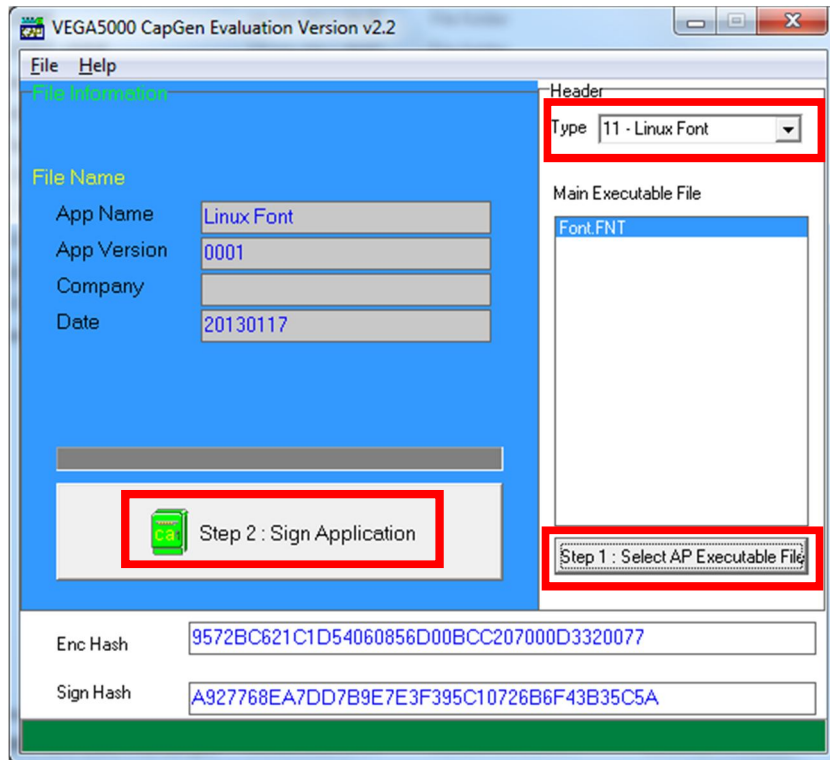

- Download the font CAP file to UPT1000.
- In the application, add following code to display message using the newly created font.

```
CTOS_LanguageConfig(0xA000,d_FONT_12x24,0,d_FALSE);
CTOS_LanguageLCDSelectASCII(0xA000);
CTOS_LCDTPrintXY(1, 1, "ABCDEFGH");
```

Or print message using the newly created font.

```
CTOS_LanguagePrinterSelectASCII(0xA000);
CTOS_PrinterPutString("ABCDEFGH");
```

### 5.3. Using TrueType Font (TTF)

TrueType Font (TTF) is supported in UPT1000. You can download the TrueType font to UPT1000 for displaying or printing.

**Following steps demonstrate how to use “Cooper Black” TrueType font.**

- Copy the TTF file needed to an empty folder.

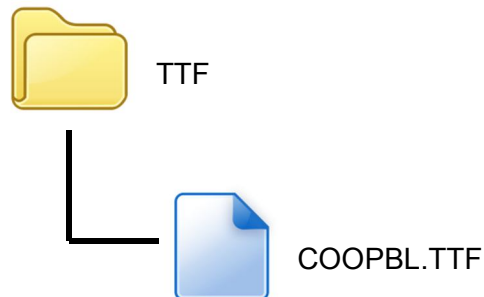

- Use CAP Generator to convert the TTF file to CAP.  
Set type to [11 – Linux Font], press [Step 1] button select the TTF file.  
Then press [Step 2] to generate CAP file.

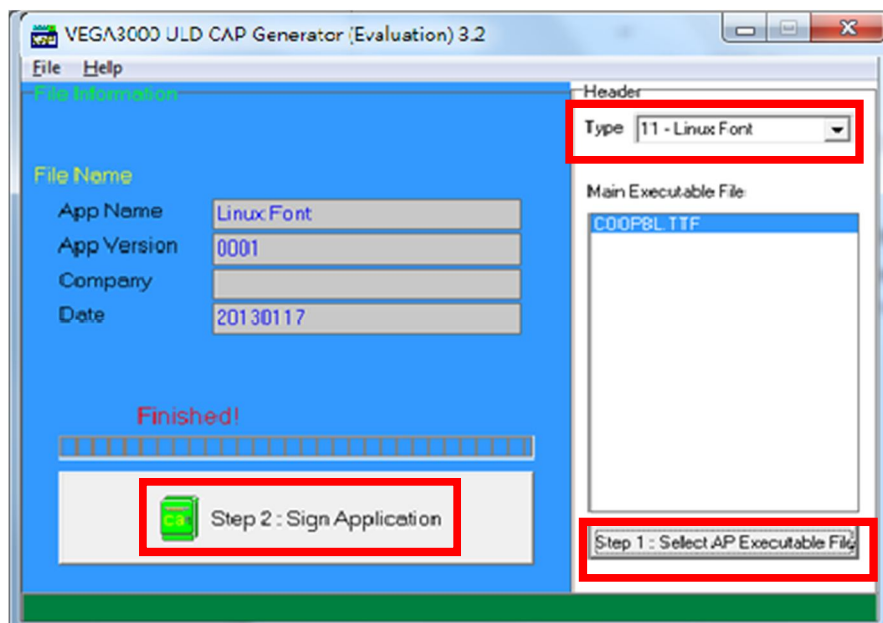

- Download the font CAP file to UPT1000.

- In the application, add following code to display message using the newly added font.

```
CTOS_LCDTTFSelect("COOPBL.TTF", 0);  
CTOS_LCDFontSelectMode(d_FONT_TTF_MODE);  
CTOS_LCDTSelectFontSize(0x203C); // 32x60  
CTOS_LCDTClearDisplay();  
CTOS_LCDTPrintXY(1, 1, "Hello World");
```

Or print message using the newly added font.

```
CTOS_PrinterTTFSelect("COOPBL.TTF", 0);  
CTOS_PrinterFontSelectMode(d_FONT_TTF_MODE);  
CTOS_LanguagePrinterFontSize(0x203C, 0, 0); // 32x60  
CTOS_PrinterPutString("Hello World");
```

## 6. Technical Notes

### 6.1. Serial Cable PIN Assignment

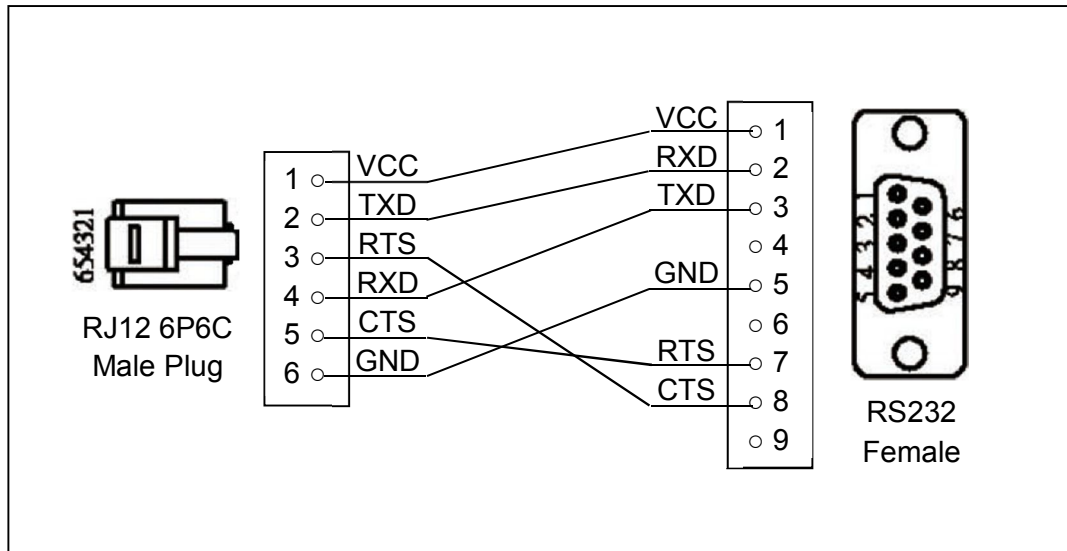



## 7. Appendix

### 7.1. Cautions

#### Federal Communication Commission Interference Statement

---

This device complies with Part 15 of the FCC Rules. Operation is subject to the following two conditions: (1) This device may not cause harmful interference, and (2) this device must accept any interference received, including interference that may cause undesired operation.

This equipment has been tested and found to comply with the limits for a Class B digital device, pursuant to Part 15 of the FCC Rules. These limits are designed to provide reasonable protection against harmful interference in a residential installation. This equipment generates, uses and can radiate radio frequency energy and, if not installed and used in accordance with the instructions, may cause harmful interference to radio communications. However, there is no guarantee that interference will not occur in a particular installation. If this equipment does cause harmful interference to radio or television reception, which can be determined by turning the equipment off and on, the user is encouraged to try to correct the interference by one of the following measures:

- Reorient or relocate the receiving antenna.
- Increase the separation between the equipment and receiver.
- Connect the equipment into an outlet on a circuit different from that to which the receiver is connected.
- Consult the dealer or an experienced radio/TV technician for help.

#### **FCC Caution:**

- Any changes or modifications not expressly approved by the party responsible for compliance could void the user's authority to operate this equipment.
- This transmitter must not be co-located or operating in conjunction with any other antenna or transmitter.

#### **Radiation Exposure Statement:**

---

This equipment complies with FCC radiation exposure limits set forth for an uncontrolled environment. This equipment should be installed and operated with minimum distance 20cm between the radiator & your body.

Note: The country code selection is for non-US model only and is not available to all US model. Per FCC regulation, all WiFi product marketed in US must fixed to US operation channels only.

~ END ~