

CATCHWELL

CATCHWELL CW30 User Guide



This User guide contains important information to ensure the user's safety and prevent damage to property. Please read this user guide carefully and use the product accordingly.

Product Notices

2011 by Catchwell, Inc. All rights reserved.

No part of this manual can be replicated nor copied by any means – all electronic or mechanical means such as digital media or paper, etc. -- without prior written consent from Catchwell. The contents of this manual can be subject to change without prior notice.

Software will be provided literally “as is.” All software including firmware, applications, etc. have been appropriately licensed. In regard to all the provided software, Catchwell assigns users non-transferable, non-exclusive license. Except for the cases set forth hereunder, a user is not allowed to transfer the license to a third party in the form of sublicense or by other means. All or partial modification, merge, integration of the software except for the cases allowed by the copyright laws are prohibited. Hereby, a user shall agree with not violating the laws regarding decompile, disassembly, decoding, and reverse engineering of all or a part of the licensed software without prior consent from Catchwell.

Catchwell holds rights to modify the product or software in order to improve the stability, features, and design of the product.

Catchwell does not accept any liability whatsoever for any incidental or consequential loss or damage arising from the use of applications, products, circuits or other software mentioned in this manual.

Catchwell and its logo and Catchwell and its logo are trademarks. Microsoft, Windows CE, Windows Mobile, Bluetooth, Wi-Fi, GSM, etc. are all the properties of their respective owners.

Catchwell™

B-405, Bundang Techno Park, 148, Yatap-dong, Bundang-gu, Seongname-si, Gyeonggi-do
<http://www.catchwell.com>

Table of Contents

Product Notices	2
Table of Contents.....	3
Information on this manual	5
Precautions for Users	6

Chapter 1. Getting Started

Product Components	9
Unpacking the product.....	11
Accessories	12
Accessory components	12
Accessories for individual use	13
Installing the SIM card	15
Installing the main battery.....	16
Install the battery.....	16
Charging the battery	17
Charging temperature.....	17
How to check remaining power in the battery	18
How to take care of the battery.....	19
Changing power settings	19
Changing backlight settings.....	20
Turning off the wireless function	20
MicroSD(Micro Secure Digital) card	22
Adjusting the hand strap	22
Removing the screen protection cover ...	22

Chapter 2. Using CW30

Overview	24
Start Screen.....	24
Title bar	24
Notifications.....	25
Connectivity.....	25
Status-indicating icons	26
Audio	27
Battery level	27
Home Screen.....	28
Classic Home Screen	29
Soft key indicator bar	30
Start Screen.....	30
Settings folder.....	34
Connections folder	35

Personal folder	36
System folder	37
Adjusting Volume	39
Display of battery level.....	40
Resetting CW30.....	41
How to perform a soft reset.....	41
How to perform a hard reset	41
Turning on or off backlight	42
Locking CW30	43
Locking with a password.....	43
Function buttons	45
Data entry	46
Viewing pictures and videos	46
Taking a picture.....	47
Video recording.....	48

Chapter 3. Data Capture

Overview	50
Laser scanning	50
Things to be considered for scanning.....	50
Scanning barcodes	51
Image decoding	52
Operation modes	52
Image scanning	53

Chapter 4. Using the phone

Overview	55
Using the phone application	55
Turning on or off the phone.....	55
Audio mode.....	56
Using wired headsets	56
Using Bluetooth headsets.....	56
Adjusting audio volume.....	57
Making a phone call.....	57
Using the Phone Dialer.....	58
Using Contacts	58
Using Call History	59
Making emergency calls	59
Answering Calls	60
Handling incoming calls	60
Smart Dialing	60

To search for phone numbers	61
How to find contacts	61
To mute the microphone during a call.....	62
How to mute or unmute the microphone during a call	62
Creating a memo	62
How to check the memo created during a call	63
Using Speed Dial	63
How to add an item to Speed Dial	64
Editing or Deleting Speed Dial shortcut..	65
Using Call History	66
Managing Call History	66
Modifying Call History View.....	66
Resetting the recent call counter	67
Deleting all Call History.....	68
Viewing call details	69
Using Call History menu	70
Switching calls on CW30	70
Text message.....	71
Viewing text messages	71
Sending text messages.....	72

Chapter 5. Using a GPS Navigation

Overview	75
Installing a software	75
Setting up GPS on CW30	75
Operation	76
GPS maps on a microSD card.....	76
Answering calls while using GPS.....	76
When you lose GPS signals in a car...	77
Auxiliary GPS.....	77

Chapter 6. Using Bluetooth

Overview	79
AFH (Adaptive Frequency Hopping).....	79
Security	80
Composition of Bluetooth.....	80
The ports supported by Microsoft Bluetooth Stack.....	81
Hard reset	81

Soft reset.....	81
Pause	81
Restart.....	81
Power states of Bluetooth.....	81
Using Microsoft Bluetooth Stack.....	81
Turning on or off the Bluetooth Wireless mode	82
Bluetooth activation.....	82
Bluetooth deactivation.....	83
Searching for Bluetooth devices	83
Available Services	86
Serial Port Services.....	87
ActiveSync using serial port services..	89
A2DP/ AVRCP Services	90

Chapter 7. Maintenance and Troubleshooting

Maintenance	92
Safety instructions on battery	92
Cleaning.....	93
Screen.....	93
Scanner window.....	93
Connectors.....	93
Cradle.....	94

Information on this manual

The contents of this manual contain the version of Windows Mobile running on CW30.

 The illustrations contained in this manual may be different from actual screens.

Technical Support

If you find any problem in the product, please contact Technical Support Team of Catchwell (tel:+82-31-788-5324). Or you can visit our Q&A bulletin board at our web site (<http://www.catchwell.com>) for further inquiry.

When you make an inquiry, please have the followings ready:

- Serial number of the product
- Model number
- Supplier information, the user's contacts, and the place where the user works

If a problem reported to the Technical Support Team of Catchwell has not resolved, a user may have to send the product to Catchwell for services and Catchwell doesn't provide the user with a replacement device unless there is a signed agreement between the user and Catchwell. Catchwell does not accept liability for damages that may result from improper packaging when the user sends the product to Catchwell.

If you purchased the product from a supplier of Catchwell, please contact the supplier for product support.

Precautions for Users

The following is the information for the safety of users and for preventing the product from being damaged. Please read the followings carefully and use the product accordingly.

Power

- In the event of abnormal sounds, smells, or smoke, please contact Customer Support after unplugging the product from the power outlet and removing the battery.
- Do not touch the power plug with wet hand.
- Do not charge the battery while thundering or lightening, and unplug the cradle from the power outlet.
- Do not use the device in rainy or wet places.
- When the surface of the product is wet, turn off the product and remove the battery from the product, then wipe off water with a cloth or a dry towel before use.
- Use the cradle when you charge the battery, if possible.

Installation and storage

- Do not store the product inside a car to avoid possible theft.
- Keep PDA and its stylus out of the reach of children to avoid injury.
- If PDA is not going to be used for prolonged periods of time, insert it into the cradle for continuous power supply.

About using this product

- When you use the battery for the first time, please use the battery after being fully charged.
- Before resetting the device, please backup programs and data in advance.
- Before proceeding with software reset, please backup currently-using programs and data to a safer place. As the saved data will be safe, data or files currently being used may be deleted.
- Do not place any heavy object on the product.
- Do not use the product in humid or dusty places or near heat sources (heaters, cigarette light)
- Be careful neither to drop the product nor to give it an excessive shock.
- If the touch screen gets dirty with foreign materials, clean it before use.
- When using the touch screen, do not use sharp objects (pens, steel wires, and screwdrivers), and only use the stylus and dedicated accessories coming with the products.
- Only use the provided batteries, power adapter, and cradle.
- In regard to the damages resulting from other software installed by a user after purchasing the product, Catchwell shall not warrant the product.
- Be careful to prevent the surface of a battery from being in contact with metallic objects.
- If the product has features like laser or flash, do not level them at the eyes of people or animals. In so doing, their sight may be impaired.

About communication

- Do not use PDA nor make a call while driving a car to avoid an accident.
- Do not touch the product or its power plug with wet hand or you may get shocked by electricity. Turn off the product in aircraft or in hospital. The electromagnetic waves of the product may interfere with electric aviation devices or medical equipments.
- Turn off the product in the areas exposed to the risk of explosion. Especially, it is safer to power off the product while gassing up a car.
- Be wary of using a headset (earphones). The use of headphones at high volume for prolonged periods of time may impair hearing ability.

Warranty

- Please do not arbitrarily attempt to disassemble, repair, and modify the main unit of the product. In such cases, warranty of the product will be invalidated.



Chapter 1. Getting Started

Product Components	9
Unpacking the product	11
Accessories.....	12
Accessory components.....	12
Accessories for individual use.....	13
Installing the SIM card.....	15
Installing the main battery	16
Install the battery.....	16
Charging the battery.....	17
Charging temperature	17
How to check remaining power in the battery	18
How to take care of the battery	19
Changing power settings.....	19
Changing backlight settings	20
Turning off the wireless function.....	20
MicroSD(Micro Secure Digital) card..	22
Adjusting the hand strap	22
Removing the screen protection cover..	22



1 Getting Started

Product Components

This chapter will explain each part of the product and its accessories.

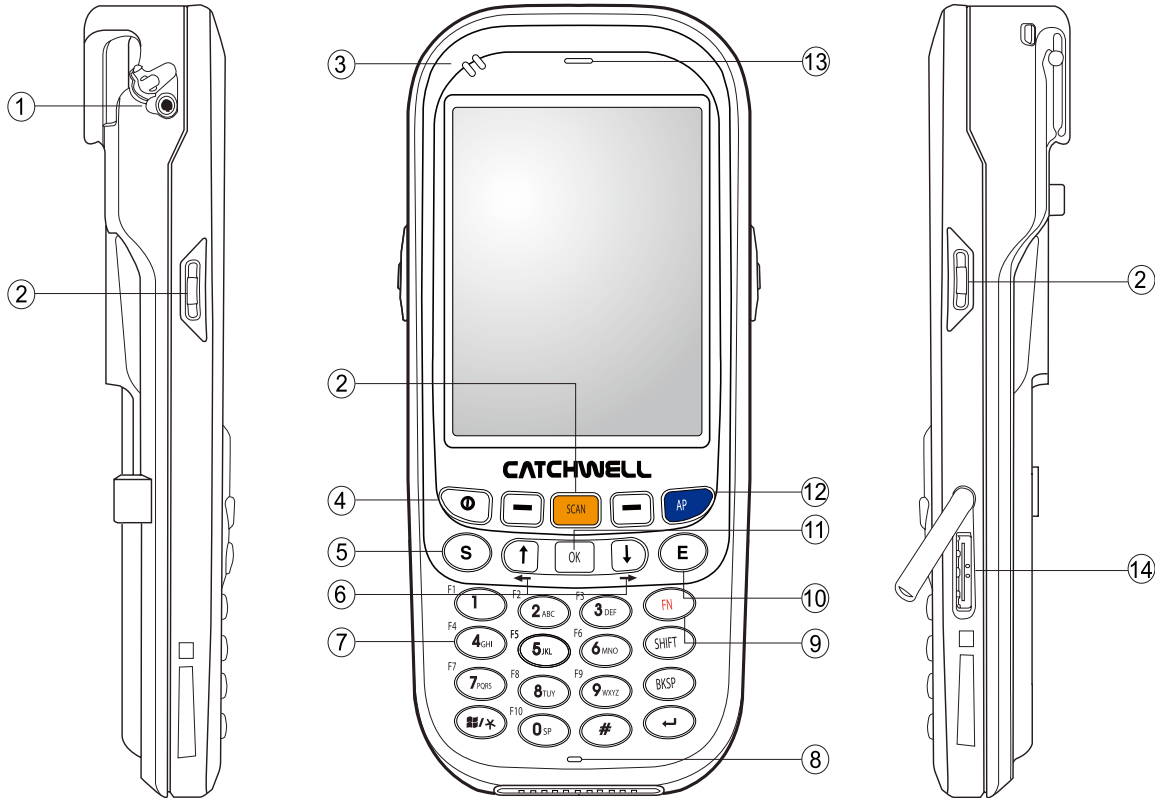

No	Contents
①	Ear phone jack
②	Scan button
③	Statue LED - Charging : red LED turn on - Operation : blue LED turn on - Full charging : green LED turn on - Connecting error : Blink red LED
④	Power button
⑤	Send button
⑥	Direction button
⑦	Numeric and Alphabet button
⑧	Microphone
⑨	Function button
⑩	End button
⑪	Select / run / ok button
⑫	Keymap mode button
⑬	Front speaker
⑭	24pin connector

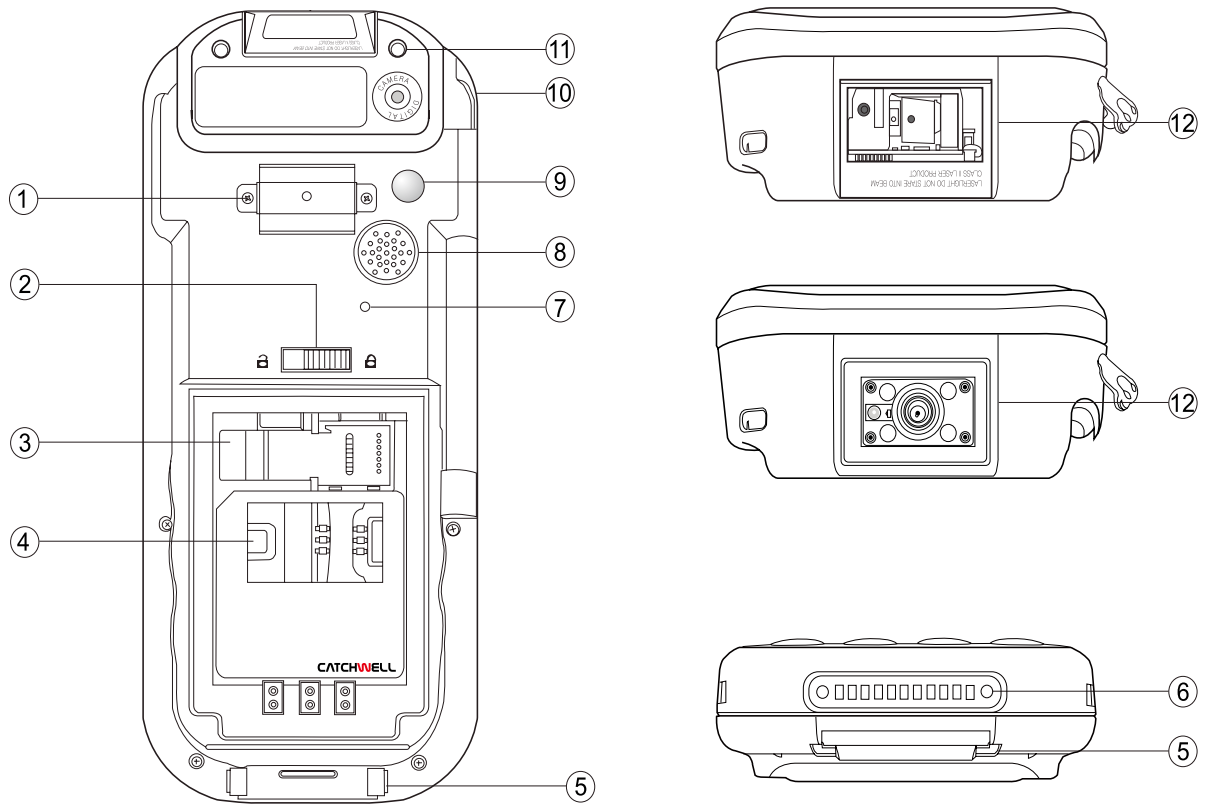

No	Contents
①	Handbelt
②	Battery Lock latch
③	SD memory slot
④	USIM slot
⑤	Handbelt slot
⑥	Battery charging connector
⑦	Reset button
⑧	Rear speaker
⑨	Flash LED
⑩	Stylus holder
⑪	Digital camera
⑫	Barcode scanner

Unpacking the product

Please check whether or not there is any damaged or missing component in the box. If there is any problem, please contact the supplier.



Main unit of PDA

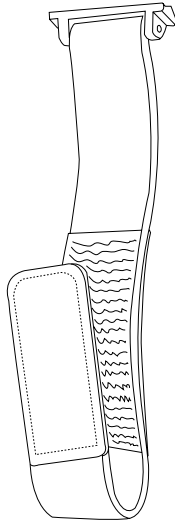

Hand strap



Waist strap

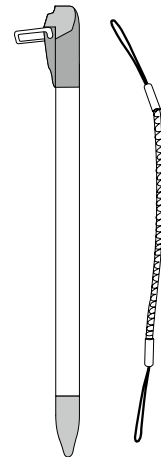

Stylus and its string

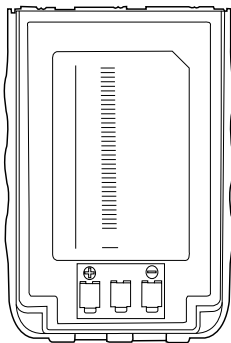

Li-ion polymer battery



Protective film

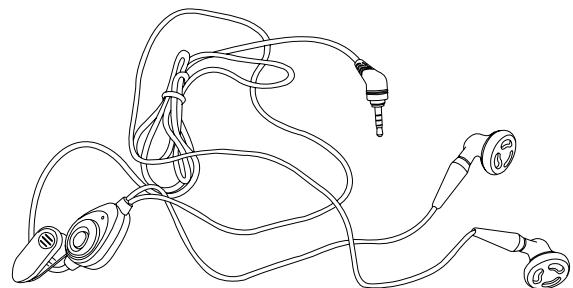

Earset: if it has a phone function

Accessory components

- **1-slot cradle**

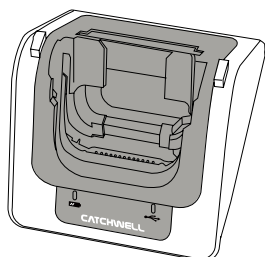

Cradle for charging and communication

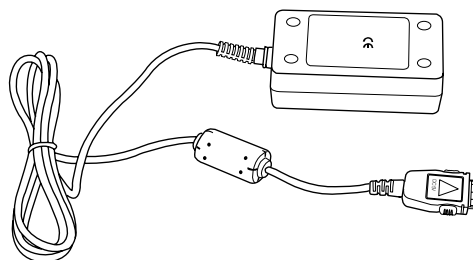

Power adapter

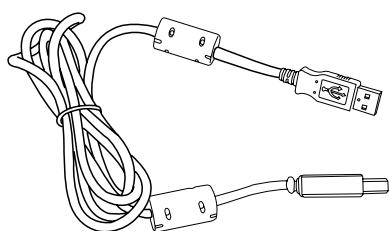

USB cable

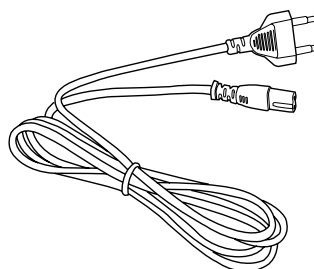

Power cord

- **Cradle components for the use in a car**

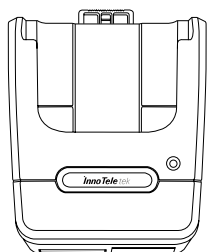

Cradle for car use

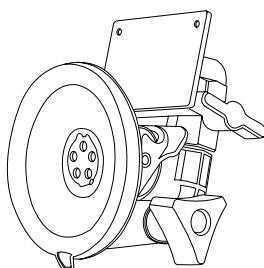

Car mount kit

• 4-slot cradle components

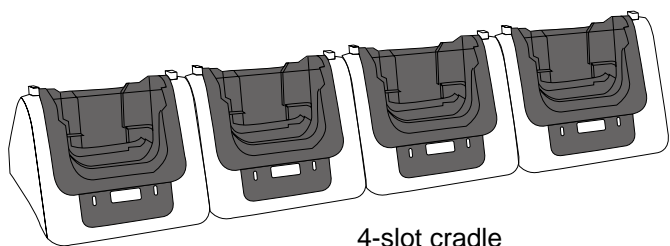

4-slot cradle

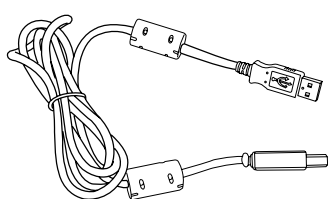

Power adapter

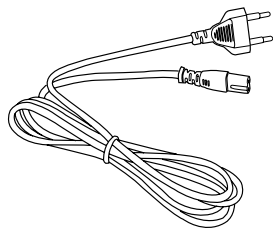

USB cable

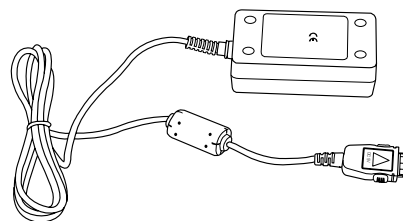

Power cord

Accessories for individual use

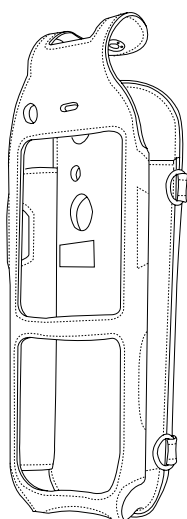

Leather case

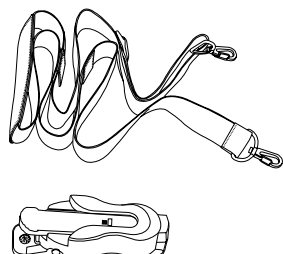

Hand strap

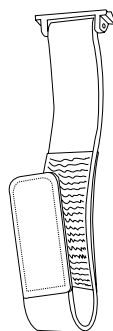

Waist strap

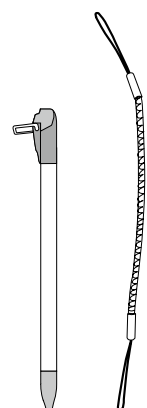

Stylus
Stylus string

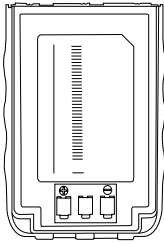

Li-ion polymer battery

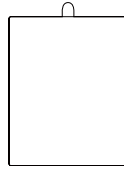

Protective film

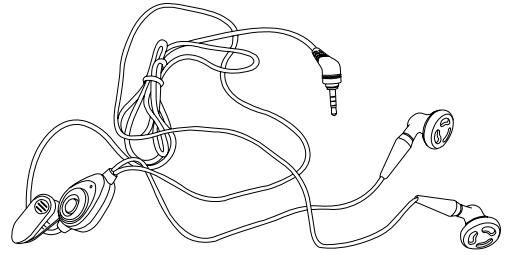

Earset

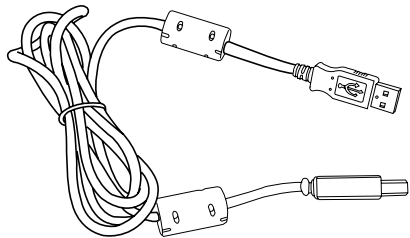

USB cable

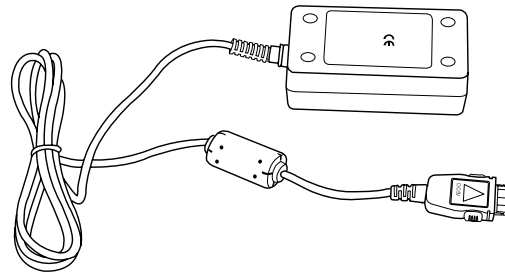

Power adapter

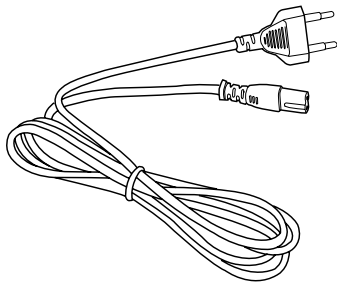

Power cord

Installing the SIM card

Please refer to the manual provided by your service provider for further information on SIM card.

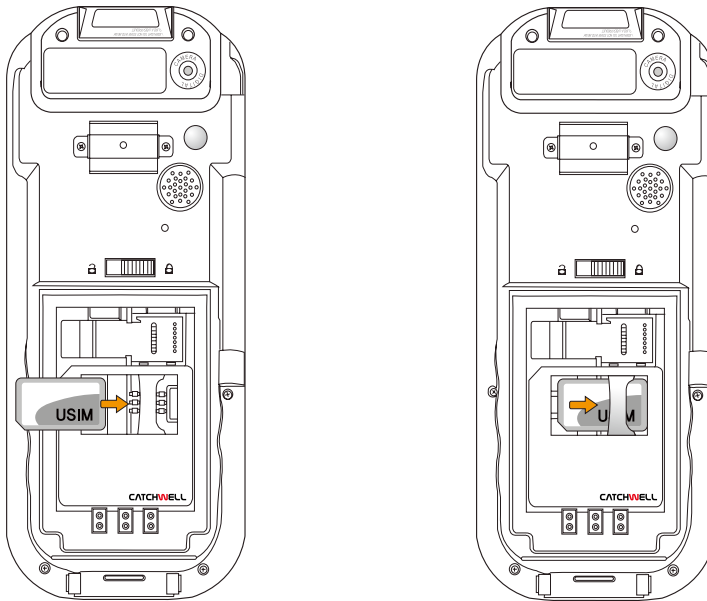

After installing a SIM card for the first time or after replacing it,

- 1 Turn on the device
- 2 Press tap on Wireless Manager on Today Screen.
- 3 Make sure the phone is turned on
- 4 Make a call for checking cellular connection.

Installing the main battery

Install the battery



Caution

- One battery comes with the product. You can buy extra battery separately.

- 1 Insert the battery from the bottom to fit into the slot of the device on the bottom.

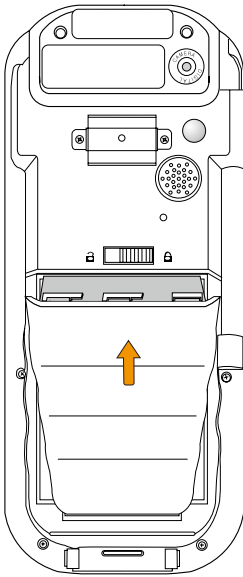

- 2 Press down the top of the battery toward the device and slide the latch to the left to fix the battery with the device.

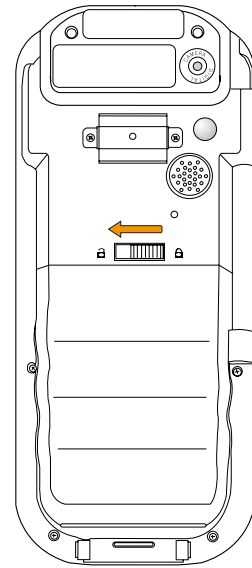

- 1 Press down the top of the battery and slide the latch to the right to release the battery from the device.

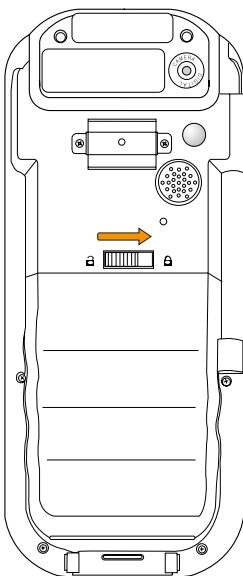

- 2 Hold the sides of the battery and pull out.

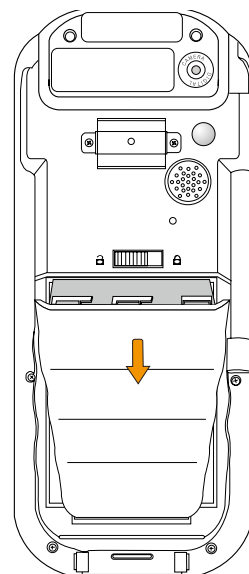

Charging the battery

Before using the battery for the first time, please fully charge the battery until yellow light is on LED, which indicates charging status. Use only the adapter and cable that came with cradle when charging the battery. In order to charge the backup battery inside the product, we recommend that you charge the battery more than 24 hours before using the product for the first time. Charging may take longer if the battery is installed in a PDA that is turned on.

Charging indicator LED (PDA LED, cradle, etc.)

Charging/battery level indicator LED	Description
Turned off	Unable to charge in PDA / The battery is not properly inserted into the cradle or power is off/ The power of the charger or cradle is disconnected.
Red is on	Charging
Red flashes	Charging error – Ambient temperature is too low or too high. Poor contact between the battery and the charging terminals due to foreign materials, etc.
Yellow is on	Charging complete



Caution

- Please charge the battery for more than 24 hours before the first use.

Charging temperature

Charging temperature ranges from 0°C to 40°C (32°F ~ 104°F).

How to check remaining power in the battery

To check the charging status of CW30, tap Start > Settings > Systems > Power and open Power Screen. Check automatic power-off after a certain period of time by tapping "Advanced" tab in order to expand battery running time.

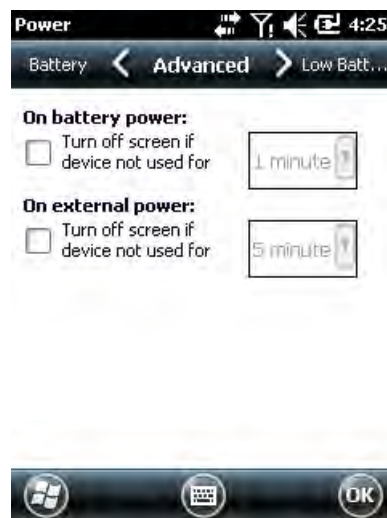
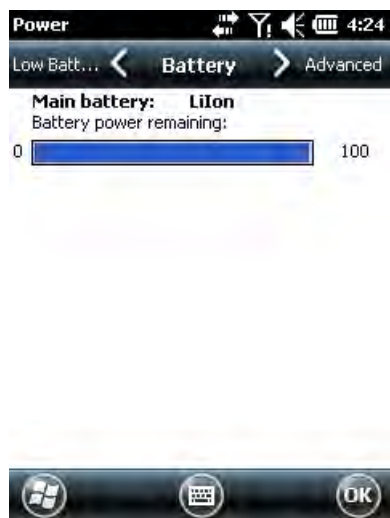

How to take care of the battery

Please follow the battery saving instructions below.



Caution

- The default settings for WWAN, WLAN and wireless Bluetooth are set at Off.

Leave CW30 connected to the power when it is not in use.
Set the power to turn itself off when it is not used for a specific time.
Set the back light to turn itself off when it is not used for a specific time.
Turn off every wireless task when it is not in use.
Turn off the power of CW30 to charge at a faster speed.

Changing power settings

How to set CW30 so that it is turned off when it is not used for a specific time

- 1 Start > Settings > Power icon > Advanced tab
- 2 On battery power: Turn off screen if device not used for (When battery power is used: turning off the device when it is not used for the following time period) Select the X mark and select one of 1 min~5 min from the dropdown menu.
- 3 Select OK.

Changing backlight settings

How to set CW30 so that only the backlight is turned off when it is not used for a specific time

- 1 Start > Settings > System > Backlight icon > Battery Power tab
- 2 On battery power: Disable backlight if device is not used for (When batter power is used: turning off the backlight when it is not used for the following time period) Select the X mark and select one of 1 min~5 min from the dropdown menu.
- 3 Select OK.



Turning off the wireless function

The Microsoft Windows Mobile 6 device includes Wireless Manager which allows every wireless function of the device to be activated, deactivated and composed at one place.

To open Wireless Manager, press Wireless Manager or press Connectivity icon on the Home screen.



Select Wireless Manager.

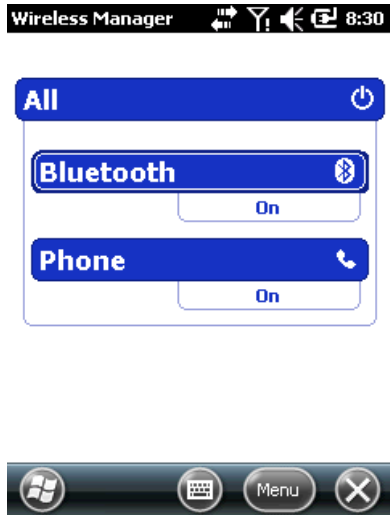

- Wireless Connectivity option may differ depending on the composition.

Press specified button to activate or deactivate wireless network.
Press ALL button to activate or deactivate every wireless connection.
Press Menu to compose connectivity settings.

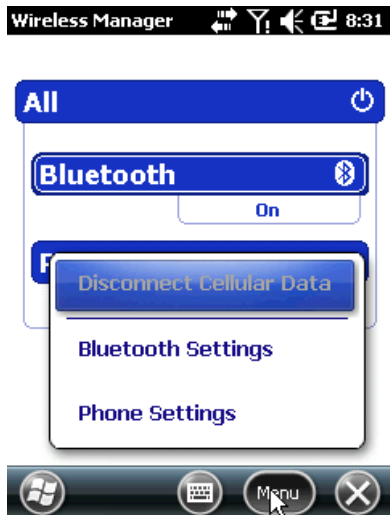

MicroSD(Micro Secure Digital) card

The MicroSD card slot provides an additional saving device function. This slot is located at the bottom of the battery mounting part.



- To prevent MicroSD from damages is careful about static electricity or other damages. It is recommended to follow the appropriate ESD preventive measures for static electricity.

[Installing MicroSD]

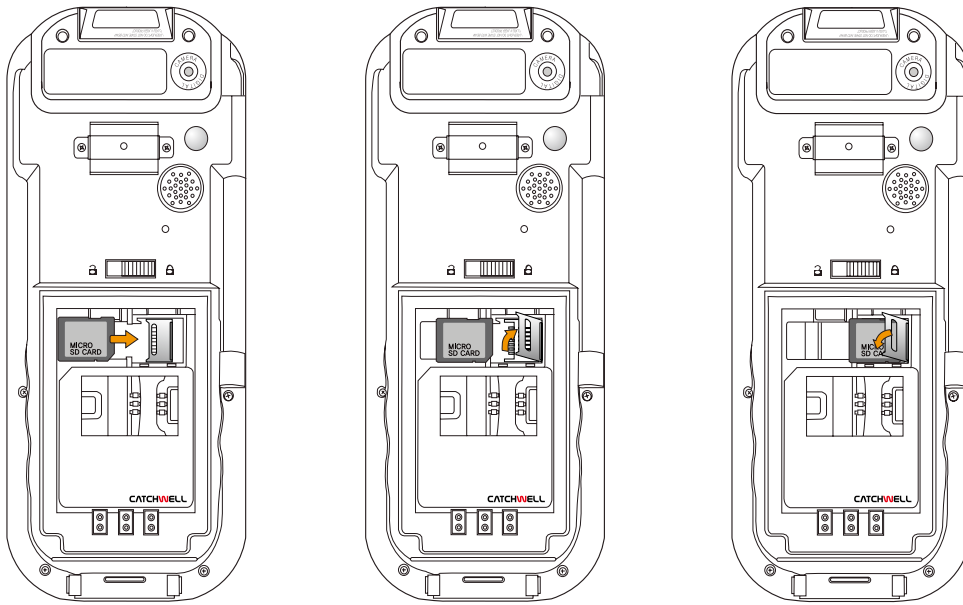

Removing MicroSD is in the reverse order.

Adjusting the hand strap

Adjust the hand strap for the convenient use of the device for a long period of time.

- 1 Connect the hand strap to the end of the device beneath the battery cover.
- 2 Adjust the length of the hand strap by passing the Velcro through the hole.
- 3 Press both sides of the strap together to get fixed.

Removing the screen protection cover

The screen protective cover is installed at factory before shipment in order to minimize abrasion that may occur during shipment.

Remove the screen protective cover before use. After removing it, attach protective film to the screen immediately.

Chapter 2. Using CW30

Overview	24
Start Screen	24
Title bar	24
Notifications	25
Connectivity	25
Status-indicating icons	26
Audio.....	27
Battery level	27
Home Screen	28
Classic Home Screen.....	29
Soft key indicator bar	30
Start Screen	30
Settings folder	34
Connections folder	35
Personal folder.....	36
System folder	37
Adjusting Volume	39
Display of battery level	40
Resetting CW30	41
How to perform a soft reset.....	41
How to perform a hard reset	41
Turning on or off backlight.....	42
Locking CW30.....	43
Locking with a password	43
Function buttons.....	45
Data entry.....	46
Viewing pictures and videos.....	46
Taking a picture	47
Video recording	48

2 Using CW30

Overview

This chapter will explain how to use the buttons of CW30 and status icons, including the basic instructions on turning on CW 30, resetting, data entry and capture.

The default wireless status of CW30 is as follows:

- Wireless LAN – Off
- Bluetooth – Off
- Phone – Off

Start Screen

The Home Screen is composed of status bar at the top, the Home Screen in the middle, and soft keys at the bottom. The descriptions on those elements are as follows:

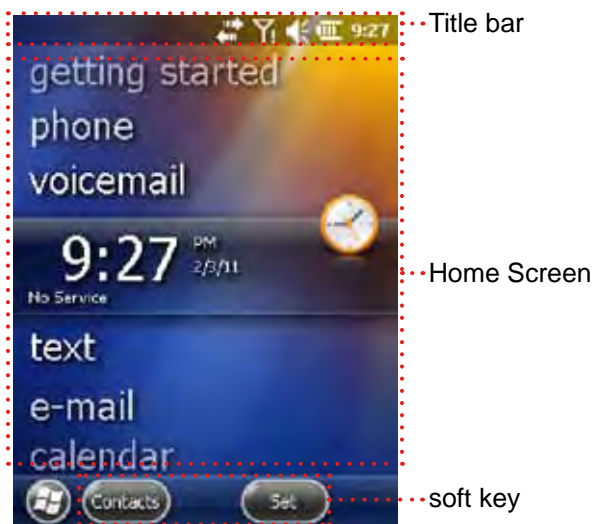

Title bar

In the title bar, status-indicating icons may be listed in table 2-1.

Notifications







	The backup battery is low.
	Received more than one instant message.
	Received more than one email or text message.
	Received more than one voice message.
	There are more notifications than indicated. Tapping this icon will display the rest notifications.
	Notifications of upcoming appointments

Table 2-1

Connectivity













	Connected.
	Not connected.
	Synchronization in progress.
	Wi-Fi is available.
	Wi-Fi is in use.
	HSDPA is available.
	3G is available.
	GPRS is available.
	EGPRS is available.
	1XRTT is available.
	EVDO is available.
	Idling state or no data received during EVDO connection

Table 2-1

Status-indicating icons



















	There are missed calls.
	Dialing without SIM card.
	Call is in progress.
	Calls are forwarded.
	Call on hold
	Antenna/Signal icons: Connected to a wireless network and signal strength is okay.
	Antenna/Signal icon: Not connected to a wireless network
	Antenna/Signal icon: No service or signal search is not available
	Connecting to HSDPA.
	HSDPA is in use.
	Connecting to 3G.
	3G is in use.
	Connecting to GPRS.
	GPRS is in use.
	Connecting to EVDO.
	EVDO is in use.
	Roaming in progress.
	No SIM card installed.

Table 2-1

Audio



	All sound is on
	All sound is off
	Vibration mode is on

Table 2-1

Battery level







	Main battery charging.
	Main battery fully charged
	Main battery charged enough
	Main battery is half full
	Main battery is low
	Main battery is very low

Table 2-1

Home Screen

The Home Screen showing the list of applications and information status indicating bar is scrollable. The application and its additional information are highlighted in Information status bar.

The home screen moves up and down if you scroll the screen up and down while pressing and holding on the screen with your finger. And the information on the selected application will be displayed on the status bar as the names below information status indicating bar moves.



[Scrolling the Home Screen up and down with the finger]

In addition, you can move your finger up and down by skipping the names of applications while pressing and holding on the information status indicating bar. When you stop holding on your finger on the screen, the information status display bar and the name of the application will be displayed at the center of the screen.



[Moving information status display bar]

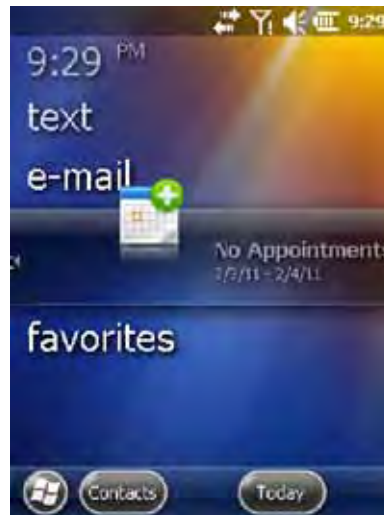

[An example of information status display bar]

To customize Home Screen, tap Start > Setting > Home icon. You can customize the background of the screen using the Appearance tab and change the screen properties using the Property tab.

Classic Home Screen

You can change the Home Screen into the classic layouts used for Windows Mobile 6.5.

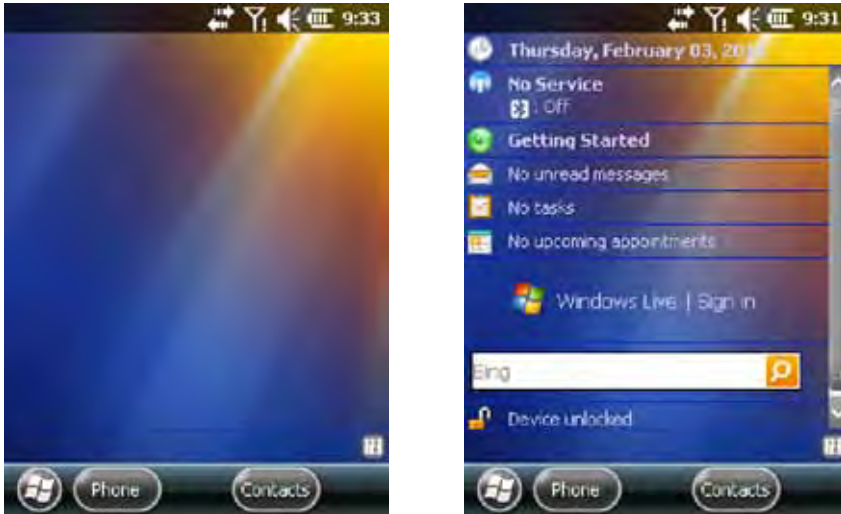

[Home Screen in classic layout]

To change the screen to the classic layouts, go to Start > Setting > Home tab.



[Setting Home Screen]

Uncheck the checkbox that was pre-checked by Windows and select other options. Then press OK.

Note: Task bar is only available in the classic layout.

Soft key indicator bar

The soft key indicator bar is displayed at the bottom of the screen, and there are two post-key buttons. This button shows a user a task and menu depending on situations and can be dynamically changed. For example, the soft key of viewing the list of Contacts is New menu. If a user starts to create a new contact on that screen, that soft key will be changed to Complete and Menu.

Start Screen







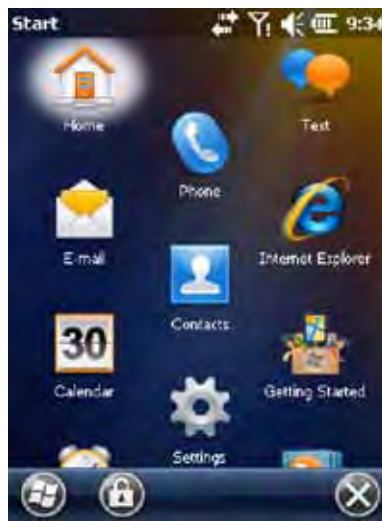

The user applications and folders are displayed on the Start Screen. Figure 203 shows basic applications and folders displayed on the Start Screen.











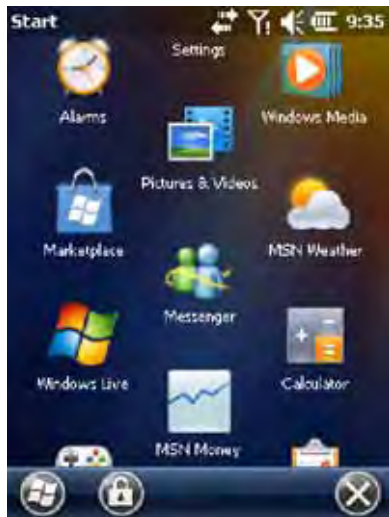

[Start screen]







[Program and folders at Start screen]

	Home	Closing Start menu and displaying the Home Screen.
	Phone	Making calls, Answering calls, changing calls, and configuring call conference.
	Text	Sending and receiving SMS text messages.
	E-mail	Sending and receiving emails.
	Contacts	Sharing contacts with friends and peers.
	Internet Explorer	Browsing web and WAP sites and downloading new programs and files from the Internet.
	Calendar	Managing appointments and request meetings.
	Settings	Opening the configuration folder. See Configuration Folder in page 10.
	Getting Started	Launching Start applications.







	Alarms	Setting local time of each country and alarms
	Picture & videos	Viewing and managing pictures, animation, gif, and video files.
	Windows Media	Playing audio and video files.
	Marketplace	Purchasing or downloading applications from the Marketplace. You can reconnect to it after upgrading via the Internet using ActiveSync, if it is your first time use.
	Messenger	A mobile version of Windows Live Messenger.
	MSN Weather	Checking nearby weather forecast.
	Windows Live	If you want to search for information on the web, use the Windows Live™.
	Calculator	Performing basic arithmetic calculations including addition, subtraction, multiplication, and division
	MSN Money	Manage finances of a user



	Game	Launching games.
	Notes	Creating handwriting memos or pictures or voice recording files.
	Tasks	Managing tasks
	File Explorer	Configuring and managing files in the device
	Internet Sharing	Share the Internet connection using CW30









	Active Sync	Synchronizing information between CW30 and a host computer or Exchange
	Task Manager	Viewing memory usage and CPU allocation status. You can end running processes using this. For further information, please refer to user's manual of Microsoft application for Windows Mobile 6.
	Contact Search	Searching for contacts, data, or other information in CW30. For further information, please refer to user's manual of Microsoft applications for Windows Mobile 6.
	Help	Displaying online help on the current screen or program.
	Remote Desktop Mobile	Remote Desktop Mobile : Run Remote Desktop Mobile



Settings folder

Pre-installed configuration applications are listed in Table 2-4. Choose Start > Settings to open Settings folder.







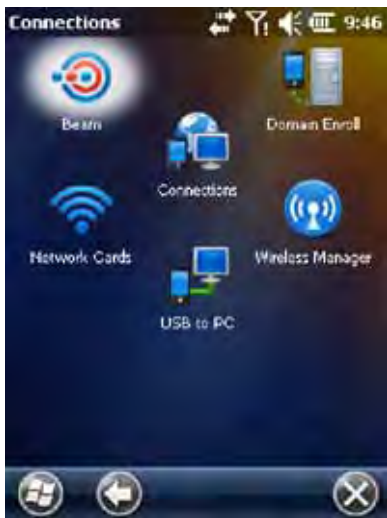

[Table 2-4. Configuration applications inside the Settings folder]

	Bluetooth	Opening Bluetooth applications, setting CW30 to visible mode, and searching for other Bluetooth devices within range.
	Clock & Alarms	Setting the clock of device to the data and time of local residence or if you are on travel, you can set them to the corresponding area. You can set alarm for specific date and time.
	Home	Customizing the appearance of the Home Screen and displayed information on the screen.
	Locks	Setting a password for CW30.
	Power	Checking remaining battery power and saving power by setting up the expiry time of display.
	Sounds & Notifications	Selecting sounds for various events and alarms and set how to alarm for each event.
	Connections	Connection applications are contained (see the below).

	Personal	Personal applications are contained (see the below).
	System	System applications are contained (see the below).



Connections folder



	Beam	A feature related to IrDA (however, it is not supported on CW30)
	Connections	In order for the device to connect to the Internet or private local networks by configuring more than of connection types – Dial-up, GPRS, Bluetooth, Modem, etc.
	Domain Enroll	For the management and security of a registered device, enroll the device in Active Directory. For further information, refer to user's manual of Microsoft applications for Windows Mobile 6.
	USB – PC	Activating or inactivating and enhanced network connection.
	Wi-Fi	Configuring a wireless network connection and user-defined settings.
	Wireless Manager	Activating or inactivating a wireless connection of CW30 and configuring user-defined Wi-Fi or Bluetooth settings.

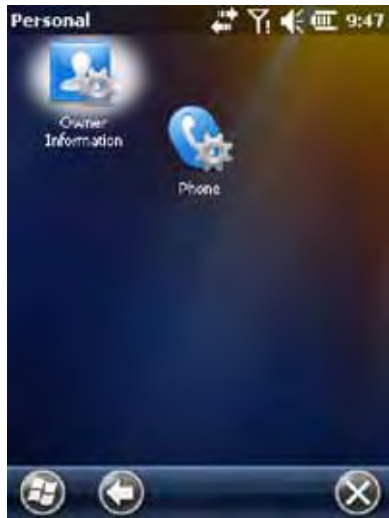







Personal folder











	Owner Information	Entering CW30 owner's information.
	Phone	Configures the phone settings

System folder



	About	Viewing the basic system information such as the version of Windows Mobile R, the type of processor used for CW30, etc.
	Backlight	Setting the expiry time of display backlight and adjusting brightness.
	Barcode	Setting Barcode message modes, gun modes, decoding sounds, etc.
	Certificates	Verifying the certificate information installed in CW30.
	Customer Feedback	Submitting a user's comment on Windows Mobile 6 software.
	Device Profile	Verifying the build information of CW30 and the other module information.
	Encryption	Encrypting files in a storage card. The encrypted files can be only read on this device.
	Error Reporting	Activating and inactivating the error reporting feature of the device. Once this function is activated, any occurrence of error will be recorded in a text file including the status of the program and the computer, and if a user wants, it will be reported to Technical Support Team at Microsoft.
	External GPS	Configuring an appropriate GPS communication port, if necessary. If there is any program accessing GPS data in the device, or in case of connecting GPS receiver to the device, you have to perform this task in advance.



	Keypad	Configuring keypad shortcuts and key maps.
	Managed Programs	Displaying installed applications in CW30 using Mobile Device Manager.
	Memory	Checking memory allocation status and memory card information; aborting currently-running programs.
	Regional Settings	Configuring CW30 locale settings according to each region including how to display numbers, currencies, date/time, or time format.
	Remove Programs	Removing programs installed in CW30.
	Screen	Changing display direction; compensating for the display after the change; changing text size. <ul style="list-style-type: none"> - Screen Orientation: Select Portrait Mode or Landscape Mode - Calibration of Screen: Calibrate the screen for accurate touch operation. - Font Size: Adjust the font size displayed on the screen.
	Task Manager	Stopping running programs.
	USB Connections	Configuring how to operate when establishing a USB connection.

Adjusting Volume

How to adjust volume using speaker icon on the Navigation Bar.

- 1 Tap the speaker icon to open the volume dialogue box.

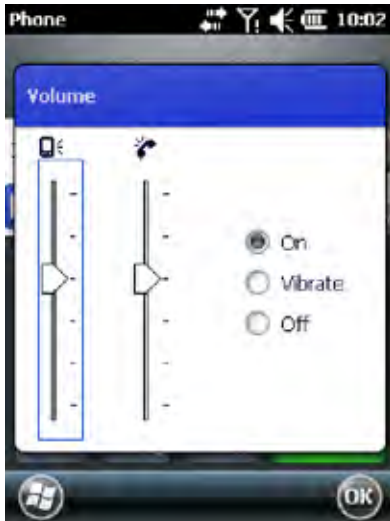

[Figure 2-8. Volume dialogue box]

- 2 Adjust volume moving the slide bar by dragging it.

- 3 Turn on or off the volume by selecting turn-off or turn-on radio button. You can adjust system volume via Sounds and Alarms window or use the up-and-down button located on the side of CW30.



Display of battery level

Battery icon on the Navigation Bar indicates battery power level. If the main battery is lower than the pre-specified level, the corresponding icon displays the level; when battery dialogue box appears, it displays the main battery level.



[Figure 2-9. Battery level dialogue box]

On the Home Screen, the battery icon is always displayed on the Navigation Bar, indicating battery level. The message will be displayed until it is dismissed.



[Figure 2-10. Battery icon on the title bar]

Or you can check battery level by opening the power window.

Resetting CW30

There are two kinds of resets: Soft reset and hard reset. A soft reset will restart CW30 after closing all running programs. A hard reset, also, restarts CW30 along with resetting the clock. The data stored in flash memory or storage card will remain intact.

If CW30 is not working properly, perform a soft reset first. If the problem persists, perform a hard reset.

How to perform a soft reset

Press the reset button at the back of the device (over the battery cover) with a stylus.

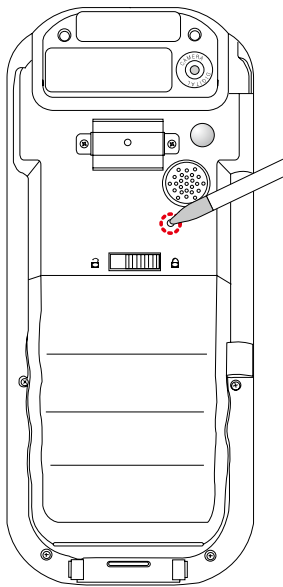

How to perform a hard reset

Quickly press the reset button at the back of the device (over the battery) with a stylus while pressing power button at the front.



Turning on or off backlight

Press power button at the front of the device for a short while.

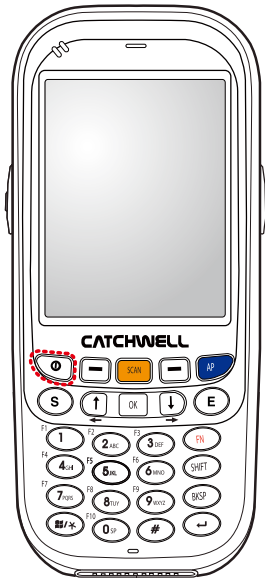

Locking CW30

Prevent unauthorized use of the device by using the device-locking feature. When locked, CW30 will not respond to all input from the screen or keyboard.

To lock CW30, tap Lock icon that looks like a lock beneath the Start.

To unlock CW30, slide the lock button to the left or to the right.



[Figure 2-18. Device-unlock window]

If CW30 is locked with a password, a message asking a password will be prompted.

Locking with a password

This feature protects CW30 from unauthorized access by setting a password in the password window.

Note: if the device is configured to be connected to a network, a user must strengthen network security using complicated (hard to figure out) password. The tools for cracking password are advancing day by day, and the computers being used for cracking passwords are becoming more powerful than ever.

- 1 Go to Start > Setting > Lock > Password tab.

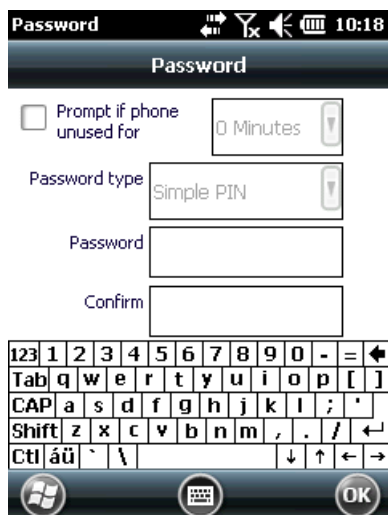

[Figure 2-19. Password window and password tab]

-
- 2 Activate password protection by checking confirm column, if the device is not going to be used for a specified period of time.
-
- 3 Select time value that forces protective function to be activated, if the device is not used for a specific period of time from the drop-down menu.
-
- 4 Password type: Select simple PIN or a complicated combination of English alphabets and numbers.
-
- 5 Simple passwords can be created by entering 4 digit numbers.
How to create a complicated password
- Password: Enter 7 digit numbers to create a complicated password. A complicated password must be composed of more than 7 characters, including at least 3 elements out of uppercase letters, lowercase letters, numbers, and a punctuation mark.
 - Confirm: Reenter the password
-
- 6 Tap Confirm.
-
- 7 If you want to enter a hint to easily recall the password in the future, tap Hint column.
-
- 8 Enter a hint for recalling the password into the text box.
-
- 9 Tap Confirm.

When a user tries to access CW30 after a certain period of unused time, a password screen will be prompted. This window is also prompted when CW30 is connected with a host computer via the cradle or via the communication cable.



Enter the password to unlock the device.

Tap Unlock button to unlock the device and go to the Home Screen or you can go to Contacts window by tapping the Contacts button or go to Message window after unlocking the device by tapping the email button.

Function buttons



Caution

- Emergency phone calls can be made even if CW30 is locked. Refer to the detailed information.

The buttons of CW30 have special functions.

Function buttons

- Power: You can turn on or off CW30 screen by pressing the red power button. When the screen is turned off, CW enters stand-by mode. For further information, refer to How to turn on CW30 in page 7. Or a user can reset CW30 by performing a soft reset or a hard reset. Refer to CW reset in page 16.
- A user may scan barcodes or capture images. Refer to Data Capture in chapter 3. Or a user may open applications or perform specific functions. Refer to user's manual of applications for Microsoft Windows Mobile 6 to open the applications.
- Up/Down: Increase or decrease the volume of CW30.
- Task: A user is able to launch an application or perform a specific function. Refer to user's manual of applications for Microsoft Windows Mobile 6 to launch the application.
- To lock the Windows, press and hold "E" key on the keypad / To unlock it, please refer 2-18. To activate and deactivate the vibrator, press and hold "*".

A user can use a stylus for selecting items and entering information when using CW30. A stylus is for CW30 what a mouse is for a computer.

- Press: Tap the option button on the screen once with the stylus to open menu items.
- Press and hold: If you press and hold on an item, a list displaying available tasks appears. Tap a desired task on the displayed pop-up menu.
- Drag: A user can select text and images by dragging them with the stylus holding on the screen. In order to select several items drag them from a list.



Warning

- When taking notes, you'd better to use the end of the stylus where a spring is installed, and when you tap the screen, it is recommended to use other end of the stylus. Press the power button and tap the keypad with your finger.

Data entry

When you enter data using the keypad, you can use just one hand or use both hands (see figure 2-22).

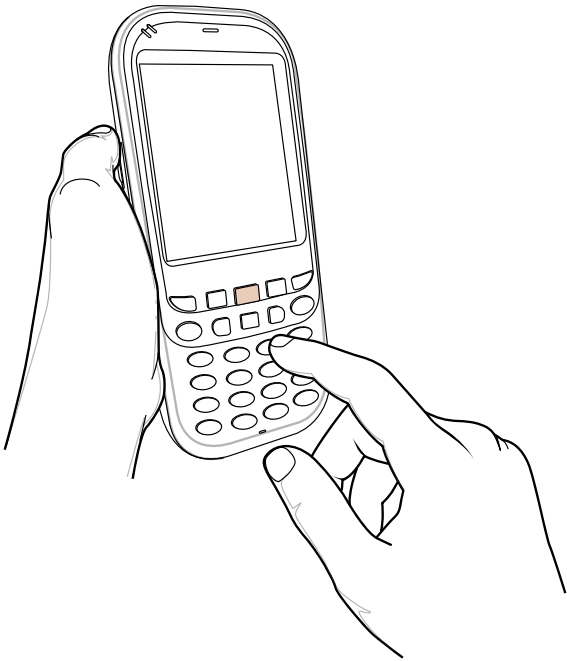

Entering data using one hand

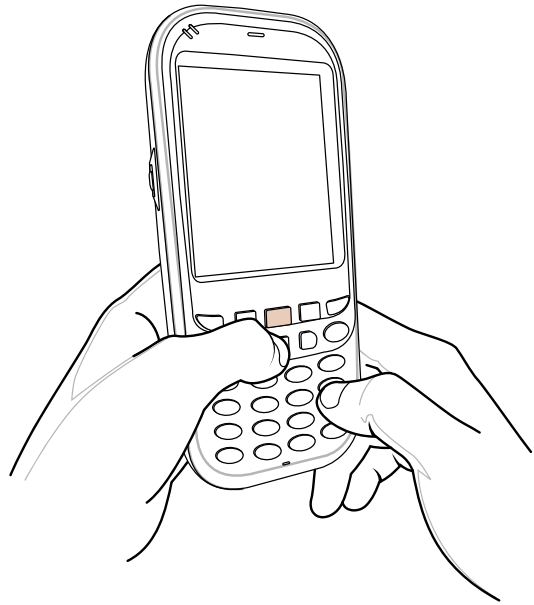

Entering data using both hands

Viewing pictures and videos

How to view pictures and video clips

- 1 Tap Start > Pictures and Videos icon
- 2 Choose pictures or video clips you want to view.

Taking a picture

How to take a picture

- 1 Tap Start > Pictures and Videos icon.
- 2 Choose camera on the navigation bar.
- 3 Check the image in the view finder, and, if necessary, adjust settings.
- 4 To turn on the Autofocus function, press and hold “↑” key for more than two seconds.
- 5 To turn off the Autofocus function, Press and hold “↓” key for more than two seconds.
- 6 Press Enter key to take a picture.

Video recording

How to create video clips

- 1 Tap Start > Pictures and Videos icon
- 2 Tap camera icon on the navigation bar
- 3 Choose Menu > Videos to set the shooting mode to video.
Available recording time will be displayed on the screen.



Caution

- The default video recording time is limited to 30 seconds.

- 4 Start recording by tapping **Enter** key
Stop recording by tapping **Enter** key again

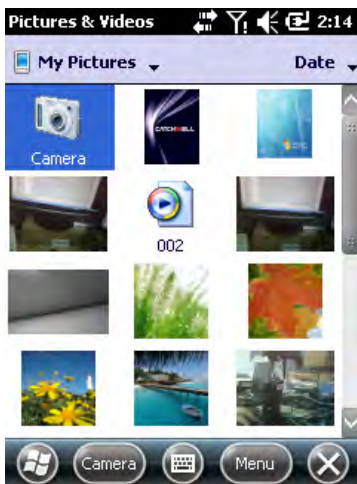

[Pictures & Videos]

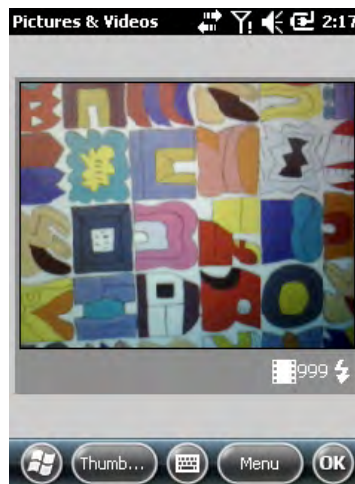

[Taking pictures]



[Video recording]



Chapter 3. Data Capture

Overview	50
Laser scanning.....	50
Things to be considered for scanning..	50
Scanning barcodes	51
Image decoding.....	52
Operation modes.....	52
Image scanning.....	53

3 Data Capture

Overview

CW30 provides two kinds of data capture modes:

- Laser decoding
- Image decoding



- To perform data capture mode, a scanning application must be installed in CW30.

Laser scanning

The barcode scanning features of CW30 are as follows:

- Recognizing various linear barcodes such as Code39, Codel128, or 1-dimension barcodes, etc.
- User-defined setting mode customizable for users' working environments.

Things to be considered for scanning

Generally, scanning is a very simple task composed of leveling, scanning, and decoding. Therefore, a user can be familiar with the process after a few trials. However, the followings should be noted beforehand to optimize the scanning performance:

Distance

- All scanning devices have their optimal recognition range (minimum or maximum distance from a barcode).
- This range may differ in barcode sizes or in the type of scanning devices. If a scanning task is performed within the range, scanning will be fast and reliable, but if the task is performed within too close distance or too far distance, the success rate will decrease.
- When scanning, move CW30 forward and backward in order to find an optimal operation range.

Angle

- Scanning at too tilted angle is more likely to fail in recognition.
- The bigger a barcode is, the greater distance between the barcode and CW30 should be.
- The shorter the distance between barcodes, the closer the use of CW30.

Scanning barcodes

- 1 Check a scanning application is running in CW30.



[[Figure 3-1 1D Laser Scanning]]

- 2 Laser beam comes out of the end of CW30 while the scan button is pressed. The red scan beam should cover the entire barcode. The laser beam indicates that scanning is under way, and if an alarm goes off and the laser is turned off indicates that the barcode was successfully decoded.

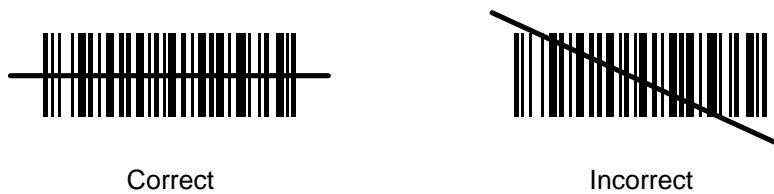

[[Figure 3-2 How to use 1D scanner]]

- 3 Release the scan button.

Image decoding

The features of CW30 to which an image scanner is integrated are as follows:

- Recognizing linear barcodes such as Code39 and Code128, including 2-D barcodes such as PDF417 and QR code.
- Photographing images for various applications
- Intuitive aimer

The image scanner photographs barcodes using digital camera technologies and saves the photographed images, and then extracts data with an optimal decoding algorithm.

Operation modes

The CW30 to which an integrated image scanner is integrated supports 4 operations mode. Each mode can be changed on the barcode setting menu.

- Decode Only: Decodes a barcode. The scanner remains decoding mode while pressing the scan button or until decoding is completed.
- Image Decode: Simultaneously proceeding barcode decoding with barcode-image filming.
- Image Only: Only photographing barcode images.
- Multi-scan Mode: Decoding multiple barcodes quickly and conveniently. New barcodes can be decoded while keeping the scan button pressed.

Image scanning

- 1 Check an application necessary for scanning is running in CW30.

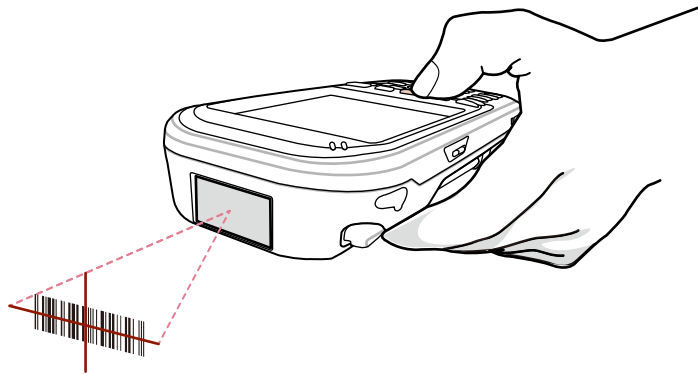

[Figure 3-3 2D Image Scanning]

- 2 Pressing the scanning button turns on the aiming pattern helping to level at a target. Move the aiming pattern to the center of a barcode area. The red laser beams indicates that scanning is under way, and an alarm goes off, meaning that decoding of the barcode was successful.



- 3 Release the scan button.

Chapter 4. Using the phone

Overview	55	Creating a memo.....	62
Using the phone application.....	55	How to check the memo created during a call.....	63
Turning on or off the phone.....	55	Using Speed Dial	63
Audio mode	56	How to add an item to Speed Dial.....	64
Using wired headsets.....	56	Editing or Deleting Speed Dial shortcut	65
Using Bluetooth headsets	56	Using Call History.....	66
Adjusting audio volume	57	Managing Call History.....	66
Making a phone call	57	Modifying Call History View	66
Using the Phone Dialer	58	Resetting the recent call counter.....	67
Using Contacts.....	58	Deleting all Call History	68
Using Call History.....	59	Viewing call details.....	69
Making emergency calls.....	59	Using Call History menu.....	70
Answering Calls	60	Switching calls on CW30.....	70
Handling incoming calls	60	Text message	71
Smart Dialing.....	60	Viewing text messages	71
To search for phone numbers	61	Sending text messages.....	72
How to find contacts.....	61		
To mute the microphone during a call.....	62		
How to mute or unmute the microphone during a call.....	62		

4 Using the phone

Overview

Using CW30, a user can make a call, save contacts, manage phone call records, send text messages, save received messages, etc. In addition, a user can browse the web via a dial-up network to send data in real time using various office applications.

Using the phone application

Regardless of running programs, a user can use the phone application anytime he wants.



In order to use the phone application, choose Start > Phone or just tap the green button on the keypad of CW30.

Turning on or off the phone

The phone can be activated or deactivated via the Wireless Manager in a Windows Mobile 6.5 device. Wireless can be launched by choosing Start > Settings > Connections.



Choose the Wireless Manager. Turn on or off a device by selecting its name. To configure connection settings tap Menu > the settings of each device.

Audio mode

You can select one of three audio modes of CW30 when making a phone call.

- Handset mode: You can use a speaker at the front side of CW30. This is the default mode.
- Speaker mode: a user can use this mode like a speaker phone.
- Headset mode: a user can connect a headset to CW30 or use a Bluetooth headset for making a call.

The default mode is handset mode. A user can listen to audio media via a headset or a Bluetooth headset by connecting them to CW30.



[Handset mode]



[Speaker mode]

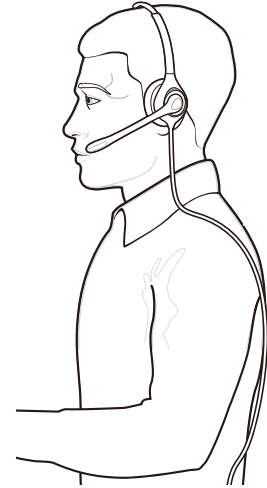

[Headset mode]

Using wired headsets

Headsets can be used for audio applications. CW30 Connect a headset to the earphone jack located on the side of CW30. Adjust volume appropriately before connecting the headset. When connected, sound doesn't come out of the speaker any more.

Using Bluetooth headsets

A Bluetooth headset can be used for audio applications for audio communication. Bluetooth Refer to chapter 6 – Using Bluetooth—to find out how to connect headsets to CW3. Adjust volume appropriately before turning on the headset. When connected, sound doesn't come out of the speaker any longer.

When making a phone call, the use of Bluetooth hand-free profile is recommended instead of using Headset profile. For more details, refer to chapter 6 – Using Bluetooth.

Adjusting audio volume

Adjust ring volume by pressing volume control settings or volume button located on the top, and adjust audio volume while making a phone call.

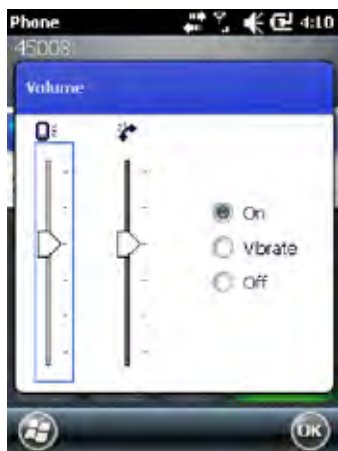

To adjust volume, tap speaker icon that comes up after tapping the title bar. Adjust volume by moving the slide up and down.

Making a phone call



Caution

- Making an emergency call is possible even if the SIM card is not installed. Refer to page 7 for more details.

A user can make a call via voice call, contacts, call list, and text message box on CW30.

Using the Phone Dialer

Making a phone call using the phone program

- 1 Choose Tap Start > Phone or Tap the green Talk key on the keypad of CW30.
- 2 Tap a number that you wish to call from the Phone program.
- 3 Press Send or the green Talk key on the keypad of CW30.
- 4 To stop an outbound call or terminate a call, press End or tap the red End key on CW30 keypad.



- When wrong keys are pressed, erase the numbers by tapping Delete key (⌫) one by one.

Using Contacts

A user can make a call using Contacts

How to make a call from the Contacts screen.

- 1 Tap Start > Contacts
- 2 Select a contact and press and hold on it for a short while in the contacts list.



- 3 Choose Call Work or Call Home or Call Mobile.

Using Call History

How to make a call using Call History

1 Tap Start > Phone or Tap the green Talk key on CW30 keypad.

2 Tap a Call History on the Phone keypad.

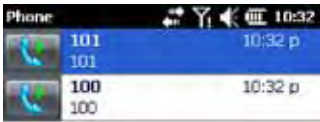

3 Start voice call by tapping the phone icon next to the number.

4 To make a call or terminate a call, tap End or tap the red End Call key on CW30 keypad.

Making emergency calls

You can use an emergency call even if the SIM card is not installed. For more details on the installation of the SIM card, refer to SIM Card Installation on page 3.



Caution

- Emergency calls can be unavailable depending on network environments.

Answering Calls

When you have an incoming call, a pop-up window will appear. If a bell sound is set, the phone will ring.

To answer the call, tap Phone > Receive or tap the green Talk key on CW30 keypad.

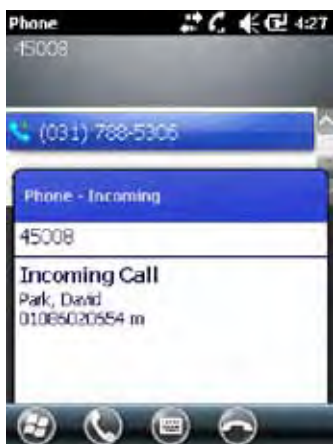

To ignore the incoming call, press Ignore. Then the service provider you are using will notify the caller that you are unable to answer the call.

To end the call, tap End Call or tap the red END on CW30 keypad.

Handling incoming calls

- To answer an incoming call when you are already on a call, tap Stand-by key to switch to stand-by mode.
- You can use other programs of CW30 while you are on a call. If you want to switch to Phone screen, tap Talk or Start > Phone. To end the call, tap End Call.
- You can add the number you are on a call or a number on the Call History to Contacts by tapping Menu > Contact > Save.
- To answer another incoming call while you are talking on the phone, tap Answer or Send after disconnecting the current call by tapping End on Phone keypad and tap Answer or Send key.
- To answer a stand-by call during a call, answer the call after tapping Answer or Send to switch the current call to stand-by mode.

Smart Dialing

When you start to enter numbers or letters, the device automatically shows you filtered list of contacts and phone numbers after searching for the contact items and the numbers from call history. Then you can choose a contact from the filtered list.

Tap a phone number to make a call. At this point, a contact matching the entered number will be displayed on the contacts panel.

To search for phone numbers

- You can search for phone numbers by entering on or two numbers at the beginning.
- By entering more than three numbers at the beginning, you can search for saved contacts and phone numbers from SIM card.

How to find contacts

- Enter the first letter of the name in contacts.
- If there are many matching items, you can narrow your search by adding extra letters.



How to make a call or send a text message using Smart Dialing.

- 1 Enter numbers or letters at the beginning.
- 2 Search for contacts or numbers that you wish to find from the Smart Dialing panel.
- 3 When you choose a contact, tap Talk to make a call.
- 4 If you want to send a text message after selecting a contact, tap Menu > Text Message.
- 5 You can select other phone numbers of that contact by tapping the name in the contact after selecting it.

To mute the microphone during a call

If you mute the microphone during a call, you can hear the voice of the other, but the other can't hear your voice.

How to mute or unmute the microphone during a call

- 1 Tap Start > Phone or tap the green Talk key on CW30 keypad.
- 2 Make a call.
- 3 Tap Mute on the screen to mute the audio. The mute icon will appear on the screen.



Creating a memo

To create a memo during a call, tap Menu button on the screen, then select Create Memo.

How to check the memo created during a call

- 1 Tap Start > Phone or tap the green Talk key on CW30 keypad.
- 2 Tap Call History on the Phone keypad.
- 3 Press and hold on a call record including a memo or the memo icon.

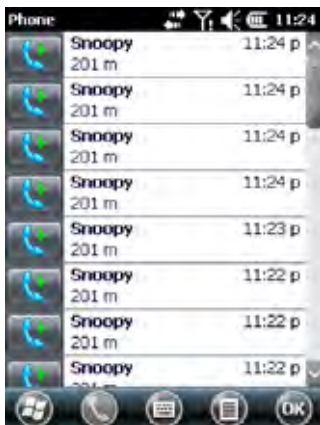

- 4 Tap View Memo.

- 5 Tap OK to end.



Caution

- You can check the Memo program directly by choosing Start > Memo.

Using Speed Dial

You can make a call with a single tap by creating a speed dial entry. After assigning a number to Contacts, you can add the number to the Speed Dial.

How to add an item to Speed Dial

How to add a number to Speed Dial on the Phone keypad

1 Check if there are contacts and numbers that you wish to add to the Speed Dial in the Call History.

2 Tap Start > Phone or tap the green Talk key on CW30.

3 Tap Speed Dial > Menu > New.

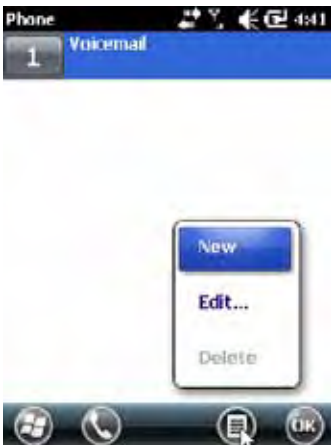

4 Select an item you wish to add to Speed Dial from the Contacts list.



5 Select a new Speed Dial number from the Location column. The first number of the Speed Dial is reserved for voice mail.

-
- 6 Tap OK to add the contact to Speed Dial list.



Editing or Deleting Speed Dial shortcut

-
- 1 Tap Start > Phone or tap the green Talk key on CW30.

-
- 2 Tap Speed Dial button.

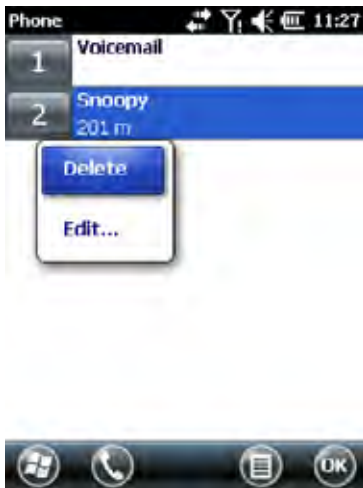



-
- 3 Press Edit... or an item to be deleted for a short while.

-
- 4 Tap Edit... or Delete.

Using Call History

You can check recent calls or make a call to the numbers using Call History. In Call History, the duration of all received, sent, missed calls and talk time are displayed. The icons displayed in the Call History screen are listed in Table 4-1.

아이콘	설명
	This icon is displayed next to the contact information on all incoming calls.
	This icon is displayed next to the contact information on all missed calls.
	This icon is displayed next to the contact information on all outgoing calls.

Managing Call History

You can manage your call history such as resetting talk time and deleting call history.

Modifying Call History View

- 1 Tap Start > Phone or tap the green Talk key on CW30 to display the phone keypad.
- 2 Tap Call History button on the phone keypad.
- 3 Tap Menu > Filter to display the menu.

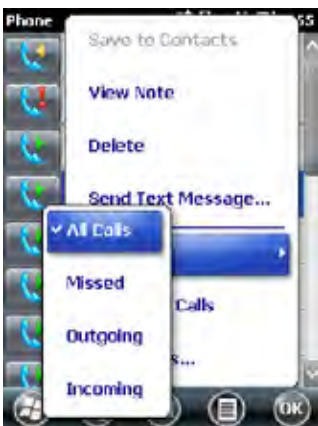

- 4 You can only display missed, outgoing, and incoming calls on the menu.

Resetting the recent call counter

1 Tap Start > Phone or tap the green Talk key on CW30 keypad.

2 Tap Call History on the phone keypad.

3 Tap Menu.

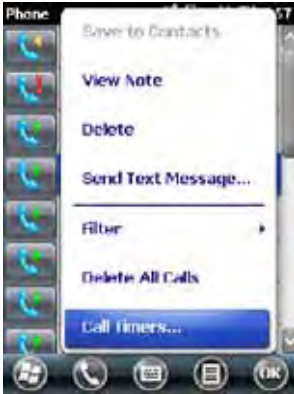

4 Choose Call Timers.



5 Tap Reset (Not counters of all calls are initialized).

Deleting all Call History

1 Tap Start > Phone or tap the green Talk key on CW30 keypad.

2 Tap Call History on the phone keypad.

3 Tap Menu icon.



4 Choose Delete All Calls.

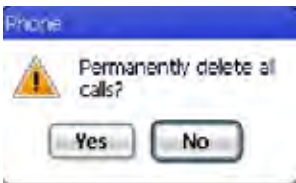

5 Tap OK.

Viewing call details

1 Tap Start > Phone or tap the green Talk key on CW30 keypad.

2 Tap Call History on the phone keypad.

3 Choosing an item will lead you to the call details screen.

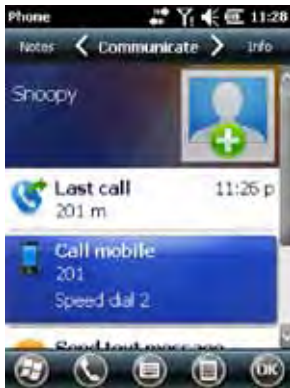

Caution

- If more than two calls are in progress, only the first one will be recorded.

Using Call History menu

You can send voicemails, save contacts, delete history, and voice calls using Call History menu.

1 Tap Start > Phone or tap the green Talk key on CW30.

2 Tap Call History on the phone keypad.

3 Press and hold on the desired item in the list for a while.

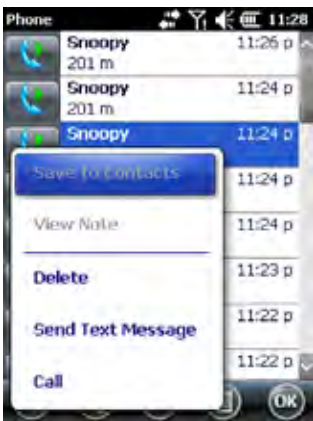

4 Choose an item on the menu.

Switching calls on CW30

How to switch calls between two calls:

1 Tap Start > Phone or tap the green Talk key on CW30 keypad.

2 When the first call is connected, Stand-by button will be displayed on the keypad.

3 Tap the Stand-by button to switch the first call to stand-by mode.

4 Proceed with the second call.

5 After being connected to the second call, a switching button will be displayed on the keypad.

6 To end each call, tap End on the phone keypad or tap the red End Talk key on CW30 keypad.

Text message

You can send or receive text messages using Text Message features.

Viewing text messages

How to view text messages

Regardless of using voice call, you can check your text messages. You will be notified by New Text Message Notification window when you have a new text message.

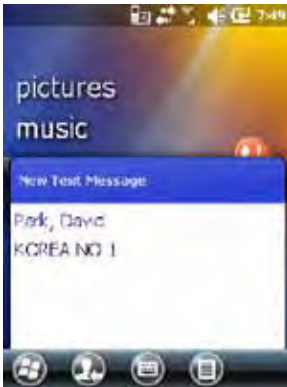

[Notification of new text message]

On the new text message screen, you can make a call, save or read or delete messages. If you are subscribed to Caller's Number Identification Service, you can identify the caller by comparing the number with the information saved on Contacts.

Even if the phone is disabled, you can still read received text messages.

1 Tab Start > Text Message.



2 Text Message window will appear.

3 Tap a text message in the message list.



- When the phone is turned off, you have to turn it on to make a call or to send a new message.

Sending text messages

How to create a new text message

1 Tap Start > Text Message

2 Tap Create New Text Message.

- You can check the size of the message you are writing via character counter.
- If you want to know whether the receiver has received your message, choose Message Transmission Check Request after tapping Menu > Message Option.



3 You can enter the receiver's number into the receiver's number column or enter the number by searching for the number from Contacts after tapping Menu > Add Receivers...

4 Enter a message into the message area.

5 When completed, tap Send button.

When the phone is turned on, a message notifying you to turn on the phone will be prompted. You can turn on the phone to send a message or save a message at the temporary folder by tapping OK. The message saved at the temporary folder will be sent when you turn on the phone.

If you are out of the communication service area, a message will be saved at Temporary message box and be sent when you are back to the service area.



Caution

- As the message saved at temporary message box remains there, you have to send the message manually when you are back to the service area (necessary to check the relevant features).



Chapter 5. Using a GPS Navigation

Overview	75
Installing a software	75
Setting up GPS on CW30	75
Operation	76
GPS maps on a microSD card.....	76
Answering calls while using GPS.....	76
When you lose GPS signals in a car.....	77
Auxiliary GPS	77

5 Using a GPS Navigation

Overview

CW30 adopted a GPS (Global Positioning System) technology using SiRF III chipset. GPS technology is based on GPS satellites that transmit digital wireless signals constantly orbiting the Earth. Those wireless signals contain precise time data, and this signal is used for identifying the location of a user.



- The user is responsible for the safe use of CW30 in a car by correctly fixing it on a safe place free from blocking vision or causing accidents, injuries, or damages. A driver must drive safely, attending to all traffics, and take special care not to risk safe driving by using this device. To use this device while driving is dangerous.

Installing a software

A GPS navigation software released by a third party is necessary, and several evaluation copies of such software are available from various manufacturers. For instance, to use VisualGPS, please visit <http://www.visualgps.net/VisualGPSce/>.

If you want to purchase a GPS navigation software, please ask the GPS manufacturer that the software you are going to buy is compatible with CW30 before purchasing or downloading or installation.

For the installation and configuration of applications, please refer to the user's manual for the relevant application.

Setting up GPS on CW30

The basic features of CW30 are as follows:

- 1 Choose Start > Settings > System > External GPS.
- 2 Set GPS program port to COM4 from the program tab.
- 3 Set GPS program port to COM9 from the hardware tab.
- 4 Set baud rate to 9600 from the hardware tab.

Several programs can access GPS data simultaneously. Each program must access GPS data using Microsoft GPS API or COM8.

Operation

Though there is a default setting, it is subject to change.

It may take from a few seconds to several minutes before receiving satellite signals. The outdoor location where there are no obstacles blocking the sky is ideal. If such a location is not available, it may take longer time to receive the signals or CW30 may be unable to calculate the initial position quickly. In case of indoor use, the access to GPS signals may be restricted or impossible.



Caution

- When you using a GPS navigation program, make sure CW30 is not switched to temporary pause mode. If CW30 is in temporary pause mode, power to the GPS module will be cut off. To continue to use GPS, the GPS receiver has to search for effective GPS signals again; as a result, the retrieval of location information will be delayed.

GPS maps on a microSD card

There are GPS navigation software vendors who are selling GPS maps on microSD cards. In case of using microSD for navigation software:

- 1 Remove the battery from CW30.
- 2 Push up the SD card slot located inside the battery compartment at the back of PDA to the right.
- 3 Insert the SD card into the slot.
- 4 Push the slot where SD card is inserted to the left by pulling it down.

Answering calls while using GPS

When there is an incoming call while using a GPS navigation program:

- 1 Tap Answer button to receive the call.
- 2 After finishing the call, tap Talk End button to restart the audio of GPS software.



Caution

- When receiving incoming calls while using GPS on CW30, the GPS navigation software will be muted until the call is finished

When you lose GPS signals in a car

If the window of your car is heating-wired, it may affect the GPS performance of CW30 by blocking the GPS signals. To strengthen GPS signals, install CW30 to the place exposed to the sky without any obstacles.

For a quick reception of the GPS signal, CW30 requires a clear view of the sky

Auxiliary GPS

If there is no internal GPS in the device, a user may use a Bluetooth GPS. For the details on how to set up a Bluetooth device, refer to chapter 6 – Bluetooth.

For how to use them, see the user's manuals released by each vendor.

Chapter 6. Using Bluetooth

Overview	79
AFH (Adaptive Frequency Hopping) ...	79
Security	80
Composition of Bluetooth.....	80
The ports supported by Microsoft	
Bluetooth Stack.....	81
Hard reset	81
Soft reset.....	81
Pause.....	81
Restart	81
Power states of Bluetooth	81
Using Microsoft Bluetooth Stack	81
Turning on or off the Bluetooth	
Wireless mode	82
Bluetooth activation.....	82
Bluetooth deactivation.....	83
Searching for Bluetooth devices	83
Available Services.....	86
Serial Port Services	87
ActiveSync using serial port services....	89
A2DP/ AVRCP Services.....	90

6 Using Bluetooth

Overview

A device equipped with Bluetooth technology can send and receive data within the frequency range (802.15.1) of 2.4GHz ISM (Industry Scientific and Medical) by communicating wirelessly with radio frequency in FHSS (frequency-hopping spread spectrum). Bluetooth wireless technology is, in particular, designed for short-range communication (10 m / 30 ft) and low-power consumption.

CW30, equipped with Bluetooth technology, is able to exchange information (e.g. files, appointments, tasks) with other Bluetooth-support devices such as phones, printers, access points, or other mobile computers. To use CW30 as a modem, you can establish a dial-up modem connection between a computer and CW30.

AFH (Adaptive Frequency Hopping)

AFH (Adaptive Frequency Hopping), a way of avoiding fixed frequency interference, can be applied to Bluetooth voice. In order for AFH to operate correctly, all devices of piconet (Bluetooth network) must support AFH. When searching and connecting to devices, AFH is not used. Refrain from using Bluetooth pairing or search when an important 802.11b communication is underway. The AFH for Bluetooth consists of four major components:

- It is a way of detecting interference according to the pre-defined channel masks or standards of each channel.
- Link management– It distributes adjusted AFH information over the rest of Bluetooth network
- Modification of hopping order– It prevents interference by selectively reducing the number of hopping channels.
- Channel maintenance –It is a way of re-evaluating channels periodically.

When AFH is activated, Bluetooth communication hops to near high-speed 802.11b channels instead of passing through them.

Bluetooth wireless connection of CW30 is working at Class 2 device power level. The maximum output power is 2.5 mW and the estimated distance is 10 m (32.8 ft). The distance depending on power levels may differ in the measured environments such as open space or closed office space, etc. Therefore, it is difficult to define the right distance due to the differences in power and devices.

Security

In the current Bluetooth specifications, the security level is defined to the level of link and the security level of applications is not defined. Therefore, application developers may define security mechanisms to meet specific requirements. The security at the level of applications is implemented per each user, whereas the security at the level of link is implemented between devices. The Bluetooth specifications define security algorithms and procedures necessary to certificate devices and, if necessary, to encrypt the data flow of link between devices. The certification of devices is a fundamental feature of Bluetooth; however, the encryption of link is selective.

The synchronization between Bluetooth devices are performed by generating initialization keys used for link keys required for certifying devices. Basically, a Bluetooth stack responds without a key when a key is requested (the response to the key-requesting event is the user's role). The certification of Bluetooth devices are based on attempt-response transactions. In Bluetooth technology, other PIN numbers or passwords used for generating 128 bit keys for security and encryption can be re-used. Encrypted keys are extracted from the link keys used for certifying synchronized devices. Also, the constraints in distance and high-speed frequency hopping of Bluetooth wireless technology make eavesdropping difficult.

Recommendations are as follows:

- Synchronization should be conducted under secured environments.
- Do not save PIN code at industrial PDA. Store it somewhere else personally.
- Implement a security at the level of applications.

Microsoft stack supports smart synchronization. For the details, see Microsoft MSDN.

Composition of Bluetooth

In principle, CW30 is configured to use Microsoft Bluetooth stack.

The available services via Microsoft Bluetooth stack is listed in Table 6-1.

Microsoft Bluetooth Stack
OBEX Object Push Services
Hands-Free Audio Gateway Services
Serial Port Services
Personal Area Networking Services
PBAP Services
Dial-Up Networking Services
HID Client Services
A2DP/AVRCP Services

[Table 6-1. Bluetooth services]

The ports supported by Microsoft Bluetooth Stack

COM5
COM9

For more details on ports, contact Technical Support Team at Catchwell.

Power states of Bluetooth

Hard reset

Using Microsoft Bluetooth Stack

If you perform a hard reset, the Bluetooth wireless condition before hard reset remains.

Soft reset

Using Microsoft Bluetooth Stack

If you perform a soft reset, the Bluetooth wireless condition before hard reset remains.

Pause

If there is an active Bluetooth pairing, the Bluetooth wireless connection enters low-power consumption mode to maintain the active pairing. If there is no active pairing, the Bluetooth wireless connection will be disconnected.

Using Microsoft Bluetooth Stack



Caution

- Under the condition that the Bluetooth pairing between CW30 and other Bluetooth device is active, if there is no data exchange between the devices, CW30 will be timed out. However, once the power button of CW30 is pressed, CW30 will be temporarily suspended (except for the case of making a call), and CW30 will be awake from the suspend mode right after receiving data from the Bluetooth device. For example, if redialing is made from a headset, the suspension will be disengaged.

Restart

If Bluetooth was on before temporary suspension, it will be powered on when CW30 restarts.

In the next chapter, how to use Microsoft Bluetooth Stack will be explained.

Turning on or off the Bluetooth Wireless mode

Turn off Bluetooth wireless connection to save battery or when you enter an area where wireless connection is restricted (e.g. aircraft). When wireless connection is turned off, no other Bluetooth devices can detect or connect to CW30. To exchange information with other Bluetooth devices within the operation range, turn on the Bluetooth wireless connection. The communication using Bluetooth wireless connection is only available within the close distance.



- Turn off wireless connection when not in use to extend battery life.

Bluetooth activation

How to activate Bluetooth

- 1 Tab Bluetooth bar after tapping Wireless Manager or tap Start > Settings > Connection > Bluetooth icon.

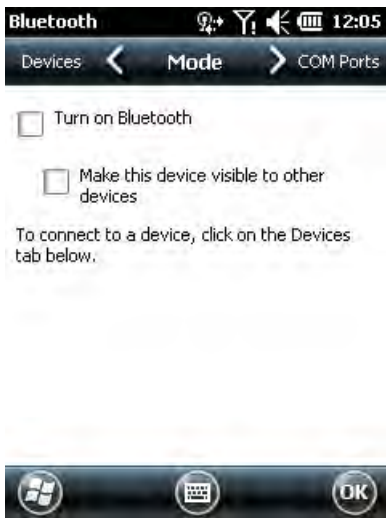

[Figure 6-1. Bluetooth mode tab]

- 2 Select Turn on Bluetooth.

- 3 Tap OK.

Bluetooth deactivation

How to deactivate Bluetooth

- 1 Tab Bluetooth bar after tapping Wireless Manager or tap Start > Settings > Connection > Bluetooth icon.
- 2 Deselect Turn on Bluetooth
- 3 Tap OK.

Searching for Bluetooth devices

CW30 can receive information from a detected device without connecting to it. But, when connected, the device connected to CW30 will automatically exchange data with CW30 if Bluetooth wireless connection is activated.

How to find a Bluetooth device within the range

- 1 Activate Bluetooth on both devices.
- 2 Set the Bluetooth devices to detection and connection-enabled mode.
- 3 Check the distance between the devices is within 10 m (30 ft).
- 4 Choose Start > Settings > Connection > Bluetooth > Device.



[Figure 6-2 Bluetooth device tab]

5 Tab Add New Device. Then CW30 will begin to search for a new Bluetooth device within the range.



[Figure 6-3. Searching for a Bluetooth device]

6 Choose a device from the list.



[Figure 6-4 Selecting a Bluetooth device]

7 Tap Next. A password input screen will appear.



- If smart synchronization is pre-configured or pre-defined PIN is requested, the password input screen will not appear.

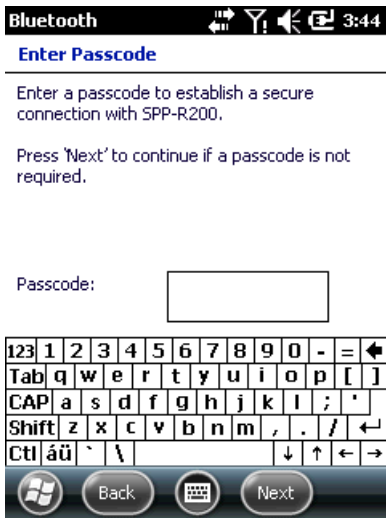

[Figure 6-5. Entering a password]

-
- 8 Enter a password of other device. Then the device will be added to Bluetooth device list.



[Figure 6-6. Bluetooth paring set-up]

A message requesting a password will appear. If there is a specific password for the device, enter the password to the Password column and tap Next. If there is no password for the device, enter an arbitrary password and tap Next. Bluetooth will attempts to establish a partnership with the device.

-
- 9 If there is a pre-defined password, the same message will appear in the other device requesting the password. Enter the password to configure the synchronized connection (if the password of the device is entered, there is no other tasks to perform on other device).

-
- 10 When connected, a list of appropriate and supporting services will appear.

11 Choose the service you want and tap OK. If you don't select the service, it will not be synchronized even if the device is synchronized. If you don't choose a service, a message that keeps asking you to enter a password will appear.

12 The device will appear in the list of the main panel. When the both devices accept their passwords, a reliable (synchronized) partnership is established.

Available Services



Caution

- Some devices may not require PIN depending on the certification of devices.

For the information on available services, refer to the next paragraph.



Caution

- The partnership with a Bluetooth headset is different from each headset, and the device only remembers the last connected headset. If a problem occurs while making a connection to a headset, switch the headset to detection mode. For more details, refer to user's manual of the headset. Only WAN audio will be transmitted to a headset. System audio will keep being transmitted to CW30 speaker. You can answer or make a call using a hands-free profile.

1 Activate Bluetooth in both devices and turn on detection mode.

2 Check the distance between the devices is within 10 m (30 ft).

3 Tap Start > Settings > Connections > Bluetooth icon.

4 Tap New Device. CW30 will begin to search for a Bluetooth device within the range.

5 Enter the name of the headset, and tap Next. A password window will appear.

6 Enter a password for the headset.

7 Tap Next. CW30 will be connected to the headset. For the instructions on the communications with Bluetooth devices, refer to the user's manual of the headset.

Serial Port Services

Wireless Bluetooth uses serial port connection as well as the wired serial cable connection. It configures applications that will be used for connections to correct serial ports.

How to connect to serial ports

1 Activate Bluetooth on both devices and turn on detection mode.

2 Check the distance between two devices is within 10 m (30 ft).

3 Go to Start > Settings > Connections > Bluetooth > Device tab.

4 Tap Add New Devices. CW30 will start to search for a detectable Bluetooth device within the range.

5 Select a device from the list.

6 Tap Next. A screen asking a password will appear.



Caution

- If smart synchronization is pre-configured and a pre-defined PIN is being requested, no screen asking a password will appear.

7 Enter a password and tap Next. The device will be added to the Bluetooth list.

8 Tap a serial device from the device list. Connection settings screen will appear.

9 Select the serial port confirmation column.

10 Tap Save.

11 Tap COM ports tab.



12 Tap New Outgoing Port. Add a Device screen will appear.

13 Select the serial device and tap Next.



14 Select a COM port from the drop-down menu.



15 Tap Finish.



- This process alone will not create a partnership. To make a partnership again, the application must run Microsoft Bluetooth Stack by opening the selected COM port.

ActiveSync using serial port services

As is the case with a wired serial cable connection, ActiveSync also uses a wireless Bluetooth serial port connection. Therefore, an application required for connecting to the correct serial port must be configured.

How to configure Bluetooth ActiveSync

Configure Bluetooth features of the device prior to establish a Bluetooth ActiveSync connection.



- In order to strengthen security, the network bridge (especially Remote NDIS adapter Connection Bridge) of a computer must be deactivated before connecting the device to a computer passing through the Internet or other networks. For further information on the network bridge, see Windows online help of the computer.

The following instructions correspond to the computers running Windows XP higher than SP2.

- 1 Activate Bluetooth on both devices and turn on detection mode. Check the distance between two devices is within 10 m (30 ft).
- 2 Double click Start > Settings > Configuration Panel > Bluetooth device.
- 3 Check Search for a Bluetooth Device checkbox on Option tab and Allow a New Bluetooth Device to Connect to This Computer checkbox.
- 4 Choose Receive (start connection from the device) options after clicking Add on COM port tab and click OK. Click OK after checking the added COM port.
- 5 Click Start > ActiveSync.
- 6 Click File > Connection Settings
- 7 Allow one connection out of the followings: Press Start > ActiveSync after selecting a COM port whose number was checked in the previous step from the drop-down menu.
- 8 Choose a connection via Menu > Bluetooth. Synchronization will automatically initiate and ActiveSync icon will appear at the bottom of the right corner on the Home Screen. If certification is required, a password window will appear, then enter a password (PIN code) and press Enter and repeat this procedure on the other device. The use of password is recommended for enhanced security and the digit of a password should be between 1 to 16 characters combined with English letters and numbers. If you are not going to use a password, just click Next.
- 9 To disengage the ActiveSync connection, select ActiveSync icon on the Home Screen and click Disconnect.

A2DP/ AVRCP Services

A2DP/ AVRCP are used for connecting to high-quality stereo headsets.

- 1 Activate Bluetooth on the both device and set the Bluetooth device into detection and connection mode.
- 2 Check the distance between two devices is within 10 m (30 ft).
- 3 Tap Add a Device after selecting Start > Settings > Connections > Bluetooth. CW30 will start to search for a new Bluetooth device within the range.
- 4 Select the stereo headset from the list and tap Next. A screen asking a password will appear. For further information, refer to user's manual of the device.
 - If smart synchronization is pre-configured and a pre-defined PIN is requested, the password screen will not appear.
- 5 Tapping Connection will pair CW30 with the stereo headset.



Caution

The stereo headset applicable to hands-free service will be connected to the hands-free service after being connected to A3DP service.

- 1 Tap Add a Device after choosing Start > Settings > Connections > Bluetooth. CW30 will begin to search for a new Bluetooth device within range.
- 2 Select the stereo headset in the list. Tapping Next will take you to a password window. For more details, refer to the user's manual of the device.
 - If smart synchronization is pre-configured and a pre-defined PIN is requested, that password screen will not appear.
- 3 Tap Connection. CW30 will be paired with the stereo headset.



Caution



Chapter 7. Maintenance and Troubleshooting

Maintenance.....	92
Safety instructions on battery.....	92
Cleaning.....	93
Screen.....	93
Scanner window.....	93
Connectors.....	93
Cradle	94

7 Maintenance and Troubleshooting

This chapter will provide troubleshooting guidelines including instructions on the cleaning and storage of CW30.

Maintenance

Please follow the below instructions for trouble-free use of the device.

- Take special care to protect the screen of CW30 from being scratched. Only use a plastic pen designed for touch screen or the provided stylus. Never use other pens or pencils or other sharp object for the screen.
- The use of protective film is recommended (a sheet of film is included in the box).
- The advantages of using the protective film
 - Protecting the screen from scratches or grooves.
 - More realistic feeling in writing and touching
 - Protecting the screen from damage caused by abrasion and foreign materials.
 - Extending the lifespan of the touch screen.
- The screen of CW30 is made of glass. Do not drop CW30 or apply excessive shock to it.
- Protect CW30 from drastic temperature change.
- When temperature is high, do not keep it on the dashboard of a car and keep it away from heat sources.
- Do not use or store CW30 at dirty, humid, or wet places.
- Use a soft lens-cleaning cloth for cleaning CW30. If the surface of CW30 screen gets dirty, clean it with a diluted detergent.
- To maximize battery life and performance, replace the rechargeable battery periodically. The lifespan of battery may differ in every user depending on how he or she uses it.

Safety instructions on battery

- No debris, combustibles, chemicals are allowed near the battery on charging. Special caution is required in case of charging the battery under non-commercial environments.
- Use the battery in accordance with the instructions on how to use, store, and recharge in this manual.
- The use of improper battery may lead to fire and explosion. The charging temperature of the battery for mobile devices ranges from 0°C to 40°C (32°F ~ 104°F).
- Do not use incompatible batteries or chargers. The use of incompatible batteries or chargers may result the risks such as fire, explosion, leakage, etc. If you have any question on battery or charger, contact Catchwell.
- Do not attempt to disassemble, open, bend, modify, puncture, or smash the product or the battery.
- If you drop the device in which the battery installed on the solid surface hard, the battery may be overheated.
- Special attention must be paid to avoid short circuit, contacting a metal conductor to the battery terminals.
- Special attention must be paid to avoid modification, restoration, inserting foreign materials into the battery, exposing the battery to water or other liquids, fire, explosion, and other risks.
- Children's handling of the battery should be supervised by parents.
- The used battery must be disposed of immediately as stipulated by the local regulations.
- Do not dispose of the battery in fire.
- In case of swallowing of the battery, consult the doctor immediately.
- If the battery leaks, be careful not to allow skin or eyes to be in contact with the leaking fluid, and if skin or eyes are already in contact, rinse with a large amount of water and seek medical advice.
- If a trouble suspicious of the damage of the device or the battery occurs, contact Catchwell for check.

Cleaning

Cleaning the exterior of the device

Use only computer-cleaning detergents or dedicated cleaners.

Screen

Use only computer-cleaning detergents or dedicated cleaners. Be careful not to allow liquid to pervade into the gaps at the corner of screen. To avoid any scratch, wipe it off with a non-abrasive dry cloth.

Scanner window

Clean it regularly with a lens cleaner.

Connectors

-
- 1 Remove the battery.

 - 2 Soak the end of a swap in isopropyl alcohol and rub connector pins with it.

 - 3 Be careful not to leave any fluff at the surface of connectors.

 - 4 Repeat this process about three times.

If isopropyl alcohol is not available, clean the connector pins with computer-cleaning detergent or a pencil eraser, and be careful not to leave any foreign materials at the surface of the pins.

Cradle

- 1 Remove the power cable from the cradle.
- 2 Soak the end of a swap in isopropyl alcohol and rub connector pins.
- 3 Be careful not to leave fluff at the surface of connectors.
- 4 Rub the connectors carefully, so that both sides of the connectors are surely cleaned; repeat this three times.
- 5 Remove the foreign materials inside the cradle with compressed air, etc.
- 6 Clean the exterior of the cradle with computer-cleaning detergents, etc.

As the level of contamination may vary depending on users' operation environments, clean the device regularly.

FCC compliance information

This device complies with Part 15 of FCC Rules. Operation is subject to the following two conditions:

- (1) This device may not cause harmful interference, and
- (2) This device must accept any interference received.

Including interference that may cause undesired operation.

Information to User

(a) For a Class A digital device or peripheral, the instructions furnished the user shall include the following or similar statement, placed in a prominent location in the text of the manual:NOTE: This equipment has been tested and found to comply with the limits for a Class A digital device, pursuant to Part 15 of the FCC Rules.

These limits are designed to provide reasonable protection against harmful interference when the equipment is operated in a commercial environment.

This equipment generates, uses, and can radiate radio frequency energy and, if not installed and used in accordance with the instruction manual, may cause harmful interference to radio communications.

Operation of this equipment in a residential area is likely to cause harmful interference

in which case the user will be required to correct the interference at his own expense.



CAUTION: The user who makes changes or modifications to the unit without the express approval by the manufacturer will void user authority to operate the equipment.

LIMITED WARRANTY

CATCHWELL, Inc. ("CATCHWELL") warrants to the original end user purchaser ("You") that for the Warranty Period listed below, the Product (excluding any third party software) will be free of defects in materials and workmanship under normal use.

You must have proof of purchase before returning defective products to CATCHWELL. Returned products must be shipped prepaid and packaged appropriately to prevent any damage in transit, and it is recommended that the package should be insured or sent by a carrier who provides a tracking number of the package. CATCHWELL is not responsible for any Product that is lost or damaged in transit. If CATCHWELL ships a replacement product to you before receiving the original product and you fail to return the original product to CATCHWELL within thirty (30) days from the date the warranty service authorization is issued, CATCHWELL will charge you the current manufacturer's suggested retail price of such product. Your exclusive remedy and CATCHWELL's entire liability under this warranty will be for CATCHWELL at its option to repair or replace the Product or refund your purchase price less any rebates. CATCHWELL does not warrant against loss of any data or images (including data stored on Product returned to CATCHWELL for service), and assumes no liability for such loss.

ALL IMPLIED WARRANTIES OR CONDITIONS OF MERCHANTABILITY, SATISFACTORY QUALITY OR FITNESS FOR A PARTICULAR PURPOSE ARE LIMITED TO THE DURATION OF THE APPLICABLE EXPRESS WARRANTY. ALL OTHER EXPRESS OR IMPLIED CONDITIONS, REPRESENTATIONS AND WARRANTIES, INCLUDING ANY IMPLIED WARRANTY OF NON-INFRINGEMENT, ARE DISCLAIMED TO THE FULLEST EXTENT PERMITTED BY LAW.

There are inherent risks associated with any biometric sensor technology and security safeguard, including encryption technology, and biometric sensors and security safeguards, by their nature, are capable of circumvention. CATCHWELL cannot, and does not, guarantee that your data will not be accessed by unauthorized persons, and CATCHWELL disclaims any warranties to that effect to the fullest extent permitted by law. You should not use this product to protect sensitive data such as financial information or for accessing corporate networks.

Some jurisdictions do not allow limitations on how long an implied warranty lasts or at all, so the above limitation may not apply to you. This warranty gives you specific legal rights, and you may also have other rights, which vary by jurisdiction. This limitation does not affect your statutory rights.

All third party software provided with the Product is provided "AS IS". You assume the entire risk as to the quality, performance, accuracy and effect of such software, and should it prove defective, you, and not CATCHWELL, assume the entire cost of all necessary servicing or repair.

TO THE EXTENT NOT PROHIBITED BY LAW, IN NO EVENT WILL CATCHWELL BE LIABLE FOR ANY LOST IMAGES, DATA, REVENUE OR PROFIT, OR FOR SPECIAL, INDIRECT, CONSEQUENTIAL, INCIDENTAL OR PUNITIVE DAMAGES, HOWEVER CAUSED REGARDLESS OF THE THEORY OF LIABILITY, ARISING OUT OF OR RELATED TO THE USE OF OR INABILITY TO USE THE PRODUCT, EVEN IF CATCHWELL HAS BEEN ADVISED OF THE POSSIBILITY OF SUCH DAMAGES. IN NO EVENT WILL CATCHWELL'S LIABILITY EXCEED THE AMOUNT PAID BY YOU FOR THE PRODUCT.

The foregoing limitations will apply even if any warranty or remedy provided under this Agreement fails of its essential purpose.

Product	Warranty Period
CATCHWELL CW20 / CW30 :	
Handheld Mobile Computer	15 month from the manufactured date

INDEX

1XRTT 25
3G 25, 26

A

A2DP/AVRCP 90
About 37
Active Sync 33, 89
adapter 12, 13, 14
Adjusting Volume 39
Alarms 31
Answering Calls 60
Antenna 26
Audio mode 56
audio volume 57
Auxiliary GPS 77

B

backlight 20, 42
Backlight 37
backup battery 25
Barcode 37
Barcode scanner 10
battery 11, 14, 16
Battery 10
battery level 40
battery saving 19
Beam 35
Bluetooth 79
Bluetooth activation 82
Bluetooth deactivation 83
Bluetooth headsets 56
Bluetooth Stack 80, 81

C

Calculator 31
Calendar 30
Call 26
call details 69
Call History 59, 66
Call on hold 26
capture images 45
Certificates 37
Charging temperature 17

Charging the battery 17
Cleaning 93
Clock & Alarms 34
communication 7
Connected 25
Connections 34, 35
connector 9
Contacts 30, 58
cradle 13
Cradle 12

D

Device Profile 37
Digital camera 10
Direction 9

E

Ear phone 9
Earset 11, 14
EGPRS 25
email 25
E-mail 30
emergency calls 59
End 9
EVDO 25, 26
External GPS 37

F

find contacts 61
Flash 10
Function 9
Function buttons 45

G

GPRS 25, 26
GPS 75

H

Handbelt 10
hand strap 22
Hand strap 11, 13
hard reset 41

headsets 56
Home 30, 34
Home Screen 28
HSDPA 25, 26

I

Idling state 25
Image decoding 50, 52
Image scanning 53
indicator bar 30
information status indicating bar 28
Installation 6
Internet Explorer 30

K

Keymap 9
Keypad 38

L

Laser decoding 50
Laser scanning 50
Leather case 13
Locking 43
Locks 34

M

Maintenance 92
Marketplace 31
memo 62
Memory 38
message 25
Messenger 31
Microphone 9
MicroSD 22
microSD card 76
missed calls 26
mute the microphone 62

N

Notes 32
notifications 25
Notifications 25

O

ok 9

P

password 43, 84, 85
PDA 11
Personal 35
phone 55
Phone 30, 36
phone call 57
Phone Dialer 58
phone numbers 61
pictures and videos 46
Picture & videos 31
PIN 85
Power 6, 9, 34, 45
Power cord 12, 13, 14
protective film 92
Protective film 11, 14

R

Regional Settings 38
Remote Desktop Mobile 33
Remove Programs 38
Reset 10
Roaming 26
run 9

S

Safety instructions 92
Scan 9
scan barcodes 45
Scanning barcodes 51
Screen 38
screen protection 22
SD memory 10
Searching for Bluetooth devices 83
Select 9
Send 9
Serial Port 87
Settings 30, 34
SIM 15, 26
soft reset 41

sound 27
Sounds & Notifications 34
speaker 9, 10
Speed Dial 63
Start Screen 24, 30
Stylus 11, 13
Stylus holder 10
Switching calls 70
Synchronization 25
System 35

T

Taking a picture 47
Task Manager 33
Tasks 32
Text 30
Text message 71
Today 15
Turning on or off the phone 55

U

USB 12, 13, 14
USB Connections 38
USB – PC 35

V

Vibration 27
Video 48

W

Waist strap 11, 13
Warranty 7
Wi-Fi 25, 35
Windows Media 31
Wireless Manager 15, 20, 35

Body worm operation

This device was tested for typical body-worn operations with the back of the phone kept **20 mm.** from the body. To maintain compliance with FCC RF exposure requirements, use only belt-clips, holsters or similar accessories that maintain a **20 mm.** separation distance between the user's body and the back of the phone, including the antenna. The use of belt-clips, holsters and similar accessories should not contain

metallic components in its assembly. The use of accessories that do not satisfy these requirements may not comply with FCC RF exposure requirements, and should be avoided.

SAR INFORMATION

THIS MODEL PHONE MEETS THE GOVERNMENT'S REQUIREMENTS FOR EXPOSURE TO RADIO WAVES.

Your wireless phone is a radio transmitter and receiver. It is designed and manufactured not to exceed the emission limits for exposure to radiofrequency (RF) energy set by the Federal Communications Commission of the U.S. Government. These limits are part of comprehensive guidelines and establish permitted levels of RF energy for the general population. The guidelines are based on standards that were developed by independent scientific organizations through periodic and thorough evaluation of scientific studies. The standards include a substantial safety margin designed to assure the safety of all persons, regardless of age and health. The exposure standard for wireless mobile phones employs a unit of measurement known as the Specific Absorption Rate, or SAR. The SAR limit set by the FCC is 1.6 W/kg. *

Tests for SAR are conducted with the phone transmitting at its highest certified power level in all tested frequency bands. Although the SAR is determined at the highest certified power level, the actual SAR level of the phone while operating can be well below the maximum value. This is because the phone is designed to operate at multiple power levels so as to use only the power required to reach the network. In general, the closer you are to a wireless base station antenna, the lower the power output. Before a phone model is available for sale to the public, it must be tested and certified to the FCC that it does not exceed the limit established by the government adopted requirement for safe exposure. The tests are performed in positions and locations (e.g., at the ear and worn on the body) as required by the FCC for each model. The highest SAR value for this model phone when tested for use at the ear is **0.544 W/Kg** and when worn on the body, as described in this user guide, is **0.136 W/Kg**. (Body-worn measurements differ among phone models, depending upon available accessories and FCC requirements). While there may be differences between the SAR levels of various phones and at various positions, they all meet the government requirement for safe exposure. The FCC has granted an Equipment Authorization for this model phone with all reported SAR levels evaluated as in compliance with the FCC RF exposure guidelines. SAR information on this model phone is on file with the FCC and can be found under the Display Grant section of <http://www.fcc.gov/oet/fccid> after searching on **FCC ID: ZP4CW30**.

Additional information on Specific Absorption Rates (SAR) can be found on the Cellular Telecommunications Industry Association (CTIA) web-site at <http://www.wow-com.com>. * In the United States and Canada, the SAR limit for mobile phones used by the public is 1.6 watts/kg (W/kg) averaged over one gram of tissue. The standard incorporates a substantial margin of safety to give additional protection for the public and to account for any variations in measurements.

