

User's Manual

Version: 1.0

CC&C

WLAN 11n Pocket Router

WA-6210-V3

Wireless LAN Broadband Router

Trademarks

Copyright ©2007

Contents are subject to change without notice.

All trademarks belong to their respective proprietors.

Copyright Statement

THIS DOCUMENT CONTAINS OF PROPRIETARY TECHNICAL INFORMATION THAT IS THE PROPERTY OF THIS COMPANY. AND NO PART OF THIS DOCUMENTATION MAY BE REPRODUCED, STORED IN A RETRIEVAL SYSTEM OR TRANSMITTED IN ANY FORM OR BY ANY MEANS, ELECTRICAL OR MECHANICAL, BY PHOTOCOPYING, RECORDING, OR OTHERWISE, WITHOUT THE PRIOR WRITTEN CONSENT OF THIS COMPANY.

Federal Communication Commission Interference Statement

This equipment has been tested and found to comply with the limits for a Class B digital device, pursuant to Part 15 of the FCC Rules. These limits are designed to provide reasonable protection against harmful interference in a residential installation. This equipment generates, uses and can radiate radio frequency energy and, if not installed and used in accordance with the instructions, may cause harmful interference to radio communications. However, there is no guarantee that interference will not occur in a particular installation. If this equipment does cause harmful interference to radio or television reception, which can be determined by turning the equipment off and on, the user is encouraged to try to correct the interference by one of the following measures:

- Reorient or relocate the receiving antenna.
- Increase the separation between the equipment and receiver.
- Connect the equipment into an outlet on a circuit different from that to which the receiver is connected.
- Consult the dealer or an experienced radio/TV technician for help.

This device complies with Part 15 of the FCC Rules. Operation is subject to the following two conditions: (1) This device may not cause harmful interference, and (2) this device must accept any interference received, including interference that may cause undesired operation.

FCC Caution: Any changes or modifications not expressly approved by the party responsible for compliance could void the user's authority to operate this equipment.

IMPORTANT NOTE:

FCC Radiation Exposure Statement:

This equipment complies with FCC radiation exposure limits set forth for an uncontrolled environment. This equipment should be installed and operated with minimum distance 20cm between the radiator & your body.

This transmitter must not be co-located or operating in conjunction with any other antenna or transmitter.

Table of Contents

REVISION HISTORY I

TERMINOLOGY II

1 INTRODUCTION..... 1

 1.1 PACKAGE CONTENTS 1

 1.2 PRODUCT FEATURES 1

2 INSTALLATION 7

 2.1 HARDWARE INSTALLATION 7

 2.2 SOFTWARE INSTALLATION 7

3 SOFTWARE CONFIGURATION 7

 3.1 PREPARE YOUR PC TO CONFIGURE THE WLAN BROADBAND ROUTER 8

 3.2 CONNECT TO THE WLAN BROADBAND ROUTER 10

 3.3 MANAGEMENT AND CONFIGURATION ON THE WLAN BROADBAND ROUTER..... 10

 3.3.1 Status 10

 3.3.2 Setup Wizard..... 12

 I Operation Mode 12

 II Time Zone Setting 13

 III LAN Interface Setup..... 13

 IV WAN Interface Setup 14

 V Wireless Basic Settings..... 14

 VI Wireless Security Setup 15

 3.3.3 Operation Mode 16

 3.3.4 Wireless - Basic Settings..... 16

 3.3.5 Wireless - Advanced Settings 18

 3.3.6 Wireless - Security Setup 20

 3.3.7 Wireless - Access Control 22

 3.3.8 WDS Settings..... 23

 I WDS Security Setup 25

 II WDS AP Table 25

 3.3.9 Site Survey 26

 3.3.10 WPS 27

 3.3.11 Schedule 29

3.3.12	LAN Interface Setup	29
I	Static DHCP Setup.....	31
3.3.13	WAN Interface Setup	32
I	Static IP.....	33
II	DHCP Client	35
III	PPPoE	37
IV	PPTP	40
V	L2TP	43
3.3.14	Firewall - Port Filtering	45
3.3.15	Firewall - IP Filtering.....	46
3.3.16	Firewall - MAC Filtering	47
3.3.17	Firewall - Port Forwarding.....	48
3.3.18	Firewall – URL Filtering.....	50
3.3.19	Firewall - DMZ.....	51
3.3.20	QoS	51
3.3.21	Management - Statistics	53
3.3.22	Management - DDNS	54
3.3.23	Management - Time Zone Setting.....	55
3.3.24	Management – Denial-of-Service	56
3.3.25	Management - Log	57
3.3.26	Management - Upgrade Firmware	58
3.3.27	Management Save/ Reload Settings.....	59
3.3.28	Management - Password Setup.....	60
3.3.29	Management – Watchdog Setting	60
4	FREQUENTLY ASKED QUESTIONS (FAQ).....	62
4.1	WHAT AND HOW TO FIND MY PC’S IP AND MAC ADDRESS?.....	62
4.2	WHAT IS WIRELESS LAN?	62
4.3	WHAT ARE ISM BANDS?	62
4.4	HOW DOES WIRELESS NETWORKING WORK?.....	62
4.5	WHAT IS BSSID?	63
4.6	WHAT IS ESSID?	63
4.7	WHAT ARE POTENTIAL FACTORS THAT MAY CAUSES INTERFERENCE?	64
4.8	WHAT ARE THE OPEN SYSTEM AND SHARED KEY AUTHENTICATIONS?	64
4.9	WHAT IS WEP?	64
4.10	WHAT IS FRAGMENT THRESHOLD?.....	64
4.11	WHAT IS RTS (REQUEST TO SEND) THRESHOLD?	65

4.12	WHAT IS BEACON INTERVAL?.....	65
4.13	WHAT IS PREAMBLE TYPE?.....	66
4.14	WHAT IS SSID BROADCAST?	66
4.15	WHAT IS WI-FI PROTECTED ACCESS (WPA)?	66
4.16	WHAT IS WPA2?	67
4.17	WHAT IS 802.1X AUTHENTICATION?	67
4.18	WHAT IS TEMPORAL KEY INTEGRITY PROTOCOL (TKIP)?	67
4.19	WHAT IS ADVANCED ENCRYPTION STANDARD (AES)?	67
4.20	WHAT IS INTER-ACCESS POINT PROTOCOL (IAPP)?.....	67
4.21	WHAT IS WIRELESS DISTRIBUTION SYSTEM (WDS)?.....	67
4.22	WHAT IS UNIVERSAL PLUG AND PLAY (UPNP)?.....	68
4.23	WHAT IS MAXIMUM TRANSMISSION UNIT (MTU) SIZE?.....	68
4.24	WHAT IS CLONE MAC ADDRESS?.....	68
4.25	WHAT IS DDNS?.....	68
4.26	WHAT IS NTP CLIENT?	68
4.27	WHAT IS VPN?.....	68
4.28	WHAT IS IPSEC?.....	68
4.29	WHAT IS WLAN BLOCK RELAY BETWEEN CLIENTS?	69
4.30	WHAT IS WMM?.....	69
4.31	WHAT IS WLAN ACK TIMEOUT?	69
4.32	WHAT IS MODULATION CODING SCHEME (MCS)?	69
4.33	WHAT IS FRAME AGGREGATION?	69
4.34	WHAT IS GUARD INTERVALS (GI)?	69
5	CONFIGURATION EXAMPLES.....	71
5.1	EXAMPLE ONE – PPPOE ON THE WAN	71
5.2	EXAMPLE TWO – FIXED IP ON THE WAN	73

Revision History

DATE	REVISION OF USER'S MANUAL	FIRMWARE
2009/09/09	Version 1.0	vs5.4.0.2

Terminology

3DES	Triple Data Encryption Standard
AES	Advanced Encryption Standard
ANSI	American National Standards Institute
AP	Access Point
CCK	Complementary Code Keying
CSMA/CA	Carrier Sense Multiple Access/ Collision Avoidance
CSMA/CD	Carrier Sense Multiple Access/ Collision Detection
DDNS	Dynamic Domain Name Server
DH	Diffie-Hellman Algorithm
DHCP	Dynamic Host Configuration Protocol
DSSS	Direct Sequence Spread Spectrum
EAP	Extensible Authentication Protocol
ESP	Encapsulating Security Payload
FCC	Federal Communications Commission
FTP	File Transfer Protocol
GI	Guard Intervals
IAPP	Inter Access Point Protocol
IEEE	Institute of Electrical and Electronic Engineers
IKE	Internet Key Exchange
IP	Internet Protocol
ISM	Industrial, Scientific and Medical
LAN	Local Area Network
MAC	Media Access Control
MCS	Modulation Coding Scheme
MD5	Message Digest 5
NAT	Network Address Translation
NT	Network Termination
NTP	Network Time Protocol
PPTP	Point to Point Tunneling Protocol
PSD	Power Spectral Density
RF	Radio Frequency
SHA1	Secure Hash Algorithm
SNR	Signal to Noise Ratio

SSID	Service Set Identification
TCP	Transmission Control Protocol
TFTP	Trivial File Transfer Protocol
TKIP	Temporal Key Integrity Protocol
UPNP	Universal Plug and Play
VPN	Virtual Private Network
WDS	Wireless Distribution System
WEP	Wired Equivalent Privacy
WISP	Wireless Internet Service Provider
WLAN	Wireless Local Area Network
WPA	Wi-Fi Protected Access
WPS	Wi-Fi Protected Setup

1 Introduction

The Wireless LAN Broadband Router is an affordable IEEE 802.11b/g/n wireless LAN broadband router solution; setting SOHO and enterprise standard for high performance, secure, manageable and reliable WLAN.

This document describes the steps required for the initial IP address assign and other WLAN router configuration. The description includes the implementation of the above steps.

1.1 Package contents

The package of the WLAN Broadband Router includes the following items,

- ✓ The WLAN Broadband Router
- ✓ The AC to DC power adapter
- ✓ The Documentation CD
- ✓ RJ-45 Cable Line (Option)

1.2 Product Features

Generic Router

- Complies with IEEE 802.11b/g/n standard for 2.4GHz Wireless LAN.
- Compatible with IEEE 802.11n Draft 2.0 Specifications provides wireless speed up to 300Mbps data rate.
- Compatible with IEEE 802.11g high rate standard to provide wireless Ethernet speeds of 54Mbps data rate.
- Maximizes the performance and ideal for media-centric applications like streaming video, gaming and Voice over IP technology.
- Supports multi-operation (bridge/gateway/WISP) modes between wireless and wired Ethernet interfaces.
- Supports WPS, 64-bit and 128-bit WEP, WPA, WPA2 encryption/decryption and WPA with Radius function to protect the wireless data transmission.
- Supports IEEE 802.1x Authentication.
- Support Wi-Fi Protected Access Authentication with Radius and Pre-Shared Key mode.
- Supports Inter-Access Point Protocol (IAPP).
- Supports Wireless Distribution System (WDS).
- Supports IEEE 802.3x full duplex flow control on 10/100M Ethernet interface.
- Supports DHCP server to provide clients auto IP addresses assignment.
- Supports DHCP client for WAN interface auto IP address assignment from ISP.
- Supports PPPoE on WAN interface.

-
- Supports PPTP Client on Ethernet WAN interface.
 - Supports L2TP Client on Ethernet WAN interface.
 - Supports clone MAC address function.
 - Supports firewall security with Port filtering, IP filtering, MAC filtering, Port forwarding, DMZ hosting and URL filtering functions.
 - Supports WEB based management and configuration.
 - Supports UPnP for automatic Internet access.
 - Supports Dynamic DNS service.
 - Supports NTP client service.
 - Supports Log table and remote Log service.
 - Support Setup Wizard mode.
 - Support DoS (Denial of Service) function.
 - Support WMM function.

Panel Description (1WAN)

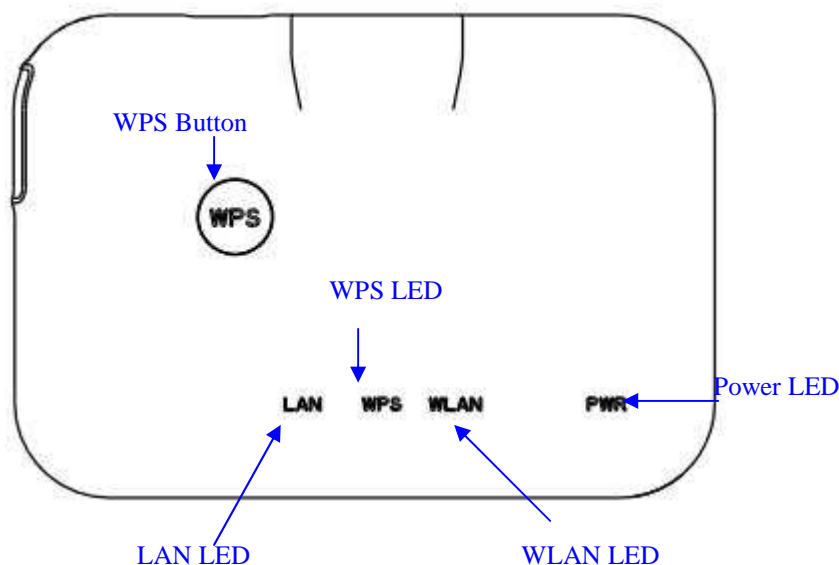

LED Indicator	State	Description
1. Power LED	On	The WLAN Broadband Router is powered on.
	Off	The WLAN Broadband Router is powered off.
2. WLAN LED	Flashing	Data is transmitting or receiving on the antenna.
	Off	No data is transmitting or receiving on the antenna.
3. WPS LED	Flashing	The WPS feature is Enabled.
	Off	The WPS feature is Disabled.
4. WAN LED ACT	Flashing	Data is transmitting or receiving on the WAN interface.
	On	Port linked.
	Off	No link.
5. LAN LED ACT	Flashing	Data is transmitting or receiving on the LAN interface.
	On	Port linked.
	Off	No link.

Interface Description

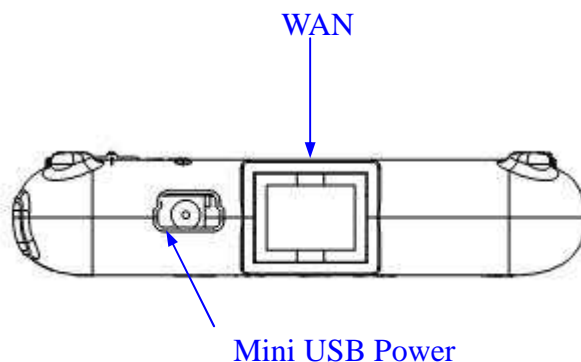

Interfaces	Description
Antenna	The Wireless LAN Antenna. in box
Power	The power jack allows an mini USB power supply connection. The external mini USB adaptor provide adaptive power requirement to the WLAN Broadband Router.
WAN	The RJ-45 socket allows WAN connection through a Category 5 cable. Support auto-sensing on 10/100M speed and half/ full duplex; comply with IEEE 802.3/ 802.3u respectively.
LAN	The RJ-45 sockets allow LAN connection through Category 5 cables. Support auto-sensing on 10/100M speed and half/ full duplex; comply with IEEE 802.3/ 802.3u respectively.
WPS	Push continually the reset button 5 ~ 10 seconds to enable the WPS feature.
Reset	Push continually the reset button 5 ~ 10 seconds to reset the configuration parameters to factory defaults.

Panel Description (1WAN)

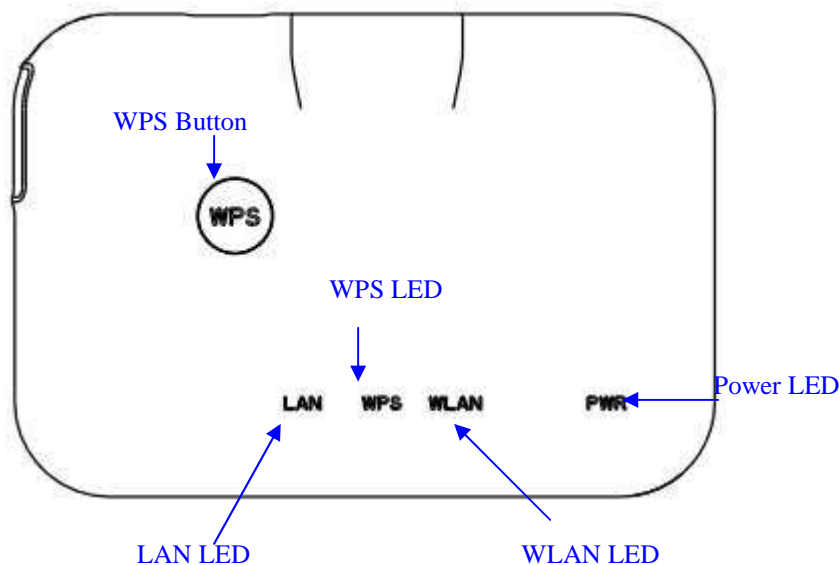

LED Indicator	State	Description
1. Power LED	On	The WLAN Broadband Router is powered on.
	Off	The WLAN Broadband Router is powered off.
2. WLAN LED	Flashing	Data is transmitting or receiving on the antenna.
	Off	No data is transmitting or receiving on the antenna.
3. WPS LED	Flashing	The WPS feature is Enabled.
	Off	The WPS feature is Disabled.
4. WAN LED ACT	Flashing	Data is transmitting or receiving on the WAN interface.
	On	Port linked.
	Off	No link.
5. LAN LED ACT	Flashing	Data is transmitting or receiving on the LAN interface.
	On	Port linked.
	Off	No link.

Interface Description

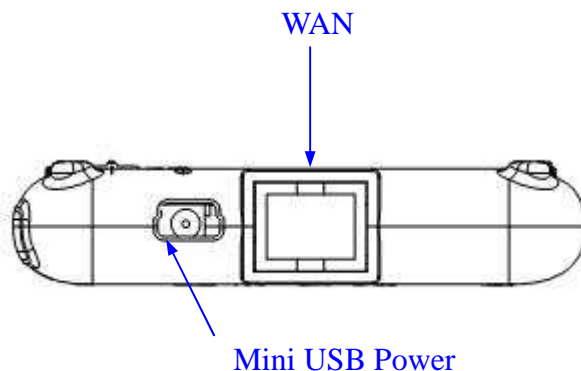

Interfaces	Description
Antenna	The Wireless LAN Antenna. in box
Mini USB Power	The power jack allows an mini USB power supply connection. The external mini USB adaptor provide adaptive power requirement to the WLAN Broadband Router.
WAN	The RJ-45 socket allows WAN connection through a Category 5 cable. Support auto-sensing on 10/100M speed and half/ full duplex; comply with IEEE 802.3/ 802.3u respectively.
LAN	The RJ-45 sockets allow LAN connection through Category 5 cables. Support auto-sensing on 10/100M speed and half/ full duplex; comply with IEEE 802.3/ 802.3u respectively.
WPS	Push continually the reset button 5 ~ 10 seconds to enable the WPS feature.
Reset	Push continually the reset button 5 ~ 10 seconds to reset the configuration parameters to factory defaults.

2 Installation

2.1 Hardware Installation

Step 1: Place the Wireless LAN Broadband Router to the best optimum transmission location. The best transmission location for your WLAN Broadband Router is usually at the geographic center of your wireless network, with line of sight to all of your mobile stations.

Step 2: Connect the WLAN Broadband Router to your wired network. Connect the Ethernet WAN interface of WLAN Broadband Router by category 5 Ethernet cable to your switch/ hub/ xDSL modem or cable modem. A straight-through Ethernet cable with appropriate cable length is needed.

Step 3: Supply DC power to the WLAN Broadband Router. Use only the AC/DC power adapter supplied with the WLAN Broadband Router; it may occur damage by using a different type of power adapter.

The hardware installation finished.

2.2 Software Installation

- There are no software drivers, patches or utilities installation needed, but only the configuration setting. Please refer to chapter 3 for software configuration.

Notice: It will take about 50 seconds to complete the boot up sequence after powered on the WLAN Broadband Router; Power LED will be active, and after that the WLAN Activity LED will be flashing to show the WLAN interface is enabled and working now.

3 Software configuration

There are web based management and configuration functions allowing you to have the jobs done easily.

The WLAN Broadband Router is delivered with the following factory default parameters on the Ethernet LAN interfaces.

Default IP Address: **192.168.1.254**

Default IP subnet mask: **255.255.255.0**

WEB login User Name: **<empty>**

WEB login Password: **<empty>**

3.1 Prepare your PC to configure the WLAN Broadband Router

For OS of Microsoft Windows 95/ 98/ Me/XP:

1. Click the *Start* button and select *Settings*, then click *Control Panel*. The *Control Panel* window will appear.
Note: Windows Me users may not see the Network control panel. If so, *select View all Control Panel options* on the left side of the window
2. Move mouse and double-click the right button on *Network* icon. The *Network* window will appear.
3. Check the installed list of *Network Components*. If TCP/IP is not installed, click the *Add* button to install it; otherwise go to step 6.
4. Select *Protocol* in the *Network Component Type* dialog box and click *Add* button.
5. Select *TCP/IP* in *Microsoft* of *Select Network Protocol* dialog box then click OK button to install the TCP/IP protocol, it may need the Microsoft Windows CD to complete the installation. Close and go back to *Network* dialog box after the TCP/IP installation.
6. Select *TCP/IP* and click the *properties* button on the *Network* dialog box.
7. Select *Specify an IP address* and type in values as following example.
 - ✓ IP Address: **192.168.1.1**, any IP address within 192.168.1.1 to 192.168.1.253 is good to connect the Wireless LAN Access Point.
 - ✓ IP Subnet Mask: **255.255.255.0**
8. Click OK and reboot your PC after completes the IP parameters setting.

For OS of Microsoft Windows 2000, XP:

1. Click the *Start* button and select *Settings*, then click *Control Panel*. The *Control Panel* window will appear.
2. Move mouse and double-click the right button on *Network and Dial-up Connections* icon. Move mouse and double-click the *Local Area Connection* icon. The *Local Area Connection* window will appear. Click *Properties* button in the *Local Area Connection* window.
3. Check the installed list of *Network Components*. If TCP/IP is not installed, click the *Add* button to install it; otherwise go to step 6.
4. Select *Protocol* in the *Network Component Type* dialog box and click *Add* button.
5. Select *TCP/IP* in *Microsoft* of *Select Network Protocol* dialog box then click OK button to install the TCP/IP protocol, it may need the Microsoft Windows CD to complete the installation. Close and go back to *Network* dialog box after the TCP/IP installation.

6. Select **TCP/IP** and click the **properties** button on the **Network** dialog box.
7. Select **Specify an IP address** and type in values as following example.
 - ✓ IP Address: **192.168.1.1**, any IP address within 192.168.1.1 to 192.168.1.253 is good to connect the Wireless LAN Access Point.
 - ✓ IP Subnet Mask: **255.255.255.0**
8. Click OK to completes the IP parameters setting.

For OS of Microsoft Windows NT:

1. Click the **Start** button and select **Settings**, then click **Control Panel**. The **Control Panel** window will appear.
2. Move mouse and double-click the right button on **Network** icon. The **Network** window will appear. Click **Protocol** tab from the **Network** window.
3. Check the installed list of **Network Protocol** window. If TCP/IP is not installed, click the **Add** button to install it; otherwise go to step 6.
4. Select **Protocol** in the **Network Component Type** dialog box and click **Add** button.
5. Select **TCP/IP** in **Microsoft** of **Select Network Protocol** dialog box then click OK button to install the TCP/IP protocol, it may need the Microsoft Windows CD to complete the installation. Close and go back to **Network** dialog box after the TCP/IP installation.
6. Select **TCP/IP** and click the **properties** button on the **Network** dialog box.
7. Select **Specify an IP address** and type in values as following example.
 - ✓ IP Address: **192.168.1.1**, any IP address within 192.168.1.1 to 192.168.1.253 is good to connect the Wireless LAN Access Point.
 - ✓ IP Subnet Mask: **255.255.255.0**
8. Click OK to complete the IP parameters setting.

For OS of Microsoft Windows Vista:

1. Click the **Start** button and select **Settings**, then click **Control Panel**. The **Control Panel** window will appear.
2. Move mouse and double-click the right button on **Network Connections** item. The **Network Connections** window will appear. Double click **Local Area Connection** icon, then **User Account Control** window shown. Right click **Continue** button to set properties.
3. In **Local Area Connection Properties** window, Choose **Networking** tab, move mouse and click **Internet Protocol Version 4 (TCP/IPv4)**, then click **Properties** button.
4. Move mouse and click **General** tab, Select **Specify an IP address** and type in values as following example.
 - ✓ IP Address: **192.168.1.1**, any IP address within 192.168.1.1 to 192.168.1.253 is

good to connect the Wireless LAN Access Point.

- ✓ IP Subnet Mask: **255.255.255.0**

5. Click OK to complete the IP parameters setting.

3.2 Connect to the WLAN Broadband Router

Open a WEB browser, i.e. Microsoft Internet Explore 6.1 SP1 or above, then enter 192.168.1.254 on the URL to connect the WLAN Broadband Router.

3.3 Management and configuration on the WLAN Broadband Router

3.3.1 Status

This page shows the current status and some basic settings of the device, includes system, wireless, Ethernet LAN and WAN configuration information.

Access Point Status	
This page shows the current status and some basic settings of the device.	
System	
Uptime	0day:0h:14m:39s
Firmware Version	cs5.4.0.0
Build Time	Wed Aug 19 11:07:59 CST 2009
Wireless Configuration	
Mode	AP
Band	2.4 GHz (B+G+N)
SSID	MyWLAN
Channel Number	11
Encryption	Disabled
BSSID	00:02:72:81:96:01
Associated Clients	0
TCP/IP Configuration	
Attain IP Protocol	Fixed IP
IP Address	192.168.1.254
Subnet Mask	255.255.255.0
Default Gateway	192.168.1.254
DHCP Server	Enabled
MAC Address	00:02:72:81:96:01
WAN Configuration	
Attain IP Protocol	Getting IP from DHCP server...
IP Address	0.0.0.0
Subnet Mask	0.0.0.0
Default Gateway	0.0.0.0
MAC Address	00:02:72:81:96:09

Screen snapshot – Status

Item	Description
------	-------------

System

Uptime It shows the duration since WLAN Broadband Router is powered on.

Firmware version It shows the firmware version of WLAN Broadband Router.

Build time It shows the Build-up time of firmware

Wireless configuration

Mode It shows wireless operation mode

Band It shows the current wireless operating frequency.

SSID It shows the SSID of this WLAN Broadband Router. The SSID is the unique name of WLAN Broadband Router and shared among its service area, so all devices attempts to join the same wireless network can identify it.

Channel Number It shows the wireless channel connected currently.

Encryption It shows the status of encryption function.

BSSID It shows the BSSID address of the WLAN Broadband Router. BSSID is a six-byte address.

Associated Clients It shows the number of connected clients (or stations, PCs).

TCP/IP configuration

Attain IP Protocol It shows type of connection.

IP Address It shows the IP address of LAN interfaces of WLAN Broadband Router.

Subnet Mask It shows the IP subnet mask of LAN interfaces of WLAN Broadband Router.

Default Gateway It shows the default gateway setting for LAN interfaces outgoing data packets.

DHCP Server It shows the DHCP server is enabled or not.

MAC Address It shows the MAC address of LAN interfaces of WLAN Broadband Router.

WAN configuration

Attain IP Protocol It shows how the WLAN Broadband Router gets the IP address. The IP address can be set manually to a fixed one or set dynamically by DHCP server or attain IP by PPPoE / PPTP connection.

IP Address It shows the IP address of WAN interface of WLAN

	Broadband Router.
Subnet Mask	It shows the IP subnet mask of WAN interface of WLAN Broadband Router.
Default Gateway	It shows the default gateway setting for WAN interface outgoing data packets.
MAC Address	It shows the MAC address of WAN interface of WLAN Broadband Router.

3.3.2 Setup Wizard

This page guides you to configure wireless broadband router for first time

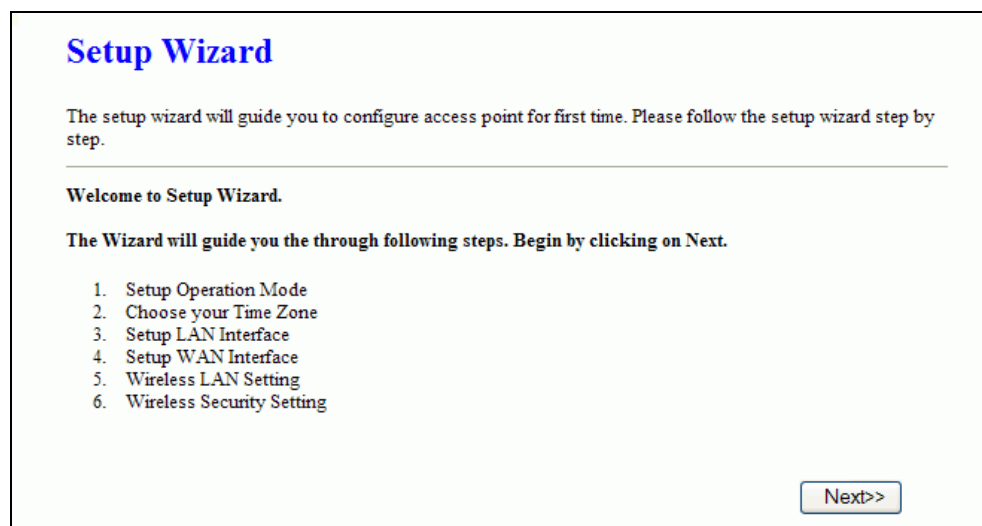

Screen snapshot – Setup Wizard

I Operation Mode

This page followed by Setup Wizard page to define the operation mode.

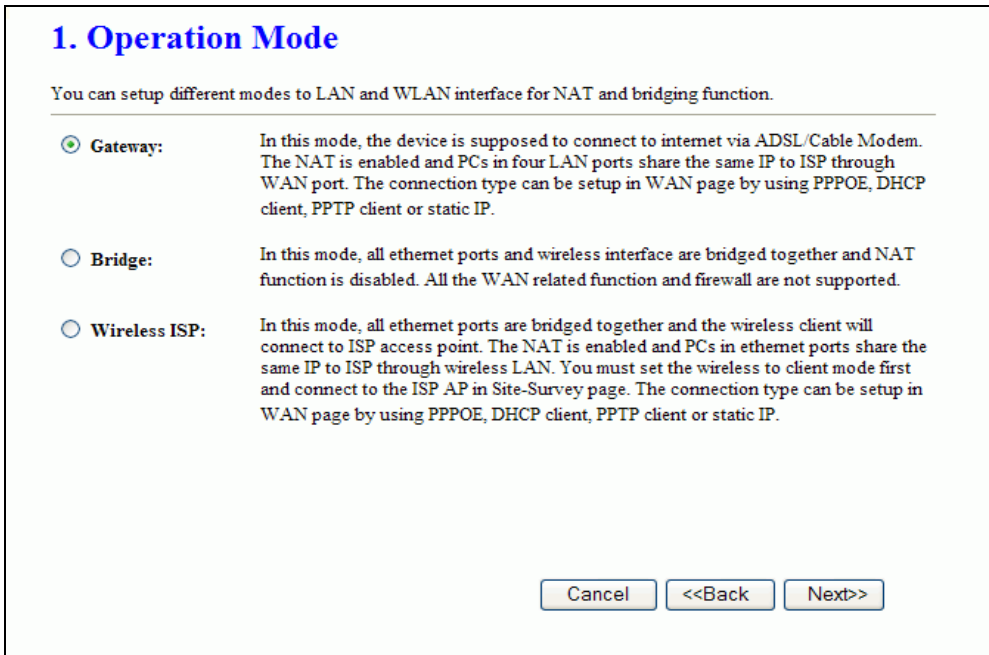

Screen snapshot – Operation Mode

II Time Zone Setting

This page is used to enable and configure NTP client



Screen snapshot – Time Zone Settings

III LAN Interface Setup

This page is used to configure local area network IP address and subnet

mask

3. LAN Interface Setup

This page is used to configure the parameters for local area network which connects to the LAN port of your Access Point. Here you may change the setting for IP addresss, subnet mask, DHCP, etc..

IP Address:

Subnet Mask:

Screen snapshot – LAN Interface Setup

IV WAN Interface Setup

This page is used to configure WAN access type

4. WAN Interface Setup

This page is used to configure the parameters for Internet network which connects to the WAN port of your Access Point. Here you may change the access method to static IP, DHCP, PPPoE or PPTP by click the item value of WAN Access type.

WAN Access Type:

Screen snapshot – WAN Interface Setup

V Wireless Basic Settings

This page is used to configure basic wireless parameters like Band, Mode, Network Type SSID, Channel Number, Enable Mac Clone(Single Ethernet Client)

14

5. Wireless Basic Settings

This page is used to configure the parameters for wireless LAN clients which may connect to your Access Point.

Band: 2.4 GHz (B+G+N)

Mode: AP

Network Type: Infrastructure

SSID: MyWLAN

Channel Width: 40MHz

ControlSideband: Upper

Channel Number: 11

Enable Mac Clone (Single Ethernet Client)

Screen snapshot – Wireless Basic Settings

VI Wireless Security Setup

This page is used to configure wireless security

6. Wireless Security Setup

This page allows you setup the wireless security. Turn on WEP or WPA by using Encryption Keys could prevent any unauthorized access to your wireless network.

Encryption: WEP

Key Length: 64-bit

Key Format: Hex (10 characters)

Key Setting:

Screen snapshot – Wireless Security Setup

3.3.3 Operation Mode

This page is used to configure which mode wireless broadband router acts

Operation Mode

You can setup different modes to LAN and WLAN interface for NAT and bridging function.

- Gateway:** In this mode, the device is supposed to connect to internet via ADSL/Cable Modem. The NAT is enabled and PCs in LAN ports share the same IP to ISP through WAN port. The connection type can be setup in WAN page by using PPPOE, DHCP client, PPTP client or static IP.
- Bridge:** In this mode, all ethernet ports and wireless interface are bridged together and NAT function is disabled. All the WAN related function and firewall are not supported.
- Wireless ISP:** In this mode, all ethernet ports are bridged together and the wireless client will connect to ISP access point. The NAT is enabled and PCs in ethernet ports share the same IP to ISP through wireless LAN. You must set the wireless to client mode first and connect to the ISP AP in Site-Survey page. The connection type can be setup in WAN page by using PPPOE, DHCP client, PPTP client or static IP.

Screen snapshot – Operation Mode

Item	Description
Gateway	Traditional gateway configuration. It always connects internet via ADSL/Cable Modem. LAN interface, WAN interface, Wireless interface, NAT and Firewall modules are applied to this mode
Bridge	Each interface (LAN, WAN and Wireless) regards as bridge. NAT, Firewall and all router's functions are not supported
Wireless ISP	Switch Wireless interface to WAN port and all Ethernet ports in bridge mode. Wireless interface can do all router's functions
Apply Changes	Click the Apply Changes button to complete the new configuration setting.
Reset	Click the Reset button to abort change and recover the previous configuration setting.

3.3.4 Wireless - Basic Settings

This page is used to configure the parameters for wireless LAN clients that may connect to your Broadband Router. Here you may change wireless encryption

settings as well as wireless network parameters.

Wireless Basic Settings

This page is used to configure the parameters for wireless LAN clients which may connect to your Access Point. Here you may change wireless encryption settings as well as wireless network parameters.

Disable Wireless LAN Interface

Band: 2.4 GHz (B+G+N)

Mode: AP Multiple AP

Network Type: Infrastructure

SSID: MyWLAN

Channel Width: 40MHz

Control Sideband: Upper

Channel Number: 11

Broadcast SSID: Enabled

WMM: Enabled

Data Rate: Auto

Associated Clients: Show Active Clients

Enable Mac Clone (Single Ethernet Client)

Enable Universal Repeater Mode (Acting as AP and client simultaneously)

SSID of Extended Interface:

Apply Changes
Reset

Screen snapshot – Wireless Basic Settings

Item	Description
Disable Wireless LAN Interface	Click on to disable the wireless LAN data transmission.
Band	Click to select 2.4GHz(B) / 2.4GHz(G) / 2.4GHz(N) / 2.4GHz(B+G)/ 2.4GHz(G+N) / 2.4GHz(B+G+N)
Mode	Click to select the WLAN AP / Client / WDS / AP+WDS wireless mode.
Network Type	While Mode is selected to be Client . Click to select the network type infrastructure or Ad hoc.

SSID	It is the wireless network name. The SSID can be 32 bytes long.
Channel Width	Select the operating channel width 20 MHz or 40 MHz. [N band only]
Control Sideband	Select the Sideband with Upper or Lower for channel width 40MHz. [N band only]
Channel Number	Select the wireless communication channel from pull-down menu.
Broadcast SSID	Click to enable or disable the SSID broadcast function. Refer to 4.14 What is SSID Broadcast?
WMM	Click Enabled/Disabled to init WMM feature.
Data Rate	Select the transmission data rate from pull-down menu. Data rate can be auto-select, 1M to 54Mbps or MCS. Refer to 4.32 What is Modulation Coding Schemes (MCS)?
Associated Clients	Click the Show Active Clients button to open Active Wireless Client Table that shows the MAC address, transmit-packet, receive-packet and transmission-rate for each associated wireless client.
Enable Mac Clone (Single Ethernet Client)	Take Laptop NIC MAC address as wireless client MAC address. [Client Mode only]
Enable Universal Repeater Mode	Click to enable Universal Repeater Mode
SSID of Extended Interface	Assign SSID when enables Universal Repeater Mode.
Apply Changes	Click the Apply Changes button to complete the new configuration setting.
Reset	Click the Reset button to abort change and recover the previous configuration setting.

3.3.5 Wireless - Advanced Settings

These settings are only for more technically advanced users who have a sufficient knowledge about wireless LAN. These settings should not be changed unless you know what effect the changes will have on your WLAN Broadband Router.

Wireless Advanced Settings

These settings are only for more technically advanced users who have a sufficient knowledge about wireless LAN. These settings should not be changed unless you know what effect the changes will have on your Access Point.

Fragment Threshold: (256-2346)

RTS Threshold: (0-2347)

Beacon Interval: (20-1024 ms)

Preamble Type: Long Preamble Short Preamble

IAPP: Enabled Disabled

Protection: Enabled Disabled

Aggregation: Enabled Disabled

Short GI: Enabled Disabled

WLAN Partition: Enabled Disabled

RF Output Power: 100% 70% 50% 35% 15%

Screen snapshot – Wireless Advanced Settings

Item	Description
Fragment Threshold	Set the data packet fragmentation threshold, value can be written between 256 and 2346 bytes. Refer to 4.10 What is Fragment Threshold?
RTS Threshold	Set the RTS Threshold, value can be written between 0 and 2347 bytes. Refer to 4.11 What is RTS(Request To Send) Threshold?
Beacon Interval	Set the Beacon Interval, value can be written between 20 and 1024 ms. Refer to 4.12 What is Beacon Interval?
Preamble Type	Click to select the <i>Long Preamble</i> or <i>Short Preamble</i> support on the wireless data packet transmission. Refer to 4.13 What is Preamble Type?
IAPP	Click to enable or disable the IAPP function. Refer to 4.20 What is Inter-Access Point Protocol(IAPP)?
Protection	Protect 802.11n user priority.
Aggregation	Click to enable or disable the Aggregation function. Refer to 4.33 What is Aggregation?

Short GI	Click to enable or disable the short Guard Intervals function. Refer to 4.34 What is Guard Intervals (GI)?
WLAN Partition	Click to enable or disable that prevents associated wireless clients from communication with each other.
RF Output Power	To adjust transmission power level.
Apply Changes	Click the Apply Changes button to complete the new configuration setting.
Reset	Click the Reset button to abort change and recover the previous configuration setting.

3.3.6 Wireless - Security Setup

This page allows you setup the wireless security. Turn on WEP, WPA, WPA2 by using encryption keys could prevent any unauthorized access to your wireless network.



Screen snapshot – Wireless Security Setup

Item	Description
Select SSID	Select the SSID from multiple APs.
Encryption	Select the encryption supported over wireless access. The encryption method can be None, WEP, WPA, WPA2 or

	WPA-Mixed Refer to 4.9 What is WEP? 4.15 What is Wi-Fi Protected Access (WPA)? 4.16 What is WPA2?
Use 802.1x Authentication	While Encryption is selected to be WEP. Click the check box to enable IEEE 802.1x authentication function. Refer to 4.17 What is 802.1x Authentication?
Authentication Type	Click to select the authentication type in Open System , Shared Key or Auto selection.
Key Length	Select the WEP shared secret key length from pull-down menu. The length can be chose between 64-bit and 128-bit (known as “WEP2”) keys. The WEP key is composed of initialization vector (24 bits) and secret key (40-bit or 104-bit).
Key Format	Select the WEP shared secret key format from pull-down menu. The format can be chose between plant text (ASCII) and hexadecimal (HEX) code.
Encryption Key	Secret key of WEP security encryption function.
WPA Authentication Mode	While Encryption is selected to be WPA. Click to select the WPA Authentication Mode with Enterprise (RADIUS) or Personal (Pre-Shared Key). Refer to 4.15 What is Wi-Fi Protected Access (WPA)?
WPA Cipher Suite	Select the Cipher Suite for WPA encryption. 4.18 What is Temporal Key Integrity Protocol (TKIP)? 4.19 What is Advanced Encryption Standard (AES)?
WPA2 Cipher Suite	Select the Cipher Suite for WPA2 encryption.
Pre-Shared Key Format	While Encryption is selected to be WPA. Select the Pre-shared key format from the pull-down menu. The format can be Passphrase or Hex (64 characters). [WPA, Personal(Pre-Shared Key) only]
Pre-Shared Key	Fill in the key value. [WPA, Personal(Pre-Shared Key) only]
Enable Pre-Authentication	Click to enable Pre-Authentication. [WPA2/WPA2 Mixed only, Enterprise only]
Authentication	Set the IP address, port and login password information

RADIUS Server	of authentication RADIUS sever.
Apply Changes	Click the <i>Apply Changes</i> button to complete the new configuration setting.
Reset	Click the <i>Reset</i> button to abort change and recover the previous configuration setting.

WEP encryption key (secret key) length:

	Length	64-bit	128-bit
Format	ASCII	5 characters	13 characters
	HEX	10 hexadecimal codes	26 hexadecimal codes

3.3.7 Wireless - Access Control

If you enable wireless access control, only those clients whose wireless MAC addresses are in the access control list will be able to connect to your Access Point. When this option is enabled, no wireless clients will be able to connect if the list contains no entries.

Wireless Access Control

If you choose 'Allowed Listed', only those clients whose wireless MAC addresses are in the access control list will be able to connect to your Access Point. When 'Deny Listed' is selected, these wireless clients on the list will not be able to connect the Access Point.

Wireless Access Control Mode: Allow Listed ▾

MAC Address: Comment:

Apply Changes
Reset

Current Access Control List:

MAC Address	Comment	Select
00-02-72-81-86-01	ST-1	<input type="checkbox"/>
00-00-55-66-66-50	ST-2	<input type="checkbox"/>

Delete Selected
Delete All
Reset

Screen snapshot – Wireless Access Control

Item	Description
Wireless Access Control Mode	Click the <i>Disabled, Allow Listed</i> or <i>Deny Listed</i> of drop down menu choose wireless access control mode. This is a security control function; only those clients

	registered in the access control list can link to this WLAN Broadband Router.
MAC Address	Fill in the MAC address of client to register this WLAN Broadband Router access capability.
Comment	Fill in the comment tag for the registered client.
Apply Changes	Click the Apply Changes button to register the client to new configuration setting.
Reset	Click the Reset button to abort change and recover the previous configuration setting.
Current Access Control List	It shows the registered clients that are allowed to link to this WLAN Broadband Router.
Delete Selected	Click to delete the selected clients that will be access right removed from this WLAN Broadband Router.
Delete All	Click to delete all the registered clients from the access allowed list.
Reset	Click the Reset button to abort change and recover the previous configuration setting.

3.3.8 WDS Settings

Wireless Distribution System uses wireless media to communicate with other APs, like the Ethernet does. To do this, you must set these APs in the same channel and set MAC address of other AP that you want to communicate with in the table and then enable the WDS.

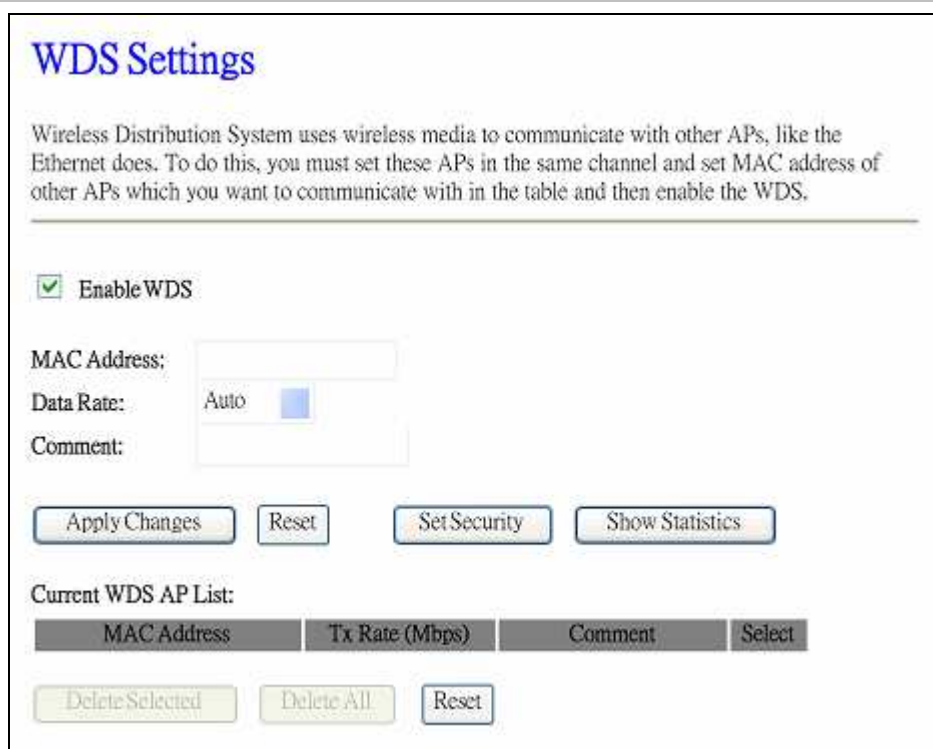

Screen snapshot – WDS Setup

Item	Description
Enable WDS	Click the check box to enable wireless distribution system. Refer to 4.21 What is Wireless Distribution System (WDS)?
MAC Address	Fill in the MAC address of AP to register the wireless distribution system access capability.
Data Rate	Select the transmission data rate from pull-down menu. Data rate can be auto-select, 1M to 54Mbps or MCS.
Comment	Fill in the comment tag for the registered AP.
Apply Changes	Click the Apply Changes button to register the AP to new configuration setting.
Reset	Click the Reset button to abort change and recover the previous configuration setting.
Set Security	Click button to configure wireless security like WEP(64bits) , WEP(128bits) , WPA(TKIP) , WPA2(AES) or None
Show Statistics	It shows the TX, RX packets, rate statistics
Delete Selected	Click to delete the selected clients that will be removed

	from the wireless distribution system.
Delete All	Click to delete all the registered APs from the wireless distribution system allowed list.
Reset	Click the Reset button to abort change and recover the previous configuration setting.

I WDS Security Setup

Requirement: Set [Wireless]->[Basic Settings]->[Mode]->AP+WDS

This page is used to configure the wireless security between APs.
Refer to [3.3.6 Wireless Security Setup](#).

WDS Security Setup

This page allows you setup the wireless security for WDS. When enabled, you must make sure each WDS device has adopted the same encryption algorithm and Key.

Encryption:

WEP Key Format:

WEP Key:

Pre-Shared Key Format:

Pre-Shared Key:

Screen snapshot – WDS Security Setup

II WDS AP Table

This page is used to show WDS statistics

WDS AP Table

This table shows the MAC address, transmission, reception packet counters and state information for each configured WDS AP.

MAC Address	Tx Packets	Tx Errors	Rx Packets	Tx Rate (Mbps)
00:02:72:81:86:0a	22	0	0	1
00:02:72:81:86:0b	22	14	0	1

Screen snapshot – WDS AP Table

Item	Description
MAC Address	It shows the MAC Address within WDS.
Tx Packets	It shows the statistic count of sent packets on the wireless LAN interface.
Tx Errors	It shows the statistic count of error sent packets on the Wireless LAN interface.
Rx Packets	It shows the statistic count of received packets on the wireless LAN interface.
Tx Rare (Mbps)	It shows the wireless link rate within WDS.
Refresh	Click to refresh the statistic counters on the screen.
Close	Click to close the current window.

3.3.9 Site Survey

This page is used to view or configure other APs near yours.

Wireless Site Survey

This page provides tool to scan the wireless network. If any Access Point or IBSS is found, you could choose to connect it manually when client mode is enabled.

SSID	BSSID	Channel	Type	Encrypt	Signal	Select
MyWLAN	00:02:72:00:81:86	11 (B+G)	AP	no	90	<input type="radio"/>
linux-wlan	00:02:72:f1:02:ad	6 (B)	AP	no	76	<input type="radio"/>
RTL8186-VPN-GW	00:e0:4c:81:86:23	11 (B+G)	AP	no	66	<input type="radio"/>
Sales	00:02:72:04:68:92	11 (B)	AP	yes	53	<input type="radio"/>
Tekom_Office	00:02:72:00:93:fb	9 (B)	AP	yes	35	<input type="radio"/>
alex	d6:4c:fc:0d:2a:d4	1 (B)	Ad hoc	no	32	<input type="radio"/>
MyWLAN	00:02:72:85:15:99	11 (B+G)	AP	no	32	<input type="radio"/>

Screen snapshot – Wireless Site Survey

Item	Description
SSID	It shows the SSID of AP.
BSSID	It shows BSSID of AP.
Channel	It show the current channel of AP occupied.
Type	It show which type AP acts.
Encrypt	It shows the encryption status.
Signal	It shows the power level of current AP.
Select (Client Only)	Click to select AP or client you'd like to connect.
Refresh	Click the Refresh button to re-scan site survey on the screen.
Connect	Click the Connect button to establish connection.

3.3.10 WPS

This page allows you to change the setting for WPS (Wi-Fi Protected Setup). Using this feature could let your wireless client automatically synchronize its setting and connect to the Access Point in a minute without any hassle.

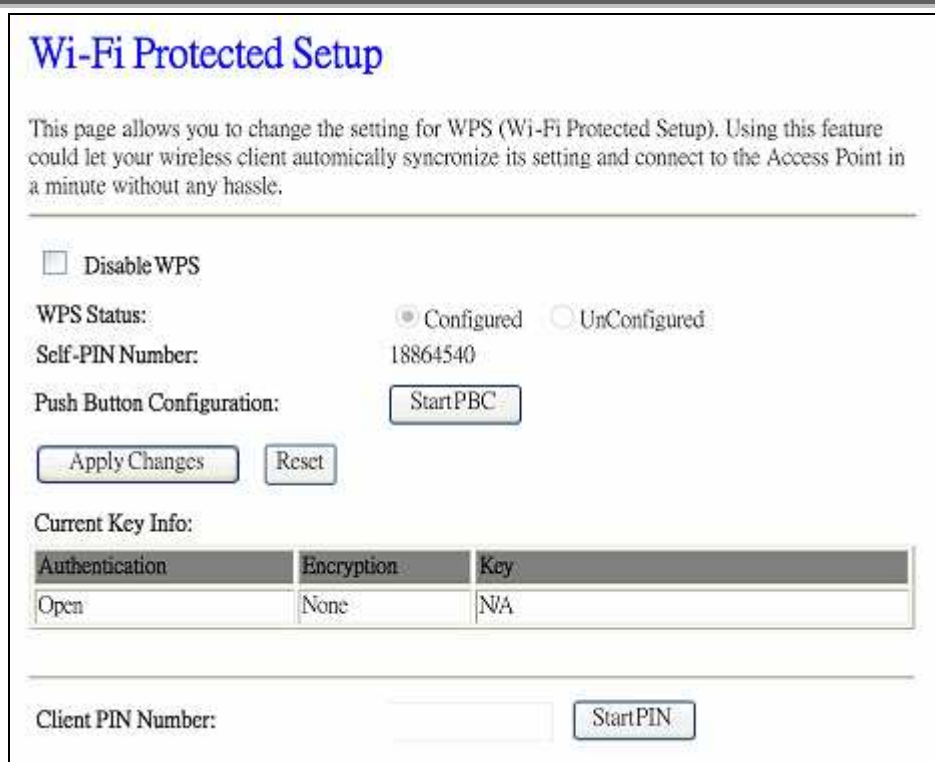

Screen snapshot – Wi-Fi Protected Setup

Item	Description
Disable WPS	Click on to disable the Wi-Fi Protected Setup function.
WPS Status	Show WPS status is Configured or UnConfigured .
Self-PIN Number	Fill in the PIN Number of AP to register the wireless distribution system access capability.
PIN Configuration	The Start PIN button provides tool to scan the wireless network. If any Access Point or IBSS is found, you could connect it automatically when client join WPS mode.
Push Button Configuration	The Start PBC button provides tool to scan the wireless network. If any Access Point or IBSS is found, you could connect it automatically when client join PBC mode.
Apply Changes	Click the Apply Changes button to complete the new configuration setting.
Reset	Click the Reset button to abort change and recover the previous configuration setting.
Current Key Info	Authentication : It shows the Authentication is opened or closed. Encryption : It shows the Encryption mode.

Key : It shows the Encryption key.

3.3.11 Schedule

This page is to configure the wireless activation timestamp by users.

Wireless Schedule

This page allows you setup the wireless schedule rule. Please do not forget to configure system time before enable this feature.

Enable Wireless Schedule

Days :
 Everyday Sun Mon Tue Wed Thu Fri Sat

Time :
 24 Hours From : To :

Screen snapshot – Wireless Schedule

Item	Description
Enable Wireless	Click on to enable the wireless schedule function.
Schedule	
Days	Click the one or more of days to set the rules.
Time	Click 24 hrs or set the starting time and ending time.
Apply Changes	Click the Apply Changes button to complete the new configuration setting.
Reset	Click the Reset button to abort change and recover the previous configuration setting.

3.3.12 LAN Interface Setup

This page is used to configure the parameters for local area network that connects to the LAN ports of your WLAN Broadband Router. Here you may change the setting for IP address, subnet mask, DHCP, etc.

LAN Interface Setup

This page is used to configure the parameters for local area network which connects to the LAN port of your Access Point. Here you may change the setting for IP address, subnet mask, DHCP, etc..

IP Address:

Subnet Mask:

DHCP:

DHCP Client Range: -

Static DHCP:

Domain Name:

802.1d Spanning Tree:

Clone MAC Address:

Screen snapshot – LAN Interface Setup

Item	Description
IP Address	Fill in the IP address of LAN interfaces of this WLAN Access Point.
Subnet Mask	Fill in the subnet mask of LAN interfaces of this WLAN Access Point.
DHCP	Click to select <i>Disabled</i> , <i>Client</i> or <i>Server</i> in different operation mode of wireless Access Point.
DHCP Client Range	Fill in the start IP address and end IP address to allocate a range of IP addresses; client with DHCP function set will be assigned an IP address from the range.
Show Client	Click to open the <i>Active DHCP Client Table</i> window that shows the active clients with their assigned IP address, MAC address and time expired information. [Server mode only]
Static DHCP	Select enable or disable the Static DHCP function from pull-down menu. [Server mode only]
Set Static DHCP	Manual setup Static DHCP IP address for specific MAC address. [Server mode only]

Domain Name	Assign Domain Name and dispatch to DHCP clients. It is optional field.
802.1d Spanning Tree	Select enable or disable the IEEE 802.1d Spanning Tree function from pull-down menu.
Clone MAC Address	Fill in the MAC address that is the MAC address to be cloned. Refer to 4.24 What is Clone MAC Address?
Apply Changes	Click the Apply Changes button to complete the new configuration setting.
Reset	Click the Reset button to abort change and recover the previous configuration setting.

I Static DHCP Setup

The screenshot shows the 'Static DHCP Setup' configuration page. At the top, there is a checkbox labeled 'Enable Static DHCP'. Below this are three input fields: 'IP Address', 'MAC Address', and 'Comment'. Underneath the input fields are two buttons: 'Apply Changes' and 'Reset'. A section titled 'Static DHCP List' contains a table with four columns: 'IP Address', 'MAC Address', 'Comment', and 'Select'. Below the table are three buttons: 'Delete Selected', 'Delete All', and 'Reset'.

Screen snapshot – Static DHCP Setup

Item	Description
Enable Static DHCP	Click on to Enable the Static DHCP Setup function.
IP Address	If you select the Set Static DHCP on LAN interface, fill in the IP address for it.
MAC Address	If you select the Set Static DHCP on LAN interface, fill in the MAC address for it.
Comment	Fill in the comment tag for the registered Static DHCP.
Apply Changes	Click the Apply Changes button to complete the new configuration setting.
Reset	Click the Reset button to abort change and recover the previous configuration setting.
Static DHCP List	It shows IP Address 、 MAC Address from the Static

DHCP.	
Delete Selected	Click to delete the selected clients that will be removed from the Static DHCP list.
Delete All	Click to delete all the registered clients from the Static DHCP list.
Reset	Click the Reset button to abort change and recover the previous configuration setting.

3.3.13 WAN Interface Setup

This page is used to configure the parameters for wide area network that connects to the WAN port of your WLAN Broadband Router. Here you may change the access method to **Static IP**, **DHCP**, **PPPoE**, **PPTP** or **L2TP** by click the item value of **WAN Access Type**.

I Static IP

WAN Interface Setup

This page is used to configure the parameters for Internet network which connects to the WAN port of your Access Point. Here you may change the access method to static IP, DHCP, PPPoE, PPTP or L2TP by click the item value of WAN Access type.

WAN Access Type: Static IP

IP Address: 172.1.1.1

Subnet Mask: 255.255.255.0

Default Gateway: 172.1.1.254

MTU Size: 1500 (1400-1500 bytes)

DNS 1:

DNS 2:

DNS 3:

Clone MAC Address: 000000000000

Enable uPNP

Enable IGMP Proxy

Enable Ping Access on WAN

Enable Web Server Access on WAN

Enable IPsec pass through on VPN connection

Enable PPTP pass through on VPN connection

Enable L2TP pass through on VPN connection

Apply Changes
Reset

Screen snapshot – WAN Interface Setup – Static IP

Item	Description
Static IP	Click to select Static IP support on WAN interface. There are IP address, subnet mask and default gateway settings need to be done.
IP Address	If you select the Static IP support on WAN interface, fill in the IP address for it.
Subnet Mask	If you select the Static IP support on WAN interface, fill in the subnet mask for it.
Default Gateway	If you select the Static IP support on WAN interface, fill in the default gateway for WAN interface out going data

	packets.
MTU Size	Fill in the mtu size of MTU Size. The default value is 1500
DNS 1	Fill in the IP address of Domain Name Server 1.
DNS 2	Fill in the IP address of Domain Name Server 2.
DNS 3	Fill in the IP address of Domain Name Server 3.
Clone MAC Address	Fill in the MAC address that is the MAC address to be cloned. Refer to 4.24 What is Clone MAC Address?
Enable uPNP	Click the checkbox to enable uPNP function. Refer to 4.22 What is Universal Plug and Play (uPNP)?
Enable IGMP Proxy	Click the checkbox to enable IGMP Proxy.
Enable Ping Access on WAN	Click the checkbox to enable WAN ICMP response.
Enable Web Server Access on WAN	Click the checkbox to enable web configuration from WAN side.
Enable IPsec pass through on VPN connection	Click the checkbox to enable IPsec packet pass through
Enable PPTP pass through on VPN connection	Click the checkbox to enable PPTP packet pass through
Enable L2TP pass through on VPN connection	Click the checkbox to enable L2TP packet pass through
Apply Changes	Click the Apply Changes button to complete the new configuration setting.
Reset	Click the Reset button to abort change and recover the previous configuration setting.

II DHCP Client

WAN Interface Setup

This page is used to configure the parameters for Internet network which connects to the WAN port of your Access Point. Here you may change the access method to static IP, DHCP, PPPoE, PPTP or L2TP by click the item value of WAN Access type.

WAN Access Type: DHCP Client ▾

Host Name:

MTU Size: 1492 (1400-1492 bytes)

Attain DNS Automatically
 Set DNS Manually

DNS 1:

DNS 2:

DNS 3:

Clone MAC Address: 000000000000

Enable uPNP
 Enable IGMP Proxy
 Enable Ping Access on WAN
 Enable Web Server Access on WAN
 Enable IPsec pass through on VPN connection
 Enable PPTP pass through on VPN connection
 Enable L2TP pass through on VPN connection

Apply Changes
Reset

Screen snapshot – WAN Interface Setup – DHCP Client

Item	Description
DHCP Client	Click to select DHCP support on WAN interface for IP address assigned automatically from a DHCP server.
Host Name	Fill in the host name of Host Name. The default value is empty
MTU Size	Fill in the mtu size of MTU Size. The default value is 1492
Attain DNS Automatically	Click to select getting DNS address for DHCP support. Please select Set DNS Manually if the DHCP support is selected.
Set DNS Manually	Click to select getting DNS address for DHCP support.

DNS 1	Fill in the IP address of Domain Name Server 1.
DNS 2	Fill in the IP address of Domain Name Server 2.
DNS 3	Fill in the IP address of Domain Name Server 3.
Clone MAC Address	Fill in the MAC address that is the MAC address to be cloned. Refer to 4.24 What is Clone MAC Address?
Enable uPNP	Click the checkbox to enable uPNP function. Refer to 4.22 What is Universal Plug and Play (uPNP)?
Enable IGMP Proxy	Click the checkbox to enable IGMP Proxy.
Enable Ping Access on WAN	Click the checkbox to enable WAN ICMP response.
Enable Web Server Access on WAN	Click the checkbox to enable web configuration from WAN side.
Apply Changes	Click the Apply Changes button to complete the new configuration setting.
Reset	Click the Reset button to abort change and recover the previous configuration setting.

III PPPoE

WAN Interface Setup

This page is used to configure the parameters for Internet network which connects to the WAN port of your Access Point. Here you may change the access method to static IP, DHCP, PPPoE, PPTP or L2TP by click the item value of WAN Access type.

WAN Access Type: PPPoE ▼

User Name:

Password:

Service Name:

Connection Type: Continuous ▼

Idle Time: 5 (1-1000 minutes)

MTU Size: 1452 (1360-1492 bytes)

Attain DNS Automatically

Set DNS Manually

DNS 1:

DNS 2:

DNS 3:

Clone MAC Address: 000000000000

Enable uPNP

Enable IGMP Proxy

Enable Ping Access on WAN

Enable Web Server Access on WAN

Enable IPsec pass through on VPN connection

Enable PPTP pass through on VPN connection

Enable L2TP pass through on VPN connection

Screen snapshot – WAN Interface Setup – PPPoE

Item	Description
PPPoE	Click to select PPPoE support on WAN interface. There are user name, password, connection type and idle time settings need to be done.
User Name	If you select the PPPoE support on WAN interface, fill in the user name and password to login the PPPoE server.

Password	If you select the PPPoE support on WAN interface, fill in the user name and password to login the PPPoE server.
Service Name	Fill in the service name of Service Name. The default value is empty.
Connection Type	Select the connection type from pull-down menu. There are <i>Continuous</i> , <i>Connect on Demand</i> and <i>Manual</i> three types to select. <i>Continuous</i> connection type means to setup the connection through PPPoE protocol whenever this WLAN Broadband Router is powered on. <i>Connect on Demand</i> connection type means to setup the connection through PPPoE protocol whenever you send the data packets out through the WAN interface; there are a watchdog implemented to close the PPPoE connection while there are no data sent out longer than the idle time set. <i>Manual</i> connection type means to setup the connection through the PPPoE protocol by clicking the <i>Connect</i> button manually, and clicking the <i>Disconnect</i> button manually.
Idle Time	If you select the <i>PPPoE</i> and <i>Connect on Demand</i> connection type, fill in the idle time for auto-disconnect function. Value can be between 1 and 1000 minutes.
MTU Size	Fill in the mtu size of MTU Size. The default value is 1452. Refer to 4.23 What is Maximum Transmission Unit (MTU) Size?
Attain DNS Automatically	Click to select getting DNS address for <i>PPPoE</i> support. Please select <i>Set DNS Manually</i> if the <i>PPPoE</i> support is selected.
Set DNS Manually	Click to select getting DNS address for <i>Static IP</i> support.
DNS 1	Fill in the IP address of Domain Name Server 1.
DNS 2	Fill in the IP address of Domain Name Server 2.
DNS 3	Fill in the IP address of Domain Name Server 3.
Clone MAC Address	Fill in the MAC address that is the MAC address to be cloned. Refer to 4.24 What is Clone MAC Address?
Enable uPNP	Click the checkbox to enable uPNP function.

Refer to [4.22 What is Universal Plug and Play \(uPNP\)?](#)

Enable IGMP Proxy	Click the checkbox to enable IGMP Proxy.
Enable Ping Access on WAN	Click the checkbox to enable WAN ICMP response.
Enable Web Server Access on WAN	Click the checkbox to enable web configuration from WAN side.
Apply Changes	Click the Apply Changes button to complete the new configuration setting.
Reset	Click the Reset button to abort change and recover the previous configuration setting.

IV PPTP

WAN Interface Setup

This page is used to configure the parameters for Internet network which connects to the WAN port of your Access Point. Here you may change the access method to static IP, DHCP, PPPoE, PPTP or L2TP by click the item value of WAN Access type.

WAN Access Type: PPTP

Enable Dynamic Mode

IP Address: 172.1.1.2

Subnet Mask: 255.255.255.0

Gateway: 172.1.1.254

Server IP Address: 172.1.1.1

Server Domain Name :

User Name:

Password:

Connection Type: Continuous

Idle Time: 5 (1-1000 minutes)

MTU Size: 1460 (1400-1460 bytes)

Request MPPE Encryption **Request MPPC Compression**

Attain DNS Automatically

Set DNS Manually

DNS 1:

DNS 2:

DNS 3:

Clone MAC Address: 000000000000

Enable uPNP

Enable IGMP Proxy

Enable Ping Access on WAN

Enable Web Server Access on WAN

Enable IPsec pass through on VPN connection

Enable PPTP pass through on VPN connection

Enable L2TP pass through on VPN connection

Apply Changes Reset

Screen snapshot – WAN Interface Setup – PPTP

Item	Description
PPTP	Allow user to make a tunnel with remote site directly to secure the data transmission among the connection. User

	can use embedded PPTP client supported by this router to make a VPN connection.
Enable Dynamic Mode	Click the checkbox to enable Dynamic PPTP function.
IP Address	If you select the PPTP support on WAN interface, fill in the IP address for it.
Subnet Mask	If you select the PPTP support on WAN interface, fill in the subnet mask for it.
Server IP Address	Enter the IP address of the PPTP Server.
Server Domain Name	Input domain name to resolve DHCP server.
User Name	If you select the PPTP support on WAN interface, fill in the user name and password to login the PPTP server.
Password	If you select the PPTP support on WAN interface, fill in the user name and password to login the PPTP server.
Connection Type	Select the connection type from pull-down menu. There are <i>Continuous</i> , <i>Connect on Demand</i> and <i>Manual</i> three types to select. <i>Continuous</i> connection type means to setup the connection through PPTP protocol whenever this WLAN Broadband Router is powered on. <i>Connect on Demand</i> connection type means to setup the connection through PPTP protocol whenever you send the data packets out through the WAN interface; there are a watchdog implemented to close the PPTP connection while there are no data sent out longer than the idle time set. <i>Manual</i> connection type means to setup the connection through the PPTP protocol by clicking the <i>Connect</i> button manually, and clicking the <i>Disconnect</i> button manually.
Idle Time	If you select the <i>PPTP</i> and <i>Connect on Demand</i> connection type, fill in the idle time for auto-disconnect function. Value can be between 1 and 1000 minutes.
MTU Size	Fill in the mtu size of MTU Size. The default value is 1460. Refer to 4.23 What is Maximum Transmission Unit (MTU) Size?
Request MPPE	Click the checkbox to enable request MPPE encryption.

Encryption	
Request MPPC Compression	Click the checkbox to enable request MPPC compression.
Attain DNS Automatically	Click to select getting DNS address for PPTP support. Please select Set DNS Manually if the PPTP support is selected.
Set DNS Manually	Click to select getting DNS address for PPTP support.
DNS 1	Fill in the IP address of Domain Name Server 1.
DNS 2	Fill in the IP address of Domain Name Server 2.
DNS 3	Fill in the IP address of Domain Name Server 3.
Clone MAC Address	Fill in the MAC address that is the MAC address to be cloned. Refer to 4.24 What is Clone MAC Address?
Enable uPNP	Click the checkbox to enable uPNP function. Refer to 4.22 What is Universal Plug and Play (uPNP)?
Enable IGMP Proxy	Click the checkbox to enable IGMP Proxy.
Enable Ping Access on WAN	Click the checkbox to enable WAN ICMP response.
Enable Web Server Access on WAN	Click the checkbox to enable web configuration from WAN side.
Apply Changes	Click the Apply Changes button to complete the new configuration setting.
Reset	Click the Reset button to abort change and recover the previous configuration setting.

V L2TP

WAN Interface Setup

This page is used to configure the parameters for Internet network which connects to the WAN port of your Access Point. Here you may change the access method to static IP, DHCP, PPPoE, PPTP or L2TP by click the item value of WAN Access type.

WAN Access Type: L2TP

IP Address: 172.1.1.2

Subnet Mask: 255.255.255.0

Server IP Address: 172.1.1.1

User Name:

Password:

Connection Type: Continuous

Idle Time: 5 (1-1000 minutes)

MTU Size: 1460 (1400-1460 bytes)

Attain DNS Automatically

Set DNS Manually

DNS 1:

DNS 2:

DNS 3:

Clone MAC Address: 000000000000

Enable uPNP

Enable IGMP Proxy

Enable Ping Access on WAN

Enable Web Server Access on WAN

Enable IPsec pass through on VPN connection

Enable PPTP pass through on VPN connection

Enable L2TP pass through on VPN connection

Apply Changes Reset

Screen snapshot – WAN Interface Setup – PPTP

Item	Description
L2TP	Allow user to make a tunnel with remote site directly to secure the data transmission among the connection. User can use embedded L2TP client supported by this router to make a VPN connection.

IP Address	If you select the L2TP support on WAN interface, fill in the IP address for it.
Subnet Mask	If you select the L2TP support on WAN interface, fill in the subnet mask for it.
Gateway	If you select the Static L2TP support on WAN interface, fill in the gateway for WAN interface out going data packets.
Server IP Address	Enter the IP address of the L2TP Server.
User Name	If you select the L2TP support on WAN interface, fill in the user name and password to login the L2TP server.
Password	If you select the L2TP support on WAN interface, fill in the user name and password to login the L2TP server.
Connection Type	Select the connection type from pull-down menu. There are <i>Continuous</i> , <i>Connect on Demand</i> and <i>Manual</i> three types to select. <i>Continuous</i> connection type means to setup the connection through L2TP protocol whenever this WLAN Broadband Router is powered on. <i>Connect on Demand</i> connection type means to setup the connection through L2TP protocol whenever you send the data packets out through the WAN interface; there are a watchdog implemented to close the L2TP connection while there are no data sent out longer than the idle time set. <i>Manual</i> connection type means to setup the connection through the L2TP protocol by clicking the <i>Connect</i> button manually, and clicking the <i>Disconnect</i> button manually.
Idle Time	If you select the <i>L2TP</i> and <i>Connect on Demand</i> connection type, fill in the idle time for auto-disconnect function. Value can be between 1 and 1000 minutes.
MTU Size	Fill in the mtu size of MTU Size. The default value is 1460. Refer to 4.23 What is Maximum Transmission Unit (MTU) Size?
Attain DNS Automatically	Click to select getting DNS address for <i>L2TP</i> support. Please select <i>Set DNS Manually</i> if the <i>L2TP</i> support is

	selected.
Set DNS Manually	Click to select getting DNS address for L2TP support.
DNS 1	Fill in the IP address of Domain Name Server 1.
DNS 2	Fill in the IP address of Domain Name Server 2.
DNS 3	Fill in the IP address of Domain Name Server 3.
Clone MAC Address	Fill in the MAC address that is the MAC address to be cloned. Refer to 4.24 What is Clone MAC Address?
Enable uPNP	Click the checkbox to enable uPNP function. Refer to 4.22 What is Universal Plug and Play (uPNP)?
Enable IGMP Proxy	Click the checkbox to enable IGMP Proxy.
Enable Ping Access on WAN	Click the checkbox to enable WAN ICMP response.
Enable Web Server Access on WAN	Click the checkbox to enable web configuration from WAN side.
Apply Changes	Click the Apply Changes button to complete the new configuration setting.
Reset	Click the Reset button to abort change and recover the previous configuration setting.

3.3.14 Firewall - Port Filtering

Entries in this table are used to restrict certain types of data packets from your local network to Internet through the Gateway. Use of such filters can be helpful in securing or restricting your local network.

Port Filtering

Entries in this table are used to restrict certain types of data packets from your local network to Internet through the Gateway. Use of such filters can be helpful in securing or restricting your local network.

Enable Port Filtering
 Port Range: - Protocol: Both Comment:

Current Filter Table:

Port Range	Protocol	Comment	Select
20-21	TCP-UDP	FTP	<input type="checkbox"/>

Screen snapshot – Firewall - Port Filtering

Item	Description
Enable Port Filtering	Click to enable the port filtering security function.
Port Range	To restrict data transmission from the local network on certain ports, fill in the range of start-port and end-port, and the protocol, also put your comments on it.
Protocol	The <i>Protocol</i> can be TCP, UDP or Both.
Comments	<i>Comments</i> let you know about whys to restrict data from the ports.
Apply Changes	Click the <i>Apply Changes</i> button to register the ports to port filtering list.
Reset	Click the <i>Reset</i> button to abort change and recover the previous configuration setting.
Delete Selected	Click to delete the selected port range that will be removed from the port-filtering list.
Delete All	Click to delete all the registered entries from the port-filtering list.
Reset	Click the <i>Reset</i> button to abort change and recover the previous configuration setting.

3.3.15 Firewall - IP Filtering

Entries in this table are used to restrict certain types of data packets from your local network to Internet through the Gateway. Use of such filters can be helpful in securing or restricting your local network.

IP Filtering

Entries in this table are used to restrict certain types of data packets from your local network to Internet through the Gateway. Use of such filters can be helpful in securing or restricting your local network.

Enable IP Filtering
 Local IP Address: Protocol: Both Comment:

Current Filter Table:

Local IP Address	Protocol	Comment	Select
192.168.1.201	TCP+UDP	ST-1	<input type="checkbox"/>
192.168.1.202	TCP	ST-2	<input type="checkbox"/>

Screen snapshot – Firewall - IP Filtering

Item	Description
Enable IP Filtering	Click to enable the IP filtering security function.
Local IP Address	To restrict data transmission from local network on certain IP addresses, fill in the IP address and the
Protocol	protocol, also put your comments on it.
Comments	The Protocol can be TCP, UDP or Both. Comments let you know about whys to restrict data from the IP address.
Apply Changes	Click the Apply Changes button to register the IP address to IP filtering list.
Reset	Click the Reset button to abort change and recover the previous configuration setting.
Delete Selected	Click to delete the selected IP address that will be removed from the IP-filtering list.
Delete All	Click to delete all the registered entries from the IP-filtering list.
Reset	Click the Reset button to abort change and recover the previous configuration setting.

3.3.16 Firewall - MAC Filtering

Entries in this table are used to restrict certain types of data packets from your local network to Internet through the Gateway. Use of such filters can be

helpful in securing or restricting your local network.

MAC Filtering

Entries in this table are used to restrict certain types of data packets from your local network to Internet through the Gateway. Use of such filters can be helpful in securing or restricting your local network.

Enable MAC Filtering

MAC Address: Comment:

Current Filter Table:

MAC Address	Comment	Select
00:02:72:00:81:90	ST-1	<input type="checkbox"/>
00:02:72:00:81:91	ST-2	<input type="checkbox"/>

Screen snapshot – Firewall - MAC Filtering

Item	Description
Enable MAC Filtering	Click to enable the MAC filtering security function.
MAC Address	To restrict data transmission from local network on certain MAC addresses, fill in the MAC address and your comments on it.
Comments	Comments let you know about whys to restrict data from the MAC address.
Apply Changes	Click the Apply Changes button to register the MAC address to MAC filtering list.
Reset	Click the Reset button to abort change and recover the previous configuration setting.
Delete Selected	Click to delete the selected MAC address that will be removed from the MAC-filtering list.
Delete All	Click to delete all the registered entries from the MAC-filtering list.
Reset	Click the Reset button to abort change and recover the previous configuration setting.

3.3.17 Firewall - Port Forwarding

Entries in this table allow you to automatically redirect common network

services to a specific machine behind the NAT firewall. These settings are only necessary if you wish to host some sort of server like a web server or mail server on the private local network behind your Gateway's NAT firewall.

Port Forwarding

Entries in this table allow you to automatically redirect common network services to a specific machine behind the NAT firewall. These settings are only necessary if you wish to host some sort of server like a web server or mail server on the private local network behind your Gateway's NAT firewall.

Enable Port Forwarding
 IP Address: Protocol: Both Port Range: - Comment:

Current Port Forwarding Table:

Local IP Address	Protocol	Port Range	Comment	Select
192.168.1.201	TCP+UDP	20-21	FTP	<input type="checkbox"/>

Screen snapshot – Firewall - Port Forwarding

Item	Description
Enable Port Forwarding	Click to enable the Port Forwarding security function.
IP Address	To forward data packets coming from WAN to a specific IP address that hosted in local network behind the NAT firewall, fill in the IP address, protocol, port range and your comments.
Protocol	The <i>Protocol</i> can be TCP, UDP or Both.
Port Range	The <i>Port Range</i> for data transmission.
Comment	<i>Comments</i> let you know about whys to allow data packets forward to the IP address and port number.
Apply Changes	Click the <i>Apply Changes</i> button to register the IP address and port number to Port forwarding list.
Reset	Click the <i>Reset</i> button to abort change and recover the previous configuration setting.
Delete Selected	Click to delete the selected IP address and port number that will be removed from the port-forwarding list.
Delete All	Click to delete all the registered entries from the

port-forwarding list.

Reset Click the **Reset** button to abort change and recover the previous configuration setting.

3.3.18 Firewall – URL Filtering

URL Filtering is used to restrict users to access specific websites in internet.

Screen snapshot – Firewall – URL Filtering

Item	Description
Enable URL Filtering	Click to enable the URL Filtering function.
URL Address	Add one URL address.
Apply Changes	Click the Apply Changes button to save settings.
Reset	Click the Reset button to abort change and recover the previous configuration setting.
Delete Selected	Click to delete the selected URL address that will be removed from the URL Filtering list.
Delete All	Click to delete all the registered entries from the URL Filtering list.
Reset	Click the Reset button to abort change and recover the previous configuration setting.

3.3.19 Firewall - DMZ

A Demilitarized Zone is used to provide Internet services without sacrificing unauthorized access to its local private network. Typically, the DMZ host contains devices accessible to Internet traffic, such as Web (HTTP) servers, FTP servers, SMTP (e-mail) servers and DNS servers.



Screen snapshot – Firewall - DMZ

Item	Description
Enable DMZ	Click to enable the DMZ function.
DMZ Host IP Address	To support DMZ in your firewall design, fill in the IP address of DMZ host that can be access from the WAN interface.
Apply Changes	Click the Apply Changes button to register the IP address of DMZ host.
Reset	Click the Reset button to abort change and recover the previous configuration setting.

3.3.20 QoS

This page sets bandwidth control by IP or Mac address.

QoS

Entries in this table improve your online gaming experience by ensuring that your game traffic is prioritized over other network traffic, such as FTP or Web.

Enable QoS

Automatic Uplink Speed

Manual Uplink Speed (Kbps):

Automatic Downlink Speed

Manual Downlink Speed (Kbps):

QoS Rule Setting:

Address Type: IP MAC

Local IP Address: -

MAC Address:

Mode: ▾

Uplink Bandwidth (Kbps):

Downlink Bandwidth (Kbps):

Comment:

Current QoS Rules Table:

Local IP Address	MAC Address	Mode	Uplink Bandwidth	Downlink Bandwidth	Comment	Select
192.168.1.100 - 192.168.1.105	---	Guaranteed minimum bandwidth	50	100	G-1	<input type="checkbox"/>

Screen snapshot – QoS

Item	Description
Enable QoS	Click to enable the QoS function.
Automatic Uplink Speed	Click checkbox to enable Uplink speed by system.
Manual Uplink Speed (Kbps)	Input number to set Uplink speed.
Automatic Downlink Speed	Click checkbox to enable Downlink speed by system.

Manual Downlink Speed (Kbps)	Input number to set Downlink speed.
Access Type	Click the set type either IP or Mac address.
Local IP address	Input the range IP address of LAN.
MAC address	Input MAC address.
Mode	There are 2 options to control the bandwidth. One is Guaranteed minimum bandwidth . The other is Restricted maximum bandwidth .
Uplink Bandwidth (Kbps)	Set Uplink bandwidth for range of IP addresses or specific MAC address
Downlink Bandwidth (Kbps)	Set Downlink bandwidth for range of IP addresses or specific MAC address
Comment	Comments let you to remind your settings easily.
Apply Changes	Click the Apply Changes button to add settings to the list.
Reset	Click the Reset button to abort change and recover the previous configuration setting.

3.3.21 Management - Statistics

This page shows the packet counters for transmission and reception regarding to wireless, Ethernet LAN and Ethernet WAN networks.

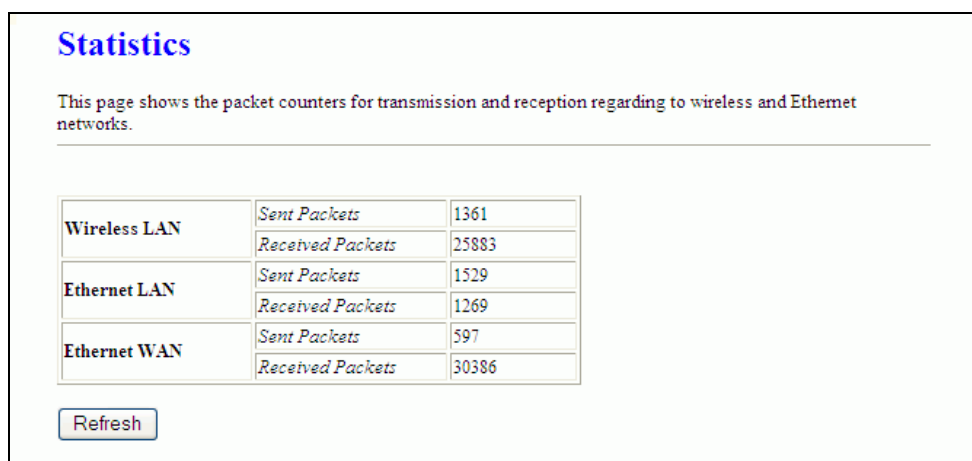

Screen snapshot – Management - Statistics

Item	Description
------	-------------

Wireless LAN <i>Sent Packets</i>	It shows the statistic count of sent packets on the wireless LAN interface.
Wireless LAN <i>Received Packets</i>	It shows the statistic count of received packets on the wireless LAN interface.
Ethernet LAN <i>Sent Packets</i>	It shows the statistic count of sent packets on the Ethernet LAN interface.
Ethernet LAN <i>Received Packets</i>	It shows the statistic count of received packets on the Ethernet LAN interface.
Ethernet WAN <i>Sent Packets</i>	It shows the statistic count of sent packets on the Ethernet WAN interface.
Ethernet WAN <i>Received Packets</i>	It shows the statistic count of received packets on the Ethernet WAN interface.
Refresh	Click the refresh the statistic counters on the screen.

3.3.22 Management - DDNS

This page is used to configure Dynamic DNS service to have DNS with dynamic IP address.

Dynamic DNS Setting

Dynamic DNS is a service, that provides you with a valid, unchanging, internet domain name (an URL) to go with that (possibly everchanging) IP-address.

Enable DDNS

Service Provider :

Domain Name :

User Name/Email:

Password/Key:

Note:
 For TZO, you can have a 30 days free trial [here](#) or manage your TZO account in [control panel](#)
 For DynDNS, you can create your DynDNS account [here](#)

Screen snapshot – Management – DDNS

Item	Description
Enable DDNS	Click the checkbox to enable DDNS service. Refer to 4.25 What is DDNS?
Service Provider	Click the drop down menu to pickup the right provider.
Domain Name	To configure the Domain Name.
User Name/Email	Configure User Name, Email.
Password/Key	Configure Password, Key.
Apply Change	Click the Apply Changes button to save the enable DDNS service.
Reset	Click the Reset button to abort change and recover the previous configuration setting.

3.3.23 Management - Time Zone Setting

This page is used to configure NTP client to get current time.

Time Zone Setting

You can maintain the system time by synchronizing with a public time server over the Internet.

Current Time : Yr Mon Day Hr Mn Sec

Time Zone Select :

Enable NTP client update

NTP server :
 (Manual IP Setting)

Screen snapshot – Management – Time Zone Settings

Item	Description
Current Time	It shows the current time.
Time Zone Select	Click the time zone in your country.
Enable NTP client	Click the checkbox to enable NTP client update. Refer to

update	4.26 What is NTP Client?
NTP Server	Click select default or input NTP server IP address.
Apply Change	Click the Apply Changes button to save and enable NTP client service.
Reset	Click the Reset button to abort change and recover the previous configuration setting.
Refresh	Click the refresh the current time shown on the screen.

3.3.24 Management – Denial-of-Service

This page is used to enable and setup protection to prevent attack by hacker's program. It provides more security for users.

Denial of Service

A "denial-of-service" (DoS) attack is characterized by an explicit attempt by hackers to prevent legitimate users of a service from using that service.

Enable DoS Prevention

- Whole System Flood: SYN** **Packets/Second**
- Whole System Flood: FIN** **Packets/Second**
- Whole System Flood: UDP** **Packets/Second**
- Whole System Flood: ICMP** **Packets/Second**
- Per-Source IP Flood: SYN** **Packets/Second**
- Per-Source IP Flood: FIN** **Packets/Second**
- Per-Source IP Flood: UDP** **Packets/Second**
- Per-Source IP Flood: ICMP** **Packets/Second**
- TCP/UDP PortScan** **Sensitivity**
- ICMP Smurf**
- IP Land**
- IP Spoof**
- IP TearDrop**
- PingOfDeath**
- TCP Scan**
- TCP SynWithData**
- UDP Bomb**
- UDP EchoChargen**

Enable Source IP Blocking **Block time (sec)**

Screen snapshot – Management – Denial-of-Service

Item	Description
Enable DoS Prevention	Click the checkbox to enable DoS prevention.
Whole System Flood / Per-Source IP Flood...	Enable and setup prevention in details.
Select ALL	Click the checkbox to enable all prevention items.
Clear ALL	Click the checkbox to disable all prevention items.
Apply Changes	Click the <i>Apply Changes</i> button to save above settings.

3.3.25 Management - Log

This page is used to configure the remote log server and shown the current log.

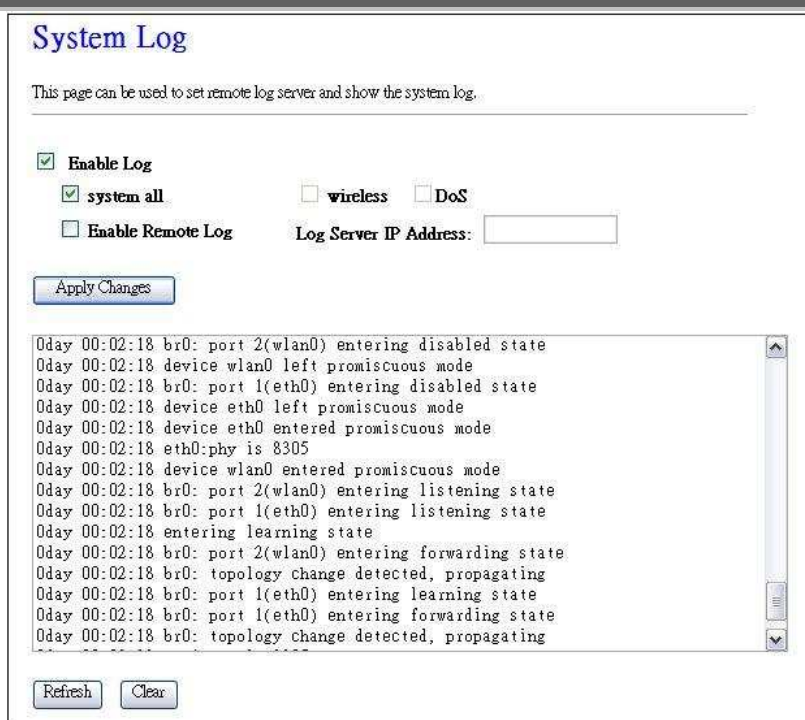

Screen snapshot – Management – Log

Item	Description
Enable Log	Click the checkbox to enable log.
<i>System all</i>	Show all log of wireless broadband router
<i>Wirelessy</i>	Only show wireless log
<i>DoS</i>	Only show Denial-of-Service log
<i>Enable Remote Log</i>	Click the checkbox to enable remote log service.
<i>Log Server IP Address</i>	Input the remote log IP address
Apply Changes	Click the Apply Changes button to save above settings.
Refresh	Click the refresh the log shown on the screen.
Clear	Clear log display screen

3.3.26 Management - Upgrade Firmware

This page allows you upgrade the Access Point firmware to new version. Please note, do not power off the device during the upload because it may crash the system.

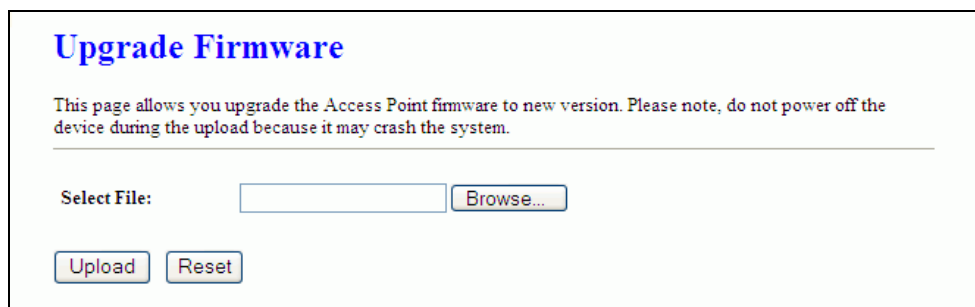

Screen snapshot – Management - Upgrade Firmware

Item	Description
Select File	Click the Browse button to select the new version of web firmware image file.
Upload	Click the Upload button to update the selected web firmware image to the WLAN Broadband Router.
Reset	Click the Reset button to abort change and recover the previous configuration setting.

3.3.27 Management Save/ Reload Settings

This page allows you save current settings to a file or reload the settings from the file that was saved previously. Besides, you could reset the current configuration to factory default.

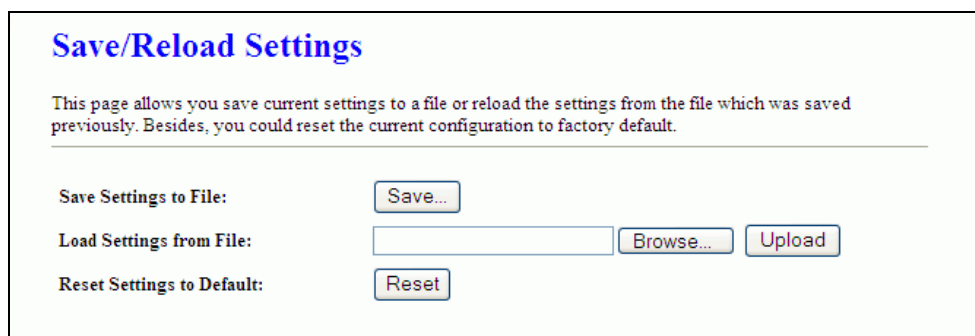

Screen snapshot – Management - Save/Reload Settings

Item	Description
Save Settings to File	Click the Save button to download the configuration parameters to your personal computer.
Load Settings from File	Click the Browse button to select the configuration files

then click the **Upload** button to update the selected configuration to the WLAN Broadband Router.

Reset Settings to Default Click the **Reset** button to reset the configuration parameter to factory defaults.

3.3.28 Management - Password Setup

This page is used to set the account to access the web server of Access Point. Empty user name and password will disable the protection.

Screen snapshot – Management - Password Setup

Item	Description
User Name	Fill in the user name for web management login control.
New Password	Fill in the password for web management login control.
Confirmed Password	Because the password input is invisible, so please fill in the password again for confirmation purpose.
Apply Changes	Clear the User Name and Password fields to empty, means to apply no web management login control. Click the Apply Changes button to complete the new configuration setting.
Reset	Click the Reset button to abort change and recover the previous configuration setting.

3.3.29 Management – Watchdog Setting

This page is used to do watchdog function using ping command. User set IP address, interval and ping fail count conditions to decide whether router reboots or not.

WatchDog Setting

Use ping command to identify whether the router is functional or not. User has to set IP address, interval and fail count to decide reboot router.

Enable WatchDog

WatchDog IP Address:

Ping Interval: (30-600 seconds)

Ping Fail to reboot Counter: (3-30)

Screen snapshot – Management – WatchDog Setting

Item	Description
Enable WatchDog	Click to enable watchdog.
WatchDog IP Address	IP address that is referred.
Ping Interval	Fill in the value by seconds.
Ping Fail to reboot Count	Fill in the value that is the threshold to reboot router when ping fails.
Apply Changes	Click the Apply Changes button to complete the new configuration setting.
Reset	Click the Reset button to abort change and recover the previous configuration setting.

4 Frequently Asked Questions (FAQ)

4.1 What and how to find my PC's IP and MAC address?

IP address is the identifier for a computer or device on a TCP/IP network. Networks using the TCP/IP protocol route messages based on the IP address of the destination. The format of an IP address is a 32-bit numeric address written as four numbers separated by periods. Each number can be zero to 255. For example, 191.168.1.254 could be an IP address.

The MAC (Media Access Control) address is your computer's unique hardware number. (On an Ethernet LAN, it's the same as your Ethernet address.) When you're connected to the Internet from your computer (or host as the Internet protocol thinks of it), a correspondence table relates your IP address to your computer's physical (MAC) address on the LAN.

To find your PC's IP and MAC address,

- ✓ Open the Command program in the Microsoft Windows.
 - ✓ Type in *ipconfig /all* then press the *Enter* button.
- Your PC's IP address is the one entitled IP Address and your PC's MAC address is the one entitled Physical Address.

4.2 What is Wireless LAN?

A wireless LAN (WLAN) is a network that allows access to Internet without the need for any wired connections to the user's machine.

4.3 What are ISM bands?

ISM stands for Industrial, Scientific and Medical; radio frequency bands that the Federal Communications Commission (FCC) authorized for wireless LANs. The ISM bands are located at 915 +/- 13 MHz, 2450 +/- 50 MHz and 5800 +/- 75 MHz.

4.4 How does wireless networking work?

The 802.11 standard define two modes: infrastructure mode and ad hoc mode. In infrastructure mode, the wireless network consists of at least one access point connected to the wired network infrastructure and a set of wireless end stations. This configuration is called a Basic Service Set (BSS). An Extended Service Set (ESS) is a set of two or

more BSSs forming a single subnetwork. Since most corporate WLANs require access to the wired LAN for services (file servers, printers, Internet links) they will operate in infrastructure mode.

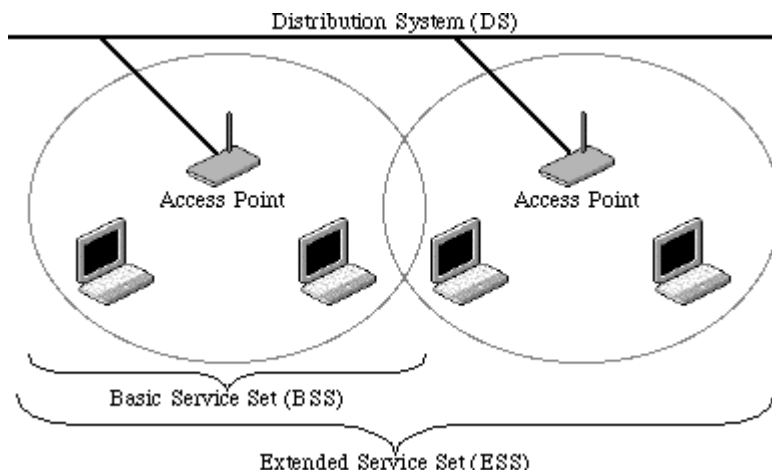

Example 1: wireless Infrastructure Mode

Ad hoc mode (also called peer-to-peer mode or an Independent Basic Service Set, or IBSS) is simply a set of 802.11 wireless stations that communicate directly with one another without using an access point or any connection to a wired network. This mode is useful for quickly and easily setting up a wireless network anywhere that a wireless infrastructure does not exist or is not required for services, such as a hotel room, convention center, or airport, or where access to the wired network is barred (such as for consultants at a client site).

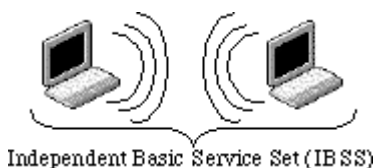

Example 2: wireless Ad Hoc Mode

4.5 What is BSSID?

A six-byte address that distinguishes a particular a particular access point from others. Also know as just SSID. Serves as a network ID or name.

4.6 What is ESSID?

The Extended Service Set ID (ESSID) is the name of the network you want to access. It is used to identify different wireless networks.

4.7 What are potential factors that may causes interference?

Factors of interference:

- Obstacles: walls, ceilings, furniture... etc.
- Building Materials: metal door, aluminum studs.
- Electrical devices: microwaves, monitors and electrical motors.

Solutions to overcome the interferences:

- ✓ Minimizing the number of walls and ceilings.
- ✓ Position the WLAN antenna for best reception.
- ✓ Keep WLAN devices away from other electrical devices, eg: microwaves, monitors, electric motors, ... etc.
- ✓ Add additional WLAN Access Points if necessary.

4.8 What are the Open System and Shared Key authentications?

IEEE 802.11 supports two subtypes of network authentication services: open system and shared key. Under open system authentication, any wireless station can request authentication. The station that needs to authenticate with another wireless station sends an authentication management frame that contains the identity of the sending station. The receiving station then returns a frame that indicates whether it recognizes the sending station. Under shared key authentication, each wireless station is assumed to have received a secret shared key over a secure channel that is independent from the 802.11 wireless network communications channel.

4.9 What is WEP?

An optional IEEE 802.11 function that offers frame transmission privacy similar to a wired network. The Wired Equivalent Privacy generates secret shared encryption keys that both source and destination stations can use to alert frame bits to avoid disclosure to eavesdroppers.

WEP relies on a secret key that is shared between a mobile station (e.g. a laptop with a wireless Ethernet card) and an access point (i.e. a base station). The secret key is used to encrypt packets before they are transmitted, and an integrity check is used to ensure that packets are not modified in transit.

4.10 What is Fragment Threshold?

The proposed protocol uses the frame fragmentation mechanism defined in IEEE 802.11 to achieve parallel transmissions. A large data frame is fragmented into several fragments each of size equal to fragment threshold. By tuning the fragment threshold

value, we can get varying fragment sizes. The determination of an efficient fragment threshold is an important issue in this scheme. If the fragment threshold is small, the overlap part of the master and parallel transmissions is large. This means the spatial reuse ratio of parallel transmissions is high. In contrast, with a large fragment threshold, the overlap is small and the spatial reuse ratio is low. However high fragment threshold leads to low fragment overhead. Hence there is a trade-off between spatial re-use and fragment overhead.

Fragment threshold is the maximum packet size used for fragmentation. Packets larger than the size programmed in this field will be fragmented.

If you find that your corrupted packets or asymmetric packet reception (all send packets, for example). You may want to try lowering your fragmentation threshold. This will cause packets to be broken into smaller fragments. These small fragments, if corrupted, can be resent faster than a larger fragment. Fragmentation increases overhead, so you'll want to keep this value as close to the maximum value as possible.

4.11 What is RTS (Request To Send) Threshold?

The RTS threshold is the packet size at which packet transmission is governed by the RTS/CTS transaction. The IEEE 802.11-1997 standard allows for short packets to be transmitted without RTS/CTS transactions. Each station can have a different RTS threshold. RTS/CTS is used when the data packet size exceeds the defined RTS threshold. With the CSMA/CA transmission mechanism, the transmitting station sends out an RTS packet to the receiving station, and waits for the receiving station to send back a CTS (Clear to Send) packet before sending the actual packet data.

This setting is useful for networks with many clients. With many clients, and a high network load, there will be many more collisions. By lowering the RTS threshold, there may be fewer collisions, and performance should improve. Basically, with a faster RTS threshold, the system can recover from problems faster. RTS packets consume valuable bandwidth, however, so setting this value too low will limit performance.

4.12 What is Beacon Interval?

In addition to data frames that carry information from higher layers, 802.11 includes management and control frames that support data transfer. The beacon frame, which is a type of management frame, provides the "heartbeat" of a wireless LAN, enabling stations to establish and maintain communications in an orderly fashion.

Beacon Interval represents the amount of time between beacon transmissions. Before a station enters power save mode, the station needs the beacon interval to know when to wake up to receive the beacon (and learn whether there are buffered frames at the access point).

4.13 What is Preamble Type?

There are two preamble types defined in IEEE 802.11 specification. A long preamble basically gives the decoder more time to process the preamble. All 802.11 devices support a long preamble. The short preamble is designed to improve efficiency (for example, for VoIP systems). The difference between the two is in the Synchronization field. The long preamble is 128 bits, and the short is 56 bits.

4.14 What is SSID Broadcast?

Broadcast of SSID is done in access points by the beacon. This announces your access point (including various bits of information about it) to the wireless world around it. By disabling that feature, the SSID configured in the client must match the SSID of the access point.

Some wireless devices don't work properly if SSID isn't broadcast (for example the D-link DWL-120 USB 802.11b adapter). Generally if your client hardware supports operation with SSID disabled, it's not a bad idea to run that way to enhance network security. However it's no replacement for WEP, MAC filtering or other protections.

4.15 What is Wi-Fi Protected Access (WPA)?

Wi-Fi's original security mechanism, Wired Equivalent Privacy (WEP), has been viewed as insufficient for securing confidential business communications. A longer-term solution, the IEEE 802.11i standard, is under development. However, since the IEEE 802.11i standard is not expected to be published until the end of 2003, several members of the Wi-Fi Alliance teamed up with members of the IEEE 802.11i task group to develop a significant near-term enhancement to Wi-Fi security. Together, this team developed Wi-Fi Protected Access.

To upgrade a WLAN network to support WPA, Access Points will require a WPA software upgrade. Clients will require a software upgrade for the network interface card, and possibly a software update for the operating system. For enterprise networks, an authentication server, typically one that supports RADIUS and the selected EAP authentication protocol, will be added to the network.

4.16 What is WPA2?

It is the second generation of WPA. WPA2 is based on the final IEEE 802.11i amendment to the 802.11 standard.

4.17 What is 802.1x Authentication?

802.1x is a framework for authenticated MAC-level access control, defines Extensible Authentication Protocol (EAP) over LANs (WAPOL). The standard encapsulates and leverages much of EAP, which was defined for dial-up authentication with Point-to-Point Protocol in RFC 2284.

Beyond encapsulating EAP packets, the 802.1x standard also defines EAPOL messages that convey the shared key information critical for wireless security.

4.18 What is Temporal Key Integrity Protocol (TKIP)?

The Temporal Key Integrity Protocol, pronounced tee-kip, is part of the IEEE 802.11i encryption standard for wireless LANs. TKIP is the next generation of WEP, the Wired Equivalency Protocol, which is used to secure 802.11 wireless LANs. TKIP provides per-packet key mixing, a message integrity check and a re-keying mechanism, thus fixing the flaws of WEP.

4.19 What is Advanced Encryption Standard (AES)?

Security issues are a major concern for wireless LANs, AES is the U.S. government's next-generation cryptography algorithm, which will replace DES and 3DES.

4.20 What is Inter-Access Point Protocol (IAPP)?

The IEEE 802.11f Inter-Access Point Protocol (IAPP) supports Access Point Vendor interoperability, enabling roaming of 802.11 Stations within IP subnet.

IAPP defines messages and data to be exchanged between Access Points and between the IAPP and high layer management entities to support roaming. The IAPP protocol uses TCP for inter-Access Point communication and UDP for RADIUS request/response exchanges. It also uses Layer 2 frames to update the forwarding tables of Layer 2 devices.

4.21 What is Wireless Distribution System (WDS)?

The Wireless Distribution System feature allows WLAN AP to talk directly to other APs via wireless channel, like the wireless bridge or repeater service.

4.22 What is Universal Plug and Play (uPNP)?

UPnP is an open networking architecture that consists of services, devices, and control points. The ultimate goal is to allow data communication among all UPnP devices regardless of media, operating system, programming language, and wired/wireless connection.

4.23 What is Maximum Transmission Unit (MTU) Size?

Maximum Transmission Unit (MTU) indicates the network stack of any packet is larger than this value will be fragmented before the transmission. During the PPP negotiation, the peer of the PPP connection will indicate its MRU and will be accepted. The actual MTU of the PPP connection will be set to the smaller one of MTU and the peer's MRU. The default is value 1400.

4.24 What is Clone MAC Address?

Clone MAC address is designed for your special application that request the clients to register to a server machine with one identified MAC address.

Since that all the clients will communicate outside world through the WLAN Broadband Router, so have the cloned MAC address set on the WLAN Broadband Router will solve the issue.

4.25 What is DDNS?

DDNS is the abbreviation of Dynamic Domain Name Server. It is designed for user own the DNS server with dynamic WAN IP address.

4.26 What is NTP Client?

NTP client is designed for fetching the current timestamp from internet via Network Time protocol. User can specify time zone, NTP server IP address.

4.27 What is VPN?

VPN is the abbreviation of Virtual Private Network. It is designed for creating point-to-point private link via shared or public network.

4.28 What is IPSEC?

IPSEC is the abbreviation of IP Security. It is used to transferring data securely under VPN.

4.29 What is WLAN Block Relay Between Clients?

An Infrastructure Basic Service Set is a BSS with a component called an *Access Point* (AP). The access point provides a local relay function for the BSS. All stations in the BSS communicate with the access point and no longer communicate directly. All frames are relayed between stations by the access point. This local relay function effectively doubles the range of the IBSS

4.30 What is WMM?

WMM is based on a subset of the IEEE 802.11e WLAN QoS draft standard. WMM adds prioritized capabilities to Wi-Fi networks and optimizes their performance when multiple concurring applications, each with different latency and throughput requirements, compete for network resources. By using WMM, end-user satisfaction is maintained in a wider variety of environments and traffic conditions. WMM makes it possible for home network users and enterprise network managers to decide which data streams are most important and assign them a higher traffic priority.

4.31 What is WLAN ACK TIMEOUT?

ACK frame has to receive ACK timeout frame. If remote does not receive in specified period, it will be retransmitted.

4.32 What is Modulation Coding Scheme (MCS)?

MCS is Wireless link data rate for 802.11n. The throughput/range performance of a AP will depend on its implementation of coding schemes. MCS includes variables such as the number of spatial streams, modulation, and the data rate on each stream. Radios establishing and maintaining a link must automatically negotiate the optimum MCS based on channel conditions and then continuously adjust the selection of MCS as conditions change due to interference, motion, fading, and other events.

4.33 What is Frame Aggregation?

Every 802.11 packet, no matter how small, has a fixed amount of overhead associated with it. Frame Aggregation combines multiple smaller packets together to form one larger packet. The larger packet can be sent without the overhead of the individual packets. This technique helps improve the efficiency of the 802.11n radio allowing more end user data to be sent in a given time.

4.34 What is Guard Intervals (GI)?

A GI is a period of time between symbol transmission that allows reflections (from multipath) from the previous data transmission to settle before transmitting a new

symbol.

The 802.11n draft specifies two guard intervals: 400ns (short) and 800ns (long).

Support of the 400ns GI is optional for transmit and receive. The purpose of a guard interval is to introduce immunity to propagation delays, echoes, and reflections to which digital data is normally very sensitive.

5 Configuration Examples

5.1 Example One – PPPoE on the WAN

Sales division of Company ABC likes to establish a WLAN network to support mobile communication on sales' Notebook PCs. MIS engineer collects information and plans the WLAN Broadband Router implementation by the following configuration.

WAN configuration:

PPPoE

User Name	H890123456
Password	PW192867543210

LAN configuration

IP Address	192.168.1.254
Subnet Mask	255.255.255.0
Default Gateway	0.0.0.0
DHCP Client Range	192.168.1.100 – 192.168.1.200

WLAN configuration

SSID	MyWLAN
Channel Number	11

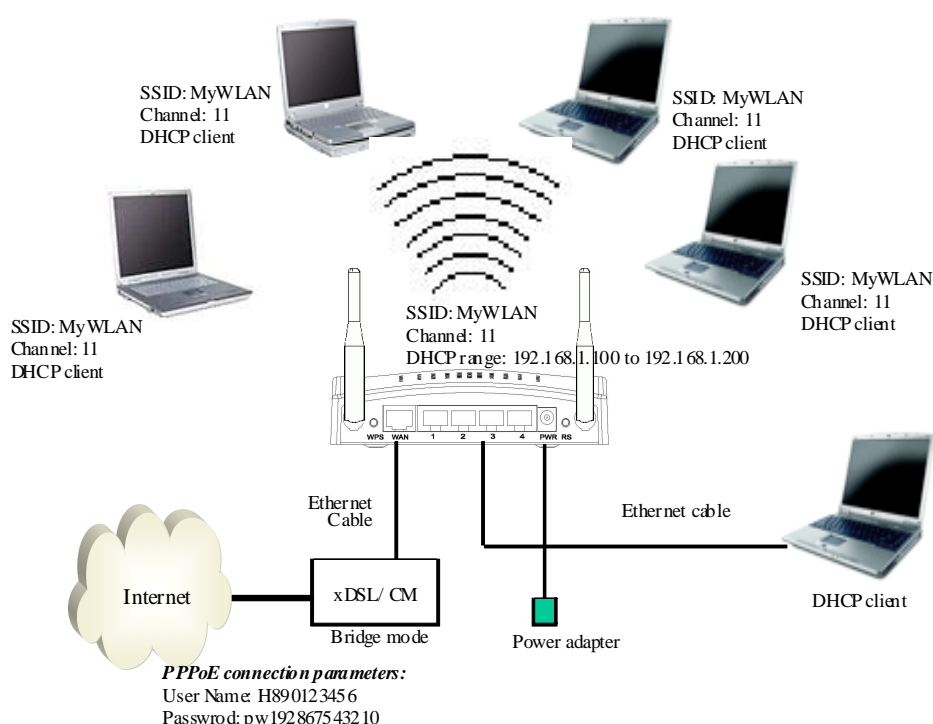
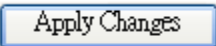

Figure 3 – Configuration Example One – PPPoE on the WAN

Configure the WAN interface:

Open WAN Interface Setup page, select PPPoE then enter the User Name “**H890123456**” and Password “**PW192867543210**”, the password is encrypted to display on the screen.

Press  button to confirm the configuration setting.

WAN Interface Setup

This page is used to configure the parameters for Internet network which connects to the WAN port of your Access Point. Here you may change the access method to static IP, DHCP, PPPoE or PPTP by click the item value of WAN Access type.

WAN Access Type: PPPoE

User Name:

Password:

Service Name:

Connection Type: Continuous

Idle Time: (1-1000 minutes)

MTU Size: (1360-1492 bytes)

Attain DNS Automatically

Set DNS Manually

DNS 1:

DNS 2:

DNS 3:

Clone MAC Address:

Enable uPNP

Enable IGMP Proxy

Enable Ping Access on WAN

Enable Web Server Access on WAN

Enable IPsec pass through on VPN connection

Enable PPTP pass through on VPN connection

Enable LZTP pass through on VPN connection

Configure the LAN interface:

Open LAN Interface Setup page, enter the IP Address “**192.168.1.254**”, Subnet Mask “**255.255.255.0**”, Default Gateway “**0.0.0.0**”, enable DHCP Server, DHCP client range “**192.168.1.100**” to “**192.168.1.200**”.

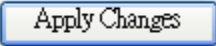
Press  button to confirm the configuration setting.

LAN Interface Setup

This page is used to configure the parameters for local area network which connects to the LAN port of your Access Point. Here you may change the setting for IP address, subnet mask, DHCP, etc..

IP Address:

Subnet Mask:

Default Gateway:

DHCP:

DHCP Client Range: -

Static DHCP:

Domain Name:

802.1d Spanning Tree:

Clone MAC Address:

Configure the WLAN interface:

Open WLAN Interface Setup page, enter the SSID “MyWLAN”, Channel Number “11”.

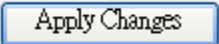
Press  button to confirm the configuration setting.

Wireless Basic Settings

This page is used to configure the parameters for wireless LAN clients which may connect to your Access Point. Here you may change wireless encryption settings as well as wireless network parameters.

Disable Wireless LAN Interface

Band: 2.4 GHz (B+G+N)

Mode: AP Multiple AP

Network Type: Infrastructure

SSID: MyWLAN

Channel Width: 40MHz

Control Sideband: Upper

Channel Number: 11

Broadcast SSID: Enabled

WMM: Enabled

Data Rate: Auto

Associated Clients: Show Active Clients

Enable Mac Clone (Single Ethernet Client)

Enable Universal Repeater Mode (Acting as AP and client simultaneously)

SSID of Extended Interface:

Apply Changes Reset

5.2 Example Two – Fixed IP on the WAN

Company ABC likes to establish a WLAN network to support mobile communication on all employees’ Notebook PCs. MIS engineer collects information and plans the WLAN Broadband Router implementation by the following configuration.

WAN configuration:

Fixed IP

<i>IP Address</i>	192.168.2.254
<i>Subnet Mask</i>	255.255.255.0
<i>Default Gateway</i>	192.168.2.10
<i>DNS Address</i>	168.95.1.1

LAN configuration

<i>IP Address</i>	192.168.1.254
<i>Subnet Mask</i>	255.255.255.0
<i>Default Gateway</i>	192.168.2.254
<i>DHCP Client Range</i>	192.168.1.100 – 192.168.1.200

WLAN configuration

<i>SSID</i>	MyWLAN
<i>Channel Number</i>	11

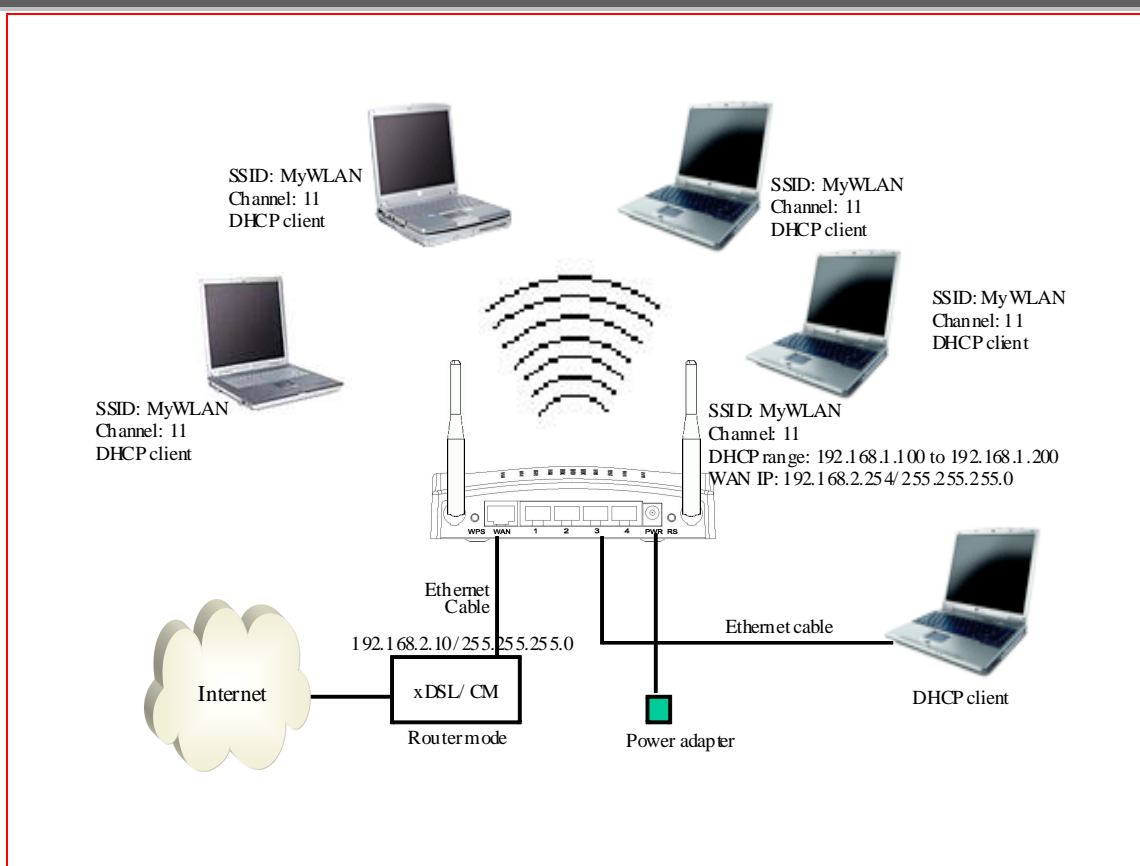
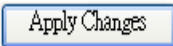

Figure 4 – Configuration Example Two – Fixed IP on the WAN

Configure the WAN interface:

Open WAN Interface Setup page, select Fixed IP then enter IP Address “192.168.2.254”, subnet mask “255.255.255.0”, Default gateway “192.168.2.10”.

Press  button to confirm the configuration the setting.

WAN Interface Setup

This page is used to configure the parameters for Internet network which connects to the WAN port of your Access Point. Here you may change the access method to static IP, DHCP, PPPoE or PPTP by click the item value of WAN Access type.

WAN Access Type: Static IP

IP Address:

Subnet Mask:

Default Gateway:

MTU Size: (1400-1500 bytes)

DNS 1:

DNS 2:

DNS 3:

Clone MAC Address:

- Enable uPNP
- Enable IGMP Proxy
- Enable Ping Access on WAN
- Enable Web Server Access on WAN
- Enable IPsec pass through on VPN connection
- Enable PPTP pass through on VPN connection
- Enable LZTP pass through on VPN connection

Configure the LAN interface:

Open LAN Interface Setup page, enter the IP Address “192.168.1.254”, Subnet Mask “255.255.255.0”, enable DHCP Server, DHCP client range “192.168.1.100” to “192.168.1.200”.

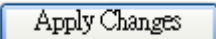
Press 

button to confirm the configuration setting.

LAN Interface Setup

This page is used to configure the parameters for local area network which connects to the LAN port of your Access Point. Here you may change the setting for IP address, subnet mask, DHCP, etc..

IP Address:

Subnet Mask:

Default Gateway:

DHCP:

DHCP Client Range: -

Static DHCP:

Domain Name:

802.1d Spanning Tree:

Clone MAC Address:

Configure the WLAN interface:

Open WLAN Interface Setup page, enter the SSID “MyWLAN”, Channel Number “11”.

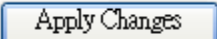
Press 

button to confirm the configuration setting.

Wireless Basic Settings

This page is used to configure the parameters for wireless LAN clients which may connect to your Access Point. Here you may change wireless encryption settings as well as wireless network parameters.

Disable Wireless LAN Interface

Band:

Mode:

Network Type:

SSID:

Channel Width:

Control Sideband:

Channel Number:

Broadcast SSID:

WMM:

Data Rate:

Associated Clients:

Enable Mac Clone (Single Ethernet Client)

Enable Universal Repeater Mode (Acting as AP and client simultaneously)

SSID of Extended Interface: