



CCL ELECTRONICS LTD

PROFESSIONAL WEATHER STATION WITH WIRELESS 5-IN-1 SENSOR

USERS' INSTRUCTION



CONTENTS

- INTRODUCTION.....1
- OVERVIEW.....1
- LCD DISPLAY.....3
- INSTALLATION.....5
- DISPLAY MAIN UNIT.....7
- WEATHER FORECAST.....9
- BAROMETRIC / ATMOSPHERIC PRESSURE.....9
- RAINFALL.....10
- WIND SPEED / WIND DIRECTION.....10
- BEAUFORT SCALE.....11
- WIND CHILL / HEAT INDEX / DEW-POINT.....12
- HISTORY DATA (ALL RECORDS IN THE PAST 24 HOURS).....12
- MAXIMUM / MINIMUM MEMORY FUNCTION.....12
- HI / LO ALERT.....13
- WIRELESS SIGNAL RECEPTION.....14
- TEMPERATURE & HUMIDITY.....14
- DATA CLEARING.....14
- POINTING 5-IN-1 SENSOR TO THE SOUTH.....14
- ABOUT THE MOON PHASE.....15
- MAINTENANCE.....15
- TROUBLESHOOTING.....16
- PRECAUTIONS.....16
- SPECIFICATIONS.....17

INTRODUCTION

Thank you for selecting Professional Weather Station with integrated 5-in-1 multi sensor.

The wireless 5-in-1 sensor contains a self-emptying rain collector for measuring rainfall, anemometer, wind vane, temperature and humidity sensors. It is fully assembled and calibrated for your easy installation. It sends data by a low power radio frequency to the Display Main Unit up to 150m away (line of sight).

The display Main Unit displays all the weather data received from the 5-in-1 sensor outside. It remembers the data for a time range for you to monitor and analyze the weather status for past 24 hours. It has advance feature such as the HI /LO Alert alarm which will alert the user when the set high or low weather criteria are met. The barometric pressure records are computed to give users forthcoming weather forecast and stormy warning. Day and date stamps are also provided to the corresponding maximum and minimum records for each weather details.

The system also analyzes the records for your convenient viewing, such as the display of rainfall in terms of rain rate, daily, weekly and monthly records, whereas wind-speed in different levels, and expressed in Beaufort Scale. Different useful readings such as Wind-chill, Heat Index, Dew-point, Comfort level are also provided.

With Radio-controlled / Atomic clock feature built-in, the system is truly a remarkable personal Professional Weather Station for your own backyard.

Note: This instruction manual contains useful information on the proper use and care of this product. Please read this manual through to fully understand and enjoy its features, and keep it handy for future use.

OVERVIEW

Display main unit

1. SNOOZE / LIGHT button
2. HISTORY button
3. MAX/MIN button
4. RAINFALL button
5. BARO button
6. WIND button
7. INDEX button
8. CLOCK button
9. ALARM button
10. ALERT button
11. DOWN button
12. UP button
13. °C/°F slide switch
14. RCC button
15. SCAN button
16. RESET button
17. Battery compartment
18. Alert LED indicator
19. LCD display with backlight
20. Table stand

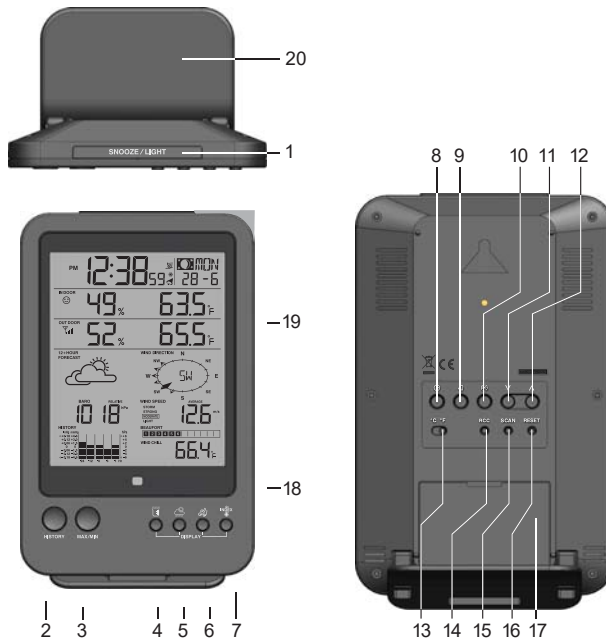

1

Wireless 5-in-1 Sensor

1. Rain collector
2. Balance indicator
3. Antenna
4. Wind cups
5. Mounting pole
6. Radiation shield
7. Wind vane
8. Mounting base
9. Mounting clamp
10. Red LED indicator
11. RESET button
12. Battery door
13. Screws

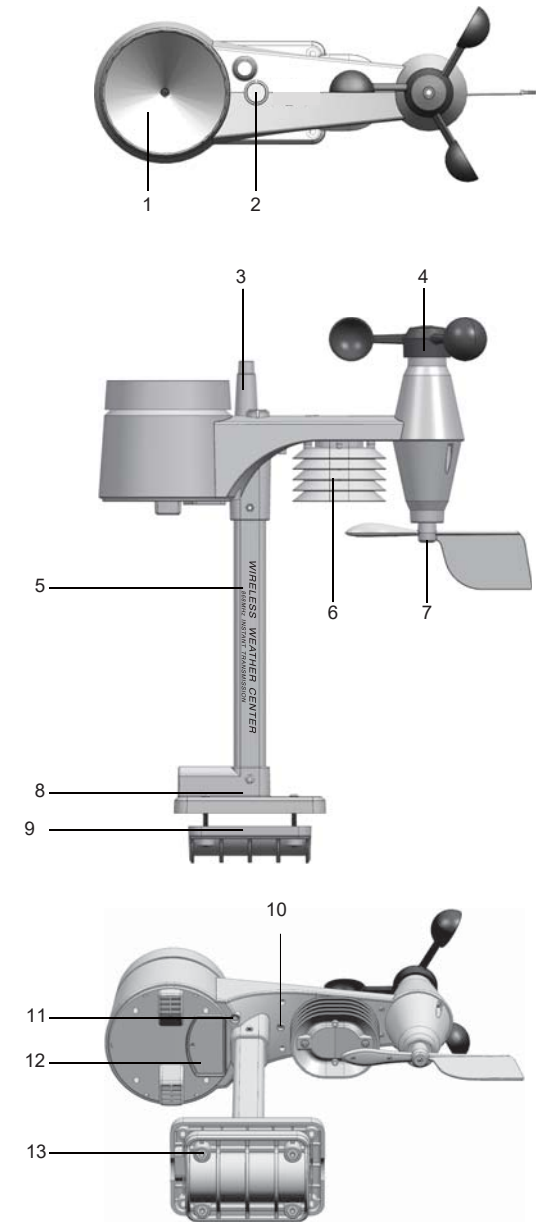

2

Rain gauge

1. Rain collector
2. Tipping bucket
3. Rain sensor
4. Drain holes

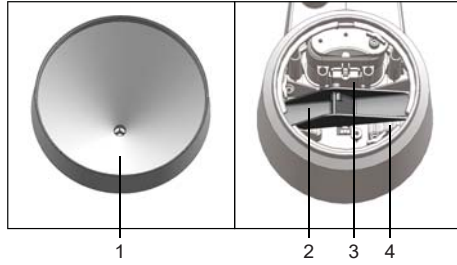

Temperature and humidity sensor

1. Radiation shield
2. Sensor casing (Temperature and humidity sensor)

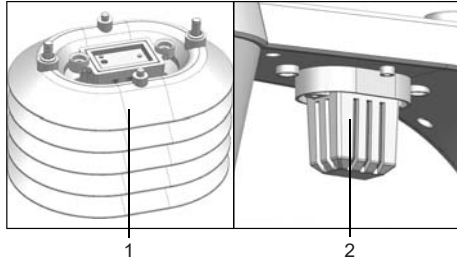

Wind sensor

1. Wind cups (anemometer)
2. Wind vane

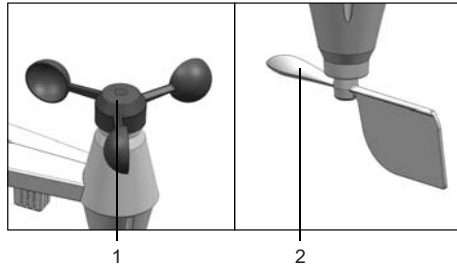

LCD DISPLAY

Normal time and calendar / Moon phase

1. Max/Min/Previous indicator
2. Low battery indicator for main unit
3. Time
4. Ice pre-alert on
5. RC Signal strength indicator
6. DST icon
7. Moon phase
8. Day of the week
9. Alarm icon
10. Date
11. Month

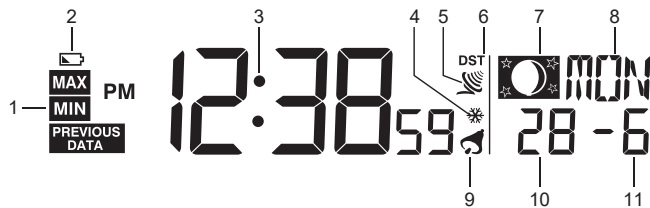

Indoor temperature and humidity window

1. Comfort/cold/hot icon
2. Indoor indicator
3. Indoor humidity
4. Hi / Lo Alert and Alarm
5. Indoor temperature

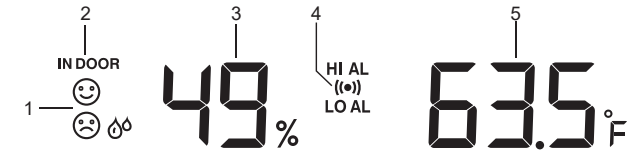

Outdoor temperature and humidity window

1. Outdoor signal strength indicator
2. Outdoor indicator
3. Outdoor humidity
4. Hi / Lo Alert and Alarm
5. Outdoor temperature
6. Low battery indicator for sensor

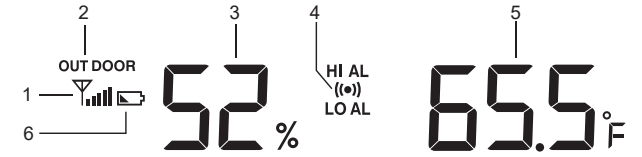

12+ Hour forecast

1. Weather forecast indicator
2. Weather forecast icon



Barometer

1. Barometer indicator
2. Histogram
3. Absolute/Relative indicator
4. Barometer measurement unit (hPa / inHg / mmHg)
5. Barometer reading
6. Hourly records indicator

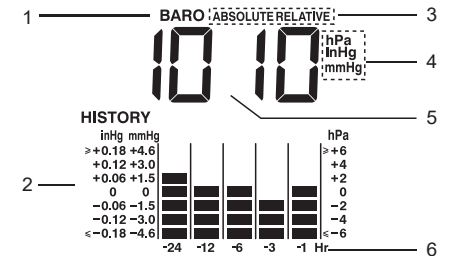

Rainfall

1. Rainfall indicator
2. Time range record indicator
3. Day records indicator
4. Histogram
5. Hi Alert and Alarm
6. Current rainfall rate
7. Rainfall unit (in / mm)

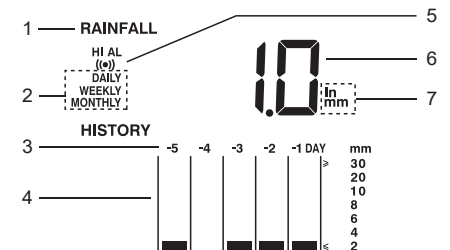

Wind direction/Wind speed

1. Wind direction indicator
2. Wind direction indicator(s) during last hour
3. Current wind direction indicator
4. Wind speed indicator
5. Wind levels and indicator
6. Beaufort scale reading
7. Current wind direction reading
8. Average/Gust wind indicator
9. Wind speed unit (mph / m/s / km/h / knots)
10. Hi Alert and Alarm

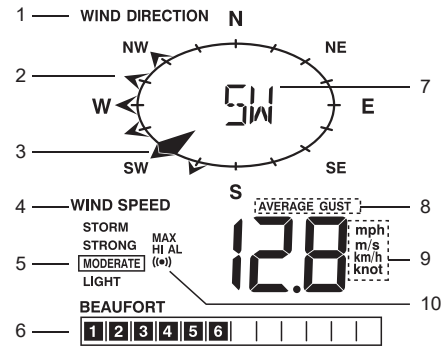

Wind chill/ Heat index/ Indoor dewpoint

1. Wind chill/ Heat index/ Indoor dewpoint indicator
2. Wind chill/ Heat index/ Indoor dewpoint reading



INSTALLATION

Wireless 5-in-1 Sensor

Your wireless 5-in-1 sensor measures wind-speed, wind-direction, rainfall, temperature and humidity for you. It's fully assembled and calibrated for your easy installation.

Battery and installation

Unscrew the battery door at bottom of unit and insert the batteries according to the "+/-"polarity indicated. Screw the battery door compartment on tightly.

Note:
The red LED will begin flashing every 12 seconds.

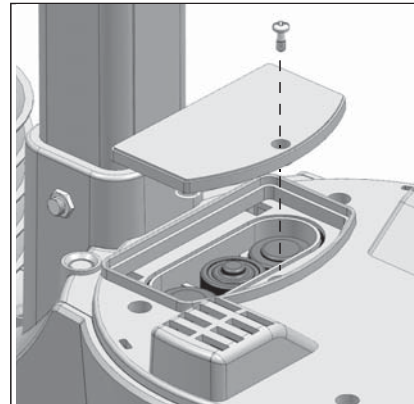

Install the wireless 5-in-1 sensor in an open location with no obstructions above and around the sensor for accurate rain and wind measurement. Install the sensor with the smaller end facing the North to properly orient the wind direction vane.

Secure the mounting stand and bracket (included) to a post or pole, and allow minimum 1.5m off the ground.

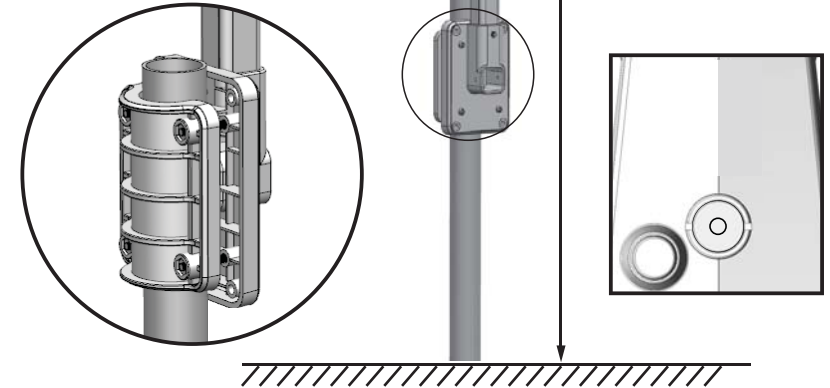

Mounting guidelines:

1. Install the wireless 5-in-1 sensor at least 1.5m off the ground for better and more accurate wind measurements.
2. Choose an open area within 150 meters from the LCD display Main Unit.
3. Install the wireless 5-in-1 sensor as level as possible to achieve accurate rain and wind measurements. A bubble level device is provided to ensure a level installation.
4. Mount the wireless 5-in-1 sensor with the wind meter end pointing to the North to correctly orient direction of the wind vane.



A. Mounting on pole (Pole Diameter 1"~1.3" (25~33mm))

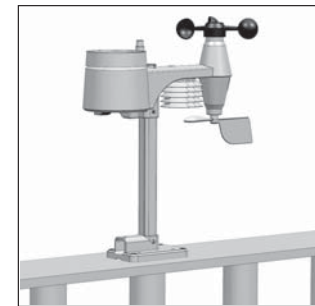

B. Mounting on the railing

DISPLAY MAIN UNIT

Stand and batteries installation

The unit is designed for desktop or wall mount for easy viewing.



1. Remove the battery door of the main unit.
2. Insert 3 new AA size batteries according to the “+/-” polarity mark on the battery compartment.
3. Replace the battery door.
4. Once the batteries are inserted, all the segments of the LCD will be shown briefly before entering the radio-controlled time reception mode.
5. The RC clock will automatically start scanning for the radio-controlled time signal in 8 seconds.

Note:

1. If no display appears on the LCD after inserting the batteries, press the RESET button by using a pointed object.
2. In some cases, you may not receive the signal immediately due to the atmospheric disturbance.

Pairing of wireless 5-in-1 sensor with Display Main Unit

After insertion of batteries, the Display Main Unit will automatically search and connect the wireless 5-in-1 sensor (antenna blinking).

Once the connection is successful, antenna mark and readings for outdoor temperature, humidity, wind speed, wind direction, and rainfall will appear on the display.

Changing batteries and manual pairing of sensor

Whenever you changed the batteries of the wireless 5-in-1 sensor, pairing must be done manually.

1. Change the batteries to new ones.
2. Press the [SCAN] button.
3. Press the [RESET] button on the sensor.

Note:

1. Pressing [RESET] button at bottom of wireless 5-in-1 sensor will generate a new code for pairing purpose.
2. Always dispose old batteries in an environmental safe manner.

Radio-controlled / atomic clock function

When the unit receives RC signal, a sync-time symbol “” will appear on the LCD, and synchronizes daily.

Note:

1. The strength of radio-controlled time signal from the transmitter tower may be affected by geographical location or building around.
2. Always place the unit away from interfering sources such as TV set, computer, etc.

3. Avoid placing the unit on or next to metal plates.
4. Closed areas such as airport, basement, tower block, or factory are not recommended.

Time setting

The unit automatically set itself accordingly to the Radio Controlled Clock signal it received. To set the clock/ calendar manually, first disable the reception by holding the RCC button for 8 seconds.

To manually set the clock / Time Zone selection

1. Press and hold [CLOCK] button for 2 seconds until “12 or 24Hr” flashes.
2. Use [UP]/[DOWN] button to adjust, and press [CLOCK] button to proceed to the next setting.
3. Repeat 2 above for setting of **TIME ZONE, HOUR, MINUTE, SECOND, YEAR, MONTH, DATE, HOUR OFFSET, LANGUAGE and DST.**

Note:

1. The unit will automatically exit setting mode if no button was pressed in 60 seconds.
2. Time zone setting is only for North American version where the unit is set to receive WWVB signal. User can select PST, MST, CST, EST, AST or NST.
3. The language options are English (EN), French (FR), German (DE), Spanish (ES), and Italian (IT).
4. DST (Daylight Saving Time) feature is set to Auto (factory set). The clock has been programmed to automatically switch when the daylight saving time is in effect. User can set the DST to OFF to disable the feature.

Disable / Enable RCC signal reception

1. Press and hold [RCC] button 8 seconds to disable the reception.
2. Press and hold [RCC] button 8 seconds to enable automatic RCC reception.



To turn on/off alarm clock (with ice-alert function)

1. Press the [ALARM] button anytime to show the alarm time.
2. Press [ALARM] button to activate the alarm.
3. Press again to activate alarm with ice-alert function.
4. To disable the alarm, press until the alarm icon disappears.



To set the alarm time

1. Press and hold [ALARM] button for 2 seconds to enter alarm setting mode. HOUR will begin to flash.
2. Use [UP]/[DOWN] button to adjust HOUR, and press [ALARM] button to proceed to set MINUTE.
3. Repeat 2 above to set MINUTE, then press [ALARM] button to exit.

Note: Pressing the [ALARM] button twice when alarm time is being displayed will activate the temperature-adjusted pre-alarm. The alarm will sound 30 minutes earlier if it detects outside temperature is below -3°C.

WEATHER FORECAST

The device contains sensitive pressure sensor built-in with sophisticated and proven software that predicts weather for the next 12 ~ 24 hours within a 30 to 50km (19-31 miles) radius.

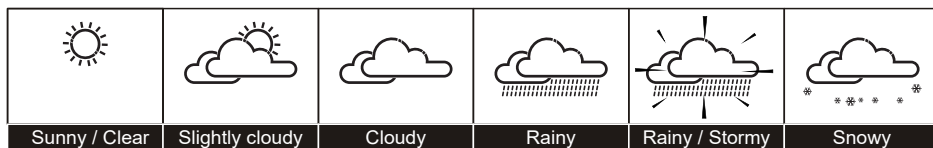

Note:

1. The accuracy of a general pressure-based weather forecast is about 70% to 75%.
2. The weather forecast is meant for the next 12 hours, it may not necessarily reflect the current situation.
3. The "Snowy" weather forecast is not based on the atmospheric pressure, but based on the outdoor temperature. When the outdoor temperature is below -3°C (26°F), the "Snowy" weather indicator will be displayed on the LCD.

BAROMETRIC / ATMOSPHERIC PRESSURE

Atmospheric Pressure is the pressure at any location of the Earth caused by the weight of the column of air above it. One atmospheric pressure refers to the average pressure and gradually decreases as altitude increases. Meteorologists use barometers to measure atmospheric pressure. Since variation in atmospheric pressure greatly affected by weather, it is possible to forecast the weather by measuring the changes in pressure.

To select the display mode:

Press and hold [BARO] button for 2 seconds to toggle between:

- **ABSOLUTE** the absolute atmospheric pressure of your location
- **RELATIVE** the relative atmospheric pressure based on the sea level

To set relative atmospheric pressure value:

1. Get the atmospheric pressure data of the sea level (it is also the relative atmospheric pressure data of your home area) through the local weather service, internet and other channels.
2. Press and hold [BARO] button for 2 seconds until "ABSOLUTE" or "RELATIVE" icon flashes.
3. Press [UP]/[DOWN] button to switch to "RELATIVE" mode.
4. Press [BARO] button once again until the "RELATIVE" atmospheric pressure digit flashes.
5. Press [UP]/[DOWN] button to change its value.
6. Press [BARO] button to save and exit the setting mode.

Note:

1. The default relative atmospheric pressure value is 1013 hPa (29.91 inHg), which refers to the average atmospheric pressure.
2. When you change the relative atmospheric pressure value, the weather indicators will change along with it.
3. The built-in barometer can notice the environmental absolute atmospheric pressure changes. Based on the data collected, it can predict the weather conditions in the forthcoming 12 hours. Therefore, the weather indicators will change according to the detected absolute atmospheric pressure after you operate the clock for 1 hour.
4. The relative atmospheric pressure is based on the sea level, but it will change with the absolute atmospheric pressure changes after operating the clock for 1 hour.

To select the measurement unit for the barometer:

1. Press the [BARO] button to enter unit setting mode.
2. Use the [BARO] button to change the unit between **inHg** (inches of mercury) / **mmHg** (millimeter of mercury) (millibars per hectopascal) / **hPa**.
3. Press [BARO] button to confirm.

RAINFALL

To select the rainfall display mode:

The device displays how many mm / inches of rain are accumulated in a one hour time period, based on current rainfall rate.

Press [RAINFALL] button to toggle between:

- **RATE** Current rainfall rate in past an hour
- **DAILY** The DAILY display indicate the total rainfall from midnight
- **WEEKLY** The WEEKLY display indicate the total rainfall from the current week
- **MONTHLY** The MONTHLY display indicate the total rainfall from the current calendar month

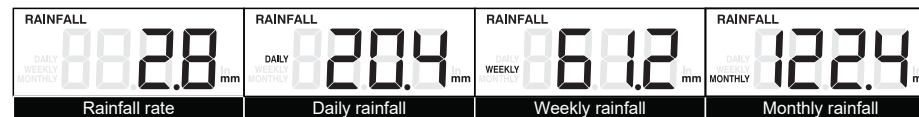

Note: Rain rate is updated every 6 minutes, at every hour on the hour, and at 6, 12, 18, 24, 30, 36, 42, 48, 54 minute past the hour.

To select the measurement unit for the rainfall:

1. Press and hold [RAINFALL] button 2 seconds to enter unit setting mode.
2. Use [UP] / [DOWN] button to toggle between **mm** (millimeter) and **in** (inch).
3. Press [RAINFALL] button to confirm and exit.

WIND SPEED / DIRECTION

To read the wind direction:

Wind Direction Indicator	Meaning
	Real-time wind direction
	Wind directions appeared in last 5 minutes (max 6)

To select the wind display mode:

Press [WIND] button to toggle between:

- **AVERAGE** The AVERAGE wind speed will display the average of all wind speed numbers recorded in the previous 30 seconds
- **GUST** The GUST wind speed will display the highest wind speed recorded from last reading



The wind level provides a quick reference on the wind condition and is indicated by a series of text icons:

Level	LIGHT	MODERATE	STRONG	STORM
Speed	2-8 mph 3-13 km/h	9-25 mph 14-41 km/h	26-54 mph 42-87 km/h	≥ 55 mph ≥ 88 km/h

To select wind speed unit:

1. Press and hold [WIND] button for 2 seconds to enter unit setting mode.
2. Use the [UP] / [DOWN] button to change the unit between **mph** (miles per hour) / **m/s** (meter per second) / **km/h** (kilometer per hour) / **knots**.
3. Press [WIND] button to confirm and exit.

BEAUFORT SCALE

Beaufort scale is an international scale of wind velocities from 0 (calm) to 12 (Hurricane force).

Beaufort number	Description	Wind speed	Land conditions
0	Calm	< 1 km/h	Calm. Smoke rises vertically.
		< 1 mph	
		< 1 knots	
		< 0.3 m/s	
1	Light air	1.1–5.5 km/h	Smoke drift indicates wind direction. Leaves and wind vanes are stationary.
		1–3 mph	
		1–3 knots	
		0.3–1.5 m/s	
2	Light breeze	5.6–11 km/h	Wind felt on exposed skin. Leaves rustle. Wind vanes begin to move.
		4–7 mph	
		4–6 knots	
		1.6–3.4 m/s	
3	Gentle breeze	12–19 km/h	Leaves and small twigs constantly moving, light flags extended.
		8–12 mph	
		7–10 knots	
		3.5–5.4 m/s	
4	Moderate breeze	20–28 km/h	Dust and loose paper raised. Small branches begin to move.
		13–17 mph	
		11–16 knots	
		5.5–7.9 m/s	
5	Fresh breeze	29–38 km/h	Branches of a moderate size move. Small trees in leaf begin to sway.
		18–24 mph	
		17–21 knots	
		8.0–10.7 m/s	
6	Strong breeze	39–49 km/h	Large branches in motion. Whistling heard in overhead wires. Umbrella use becomes difficult. Empty plastic bins tip over.
		25–30 mph	
		22–27 knots	
		10.8–13.8 m/s	
7	High wind	50–61 km/h	Whole trees in motion. Effort needed to walk against the wind.
		31–38 mph	
		28–33 knots	
		13.9–17.1 m/s	
8	Gale	62–74 km/h	Some twigs broken from trees. Cars veer on road. Progress on foot is seriously impeded.
		39–46 mph	
		34–40 knots	
		17.2–20.7 m/s	
9	Strong gale	75–88 km/h	Some branches break off trees, and some small trees blow over. Construction /temporary signs and barricades blow over.
		47–54 mph	
		41–47 knots	
		20.8–24.4 m/s	
10	Storm	89–102 km/h	Trees are broken off or uprooted, structural damage likely.
		55–63 mph	
		48–55 knots	
		24.5–28.4 m/s	
11	Violent storm	103–117 km/h	Widespread vegetation and structural damage likely.
		64–73 mph	
		56–63 knots	
		28.5–32.6 m/s	
12	Hurricane force	≥ 118 km/h	Severe widespread damage to vegetation and structures. Debris and unsecured objects are hurled about.
		≥ 74 mph	
		≥ 64 knots	
		≥ 32.7m/s	

WIND CHILL / HEAT INDEX / DEW-POINT

To view Wind Chill:

Press the [INDEX] button repeatedly until WINDCHILL displays.

Note: The wind chill factor is based on the combined effects of temperature and wind speed. The wind chill displayed is calculated solely from temperature and humidity measured from the 5-in-1 sensor.

To view Heat Index:

Press the [INDEX] button repeatedly until HEAT INDEX displays.

Heat Index range	Warning	Explanation
27°C to 32°C (80°F to 90°F)	Caution	Possibility of heat exhaustion
33°C to 40°C (91°F to 105°F)	Extreme Caution	Possibility of heat dehydration
41°C to 54°C (106°F to 129°F)	Danger	Heat exhaustion likely
≥55°C (≥130°F)	Extreme Danger	Strong risk of dehydration / sun stroke

Note: Heat index is only calculated when temperature is 27°C/80°F or above, and based solely from the temperature and humidity measured from the 5-in-1 sensor.

To view Dew-Point (Indoor)

Press the [INDEX] button repeatedly until DEWPOINT displays.

Note: The dew point is the temperature below which the water vapor in air at constant barometric pressure condenses into liquid water at the same rate at which it evaporates. The condensed water is called dew when it forms on a solid surface.

The dewpoint temperature is calculated from the indoor temperature and humidity measured at the Main Unit.

HISTORY DATA (ALL RECORDS IN THE PAST 24 HOURS)

The Display main unit automatically record and display data of past 24 hours on the hour.

To check all the history data in the past 24 hours, press the [HISTORY] button.

E.g. Current time 7:25 am, Mach 28

Press [HISTORY] button repeatedly to view past readings at 7:00am, 6:00am, 5:00am, ..., 5:00am (Mar 27), 6:00am (Mar 27), 7:00am (Mar 27)

The LCD will display the past indoor and outdoor temperature & humidity, value of air pressure, wind chill, wind speed, rainfall and their time and date.

MAXIMUM / MINIMUM MEMORY FUNCTION

- Press [MAX/MIN] button to check the maximum/minimum records. The checking orders will be: Outdoor max temperature → Outdoor min temperature → Outdoor max humidity → Outdoor min humidity → Indoor max temperature → Indoor min temperature → Indoor max humidity → Indoor min humidity → Outdoor max wind chill → Outdoor min wind chill → Outdoor max heat index → Outdoor min heat index → Indoor max dewpoint → Indoor min dewpoint → Max pressure → Min pressure → Max average → Max gust → Max rainfall.

- Press and hold [MAX/MIN] button for 2 seconds to reset the maximum and minimum records.

Note: When maximum or minimum reading is displayed, the corresponding timestamp will be shown.

HI / LO ALERT

HI/LO alert are used to alert you of certain weather conditions. Once activated, the alarm will turn on and amber LED starts flashing when a certain criterion is met. The following are areas and type of alert provided:

Area	Type of Alert available
Indoor temperature	HI and LO alert
Indoor humidity	HI and LO alert
Outdoor temperature	HI and LO alert
Outdoor humidity	HI and LO alert
Rainfall	HI alert *
Wind speed	HI alert

Note: * Daily rainfall since midnight.

To set the HI / LO alert

1. Press the [ALERT] button until the desired area is selected.
2. Use [UP] / [DOWN] buttons to adjust the setting.
3. Press [ALERT] button to confirm and continue to next setting.

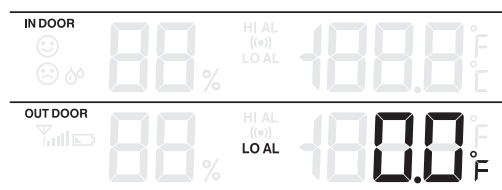
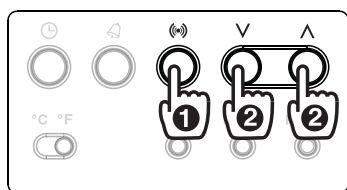

To enable/disable the HI / LO alert

1. Press [ALERT] button until the desired area is selected.
2. Press [ALARM] button to turn the alert on or off.
3. Press [ALERT] button to continue to next setting.

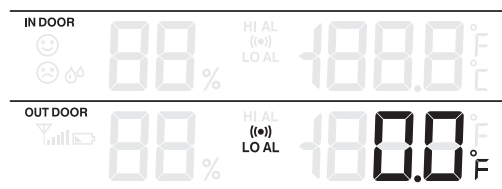
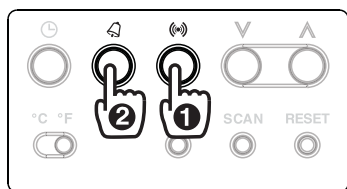

Note:

1. The unit will automatically exit setting mode in 5 seconds if no button is pressed.
2. When ALERT alarm is on, the area and type of alarm that triggered the alarm will be flashing and the alarm will sound for 2 minutes.
3. To silence the Alert alarm beeping, press the [SNOOZE / LIGHT] / [ALARM] button, or let the beeping alarm automatically turn off after 2 minutes.

WIRELESS SIGNAL RECEPTION



The 5-in-1 sensor is capable of transmitting data wirelessly over an approximate operating of 150m range (line of sight).

Occasionally, due to intermittent physical obstructions or other environmental interference, the signal may be weaken or lost.

In the case that the sensor signal is lost completely, you will need to relocate the Display main unit or the wireless 5-in-1 sensor.

TEMPERATURE & HUMIDITY

Comfort Indication

The comfort indication is a pictorial indication based on indoor air temperature and humidity in an attempt to determine comfort level.



Note:

1. Comfort indication can vary under the same temperature, depending on the humidity.
2. There is no comfort Indication when temperature is below 0°C (32°F) or over 60°C (140°F).

DATA CLEARING

During installation of the wireless 5-in-1 sensor, the sensors were likely to be triggered, resulting in erroneous rainfall and wind measurements. After the installation, user may clear out all the erroneous data from the Display Main Unit, without needing to reset the clock and re-establish pairing.

Simply press and hold the [HISTORY] button for 10 seconds. This will clear out any data recorded before.

POINTING 5-IN-1 SENSOR TO THE SOUTH

The outdoor 5-in-1 sensor is calibrated to be pointing to North by default. However, in some cases, users may wish to install the product with the arrow pointing towards the South, especially for people living in the Southern hemisphere (e.g. Australia, New Zealand).

1. First install the outdoor 5-in-1 sensor with its arrow pointing to the South. (Please refer to Installation session for mounting details)
2. On the Display main unit, press and hold [WIND] button for 8 seconds until the upper part (Northern Hemisphere) of the compass lights up and blinking.
3. Use [UP] / [DOWN] to change to lower part (Southern Hemisphere).

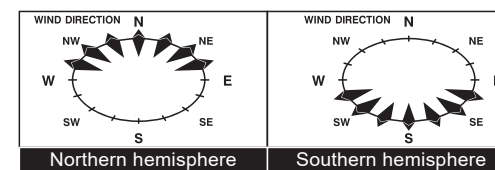

4. Press [WIND] button to confirm and exit.









Note: Changing from hemisphere setting will automatically switch the direction of the moon phase on the display.

ABOUT THE MOON PHASE









In the Northern hemisphere, the moon waxes (the part of the moon we see that glows after the New Moon) from the right. Hence the sun-lit area of the moon moves from right to left in the Northern Hemisphere, while in the Southern Hemisphere, it moves from left to right.

Below are the 2 tables which illustrate how the moon will appear on the main unit.

Northern hemisphere:

	New Moon		Full Moon
	Waxing Crescent		Waning Gibbous
	First quarter		Third quarter
	Waxing Gibbous		Waning Crescent

Southern hemisphere:

	New Moon		Full Moon
	Waxing Crescent		Waning Gibbous
	First quarter		Third quarter
	Waxing Gibbous		Waning Crescent

MAINTENANCE

To clean the rain collector

1. Rotate the rain collector by 30° anticlockwise.
2. Gently remove the rain collector.
3. Clean and remove any debris or insects.
4. Install all the parts when they are fully clean and dried.

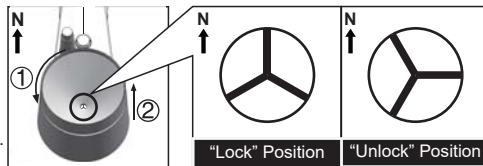

To clean the Thermo / Hygro sensor

1. Unscrew the 2 screws at the bottom of the radiation shield.
2. Gently pull out the shield.
3. Remove carefully any dirt or insects inside the sensor casing (Do not let the sensors inside get wet).
4. Clean the shield with water and remove any dirt or insects.
5. Install all the parts back when they are fully clean and dried.

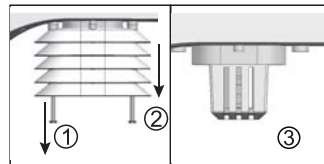

TROUBLESHOOTING

Problem / Symptom	Solution
Strange or no measurement of Rain Sensor	<ol style="list-style-type: none"> 1. Check the drain hole in the rain collector. 2. Check the balance indicator.
Strange or no measurement of Thermo / Hygro Sensor	<ol style="list-style-type: none"> 1. Check the radiation shield. 2. Check the sensor casing.
Strange or no measurement of Wind Speed and Direction	<ol style="list-style-type: none"> 1. Check wind cups (Anemometer). 2. Check the wind vane.
⚡ and — — — (Signal lost for 15 minutes)	<ol style="list-style-type: none"> 1. Relocate the main unit and 5-in-1 sensor closer to each other. 2. Make sure the main unit is placed away from other electronic appliances that may interfere with the wireless communication (TVs, computers, microwaves). 3. If problem continues, reset both main unit and 5-in-1 sensor.
⚡ and E _r (Signal lost for 1 hour)	

PRECAUTIONS

- Read and keep these instructions.
- Heed all warnings.
- Follow all instructions.
- Do not subject the unit to excessive force, shock, dust, temperature or humidity.
- Do not cover the ventilation holes with any items such as newspapers, curtains etc.
- Do not immerse the unit in water. If you spill liquid over it, dry it immediately with a soft, lint-free cloth.
- Do not clean the unit with abrasive or corrosive materials.
- Do not tamper with the unit's internal components. This invalidates the warranty.
- Only use fresh batteries. Do not mix new and old batteries.
- Only use attachments / accessories specified by the manufacturer.
- Images shown in this manual may differ from the actual display.
- When disposing of this product, ensure it is collected separately for special treatment.
- Placement of this product on certain types of wood may result in damage to its finishing for which manufacture will not be responsible. Consult the furniture manufacturer's care instructions for information.
- The contents of this manual may not be reproduced without the permission of the manufacturer.
- When replacement parts are required, be sure the service technician uses replacement parts specified by the manufacturer that have the same characteristics as the original parts. Unauthorized substitutions may result in fire, electric shock, or other hazards.
- Do not dispose old batteries as unsorted municipal waste. Collection of such waste separately for special treatment is necessary.
- Please note that some units are equipped with a battery safety strip. Remove the strip from the battery compartment before first use.
- The technical specifications for this product and the contents of the user manual are subject to change without notice.

SPECIFICATIONS

MAIN UNIT

Dimensions (W x H x D)	120 x 190 x 22 mm
Weight	370g with batteries
Battery	3 x AA size 1.5V batteries (Alkaline recommended)
Support channels	Wireless 5-in-1 sensor (Wind speed, Wind direction, Rain gauge, thermo-hygro)

INDOOR BAROMETER

Barometer unit	hPa, inHg and mmHg
Measuring range	540 to 1100 hPa / 405 to 825 mmHg / 15.95 to 32.48 inHg
Resolution	1hPa, 0.01inHg, 0.1mmHg
Accuracy @ 0 to 50°C (32 to 122°F)	540 to 699hPa ± 8hPa / 700 to 1100hPa ± 4hPa 405 to 524 mmHg ± 6mmHg / 525 to 825 mmHg ± 3mmHg 15.95 to 20.66 inHg ± 0.24 inHg / 20.67 to 32.48 inHg ± 0.12 inHg
Weather forecast	Sunny/Clear, slightly Cloudy, Cloudy, Rainy, Rainy / Stormy and Snowy
Display modes	Current, Max, Min, Historical data for last 24hrs
Memory modes	Max & Min from last memory reset (with time stamp)

INDOOR TEMPERATURE

Temp. unit	°C or °F
Displayed range	-40°C to 70°C (-40°F to 158°F)
Operating range	-10°C to 50°C (14°F to 122°F)
Resolution	0.1°C or 0.1°F
Accuracy	+/- 1°C or 2°F typical @ 25°C (77°F)
Display modes	Current, Min and Max, Historical data for past 24 hours
Memory modes	Max & Min from last memory reset (with time stamp)
Alarm	Hi / Lo Temperature Alert

INDOOR HUMIDITY

Displayed range	20% to 90% RH (< 20%: LO; > 90%: HI) (Temperature between 0°C to 60°C)
Operating range	20% to 90%RH
Resolution	1%
Accuracy	+/-5% typical @ 25°C (77°F)
Display modes	Current, Min and Max, Historical data for past 24 hours
Memory modes	Max & Min from last memory reset (with time stamp)
Alarm	Hi / Lo Humidity Alert

RADIO-CONTROLLED / ATOMIC CLOCK

Synchronization	Auto or disabled
Clock display	HH:MM:SS / Weekday
Hour format	12hr AM/PM or 24hr
Calendar	MM/DD
Weekday in 5 languages	EN, FR, DE, ES, IT
Time signal	WWVB
Time zone	PST, MST, CST, EST, AST, NST
DST	AUTO / OFF

WIRELESS 5-IN-1 SENSOR

Dimensions (W x H x D)	343.5 x 393.5 x 136 mm
Weight	673g with batteries
Battery	3 x AA size 1.5V battery (Lithium battery recommended)
Frequency	868 MHz (European) / 915 MHz (North American)
Transmission	Every 12 seconds

OUTDOOR TEMPERATURE

Temp. unit	°C or °F
Displayed range	-40°C to 80°C (-40°F to 176°F)
Operating range	-40°C to 60°C (-40°F to 140°F)
Resolution	0.1°C or 0.1°F
Accuracy	+/- 0.5°C or 1°F typical @ 25°C (77°F)
Display modes	Current, Min and Max, Historical data for past 24 hours
Memory modes	Max & Min from last memory reset (with time stamp)
Alarm	Hi / Lo Temperature Alert

OUTDOOR HUMIDITY

Displayed range	1% to 99% (< 1%: LO; > 99%: HI)
Operating range	1% to 99%
Resolution	1%
Accuracy	+/- 3% typical @ 25°C (77°F)
Display modes	Current, Min and Max, Historical data for past 24 hours
Memory modes	Max & Min from last memory reset (with time stamp)
Alarm	Hi / Lo Humidity Alert

RAIN GAUGE

Unit for rainfall	mm and in
Range for rainfall	0 to 9999mm (0 to 393.7inches)
Resolution	0.4 mm (0.0157 in)
Accuracy for rainfall	Greater of +/- 7% or 1 tip
Display modes	Rainfall (Rate / Daily / Weekly / Monthly), Historical data for past 24 hours
Memory modes	Total rainfall from last memory reset
Alarm	Hi Rainfall Alert

WIND SPEED

Wind speed unit	mph, m/s, km/h, knots
Wind speed range	0 to 112mph, 50m/s, 180km/h, 97knots
Wind speed resolution	0.1mph or 0.1knot or 0.1m/s
Speed accuracy	< 5m/s: +/- 0.5m/s; > 5m/s: +/- 6%
Direction resolutions	16
Display modes	Gust/average wind speed & direction, Historical data for past 24 hours
Memory modes	Max gust speed with direction (with time stamp)
Alarm	Hi Wind speed Alert (Average / Gust)

Warning: Changes or modifications to this unit not expressly approved by the party responsible for compliance could void the user's authority to operate the equipment.

NOTE: This equipment has been tested and found to comply with the limits for a Class B digital device, pursuant to Part 15 of the FCC Rules. These limits are designed to provide reasonable protection against harmful interference in a residential installation.

This equipment generates, uses and can radiate radio frequency energy and, if not installed and used in accordance with the instructions, may cause harmful interference to radio communications.

However, there is no guarantee that interference will not occur in a particular installation. If this equipment does cause harmful interference to radio or television reception, which can be determined by turning the equipment off and on, the user is encouraged to try to correct the interference by one or more of the following measures:

"This device complies with Industry Canada's licence-exempt RSSs. Operation is subject to the following two conditions:

- (1) This device may not cause interference, and
- (2) This device must accept any interference, including interference that may cause undesired operation of the device."

"This radio transmitter (identify the device by certification number, or model number if Category II) has been approved by Industry Canada to operate with the antenna types listed below with the maximum permissible gain indicated. Antenna types not included in this list, having a gain greater than the maximum gain indicated for that type, are strictly prohibited for use with this device."

"Caution: To maintain the compliance with the RF exposure guideline, place the unit at least 20 cm from nearby persons."

Le présent appareil est conforme aux CNR d'Industrie Canada applicables aux appareils radio exempts de licence.

Le fonctionnement est autorisé aux deux conditions suivantes :

- 1) l'appareil ne doit pas produire de brouillage;
- 2) l'appareil doit accepter tout brouillage radioélectrique subi, même si le brouillage est susceptible d'en compromettre le fonctionnement.

Le présent émetteur (identifier l'appareil par son numéro d'homologation ou par son numéro de modèle, s'il s'agit d'un appareil de catégorie II) a été approuvé par Industrie Canada pour fonctionner avec les types d'antennes énumérées ci-dessous et ayant un gain admissible maximal. Il est strictement interdit d'utiliser les types d'antennes non incluses dans cette liste, et dont le gain est supérieur au gain maximal indiqué, avec cet appareil.

Mise en garde : Pour assurer la conformité aux lignes directrices concernant l'exposition aux RF, placer l'appareil à au moins 20 cm des personnes.