

Limited Ninety-Day Warranty

This product is warranted by RadioShack against manufacturing defects in material and workmanship under normal use for ninety (90) days from the date of purchase from RadioShack company-owned stores and authorized RadioShack franchisees and dealers. EXCEPT AS PROVIDED HEREIN, RadioShack MAKES NO EXPRESS WARRANTIES AND ANY IMPLIED WARRANTIES, INCLUDING THOSE OF MERCHANTABILITY AND FITNESS FOR A PARTICULAR PURPOSE, ARE LIMITED IN DURATION TO THE DURATION OF THE WRITTEN LIMITED WARRANTIES CONTAINED HEREIN. EXCEPT AS PROVIDED HEREIN, RadioShack SHALL HAVE NO LIABILITY OR RESPONSIBILITY TO CUSTOMER OR AN OTHER PERSON OR ENTITY WITH RESPECT TO ANY LIABILITY, LOSS OR DAMAGE CAUSED DIRECTLY OR INDIRECTLY BY USE OR PERFORMANCE OF THE PRODUCT OR ARISING OUT OF ANY BREACH OF THIS WARRANTY, INCLUDING, BUT NOT LIMITED TO, ANY DAMAGES RESULTING FROM INCONVENIENCE, LOSS OF TIME, DATA, PROPERTY, REVENUE, OR PROFIT OR ANY INDIRECT, SPECIAL, INCIDENTAL, OR CONSEQUENTIAL DAMAGES, EVEN IF RadioShack HAS BEEN ADVISED OF THE POSSIBILITY OF SUCH DAMAGES.

Some states do not allow the limitations on how long an implied warranty lasts or the exclusion of incidental or consequential damages, so the above limitations or exclusions may not apply to you. In the event of a product defect during the warranty period, take the product and the RadioShack sales receipt as proof of purchase date to any RadioShack store. RadioShack will, at its option, unless otherwise provided by law: (a) correct the defect by product repair without charge for parts and labor; (b) replace the product with one of the same or similar design; or (c) refund the purchase price. All replaced parts and products, and products on which a refund is made, become the property of RadioShack. New or reconditioned parts and products may be used in the performance of warranty service. Repaired or replaced parts and products are warranted for the remainder of the original warranty period. You will be charged for repair or replacement of the product made after the expiration of the warranty period.

This warranty does not cover: (a) damage or failure caused by or attributable to acts of God, abuse, accident, misuse, improper or abnormal usage, failure to follow instructions, improper installation or maintenance, alteration, lightning or other incidence of excess voltage or current; (b) any repairs other than those provided by a RadioShack Authorized Service Facility; (c) consumables such as fuses or batteries; (d) cosmetic damage; (e) transportation, shipping or insurance costs; or (f) costs of product removal, installation, set-up service adjustment or reinstallation.

This warranty gives you specific legal rights, and you may also have other rights which vary from state to state.

RadioShack Customer Relations, 200 Taylor Street, 6th Floor, Fort Worth, TX 76102

We Service What We Sell

04/99

Please read before using this equipment.

MINI ATV

RadioShack
A Division of Tandy Corporation
Fort Worth, Texas 76102

INS-2303-52
Printed in China



RadioShack®

FEATURES

Your RadioShack **MINI ATV** is a winner! Built to 1/12 scale, it can reach speeds of up to 720 feet per minute. The vehicle's precise steering gives you control over the Road Rustler anywhere it goes. Enjoy the excitement of the Road Rustler's speed and sharp turns, and use the controls to rock the vehicle from side to side, pop a wheelie, or spin out! The driver even leans to the left or right as the vehicle banks into turns!

The **MINI ATV** comes in two frequencies (27 MHz and 49 MHz), so you and your friends can drive together. Check the box to see which frequency you have.

Note: You need these items, available at your local RadioShack store) to power your **MINI ATV**

- one 9-volt battery for the transmitter
- one 9.6-volt rechargeable battery pack for the vehicle
- one battery pack charger

Warning: Your **MINI ATV** can reach higher speeds than most other radio-controlled cars. Be careful when you use the vehicle to avoid high-impact collisions with people and objects.

© 1999 Tandy Corporation.
All Rights Reserved.

RadioShack is a registered trademark used by Tandy Corporation.

PREPARATION

ATTACHING THE TRANSMITTER'S ANTENNA

Thread the antenna into the transmitter's antenna connector. Make sure the connection is tight.

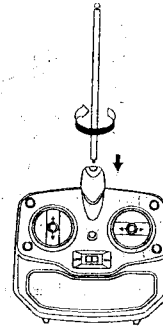

INSTALLING BATTERIES

Warning: Dispose of batteries and the battery pack promptly and properly; do not bury or burn them.

Cautions:

- Use only a fresh battery of the required size and recommended type.
- If you do not plan to use the vehicle for a week or more, remove the battery from the transmitter and the battery pack from the vehicle. Batteries can leak chemicals that can damage electronic parts.
- Never leave dead or weak batteries in the transmitter or the vehicle.

In the Transmitter

You need one 9-volt battery to power the transmitter. For the best performance and longest life, we recommend a RadioShack alkaline battery.

1. Slide the transmitter's OFF/ON switch to OFF.

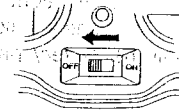

2. Slide the battery compartment cover in the direction of the arrow marked on it and slide the cover off.

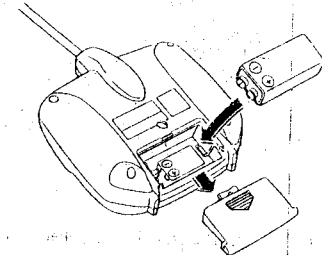

3. Put the battery in the compartment as indicated by the polarity symbols (+ and -) marked inside.
4. Replace the cover and snap it shut.

When the transmitter's range decreases, replace its battery.

In the Road Rustler

You need one 9.6-volt rechargeable battery pack to power the motor. Before you use the battery pack, you must charge it using a special battery charger (both items available at your local RadioShack store).

Follow the charger's directions to charge the battery pack. Then follow these steps to install the battery pack in the Road Rustler.

1. Slide the vehicle's ON/OFF switch to OFF.

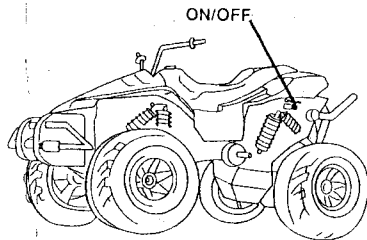

2. Press the tab on the battery compartment cover and slide the cover in the direction of the arrow marked on it. Then remove the cover.

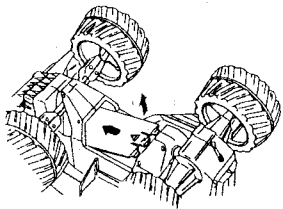

3. Attach the battery pack's connector to the vehicle's matching connector. Do not force them! They fit together only one way.

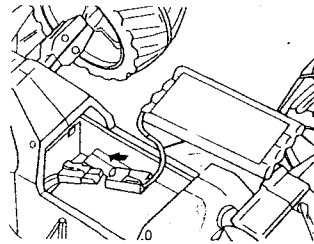

4. Put the connectors in the groove on the side of the battery compartment. Then put the battery pack in the battery compartment.
5. Close the cover and snap it shut.

As the vehicle loses power, its turns become wider. When this happens, change the battery pack or recharge it according to the battery charger's supplied instructions.

Cautions:

- Use only the recommended battery pack and charger.
- Do not charge or recharge the battery pack while it is in the vehicle.

Notes:

- If you want to drive your Road Rustler for longer periods, we suggest purchasing an extra battery pack. You can charge one while you use the other.

- When you disconnect the battery pack from the charger, do not pull on the connector's wires. This can damage the battery pack.
- Do not recharge a battery pack immediately after use (while it is still hot). Allow it to cool first.
- To easily remove the battery pack, press down on the end near the battery connector. The battery pack pops out.

Important: This vehicle can use nickel-cadmium rechargeable batteries. At the end of a nickel-cadmium battery's useful life, it must be recycled or disposed of properly. Contact your local, county, or state hazardous waste management authorities for information on recycling or disposal programs in your area or call 1-800-843-7422. Some options that might be available are: municipal curbside collection, drop-off boxes at retailers such as your local RadioShack store, recycling collection centers, and mail-back programs.



Warning: Never play with your Road Rustler in the street.

Caution: To avoid crashes, always watch where the vehicle is going.

1. Seat the rider on the Road Rustler. Slide his hands onto the handles and his feet onto the footrests. Rotate the pedal clips to secure his feet to the footrests.

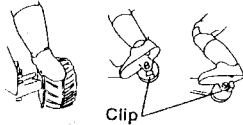
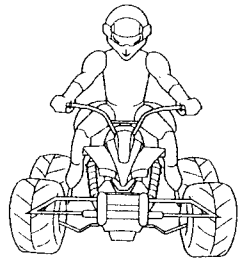

2. Extend the transmitter's antenna to its full length. For maximum range, hold the transmitter with the antenna as high as possible and pointing straight up.

3. Slide the transmitter's OFF/ON switch to ON.

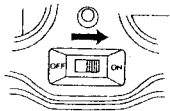

4. Slide the vehicle's ON/OFF switch to ON.

6

5. Use the transmitter's control levers to drive and steer the Road Rustler.

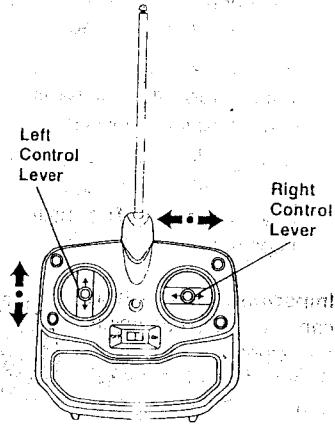

Left Control Lever

- Push forward to move forward.
- Push forward further for higher speed.
- Push forward all the way for maximum speed.
- Pull backward to move back.
- Pull backward all the way for maximum reverse.

Right Control Lever

- Push left to turn left.
- Push right to turn right.
- Release to go straight.

Also, see "Driving Hints" on Page 7.

6. When you finish driving the Road Rustler, slide the vehicle's ON/OFF switch to OFF and the transmitter's OFF/ON switch to OFF.

Cautions:

- Do not touch the motor immediately after using the vehicle, as the motor becomes hot during use.
- If the vehicle gets stuck under an object, immediately slide the transmitter's ON/OFF switch to OFF. Then retrieve the vehicle.

Driving Hints

- **Rocking Action** — You can make the vehicle rock from side to side as it moves forward or backward by moving the right control lever rapidly from right to left.
- **Wheelie Action** — You can make the vehicle do a wheelie by moving the left control lever to maximum reverse, then quickly moving the control to forward.
- **Spinning Action** — While doing a wheelie, move the right control lever rapidly from right to left to make the vehicle spin.

HELPFUL HINTS

These hints can help you get the most enjoyment from your Road Rustler.

- Running your vehicle continuously for long periods generates high heat levels. Heat causes wear and tear

on the motor. To help keep heat levels down, when your vehicle's battery pack dies, let the vehicle cool at least 10 minutes before installing a newly charged battery pack.

- The **MINI ATV** has a special circuit to prolong battery life. If you keep the left control lever in one position continuously for 30 seconds, the transmitter automatically shuts off. If this happens, move the left control lever to another position to continue driving.
- If someone uses a CB nearby, it might interfere with control of the vehicle. If this happens, move the vehicle and the transmitter away from the CB.
- You cannot operate your vehicle near devices with transmitters that use the same frequency as your vehicle (27 or 49 MHz). Check the box to see which frequency you have.
- Be sure the vehicle is not out of the transmitter's range. The range depends on the surroundings and on battery strength. Obstructions such as buildings, fences, and so on, between the transmitter and the vehicle, reduce the range.
- If the vehicle moves slowly and you have installed a fully charged battery pack, check the wheel mechanisms for lint, thread, hair, or dust.

7

The following suggestions will help you care for your RadioShack Road Rustler so you can enjoy it for years.

- Do not drive the vehicle through puddles or mud, on a wet floor, or in sand, rain, or snow. These can damage it.
- Do not expose the vehicle or transmitter to temperature extremes, and do not store them in direct sunlight or near a heat source.
- Do not leave the vehicle or transmitter outside overnight. Night dampness can damage their electronic circuits.
- To protect the vehicle's mechanisms from lint and hair, do not drive the vehicle on carpet.
- Wipe the vehicle and transmitter with a damp cloth occasionally to keep them looking new. Do not use harsh chemicals to clean them.

Modifying or tampering with the vehicle's or transmitter's internal components can cause a malfunction and might invalidate the vehicle's warranty and void your FCC authorization to operate it. If your vehicle is not performing as it should, take it and the transmitter to your local RadioShack store for assistance. Changes or modifications to this product not expressly approved by RadioShack, or operation of this product in any way other than as detailed by the Owner's Manual, could void your authority to operate the product.

THE FCC WANTS YOU TO KNOW

Your **MINI ATV** and its transmitter might cause TV or radio interference even when they are operating properly. To determine whether your vehicle and transmitter are causing the interference, turn them off. If the interference goes away, your vehicle and transmitter are causing it. Try to eliminate the interference by:

- moving your vehicle and transmitter away from the TV or radio
- contacting your local RadioShack store for help

If you cannot eliminate the interference, the FCC requires that you stop using your Road Rustler and its transmitter.

This device complies with Part 15 of the *FCC Rules*. Operation is subject to the following two conditions:

1. This device may not cause harmful interference and
2. This device must accept any interference received, including interference that may cause undesired operation.

USER-REPLACEABLE PARTS

You can order these easily replaceable parts for your **MINI ATV** at your local RadioShack store. Simply identify the part(s) you need from this exploded view, then find the part number in the list on Page 10.

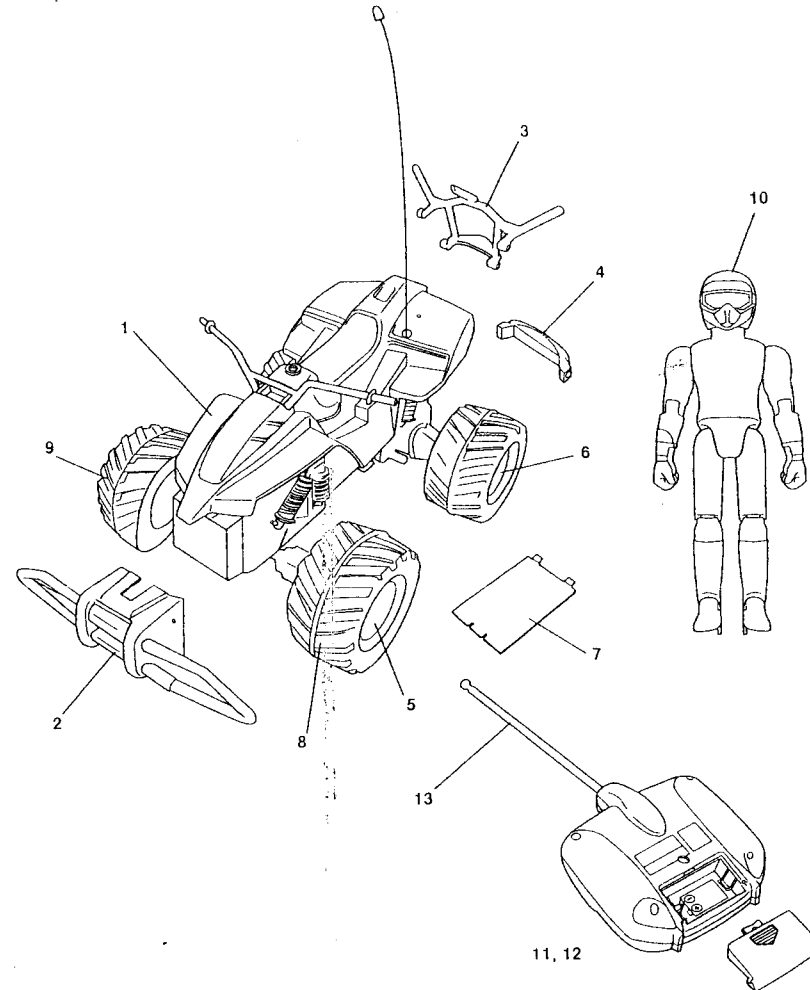

NOTES

Ref. No.	Description	RSU #	NP Parts #
1	Body Set Body Driver Handle Antenna, Receiver Washer Lug Washer Tooth Flange 3 x 10 Pan Head 3 x 10	12184610	Z-92032
2	Bumper, Front	12184628	Z-92033
3	Bumper, Rear	12184636	Z-92034
4	Link, Rear	12184644	RA-90369
5	Wheel, Front	11964467	Z-90337
6	Wheel, Rear	11964475	Z-90338
7	Cover, Battery	11964459	DB-90190
8	Tire, Left	11964483	Z-90389
9	Tire, Right	11964491	Z-90390
10	Rider Figure	12051421	Z-92035
11	Transmitter Kit, 27 MHz	12051421	ZA-90139
12	Transmitter Kit, 49 MHz	12067419	ZA-90161
13	Antenna, Transmitter	11964574	A-90052
14*	Manual, Service	12193397	MS-6004235
15*	Manual, Owner's	12193405	MU-6004235

*Not shown in exploded view