

*** CAUTION**

《 If misuse of rechargeable battery, it cause fever, damage, fire and leakage. Pay attentn as below. 》

- Charge the battery according to the instruction.
- Use only indicated batteries.
- Install the battery with + & - correctly.
- After playing, surely switch off and remove the battery from the car.
- Absolutely do not make short-circuited due to a lot of electric current.
- Do not disassemble, modify or soldring your car, it causes fire, injury or unexpected accident.
- Do not put your car into water and fire, or heat the car, it causes fire, injury or unexpected accident.
- Do not use, charge and keep your car near fire, at the place with direct sunshine, at high temperature or high humidity place or inside the car.

《 In case of misuse of the batteries, it causes fever. damage, fire or leakage. Pay attention as below. 》

- Install the batteires with + & - correctly.
- After use, surely switch off and remove the batteries from your car.
- Do not make short-circuited, disassemble, heat or put in water or fire.
- If liquied from the batteries put in your eye, wash by a lot of water immediatly and go to the doctor.
- If the liquid put on your skin or clothes, wash it by water.

《 To avoid unexpected accident, pay attention as below. 》

- Do not paly at the driving road or crowded place. Please play at the safety place outside.
- Do not force to bend the antenna of controller, if it is broken, possible to injure by sharpening edge.
- If there is thunder, please stop playing immediatly. It may cause thunderbolt.
- Do not hit or brandish your car.
- Be careful not to breke the glass or furniture if you play indoor.
- Be careful not to be rolled your finger, hair or clothes in the car wheels.
- Do not use your car at the place there are under age children, or do not make under children use this car it may cause unexpected accident or injury.
- Do not use this car except radio controlled use.

ATTENTION

This product is using electrical circuit and a lot of parts, do not disassemble or modify your car.
Do not use at the more than 2cm depth water.
Do not sink the car in the water.
Do not keep the car in the water after playing. The water may put into the car.
Do not put the car near the fire or high temperature place, such as near the stove.

FREQUENCY

Playing the cars in same frequency at the near place, it may cause out of control.
In case of interference except radio control, it may cause out of control.
In this case, please move the place for playing.

BATTERY

After playing, surely switch off of car and controller. If you miss to switch off, the car continue to play and the batteries exaust quickly.
Do not mix the old and new batteries.

CONTENTS

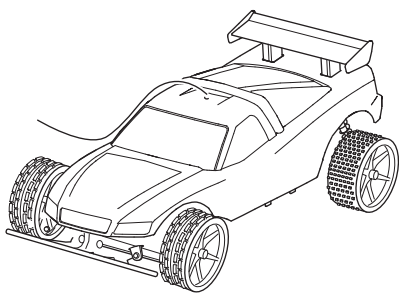

Car x 1

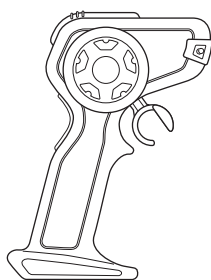

Controller x 1

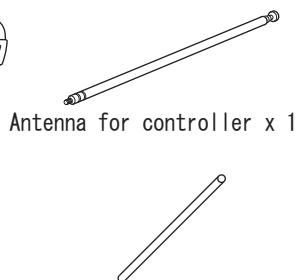

Antenna for controller x 1

Antenna tube x 1



Instruction manual x 1

※実際の商品とイラストは多少異なります。

CAR PARTS

car

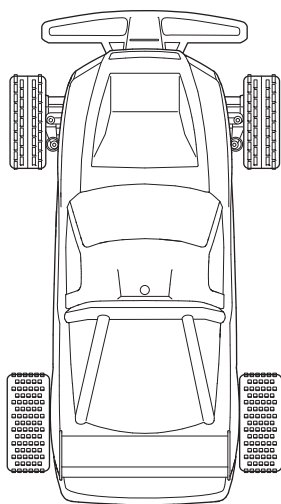

Trim adjusting lever

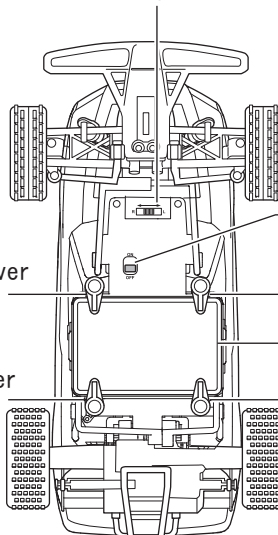

Power switch
There is a cover for waterproof

Battery cover lock

Battery cover lock

Battery cover lock

Battery cover lock

controller

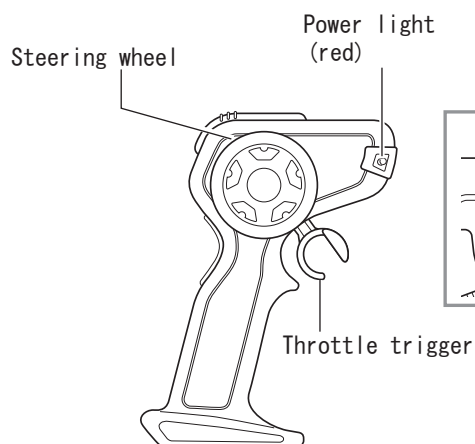

Steering wheel

Power light (red)

Throttle trigger

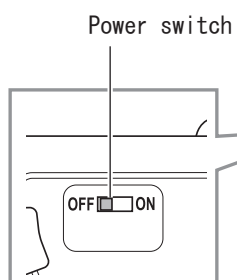

Power switch

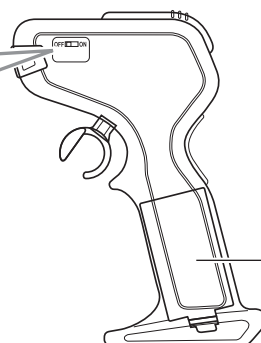

Battery cover

■ Operation distance

SPECIFICATIONS

- Frequency : 27 MHz
- Operating distance : Approx. 15m
- Full action : Forward, backward, right, left and stop

Car

- Battery : AA x 6pcs (not included)
- ** Do not use manganese batteries.
- ** AA rechargeable batteries can be used.
- Operation time : Approx. 30 min.
(in case of new alkaline batteries)

Controller

- Battery : AA x 3pcs (not included)
- ** Do not use manganese batteries.
- ** AA rechargeable batteries can be used.
- ** When controller batteries are exhausted, power light (red) is put out. Please change to new batteries then.

- Operation time : Approx. 4 hours
(Using new alkaline batteries)

※Operating time may vary according to the kind of batteries or how to use.

SAFETY MODE

During driving on the rough road or continuous driving, the car may stop or speed down automatically by working the protect function to avoid car damage or battery heat. In this case, please release the function as below.

1. Switch the car off.
2. Cool down the car by holding it at cooler place more than 15min. then driving function will recover.



ATTENTION

- Do not wash the car or put the car in the water when you cool the car down.

Waterproof (Same level as JIS 4 level)

This product is not completely waterproofed. Pay attention as below.

can be used	cannot be used	
<ul style="list-style-type: none"> ● Pools under 2cm depth or water side. ● In the light rain ● Wash the dirty of tire 	<ul style="list-style-type: none"> ● More than 2cm depth water. ● Driving at seaside or put the car in the sea. ● Diring in the bath or hot spring ● In the heavy rain. 	<ul style="list-style-type: none"> ● Put in the bucket water inside. ● Diring in the mud. ● Driving or wash the car with removing the battery cover.



ATTENTION

- Do not drive at pond or any other place which water is deep. If more than 7cm water depth the car is floated, the water come into the car and it may cause damage or accident.

How to install the battery in the controller

① Check the power switch of the controller off.

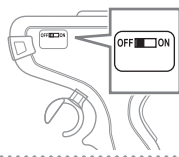

③ Put the AA battery in correct polarity as right picture.

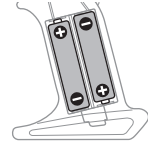

② Open the battery cover by pushing the claw of the back side.



④ Close the battery cover

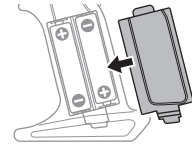

* When the batteries are exhaust, Power lump (red) is put out and cannot operate the car. In this case, please change to new batateries.

How to assemble and disassemble the antenna for controller

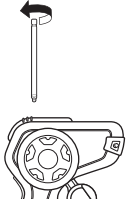

How to assemble the antenna

Screw the antenna in the direction of above picture to pot into controller correctly.

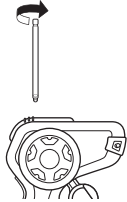

How to disassemble the antenna

Screw out the antenna in the direction of above picture and remove from the controller

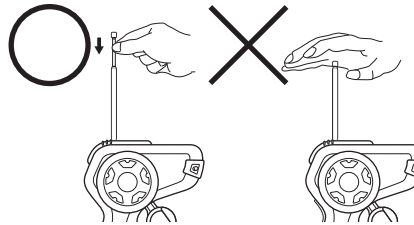

To avoid antenna broken

When shorten the antenna, to shorten step by step from the under level. Do not shorten by pusing the top of the antenna.

How to install the battery in the car

① Chek the power switch of the back side off.

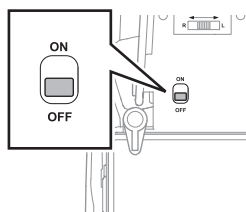

③ Put the batteries in correct polarity as per right picture.

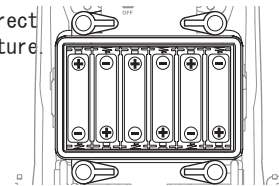

② Release the lock of the battery cover by turning as right picture and remove the battery cover.

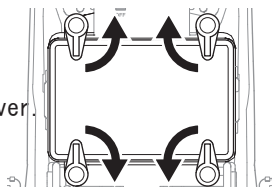

④ Put the battery cover on and close it by locking as right picture.

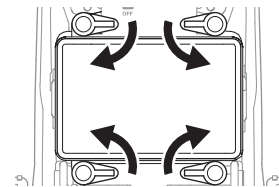

How to operate the car

- ① Put the antennal tube in the car body firmly and tie the top of the antenna.

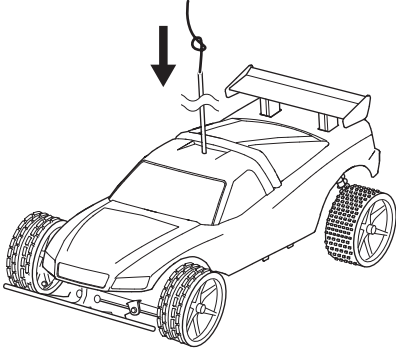

- ② Put the power switch on.

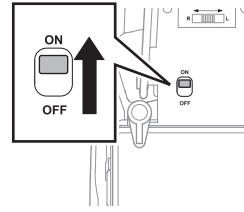

- ③ Extend the controller antenna and put the controller switch on, then power lump (red) is light on.

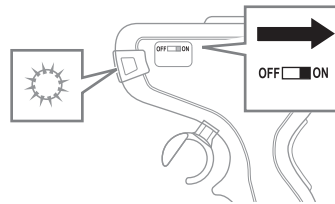

Forward

Pull the throttle trigger in arrows direction, the car go to forward.

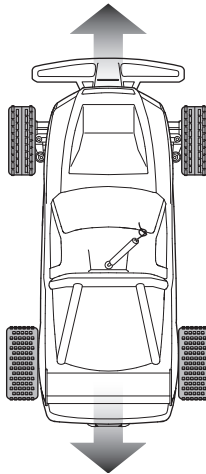
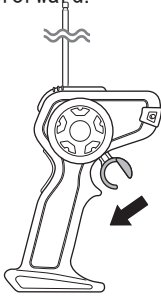

Backward

Push the throttle trigger to arrows directly, the car go to backward.

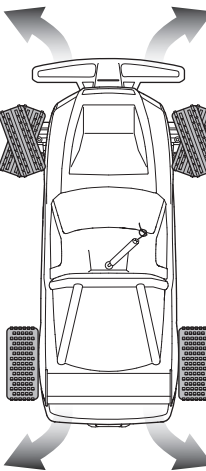
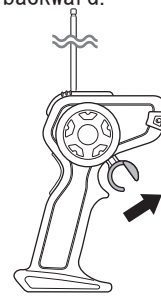

Left

Turn the steering wheel to arrows directly with operating throttle trigger.

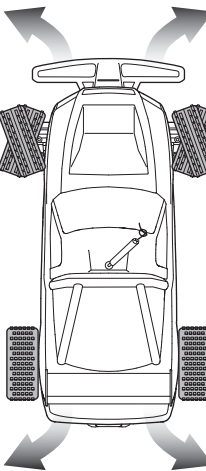
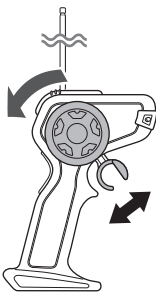

Right

Turn the steering wheel to arrows directly with operating throttle trigger.

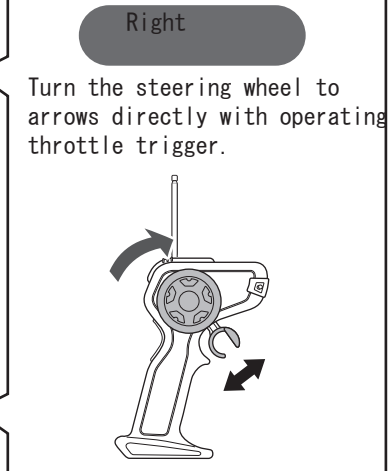
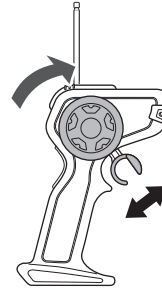

Trim adjustment

If the car does not run straight even flat surface, adjust the trim lever at the back of the car.
If the car turns left.

Move the trim adjustment lever to R side.

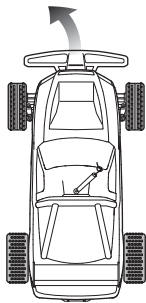

Trim adjustment lever

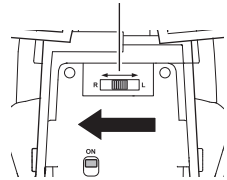

Back of the car

If the car turns right.

Move the trim adjustment lever to L side.

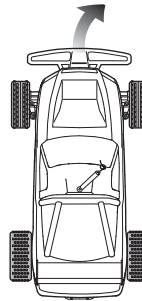

Trim adjustment lever

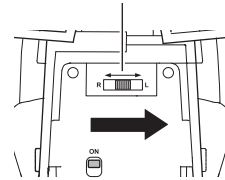

Back of the car

! Pay attention when drive the car continuously

+ When drive the car continuously after changing to new batteries, surely hold playing more than 15 minutes and cool down the car, or the car may not work due to safety function will work.

After paying

① Switch the car and controller off.

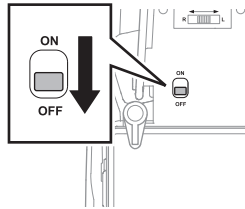

② Remove the battery from the controller after confirming the power lamp is off.

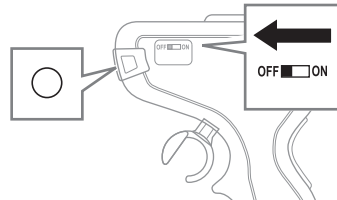

Maintenance after playing

Ensure the no damage. Remove the sand or stones in the pattern of the tyres.
Wipe by dry cloth after washing.

! Attention when wash the car

- When wash the car, do not remove the battery cover, it causes out of order by water.

! Attention for keeping the car

-Do not keep at the place having direct sunshine, high temperature, high humidity and the inside the car.
It may cause short-circuited, heat or fire.

+ Ensure to switch the car and controller off.

+ Keep the car with removing the battery from the car.
It may cause the damage by water.

Trouble shooting

Condition	Reason	How to settle it	Ref. pag
The car cannot drive	The batteries are put in wrong polarity	Install the batteries in correct polarity.	page 4
	Batteries are exhaust,	Change the all batteries to new one.	page 4
	Safety function is working as the car is heating up by driving rough road or continuously driving.	Hold to drive more than 15 minutes and cool down the car.	page 3
The car is out of control	Batteires are exhausted.	Change the all batteries to new one.	page 4
	Same frequency radio controlled is operated at near	Change the place or operate later.	page 1
	There is interference		page 1
Controller power lamp is dark	Controller batteries are exhausted.	Change the all batteries to new one	page 4

This device complies with Part 15 of the FCC Rules. Operations is subject to the following two conditions: (1) this device may not cause harmful interference, and (2) this device must accept any interference received, including interference that may cause undesired operation.

Warning: Changes or modifications to this unit not expressly approved by the party responsible for compliance could void the user's authority to operate the equipment.

NOTE: This equipment has been tested and found to comply with the limits for a Class B digital device, pursuant to part 15 of the FCC Rules. These limits are designed to provide reasonable protection against harmful interference in a residential installation. This equipment generates, uses and can radiate radio frequency energy and, if not installed and used in accordance with the instructions, may cause harmful interference to radio communications.

However, there is no guarantee that interference will not occur in a particular installation. If this equipment does cause harmful interference to radio or television reception, which correct the interference by one or more of the following measures:

- * Reorient or relocate the receiving antenna.
- * Increase the separation between the equipment and receiver.
- * Connect the equipment into an outlet on a circuit difference from that to which the receiver is needed.
- * Consult the dealer or an experienced radio/TV technician for help.