

# BLUETOOTH CORDED 2-LINE TELEPHONE

Model number:

30385



# Thank you for choosing GE!

## Register your product

---

Please take a moment to register your product online. Just go to **www.gephones.com** and click “register here” from the home page. Provide your email address and receive product updates, special offers, or discounts on future purchases.

\* It will not diminish your warranty rights if you choose not to register.

## Assistance and more information

Retain your sales receipt as proof of purchase in the event warranty service is necessary.

For product assistance or for more information about accessories, visit our website at **www.gephones.com** or call our customer service center at **1-877-394-9775**.

Attach your sales receipt here.

# Table of contents

## Getting started

Parts checklist.....	1
Installing on a desk.....	2
Telephone jack requirements.....	5
Wall mount installation.....	5
Telephone base layout.....	10
Telephone base layout.....	11
Side view layout.....	12
Scroll wheel.....	12
Telephone base screen display icon.....	13
Paired devices.....	14
To pair a cell phone.....	14
To pair a headset.....	14
o remove a paired device.....	15
Active Devices.....	15
To activate a paired device.....	15
To connect/disconnect an active device.....	16
To remove an active device.....	16
To add a device on the active devices list.....	17
Information about an active device.....	17
Directory Download.....	18
Bluetooth Base name.....	18
Base PIN.....	19
Auto Connect.....	19

## Telephone base settings

Display language.....	20
Ring tones.....	20
Ring volume.....	20
Key beeps.....	20
Equalizer.....	21
Priority Line.....	21
Local area code.....	21
Date and time.....	22
Date Format.....	22
Time Format.....	22
Alarm.....	23
Alarm tone.....	23
Clear voicemail indicator.....	24
Reset setting.....	24

## Telephone operation

To make, answer or end a call.....	25
To make a Line 2 call while on Line 1 call.....	25
To make a Line 1 call while on Line 2 Call.....	25
Call Waiting.....	26
3-way conference call.....	26
Muting a call.....	26
Speakerphone.....	26

Volume control.....	26
Equalizer.....	27
Silencing the ringer.....	27
To put a call on hold.....	27
To make a call using the redial memory.....	27
To save a number from the redial list to the phonebook.....	27
To delete a number from the redial list.....	28
Voice message indicator.....	28
Answering system message indicator.....	28
Line-in-use indicator.....	29

## Phonebook

Add a local phonebook record.....	30
To view/call a phonebook entry.....	30
To search a phonebook entry alphabetically.....	31
Edit a phonebook entry.....	31
Delete a phonebook entry.....	31
Delete all phonebook entries.....	32
Phonebook capacity.....	32
Direct memory.....	32
Character table.....	33

## Caller ID

Using Caller ID service.....	34
Phonebook Caller-ID matching.....	34
Review/call from the call log.....	34
Save a number to the Local Phonebook.....	34
Delete a caller ID record.....	35
Delete all caller ID records.....	35
Call log display screen messages.....	35

## Answering system

Answering system and voice mail.....	36
Turning the answering system on or off.....	36
Message capacity.....	36
New message indicators for Line 1 and Line 2.....	36
Recording memos.....	36
Listening to Outgoing Announcement (OGA).....	37
Recording Outgoing Announcement (OGA).....	38
Deleting your recorded Outgoing Announcement (OGA).....	38
Number of rings before the system answers.....	39
Message length.....	39
Turning the message alert on or off.....	40
Turning the call screening on or off.....	40
Call intercept.....	40

Message playback using the telephone	
base.....	41
Options during playback:.....	41
Delete all old messages.....	41
Changing the security code for remote	
access .....	42
Access the answering system remotely .....	42
Remote access commands .....	42

## **Appendix**

Troubleshooting guide .....	43
General Product Care .....	45
Important Safety Instructions .....	46
FCC Parts 15, 68 and ACTA.....	49
One Year Limited Warranty .....	53
Technical specification .....	55
Index.....	56
Remote access operation card.....	57

# Getting started

## Parts checklist

Your telephone contains the following items. Save your sales receipt and original packaging in the event warranty service is necessary.

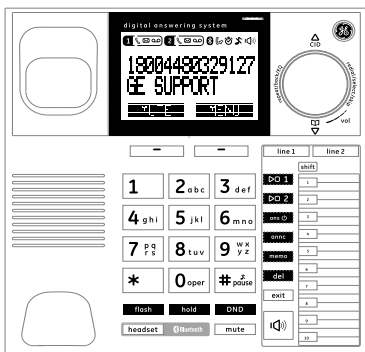

Telephone base

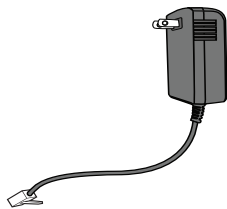

Power adapter for telephone base

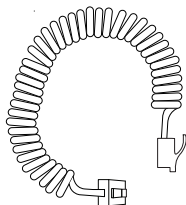

Handset coiled cord



Corded handset



**Gray** color telephone line cord for **Line 1 + Line 2** (4-pin)

**Black** color telephone line cord for **Line 2** (2-pin)

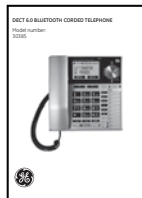

User's guide

# Getting started

## Installing on a desk

---

1. Remove the base bracket by lifting it up from both sides of the bracket as shown in Figure 1 below.

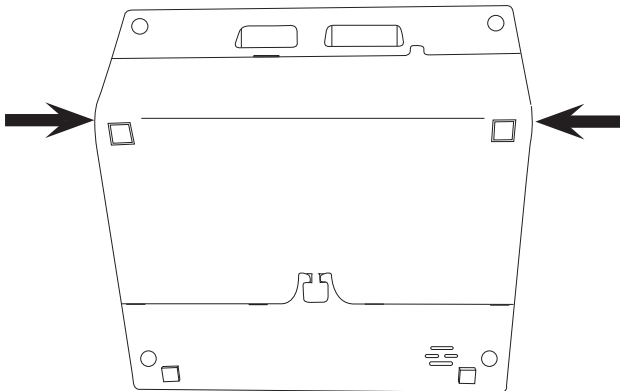

Figure 1

2. Plug one end of the coiled handset cord into the jack at the bottom of the telephone base as shown in figure 2. Plug the other end of the coiled cord into the bottom of the handset making sure that the plug is snapped into place and flush with the bottom of the handset. Then route the coiled cord through the tabbed slot as shown.
3. Slide the desk/wall switch to the desk position.

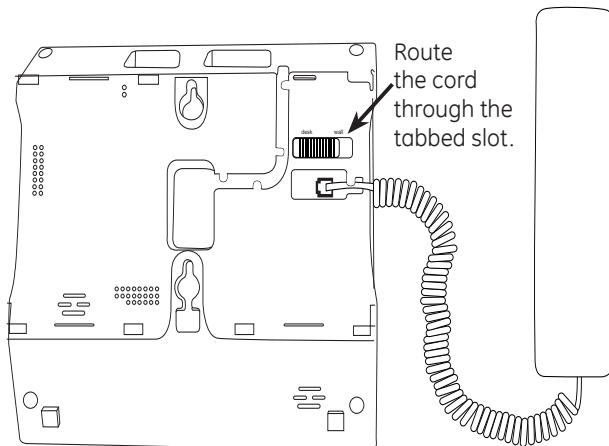

Figure 2

## Getting started

4. Replace the bracket to the telephone base.
5. Plug the smaller end of the power adapter into the power jack at the back of the telephone base.
6. Plug the larger end of the power adapter into an electrical outlet not controlled by a wall switch.

Note that there is 1 power jack and 2 phone jacks at the back of the telephone base as shown in Figure 3.

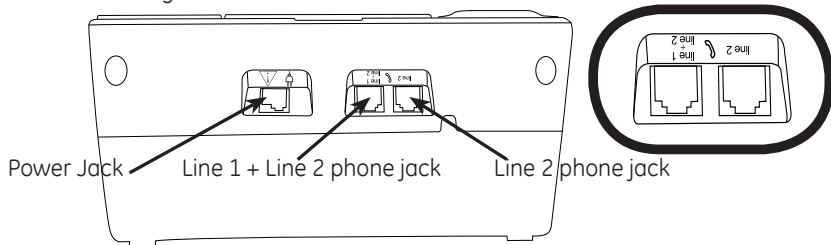

Figure 3

**If both of your telephone lines are located in one wall jack, go to step 7. If your telephone lines are in two separate jacks, go to step 9.**

7. Plug one end of the 4-pin gray-color telephone line cord into the **Line 1 + Line 2** jack at the back of the telephone base as shown in Figure 4.
8. Plug the other end of the telephone line into a telephone wall jack.

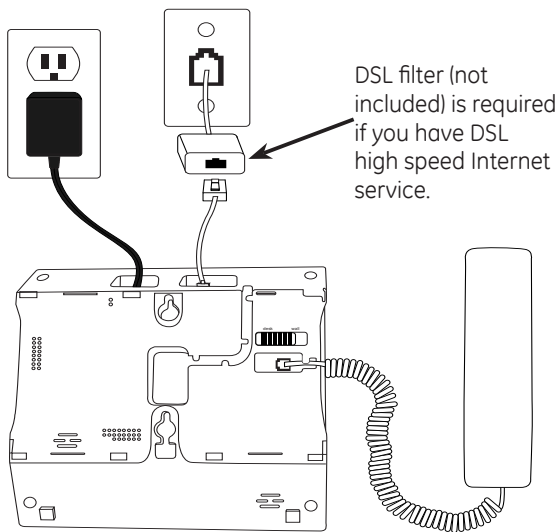

Figure 4

## Getting started

If you have separate wall jacks for each line, install the telephone base as described below.

9. Plug one end of the 4-pin gray-color telephone line cord into the **Line 1 + Line 2** jack at the back of the telephone base as shown in Figure 5.
10. Plug the other end of the 4-pin gray-color telephone line cord into the telephone wall jack you will use as your "line 1".
11. Plug one end of the 2-pin black-color telephone line cord into the **Line 2** jack at the back of the telephone base.
12. Plug the other end of the 2-pin black-color telephone line cord into the telephone wall jack you will use as your "line 2".
13. Press  **line 1** or  **line 2** as desired. The speakerphone is activated automatically.
14. If you hear a dial tone, the installation is complete.

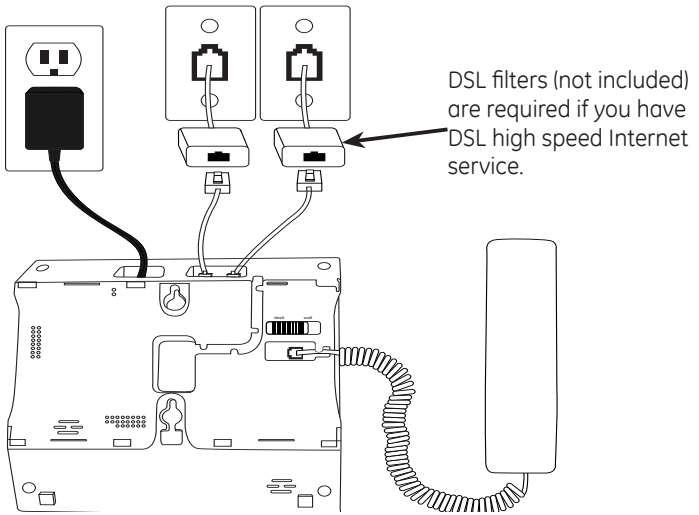

Figure 5

### CAUTION:

1. Use only the power adaptor that came with this unit. Using other power adaptors may damage the unit.
2. To prevent fire or electrical shock hazard, do not expose this product to rain or moisture.



# Getting started

## Telephone jack requirements

---

To use this phone, you need a RJ11C type modular telephone jack, which might look like the one pictured here, installed in your home. If you do not have a modular jack, call your telephone service provider to find out how to have one installed.

If you have DSL high speed Internet service, a DSL filter is required (not included). Contact your DSL service provider for more information about DSL filter.

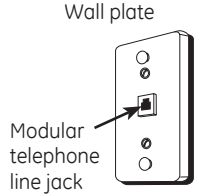

## Wall mount installation

---

1. Make sure the telephone line cord is unplugged from the modular jack and the power adapter cord is unplugged from the electrical outlet before installation.
2. Remove the base bracket by lifting it up from both sides of the bracket as shown in Figure 6.

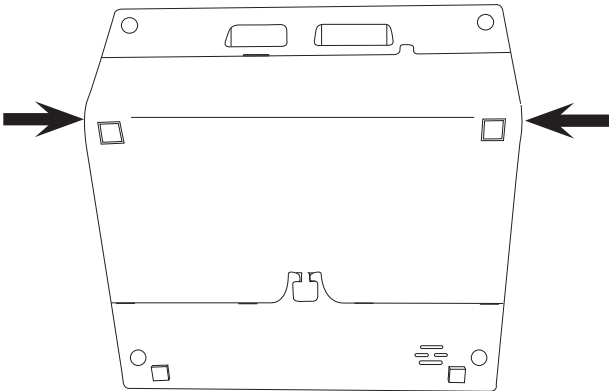

Figure 6

## Getting started

- Slide the wall mounting switch to the wall position as shown in Figure 7. This prevents the handset from falling out of the telephone base.

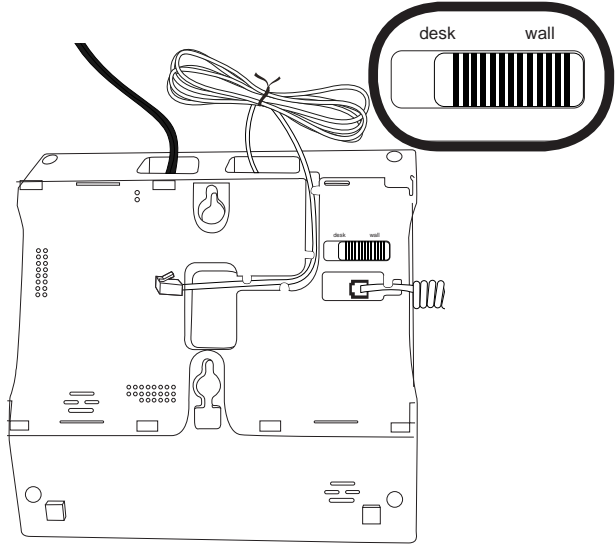

Figure 7

If both of your telephone lines are located in one wall jack, go to step 4. If your telephone lines are in two separate jacks, go to step 8.

- Route the 4-pin telephone line cord from the **Line 1 + Line 2** jack through the channel as shown in Figure 8, leaving about 2 inches from the end of the channel for plugging into the wall jack.

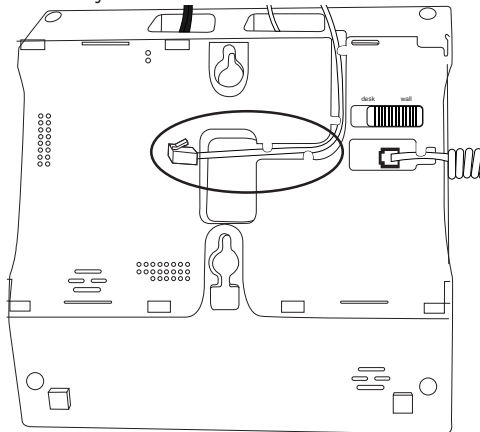

Figure 8

## Getting started

5. Plug the telephone line cord into the 2-line wall jack on the wall plate as shown in Figure 9. Align the holes on the telephone with the mounting studs of the wall plate and slide the telephone base down until it locks securely. Tie the excess cords neatly with a twist tie. Plug the power adapter into an electrical outlet. Be sure to avoid using an electrical outlet that is controlled by a wall switch.

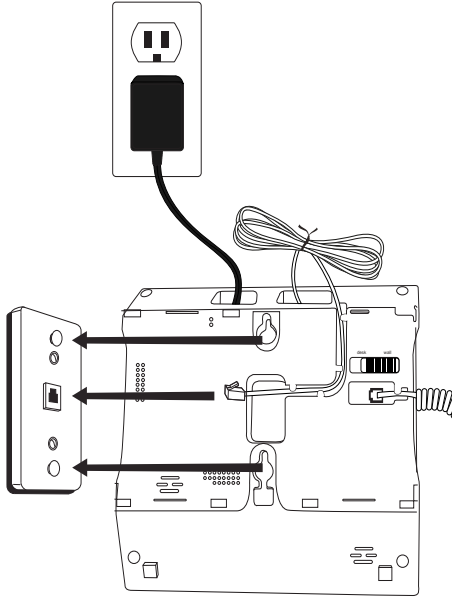

Figure 9

6. Press  or  as desired. The speakerphone is activated automatically.
7. If you hear a dial tone, the installation is complete.

## Getting started

If you have separate wall jacks for each line, mount the telephone base on the wall as described below.

8. Route the 4-pin gray-color telephone line cord from the **Line 1 + Line 2** jack through the channel as shown in Figure 8, leaving about 2 inches from the end of the channel for plugging into the wall jack.
9. Plug the 4-pin gray telephone line cord into the wall jack on the wall plate as shown in Figure 9. Align the holes on the telephone with the mounting studs of the wall plate and slide the telephone base down until it locks securely. Plug the power adapter into an electrical outlet as shown in Figure 10. Be sure to avoid using an electrical outlet that is controlled by a wall switch.
10. Plug one end of the 2-pin black-color telephone line cord into the **Line 2** jack and the other end into a different wall jack as shown in Figure 10.
11. Neatly tie both the excess telephone line cords with a twist tie so it is held on the top of the base unit.
12. Press  or  as desired. The speakerphone is activated automatically.
13. If you hear a dial tone, the installation is complete.

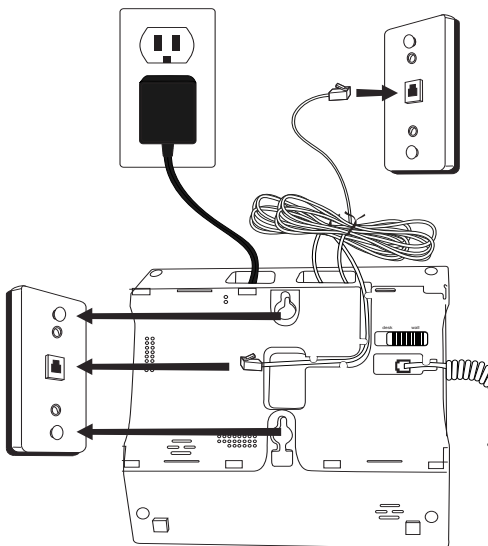

Figure 10

### CAUTION:

1. Use only the power adaptor that came with this unit. Using other power adaptors may damage the unit.
2. To prevent fire or electrical shock hazard, do not expose this product to rain or moisture.

## Overview

Your 30385 telephone system allows you to communicate with built-in Bluetooth wireless technology.

This product is compatible with many current Bluetooth-enabled headsets and cell phones. Refer to your headset or cell phone user's guide for information about using Bluetooth.

The telephone system allows you to:

- Pair up to 6 Bluetooth devices (cellular phone or bluetooth headset) with the telephone base.
- Connect a maximum of two devices (cellular phone or bluetooth headset) at a time.
- Connect a Bluetooth headset to make or receive calls on  or .
- Download phonebook from cellular phone to the telephone base. Note that it is NOT possible to make or receive calls on the Cell line by using the telephone base.
- Establish a 3-way conference call between the corded handset,  and .

# Overview

## Telephone base layout

### softkey

Press to select menu item displayed above the key.

### repeat/back/EQ

- Press to repeat current message or press twice to play previous message during message playback.
- Press to return to previous level when in menu.
- Press to adjust the equalizer when in idle mode or during a call.

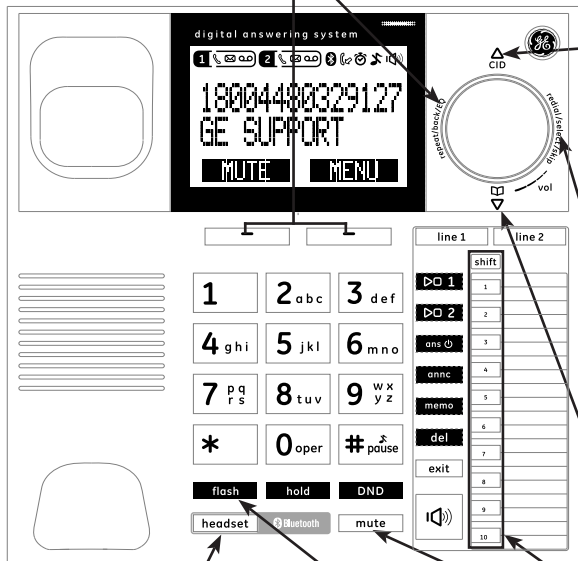

### △ CID

- Press to review the call log when the telephone is in idle mode.
- While in menu, press to scroll up.

### redial/select/skip

- Press to review redial list.
- Press to select in menu.
- Press to skip to the next message during playback.

### ▽ ▽

- Press to review the phonebook(s) when the telephone is in idle mode.
- While in menu, press to scroll down.

### headset

Press to make or receive call using a Bluetooth headset.

### flash

During a call, press to answer a second incoming call if you receive a call waiting alert (available only if you have subscribed to the call waiting feature from your telephone service provider).

### mute

Press to mute a call, press again to resume conversation.

### Quick dialing buttons

Press to call quick dialing memory location.

# Overview

## Telephone base layout

The diagram shows a telephone base with a display screen and a keypad. The display screen shows "digital answering system", "1 180044800329127", "GE SUPPORT", "MUTE", and "MENU". The keypad includes standard numeric keys (1-9, \*, 0), function keys (flash, hold, DND, headset, bluetooth, mute), and a vertical column of keys (line 1, line 2, shift, ans φ, annc, memo, del, exit, speaker). Callouts provide detailed instructions for each key.

**ans φ**  
Press to turn answering system on or off.

**▷ 2 2 play/stop**  
Press to play messages or stop playback on Line 2.

**▷ 1 1 play/stop**  
Press to play messages or stop playback on Line 1.

**line 1**  
Press to make or answer call on Line 1.

**line 2**  
Press to make or answer call on Line 2.

**annc**  
Press to play, record or delete outgoing announcement.

**memo**  
Press to record memo.

**del**  
Press to delete the entered number or character.

**exit**  
Press to exit a setting or operation and return to idle mode.

**speaker**  
Press to make or answer a call using the speakerphone.  
• Press to make or answer a call using the speakerphone.  
• During a call, press to switch between speakerphone and normal handset use.

**hold**  
Press to put a call on hold.

**Do not disturb**  
Press to turn Do Not Disturb mode on of off.

**# pause**

- Press and hold to add a dialing pause when dialing or entering numbers into phonebook.
- Press to switch between upper case and lower case when entering names into phonebook.
- Press to change the telephone number format (7 digits, 1+, or 1+ area code) for appropriate dialing.

## Overview

### Side view layout

---

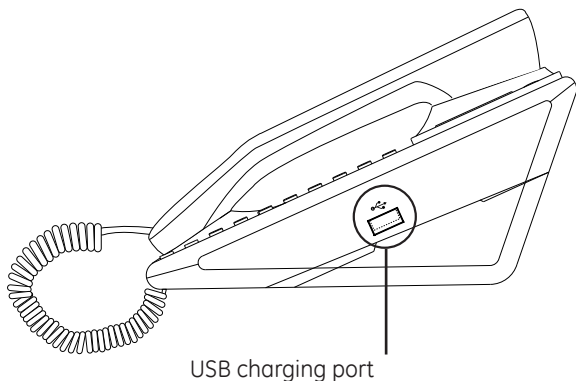

You can charge your Bluetooth cellular phone or headset by plugging the USB cable into the port on the right side of the telephone base.

## Scroll wheel

---



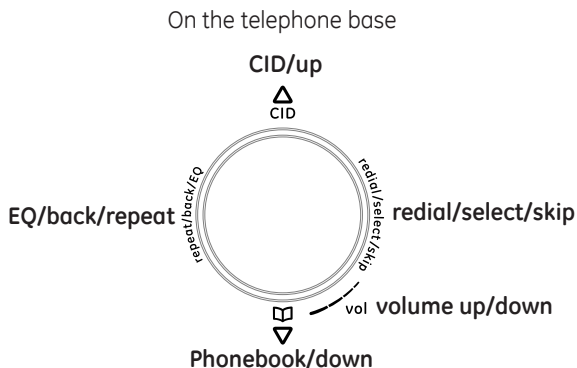







The scroll wheel on the telephone base can be used to navigate the menu or perform telephone operations.



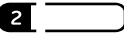

## Overview

### Telephone base screen display icon

Item	Meaning
	<ul style="list-style-type: none"><li>Displays when there is a new voice mail message. (Available only if you have subscribed to voice mail service from your telephone service provider.)</li></ul>
	<ul style="list-style-type: none"><li>Displays when speakerphone is in use.</li></ul>
	<ul style="list-style-type: none"><li>Displays when a paired device is connected.</li><li>Flashes when a call on the Cell line is on hold</li><li>Flashes when the telephone is pairing or connecting with a Bluetooth enabled device.</li></ul>
	<ul style="list-style-type: none"><li>Displays when the alarm is set.</li><li>Flashes during alarm ringing.</li></ul>
	<ul style="list-style-type: none"><li>Displays when there are new unreviewed calls.</li></ul>
	<ul style="list-style-type: none"><li>Displays when the ringer is turned off.</li><li>Displays when Do Not Disturb (DND) mode is activated.</li></ul>
	<ul style="list-style-type: none"><li>Displays when answering system is on.</li><li>Flashes when there are new messages.</li></ul>
	<ul style="list-style-type: none"><li><b>Line 1</b> icons will display in this area.</li></ul>
	<ul style="list-style-type: none"><li><b>Line 2</b> icons will display in this area.</li></ul>
	<ul style="list-style-type: none"><li>Displays when the line is in use.</li></ul>

## Bluetooth settings

To use a Bluetooth enabled cell phone with your telephone system, you must first pair and connect the device with the telephone base.

Bluetooth connection operates within 30 feet (10 meters) from the telephone base. Keep your Bluetooth-enabled devices close to the telephone base before starting the pairing procedures.







### Paired devices

---

The paired devices list stores all devices paired to the telephone base. Once a device is paired, you do not need to repeat the pairing procedure unless you remove the device from the paired device list. The system can store a maximum of 6 devices (cell phone or headset).







### To pair a cell phone

---

1. With the cell phone near the corded base of the 30385, press the **Menu** softkey.
2. Press   or use the scroll wheel to select **Bluetooth**, and then press the **Select** softkey.
3. Press   or use the scroll wheel to select **My Devices**, and then press the **Select** softkey.
4. Press   or use the scroll wheel to select **Add Cell Phone**, and then press the **Select** softkey.
5. The screen displays **Place the cell phone near the base**. Move your Bluetooth cell phone near the telephone base, then press the **Ok** softkey.
6. The screen displays **Please use your cell phone to search the base**, and then press the **Ok** softkey.
7. Turn the Bluetooth feature on your cell phone on and then search for the telephone base.
8. When your cell phone finds the telephone base, select **GE30385** on your cell phone to continue the pairing process.
9. The telephone base displays **XX Paired** and **XX Connected** where **XX** indicates your cell phone's name, and the telephone base displays the  icon when the pairing is successful.

### To pair a headset

---

1. Press the **Menu** softkey.
2. Press   or use the scroll wheel to select **Bluetooth**, and then press the **Select** softkey.
3. Press   or use the scroll wheel to select **My Devices**, and then press the **Select** softkey.
4. Press   or use the scroll wheel to select **Add Headset**, and then press the **Select** softkey.

## Bluetooth settings











5. The screen displays **Place the headset near the base**. Move your Bluetooth headset near the telephone base, and then press the **OK** softkey.
6. The screen displays **Please set your headset in discoverable mode**. Turn your Bluetooth headset to discoverable mode, and then press the **OK** softkey.
7. When the telephone base finds your headset, press the **Select** softkey.
8. The screen displays **XX Paired** when the pairing is successful.
9. The telephone base then asks if you want to connect your headset with the telephone base now. Press the **Yes** softkey to connect.

When the connection is successfully established, the screen displays **XX Connected** where **XX** indicates the name of your headset.

---

### o remove a paired device

You can remove a paired device from the **Paired Devices** list.

1. Press the **Menu** softkey.
2. Press   or use the scroll wheel to scroll to **Bluetooth**, and then press the **Select** softkey.
3. Press   or use the scroll wheel to select **My Devices**, and then press the **Select** softkey.
4. Press   or use the scroll wheel to select **Paired Devices**, and then press the **Select** softkey.
5. Press   or use the scroll wheel to select the desired device, and then press the **Select** softkey.
6. Press   or use the scroll wheel to select **Remove Paired**, and then press the **Select** softkey.
7. The screen displays **Remove?** Press the **Yes** softkey to confirm.

---





### Active Devices

Only devices on the **Active Devices** list can establish a Bluetooth connection with the telephone base. The **Active Device** list can store a maximum of two devices. Both devices can be connected to the telephone base, but only one of them can be used at a time.









---

### To activate a paired device

To allow a paired device to establish a Bluetooth connection to the telephone base, it must be activated.

1. Press the **Menu** softkey.
2. Press   or use the scroll wheel to select **Bluetooth**, and then press the **Select** softkey.
3. Press   or use the scroll wheel to select **My Devices**, and then press the **Select** softkey.











## Bluetooth settings

4. Press   or use the scroll wheel to select **Paired Devices**, and then press the **Select** softkey.
5. Press   or use the scroll wheel to select the desired device, and then press the **Select** softkey.
6. Press   or use the scroll wheel to select **Set Active**, and then press the **Select** softkey.
7. Press   or use the scroll wheel to select an empty location or replace an existing device, then press the **Select** softkey to confirm.

---

### To connect/disconnect an active device











You can connect or disconnect a device on the **Active Devices** list.

1. Press the **Menu** softkey.
2. Press   or use the scroll wheel to select **Bluetooth**, and then press the **Select** softkey.
3. Press   or use the scroll wheel to select **My Devices**, and then press the **Select** softkey.
4. Press   or use the scroll wheel to select **Active Devices**, and then press the **Select** softkey.
5. Press   or use the scroll wheel to select the desired device, and then press the **Select** softkey.
6. Press   or use the scroll wheel to select **Connect** or **Disconnect**, and then press the **Select** softkey.

---

### To remove an active device

You can remove a device on the **Active Devices** list.



















1. Press the **Menu** softkey.
2. Press   or use the scroll wheel to scroll to **Bluetooth**, and then press the **Select** softkey.
3. Press   or use the scroll wheel to select **My Devices**, and then press the **Select** softkey.
4. Press   or use the scroll wheel to select **Active Devices**, and then press the **Select** softkey.
5. Press   or use the scroll wheel to select the desired device, and then press the **Select** softkey.
6. Press   or use the scroll wheel to select **Remove**, and then press the **Select** softkey to confirm.

# Bluetooth settings

## To add a device on the active devices list

---















You can add a paired device to the **Active Devices** list.

1. Press the **Menu** softkey.
2. Press    or use the scroll wheel to scroll to **Bluetooth**, and then press the **Select** softkey.
3. Press    or use the scroll wheel to select **My Devices**, and then press the **Select** softkey.
4. Press    or use the scroll wheel to select **Active Devices**, and then press the **Select** softkey.
5. Press    or use the scroll wheel to select an empty location, and then press the **Add** softkey.
6. Press    or use the scroll wheel to select the desired paired device, and then press the **Select** softkey.
7. Press    or use the scroll wheel to select **Set Active**, and then press the **Select** softkey.

**NOTE:** If two devices are on the Active Devices List, you will need to remove one before adding another device.

## Information about an active device

---

1. Press the **Menu** softkey.
2. Press    or use the scroll wheel to scroll to **Bluetooth**, and then press the **Select** softkey.
3. Press    or use the scroll wheel to select **My Devices**, and then press the **Select** softkey.
4. Press    or use the scroll wheel to select **Active Devices**, and then press the **Select** softkey.
5. Press    or use the scroll wheel to select the desired device, and then press the **Select** softkey.
6. Press    or use the scroll wheel to select **Bluetooth ID**, and then press the **Select** softkey. The screen displays the information about the device.









## Bluetooth settings

### Directory Download

---

You can download up to 4 phonebooks from the paired cell devices to your telephone system via Bluetooth connection. Each cell phone directory can hold up to 1500 entries with up to 24 digits for each phone number and 16 characters for each name.

Make sure your cell phone is paired and is on the **Active Devices** list before downloading the phonebook.

1. Press the **Menu** softkey.
2. Press   or use the scroll wheel to scroll to **Bluetooth**, and then press the **Select** softkey.
3. Press   or use the scroll wheel to select **Dir. Download**, and then press the **Select** softkey.
4. Press   or use the scroll wheel to select the desired device, and then press the **Select** softkey.
5. Press   or use the scroll wheel to select the desired option, then press the **Select** softkey.

(**Cell Memory** - download directory entries from cell phone memory.

**SIM Memory** - download directory entries from SIM card memory.

**Both** - download directory entries from both cell phone and SIM card memories.)

If the selected device's directory has already been downloaded to the telephone system, the screen displays **Dir. Existed Overwrite?** press the **Yes** softkey to overwrite the existing entries.

6. The number of entries downloaded displays and a beep sounds when the phonebook download is complete.





#### NOTES:

1. If the selected device is on the active devices list but is not connected, the screen displays **Not Connected**. Refer to the **To connect/disconnect an active device** section to connect the device to the telephone base.
2. If the selected device is not on the **Active Devices** list, the screen displays **No Device**. Refer to the **To add a device on the active devices list** section to add a device first.



### Bluetooth Base name

---

You can change the name of the base to personalize your system. The default name is GE30385.

1. Press the **Menu** softkey.
2. Press   or use the scroll wheel to scroll to **Bluetooth**, and then press the **Select** softkey.
3. Press   or use the scroll wheel to select **My Base**, and then press the **Select** softkey.







## Bluetooth settings

4. Press   or use the scroll wheel to select **Base Name**, and then press the **Select** softkey.
5. Edit the base name by using the dial pad keys. Refer to the **Characters Table** section for information on how to use the dial pad keys.
6. Press the **Ok** softkey to confirm.

### Base PIN

---







To change the Base PIN:

1. Press the **Menu** softkey.
2. Press   or use the scroll wheel to scroll to **Bluetooth**, and then press the **Select** softkey.
3. Press   or use the scroll wheel to select **My Base**, and then press the **Select** softkey.
4. Press   or use the scroll wheel to select **Base PIN**, and then press the **Select** softkey.
5. Press **del** to delete the current PIN and then enter a new PIN by using the dial pad keys.
6. Press the **Save** softkey to confirm.

### Auto Connect

---

When this feature is set to on, the telephone base automatically searches and connects with your Bluetooth active device when it is within range.







1. Press the **Menu** softkey.
2. Press   or use the scroll wheel to scroll to **Bluetooth**, and then press the **Select** softkey.
3. Press   or use the scroll wheel to select **Auto Connect**, and then press the **Select** softkey.
4. Press   or use the scroll wheel to select **On** or **Off**, and then press the **Select** softkey.

## Telephone base settings

### Display language

---









You can select **ENGLISH**, **ESPAÑOL** or **FRANÇIS** as the display language. The default setting is **ENGLISH**.

1. Press the **Menu** softkey when the handset is in idle mode.
2. Press   or use the scroll wheel to select **Settings** and then press the **Select** softkey.
3. Press   or use the scroll wheel to select **Language** and then press the **Select** softkey.
4. Press   or use the scroll wheel to select the desired language and then press the **Select** softkey to confirm.

### Ring tones

---







You can select from 10 ringer melodies for the telephone base.

1. Press the **Menu** softkey when the handset is in idle mode.
2. Press   or use the scroll wheel to select **Settings** and then press the **Select** softkey.
3. Press   or use the scroll wheel to select **Ring Tones** and then press the **Select** softkey.
4. Press   or use the scroll wheel to select **Line 1** or **Line 2** and then press the **Select** softkey.
5. Press   or use the scroll wheel to select the desired ring tone and then press the **Select** softkey to confirm.

### Ring volume

---

You can set the telephone base ringer volume from level 1 to level 5 or turn the ringer off.

1. Press the **Menu** softkey when the handset is in idle mode.
2. Press   or use the scroll wheel to select **Settings** and then press the **Select** softkey.
3. Press   or use the scroll wheel to select **Ring Volume** and then press the **Select** softkey.
4. Press   or use the scroll wheel to select the desired volume level and then press the **Select** softkey to confirm. You can also adjust the ring volume when the base is in the idle mode by using the scroll wheel.

### Key beeps







---

The telephone base can be programmed to emit a tone with each key press. You can choose to turn this feature on or off. The default setting is **ON**.

To change the key tone setting:





## Telephone base settings

1. Press the **Menu** softkey when the handset is in idle mode.
2. Press   or use the scroll wheel to select **Settings** and then press the **Select** softkey.
3. Press   or use the scroll wheel to select **Key Beeps** and then press the **Select** softkey.
4. Press   or use the scroll wheel to select **On** or **Off** and then press the **Select** softkey to confirm.

## Equalizer

---







This feature allows you to change the balance of the audio of the handset to best suit your hearing.

1. Press **repeat/back/EQ** on the left of the scroll wheel when the telephone base is in idle mode.
2. Press   or use the scroll wheel to select **Natural**, **Bass** or **Treble** and then press the **Select** softkey to confirm.

## Priority Line

---





Priority line setting determines the default line the telephone uses when making an outgoing call. You can select either **Line 1** or **Line 2** line.

1. Press the **Menu** softkey when the handset is in idle mode.
2. Press   or use the scroll wheel to select **Adv. Settings** and then press the **Select** softkey.
3. Press   or use the scroll wheel to select **Priority Line** and then press the **Select** softkey.
4. Press   or use the scroll wheel to select **Line 1** or **Line 2** and then press the **Select** softkey to confirm.

## Local area code

---

If you program your area code, the caller ID history displays only seven digits of the telephone numbers from your area code.







1. Press the **Menu** softkey when the handset is in idle mode.
2. Press   or use the scroll wheel to select **Adv. Settings** and then press the **Select** softkey.
3. Press   or use the scroll wheel to select **Local Area Code** and then press the **Select** softkey.
4. Enter a 3-digit area code and then press the **Save** softkey to confirm.

# Telephone base settings

## Date and time









---

In order for your answering system to accurately mark your messages you must set the date and time.

1. Press the **Menu** softkey when the handset is in idle mode.
2. Press   or use the scroll wheel to select **Clock & Alarm** and then press the **Select** softkey.
3. Press   or use the scroll wheel to select **Set Date/Time** and then press the **Select** softkey.
4. Enter the current month, day and year. For example, May 16, 2010 should be entered as [0], [5], [1], [6], [1], [0], and then press the **Next** softkey to confirm.
5. Enter the current hour and minute. For example, 9:30 should be entered as [0], [9], [3], [0]. Press   or use the scroll wheel to select **AM** or **PM**.
6. Press the **Save** softkey to confirm.









## Date Format

---

1. Press the **Menu** softkey when the handset is in idle mode.
2. Press   or use the scroll wheel to select **Clock & Alarm** and then press the **Select** softkey.
3. Press   or use the scroll wheel to select **Set Format** and then press the **Select** softkey.
4. Press   or use the scroll wheel to select **Date Format** and then press the **Select** softkey.
5. Press   or use the scroll wheel to select **MM/DD/YYYY** or **YYYY/DD/MM**, and then press the **Select** softkey to confirm.

## Time Format

---











1. Press the **Menu** softkey when the handset is in idle mode.
2. Press   or use the scroll wheel to select **Clock & Alarm** and then press the **Select** softkey.
3. Press   or use the scroll wheel to select **Set Format** and then press the **Select** softkey.
4. Press   or use the scroll wheel to select **Time Format** and then press the **Select** softkey.
5. Press   or use the scroll wheel to select **12 Hours** or **24 Hours**, and then press the **Select** softkey to confirm.

# Telephone base settings

## Alarm

---









The alarm can be programmed to sound once or daily for one minute. The alarm setting is independent of each handset.

1. Press the **Menu** softkey when the handset is in idle mode.
2. Press   or use the scroll wheel to select **Clock & Alarm** and then press the **Select** softkey.
3. Press   or use the scroll wheel to select **Set Alarm** and then press the **Select** softkey.
4. Press   or use the scroll wheel to select **On**, and then press the **Select** softkey.
5. Enter the desired hour and minute, and then press   or use the scroll wheel to select **AM** or **PM**.
6. Press the **Ok** softkey.
7. Press   or use the scroll wheel to select **Once** or **Daily**.  
(**Once**: The alarm sounds once at the set time.  
**Daily**: The alarm sounds daily at the set time.)
8. Press the **Select** softkey to confirm.

## Alarm tone

---

You can select from 10 ringers for the alarm.





1. Press the **Menu** softkey when the handset is in idle mode.
2. Press   or use the scroll wheel to select **Clock & Alarm** and then press the **Select** softkey.
3. Press   or use the scroll wheel to select **Set Alarm** and then press the **Select** softkey.
4. Press   or use the scroll wheel to select **Alarm Tone** and then press the **Select** softkey.
5. Press   or use the scroll wheel to select the desired ringer and then press the **Select** softkey to confirm.
6. You can select **Stop** or **Snooze** when the alarm sounds. The snooze will activate the alarm sound again in 5 minutes.

## Telephone base settings

### Clear voicemail indicator

---





You can reset the VMWI (voice message waiting indicator) when the phone indicates new messages waiting but there are none (for example, if you have previously accessed voice mail from a different telephone line while away from home). When new voice mails do exist, your telephone service provider will continue to send the signal to activate the feature.

1. Press the **Menu** softkey when the handset is in idle mode.
2. Press  $\Delta$    or use the scroll wheel to select **Adv. Settings** and then press the **Select** softkey.
3. Press  $\Delta$    or use the scroll wheel to select **Clear VoiceMail** and then press the **Select** softkey.
4. Press the **Yes** softkey to confirm.

### Reset setting

---

This feature allows you to restore all system settings, except the answering system messages and phonebook, to default settings. This feature could be useful, if you have forgotten the security code to access the answering system remotely.

1. Press the **Menu** softkey when the handset is in idle mode.
2. Press  $\Delta$    or use the scroll wheel to select **Adv. Settings** and then press the **Select** softkey.
3. Press  $\Delta$    or use the scroll wheel to select **Reset setting** and then press the **Select** softkey.
4. Press the **Yes** softkey to confirm.

**NOTE:** All settings under the **Ans. Sys Setup**, **Direct Memories**, **Clock & Alarm**, **Settings**, **Adv. Settings** and **Bluetooth** menus will be restored to default settings, the redial list and call log will also be cleared.

## Telephone operation

### To make, answer or end a call

---

#### Using the telephone base:

##### To make a call

1. Lift the corded handset, or press  or  or .
2. Dial the phone number.

##### To predial a call

1. Dial the phone number using the dial pad keys. If you make an error when dialing, press  to erase the digit entered.
2. Lift the corded handset, or press  or  or  to call.

##### To answer a call

Lift the corded handset, or press  or  to answer an incoming **Line 1** call.

Lift the corded handset, or press  or  to answer an incoming **Line 2** call.

##### To end a call

Return the corded handset to the telephone base or press .

#### Using a Bluetooth headset:

##### To make a call

Press  on the telephone base, then dial the phone number.

**-OR-**

Dial the phone number, then press  on the telephone base to call.

##### To answer a call

Press  on the telephone base or press the call button on your headset to answer an incoming call.

##### To end a call

Press  on the telephone base or press the call button on your headset to end a call.

### To make a Line 2 call while on Line 1 call

---

When you are on a **Line 1** call, you can initiate a **Line 2** call without disconnecting the **Line 1** call.

#### Using the telephone base:

1. Press  on the telephone base when on a **Line 1** call.
  2. Dial the phone number using the dial pad keys.
  3. Press  to call from the **Line 2** line.
- Press  or  to switch between the **Line 1** call and **Line 2** call.

### To make a Line 1 call while on Line 2 Call

---

When you are on a **Line 2** call, you can initiate a **Line 1** call without disconnecting the **Line 2** call.

# Telephone operation

## Using the telephone base:

1. Press **hold** on the telephone base when on a **Line 2** call.
2. Dial the phone number using the dial pad keys.
3. Press **line 1** to call from the **Line 1** line.  
Press **line 1** or **line 2** to switch between the **Line 1** call and **Line 2** call.

## Call Waiting

---

If you subscribe to call waiting service from your telephone service provider, a call waiting alert tone sounds when there is a second incoming call. If you subscribe to both caller ID and call waiting with caller ID services, the second caller's information is displayed after you hear the call waiting alert tone.

## Using the telephone base:

- Press **flash** to answer the second incoming call.
- Press **flash** to switch between calls.

## 3-way conference call

---

When you have calls on both **Line 1** line and **Line 2** line, you can establish a 3-way conference.

1. With calls on both lines, press the **Options** softkey.
2. Press **cid** or use the scroll wheel to select **Conference**, then press the **Select** softkey. A 3-way conference call is established.

## Muting a call

---

The mute function allows you to turn off the microphone while on a call. You can hear the other party but the other party cannot hear you.

## Using the telephone base:

1. Press **mute** during a call. The telephone base screen displays **Mute**.
2. Press **mute** again to resume conversation. The telephone base screen displays **Talk**.

## Speakerphone

---

Anytime during a call, press **speakerphone** on the telephone base to switch between speakerphone and normal handset use.

## Volume control

---

You can adjust the volume of the handset or speakerphone anytime during a call.

- Use the scroll wheel on the telephone base to increase or decrease the volume.

**NOTE:** Only the listening volume can be adjusted.

## Telephone operation

### Equalizer

---

This feature allows you to change the tone of the audio of the handset to best suit your hearing. You can select **Natural**, **Bass** or **Treble**.

#### Using the telephone base:

1. During a call, press **repeat/back/EQ** on the left of the scroll wheel.
2. Press  or use the scroll wheel to select **Natural**, **Bass** or **Treble**.
3. Press the **Select** softkey to confirm.

### Silencing the ringer

---



You can temporarily silence the ringer for an incoming call on a telephone base without disconnecting the call.

- Press the **Silence** softkey, or use the scroll wheel to scroll the volume level to silent.



### To put a call on hold

---

#### To put a Line 1 call on hold:

Press  on the telephone base to put a **Line 1** call on hold. The  button flashes. Press  on the telephone base to resume the call.

#### To put a Line 2 call on hold:





Press  on a the telephone base to put a **Line 2** call on hold. The  button flashes. Press  on the telephone base to resume the call.

### To make a call using the redial memory

---

The last ten telephone numbers previously dialed are stored in the redial list (up to 24 digits each).



#### Using the telephone base:

1. Press **redial/select/skip** on the right of the scroll wheel when in idle mode.
2. Press  or use the scroll wheel to scroll to the desired entry.
3. Lift the corded handset, or press  or  to call from **Line 1** line.  
**-OR-**  
Press  to call from **Line 2** line.
4. The number is dialed automatically.



### To save a number from the redial list to the phonebook

---

#### Using the telephone base:

1. Press **redial/select/skip** located on the blue ring surrounding the scroll wheel.
2. Press  or use the scroll wheel to select the desired entry, then press the **Options** softkey.
3. Press  or use the scroll wheel to select **Save Number**, then press the **Select** softkey.







## Telephone operation

4. Enter the name using the dial pad keys, then press the **Next** softkey.
5. Edit the number using the dial pad keys if necessary, then press the **Next** softkey.
6. Press   or use the scroll wheel to select the desired category (**Home, Cell, Office, Other**) of the number.
7. Press **Save** softkey to confirm.

## To delete a number from the redial list

---





### Using the telephone base:

1. Press **redial/select/skip** located on the blue ring surrounding the scroll wheel when in idle mode.
2. Press   or use the scroll wheel to select the desired entry, then press the **Options** softkey.
3. Press   or use the scroll wheel to select **Delete**, then press the **Select** softkey to delete the selected entry.  
**-OR-**  
Press   or use the scroll wheel to select **Delete All**, then press the **Select** softkey to delete all entries.
4. Press the **Yes** softkey to confirm.

## Voice message indicator

---

The telephone base displays voice message indicators for **Line 1** and **Line 2** separately.





- The  icon appears inside **1**  denotes that **Line 1** has received a new voice message from your service provider.
- The  icon appears inside **2**  denotes that **Line 2** has received a new voice message from your service provider.

**IMPORTANT:** Voice mail service is different from the answering system. In order to use the voice mail service, you must subscribe to it from your telephone service provider.

## Answering system message indicator

---

The telephone base displays answering system message indicators for **Line 1** and **Line 2** separately.

- The  icon appears inside **1**  denotes that **Line 1** has received a new answering system message.
- The  icon appears inside **2**  denotes that **Line 2** has received new answering system message.





# Telephone operation

## Line-in-use indicator

---

**Line 1** and **Line 2** each has its own line-in-user indicator.

- The  icon appears inside **1**  denotes that **Line 1** is in active use.
- The  icon appears inside **2**  denotes that **Line 2** is in active use.









**NOTE:** The line-in-use indicator  is different from the new calls indicator .

# Phonebook

The telephone system has a **Local Phonebook** that can store up to 100 entries. The phone number in each entry can be up to 24 digits long; the contact names can be up to 15 characters long. The telephone system can also download and store up to 4 **Cell Phonebooks** with each phonebook storing up to 1500 entries.

## Add a local phonebook record





---

1. Press  when in idle mode.
2. Press / or use the scroll wheel to select the **Local Phonebook**, then press the **Select** softkey.
3. Press the **Options** softkey.
4. Press / or use the scroll wheel to select **Add Entries**, then press the **Select** softkey.
5. Enter the name (max. 15 characters). Press the key to the corresponding character to display the correct letter. See the character table on page 33 for more information.
6. Press the **Next** softkey.
7. Enter the number (max. 24 digits). If you need a pause between digits, press and hold the  until a **P** appears in the display. This will insert a 3-second pause in the dialing sequence.
8. Press the **Next** softkey.
9. Press / or use the scroll wheel to select the desired category (**Home, Cell, Office, Other**) of the number.
10. Press the **Save** softkey to confirm.

**IMPORTANT:** You can only add phonebook entries to the **Local Phonebook**. You cannot add any new entries to the **Cell Phonebooks**.

## To view/call a phonebook entry



---

1. Press  when in idle mode.
2. Press / or use the scroll wheel to select the desired phonebook, then press the **Select** softkey.
3. Press / or use the scroll wheel to scroll through the phonebook to select the desired entry.
4. Lift the corded handset or press  to call from **Line 1** line, or press  to call from **Line 2** line.

# Phonebook







## To search a phonebook entry alphabetically

---

1. Press  when in idle mode.
2. Press  or use the scroll wheel to select the desired phonebook, then press the **Select** softkey.
3. Use the dial pad key (0-9) to enter up to the first three letters of the entry you are looking for. The closest match will appear.
4. Lift the handset or press  to call from **Line 1** line, or press  to call from **Line 2** line.





## Edit a phonebook entry

---

1. Press  when in idle mode.
2. Press  or use the scroll wheel to select the desired phonebook, then press the **Select** softkey.
3. Press  or use the scroll wheel to select the desired entry, then press the **Options** softkey.
4. Press  or use the scroll wheel to select **Edit Entries**, then press the **Select** softkey.
5. Edit the name (max. 15 characters). Press the key to the corresponding character to display the correct letter. See the character table on page 33 for more information.
6. Press the **Next** softkey.
7. Edit the number (max. 24 digits). If you need a pause between digits, press and hold the  until a **P** appears in the display. This will insert a 3-second pause in the dialing sequence.
8. Press the **Next** softkey.
9. Press  or use the scroll wheel to select the desired category (**Home, Cell, Office, Other**) of the number.
10. Press the **Save** softkey to confirm.

## Delete a phonebook entry



---

1. Press  when in idle mode.
2. Press  or use the scroll wheel to select the desired phonebook, then press the **Select** softkey.
3. Press  or use the scroll wheel to select the desired entry, then press the **Options** softkey.
4. Press  or use the scroll wheel to select **Delete An Entry**, then press the **Select** softkey.
5. Press the **Yes** softkey to confirm.

# Phonebook

## Delete all phonebook entries





---

1. Press  when in idle mode.
2. Press  or use the scroll wheel to select the desired phonebook, then press the **Select** softkey.
3. Press the **Options** softkey.
4. Press  or use the scroll wheel to select **Delete All**, then press the **Select** softkey.
5. Press the **Yes** softkey to confirm.

## Phonebook capacity

---

This feature allows you to check the remaining capacity of the phonebook.

1. Press  when in idle mode.
2. Press  or use the scroll wheel to select the desired phonebook, then press the **Select** softkey.
3. Press  or use the scroll wheel to select entry, then press the **Options** softkey.
4. Press  or use the scroll wheel to select **PB Capacity**, then press the **Select** softkey. The screen then displays **X/Y**, where **X** indicates the number of entries stored while **Y** indicates the capacity of the selected phonebook.



For example, 241/1500 means that there are 241 entries in a phonebook, which has a maximum capacity of 1500 entries.

## Direct memory

---

You can program 20 phone numbers into the memory location buttons **1-10** and **shift 1-10** in the telephone base for quick dialing.

### To program a memory location:

1. Press the **Menu** softkey when the telephone base is in idle mode.
2. Press  or use the scroll wheel to select **Direct Memory**, then press the **Select** softkey.
3. Press buttons **1-10** for locations 1-10, or press button **shift** followed by **1-10** for locations 11-20.
4. Enter the number (max. 24 digits). If you need a pause between digits, press and hold the  until a **P** appears in the display. This will insert a 3-second pause in the dialing sequence.
5. Press the **Save** softkey to confirm.

### To dial from a memory location:

Press the desired memory location button on the telephone base, the number will be dialed automatically using the speakerphone.

-OR-

# Phonebook

1. Lift the corded handset, or press or or .
2. Press the desired memory location button on the telephone base.

## To edit/delete a memory location number:

1. Press the **Menu** softkey when the telephone base is in idle mode.
2. Press or use the scroll wheel to select **Direct Memory**, then press the **Select** softkey.
3. Press the desired memory location button (**1-10** for locations 1-10, or **shift** following by **1-10** for locations 11-20).
4. To edit the number, press to delete the existing numbers. Then use the dial pad keys to enter the new number (max. 24 digits). If you need a pause between digits, press and hold the until a **P** appears in the display. This will insert a 3-second pause in the dialing sequence.

**-OR-**

To delete the number, press and hold until all numbers erased on the screen.

5. Press the **Save** softkey to confirm.

## Character table

Use the dial pad and the chart below to enter a name (up to 15 characters). Each press of a particular key displays the character in the following order:

Dial pad key	Character by number of key presses							
	1	2	3	4	5	6	7	8
[1]	space	1	#	'	,	-	.	&
[2]	Aa	Bb	Cc	2				
[3]	Dd	Ee	Ff	3				
[4]	Gg	Hh	li	4				
[5]	Jj	Kk	Ll	5				
[6]	Mm	Nn	Oo	6				
[7]	Pp	Qq	Rr	S	7			
[8]	Tt	Uu	Vv	8				
[9]	Ww	Xx	Yy	Zz	9			
[0]	0							

**NOTE:** Press # to alternate between upper and lower case. Press \* for special characters, \*, ?, !, /, (, ), @.

# Caller ID

## Using Caller ID service

---

**IMPORTANT:** You must subscribe to Caller-ID services from your telephone service provider(s) to receive Caller ID information.

Caller ID records from **Line 1** line and **Line 2** line are stored separately and in the order that they are received.

Your telephone stores stores caller ID memory for the 100 most recent calls. When the 101st call is received, the oldest Caller ID record (first call) is automatically deleted.

## Phonebook Caller-ID matching

---

If the last seven digits of an incoming telephone number match a telephone number in your phonebook, the name from this entry will display on the screen.





For example, if Michael Jones calls, and his number is saved in the phonebook under the name **MIKE**, the screen displays the name **MIKE**.

**NOTE:** The number you see on your caller ID is in the format sent by the telephone service provider. It usually delivers 10-digit telephone numbers (area code plus telephone number). If the last seven digits of the incoming telephone number do not match with a number in your phonebook, the name appears as it is delivered by the telephone service provider.



## Review/call from the call log

---

As calls are received and stored, the display is updated to let you know new calls have been received. To scroll through the caller ID records:



1. Press  when the handset is in idle mode.
2. Press  or use the scroll wheel to select **Line 1** or **Line 2**, then press the **Select** softkey.
3. Press  or use the scroll wheel to scroll through the phonebook. When the desired record is displayed, press  or  to call from **Line 1** line, or press  to call from **Line 2** line.

**-OR-**



Press  repeatedly until the phone number is shown in the desired format (for example, when 555-5555 is displayed, press  to change the format of the phone number to 555-555-5555, 1-555-555-5555, and back to 555-5555), then press  or  to call from **Line 1** line, or press  to call from **Line 2** line.

## Save a number to the Local Phonebook

---

1. Press  when the handset is in idle mode.
2. Press  or use the scroll wheel to select **Line 1** or **Line 2**, then press the **Select** softkey.
3. Press  or use the scroll wheel to select the desired entry, then press the **Options** softkey.





## Caller ID

4. Press  or use the scroll wheel to select **Save Number**, then press the **Select** softkey.
5. Edit the name using the dial pad keys if necessary, then press the **Next** softkey.
6. Edit the number by using the dial pad keys if necessary, then press the **Next** softkey.
7. Press  or use the scroll wheel to select the desired category (**Home, Cell, Office, Other**) for the entry, then press the **Save** softkey.

**IMPORTANT:** You can only save a caller ID record to the **Local Phonebook**.



### Delete a caller ID record

---

1. Press  when the handset is in idle mode.
2. Press  or use the scroll wheel to select **Line 1** or **Line 2**, then press the **Select** softkey.
3. Press  or use the scroll wheel to select the desired entry, then press the **Options** softkey.
4. Press  or use the scroll wheel to select **Delete**, then press the **Select** softkey.
5. Press the **Yes** softkey to confirm.

### Delete all caller ID records

---

1. Press  when the handset is in idle mode.
2. Press  or use the scroll wheel to select the desired entry, then press the **Options** softkey.
3. Press  or use the scroll wheel to select **Delete All**, then press the **Select** softkey.
4. Press the **Yes** softkey to confirm.

### Call log display screen messages

---

Display	When
Out of area	The caller's name and number are not available.
Private	The caller is blocking the name and/or number.

## Answering system

### Answering system and voice mail

---



Your telephone has separate mail boxes for **Line 1** and **Line 2**, as well as a voicemail indicator for voice mail service offered by your telephone service provider (fees may apply). They are independent features and each alerts you to new messages differently.

To listen to your voicemail, follow the instructions provided by your voicemail service provider. To listen to messages recorded on your answering system, refer to page 41.

### Turning the answering system on or off

---

You can turn the answering system for both **Line 1** and **Line 2** on and off. Each line has its own mailbox and they operate independent of each other.

1. Press  on the telephone base when in idle mode.
2. Press  or use the scroll wheel to select **Mailbox 1** or **Mailbox 2**, then press the **Select** softkey.
3. Press  or use the scroll wheel to select **On** or **Off** and then press the **Select** softkey to confirm.



### Message capacity



---

The answering system can record up to 59 messages. You can set how long a message can be recorded in the answering system, refer to the **Message length** section on page 39 for details.

### New message indicators for Line 1 and Line 2

---



When there are new messages in the mailbox for **Line 1**, the  icon appears inside  on the screen of the telephone base. The  button also lights up on the telephone base.

When there are new messages in the mailbox for **Line 2**, the  icon appears inside  on the screen of the telephone base. The  button also lights up on the telephone base.

### Recording memos

---









Recorded memos appear like messages from callers at the telephone base.

1. Press  on the telephone base when in idle mode.
2. Press  or use the scroll wheel to select **Mailbox 1** or **Mailbox 2**, then press the **Select** softkey.
3. Position yourself about 1 foot away from the microphone on the telephone base, then speak clearly towards the microphone while recording your memo (up to 3 minutes).
4. Press the **Save** softkey when you are done. The telephone base then replays the recorded memo for your review.



## Answering system

-OR-





1. Press the **Menu** softkey when in idle mode.
2. Press   or use the scroll wheel to select **Ans. Sys Setup**, then press the **Select** softkey.
3. Press   or use the scroll wheel to select **Mailbox Setting**, then press the **Select** softkey.
4. Press   or use the scroll wheel to select **Mailbox 1** or **Mailbox 2**, then press the **Select** softkey.
5. Press   or use the scroll wheel to select **Memo**, then press the **Select** softkey.
6. Position yourself about 1 foot away from the microphone on the telephone base, then speak clearly towards the microphone while recording your memo (up to 3 minutes).
7. Press the **Save** softkey when you are done. The telephone base then replays the recorded memo for your review.

Memos are stored as answering system messages. For details about playing back the message and other options, refer to page 41.











## Listening to Outgoing Announcement (OGA)

---

When the answering system answers a call, the default Outgoing Announcement (OGA) that comes with the system is played to the caller. You can change the OGA by recording your own announcement.

1. Press  on the telephone base when in idle mode.
2. Press   or use the scroll wheel to select **Mailbox 1** or **Mailbox 2**, then press the **Select** softkey.
3. Press   or use the scroll wheel to select **Play**, then press the **Select** softkey. The system plays the current OGA you are using.

-OR-

1. Press the **Menu** softkey when in idle mode.
2. Press   or use the scroll wheel to select **Ans. Sys Setup**, then press the **Select** softkey.
3. Press   or use the scroll wheel to select **Mailbox Setting**, then press the **Select** softkey.
4. Press   or use the scroll wheel to select **Mailbox 1** or **Mailbox 2**, then press the **Select** softkey.
5. Press   or use the scroll wheel to select **Announcement**, then press the **Select** softkey.
6. Press   or use the scroll wheel to select **Play**, then press the **Select** softkey. The system plays the current OGA you are using.



## Answering system

### Recording Outgoing Announcement (OGA)





---

You can record your own Outgoing Announcement (OGA).

#### Using the telephone base:

1. Position yourself about 1 foot away from the microphone on the telephone base, then press **annc** on the telephone base.
2. Press  or use the scroll wheel to select **Mailbox 1** or **Mailbox 2**, then press the **Select** softkey.
3. Press  or use the scroll wheel to select **Record**, then press the **Select** softkey.
4. Speak clearly towards the cordless handset while recording your OGA (up to 2 minutes).
5. Press the **Save** softkey when you are done. The telephone base then replays the OGA for your review.



**-OR-**

1. Press the **Menu** softkey when in idle mode.
2. Press  or use the scroll wheel to select **Ans. Sys Setup**, then press the **Select** softkey.
3. Press  or use the scroll wheel to select **Mailbox Setting**, then press the **Select** softkey.
4. Press  or use the scroll wheel to select **Mailbox 1** or **Mailbox 2**, then press the **Select** softkey.
5. Press  or use the scroll wheel to select **Announcement**, then press the **Select** softkey.
6. Press  or use the scroll wheel to select **Record**, then press the **Select** softkey.
7. Speak clearly towards the cordless handset while recording your OGA (up to 2 minutes).
8. Press the **Save** softkey when you are done. The telephone base then replays the OGA for your review.

### Deleting your recorded Outgoing Announcement (OGA)

---















If you want to use the default system Outgoing Announcement (OGA), simply delete your recorded OGA.

1. Press **annc** on the telephone base when in idle mode.
2. Press  or use the scroll wheel to select **Mailbox 1** or **Mailbox 2**, then press the **Select** softkey.
3. Press  or use the scroll wheel to select **Delete**, then press the **Select** softkey. The OGA you recorded is deleted.

**-OR-**

1. Press the **Menu** softkey when in idle mode.

## Answering system















1. Press   /  or use the scroll wheel to select **Ans. Sys Setup**, then press the **Select** softkey.
2. Press   /  or use the scroll wheel to select **Mailbox Setting**, then press the **Select** softkey.
3. Press   /  or use the scroll wheel to select **Mailbox 1** or **Mailbox 2**, then press the **Select** softkey.
4. Press   /  or use the scroll wheel to select **Announcement**, then press the **Select** softkey.
5. Press   /  or use the scroll wheel to select **Delete**, then press the **Select** softkey. The OGA you recorded is deleted.

## Number of rings before the system answers

---

You can select the number of rings before the answering system answers a call.

### Using the telephone base

1. Press the **Menu** softkey when in idle mode.
2. Press   /  or use the scroll wheel to select **Ans. Sys Setup**, then press the **Select** softkey.
3. Press   /  or use the scroll wheel to select **Mailbox Setting**, then press the **Select** softkey.
4. Press   /  or use the scroll wheel to select **Mailbox 1** or **Mailbox 2**, then press the **Select** softkey.
5. Press   /  or use the scroll wheel to select **Ring To Answer**, then press the **Select** softkey.
6. Press   /  or use the scroll wheel to select the desired number of ring, then press the **Select** softkey.







**NOTE:** If you select **Toll Saver**, the system answers after the second ring if there are new messages, or after the fourth ring if there are no new messages. This allows you to check your system to see if there are new messages before incurring toll charges.

## Message length



---

You can set the maximum recording time for an individual message recorded in the answering system.

### Using the telephone base

1. Press the **Menu** softkey when in idle mode.
2. Press   /  or use the scroll wheel to select **Ans. Sys Setup**, then press the **Select** softkey.
3. Press   /  or use the scroll wheel to select **Mailbox Setting**, then press the **Select** softkey.

## Answering system



1. Press  or use the scroll wheel to select **Mailbox 1** or **Mailbox 2**, then press the **Select** softkey.
2. Press  or use the scroll wheel to select **Msg Length**, then press the **Select** softkey.
3. Press  or use the scroll wheel to select the desired time (**1 minute**, **2 minutes**, **3 minutes**, or **No Limit**), then press the **Select** softkey.

## Turning the message alert on or off

---

When this feature is activated and there are new messages in either **Line 1** or **Line 2**, the telephone base beeps once every 15 seconds.

### Using a the telephone base

1. Press the **Menu** softkey when in idle mode.
2. Press  or use the scroll wheel to select **Ans. Sys Setup**, then press the **Select** softkey.
3. Press  or use the scroll wheel to select **Message Alert**, then press the **Select** softkey.
4. Press  or use the scroll wheel to select **On** or **Off**, then press the **Select** softkey.



## Turning the call screening on or off

---

When the answering system answers a call, you can listen at the telephone base while the caller leaves a message.

If you turn the call screening feature on, the message automatically plays on the telephone base. If the call screening feature is turned off, you can still screen a call on the telephone base by pressing the **Screen** softkey.

Press  or use the scroll wheel to adjust speaker volume. If the speaker is at the lowest level (off), you will need to increase the volume when listening to message playback at the telephone base.

1. Press the **Menu** softkey when in idle mode.
2. Press  or use the scroll wheel to select **Ans. Sys Setup**, then press the **Select** softkey.
3. Press  or use the scroll wheel to select **Call Screening**, then press the **Select** softkey.
4. Press  or use the scroll wheel to select **On** or **Off**, then press the **Select** softkey.

## Call intercept

---

If you want to speak to the caller when the answering system is recording a message, lift the handset or press  on the telephone base. The answering system will automatically stop recording when you do so.

# Answering system

## Message playback using the telephone base

---



### To playback messages on answering system for Line 1:

1. Press **▷□ 1** on the telephone base to listen to the messages.
2. The system announces the number of messages and date and time when the message was recorded.
3. Press **▷□ 1** again to stop the playback.

### To playback messages on answering system for Line 2:





1. Press **▷□ 2** on the telephone base to listen to the messages.
2. The system announces the number of messages and date and time when the message was recorded.
3. Press **▷□ 2** again to stop the playback.

### Options during playback:

Key	Operation
 or scroll wheel	Press to adjust the listening volume.
	Press to playback or stop messages.
<b>Repeat</b> softkey	Press to repeat a message. Press twice to play the previous message.
<b>Skip</b> softkey	Press to skip to the next message.
	Press during playback to delete the current message.

### Delete all old messages

---





1. Press the **Menu** softkey when in idle mode.
2. Press  or use the scroll wheel to select **Ans. Sys Setup**, then press the **Select** softkey.
3. Press  or use the scroll wheel to select **Mailbox Setting**, then press the **Select** softkey.
4. Press  or use the scroll wheel to select **Mailbox 1** or **Mailbox 2**, then press the **Select** softkey.
5. Press  or use the scroll wheel to select **Del All Old Msg**, then press the **Select** softkey.
6. Press the **Yes** softkey to confirm.

# Answering system

## Changing the security code for remote access

---

Your answering system allows you to program a 4-digit security code to get access to the system through any touch-tone telephone. The default security code is 0000.

1. Press the **Menu** softkey when in idle mode.
2. Press  or use the scroll wheel to select **Ans. Sys Setup**, then press the **Select** softkey.
3. Press  or use the scroll wheel to select **Mailbox Setting**, then press the **Select** softkey.
4. Press  or use the scroll wheel to select **Mailbox 1** or **Mailbox 2**, then press the **Select** softkey.
5. Press  or use the scroll wheel to select **Security Code**, then press the **Select** softkey.
6. Enter a 4-digit security code using the dial pad keys, then press the **Save** softkey to confirm.

## Access the answering system remotely

---

1. Dial your phone number from any touch-tone telephone.
2. Press  when the system is playing the outgoing announcement.
3. You will be prompted to enter the security code. The default security code is 0000.
4. The system will start playing the remote access menu if the security code is correctly entered.

### NOTES:

1. If your answering system is off, you will not hear your outgoing announcement. The system will answer your call after 10 rings and then ask you to enter your remote code.
2. An error tone sounds if the entered security code is incorrect.

## Remote access commands

Touch-tone keys	Remote command
1	Replay the current or previous message.
2	Play/stop messages.
3	Skip to the next message.
4	Turn the answering system on or off.
7	Listen to the main menu.
0	Delete the current message.

A convenient wallet card, with instructions needed to operate your answering system remotely, can be found at the end of this user's manual.

# Appendix

## Troubleshooting guide

---

If your telephone system is not operating properly, first try these general reset procedures:

1. Unplug all power adapters from the power outlets.
2. Disconnect the telephone line cord from the base or modular jack.
3. Remove the battery compartment covers and unplug all handset battery packs.
4. After a few minutes, re-install all handset battery packs, making sure that the connectors are snug and the wires are not pinched before replacing all battery compartment covers.
5. Plug the power adapters for the base and any chargers back into their power outlets. Be sure not to use outlets that are controlled by wall switches or timers.
6. Place all handsets in the chargers to charge without interruption for at least 30 minutes before use.
7. Plug the line cord into the telephone base or modular jack and verify operation.

For product assistance or for more information about accessories, visit our website at [www.gephones.com](http://www.gephones.com) or call our customer service center at **1-877-394-9775**.

### General Performance

Problem	Cause/solution
Cannot hear a dial tone.	<ul style="list-style-type: none"><li>• Increase the volume on the handset.</li><li>• Disconnect the telephone line cord from the base unit and connect it to a known working telephone. If the known working telephone operates properly, contact our customer support center for warranty information.</li></ul>
Handset does not ring.	<ul style="list-style-type: none"><li>• The ringer may be off. Increase the ringer volume.</li></ul>
You experience audible static, noise, or fading in and out.	<ul style="list-style-type: none"><li>• If you are using a line with DSL service, make sure you have properly installed the DSL filters supplied by your service provider.</li></ul>

# Appendix

## Caller ID

Problem	Cause/solution
Caller-ID information is not displayed.	<ul style="list-style-type: none"><li>• You must subscribe to Caller ID service from your service provider/telephone company.</li><li>• Make sure the base unit is plugged directly into a telephone modular jack. If you are using a line with DSL service, make sure you have properly installed the DSL filters supplied by your service provider.</li></ul>
While on a call, new caller-ID information is not displayed.	<ul style="list-style-type: none"><li>• You must subscribe to Caller ID with Call Waiting service from your service provider/telephone company.</li></ul>

## Answering system

Problem	Cause/solution
The unit does not record new messages.	<ul style="list-style-type: none"><li>• Make sure the answering system is on.</li><li>• The message memory may be full. Some messages will need to be deleted.</li></ul>
Cannot operate the answering system remotely.	<ul style="list-style-type: none"><li>• You must use a touch-tone telephone for remote access.</li><li>• Make sure you follow the remote access procedures in this user's guide.</li></ul>

## Bluetooth

Problem	Cause/solution
The GE 30385 won't pair/connect with my cell phone/headset.	<ul style="list-style-type: none"><li>• Check to see if your cell phone/headset's Bluetooth function is turned on.</li><li>• Check your cell phone/headset's user's guide for instructions on Bluetooth device pairing.</li><li>• Make sure your cell phone/headset is near the base of the GE 30385.</li><li>• If GE 30385 appears in your cell phone's paired device list, delete it and repeat the pairing steps in this user's guide.</li><li>• Turn your cell phone/headset off, then back on and try the pairing steps again.</li><li>• Disconnect the AC adapter from the back of the telephone base. Wait a few minutes, and then reconnect it. Repeat pairing steps in this user's guide.</li></ul>



## Appendix

### General Product Care

---

- Avoid dropping the handset, as well as other rough treatment to the phone.
- Clean the phone only with a dry soft cloth.
- Never use cleaning agents, paint thinner, abrasive powder, alcohol, or other chemical products to clean the unit. Doing so will damage the unit.
- Retain the original packaging in case you need to ship the phone at a later date.

# Appendix

## Important Safety Instructions

---

Some of the following information may not apply to your particular product; however, when using telephone equipment, basic safety precautions should always be followed to reduce the risk of fire, electric shock and injury to persons, including the following:

1. Read and understand all instructions.
2. Follow all warnings and instructions marked on the product.
3. Unplug this product from the wall outlet before cleaning. Do not use liquid cleaners or aerosol cleaners. Use a damp cloth for cleaning.
4. Telephones should not be used while you are in a bathtub, shower or pool. Immersion of the telephone or handset in water could cause an electrical shock.
5. Slots and openings in the cabinet back or bottom are provided for ventilation, to protect it from overheating. Do not block or cover these openings. Do not block the openings by placing the product on a bed, sofa, rug, or other similar surface. Do not place this product in a built-in installation unless proper ventilation is provided.
6. Only operate this product from the type of power source indicated on the marking label. If you are not sure of the type of power supply to your home, consult your dealer or local power company.
7. Plug the adaptor into an easily accessible electrical outlet near the equipment.
8. Do not allow anything to rest on the power cord. Do not locate this product where the cord will be abused by persons walking on it.
9. Do not overload wall outlets and extension cords as this can result in the risk of fire or electric shock.
10. Never push objects of any kind into this product through cabinet slots as they may touch dangerous voltage points or short out parts that could result in a risk of fire or electric shock.
11. Never spill liquid of any kind on the product.
12. To reduce the risk of electric shock, do not disassemble this product. Opening or removing covers may expose you to dangerous voltages or other risks. Incorrect reassembly can cause electric shock when the appliance is subsequently used.
13. Do not expose the product to extreme temperatures such as areas near a hot radiator, stove or in a hot car. Do not place product upon other consumer electronic products such as; computer monitors, power amplifiers, etc.
14. Do not place lighted candles, cigarettes, cigars, etc., on or near the telephone.
15. Never touch uninsulated telephone wires or terminals unless the telephone line has been disconnected at the network interface.
16. Never install or modify telephone wiring during a lightning storm.
17. Never install jacks or telephones in wet locations.
18. Use caution when installing or modifying telephone lines to prevent electrical shock and/or fire.
19. Under the following conditions, unplug this product from the wall outlet and refer servicing to qualified service personnel:
  - A. The power supply cord or plug is damaged or frayed.

## Appendix

- B. The product has been exposed to rain or water.
  - C. The product does not operate normally by following the operating instructions.
  - D. The product's cabinet has been damaged.
  - E. The product exhibits a distinct change in performance.
20. Avoid using a telephone during an electrical-storm. There may be a remote risk of electric shock from lightning.
  21. Do not use the telephone to report a gas leak in the vicinity of the leak.
  22. Do not place this product on an unstable cart, stand, or table. The product may fall, causing serious damage to the product.
  23. Only use attachments/accessories specified by the manufacturer.
  24. Unplug this apparatus during lightning storms or when unused for long periods of time.

### **IF YOUR PRODUCT UTILIZES BATTERIES, THE FOLLOWING ADDITIONAL PRECAUTIONS SHOULD BE OBSERVED:**

1. Use only the type and size battery(ies) specified in the user's guide.
2. Do not use this product if the battery door is removed or missing.
3. Replace batteries that appear to be swollen or have damaged wiring.
4. Do not dispose of the battery(ies) in fire. They may explode. Check with local codes for possible special disposal instructions.
5. Do not open or mutilate the battery(ies). Released electrolyte is corrosive and may cause damage to the eyes or skin. It may be toxic if swallowed.
6. Exercise care in handling battery(ies) in order not to short out the battery(ies) with conducting materials such as rings, bracelets, and keys. The battery(ies) or conductor may overheat and cause burns.
7. Do not attempt to recharge the battery(ies) provided with or identified for use with this product that are not rechargeable. The battery(ies) may leak corrosive electrolyte or explode.
8. Do not attempt to rejuvenate the battery(ies) provided with or identified for use with this product by heating them. Sudden release of the battery(ies) electrolyte may occur causing burns or irritation to eyes or skin.
9. When replacing battery(ies), all batteries should be replaced at the same time. Mixing fresh and discharged batteries could increase internal cell pressure and rupture the discharged battery(ies). (Applies to products employing more than one separately replaceable primary battery.)
10. When inserting battery(ies) into this product, the proper polarity or direction must be observed. Reverse insertion of battery(ies) may result in leakage or explosion.
11. When inserting battery(ies) into this product, do not twist or pinch the wires or allow wires to become pinched in battery door.
12. If storing over 30 days, remove battery(ies) from this product because the battery(ies) could leak and damage the product.
13. Discard "dead" battery(ies) as soon as possible since "dead" batteries are more likely to leak in a product.

## Appendix

14. Do not store this product, or the battery(ies) provided with or identified for use with this product, in high-temperature areas. Batteries that are stored in a freezer or refrigerator for the purpose of extending shelf life should be protected from condensation during storage and defrosting. Batteries should be stabilized at room temperature prior to use after cold storage.
15. If your product uses rechargeable battery(ies), charge the battery(ies) only in accordance with the instructions and limitation specified in the user's guide.
16. Battery safety precautions
  - Do not burn, disassemble, mutilate, or puncture. Like other batteries of this type, toxic materials could be released which might cause injury to persons or property damage.
  - To reduce the risk of fire or personal injury, use only the supplied battery or replacement battery.
  - Keep batteries out of the reach of children.
  - Remove batteries if storing over 30 days.

Use only the supplied rechargeable battery or replacement battery. Visit our website at [www.gephones.com](http://www.gephones.com) to order a replacement battery if necessary.

**SAVE THESE INSTRUCTIONS**

# Appendix

## FCC Parts 15, 68 and ACTA

---

This equipment is in compliance with parts 15 and 68, FCC Rules and Regulations and the Technical Requirements for Telephone Terminal Equipment published by ACTA.

On the bottom of this equipment is a label indicating, among other information, the US number and Ringer Equivalence Number (REN) for the equipment. You must, upon request, provide this information to your telephone company.

The REN is useful in determining the number of devices you may connect to your telephone line and still have all of these devices ring when your telephone number is called. In most (but not all) areas, the sum of the RENs of all devices connected to one line should not exceed 5.

A plug and jack used to connect this equipment to the premises wiring and telephone network must comply with the applicable FCC Part 68 rules and requirements adopted by the ACTA. A compliant telephone cord and modular plug is provided with this product. It is designed to be connected to a compatible modular jack that is also compliant. See installation instructions for details.

This equipment is not intended to be used with Party Lines. If your home has specially wired alarm equipment connected to the telephone line, ensure the installation of this product does not disable your alarm equipment. If you have questions about what will disable alarm equipment, consult your telephone company or a qualified installer.

If this equipment is malfunctioning, it should be unplugged from the modular jack until the problem is corrected. Repairs to this equipment can only be made by the manufacturer or its authorized agents. For information on repair procedures, follow the instructions provided with the limited warranty. Should your equipment cause trouble on your line which may harm the telephone network, the telephone company shall, where practicable, notify you that temporary discontinuance of service may be required. Where prior notice is not practical and the circumstances warrant such action, the telephone company may temporarily discontinue service immediately. In case of such temporary discontinuance, the telephone company must: (1) promptly notify you of such temporary discontinuance; (2) afford you the opportunity to correct the situation; and (3) inform you of your right to bring a complaint to the Commission pursuant to procedures set forth in Subpart E of Part 68, FCC Rules and Regulations.

The telephone company may make changes in its communications facilities, equipment, operations or procedures where such action is required in the operation of its business and not inconsistent with FCC Rules and Regulations. If these changes are expected to affect the use or performance of your telephone equipment, the telephone company must give you adequate notice, in writing, to allow you to maintain uninterrupted service. This device complies with Part 15 of the FCC Rules. Operation is subject to the following two conditions: (1) This device may not cause harmful interference; and (2) This device must accept any interference received, including interference that may cause undesired operation. This equipment has been tested and found to comply with the limits for a Class B digital device, pursuant to Part 15 of the FCC Rules. These limits are designed to provide reasonable protection against harmful interference in a residential installation.

This equipment generates, uses, and can radiate radio frequency energy and, if not installed and used in accordance with the instructions, may cause harmful interference to radio communications. However, there is no guarantee that interference will not occur in a particular installation.

Privacy of Communications may not be ensured when using this product.

## Appendix

If this equipment does cause harmful interference to radio or television reception, which can be determined by turning the equipment off and on, the user is encouraged to try to correct the interference by one or more of the following measures:

- Reorient or relocate the receiving antenna (that is, the antenna for radio or television that is “receiving” the interference).
- Reorient or relocate and increase the separation between the telecommunications equipment and receiving antenna.
- Connect the telecommunications equipment into an outlet on a circuit different from that to which the receiving antenna is connected.

If these measures do not eliminate the interference, please consult an experienced radio/television technician for additional suggestions. **The changes or modifications not expressly approved by the party responsible for compliance could void the user’s authority to operate the equipment.**

### FCC RF Radiation Exposure Statement

The installation of the base unit should allow at least 20 centimeter between the base and persons to be in compliance with FCC RF exposure guidelines. For body worn operation, the portable part (handset) has been tested and meets FCC RF exposure guidelines.

This device must not be co-located or operating in conjunction with any other antenna or transmitter. The changes or modifications not expressly approved by the party responsible for compliance could void the user’s authority to operate the equipment.

### Hearing Aid Compatibility (HAC)

This equipment meets FCC standards for Hearing Aid Compatibility

If this product has a memory dialing feature, you may choose to store emergency phone numbers such as police, fire or medical within the memory locations. If you do store or emergency numbers, we suggest you also write these numbers down so that you can still dial the number manually if the memory dialing fails.

This feature is included as a convenience only. The manufacturer assumes no responsibility for customer reliance on the memory feature of this product.



**Testing emergency telephone numbers is not recommended.** However, if you choose to make a test call to an emergency number, you should:

- Remain on the line and provide an explanation for the call before you hang up.
- Only make a non emergency test call during off-peak hours during early mornings or late evenings.

To ensure user safety, the FCC has established criteria for the amount of radio frequency energy that can be safely absorbed by a user or bystander according to the intended usage of the equipment. This equipment has been tested and found to comply with the FCC criteria. The handset may be safely held against the ear of the user. The telephone base should be installed and used such that parts of the users body other than the handset are maintained at a distance of approximately 8 inches (20 cm) or more.

# Appendix

**WARNING: TO PREVENT FIRE OR ELECTRICAL SHOCK HAZARD, DO NOT EXPOSE THIS PRODUCT TO RAIN OR MOISTURE.**

 <p>THE LIGHTNING FLASH AND ARROW HEAD WITHIN THE TRIANGLE IS A WARNING SIGN ALERTING YOU OF "DANGEROUS VOLTAGE" INSIDE THE PRODUCT.</p>	<p><b>CAUTION</b></p> <p>RISK OF ELECTRICAL SHOCK, DO NOT OPEN</p> <p>CAUTION: TO REDUCE THE RISK OF ELECTRICAL SHOCK, DO NOT REMOVE COVER (OR BACK). NO USER SERVICEABLE PARTS INSIDE. REFER SERVICING TO QUALIFIED SERVICE PERSONNEL.</p>	 <p>THE EXCLAMATION POINT WITHIN THE TRIANGLE IS A WARNING SIGN ALERTING YOU OF IMPORTANT INSTRUCTIONS ACCOMPANYING THE PRODUCT.</p>
--	---	--

## Appendix



The RBRC seal on the battery used in your product indicates that CCT is participating in the Rechargeable Battery Recycling Corporation (RBRC) program to collect and recycle rechargeable batteries. We encourage you to explore the easy recycling options available to you in your area. For more information visit [www.rbr.org](http://www.rbr.org) or call 1-800-8-BATTERY or contact your local recycling center.

In accordance with California Proposition 65, CCT advises that nickel is a chemical known to the State of California to cause cancer.

Compatible with  
Hearing Aids T-Coil



This product has reduced magnetic noise interference with most T-coil equipped hearing aids and cochlear implants. The TIA-1083 Compliant Logo is a trademark of the Telecommunications Industry Association. Used under license.



The Bluetooth® word mark and logos are owned by Bluetooth SIG, Inc. and any use of such marks by CCT, is under license.



# Appendix

## One Year Limited Warranty

---

CCT Tech USA Inc. (CCT), the licensed manufacturer of this GE® branded product, warrants this product to the original retail purchaser to be free of material and/or workmanship defects for a period of one year after the date of original retail purchase. Proof of the original purchase is required to obtain a remedy under this limited warranty and the product must be returned to CCT at your expense.

During the limited warranty period, CCT or its authorized service representative will repair or replace at CCT's option, without charge, a materially defective product. We may use new or refurbished replacement parts. If we replace the product, it may be with a new or refurbished product of same or similar design. CCT may keep any removed or defective parts, and/or replaced product. The repaired or replaced product is warranted for the remainder of the original warranty or 90 days, whichever is greater. Repair or replacement of this product at CCT's option is your exclusive remedy.

This limited warranty only applies to products purchased, used and serviced in the United States and its territories, or Puerto Rico. If you purchased this product outside of the United States, its territories or Puerto Rico, contact your dealer for service information.

This is the only warranty applicable to this product. **ALL OTHER WARRANTIES EXPRESS OR IMPLIED INCLUDING ALL IMPLIED WARRANTIES OF MERCHANTABILITY OF FITNESS FOR A PARTICULAR PURPOSE ARE HEREBY DISCLAIMED. CCT IS NOT LIABLE FOR ANY INDIRECT, INCIDENTAL, CONSEQUENTIAL OR SIMILAR DAMAGES INCLUDING, BUT NOT LIMITED TO, LOST PROFITS OR REVENUE, INABILITY TO USE THE PRODUCT, OR ANY OTHER ASSOCIATED EQUIPMENT, THE COST OF SUBSTITUTE EQUIPMENT, AND ANY CLAIMS BY THIRD PARTIES RESULTING FROM THE USE OF THIS PRODUCT.**

This warranty gives you specific legal rights, and you may have other rights that vary from state to state. Some states do not allow the exclusion or limitation of incidental or consequential damages, so the limitations or exclusions stated above may not apply.

What Is NOT Covered Under This Limited Warranty

- Normal wear and tear or cosmetic damage.
- Damage due to accidents, misuse, physical force, improper installation or operation, mishandling, neglect, fire, heat, water, humidity, liquids, insect infestation, or other intrusion.
- Products that have been repaired, altered or modified by anyone other than CCT or its authorized service representative.
- Problems caused by signal conditions, radio interference, network reliability, cable or antenna systems.
- Damage caused by use of non CCT accessories or misapplication.
- Products whose serial numbers have been removed, altered or rendered illegible.
- Products purchased, shipped from, used or serviced outside the United States.
- Batteries.
- Products used for business, commercial or institutional purposes.
- Damage caused by acts of nature such as, but not limited to, lightning damage.
- Products returned without valid proof of purchase.

## Appendix

### How To Obtain Warranty Service

Call our customer service center at **1-877-394-9775**. Our customer service specialist will assist you in obtaining warranty service. Please have a paper and pencil handy to write down the warranty service return instructions.

**-OR-**

You may visit our web site at **www.gephones.com** for troubleshooting, FAQs, and information on warranty service.

### Accessibility

If you have a disability or questions about how CCT's products can accommodate persons with disabilities, please call our customer service center at **1-877-394-9775**. When calling, please let our specialists know that you have an inquiry about accessibility so your call is routed properly.

# Appendix

## Technical specification

<b>Telephone base input voltage and current</b>	6VDC 500mAh
<b>USB port (charging only)</b>	5V 500mAh, Ni-MH

# Appendix

## Index

---

### A

---

Alarm 23

### C

---

Caller ID 35

delete an entry 36

review/call 35

save to phonebook 35

Call intercept 41

Call screening 41

Character table 33

### D

---

Delete all messages 42

Delete message 42

### F

---

FCC 50

### G

---

General Product Care 46

### H

---

Handset locator 28

Handset screen display icon 13

### I

---

Important safety instructions 47

### K

---

Key beeps 20

### L

---

Language 20

### M

---

Make a call 25

Message Alert 40, 41

Message capacity 37

Message playback

telephone base 42

### O

---

Outgoing announcement 38

delete 39

record 39

### P

---

Parts checklist 1

Phonebook

add an entry 30

add to block list 36

delete all entries 32

delete an entry 31

edit an entry 31

search entry 31

Phonebook Caller-ID matching 35

### R

---

Redial

delete 28

dial 27

save to phonebook 27

Remote access commands 43

Remote access operation 43

Ring delay 40

Ringer tone 20

### T

---

Telephone base layout 10, 11

Telephone base screen display icon 13

Troubleshooting guide 44

### V

---

Voice mail 28

Volume control 26

### W

---

Wall mount installation 5

Warranty 54

## Remote access operation card

The remote access card below lists the commands needed to operate your answering system remotely from any touch-tone telephone.

Cut along dotted line

### Remote access operation card

1. Call your telephone number from a touch-tone telephone.
2. Enter your remote code using the numeric keypad on the touch-tone telephone when your answering system takes your call and you hear your outgoing announcement. (Default is 0000).

Remote code:

<input type="text"/>	<input type="text"/>	<input type="text"/>	<input type="text"/>
----------------------	----------------------	----------------------	----------------------

3. The system will start playing the remote access menu if the remote code is correctly entered.

**NOTE:** For more details about remote access operation, refer to page 42 of the user's guide.

Fold  
here

### Remote access commands

Touch-tone keys	Remote command
1	Replay the current or previous message.
2	Play/stop messages.
3	Skip to the next message.
4	Turn the answering system on or off.
7	Listen to the main menu.
0	Delete the current message.

visit our website:

**[www.gephones.com](http://www.gephones.com)**



is a trademark of General Electric Company and is under license by  
CCT Tech USA Inc., Irving, TX 75039

Model 30385  
P/N: 480-98620-000002  
Version 1 04/2011  
Printed in China

©2011 CCT Tech USA Inc.  
Distributed in the U.S.A. by  
CCT Tech USA Inc.