

# DECT 6.0 CORDLESS TELEPHONE

Model number:  
30522



# Thank you for choosing GE!

## Register your product

Please take a moment to register your product online. Just go to **www.gephones.com** and click “register here” from the home page. Provide your email address and receive product updates, special offers, or discounts on future purchases.

\* It will not diminish your warranty rights if you choose not to register.

## Assistance and more information

Retain your sales receipt as proof of purchase in the event warranty service is necessary.

For product assistance or for more information about accessories, visit our website at **www.gephones.com** or call our customer service center at **1-877-394-9775**.

**Attach your sales receipt here.**

# Table of contents

## Getting started

Parts checklist.....	1
Telephone base installation.....	2
Telephone jack requirements .....	2
Charger installation .....	3
Battery installation.....	4
Wall mount installation.....	5

## Overview

Telephone base layout.....	9
Handset layout .....	10
Battery charging.....	11
Screen display icon.....	12

## Initial settings

Dialing mode.....	13
Programming your area code (optional) .....	13

## Telephone operation

Make a call.....	14
Predial a call.....	14
Answer a call .....	14
End a call .....	14
Speakerphone.....	14
Volume control .....	14
Make a call using the redial memory .....	15
Save a number from the redial list to the phonebook.....	15
Delete number from the redial list....	15
Mute.....	15
Call waiting or call waiting with caller ID service .....	16
Voice mail service.....	16
Using multiple handsets.....	16
Handset locator .....	16
Intercom .....	17
To answer an incoming call during intercom.....	17

To initiate an intercom during a call.....	18
Push to talk (PTT).....	19

## Handset settings

Ringer volume .....	20
Ringer melody .....	20
Key tone.....	21
Display language.....	21
Equalizer .....	22
Energy save.....	22

## Base settings

Base ringer melody.....	23
Base ringer volume.....	23

## Block list

To add a new entry.....	24
To view the list.....	24
To edit an entry.....	24
To delete an entry .....	25
To delete all entries.....	25

## Do not disturb

Global DND .....	26
Handset DND.....	26

## Clock and alarm

Date and time .....	27
Time format.....	27
Date format.....	28
Alarm.....	28
Alarm tone .....	29

## Phonebook

Add a phonebook record .....	30
Character table .....	31
To view/call a phonebook record.....	32
To search a phonebook entry alphabetically .....	32
Chain dialing.....	32

Edit a phonebook entry .....	33
Delete a phonebook entry.....	33
Delete all phonebook entries .....	33

## Caller ID

Using Caller ID service .....	34
Phonebook Caller-ID matching.....	34
Review/call from the call log.....	34
Save a number to the phonebook.....	35
Delete caller ID record.....	35
Call log display screen messages.....	35

## Answering system

Turning the answering system on or off .....	36
Answering system and voice mail.....	36
Message capacity .....	36
Telephone base volume .....	36
New message indicator.....	37
Outgoing Announcement (OGA) .....	37
Record an outgoing announcement (OGA) .....	37
Delete your recorded OGA .....	37
Play the current outgoing announcement .....	38
Number of rings before the system answers .....	38
Security code for remote access.....	39
Call screening .....	39
Message playback using the telephone base .....	40
Message playback using the handset.....	40
Delete all messages .....	41
Message window.....	41
Access the answering system remotely .....	42
Remote access commands .....	42

## Advanced settings

Reset.....	43
Registering a handset .....	43
Deregistering a handset.....	44

## Appendix

Troubleshooting guide .....	45
General Product Care .....	47
Important Safety Instructions .....	48
FCC Parts 15, 68 and ACTA.....	52
One Year Limited Warranty .....	56
Technical specification .....	58
Index.....	59
Remote access operation card.....	61

# Getting started

## Parts checklist

Your telephone contains the following items. Save your sales receipt and original packaging in the event warranty service is necessary.



Handset

(1 for 30522XE1  
2 for 30522XE2  
3 for 30522XE3  
4 for 30522XE4)

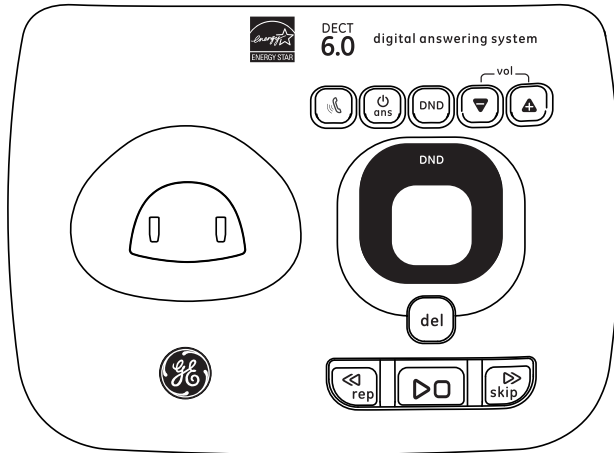

Telephone base

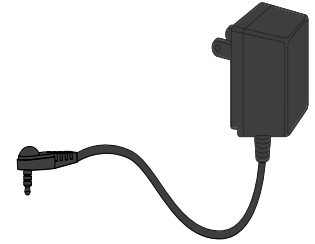

Power adapter for telephone base

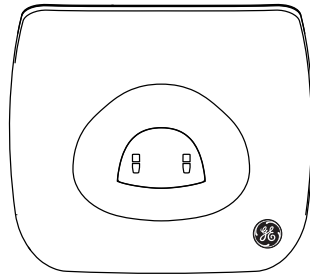

Charger

(1 for 30522XE2  
2 for 30522XE3  
3 for 30522XE4)

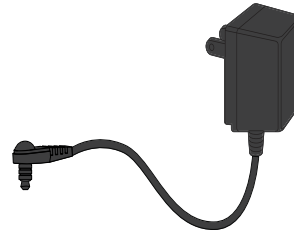

Power adapter for charger

(1 for 30522XE2  
2 for 30522XE3  
3 for 30522XE4)

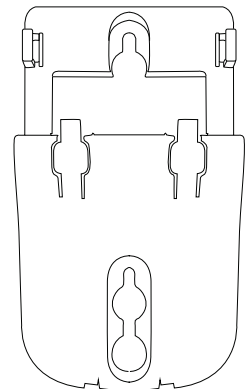

Wall mount bracket

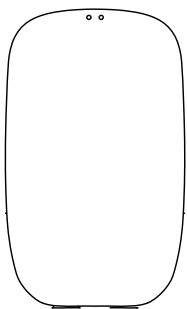

Battery compartment cover

(1 for 30522XE1  
2 for 30522XE2  
3 for 30522XE3  
4 for 30522XE4)

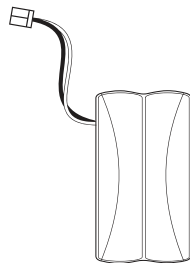

Battery

(1 for 30522XE1  
2 for 30522XE2  
3 for 30522XE3  
4 for 30522XE4)



Telephone line cord



User's guide

# Getting started

## Telephone base installation

1. Plug the smaller end of the power adapter into the power jack at the back of the telephone base.
2. Plug one end of the telephone line into the jack at the back of the telephone base.
3. Plug the other end of the telephone line into a telephone wall jack.
4. Plug the larger end of the power adapter into an electrical outlet not controlled by a wall switch.

If you have DSL high speed Internet service, a DSL filter is required (not included). Contact your DSL service provider for more information about DSL filter.

### Telephone base installation

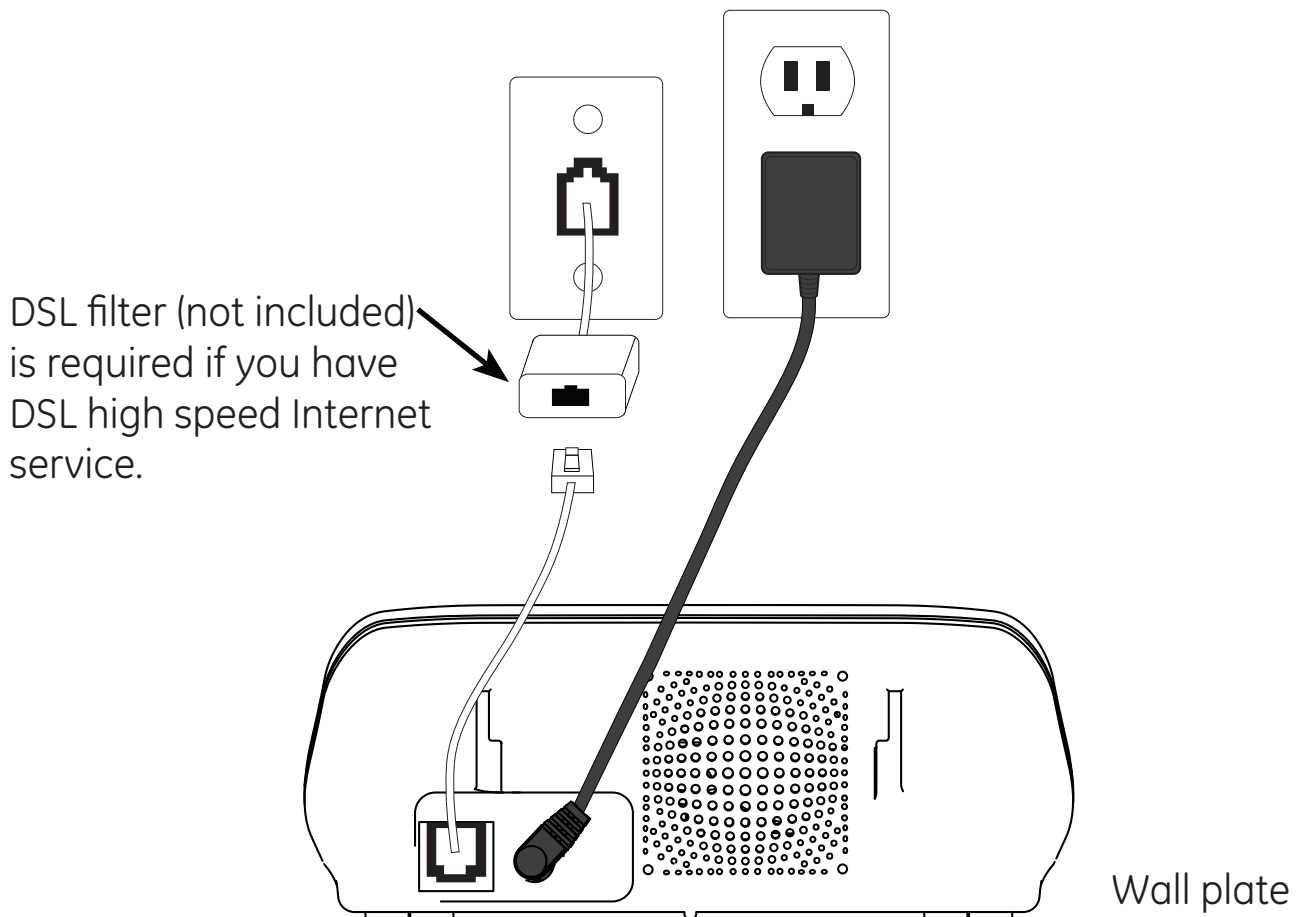

### Telephone jack requirements

To use this phone, you need a RJ11C type modular telephone jack, which might look like the one pictured here. If you do not have a modular jack, call your telephone service provider to find out how to have one installed.

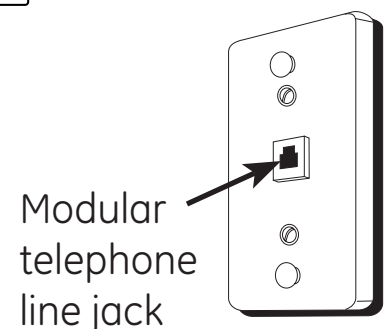

# Getting started

## Charger installation

(For models with additional handsets)

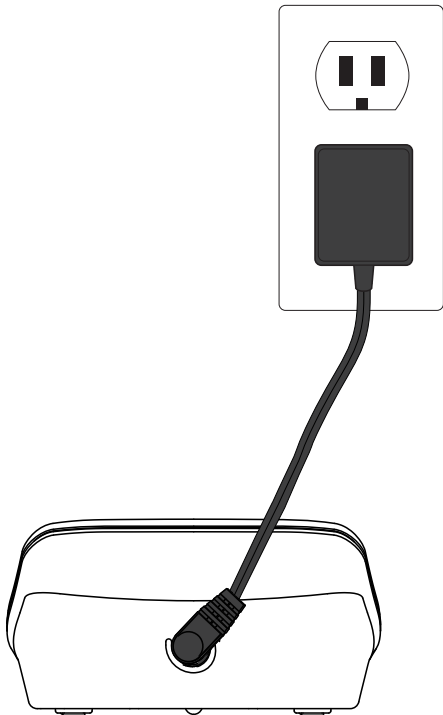

1. Plug the smaller end of the power adapter into the jack on the back of the charger.
2. Plug the larger end of the power adapter into an electrical outlet not controlled by a wall switch.



### **CAUTION:**

1. Use only the power adapter that came with this unit. Using other power adapters may damage the unit.
2. To prevent fire or electrical shock hazard, do not expose this product to rain or moisture.





# Getting started

## Wall mount installation

The telephone comes ready for desktop use. If you want to mount your telephone on the wall, follow the steps below.

1. Make sure the telephone line cord is unplugged from the modular jack and the power adapter cord is unplugged from the electrical outlet before installation.
2. Thread the power cord through the center cut out of the wall bracket as shown below.

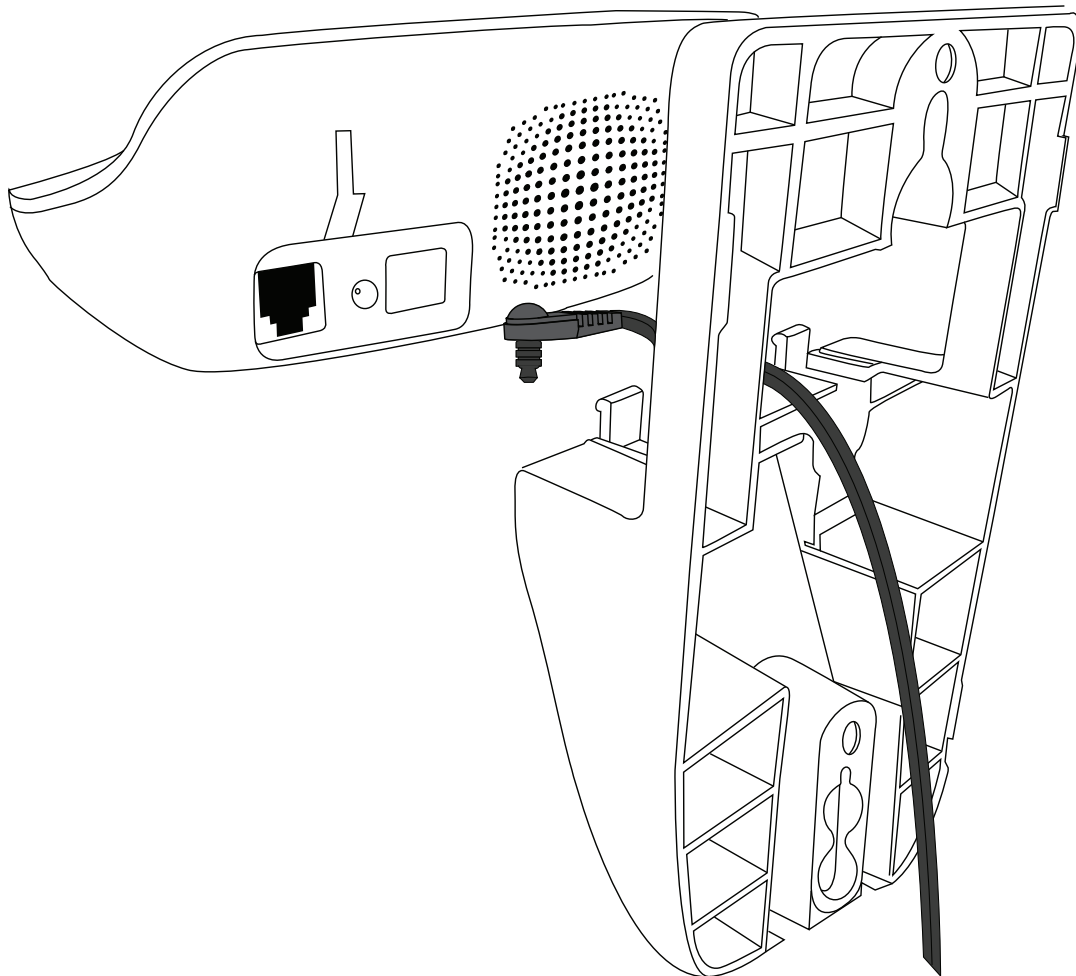

## Getting started

3. Plug the power adapter cord into the jack on the back of the telephone base. Align the tabs at the top of the wall bracket with the recessed slots on the back of the base unit. Align the lower tabs of the wall bracket with the slots on the bottom of the base. Slide the wall bracket upwards until it locks into place. Be sure the power cord is threaded through the center opening and securely plugged in. Route the power cord through either slot at the bottom of the wall mount bracket.

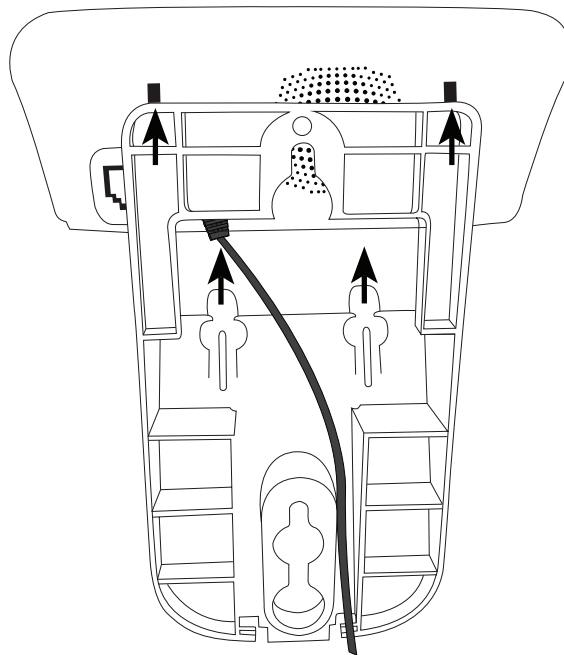

4. Plug one end of the telephone line cord into the jack on the back of the telephone base.

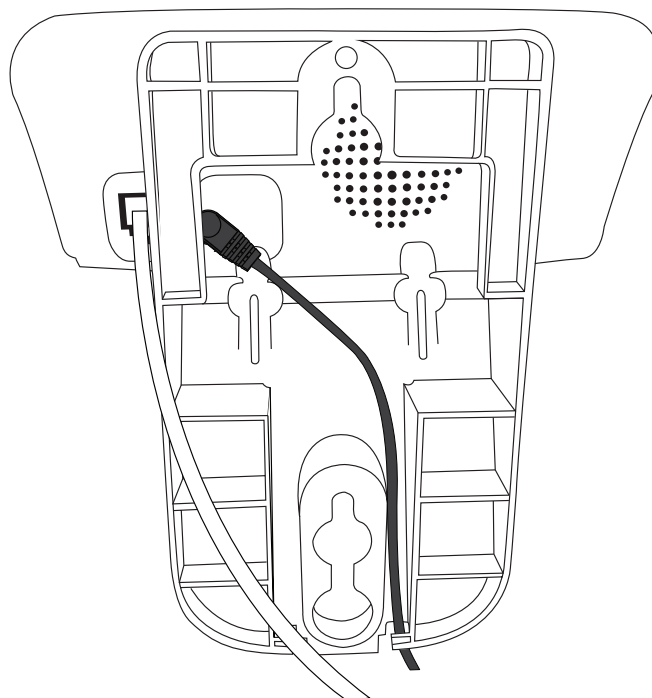

## Getting started

5. Route the telephone line cord through the open slot at the bottom of the wall mount bracket, leaving about 8 inches from the slot to the end of the cord as shown. Plug the line cord into the jack on the wall plate. Align the holes on the mounting bracket with the mounting studs of the wall plate and slide the bracket down until it locks securely.

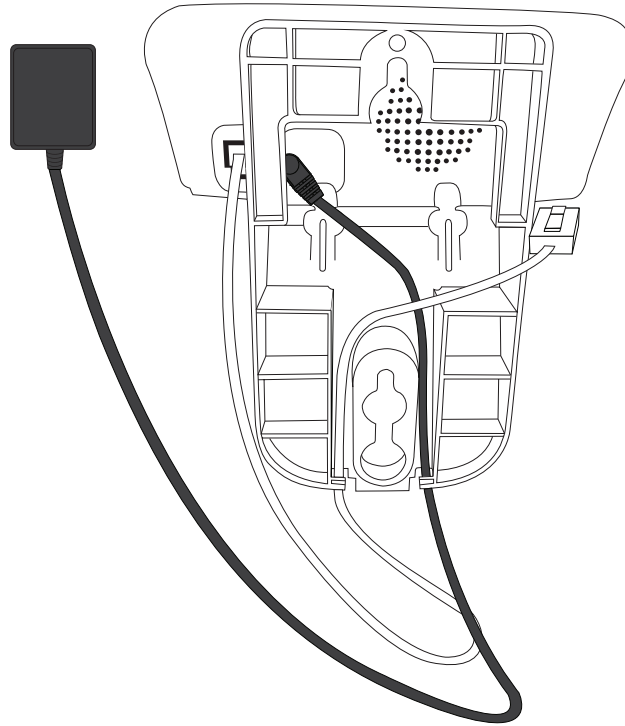

6. Plug the power adapter into an electrical outlet. Be sure to avoid using an electrical outlet that is controlled by a wall switch. The handset may now be placed in the base for charging.

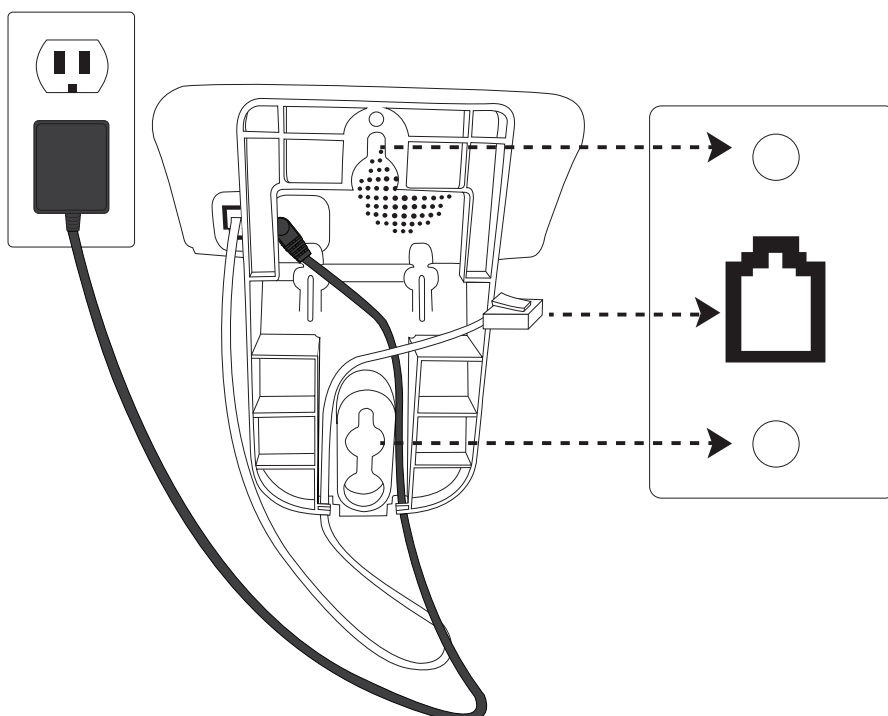

## Getting started

7. To test the installation, pick up the handset, press the  button. If you hear a dial tone, the installation is correct.
8. Neatly tie the excess telephone line cord with a twist tie so it is held close to the bottom of the base unit.

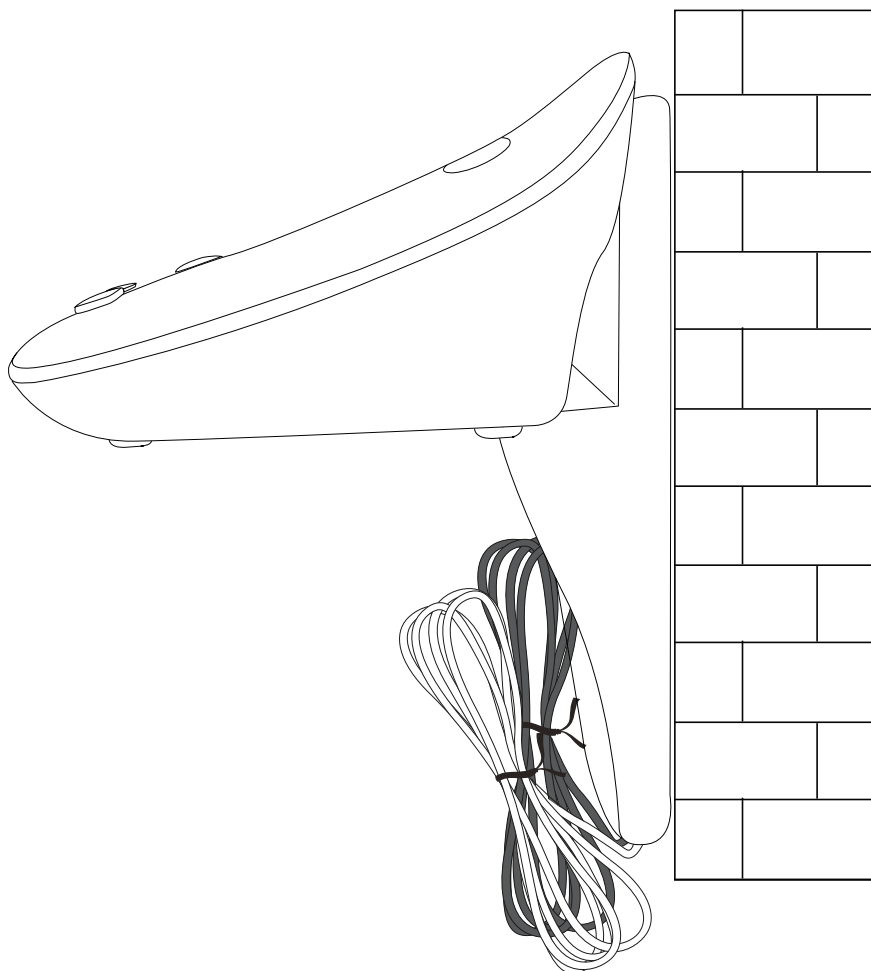

# Overview

## Telephone base layout

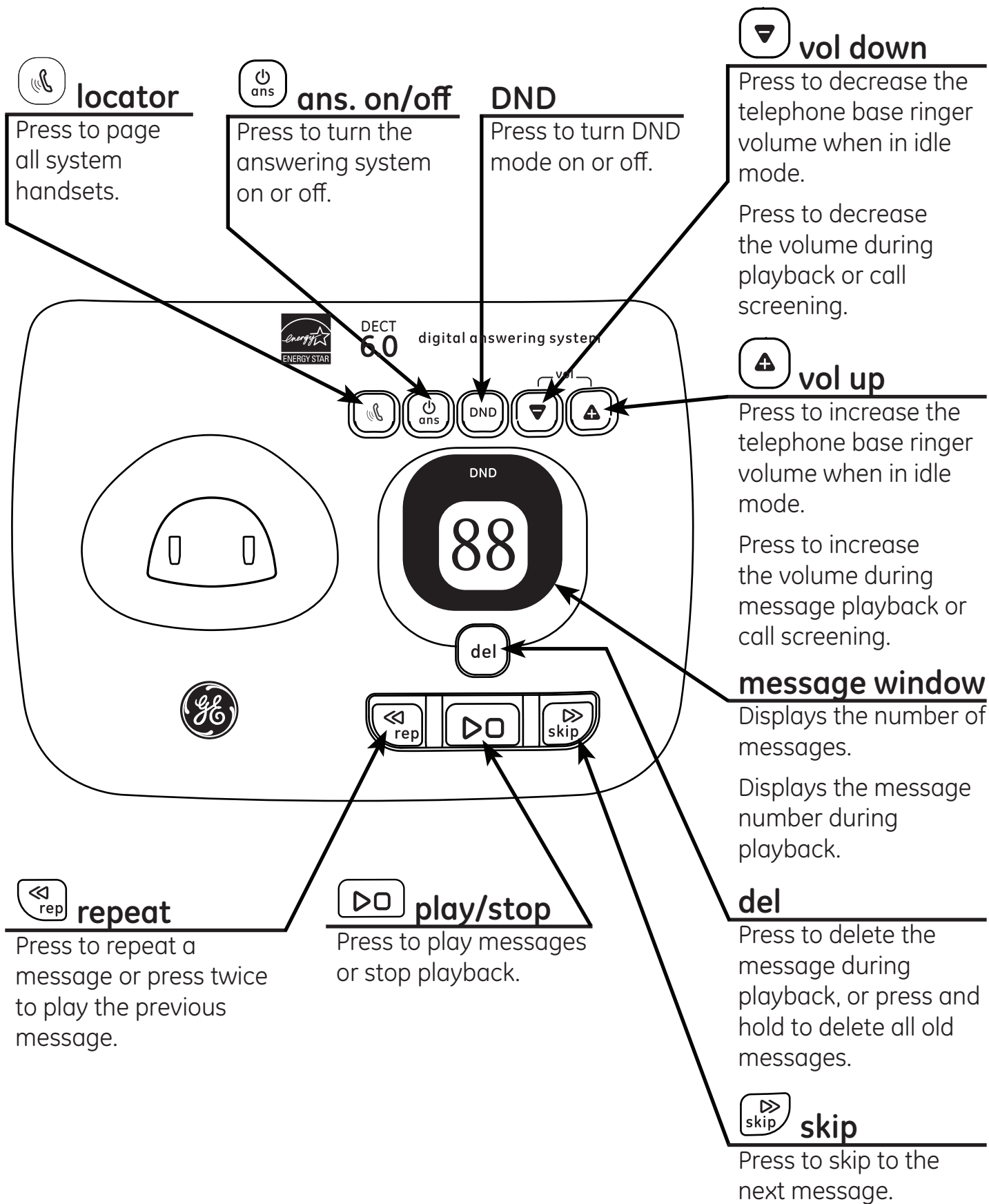

# Overview

## Handset layout

### CID/volume up

- Press to review the call log when the telephone is not in use.
- While in menu, press to scroll up.
- During a call, press to increase the incoming volume.

### flash

- During a call, press to answer an incoming call if you receive a call waiting alert (if you have subscribed to the call waiting feature from your service provider).
- Press to access message playback when in idle mode.

### talk/speaker

- Press to make or answer a call.
- Press to switch to speakerphone during a call or message playback.
- During a call, press to switch between speakerphone and normal handset use.

### del/int

- Press to delete the last number or letter entered.
- Press to initiate an intercom call or transfer a call.

### \*/tone

- During a call, press to send touch-tone signals temporarily.

### off/cancel

- During a call, press to hang up.
- During programming, press to cancel and exit without making changes.

### menu/ok/mute

- Press to show menu.
- Press to select an item, or to save an entry or setting.
- Press to mute a call, press again to resume conversation.

### volume down

- While in menu, press to scroll down.
- During a call, press to decrease the incoming volume.

### redial/format

- Press to review redial list.
- Press to change the telephone number format (7 digits, 1+, or 1+ area code) for appropriate dialing.

### phonebook

- Press to review the phonebook when the telephone is not in use.

### #/pause/ringer off

- Press and hold to turn the ringer off.
- Press and hold to add a dialing pause when dialing or entering numbers into phonebook.

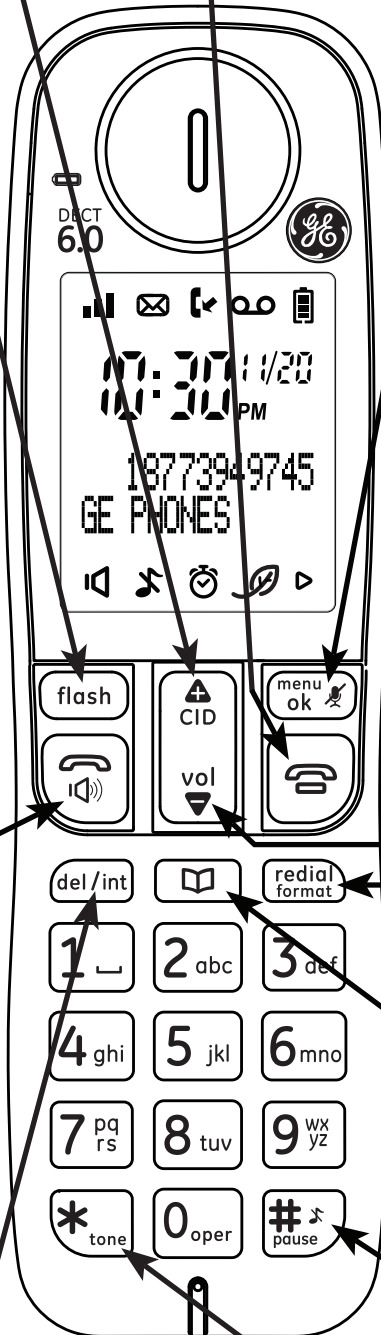

# Overview





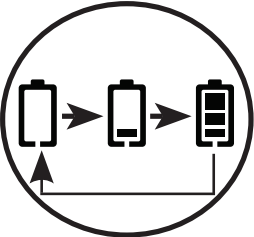

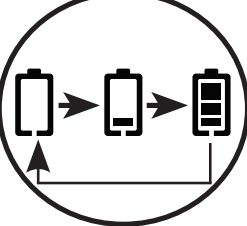

## Battery charging

The following table summarizes the battery charge indicators and what actions need to be taken.

Battery indicators	Battery status	Action
Battery icon is scrolling. 	Battery is charging.	Keep the handset in the telephone base or charger when not in use.
Battery icon is on steadily.	Battery is completely charged.	The handset is ready for use. It will take approximately 2 hours for the battery icon to indicate a full charge even if the handset is only removed from the telephone base or charger for a short time and replaced. This is a normal operation and does not indicate a battery issue.
Battery icon is empty and the screen shows <b>LOW BATTERY</b> .	Battery is low.	Place the handset in the telephone base or charger to charge without interruption (at least 30 minutes) before use.
The screen is blank.	Battery has no power while the handset is out of the telephone base or charger.	Place the handset in the telephone base or charger for at least 16 hours without interruption. See troubleshooting on page 45 for help if the screen remains blank after charging.

# Overview

## Screen display icon











Item	Meaning
	<ul style="list-style-type: none"><li>• Displays when the telephone base is within reception range.</li><li>• Flashes when the telephone base is out of range.</li></ul>
	<ul style="list-style-type: none"><li>• Scrolls to indicate battery charging when handset is in the telephone base or charger.</li><li>• Flashes and empty when battery level is low.</li></ul>
	<ul style="list-style-type: none"><li>• Speakerphone is in use.</li></ul>
	<ul style="list-style-type: none"><li>• Displays when there are new calls.</li></ul>
	<ul style="list-style-type: none"><li>• Displays when there is a new voice mail message. (Available only if you have subscribed to voice mail service from your telephone service provider.)</li></ul>
	<ul style="list-style-type: none"><li>• Displays when the alarm is set.</li></ul>
	<ul style="list-style-type: none"><li>• Displays when energy saving mode is activated.</li></ul>
	<ul style="list-style-type: none"><li>• Displays when the ringer is turned off.</li></ul>
	<ul style="list-style-type: none"><li>• Displays when answering system is on.</li><li>• Flashes when there are new messages.</li></ul>



# Initial settings

## Dialing mode

The default dialing mode is **TONE** for touch tone dialing. If you have pulse or rotary service, you can change this setting to accommodate your telephone line service.



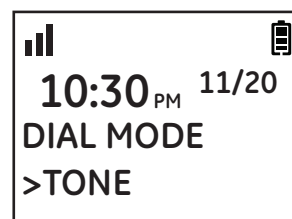
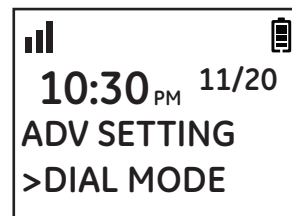





1. Press .
2. Press  or  to select **ADV SETTING** and then press .
3. Press  or  to select **DIAL MODE** and then press .
4. Press  or  to select the desired setting and then press  to confirm.



## Programming your area code (optional)

If you program your area code, the caller ID history displays only seven digits of the telephone numbers from your area code.

To set the area code:

1. Press .
2. Press  or  to select **ADV SETTING** and then press .
3. Press  or  to select **AREA CODE** and then press .
4. Enter your area code and then press  to confirm.

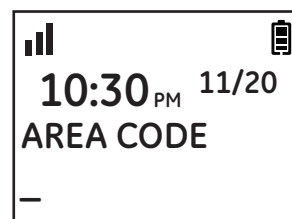
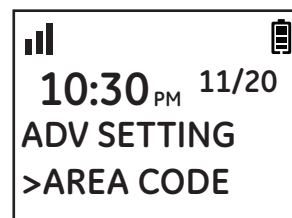

# Telephone operation

## Make a call

1. Press .
2. Dial the phone number after you hear the dial tone.

## Redial a call

1. Dial the phone number using the dial pad keys. If you make an error while dialing, you can press **del/int** to erase the last digit entered.
2. Press .

## Answer a call

Press  to answer an incoming call.



When there is an incoming call, the screen and dial pad backlight will be on.

**NOTE:** The screen shows the elapsed time as you talk (in hours, minutes and seconds).

## End a call

Press  or place the handset in the telephone base or charger to end a call.

## Speakerphone

Anytime during a call, press  to switch between speakerphone and normal handset use. When the speakerphone is active, the handset screen shows .

**NOTE:** Using the speakerphone will drain the battery faster than the normal handset use.

## Volume control

You can adjust the volume of the handset or speakerphone anytime during a call.

On the handset, press  to increase or  to decrease the volume.



**NOTE:** Only the listening volume can be adjusted.

# Telephone operation

## Make a call using the redial memory



The last ten telephone numbers previously dialed are stored in the redial list (up to 24 digits each).

1. Press **redial/format**.

2. Press  or  to select the desired phone number and then press  to dial.

## Save a number from the redial list to the phonebook

1. Press **redial/format**.

2. Press  or  to select the desired phone number and then press .



3. Press  or  to select **SAVE NUMBER** and then press .

4. Enter the name by using the dial pad, refer to the character table on page 31 for more information, and then press .

5. Edit the number by using the dial pad if necessary, and then press .

## Delete number from the redial list

1. Press **redial/format**.

2. Press  or  to select the desired phone number and then press .

3. Press  or  to select **DELETE** and then press  twice to delete the selected number.

**-OR-**

Press  or  to select **DELETE ALL** and then press  twice to delete all numbers in the redial list.

## Mute

The mute function allows you to turn off the microphone while on a call. You can hear the other party but the other party cannot hear you.

1. Press  during a call.

2. Press  again to resume conversation.

**NOTE:** The screen shows **MUTE ON** when mute feature is activated.

# Telephone operation

## Call waiting or call waiting with caller ID service

To use call waiting, you must subscribe to call waiting service from your telephone service provider. This feature allows you to receive calls while you are already talking on the phone. You will hear a call waiting alert tone when there is a second incoming call. If you subscribe to both caller ID and call waiting with caller ID services, the second caller's information is displayed after you hear the call waiting alert tone.

1. Press **flash** to answer the second incoming call.
2. Press **flash** to switch between calls.

## Voice mail service

The  icon flashes on the screen when you have received a new voice mail message from your service provider.

**IMPORTANT:** Voice mail service is different from the answering system. In order to use the voice mail service, you must subscribe to it from your telephone service provider.



## Using multiple handsets

The system allows a maximum of two handsets to have a conversation with an outside call at a time. If a handset is already on a call and you would like to join the call, press  on another handset.

The call will not be terminated until all handsets hang up.

## Handset locator

You can locate a misplaced handset by paging it.



1. Press  on the telephone base. All registered handsets beep for one minute.
2. Press  on the telephone base or press  on any handset to stop paging.

# Telephone operation

## Intercom

The system allows an intercom call between two handsets registered to the same telephone base.

To initiate an intercom call:

1. Press **del/int**.
  - If your telephone system has only two handsets registered, the intercom call will be automatically directed to the other system handset.
  - If your telephone system has more than two handsets registered, enter the handset number you want to call by using the dial pad **1-5**.
2. Press  to answer the intercom call on the other handset.
3. To end the intercom call, press .

### NOTES:

- 1) The intercom call can be canceled before it is answered by pressing  or **del/int** on the originating handset.
- 2) If the handset being called does not answer within one minute, the paging will be canceled.

## To answer an incoming call during intercom

You will hear an alert tone when you receive an incoming call during intercom.

- Press  to answer the incoming call and end the intercom.
- Press **del/int** to answer the incoming call and put the intercom on hold. Press **del/int** to switch between intercom and the incoming call.
- Press and hold **del/int** to conference with both the incoming call and the intercom.

# Telephone operation

## To initiate an intercom during a call

You can intercom with another system handset during a call, or invite another system handset to join.

1. Press **del/int** during a call.
  - If your telephone system has only two handsets registered, the intercom call will be automatically directed to the other system handset.
  - If your telephone system has more than two handsets registered, you will need to enter the handset number you want to intercom to by using the dial pad **1-5**.  
The call is placed on hold while the intercom is established with the other handset.

2. Press  to answer the intercom on the other handset.

**NOTE:** The intercom call can be canceled before it is answered by pressing **del/int** on the originating handset.



3. You can choose from one of the following options for this intercom call.
  - Press and hold **del/int** to connect both handsets to the call.
  - Press **del/int** on the originating handset to alternate between the intercom and the call.
  - Press  on either handset to terminate the intercom on that handset. The call will continue on the other handset.

# Telephone operation

## Push to talk (PTT)

You can directly broadcast messages to the speakerphone of any registered handset in the system.

### To initiate a PTT:









1. Press the **PTT** button on the right side of the handset.
  - If your telephone system has only two handsets registered, the broadcast will be automatically directed to the other system handset.
  - If your telephone system has more than two handset. Press  or  to select the handset you want to broadcast the message, or select **ALL HANDSET** to broadcast to all handsets and then press .
2. **PRESS AND HOLD (PTT) TO TALK** shows on the screen when the connection is set between the initiating handset and the destination handset.
3. Press and hold the **PTT** button on either handset to start the broadcast.



**NOTE:** Connection set between handsets lasts for 30 minutes after it is established, or 30 minutes after the last broadcast. You will need to perform the above operation again if you want to initiate a PTT to another system handset or after the 30-minute time out.

# Handset settings

## Ringer volume

You can set the handset ringer volume from level 1 to level 5 or turn the ringer off.

1. Press .
2. Press  or  to select **HANDSET TONES** and then press .
3. Press  again to select **RING VOLUME**.
4. Press  or  to select the desired setting and then press  to confirm.

**NOTE:** Press and hold the  key to switch the ringer between on and off when the handset is in idle mode. The  icon displays on the screen when ringer off feature is activated

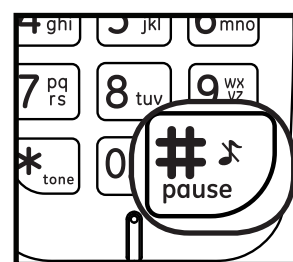
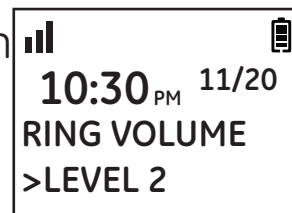
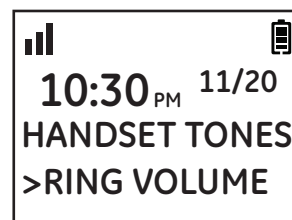

## Ringer melody

You can select from 10 ringer melodies.

1. Press .
2. Press  or  to select **HANDSET TONES** and then press .
3. Press  or  to select **RING MELODY** and then press .
4. Press  or  to select the desired setting (MELODY 1 to 10) and then press  to confirm.

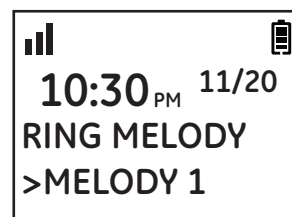
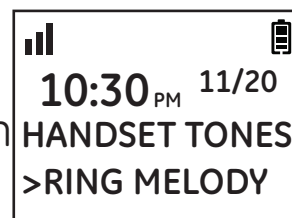













# Handset settings

## Key tone

The handset can be programmed to emit a tone with each key press. You can choose to turn this feature on or off. The default setting is **ON**.





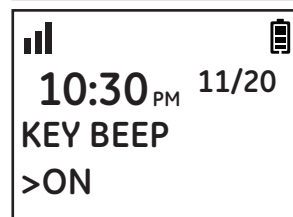
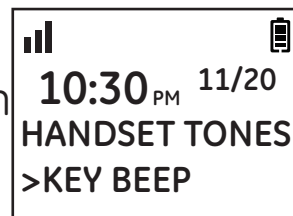



To change the key tone setting:

1. Press .
2. Press  or  to select **HANDSET TONES** and then press .
3. Press  or  to select **KEY BEEP** and then press .
4. Press  or  to select **ON** or **OFF** and then press  to confirm.



## Display language

You can select **ENGLISH**, **ESPAÑOL** or **FRANCIS** as the display language. The default setting is **ENGLISH**. To change the display language:



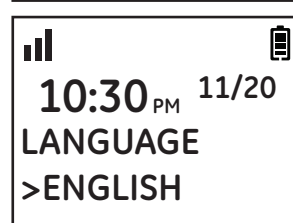
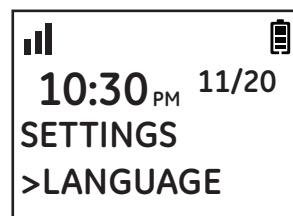







1. Press .
2. Press  or  to select **SETTINGS** and then press .
3. Press  again to select **LANGUAGE**.
4. Press  or  to select the desired setting and then press  to confirm.



# Handset settings

## Equalizer





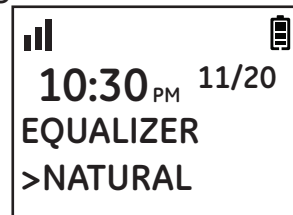
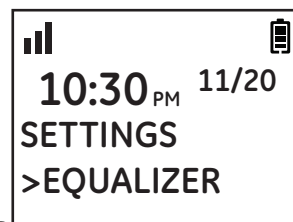





This feature allows you to change the balance of the audio of the handset to best suit your hearing.

1. Press .
2. Press  or  to select **SETTINGS** and then press .
3. Press  or  to select **EQUALIZER** and then press .
4. Press  or  to select from **NATURAL**, **BASS** or **TREBLE**.
5. Press  to confirm.



## Energy save

This feature enables the handset to operate in energy saving mode. With this feature turned on, the handset will automatically turn the handset backlight off and adjust the ringer volume to level 2.

1. Press .
2. Press  or  to select **SETTINGS** and then press .
3. Press  or  to select **ENERGY SAVE** and then press .
4. Press  or  to select **ON** or **OFF** and then press  to confirm.

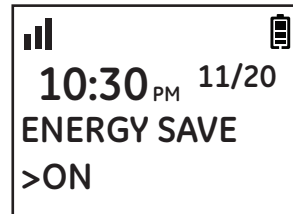
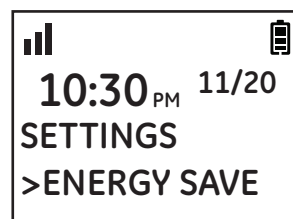









**NOTE:** When **ENERGY SAVE** is turned on, the  icon shows on the handset screen.

# Base settings

## Base ringer melody





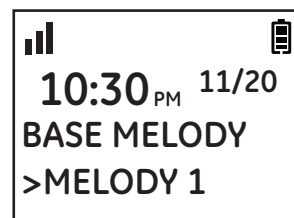
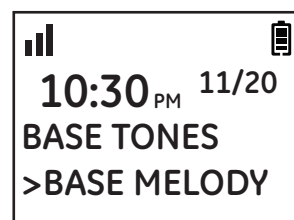





You can select from 5 ringer tones.

1. Press .
2. Press  or  to select **BASE TONES** and then press .
3. Press  again to select **BASE MELODY**.
4. Press  or  to select the desired setting and then press  to confirm.



## Base ringer volume

You can set the telephone base ringer volume from level 1 to level 5 or turn the ringer off.



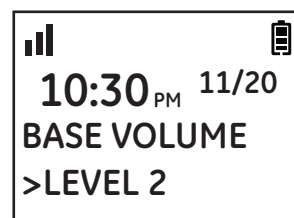
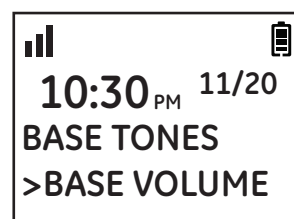



1. Press .
2. Press  or  to select **BASE TONES** and then press .
3. Press  or  to select **BASE VOLUME** and then press .
4. Press  or  to select the desired setting (LEVEL 1 to 5 or OFF) and then press  to confirm.



# Block list

You can program telephone numbers into the block list so that the telephone silences when a call is received from one of the blocked numbers. The handset shows **BLOCK LIST** when the programmed numbers call and will not record the number in the caller ID history.

## To add a new entry



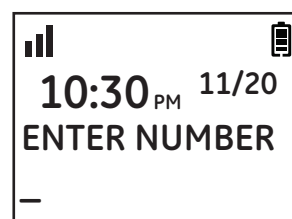
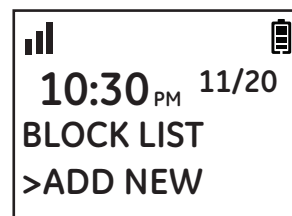







1. Press .
2. Press  or  to select **BLOCK LIST** and then press .
3. Press  again to select **ADD NEW**.
4. Enter the desired number and then press  to confirm.



## To view the list

1. Press .
2. Press  or  to select **BLOCK LIST** and then press .
3. Press  or  to browse through the block list.





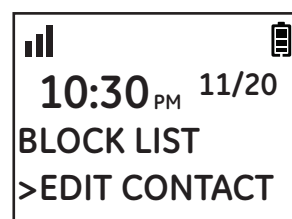





## To edit an entry

1. Press .
2. Press  or  to select **BLOCK LIST** and then press .
3. Press  or  to select the desired entry and then press .
4. Press  or  to select **EDIT CONTACT** and then press  twice.
5. Edit the number by using the **del/int** key to erase and backspace, then enter new numbers using the dial pad keys and press .









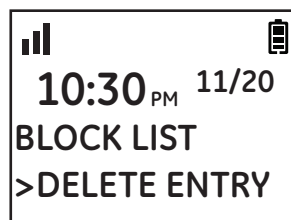



# Block list

## To delete an entry

1. Press .
2. Press  or  to select **BLOCK LIST** and then press .
3. Press  or  to select the desired entry and then press .
4. Press  or  to select **DELETE ENTRY** and then press  3 times to confirm.



## To delete all entries

1. Press .
2. Press  or  to select **BLOCK LIST** and then press .
3. Press  or  to select any entry and then press .
4. Press  or  to select **DELETE ALL** and then press  twice to confirm.

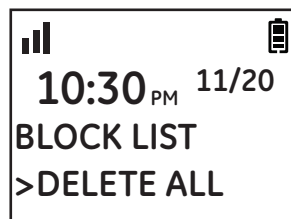

# Do not disturb

When **DO NOT DISTURB (DND)** mode is activated, all incoming calls will be silent. This feature only silences the ringer, the incoming number, if you have subscribed to the caller ID service from your telephone service provider, will be recorded in the caller ID history as normal.







## Global DND

When global DND is activated, all system handsets and the telephone base will be silent when there is an incoming call. Press the **DND** button on the telephone base to turn this feature on or off.

## Handset DND

You can program individual handset to silence during predetermined time frames. This setting is independent to each handset and only silences the ringer of the handset programmed.







To program the **DND** time for individual handset

1. Press .
2. Press  or  to select **PROGRAM DND** and then press .
3. Press  or  to select the desired option and then press  to confirm.

**ONE TIME:** The telephone silences once during the set time.

**DAILY:** The telephone silences daily during the set time.

**OFF:** Turn DND off (settings completed).

4. Enter the desired start time. For example, 9:30 should be entered as [0], [9], [3], [0]. Press  or  to select **AM** or **PM** and then press  to confirm.
5. Enter the desired stop time. For example, 7:30 should be entered as [0], [7], [3], [0]. Press  or  to select **AM** or **PM** and then press  to confirm.

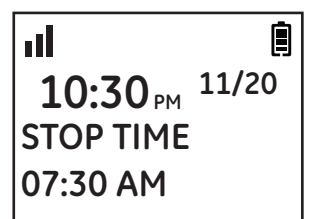
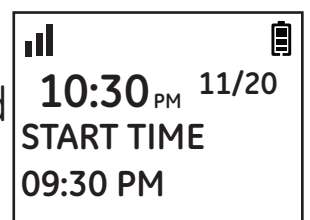
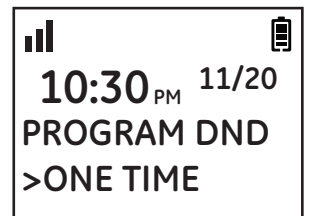









**NOTES:** When global DND is turned on, individual handset will continue to be in DND mode even after the set DND time on the handset ends.

# Clock and alarm

## Date and time





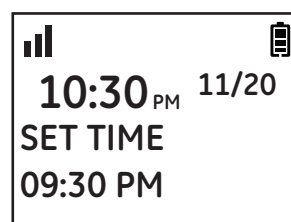
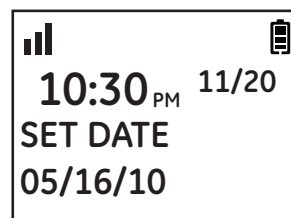
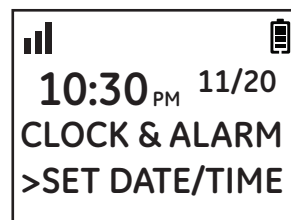





You can set the date and time of the telephone system as follows.

1. Press .
2. Press  or  to select **CLOCK & ALARM** and then press .
3. Press  again to select **SET DATE/TIME**.
4. Enter the current month, day and year. For example, May 16, 2010 should be entered as [0], [5], [1], [6], [1], [0].
5. Press  to confirm.
6. Enter the current hour and minute. For example, 9:30 should be entered as [0], [9], [3], [0]. Press  or  to select **AM** or **PM** and then press  to confirm.



## Time format

The display format of time can either be selected as 12 hour or 24 hour. The default setting is 12 hour. To change your setting:



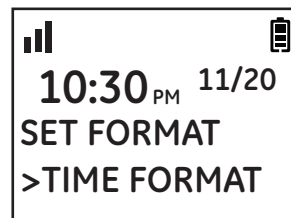
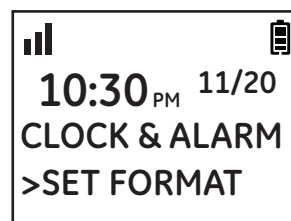









1. Press .
2. Press  or  to select **CLOCK & ALARM** and then press .
3. Press  or  to select **SET FORMAT** and then press .
4. Press  again to select **TIME FORMAT**.
5. Press  or  to select the desired setting (**12 HOURS** or **24 HOURS**) and then press  to confirm.



# Clock and alarm

## Date format





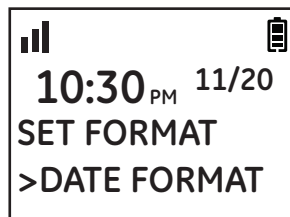
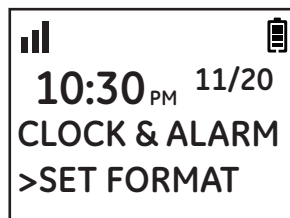







The display format of date can either be selected as Month/Day or Day/Month. The default setting is Month/Day. To change your setting:

1. Press .
2. Press  or  to select **CLOCK & ALARM** and then press .
3. Press  or  to select **SET FORMAT** and then press .
4. Press  or  to select **DATE FORMAT** and then press .
5. Press  or  to select the desired setting (**MM/DD** or **DD/MM**) and then press  to confirm.



## Alarm

The alarm can be programmed to sound once or daily for one minute. The alarm setting is independent to each handset.

1. Press .
  2. Press  or  to select **CLOCK & ALARM** and then press .
  3. Press  or  to select **ALARM** and then press .
  4. Press  or  to select the desired alarm option and then press .
- OFF:** Turn alarm off (go to step 6).  
**ONE TIME:** The alarm sounds once at the set time.  
**DAILY:** The alarm sounds daily at the set time.
5. Enter the desired hour and minute and then press  or  to select **AM** or **PM**.
  6. Press  to confirm.

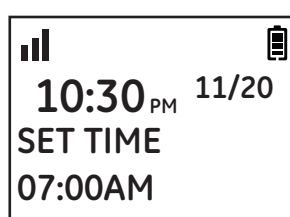
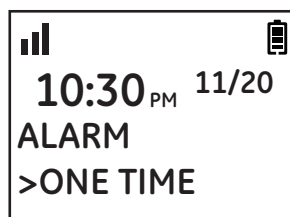
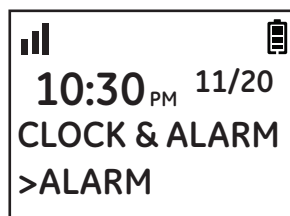













# Clock and alarm

## Alarm tone





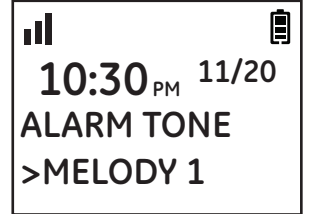
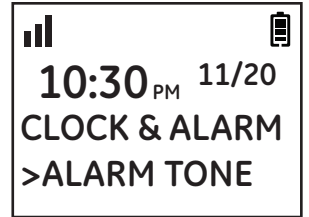



You can select from 3 alarm melodies.

1. Press .
2. Press  or  to select **CLOCK & ALARM** and then press .
3. Press  or  to select **ALARM TONE** and then press .
4. Press  or  to select the desired alarm tone and then press  to confirm.





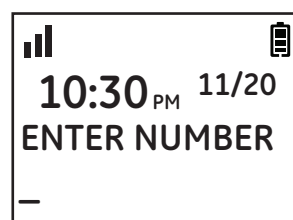
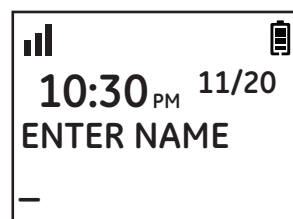
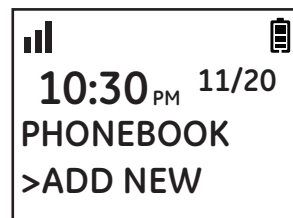
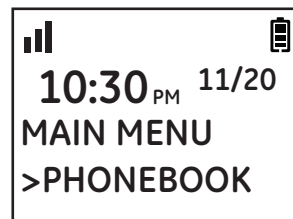

# Phonebook

## Add a phonebook record

1. Press .
2. Press  or  to select **PHONEBOOK** and then press .
3. Press  again to select **ADD NEW**.
4. Enter the name (max. 14 character). Press the key to the corresponding character to display the correct letter. See the character table on page 31 for more information.
5. Press .
6. Enter the number (max. 20 digits). If you need a pause between digits, press and hold the  until a **P** appears in the display. This will insert a 3-second pause in the dialing sequence.
7. Press  to save the new entry.



### -OR-

1. Enter the number (max. 20 digits). If you need a pause between digits, press and hold the  until a **P** appears in the display. This will insert a 3-second pause in the dialing sequence.
2. Press .
3. Enter the name (max. 14 character). Press the key to the corresponding character to display the correct letter. See the character table on page 31 for more information.
4. Press .
5. Edit the number if necessary.
6. Press  to confirm.

### NOTES:

1. The phonebook is shared by all handsets. Changes made to the phonebook on any one handset apply to all.
2. The directory can store up to 100 entries with up to 20 digits for each telephone number and 14 characters for each name.

# Phonebook

## Character table

Use the dial pad and the chart below to enter a name (up to 14 characters). Each press of a particular key displays the character in the following order:

Dial pad key	Character by number of key presses					
	1	2	3	4	5	6
[1]	space	1	_	<	>	?
[2]	A	B	C	2		
[3]	D	E	F	3		
[4]	G	H	I	4		
[5]	J	K	L	5		
[6]	M	N	O	6		
[7]	P	Q	R	S	7	
[8]	T	U	V	8		
[9]	W	X	Y	Z	9	
[0]	0	-	/		#	+

**NOTE:** Press **del/int** to correct an error.

# Phonebook

## To view/call a phonebook record





Records are stored alphabetically in the phone book. To search the phonebook:

1. Press  when handset is not in use.

**NOTE:** You can also access the phonebook by pressing  and selecting **PHONEBOOK**.

2. Press  or  to find an entry.
3. Press  to call the displayed entry.

## To search a phonebook entry alphabetically

1. Press  when the handset is not use.
2. Press the dial pad key (0-9) that corresponds to the first letter of the entry you are looking for. The closest match in alphabetical order will appear. You can then press  or  to view the next entry.
3. Press  to view the phone number.





**-OR-**

Press  to call the displayed entry.

## Chain dialing









This feature allows you to initiate a dialing sequence from numbers stored in the phonebook while you are on a call. This feature is useful if you wish to access another numbers (such as bank account information or access code) from the phonebook.

To access a number in the phonebook while on a call:

1. Press  and the phonebook will display.
2. Press  or  to locate the desired entry.
3. Press  to dial the number.





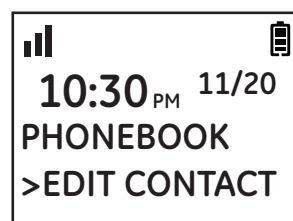

# Phonebook

## Edit a phonebook entry

1. Press  when the handset is not in use.
2. Press  or  to locate a desired entry and then press .
3. Press  or  to select **EDIT CONTACT** and then press  twice.
4. Edit the name by using the **del/int** key to erase and backspace, then enter new characters using the dial pad keys and press .
5. Edit the number by using the **del/int** key to erase and backspace, then enter new numbers using the dial pad keys and press .







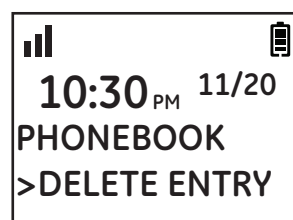

## Delete a phonebook entry

1. Press  when the handset is not in use.
2. Press  or  to locate a desired entry and then press .
3. Press  or  to select **DELETE ENTRY**.
4. Press  3 times to delete the selected entry.



## Delete all phonebook entries

1. Press  when the handset is not in use.
2. Press  or  to select any entry and then press .
3. Press  or  to select **DELETE ALL**.
4. Press  twice to delete all entries.

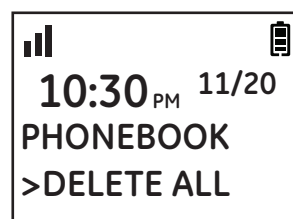

# Caller ID

## Using Caller ID service

**IMPORTANT:** To use the Caller-ID capabilities of this telephone system, you must subscribe to Caller-ID services from your service provider. Check with your telephone service provider for details.

Caller ID records are stored in the order that they are received.

Your telephone stores caller ID memory for the 50 most recent calls. When the 51st call is received, the oldest Caller ID record (first call) is automatically deleted. Each entry holds up to 20 digits for the telephone number and 14 characters for the name.

## Phonebook Caller-ID matching





If the last seven digits of an incoming telephone number match a telephone number in your phonebook, the name from this entry will display on the screen.

For example, if Michael Jones calls, and his number is saved in the phonebook under the name **MIKE**, the screen displays the name **MIKE**.

**NOTE:** The number you see on your caller ID is in the format sent by the telephone service provider. It usually delivers 10-digit telephone numbers (area code plus telephone number). If the last seven digits of the incoming telephone number do not match with a number in your phonebook, the name appears as it is delivered by the telephone service provider.

## Review/call from the call log

As calls are received and stored, the display is updated to let you know new calls have been received. To scroll through the caller ID records:









1. Press  to display the caller ID list.
2. Press  to view from the most recent calls, or  to view the oldest calls.
3. When the desired record is displayed, press  to call.

**-OR-**

Press **redial/format** repeatedly until the phone number is shown in the desired format (for example, when 555-5555 is displayed, press **redial/format** to change the format of the phone number to 555-555-5555, 1-555-555-5555, and back to 555-5555), then press  to call.







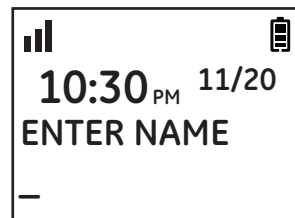
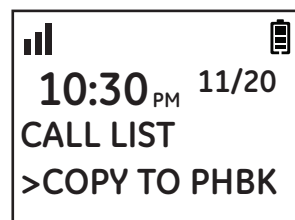



# Caller ID

## Save a number to the phonebook

1. Press .
2. Press  or  to locate the desired record and then press .
3. Press  or  to select **COPY TO PHBK** and then press .
4. Enter the name by using the dial pad keys if necessary, and then press .
5. Edit the number by using the dial pad keys if necessary, and then press  to save.



## Delete caller ID record

1. Press .
  2. Press  or  to locate the desired record and then press .
  3. Press  or  to select **DELETE** to delete the selected record, and then press  twice.
- OR-**
- Press  or  to select **DELETE ALL** to delete all records, and then press  twice to confirm.

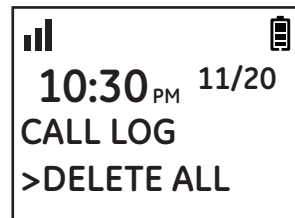
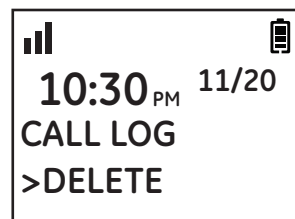

## Call log display screen messages



Display	When
<b>PRIVATE</b>	<p>The caller is blocking the name and the telephone number is out of area.</p> <p>The caller is blocking the telephone number and the name is out of area.</p> <p>The caller is blocking the name and telephone number.</p>
<b>OUT OF AREA</b>	The caller's name and telephone number are out of area.

# Answering system









This section explains how to set up your answering system. Before you begin the setup process, please make sure that the answering system is on.

## Turning the answering system on or off

### Using the telephone base:

Press  on the telephone base to turn the answering system on or off. The  button will light when the answering system is on.

### Using a handset:

1. Press .
2. Press  or  to select **ANS SYSTEM** and then press .
3. Press  again to select **ANSWER ON/OFF**.
4. Press  or  to select **ON** or **OFF**, and then press .

## Answering system and voice mail

Your telephone has a built-in answering system and voicemail indicator (if you subscribe to voicemail offered by your telephone service provider). They are independent features and each alerts you to new messages differently.

To listen to your voicemail, follow the instructions provided by your voicemail service provider. To listen to messages recorded on your answering system, refer to page 40.

## Message capacity

The answering system can record up to 59 messages. Each message can be up to 3 minutes in length, and the total recording time is 20 minutes.

## Telephone base volume

Use the  button to adjust the playback volume at the telephone base to a comfortable level (a beep tone will sound when the volume reaches the maximum or minimum level.)



# Answering system

## New message indicator











When there are new messages on the answering system, the number of new messages flashes on the message window on the telephone base, the  icon flashes and **XX TAM MSG** displays on the handset screen.

## Outgoing Announcement (OGA)

When the answering system answers a call, the pre-recorded outgoing announcement is played to the caller unless you have recorded your own outgoing announcement.











## Record an outgoing announcement (OGA)

### To record your OGA:

1. Press .
2. Press  or  to select **ANS SYSTEM** and then press .
3. Press  or  to select **ANNOUNCEMENT** and then press .
4. Press  or  to select **RECORD OGA** and then press .
5. After a beep sounds, speak into the handset as you would normally during a call while recording your OGA (2 minutes maximum).
6. Press  when finished. The system will then play back the recorded message.

## Delete your recorded OGA

If you want to use the pre-recorded outgoing announcement, simply delete your recorded OGA.









1. Press .
2. Press  or  to select **ANS SYSTEM** and then press .
3. Press  or  to select **ANNOUNCEMENT** and then press .
4. Press  or  to select **DELETE** and then press .

# Answering system

## Play the current outgoing announcement











The following steps allow you to listen to the current outgoing announcement. The answering system plays the pre-recorded outgoing message if you have not recorded your own.

### To listen to the current outgoing announcement:

1. Press .
2. Press  or  to select **ANS SYSTEM** and then press .
3. Press  or  to select **ANNOUNCEMENT** and then press .
4. Press  again to select **PLAY OGA**. The system announces the current outgoing announcement you are using.

## Number of rings before the system answers

You can select the number of rings before the answering system answers a call.

1. Press .
2. Press  or  to select **ANS SYSTEM** and then press .
3. Press  or  to select **SETTINGS** and then press .
4. Press  to select **RING DELAY**.
5. Press  or  to select the desired setting and then press  to confirm.











**NOTE:** If you select **TOLL SAVER**, the system answers after the second ring if there are new messages, or after the fourth ring if there is no new message. This allows you to check your system to see if there are new messages before incurring toll charges.

# Answering system















## Security code for remote access

Your answering system allows you to program a 4-digit security code to get access to the system through any touch-tone telephone. The default security code is 0000.

### To view the current remote code:

1. Press .
2. Press  or  to select **ANS SYSTEM** and then press .
3. Press  or  to select **SETTINGS** and then press .
4. Press  or  to select **REMOTE CODE** and then press .
5. Press  again to select **VIEW CODE**. The screen displays the current remote code.



### To change the remote code:

1. Press .
2. Press  or  to select **ANS. SYSTEM** and then press .
3. Press  or  to select **SETTINGS** and then press .
4. Press  or  to select **REMOTE CODE** and then press .
5. Press  or  to select **CHANGE CODE** and then press .
6. Use the dial key pad to enter a new 4-digit security code and then press .
7. Enter the code again to confirm and then press .



## Call screening

When the answering system answers a call, you can listen at the telephone base while the caller leaves a message.

### At the telephone base:



The message automatically plays on the telephone base. Use the   button to adjust speaker volume.

### From a cordless handset:





1. Press the  button. The caller's voice will be heard while the answering system is recording the message.
2. To intercept during handset screening, press  button on the handset. The answering system will automatically stop recording when you do so.

# Answering system

## Message playback using the telephone base

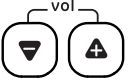

1. Press  on the telephone base to listen to the messages.
2. The system announces the number of messages and date and time when the message was recorded.
3. Press  again to stop the playback.

## Options during playback

Key	Operation
	Press to adjust the listening volume.
	Press to playback or stop messages.
	Press to repeat a message. Press twice to play the previous message.
	Press to skip to the next message.
<b>del</b>	Press during playback to delete the current message. Press and hold in idle mode to delete all old messages.

## Message playback using the handset

To listen to messages on a handset:

1. Press  twice or **flash** when the handset is in idle mode. Your messages will automatically be played back through the handset speakerphone. Press  to listen to your messages privately through the handset.
2. The following message options are available during playback:
  - **REPEAT**: Press 1 to repeat the currently playing message.
  - **STOP**: Press 2 to pause the message currently playing, press 2 again to resume playing.
  - **SKIP**: Press 3 to listen to the next message.
  - **DEL**: Press **del/int** to delete the currently playing message.







# Answering system

## Delete all messages

### Using the telephone base

Press and hold the **del** key. The system announces “All old messages erased.”

### Using a handset

1. Press .
2. Press  or  to select **ANS SYSTEM** and then press .
3. Press  or  to select **DEL. ALL OLD.**
4. Press  twice to confirm.

## Message window

The table below summarizes the messages displayed on the telephone base display.

--	When the answering system is turned off.
<b>00</b> (ON steadily)	There are no messages in the answering system.
<b>1-59</b> (flashing)	Total number of new messages. Current message number during message playback.
<b>1-59</b> (On steadily)	Total number of old messages.
<b>F</b> (flashing)	Memory is full.
<b>CL</b> (flashing)	Time is not set and there are old messages.
<b>LA</b> (flashing)	The telephone is being accessed remotely.
<b>LA/1-59</b> (alternating)	The telephone is being accessed remotely and the alternating number indicates the total number of messages.
<b>L0-L5</b> (On steadily)	Telephone base volume level when adjusting.

# Answering system

## Access the answering system remotely

1. Dial your phone number from any touch-tone telephone.
2. Once your answering system takes your call and you hear your outgoing announcement, press the **#** key. The answering system will ask you to enter your security code.
3. Enter your security code using the numeric keypad on the touch-tone telephone. The system will start playing messages after you hear a confirmation tone.

### NOTES:

1. If your answering system is off, you will not hear your outgoing announcement. The system will answer your call after 10 rings and then ask you to enter your security code.
2. If you have entered an incorrect security code, the system will ask you to enter the code again.
3. If you have forgotten the security code, you will need to reset the system (refer to page 43). The security code will be restored to its default setting as 0000 after system reset.

## Remote access commands









Touch-tone keys	Remote command
1	Replay the current or previous message.
2	Play/stop messages.
3	Skip to the next message.
4	Turn the answering system on or off.
7	Listen to the main menu.
0	Delete the current message.

A convenient wallet card, with instructions needed to operate your answering system remotely, can be found on page 61.

# Advanced settings

## Reset

This feature allows you to restore all system settings, except the answering system messages and phonebook, to default settings. This feature could be useful, for example, if you have forgotten the security code to access the answering system remotely.

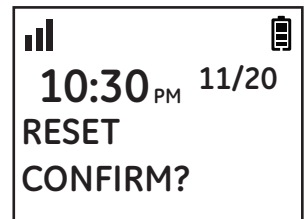
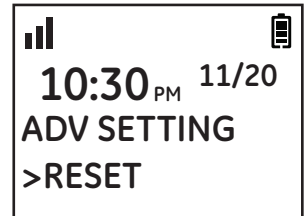

1. Press .
2. Press  or  to select **ADV SETTING** and then press .
3. Press  or  to select **RESET** and then press .
4. Press  again to confirm.



**NOTE:** All settings under the **ANS SYSTEM, BLOCK LIST, PROGRAM DND, CLOCK & ALARM, SETTINGS, HANDSET TONES, BASE TONES and ADV SETTING** menus in the handset will be restored to default settings, the redial list and call log will also be cleared.

## Registering a handset

The telephone system can support up to a total of 5 cordless handsets. Handsets that were included with your main base are pre-registered. To add or re-register a handset:

1. Press  when the handset screen shows **REGISTER YOUR HANDSET**.
2. The handset will show **PRESS LOCATOR KEY FOR 5 SEC.**
3. Press and hold the  button on the telephone base for 5 seconds.

A beep sounds on the handset when the registration is successful.

### NOTES:











1. An error tone will sound if the registration is not successful.
2. This product is compatible with model 30520 accessory handsets only. For information on how to purchase accessory handsets, please visit our website at [www.gephones.com](http://www.gephones.com)

# Advanced settings

## Deregistering a handset

This feature is intended for base replacement procedures. Handset deregistration is not recommended for normally functioning systems. For more information concerning deregistration, visit us online at

[www.gephones.com](http://www.gephones.com)

1. Press .
2. Press  or  to select **ADV SETTING** and then press .
3. Press  or  to select **DEREGISTER** and then press .
4. Press  or  to select the desired handset and then press  to confirm.

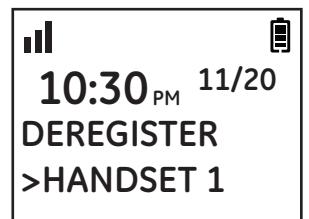
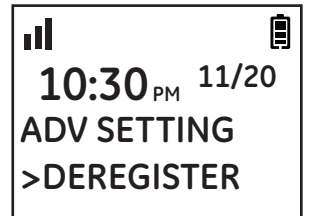



# Appendix

## Troubleshooting guide

If your telephone system is not operating properly, first try this general reset procedures:

1. Unplug all power adapters from the power outlets.
2. Disconnect the telephone line cord from the base or modular jack.
3. Remove the battery compartment covers and unplug all handset battery packs.
4. After a few minutes, re-install all handset battery packs, making sure that the connectors are snug and the wires are not pinched before replacing all battery compartment covers.
5. Plug the power adapters for the base and any chargers back into their power outlets. Be sure not to use outlets that are controlled by wall switches or timers.
6. Place all handsets in the telephone base or chargers to charge without interruption for at least 30 minutes before use.
7. Plug the line cord into the telephone base or modular jack and verify operation.

For product assistance or for more information about accessories, visit our website at [www.gephones.com](http://www.gephones.com) or call our customer service center at **1-877-394-9775**.

### General Performance

Problem	Cause/solution
Cannot hear a dial tone.	<ul style="list-style-type: none"><li>• Increase the volume on the handset.</li><li>• Disconnect the telephone line cord from the base unit and connect it to a known working telephone. If the known working telephone operates properly, contact our customer support center for warranty information.</li></ul>

# Appendix

Handset does not ring.	<ul style="list-style-type: none"><li>• The ringer may be off. Increase the ringer volume.</li><li>• Make sure your handset is charged.</li></ul>
You experience audible static, noise, or fading in and out.	<ul style="list-style-type: none"><li>• The handset may be near the end of range limit. Move the handset closer to the base unit.</li><li>• If you are using a line with DSL service, make sure you have properly installed the DSL filters supplied by your service provider.</li><li>• Try to relocate the base unit and use the handset away from sources of electrical interference.</li></ul>

## Caller ID

Problem	Cause/solution
Caller-ID information is not displayed.	<ul style="list-style-type: none"><li>• You must subscribe to Caller ID service from your telephone service provider.</li><li>• Make sure the base unit is plugged directly into a telephone modular jack. If you are using a line with DSL service, make sure you have properly installed the DSL filters supplied by your service provider.</li></ul>
While on a call, new caller-ID information is not displayed.	<ul style="list-style-type: none"><li>• You must subscribe to Caller ID with Call Waiting service from your telephone service provider.</li></ul>

# Appendix

## Answering system

Problem	Cause/solution
The unit does not record new messages.	<ul style="list-style-type: none"><li>• Make sure the answering system is on.</li><li>• The message memory may be full. Some messages will need to be deleted.</li></ul>
Cannot access the answering system locally through a system handset.	<ul style="list-style-type: none"><li>• The system may be in use by another party.</li><li>• The system is busy recording a message.</li></ul>
Cannot operate the answering system remotely.	<ul style="list-style-type: none"><li>• You must use a touch-tone telephone for remote access.</li><li>• Make sure you follow the remote access procedures in this user's guide.</li></ul>

## General Product Care

- Avoid dropping the handset, as well as other rough treatment to the phone.
- Clean the phone only with a dry soft cloth.
- Never use cleaning agents, paint thinner, abrasive powder, alcohol, or other chemical products to clean the unit. Doing so will damage the unit.
- Retain the original packaging in case you need to ship the phone at a later date.

# Appendix

## Important Safety Instructions

Some of the following information may not apply to your particular product; however, when using telephone equipment, basic safety precautions should always be followed to reduce the risk of fire, electric shock and injury to persons, including the following:

1. Read and understand all instructions.
2. Follow all warnings and instructions marked on the product.
3. Unplug this product from the wall outlet before cleaning. Do not use liquid cleaners or aerosol cleaners. Use a damp cloth for cleaning.
4. Telephones should not be used while you are in a bathtub, shower or pool. Immersion of the telephone or handset in water could cause an electrical shock.
5. Slots and openings in the cabinet back or bottom are provided for ventilation, to protect it from overheating. Do not block or cover these openings. Do not block the openings by placing the product on a bed, sofa, rug, or other similar surface. Do not place this product in a built-in installation unless proper ventilation is provided.
6. Only operate this product from the type of power source indicated on the marking label. If you are not sure of the type of power supply to your home, consult your dealer or local power company.
7. Plug the adapter into an easily accessible electrical outlet near the equipment.
8. Do not allow anything to rest on the power cord. Do not locate this product where the cord will be abused by persons walking on it.
9. Do not overload wall outlets and extension cords as this can result in the risk of fire or electric shock.
10. Never push objects of any kind into this product through cabinet slots as they may touch dangerous voltage points or short out parts that could result in a risk of fire or electric shock.
11. Never spill liquid of any kind on the product.
12. To reduce the risk of electric shock, do not disassemble this product. Opening or removing covers may expose you to dangerous voltages or other risks. Incorrect reassembly can cause electric shock when the appliance is subsequently used.

# Appendix

13. Do not expose the product to extreme temperatures such as areas near a hot radiator, stove or in a hot car. Do not place product upon other consumer electronic products such as; computer monitors, power amplifiers, etc.
14. Do not place lighted candles, cigarettes, cigars, etc., on or near the telephone.
15. Never touch uninsulated telephone wires or terminals unless the telephone line has been disconnected at the network interface.
16. Never install or modify telephone wiring during a lightning storm.
17. Never install jacks or telephones in wet locations.
18. Use caution when installing or modifying telephone lines to prevent electrical shock and/or fire.
19. Under the following conditions, unplug this product from the wall outlet and refer servicing to qualified service personnel:
  - A. The power supply cord or plug is damaged or frayed.
  - B. The product has been exposed to rain or water.
  - C. The product does not operate normally by following the operating instructions.
  - D. The product's cabinet has been damaged.
  - E. The product exhibits a distinct change in performance.
20. Avoid using a telephone during an electrical-storm. There may be a remote risk of electric shock from lightning.
21. Do not use the telephone to report a gas leak in the vicinity of the leak.
22. Do not place this product on an unstable cart, stand, or table. The product may fall, causing serious damage to the product.
23. Only use attachments/accessories specified by the manufacturer.
24. Unplug this apparatus during lightning storms or when unused for long periods of time.

## **IF YOUR PRODUCT UTILIZES BATTERIES, THE FOLLOWING ADDITIONAL PRECAUTIONS SHOULD BE OBSERVED:**

1. Use only the type and size battery(ies) specified in the user's manual.
2. Do not use this product if the battery door is removed or missing.
3. Replace batteries that appear to be swollen or have damaged wiring.

# Appendix

4. Do not dispose of the battery(ies) in fire. They may explode. Check with local codes for possible special disposal instructions.
5. Do not open or mutilate the battery(ies). Released electrolyte is corrosive and may cause damage to the eyes or skin. It may be toxic if swallowed.
6. Exercise care in handling battery(ies) in order not to short out the battery(ies) with conducting materials such as rings, bracelets, and keys. The battery(ies) or conductor may overheat and cause burns.
7. Do not attempt to recharge the battery(ies) provided with or identified for use with this product that are not rechargeable. The battery(ies) may leak corrosive electrolyte or explode.
8. Do not attempt to rejuvenate the battery(ies) provided with or identified for use with this product by heating them. Sudden release of the battery(ies) electrolyte may occur causing burns or irritation to eyes or skin.
9. When replacing battery(ies), all batteries should be replaced at the same time. Mixing fresh and discharged batteries could increase internal cell pressure and rupture the discharged battery(ies). (Applies to products employing more than one separately replaceable primary battery.)
10. When inserting battery(ies) into this product, the proper polarity or direction must be observed. Reverse insertion of battery(ies) may result in leakage or explosion.
11. When inserting battery(ies) into this product, do not twist or pinch the wires or allow wires to become pinched in battery door.
12. If storing over 30 days, remove battery(ies) from this product because the battery(ies) could leak and damage the product.
13. Discard "dead" battery(ies) as soon as possible since "dead" batteries are more likely to leak in a product.
14. Do not store this product, or the battery(ies) provided with or identified for use with this product, in high-temperature areas. Batteries that are stored in a freezer or refrigerator for the purpose of extending shelf life should be protected from condensation during storage and defrosting. Batteries should be stabilized at room temperature prior to use after cold storage.
15. If your product uses rechargeable battery(ies), charge the battery(ies) only in accordance with the instructions and limitation specified in the user's guide.

# Appendix

## 16. Battery safety precautions

- Do not burn, disassemble, mutilate, or puncture. Like other batteries of this type, toxic materials could be released which might cause injury to persons or property damage.
- To reduce the risk of fire or personal injury, use only the supplied battery or replacement battery.
- Keep batteries out of the reach of children.
- Remove batteries if storing over 30 days.

Use only the supplied rechargeable battery or replacement battery. Visit our website at [www.gephones.com](http://www.gephones.com) to order a replacement battery if necessary.

**SAVE THESE INSTRUCTIONS**



# Appendix

## FCC Parts 15, 68 and ACTA

This equipment is in compliance with parts 15 and 68, FCC Rules and Regulations and the Technical Requirements for Telephone Terminal Equipment published by ACTA.

On the bottom of this equipment is a label indicating, among other information, the US number and Ringer Equivalence Number (REN) for the equipment. You must, upon request, provide this information to your telephone company.

The REN is useful in determining the number of devices you may connect to your telephone line and still have all of these devices ring when your telephone number is called. In most (but not all) areas, the sum of the RENs of all devices connected to one line should not exceed 5.

A plug and jack used to connect this equipment to the premises wiring and telephone network must comply with the applicable FCC Part 68 rules and requirements adopted by the ACTA. A compliant telephone cord and modular plug is provided with this product. It is designed to be connected to a compatible modular jack that is also compliant. See installation instructions for details.

This equipment is not intended to be used with Party Lines. If your home has specially wired alarm equipment connected to the telephone line, ensure the installation of this product does not disable your alarm equipment. If you have questions about what will disable alarm equipment, consult your telephone company or a qualified installer.

If this equipment is malfunctioning, it should be unplugged from the modular jack until the problem is corrected. Repairs to this equipment can only be made by the manufacturer or its authorized agents. For information on repair procedures, follow the instructions provided with the limited warranty. Should your equipment cause trouble on your line which may harm the telephone network, the telephone company shall, where practicable, notify you that temporary discontinuance of service may be required. Where prior notice is not practical and the circumstances warrant such action, the telephone company may temporarily discontinue service immediately. In case of such temporary discontinuance, the telephone company must: (1) promptly notify you of such temporary discontinuance; (2) afford you the opportunity to correct the situation; and (3) inform you of your right to bring a complaint to the Commission pursuant to procedures set forth in Subpart E of Part 68, FCC Rules and Regulations.

The telephone company may make changes in its communications facilities,



# Appendix

equipment, operations or procedures where such action is required in the operation of its business and not inconsistent with FCC Rules and Regulations. If these changes are expected to affect the use or performance of your telephone equipment, the telephone company must give you adequate notice, in writing, to allow you to maintain uninterrupted service. This device complies with Part 15 of the FCC Rules. Operation is subject to the following two conditions: (1) This device may not cause harmful interference; and (2) This device must accept any interference received, including interference that may cause undesired operation. This equipment has been tested and found to comply with the limits for a Class B digital device, pursuant to Part 15 of the FCC Rules. These limits are designed to provide reasonable protection against harmful interference in a residential installation.

This equipment generates, uses, and can radiate radio frequency energy and, if not installed and used in accordance with the instructions, may cause harmful interference to radio communications. However, there is no guarantee that interference will not occur in a particular installation.

Privacy of Communications may not be ensured when using this product.

If this equipment does cause harmful interference to radio or television reception, which can be determined by turning the equipment off and on, the user is encouraged to try to correct the interference by one or more of the following measures:

- Reorient or relocate the receiving antenna (that is, the antenna for radio or television that is “receiving” the interference).
- Reorient or relocate and increase the separation between the telecommunications equipment and receiving antenna.
- Connect the telecommunications equipment into an outlet on a circuit different from that to which the receiving antenna is connected.

If these measures do not eliminate the interference, please consult an experienced radio/television technician for additional suggestions. **The changes or modifications not expressly approved by the party responsible for compliance could void the user’s authority to operate the equipment.**

## Hearing Aid Compatibility (HAC)

This equipment meets FCC standards for Hearing Aid Compatibility

If this product has a memory dialing feature, you may choose to store emergency phone numbers such as police, fire or medical within the memory locations. If you do store or emergency numbers, we suggest you also write

# Appendix

these numbers down so that you can still dial the number manually if the memory dialing fails.



This feature is included as a convenience only. The manufacturer assumes no responsibility for customer reliance on the memory feature of this product.

**Testing emergency telephone numbers is not recommended.** However, if you choose to make a test call to an emergency number, you should:

- Remain on the line and provide an explanation for the call before you hang up.
- Only make a non emergency test call during off-peak hours during early mornings or late evenings.

To ensure user safety, the FCC has established criteria for the amount of radio frequency energy that can be safely absorbed by a user or bystander according to the intended usage of the equipment. This equipment has been tested and found to comply with the FCC criteria. The handset may be safely held against the ear of the user. The telephone base should be installed and used such that parts of the users body other than the handset are maintained at a distance of approximately 8 inches (20 cm) or more.

**WARNING: TO PREVENT FIRE OR ELECTRICAL SHOCK HAZARD, DO NOT EXPOSE THIS PRODUCT TO RAIN OR MOISTURE.**

 <p>THE LIGHTNING FLASH AND ARROW HEAD WITHIN THE TRIANGLE IS A WARNING SIGN ALERTING YOU OF "DANGEROUS VOLTAGE" INSIDE THE PRODUCT.</p>	<p><b>CAUTION</b> RISK OF ELECTRICAL SHOCK, DO NOT OPEN</p> <p>CAUTION: TO REDUCE THE RISK OF ELECTRICAL SHOCK, DO NOT REMOVE COVER (OR BACK). NO USER SERVICEABLE PARTS INSIDE. REFER SERVICING TO QUALIFIED SERVICE PERSONNEL.</p>	 <p>THE EXCLAMATION POINT WITHIN THE TRIANGLE IS A WARNING SIGN ALERTING YOU OF IMPORTANT INSTRUCTIONS ACCOMPANYING THE PRODUCT.</p>
---	--	---

# Appendix



This product meets ENERGY STAR program requirements for energy conservation. Selecting ENERGY STAR products is a responsible way to save energy and money while protecting our environment. ENERGY STAR is a U.S. registered mark.



The RBRC seal on the battery used in your product indicates that CCT is participating in the Rechargeable Battery Recycling Corporation (RBRC) program to collect and recycle rechargeable batteries. We encourage you to explore the easy recycling options available to you in your area. For more information visit [www.rbrc.org](http://www.rbrc.org) or call 1-800-8-BATTERY or contact your local recycling center.

In accordance with California Proposition 65, CCT advises that nickel is a chemical known to the State of California to cause cancer.



This product has reduced magnetic noise interference with most T-coil equipped hearing aids and cochlear implants. The TIA-1083 Compliant Logo is a trademark of the Telecommunications Industry Association. Used under license.

# Appendix

## One Year Limited Warranty

CCT Tech USA Inc. (CCT), the licensed manufacturer of this GE® branded product, warrants this product to the original retail purchaser to be free of material and/or workmanship defects for a period of one year after the date of original retail purchase. Proof of the original purchase is required to obtain a remedy under this limited warranty and the product must be returned to CCT at your expense.

During the limited warranty period, CCT or its authorized service representative will repair or replace at CCT's option, without charge, a materially defective product. We may use new or refurbished replacement parts. If we replace the product, it may be with a new or refurbished product of same or similar design. CCT may keep any removed or defective parts, and/or replaced product. The repaired or replaced product is warranted for the remainder of the original warranty or 90 days, whichever is greater. Repair or replacement of this product at CCT's option is your exclusive remedy.

This limited warranty only applies to products purchased, used and serviced in the United States and its territories, or Puerto Rico. If you purchased this product outside of the United States, its territories or Puerto Rico, contact your dealer for service information.

This is the only warranty applicable to this product. **ALL OTHER WARRANTIES EXPRESS OR IMPLIED INCLUDING ALL IMPLIED WARRANTIES OF MERCHANTABILITY OF FITNESS FOR A PARTICULAR PURPOSE ARE HEREBY DISCLAIMED. CCT IS NOT LIABLE FOR ANY INDIRECT, INCIDENTAL, CONSEQUENTIAL OR SIMILAR DAMAGES INCLUDING, BUT NOT LIMITED TO, LOST PROFITS OR REVENUE, INABILITY TO USE THE PRODUCT, OR ANY OTHER ASSOCIATED EQUIPMENT, THE COST OF SUBSTITUTE EQUIPMENT, AND ANY CLAIMS BY THIRD PARTIES RESULTING FROM THE USE OF THIS PRODUCT.**

This warranty gives you specific legal rights, and you may have other rights that vary from state to state. Some states do not allow the exclusion or limitation of incidental or consequential damages, so the limitations or exclusions stated above may not apply.

### What Is NOT Covered Under This Limited Warranty

- Normal wear and tear or cosmetic damage.
- Damage due to accidents, misuse, physical force, improper installation or operation, mishandling, neglect, fire, heat, water, humidity, liquids, insect infestation, or other intrusion.

# Appendix

- Products that have been repaired, altered or modified by anyone other than CCT or its authorized service representative.
- Problems caused by signal conditions, radio interference, network reliability, cable or antenna systems.
- Damage caused by use of non CCT accessories or misapplication.
- Products whose serial numbers have been removed, altered or rendered illegible.
- Products purchased, shipped from, used or serviced outside the United States.
- Batteries.
- Products used for business, commercial or institutional purposes.
- Damage caused by acts of nature such as, but not limited to, lightning damage.
- Products returned without valid proof of purchase.

## How To Obtain Warranty Service

Call our customer service center at **1-877-394-9775**. Our customer service specialist will assist you in obtaining warranty service. Please have a paper and pencil handy to write down the warranty service return instructions.

**-OR-**

You may visit our web site at **[www.gephones.com](http://www.gephones.com)** for troubleshooting, FAQs, and information on warranty service.

## Accessibility

If you have a disability or questions about how CCT's products can accommodate persons with disabilities, please call our customer service center at **1-877-394-9775**. When calling, please let our specialists know that you have an inquiry about accessibility so your call is routed properly.

# Appendix

## Technical specification

<b>Radio frequency band</b>	DECT 6.0 (1910MHz to 1920MHz)
<b>Telephone base input voltage and current</b>	6VDC 500mA
<b>Charger input voltage and current</b>	6VAC 300mA
<b>Battery specifications</b>	2.4V 400mAh

# Appendix

## Index

### A

---

Alarm 28  
Alarm tone 29  
Answer a call 14  
Answering system  
    turn on or off 36  
Area code 13

### B

---

Base ringer melody 23  
Base ringer volume 23  
Battery charging 11  
Battery installation 4

### C

---

Caller ID 34  
    delete an entry 35  
    display screen messages 35  
    review/call 34  
    save to phonebook 35  
Call waiting 16  
Chain dial 32  
Chain dialing 32  
Character table 31  
Charger installation 3

### D

---

Date and time 27  
Date format 28  
Delete all messages 41  
Dialing mode 13

### E

---

End a call 14  
Energy save 22  
Equalizer 22

### F

---

FCC 52

### H

---

Handset deregistration 44  
Handset layout 10  
Handset locator 16  
Handset registration 43

### I

---

Important safety instructions 48  
Initiate an intercom during a call 18  
Intercom 17

### K

---

Key tone 21

### L

---

Language 21

### M

---

Make a call 14  
Message capacity 36  
Message playback  
    handset 40  
    telephone base 40  
Message window 41  
Multiple handsets 16  
Mute 15

### O

---

Outgoing announcement 37  
    delete 37  
    play 38  
    record 37

# Appendix

## P

---

- Parts checklist 1
- Phonebook
  - add an entry 30
  - delete all entries 33
  - delete an entry 33
  - edit an entry 33
  - search entry 32
  - view/call an entry 32
- Phonebook Caller-ID matching 34
- Redial a call 14
- Push to talk 19

## R

---

- Redial
  - delete 15
  - make a call 15
  - save to phonebook 15
- Remote access commands 42
- Remote access operation 42
- Ring delay 38
- Ringer melody 20
- Ringer volume 20

## S

---

- Screen display icon 12
- Speakerphone 14

## T

---

- Technical specification 58
- Telephone base installation 2
- Telephone base layout 9
- Telephone base volume 36
- Time format 27
- To answer an incoming call during intercom 17
- Troubleshooting guide 45

## V

---

- Voice mail 16
- Volume control 14

## W

---

- Warranty 56



# Appendix

## Remote access operation card

The remote access card below lists the commands needed to operate your answering system remotely from any touch-tone telephone.

Cut along dotted line



### Remote access operation card

1. Call your telephone number from a touch-tone telephone.
2. Press **#** when you hear your outgoing announcement.
3. Enter your security code (default is 0000).

Security code:

<input type="text"/>	<input type="text"/>	<input type="text"/>	<input type="text"/>
----------------------	----------------------	----------------------	----------------------

4. After the beep, the system will start playing messages.

NOTE: For more details about remote access operation, refer to page 42 of the user's guide.

Fold here

### Remote access commands

Touch-tone keys	Remote command
1	Replay the current or previous message.
2	Play/stop messages.
3	Skip to the next message.
4	Turn the answering system on or off.
7	Listen to the main menu.
0	Delete the current message.

visit our website:

**[www.gephones.com](http://www.gephones.com)**



is a trademark of General Electric Company and is under license by CCT Tech USA Inc., Irving, TX 75039

Model 30522  
P/N: 480-98790-000002  
Version 1 02/2011  
Printed in China

©2011 CCT Tech USA Inc.  
Distributed in the U.S.A. by CCT  
Tech USA Inc.