

DECT 6.0 SKYPE CORDLESS TELEPHONE

Model number:
31591



Thank you for choosing GE!

Please take a moment to register your product online. Just go to www.gephones.com and click "register here" from the home page. Provide your email address and receive product updates, special offers, or discounts on future purchases.

* It will not diminish your warranty rights if you choose not to register.

Assistance and more information

Retain your sales receipt as proof of purchase in the event warranty service is necessary.

For product assistance or for more information about accessories, visit our website at www.gephones.com. You can also call our customer service center at **1-877-394-9775 (USA)** or **1-877-395-7907 (Canada)**.



Attach your sales receipt here.

Table of contents

Parts checklist

What's in the box.....1

Before you begin

About your phone.....2
Internet connection.....2
Landline connection.....2
AC power connection.....3
Skype account.....3

Installation

Installing the telephone base.....4
Installing the handset battery.....6
Installing the handset charger.....7

Initial setup

Telephone base layout.....8
Handset layout.....9
Handset screen display icons.....10
Battery charging.....11

About Skype

Setting up for the first time.....12
Setting the language and country.....12
PSTN vs Skype calls.....12
Emergency calls.....12
Skype Credit.....13
Online Number.....13
Skype features supported.....13
VMWI vs Skype Voicemail.....13
Skype display icons.....13
SkypeOut calls.....14

Skype setup and use

Creating a new Skype account.....15
Signing into Skype.....16
Skype ID.....17
Changing your online status.....18
Skype Profile.....18
Viewing and editing your public profile.....18
Viewing and editing your private profile.....18
Changing your password.....19
Signing out of Skype.....19
Viewing your account status.....20

Entering characters

Entering text and numbers.....21
Switching input modes.....21
Entering symbols.....21
Character table for Skype.....22
Character table for the phone.....22

Handset settings

Scrolling the handset.....24
Setting the ringtone.....24
Setting the ring volume.....24
Setting the keypad tone.....24
Setting confirmations.....25
Setting the time.....25
Setting the time format.....25
Setting the date.....26
Setting the date format.....26
Setting the date separator.....26
Assigning a preferred line.....27
Changing the landline country setting.....27
Emergency calls.....27
Changing the handset display language.....28
Registering additional handsets.....28
Setting the handset backlight.....28
Setting the screen saver.....29
Finding a handset.....29
Naming your handset.....29

Telephone operation

Making a regular call.....30
Pre-dialing a regular call.....30
Pre-dialing a Skype call.....30
Pre-dialing a SkypeOut call.....30
Inserting a country prefix "+".....30
Making a Skype call from contacts.....31
Answering a call.....31
Missed calls.....31
Placing a call on hold.....32
Ending a call.....32
Muting the microphone.....32
Speakerphone.....32
Volume control.....32
Resetting the phone.....33
Call waiting or call waiting with caller

ID service	33
Voice message waiting indicator	34
Intercom	34
Answering an incoming call during an intercom call	34
Making an intercom call during an external call	34
Transferring a call	35
3-way conference call	35
Forwarding a Skype call	36
Forward a Skype call to a landline number	36
Setting Skype Voicemail Greeting	37
Blocking Skype ID calls or SkypeIn calls	37
Viewing/unblocking the block user list	38
Area code management	38

Parts checklist

What's in the box

Your GE 31591 telephone system comes with the following components:

View call history	47
Accessing the call history	47
Call history options	47
Making a call from a call history list	48
Saving a call entry to your contact list	48
Deleting a call entry from a call history list	49
Deleting all the call entries from a call history list	49

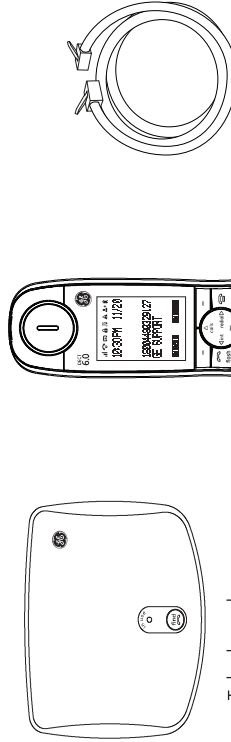

Telephone base

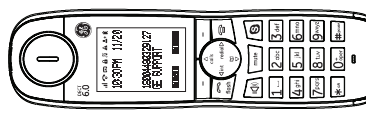

Cordless handset

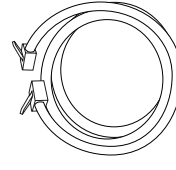

Ethernet cable

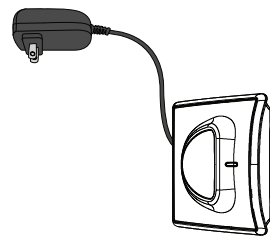

Charger with power adapter attached



Power adapter for telephone base

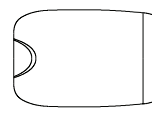

Battery compartment cover

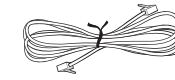

Telephone line cord



User's guide

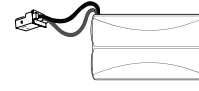

Battery

Contacts

Contacts	40
Contact display icons	40
Adding a Skype contact	41
Adding a SkypeOut or PSTN contact	42
Accessing the contact list	42
Viewing the contact list	42
Searching a contact	43
Phonebook	43
Saving a phonebook entry as SkypeOut contact	43
Sending a voicemail to your Skype ID contact	43
Renaming a contact	44
Removing a contact	44
Blocking a contact	44
Unblocking a contact	44
Saving a SkypeOut contact as a phonebook entry	45
Exchange contact details request	45
Viewing the details of the contact	45
Accepting a contact request	45
Declining a contact request	46
Blocking a contact request	46

Call history

Network settings	53
Viewing your network settings	53
DHCP	53
PPPoE	53
Configuring a static IP	54
Configuring individual network settings	54
Resetting the network	54

Software updates

Checking for software updates	55
Changing the auto update setting	55
Viewing your device information	55

Appendix

Handset Menu Tree	56
Troubleshooting guide	62
Frequently Asked Questions	66
General Product Care	70
Important Safety Instructions	70
FCC Parts 15, 68 and ACTA	74
One Year Limited Warranty	77
Technical specification	79
Index	80
Skype account information	83

Before you begin

About your phone

Your GE 31591 Skype cordless phone allows you to make and receive both land line and Skype calls. The Skype features of this product allow you to make Skype calls without using a computer.

Before you install your GE 31591 phone, you need to make sure that you have:

- Internet connection
- Landline connection
- AC power connections
- Skype account (you can also set up a new account through your GE 31591 system for Skype-to-skype calls).

Figure 1 shows the concept of using the GE31591 Skype phone.

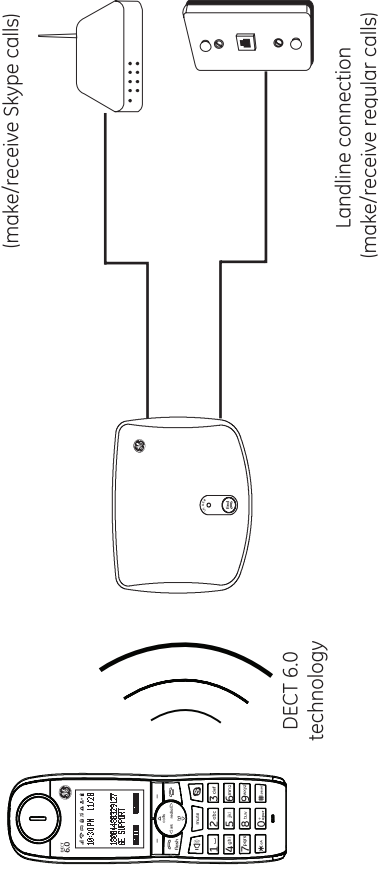

Figure 1

Internet connection

In order to use your phone for Skype calls, the telephone base must be connected with an ethernet cable to an active internet connection. If you have no available ethernet ports, you may need a router to allow you to attach more devices to your internet connection.

Landline connection

In order to use your phone for landline calls, the telephone base must be placed near a telephone jack.

Before you begin

You need a RJ11C type modular telephone jack, which might look like the one shown in Figure 2, installed in your home. If you do not have a modular jack, contact your telephone service provider to find out how to have one installed.

If you have DSL high speed internet service, a DSL filter is required (not included). Contact your DSL service provider for more information about DSL filter.

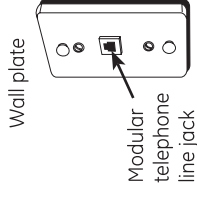

Figure 2

AC power connection

You will need access to electrical AC power outlets for the base and handset charger. The outlets should not be controlled by a wall switch, dimmer, or timer. The GE 31591 phone system will not function during a power failure/outage.

Skype account

To use Skype telephony via your phone you need a Skype account with a user name and password.

With Skype, you can call for free when talking to other Skype users with Skype account. You can buy Skype Credit to call non-Skype users on their phone numbers (both landline and mobile numbers).

For more information, refer to the *All about skype* section on page 13.

IMPORTANT: Skype does not allow emergency calls. Such calls are always routed to the landline connection. Therefore, you should not rely on Skype for emergency services. Alternative arrangements should be made.

Installation

Installing the telephone base

1. Connect one end of the Ethernet cable to the **Ethernet cable jack (WAN)** on the telephone base and the other end to a LAN (Local Area Network) port on your broadband connection (modem, router, hub, switch, etc).
2. Connect one end of the telephone line cord to the **Telephone line jack** on the telephone base and the other end to a telephone wall jack.
3. Connect the smaller end of the power adapter to the **Power adapter jack** on the telephone base and the other end to an active electrical outlet.

NOTE: Emergency calls via the landline are only possible when the telephone base is plugged into an electrical outlet receiving power and the landline is connected to a working telephone jack.

Figure 3 shows the back of the telephone base and the positions of the jacks.

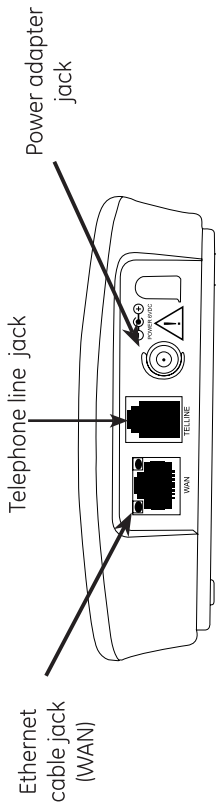

Figure 3

Note that there is a power cord catch at the back of the telephone base on the right side of the power adapter jack. This is used for threading the power cord that comes out of the power adapter jack. If necessary, you can also tie the excess cord with a twist tie.

Figure 4 shows the power cord threaded through the power cord catch.

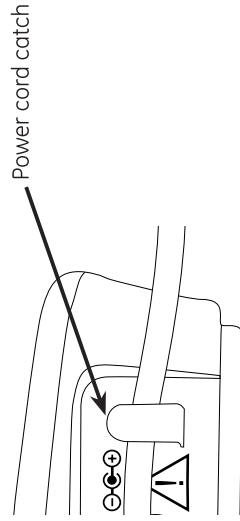

Figure 4

Installation

Figure 5 shows the completed installation.

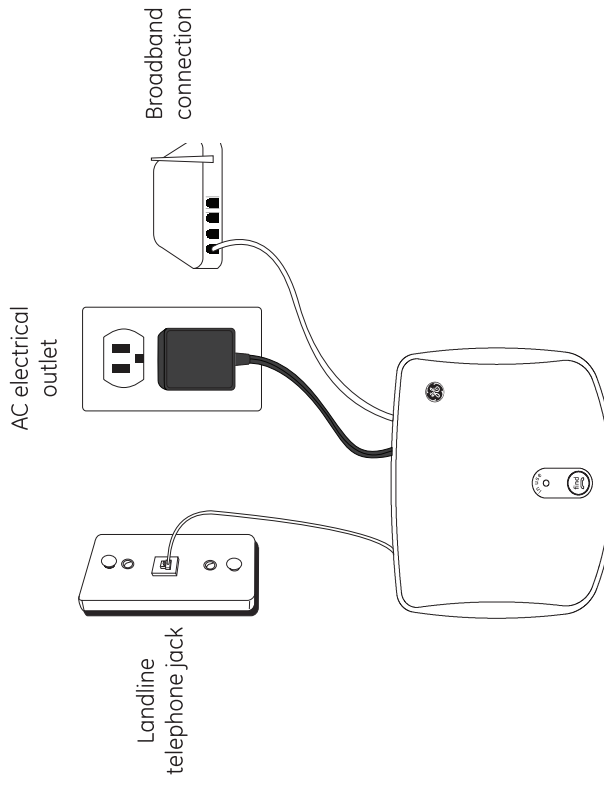

Figure 5

Attach the router to the Internet connection and connect your computer and the telephone base to the router. Please contact your ISP (Internet Service Provider) for questions regarding the use of the Internet and router. The troubleshooting section in this user guide also provides more information on Internet connection problems.

NOTE: When installing a new router you should be aware that it might take some time - up to one hour - before it is properly registered with your ISP.

Installation

Installing the handset battery

Please fully charge your handset before use!

For optimum performance, charge the battery for 16 hours before first use.

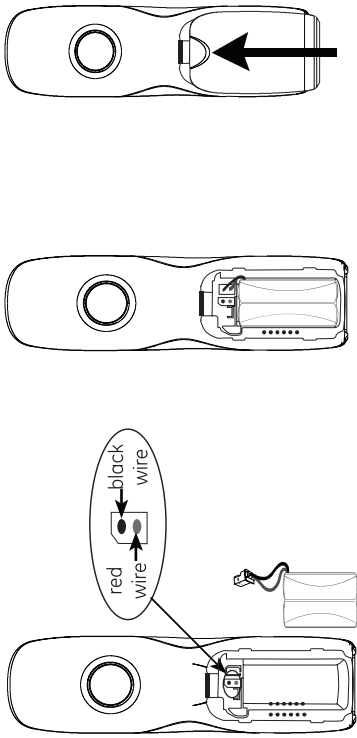

1. Plug the battery connector securely into the socket inside the handset battery compartment. Make sure that red and black wires on the plug are properly inserted into the socket as shown.
2. Place the battery and the wire inside the battery compartment.
3. Align the cover against the battery compartment and slide it upwards until it clicks into place.

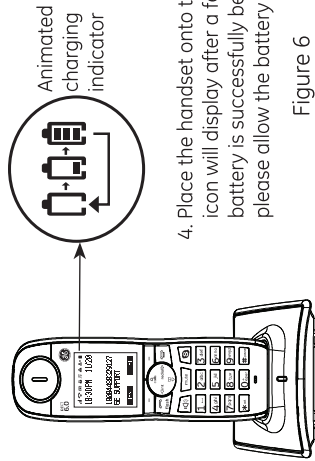

4. Place the handset onto the charger as shown. An animated battery icon will display after a few minutes to show that the handset battery is successfully being charged. For optimum performance, please allow the battery to charge for 16 hours before first use.

Figure 6

CAUTION:

1. Use only the supplied rechargeable battery or equivalent replacement battery. See battery specifications on the **Technical specification** page or visit our website at www.gephones.com to find out how to order a replacement battery if necessary.
2. If the handset will not be used for an extended period of time, unplug the battery and remove it from the handset to prevent possible leakage.

Installing the handset charger

To install the charger, simply plug the power adaptor into an electrical outlet not controlled by a wall switch, as shown in Figure 7.

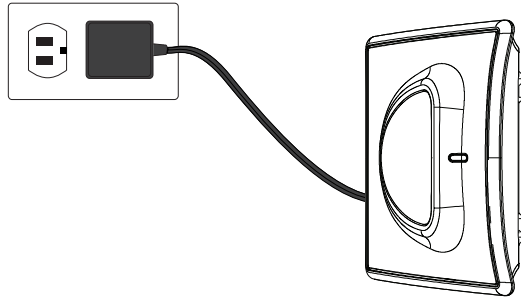

Figure 7

CAUTION:

1. Use only the power adaptor that came with this unit. Using other power adaptors may damage the unit.
2. To prevent fire or electrical shock hazard, do not expose this product to rain or moisture.

Initial setup Telephone base layout

In Use Indicator

- Flashes when paging a handset
- Flashes when there is a regular incoming call
- On steady during landline calls
- Off during Skype calls
- Lights up when starting up for the first time. After the telephone base is ready, the light goes off.

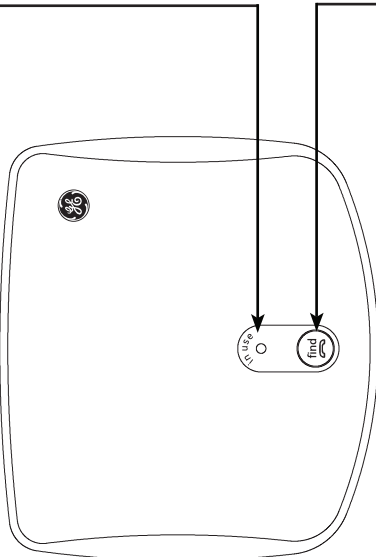

FIND button

- Press to page cordless handset(s).
- Press and hold to enter registration mode when adding GE 31590 accessory cordless handsets.

Initial setup Handset layout

The diagram shows a front view of the handset. The screen displays a call log with the following information: '10:30 PM 11/20', '1800-486-63127', and 'GE SUPPORT'. The keypad has various function keys labeled: 'flash', 'talk', 'intercom', 'mute', 'Skype', and '#/Pause'. The handset is annotated with callouts to various features and their functions.

calls Up/Calls

- Press to review the call log when the telephone is not in use.
- While in menu, press to scroll up.
- During a call, press to increase the volume.

Left Softkey

- Press to select the function displayed on the handset screen directly above it.

Talk/Flash

- Press to make and receive calls.
- During a call, press to answer a second incoming call if you receive a call waiting alert (available only if you have subscribed to the call waiting feature from your telephone service provider).

Int Left/Intercom

- While in menu, press to scroll left.
- Press to initiate an intercom call or transfer a call.

Speakerphone

- Press to make or answer a call using the speakerphone.

Mute

- Press to mute a the microphone. Press again to resume conversation.

//* */aA

- Press to input "/*/*" when in editing mode.
- Press to switch between lowercase, uppercase, and numeric input when entering text and numbers (e.g. handset naming).

Ringer/Voice Mail

Waiting Indicator LED

- Flashes during incoming landline call.
- Flashes to indicate new voice mail message has been received.

Right Softkey

- Press to select the function displayed on the handset screen directly above it.

End

- Press to end a call.
- During an operation, press to cancel and exit without making changes.

redial/ Right/Redial

- While in menu, press to scroll right.
- Press to review previously dialed numbers.

Skype

- Press to access the **Skype** status menu.
- Press to confirm selection during menu operation.







#/Pause

- Press to input "#" when in editing mode.
- If you need a pause between digits, press and hold this key until a **P** appears in the display. This inserts a 3-second pause in the dialing sequence.



Down/Contact List

- Press to review the contact list when the telephone is not in use.
- While in menu, press to scroll down.
- During a call, press to decrease the volume.

Initial setup Handset screen display icons

Item	Meaning
	<ul style="list-style-type: none"> Displays when the telephone base is within reception range.
	<ul style="list-style-type: none"> Displays when there is a missed call.
	<ul style="list-style-type: none"> Displays when there is a new voice mail message. This icon applies to both VMWI voicemail and Skype Voicemail™. Note that you have to subscribe to voice mail service from your telephone service provider.
	<ul style="list-style-type: none"> Displays when the ringer is off.
	<ul style="list-style-type: none"> Displays when there is a new event. These includes software update, missed call, Skype voicemail, VMWI (regular voicemail), and contact request.
	<ul style="list-style-type: none"> Displays when there is a new authorization request. This means someone wants to add you as a contact using Skype.
	<ul style="list-style-type: none"> Shows the status of the battery. For more information, please refer to the <i>Battery charging</i> section on page 11.

Initial setup Battery charging

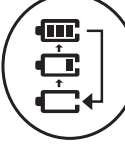
Battery indicators	Battery status	Action
<p>The screen shows "No battery".</p>	<p>The handset is inserted into the charger but there is no battery in the handset.</p>	<p>Insert the battery into the battery compartment of the handset and then put the handset in the charger. For more information on how to install the battery, refer to the <i>Installing the handset battery</i> section on page 6.</p>
<p>Battery icon is scrolling and the screen shows "Charging...".</p> 	<p>Battery has no power and you cannot turn on the handset. This usually happens when you install the battery into the handset for the first time.</p>	<p>Place the handset in the charger for at least 16 hours without interruption. See <i>Troubleshooting guide</i> section on page 64 for help if the screen remains blank after charging.</p>
<p>Battery icon is flashing and empty.</p> 	<p>Battery power is low but not yet empty. This happens after you have used the handset for some time.</p>	<p>Place the handset in the charger to charge without interruption for at least 30 minutes before use.</p>
<p>Battery icon is scrolling but the screen does not show any message.</p> 	<p>Battery is charging normally.</p>	<p>Keep the handset in the charger when not in use.</p>
<p>Battery icon is on steady.</p>	<p>Battery is fully charged.</p>	<p>The handset is ready for use. The talk time when the handset is fully charged is about 10 hours.</p>

About Skype

Setting up for the first time

Before you can use your GE 31591 phone for the first time, you must set the language and country.

The first screen you see after installing the handset battery and telephone base. It consists of three languages for your selection.

The second screen consists of two countries for your selection. The country setting configures the landline telephony port.

If your country setting is not configured correctly, emergency calls may not work properly.

Setting the language and country

1. Use calls/▽ to highlight your desired language (**English**, **Español**, or **Français**), and then press the **Select** softkey.
2. Use calls/▽ to highlight your desired country (**USA** or **Canada**), and then press the **Select** softkey.
3. The screen displays “**Connecting**” for a few seconds.
4. The screen displays “**Successful**”. Press the **OK** softkey.
5. The idle screen displaying the time appears as shown.

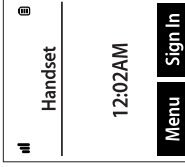
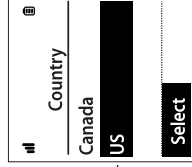
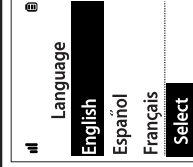

Emergency calls



IMPORTANT: Skype does not allow emergency calls. Such calls are always routed to the landline connections. Therefore, you should not rely on your GE 31591 phone for emergency services. Alternative arrangements should be made instead.

Please note also it is important that you set the correct landline country because it affects the emergency phone calls. Do not forget that your GE 31591 phone has to be connected to a power outlet in order to work. Your phone will not function during a power failure.

PSTN vs Skype calls

PSTN (public switched telephone network) is the network of the world's public circuit-switched telephone networks. It includes mobile as well as fixed landline telephones. In other words, it is the regular calls that we make.

Skype is a software application that allows users to make voice and video calls and chats over the internet. Calls to other users within the Skype service are free, while calls to both traditional landline telephones and mobile phones can be made for a fee using a debit-based user account system called Skype Credit.

About Skype Skype Credit

Skype credit is credit you buy from www.skype.com that allows you to make SkypeOut calls to landline and mobile phone numbers. You prepay the Skype credit and then each time you make a SkypeOut call, your Skype credit will be deducted accordingly. Please note, you can use Skype Credit on your GE 31591. However, you must purchase Skype credit online via a computer. You cannot purchase Skype Credit from your GE 31591 phone.

Online Number

SkypeIn allows landline and mobile phone users to call you using an Online Number. In order to use SkypeIn, you will need to pay for a number at www.skype.com. Every Online Number comes with Voicemail included.

Skype features supported

After you have created your Skype account, you can call other people with Skype accounts for free. Skype also offers additional subscription features, including:

SkypeOut	<ul style="list-style-type: none">• Allows you to make calls to ordinary landline and mobile phones.
SkypeIn	<ul style="list-style-type: none">• Provides you with an ordinary phone number for receiving Skype calls on your GE31591 phone from ordinary landline and mobile phones.
Skype Voicemail™	<ul style="list-style-type: none">• Skype Voicemail allows you to send and receive voicemail messages and record a greeting.

VMWI vs Skype Voicemail

VMWI (Visual Message Waiting Indicator) is a telephone calling feature that illuminates an LED on select telephones to notify a telephone user of waiting voicemail messages on most North American public telephone networks and PBXs. In other words, it is the voicemail system for PSTN calls.

Skype Voicemail allows callers to leave voicemail messages for Skype users who are unavailable. It is a feature provided by Skype and Skype charges a fee for the service. Skype voicemail is thus the voicemail system for Skype calls.

Skype display icons

The following table describes the 4 Skype status icons that can display on the handset screen after you have successfully signed in to your Skype account.

About Skype

Item	Skype Status
	Online
	Offline
	Away
	Do Not Disturb

SkypeOut calls

SkypeOut allows Skype users to call traditional phone numbers, including mobile phones, for a fee. You need to purchase Skype Credit in advance and then debit the Skype Credit when you make a SkypeOut call. Your phone displays the amount of Skype Credit available when in idle mode.

For more information on Skype Credit, visit <http://www.skype.com/intl/en-us/prices/skype-credit/>.

Skype setup and use

Creating a new Skype account

If you do not have a Skype account, you need to create one before you can sign in to Skype. You can create a new Skype account using your computer, or you can do so on your GE 31591 phone.

Skype name can be 6-32 characters. You can use any mix of upper- and lower-case characters, numbers and punctuation marks. You cannot use spaces and your name cannot begin with a number or punctuation mark. If the name is already in use, you will be prompted to try another name.

Passwords can be 6-20 characters. You can use any mix of upper- and lower-case characters, numbers and punctuation marks. You cannot use spaces, your password cannot begin with a number or punctuation mark, and you cannot use your Skype name as a password.

For more information on entering Skype name and password, refer to the *Character table for Skype* section on page 21.

To create a new Skype account on your phone:

1. Press the **Sign In** softkey. You see two options:
 - **Sign in to Skype** - sign in to Skype using an existing Skype account.
 - **Create new account** - sign in to Skype by creating a new Skype account.
2. Press calls/▽ to select **Create new account**, and then press the **Select** softkey.

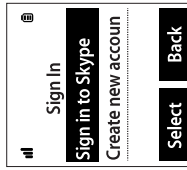

3. Enter the new Skype username, and then press the **OK** softkey.
4. Enter the new Skype password, and then press the **OK** softkey.
5. Re-enter the password in step 4, and then press the **OK** softkey.

If Skype does not accept your user name and password, you will get a message "failed!". You will need to try another combination of user name and password that meet Skype's requirements and has not already been used by another user.

6. The message "**No emergency calls. Skype is not a replacement for your ordinary telephone and cannot be used for emergency calling. I have read and accept Skype's terms and conditions at www.skype.com/eula, www.skype.com/tos and in my device user guide**" appears.
7. Press the **Accept** softkey.

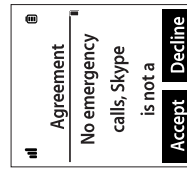
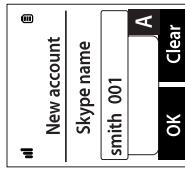

Skype setup and use

8. The screen displays "Connecting" for a few seconds.
9. The screen displays "Successful". Press the **OK** softkey.
10. The phone signs into Skype automatically using your new Skype account. You may want to write down your Skype Account information on page 80 for future reference.

Signing into Skype

If you already have an existing Skype account, you can sign in to Skype using your phone.

If this is the first time you sign in using your phone, you need to create a new user on the phone. If this is not the first time, your Skype username is already stored on the phone. In both cases, the Skype account has already been created. The new user is only new to the phone, not to Skype.

NOTE: If you have forgotten your Skype password, go to www.skype.com and choose "Sign In". Then choose "Forgotten your password?" and follow the directions on your computer screen.

1. Press the **Sign In** softkey. You see two options:
 - **Sign in to Skype** - sign in to Skype using an existing Skype account.
 - **Create new account** - sign in to Skype by creating a new Skype account.
2. **Sign in to Skype** is highlighted. Press the **Select** softkey and the Sign In screen will appear as shown.
3. The Sign In screen appears as shown.
4. If you are a *new user* to this phone, press **calls/▽** to select **<new user>**, then press the **OK** softkey.

-OR-
If you are an *existing user* to this phone, press **calls/▽** to select the desired user name, then press the **OK** softkey. In our example, the existing user names are **smith 00002** and **smith 00001**.

5. Enter your Skype username, and then press the **OK** softkey.
6. Enter your Skype password, and then press the **OK** softkey.
7. The message "**Save your name and password for auto reconnect?**" appears. Press the **Yes** softkey to automatically reconnect the next time you want to sign in. However, you can press the **No** softkey if there are multiple users who need to always sign in with a password.

Skype setup and use

8. The screen displays "Signing in <user name>" for a few seconds.
9. The screen displays "Successful". Press the **OK** softkey.
10. The phone signs into Skype automatically using your Skype account.

Skype ID

Your can switch to a different Skype ID by using the **Switch User** feature. You will be logged out of the current Skype ID you are using, and then log onto the new Skype ID of your choice.

The **Switch user** menu appears only if you have already signed into Skype. If you have not signed in, you will see the **Sign in** menu.

To switch to a Skype ID that is new to this phone:

1. Press the **Menu** softkey.
2. Press **calls/▽** or **calls/▽** to select **Skype Status**, and then press the **Select** softkey.
3. Press **calls/▽** to select **Switch user**, and then press the **Select** softkey.
4. Press **calls/▽** to select **<New user>**, and then press the **Select** softkey.
5. Enter the new Skype ID, and then press the **OK** softkey.
6. Enter the password for the Skype ID, and then press the **OK** softkey
7. The screen displays "**Save your name and password for auto reconnect?**" Press the **Yes** softkey to automatically reconnect the next time you want to sign in. However, you can press the **No** softkey if there are multiple users who need to always sign in with a password.
8. The screen displays "Successful". Press the **OK** softkey.

To switch to a Skype ID that already exists on this phone:

1. Press the **Menu** softkey.
2. Press **calls/▽** or **calls/▽** to select **Skype Status**, and then press the **Select** softkey.
3. Press **calls/▽** to select **Switch user**, and then press the **Select** softkey.
4. Press **calls/▽** to select the desired Skype user name, and then press the **Select** softkey.
5. Enter the password, and then press the **OK** softkey.
6. The screen displays "**Save your name and password for auto reconnect?**" Press the **Yes** softkey to automatically reconnect the next time you want to sign in. However, you can press the **No** softkey if there are multiple users who need to always sign in with a password.
7. The screen displays "Successful". Press the **OK** softkey.

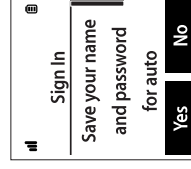
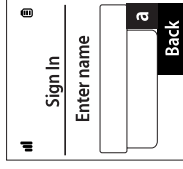
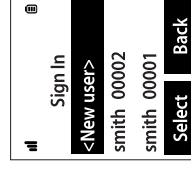
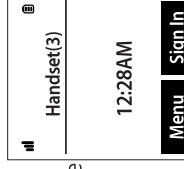

Skype setup and use

Changing your online status

Your Skype online status can be seen by all Skype contacts authorized by you. There are four online status to choose from: **Online**, **Away**, **Do not disturb**, **Offline**.

1. Press the **Menu** softkey.
2. Press \triangleleft int/ \triangleright redial or calls/ ∇ to select **Skype Status**, and then press the **Select** softkey.
3. Press calls/ ∇ to select **Online status**, and then press the **Select** softkey.
4. Press calls/ ∇ select the desired online status, and then press the **Select** softkey.
5. The screen displays the new online status. Press the **OK** softkey.

NOTE: You can also access the **Skype Status** menu by pressing \square on handset when in idle mode.

Skype Profile

Your Skype profile allows you to tell other Skype users about yourself. Your profile has public and private details. The public details are seen by all Skype users, while the private details can only be seen by users you have authorized. Skype does not require you to enter any information into your profile.

Viewing and editing your public profile

1. Press the **Menu** softkey.
2. Press \triangleleft int/ \triangleright redial or calls/ ∇ to select **Skype Status**, and then press the **Select** softkey.
3. Press calls/ ∇ to select **My profile**, and then press the **Select** softkey.
4. Press calls/ ∇ to select **Limited profile**, and then press the **Select** softkey.
5. Press calls/ ∇ to select the desired setting, and then press the **Select** softkey.
 - The settings available are **Skype name**, **Full name**, **Gender**, **Birth date**, **Country/Region**, **State/Province**, **City**, **Language**, **Home phone**, **Office phone**, **Mobile phone**, **Homepage**, **About me**, and **Mood**.
 - Please note that you cannot change your Skype name here.
6. Modify the setting you chose in step 5, and then press the **OK** softkey.
7. The screen displays "Successful". Press the **OK** softkey.

Viewing and editing your private profile

Your private profile allows you to enter your email addresses. You can define up to 3 email addresses in your private profile (**Email 1**, **Email 2**, and **Email 3**). Users who know your email address can easily find you on the Skype network by searching for it.

1. Press the **Menu** softkey.

Skype setup and use

2. Press \triangleleft int/ \triangleright redial or calls/ ∇ to select **Skype Status**, and then press the **Select** softkey.
3. Press calls/ ∇ to select **My profile**, and then press the **Select** softkey.
4. Press calls/ ∇ to select **Private details**, and then press the **Select** softkey.
5. Press calls/ ∇ to select **Email X**, where X = 1, 2, or 3, and then press the **Options** softkey.
 - If there is no email address at **Email X**, the option **Add** appears on the screen. Follow the screen prompt to enter a new email address.
 - If there is already an email address at **Email X**, the options **Edit** and **Remove** appear on the screen. Follow the screen prompts to edit or remove the email address.
6. The screen displays "Successful". Press the **OK** softkey.

Changing your password

You can change the Skype password used for signing in to your Skype account. For more information on how to create a new Skype account, refer to the section *Creating a new Skype account* on page 6.

1. Press the **Menu** softkey.
2. Press \triangleleft int/ \triangleright redial or calls/ ∇ to select **Skype Status**, and then press the **Select** softkey.
3. Press calls/ ∇ to select **Change password**, and then press the **Select** softkey.
4. Enter the current password of your Skype account, and then press the **OK** softkey.
5. Enter the new password you desired, and then press the **OK** softkey.
6. Re-enter the new password in step 5, and then press the **OK** softkey.
7. The screen displays "Successful". Press the **OK** softkey.

Signing out of Skype

To sign out of Skype:

1. Press the **Menu** softkey.
2. Press \triangleleft int/ \triangleright redial or calls/ ∇ to select **Skype Status**, and then press the **Select** softkey.
3. Press calls/ ∇ to select **Sign out**, and then press the **Select** softkey.
4. The message "Skype Contact not Available when Signed Out" appears. Press the **OK** softkey.
5. The screen displays "Successful". Press the **OK** softkey.

Skype setup and use

Viewing your account status

You can change the account status. There are 3 options: **Skype credit**, **SkypeIn**, and **Voicemail**.

Voicemail refers to Skype voicemail, not the voicemail provided by your landline telephone service provider.

1. Press the **Menu** softkey.
2. Press **⏪/redial** or **calls/▽** to select **Skype Status**, and then press the **Select** softkey.
3. Press **calls/▽** to select **Account status**, and then press the **Select** softkey.
4. Select the desired account status, and then press the **OK** softkey.
 - **Skype credit** — shows the Skype credit in your account and the expiration date
 - **SkypeIn** — shows the Online Number for your account and the expiration date
 - **Voicemail** — shows the date when your Skype Voicemail subscription expires.
5. Press the **Back** softkey four times to exit to the main menu.

Entering characters

You can enter text and numbers for handset names, Skype ID names, and phonebook contact names. Note that the handset names can be up to 20 characters, Skype ID names can be up to 32 characters, and phonebook contact names can be up to 50 characters.

The phone supports a set of characters that you can choose from the dial keypad. However, Skype supports only a subset of the characters supported by the phone. When you are working with Skype, less characters are available to you on the phone.

Entering text and numbers

To enter text and numbers using the dial keypad:

1. Find the key on the dial keypad with the desired character.
2. Press the key as many times as needed to display the desired character.
3. Press the **OK** softkey to confirm.

NOTES:

1. To delete a character to the left of the cursor, press the **Clear** softkey.
2. To delete all the characters displayed on the screen, press and hold the **Clear** softkey.

Example: Entering the word "PAUL"

Press **7** once **P**
Press **2** once **A**
Press **8** twice **U**
Press **5** three times **L**

Switching input modes

There are three input modes: **uppercase A**, **lowercase a**, and **numeric 1**.

By default, all characters entered will be in uppercase. You can press ***OK** to switch between uppercase, lowercase, and numeric characters.

NOTE: The lower righthand corner displays the method you have currently selected: **A** for uppercase, **a** for lowercase, and **1** for numeric mode.

Entering symbols

You can enter special symbols such as ?;!:) and many more.

1. Press **#Symbol** while editing in lowercase or uppercase mode. A table of symbols is displayed.
2. Press **⏪/redial** or **calls/▽** to select the desired symbol, and then press the **OK** softkey. If you want to add the "+" symbol, press and hold **0+Star**.
3. The symbol is entered in the lowercase or uppercase mode.

Entering characters

Character table for Skype

Use the dial pad and the chart below to enter a Skype ID name or perform other Skype functions. Each press of a particular key displays the character in the following order:

Dial pad key	Character by number of key presses					
	1	2	3	4	5	6
[1]	1					
[2]	Aa	Bb	Cc	2		
[3]	Dd	Ee	Ff	3		
[4]	Gg	Hh	Ii	4		
[5]	Jj	Kk	Ll	5		
[6]	Mm	Nn	Oo	6		
[7]	Pp	Qq	Rr	Ss	7	
[8]	Tt	Uu	Vv	8		
[9]	Ww	Xx	Yy	Zz	9	
[0]	.	0	,	-		

Character table for the phone

Use the dial pad and the chart below to enter handset names, phonebook contact names, or other menu items. Each press of a particular key displays the character in the following order:

Dial pad key	Characters available on the phone
[1]	[space] 1@ #-<> &€£\$%[]{}~\$
[2]	ABC2/abc2
[3]	DEF3/def3
[4]	GHI4/ghi4
[5]	JKL5/jkl5
[6]	MNO6/mno6
[7]	PQRS7/pqrs7
[8]	TUV8/tuv8

Entering characters

[9]	WXYZ9/wxyz9
[0]	.0/,:;"!?'*+-%\^~

Handset settings

Scrolling the handset

The scroll bar on the handset is only visible when the selectable items do not fit into the defined screen area. Otherwise, no scroll bar will be displayed.

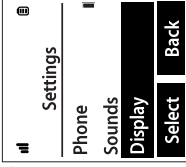

You can navigate the scroll bar by pressing  or  calls/▽.

The scroll bar is always on the righthand side of the screen.





Setting the ringtone

You can set the ringtone for 3 kinds of calls: **Skype calls**, **Regular calls**, and **Intercom**. You can assign any one of 15 built-in ringtones to these call types. Assigning a different ringtone for each will help tell you which type of call is received without looking at the display of the GE 31591.

1. Press the **Menu** softkey.
2. Press int/  or calls/▽ to select **Settings**, and then press the **Select** softkey.
3. Press calls/▽ to select **Sounds**, and then press the **Select** softkey.
4. Press calls/▽ to select **Ringtone**, and then press the **Select** softkey.
5. Press calls/▽ to select the desired call type, and then press the **Select** softkey.
6. Press calls/▽ to select the desired ring tone, and then press the **Select** softkey.
7. The screen displays "Successful". Press the **OK** softkey.

Setting the ring volume

You can set the handset ringer volume from **Volume 0** (no sound) to **Volume 5** or to **Ascending**.

1. Press the **Menu** softkey.
2. Press int/  or calls/▽ to select **Settings**, and then press the **Select** softkey.
3. Press calls/▽ to select **Sounds**, and then press the **Select** softkey.
4. Press calls/▽ to select **Ring volume**, and then press the **Select** softkey.
5. Press calls/▽ to select the desired ring volume, and then press the **Select** softkey.
6. The screen displays "Successful". Press the **OK** softkey.

Setting the keypad tone

You can choose whether you want to hear a tone whenever you press a key or whether you want your keys to be silent.



1. Press the **Menu** softkey.
2. Press int/  or calls/▽ to select **Settings**, and then press the **Select** softkey.

Handset settings



3. Press calls/▽ to select **Sounds**, and then press the **Select** softkey.
4. Press calls/▽ to select **Keypad tone**, and then press the **Select** softkey.
5. Press calls/▽ to select **On or Off**, and then press the **Select** softkey.
6. The screen displays "Successful". Press the **OK** softkey.

Setting confirmations

A confirmation is a beep sound you hear when you have successfully completed an operation. You also get a beep sound when an operation fails. You can choose to turn the beep sound on or off.



1. Press the **Menu** softkey.
2. Press int/  or calls/▽ to select **Settings**, and then press the **Select** softkey.
3. Press calls/▽ to select **Sounds**, and then press the **Select** softkey.
4. Press calls/▽ to select **Confirmation**, and then press the **Select** softkey.
5. Press calls/▽ to select **On or Off**, and then press the **Select** softkey.
6. The screen displays "Successful". Press the **OK** softkey.

Setting the time

1. Press the **Menu** softkey.
2. Press int/  or calls/▽ to select **Settings**, and then press the **Select** softkey.
3. Press calls/▽ to select **Time & Date**, and then press the **Select** softkey.
4. Press calls/▽ to select **Time**, and then press the **Select** softkey.
5. Enter the current hour and minute by modifying 2 digits for each.
 - If the time is 3:34 p.m. and you have chosen the **24 Hour** time format, press [1][5][3][4].
 - If the time is 3:34 p.m., and you have chosen the **12 Hour** time format, press [0][3][3][4].
6. Press the **OK** softkey.
7. The screen displays a check mark and the updated time. Press the **OK** softkey.

Setting the time format

You can set the time format by choosing **12 Hour** or **24 Hour**.

1. Press the **Menu** softkey.
2. Press int/  or calls/▽ to select **Settings**, and then press the **Select** softkey.
3. Press calls/▽ to select **Time & Date**, and then press the **Select** softkey.
4. Press calls/▽ to select **Time format**, and then press the **Select** softkey.

Handset settings

- Press calls/▽ to select the desired time format, and then press the **OK** softkey.
- The screen displays a check mark and the updated time format. Press the **OK** softkey.

Setting the date

- Press the **Menu** softkey.
- Press <int/ redial> or calls/▽ to select **Settings**, and then press the **Select** softkey.
- Press calls/▽ to select **Time & Date**, and then press the **Select** softkey.
- Press calls/▽ to select **Date**, and then press the **Select** softkey.
- Enter the current year, month, and date by modifying 2 digits for month and date and 4 digits for year.
 - If the date is June 13, 2011 and you have chosen the **MM/DD/YYYY** date format, press [0][6][1][3][2][0][1][1][1].
 - If the date is June 13, 2011 and you have chosen the **DD/MM/YYYY** date format, press [1][3][0][6][2][0][1][1][1].
 - If the date is June 13, 2011 and you have chosen the **YYYY/MM/DD** date format, press [2][0][1][1][1][3][0][6].
- The screen displays a check mark and the updated date. Press the **OK** softkey.

Setting the date format

You can set the date format by choosing **DD/MM/YYYY**, **MM/DD/YYYY**, or **YYYY/MM/DD**.

- Press the **Menu** softkey.
- Press <int/ redial> or calls/▽ to select **Settings**, and then press the **Select** softkey.
- Press calls/▽ to select **Time & Date**, and then press the **Select** softkey.
- Press calls/▽ to select **Date format**, and then press the **Select** softkey.
- Press calls/▽ to select the desired date format, and then press the **OK** softkey to confirm.
- The screen displays a check mark and the updated date format. Press the **OK** softkey to confirm.

Setting the date separator

You can set the date separator by choosing /, :, or -.

- Press the **Menu** softkey.
- Press <int/ redial> or calls/▽ to select **Settings**, and then press the **Select** softkey.

Handset settings

- Press calls/▽ to select **Time & Date**, and then press the **Select** softkey.
- Press calls/▽ to select **Date separator**, and then press the **Select** softkey.
- Press calls/▽ to select the desired date separator, and then press the **OK** softkey.
- The screen displays a check mark and the updated date separator. Press the **OK** softkey to confirm.

Emergency calls

 **IMPORTANT:** Skype does not allow emergency calls. Such calls are always routed to the landline connections. Therefore, you should not rely on your GE 31591 phone for emergency services. Alternative arrangements should be made instead.

Please note also it is important that you set the correct landline country because it affects the emergency phone calls. Do not forget that your GE 31591 phone has to be connected to a power outlet in order to work. Your phone will not function during a power failure.

Assigning a preferred line

A preferred line is the line of priority for calls. After setting the preferred line, all your calls will always be dialed out on the preferred line when you press .

You may select either Regular or SkypeOut call as your preferred line. Alternatively, you can set your phone to prompt you each time you make a call. The three choices are therefore: **Regular call**, **SkypeOut call**, and **Always ask**. The default is **Regular call**.

- Press the **Menu** softkey.
- Press <int/ redial> or calls/▽ to select **Settings**, and then press the **Select** softkey.
- Press calls/▽ to select **Phone**, and then press the **Select** softkey.
- Press calls/▽ to select **Preferred line**, and then press the **Select** softkey.
- Press calls/▽ to select the desired option, and then press the **Select** softkey.
- The screen displays "**Successful**". Press the **OK** softkey.

NOTE: After the first Skype credit or Landline call as a new user, your phone will invite you to set up a preferred call method.

Changing the landline country setting

You can make changes to the landline country setting after the initial setup. The country choices are **US** and **Canada**.

- Press the **Menu** softkey.
- Press <int/ redial> or calls/▽ to select **Settings**, and then press the **Select** softkey.
- Press calls/▽ to select **Advanced**, and then press the **Select** softkey.

Handset settings

1. Press Δ \square Δ \square to select **Country**, and then press the **Select** softkey.
2. Press calls/ Δ to select the desired country setting, and then press the **Select** softkey.
3. Press calls/ Δ to select the desired country setting, and then press the **Select** softkey.
4. Press calls/ Δ to select the desired country setting, and then press the **Select** softkey.
5. Press calls/ Δ to select the desired country setting, and then press the **Select** softkey.
6. The screen displays "Successful". Press the **OK** softkey.

NOTE: Emergency calls may not work properly if your country settings are not configured correctly.

Changing the handset display language

The language choices are **English**, **Español**, and **Français**.

1. Press the **Menu** softkey.
2. Press Δ \square Δ \square to select **Settings**, and then press the **Select** softkey.
3. Press calls/ Δ to select **Phone**, and then press the **Select** softkey.
4. Press calls/ Δ to select **Language**, and then press the **Select** softkey.
5. Press calls/ Δ to select the desired language, and then press the **Select** softkey.
6. The screen displays "Successful". Press the **OK** softkey.

Registering additional handsets

Your phone comes with 1 handset that is already registered to the telephone base.

NOTE: Make sure you have configured the country, the language, and the area code of your phone before registering additional handset(s). You can have up to 4 handsets and you need to register the additional handset(s) with the telephone base before using them.

Your **GE 31591** phone is compatible with **GE 31590** accessory handsets. For information on how to purchase accessory handsets, please visit our website at **www.gephones.com**

1. With the handset near the telephone base, press the **Menu** softkey on the handset.
2. Press Δ \square Δ \square to select **Settings**, and then press the **Select** softkey.
3. Press calls/ Δ to select **Phone**, and then press the **Select** softkey.
4. Press calls/ Δ to select **Registration**, and then press the **Select** softkey.
5. Press the find key  on the telephone base for 3 seconds.
6. The handset screen displays "Press menu to register?" Press the **OK** softkey.
7. The handset screen displays "Successful". Press the **OK** softkey.

Setting the handset backlight

You can set the length of time your handset backlight is on. The choices available are **20 seconds**, **30 seconds**, and **1 minute**.

1. Press the **Menu** softkey.

Handset settings

2. Press Δ \square Δ \square to select **Settings**, and then press the **Select** softkey.
3. Press calls/ Δ to select **Display**, and then press the **Select** softkey.
4. Press calls/ Δ to select **Backlight**, and then press the **Select** softkey.
5. Press calls/ Δ to select the desired duration for handset backlight, and then press the **Select** softkey.
6. The screen displays "Successful". Press the **OK** softkey.



Setting the screen saver

You can turn the screen saver for the handset on and off. If the screen saver option is on, the screen saver appears whenever the cordless handset is being placed inside the charger cradle for 5 seconds and the handset backlight is off.

1. Press the **Menu** softkey.
2. Press Δ \square Δ \square to select **Settings**, and then press the **Select** softkey.
3. Press calls/ Δ to select **Display**, and then press the **Select** softkey.
4. Press calls/ Δ to select **Screen saver**, and then press the **Select** softkey.
5. Press calls/ Δ to select **On or Off**, and then press the **Select** softkey.
6. The screen displays "Successful". Press the **OK** softkey.

Finding a handset

You can locate a misplaced handset by paging it from the telephone base.

1. Press the find key  on the telephone base. All the handset(s) registered with this base unit will ring.
2. Press  on the telephone base again to stop paging. All the handset(s) registered with this base unit will stop ringing.

-OR-

Press the **OK** softkey on a handset to stop the paging for that handset.

Naming your handset

Your handset displays the name "Handset" when in idle mode. You can personalize the handset by changing the name.

1. Press the **Menu** softkey.
2. Press Δ \square Δ \square to select **Settings**, and then press the **Select** softkey.
3. Press calls/ Δ to select **Phone**, and then press the **Select** softkey.

Handset settings

4. Press **calls/▽** to select **Handset name**, and then press the **Select** softkey.
5. Enter the desired name for the handset, and then press the **OK** softkey.
6. The screen displays **"Successful"**. Press the **OK** softkey.

Telephone operation

Making a regular call

You can make a landline call by going off-hook on the telephone line first and then dialing the number.

1. Press  or .
2. Dial the phone number.

Pre-dialing a regular call

Pre-dialing a landline call allows you to view and edit the number before making the call.

1. Dial the phone number using the dial pad keys.

Method 1

2. Press  or  to call.

-OR-

Method 2

3. Press the **Options** softkey, then press **calls/▽** to select **Regular call**.
4. Press the **Select** softkey to make the call.

Pre-dialing a Skype call

Pre-dialing a Skype ID call allows you to view and edit the Skype ID before making the call.

1. Press .
2. Enter the Skype ID you want to call.
3. Press the **Options** softkey, then press **calls/▽** to select **Call**.
4. Press the **Select** softkey or  to make the call.

Pre-dialing a SkypeOut call

Pre-dialing a SkypeOut call allows you to view and edit the number before making the call.

Inserting a country prefix "+"

To make a SkypeOut call, it is necessary to dial the country prefix "+" before dialing the number you want to call. The number must include the country code, area code (if applicable), and local phone number. The format to input your number is as follows:

+<country code><area code><local number>

For example, when calling to North America, you dial +18773949775.

Telephone operation

To make a SkypeOut call:

1. Dial the phone number using the dial pad keys.
 - To insert a "+", press and hold .
2. Press the **Options** softkey, then press   to select **SkypeOut call**.
3. Press the **Select** softkey to make the call.

Making a Skype call from contacts

A Skype call refers to a call from a Skype ID to another Skype ID. It is a free service offered by Skype and does not involve any actual phone numbers.

To make a Skype ID call:

1. Press the **Menu** softkey. 
2. Press  or  to select **Contacts**, and then press the **Select** softkey.

-OR-

Press  while in idle mode.



3. Press  to select the desired online contact, and then press the **Options** softkey. 
4. Press  to select **Call**, and then press the **Select** softkey.

NOTE: If you have selected a SkypeOut contact, the choice available is **SkypeOut call**.

5. Wait for the call to connect, ring, and be answered.
6. If you want to hold the call during the conversation, press the **Hold** softkey. Press the **Resume** softkey to resume conversation.
7. If you want to end the call, press the **End** softkey.

Answering a call

You can answer a Skype ID call, a Skypeln call, and a landline call. However, you can only reject a Skype ID call and a Skypeln call, but not a landline call.

- When the phone rings, press the **Answer** softkey or  to take the call.
 - Press the **Reject** softkey or  to decline the call.
- NOTE:** Unlike typical telephones, other system handsets cannot automatically join a call in progress. They must be conferenced in by the first handset in use. For more information, refer to the *3-way conference call* section on page 35.

Missed calls

When a Skype ID or Skype In call is missed, your phone displays "**You have X new missed calls**" where X is the number of missed call you have received.

Telephone operation

To view the missed call:

1. Press the **View** softkey to see the history of the missed calls.
2. Select the desired call entry.
3. Press the **Options** softkey to take further actions (**Call**, **Add to contacts**, **Details**, **Delete**, or **Delete all**).

Placing a call on hold

When you are in a Skype ID or Skypeln call, you can place the call on hold. You cannot hold a landline call.

1. Press the **Hold** softkey to hold a call.
2. Press the **Unhold** softkey to unhold a call.

NOTE: If a call that is placed on hold is not picked up within 5 minutes, the call will be automatically disconnected.

Ending a call

When you want to end a call after talking for some time, you can press the **End** softkey or .

This applies to regular landline call, Skype ID call, and Skypeln call.

Muting the microphone

The mute function allows you to turn off the microphone while on a call. You can hear the other party but the other party cannot hear you.

1. Press  during a call to mute the microphone.
2. Press  again to resume conversation.

Speakerphone

Anytime during a call, press  on the cordless handset to switch between speakerphone and normal handset use.

Speakerphone activation can suddenly increase the volume in the earpiece to a very high level. Make sure the handset is not too close to your ear.

NOTE: Using the speakerphone will drain the battery of the cordless handset faster than normal handset use.

Volume control

You can adjust the volume of the handset earpiece or the speakerphone from **Volume 1** to **Volume 5** anytime during a call. Unlike the ringer volume, you cannot turn the volume to zero.

NOTE: The volume control for the cordless handset and the speakerphone are independent of each other. For example, you can set the volume for the handset ^{eg}piece to Volume 4 but set the volume of the

Telephone operation

speakerphone to Volume 2.

Speakerphone volume









- During a call that uses the speakerphone, press   or   to adjust the speakerphone volume.

Handset earpiece volume

- During a call that uses the handset earpiece, press   or   to adjust the handset earpiece volume.

Resetting the phone

You can restore the factory settings of your phone in two ways: **Reset all** and **Keep network**.

1. Press the **Menu** softkey.
 2. Press  or   to select **Settings**, and then press the **Select** softkey.
 3. Press   to select **Advanced**, and then press the **Select** softkey.
 4. Press   to select **Reset settings**, and then press the **Select** softkey.
 5. Press   to select the desired method of resetting your phone, and then press the **Select** softkey.
- **Reset all** - resets all the factory settings of your phone, *including* the network settings.
 - **Keep network** - resets all the factory settings of your phone, *except* the network settings.
6. The screen displays “**Confirm?**” Press the **Yes** softkey to confirm.
 7. The screen displays “**Successful**”. Press the **OK** softkey.

 **CAUTION: Please note that all your personal settings will be lost.**

Call waiting or call waiting with caller ID service

To use call waiting, you must subscribe to call waiting service from your telephone service provider. This feature allows you to receive calls while you are already talking on the phone. You will hear a call waiting alert tone when there is a second incoming call. If you subscribe to both caller ID and call waiting with caller ID services, the second caller's information is displayed after you hear the call waiting alert tone.

1. Press  to answer the second incoming call.
2. Press  to switch between calls.

34

Telephone operation

Voice message waiting indicator

The  icon displays on the handset screen when you have received a new voice mail message. This applies to both landline voicemail and Skype Voicemail.

IMPORTANT: In order to use the landline voice mail service, you must subscribe to it from your telephone service provider. In order to use Skype Voicemail, you have to pay for it using Skype Credit. For more information, go to <http://www.skype.com/intl/en-us/features/allfeatures/voicemail/>.

Intercom

An intercom call is a call to another handset registered to the same telephone base unit. This function can only be used when multiple handsets are available. You can also use this feature to locate a misplaced handset.

The phone supports up to 4 registered handsets. The default names are Handset 1, Handset 2, Handset 3, and Handset 4.

To make an intercom call:

Handset 1

1. Press  when the handset is in idle mode. The available handsets are displayed.
2. Press   to select the desired handset, and then press the **Call** softkey.

Handset 2

3. Press  or  to take the call and start talking.

Handset 1



4. To end the intercom call, press  or place the cordless handset in the charger.

NOTES:

1. The intercom call can be cancelled before it is answered by pressing  on the originating handset.
2. If the called handset does not answer within 60 seconds, the intercom will be cancelled.

Answering an incoming call during an intercom call

You will hear an alert tone when you receive an incoming call during an intercom call. The incoming call can be a landline call, Skype ID call, or Skypeline call.

1. Press  to end the intercom call.
2. Press  to accept the incoming external call.

Making an intercom call during an external call

While talking on the phone on the Skype line or landline, you can call initiate an intercom call by calling another handset.

35

Telephone operation

Handset 1

1. Press **int** during an external call.
2. Press **calls** to select the desired handset, and then press the **Call** softkey.

Handset 2

3. Press **hand** to take the call and talk to handset 1. The external call is now on hold.

To return to the external call:

Handset 1

4. Press the **End** softkey during the intercom call. This ends the intercom call and you are now returned to the external call.

NOTE: The external call will be placed on hold automatically.

Transferring a call

During an external call, you can transfer the call to a specific handset.

Handset 1

1. Press **int** during an external call.
2. Press **calls** to select the desired handset, and then press the **Call** softkey.

Handset 2

3. Press **hand** to take the call.

Handset 1

4. Press **hand** to transfer the external call to handset 2.

3-way conference call

Conference allows one external call to be shared with two handsets registered to the same telephone base. No subscription is necessary to use this feature.

The external call can be a landline call or a SkypeIn call.

Handset 1

1. Press **int** during an external call.
2. Press **calls** to select the desired handset, and then press the **Call** softkey.

Handset 2

3. Press **hand** to take the call.

Handset 1

Telephone operation

4. Press the **Conf.** softkey during the intercom call. You have now established a 3-way conference call.

5. Press **end** to end the conference call.

Forwarding a Skype call

You can configure your phone to forward all incoming Skype calls to either a landline number, mobile number, or to your Skype Voicemail. You can also block Skype calls or SkypeIn calls to your phone.

Please note that in order to use Skype call forwarding, you need to have Skype Credits.

Forward a Skype call to your Skype Voicemail

1. Press the **Menu** softkey.
2. Press **int/redial** or **calls** to select **Settings**, and then press the **Select** softkey.
3. Press **calls** to select **Skype call**, and then press the **Select** softkey.
4. Press **calls** to select **Voicemail**, and then press the **Select** softkey.
5. Press **calls** to select **Forward unanswered**, and then press the **Select** softkey.
6. Press **calls** to select **On**, and then press the **Select** softkey. You can select **Off** later to turn off this function.
7. The screen displays **"Successful"**. Press the **OK** softkey.

Forward a Skype call to a landline number

1. Press the **Menu** softkey.
2. Press **int/redial** or **calls** to select **Settings**, and then press the **Select** softkey.
3. Press **calls** to select **Skype call**, and then press the **Select** softkey.
4. Press **calls** to select **Call forward**, and then press the **Select** softkey.
5. Press **calls** to select **Call forward:<On/Off>**, and then press the **Select** softkey.
6. Press **calls** to select **On**, and then press the **Select** softkey. You can select **Off** later to turn off this function.
7. Enter the landline or mobile number to which you want the Skype call forwarded. Press the **Clear** softkey if you need to modify the digits.
8. The screen displays **"Successful"**. Press the **OK** softkey.

Setting the PSTN number to forward

1. Press the **Menu** softkey.
2. Press **int/redial** or **calls** to select **Settings**, and then press the **Select** softkey.
3. Press **calls** to select **Skype call**, and then press the **Select** softkey.

Telephone operation

1. Press **calls/▽** to select **Call forward**, and then press the **Select** softkey.
2. Press **calls/▽** to select **Number**; and then press the **Select** softkey.
3. Enter the landline or mobile number to which you want the Skype call forwarded. Press the **Clear** softkey if you need to modify the digits.
4. The screen displays **"Successful"**. Press the **OK** softkey.

Setting Skype Voicemail Greeting

You can record your own greeting message for your Skype Voicemail. If you do not record a personal message, the Skype standard message will be used instead.

1. Press the **Menu** softkey.
2. Press **int/realia▷** or **calls/▽** to select **Settings**, and then press the **Select** softkey.
3. Press **calls/▽** to select **Skype call**, and then press the **Select** softkey.
4. Press **calls/▽** to select **Voicemail**, and then press the **Select** softkey.
5. Press **calls/▽** to select **My greetings**, and then press the **Select** softkey.
6. Press the **Options** softkey. You have 3 options. Make your selection and then press the **Select** softkey.
 - **Play** — plays your current voicemail greeting.
 - **Record** — records a new voicemail greeting. Press the **OK** softkey when you are finished recording the message.
 - **Reset default** — resets to the default greeting message provided by Skype.
7. The screen displays **"Successful"**. Press the **OK** softkey.

Blocking Skype ID calls or SkypeIn calls

This privacy feature lets you configure your phone to allow either anyone to call you or only your contacts to call you. You can block both Skype ID calls and SkypeIn calls.

Blocking Skype ID calls

1. Press the **Menu** softkey.
2. Press **int/realia▷** or **calls/▽** to select **Settings**, and then press the **Select** softkey.
3. Press **calls/▽** to select **Skype call**, and then press the **Select** softkey.
4. Press **calls/▽** to select **Block calls**, and then press the **Select** softkey.
5. Press **calls/▽** to select **Skype calls**, and then press the **Select** softkey.
6. Press **calls/▽** to select **My contacts** or **Anyone**, and then press the **Select** softkey.
7. The screen displays **"Successful"**. Press the **OK** softkey.

Telephone operation

Blocking SkypeIn calls

1. Press the **Menu** softkey.
2. Press **int/realia▷** or **calls/▽** to select **Settings**, and then press the **Select** softkey.
3. Press **calls/▽** to select **Skype call**, and then press the **Select** softkey.
4. Press **calls/▽** to select **Block calls**, and then press the **Select** softkey.
5. Press **calls/▽** to select **SkypeIn calls**, and then press the **Select** softkey.
6. Press **calls/▽** to select **My contacts**, **Known numbers**, or **Anyone**, and then press the **Select** softkey.
7. The screen displays **"Successful"**. Press the **OK** softkey.

Viewing/unlocking the block user list

You can view or unblock the blocked user list.

1. Press the **Menu** softkey.
2. Press **int/realia▷** or **calls/▽** to select **Settings**, and then press the **Select** softkey.
3. Press **calls/▽** to select **Skype call**, and then press the **Select** softkey.
4. Press **calls/▽** to select **Block calls**, and then press the **Select** softkey.
5. Press **calls/▽** to select **Blocked users**, and then press the **Select** softkey.
6. A list of blocked users appears. Press **calls/▽** to select the desired entry, and then press the **Unblock** softkey to unblock.
7. The screen displays **"Successful"**. Press the **OK** softkey.

Area code management

This feature automatically removes the area code of an incoming call. You can define an area code you want to remove. The phone number will be saved in the call history without the area code.

To activate removing an area code:

1. Press the **Menu** softkey.
2. Press **int/realia▷** or **calls/▽** to select **Settings**, and then press the **Select** softkey.
3. Press **calls/▽** to select **Regular call**, and then press the **Select** softkey.
4. Press **calls/▽** to select **Area code**, and then press the **Select** softkey.
5. Enter the area code, then press the **OK** softkey.
6. The screen displays **"Successful"**. Press the **OK** softkey.

To deactivate removing an area code:

1. Press the **Menu** softkey.

Telephone operation

2. Press \triangleleft int/ \triangleright redial/ \triangle or calls/ ∇ to select **Settings**, and then press the **Select** softkey.
3. Press calls/ ∇ to select **Regular call**, and then press the **Select** softkey.
4. Press calls/ ∇ to select **Area code**, and then press the **Select** softkey.
5. Press the **Clear** softkey to delete the digits, and then press the **OK** softkey.
6. The screen displays "**Successful**". Press the **OK** softkey.

Contacts

Contacts









Your contact list displays all of the names you can make calls to. If you have an existing Skype account, your contact list is automatically downloaded when you sign in. If you are new to Skype and have just created an account, your contact list will be empty. You will need to add contacts to your list.

Skype protects the privacy of its users by requiring exchange contact details on names that you wish to add to your contact list. When you add a name to your list, an exchange contact details request is sent to the user. The user can accept or decline the request. When a request is accepted, you can see when your contacts are online and make calls to them. You can also view their personal profile details.



You can add a Skype contact, a SkypeOut contact, and a phonebook contact. In addition, you can also add a PSTN contact. The maximum number of entries in the contact list is 200.

Contact display icons

The following table shows the display icons for the contacts:

Item	Meaning
	Status Offline
	Status Online
	Status Away
	Status Do Not Disturb
	Status Pending
	Status Blocked
	Status Calls Forwarded
	Status Available

Contacts

	Status SkypeOut
	Landline Call

Adding a Skype contact

When you add a Skype contact, you can send an authorization request (contact request) to the person whom you want to add. You can only see his or her online status if the request is accepted. If it is not, her status appears offline to you. For more information on contact request, please refer to the section *Exchange contact details request* on page 46.

NOTE: All data regarding home phone, office phone, and mobile phone supplied by a Skype user will be recorded in your Contact list when you add the contact.

1. Press the **Menu** softkey.
2. Press \triangleleft int/ \triangleright redial or calls/ \triangleright to select **Contacts**, and then press the **Select** softkey.
3. Press calls/ \triangleright to select **Add contact**, and then press the **Select** softkey.
4. Press calls/ \triangleright to select **Skype contact**, and then press the **Select** softkey.
5. Enter the Skype ID of the contact, and then press the **OK** softkey. A list of matching contacts is displayed.
6. Press calls/ \triangleright to select the desired Skype contact, and then press the **Select** softkey.
7. The screen displays "**Successful**". Press the **OK** softkey.
8. The message "**Send a request to see his/her contact details?**" appears.
 - Press the **Yes** softkey to accept. Go to step 9.
 - Press the **No** softkey to decline. The system returns to idle mode.
9. The **Say hello** screen appears, press the **OK** softkey to send the default request without any personal message. You can also edit the request with your own message before pressing the **OK** softkey.
10. The screen displays "**Successful**". Press the **OK** softkey. An authorization request is sent to the contact. The new contact will be added after the user accepts your request. For more information on contact request, please refer to the section *Exchange contact details request* on page 47.

NOTES:

1. If your contact list is full, the handset displays a notification message. Delete some contacts before adding new ones.
2. Besides Skype name, you can also enter the full name or the email of the Skype contact you want to add.

Contacts

Adding a SkypeOut or PSTN contact

SkypeOut allows you to make calls to traditional landline and mobile phones.

To add a SkypeOut contact:

1. Press the **Menu** softkey.
2. Press \triangleleft int/ \triangleright redial or calls/ \triangleright to select **Contacts**, and then press the **Select** softkey.
3. Press calls/ \triangleright to select **Add contact**, and then press the **Select** softkey.
4. Press calls/ \triangleright to select **Skypeout contact**, and then press the **Select** softkey.
5. Enter the number of the Skypeout contact.
 - The format of the phone number should be <country code><area code><local phone number>.
 - A "+" sign is already inserted for you to indicate international dialing.
 - For example, if you are entering a USA phone number with area code "123" and local number "456-7890", you should enter [1][1][2][3][4][5][6][7][8][9][0].
6. Enter the name of the SkypeOut contact, and then press the **OK** softkey.
7. The screen displays "**Successful**". Press the **OK** softkey.

Accessing the contact list

There are two ways to access the contact list.

Method 1

1. Press the **Menu** softkey.
2. Press \triangleleft int/ \triangleright redial or calls/ \triangleright to select **Contacts**, and then press the **Select** softkey.

Method 2

- Press \triangleright while in idle mode. This is the shortcut to the contact list.

Viewing the contact list

You can view the contact list in idle mode.

1. Press \triangleright in idle mode.
2. Press calls/ \triangleright to select the contact you want to view, and then press the **Options** softkey.
3. Press calls/ \triangleright to select **View profile**, and then press the **Select** softkey.

Unknown details

If the contact has not accepted your contact request, the contact details are not known. You can send a request for details to the contact.

1. Press \triangleright in idle mode.

Contacts

2. Press **calls/▽** to select the contact you want to view, and then press the **Options** softkey.
3. Press **calls/▽** to select **Request details**, and then press the **Select** softkey to send the contact request again.

Searching a contact

You can search the contact list by scrolling or searching the first character.

Searching by scrolling

While in the contact list, press **calls/▽** to scroll.

Searching by the first character

While in the contact list, you can search a contact with the quick search feature by using the letters on the keypad. For example, if you press the letter J, you will see a list showing all of the contacts beginning with this letter.

Phonebook

Your phonebook can store a total of 200 Skype contacts and 100 PSTN number contacts.

The icon displayed in front of each contact indicates the type of the contact.

Saving a phonebook entry as SkypeOut contact

You can copy a phonebook contact to your SkypeOut contact list.

1. Press **▽** in idle mode.
2. Press **calls/▽** to select the desired phonebook contact, and then press the **Options** softkey.
3. Press **calls/▽** to select **Save as SkyOut contact**, and then press the **Select** softkey.
4. Enter the number of the contact, and then press the **OK** softkey.
5. Enter the name of the contact, and then press the **OK** softkey.
6. The screen displays **"Successful"**. Press the **OK** softkey.

Sending a voicemail to your Skype ID contact

You can send a voicemail to a Skype ID contact in your contact list.

NOTE: You can only send voicemail to your SkypeID contact, not a SkypeOut contact or phonebook contact.

1. Press **▽** in idle mode.
2. Press **calls/▽** to select the desired contact, and then press the **Options** softkey.

Contacts

3. Press **calls/▽** to select **Send voice mail**, and then press the **Select** softkey.
4. The voicemail greeting is played. You can record your voice mail, and then press the **OK** softkey.

Renaming a contact

You can change the display name of your contact.

1. Press **▽** in idle mode.
2. Press **calls/▽** to select the desired contact, and then press the **Options** softkey.
3. Press **calls/▽** to select **Rename**, and then press the **Select** softkey.
4. Edit the name for the contact, and then press the **OK** softkey.
5. The screen displays **"Successful"**. Press the **OK** softkey.

Removing a contact

You can remove a contact from your contact list.

1. Press **▽** in idle mode.
2. Press **calls/▽** to select the desired contact, and then press the **Options** softkey.
3. Press **calls/▽** to select **Remove**, and then press the **Select** softkey.
4. The screen displays **"Successful"**. Press the **OK** softkey.

Blocking a contact

You can block a contact from contacting you and vice versa. You will always appear offline to the user that you have blocked.

1. Press **▽** in idle mode.
2. Press **calls/▽** to select the desired contact, and then press the **Options** softkey.
3. Press **calls/▽** to select **Block**, and then press the **Select** softkey.
4. The screen displays **"Successful"**. Press the **OK** softkey.

Unblocking a contact

You can unblock a contact that you have previously blocked.

1. Press **▽** in idle mode.
2. Press **calls/▽** to select the desired blocked contact, and then press the **Options** softkey.
3. Press **calls/▽** to select **Unblock**, and then press the **Select** softkey.
4. The screen displays **"Successful"**. Press the **OK** softkey.

Contacts

Saving a Skypeout contact as a phonebook entry

You can save your Skypeout contact as a phonebook contact.

1. Press **⏏** in idle mode.
2. Press **calls/▽** to select the desired SkypeOut contact, and then press the **Options** softkey.
3. Press **calls/▽** to select **Save to phonebook**, and then press the **Select** softkey.
4. Press **calls/▽** to select the number to save to phonebook, and then press the **Select** softkey.
5. Edit the number of the contact, and then press the **OK** softkey.
6. Enter the name of the contact, and then press the **OK** softkey.
7. The screen displays **"Successful"**. Press the **OK** softkey.

Exchange contact details request

You can send an authorization request (for *contact request*) to a Skype user; if it is accepted, you can see his or her online status.

When adding a contact to your contacts list, you will be prompted to specify if you want to send an authorization request. We recommend that you send this request but you do not have to do so — and you can send the request whenever you wish to. If you do not send the request, you will never be able to see the contact's online status. Similarly, you will receive an authorization request whenever a Skype user adds you to his or her contacts list. By accepting the request, you allow the user to see your online status.

You can view the details of the contact who sent you a contact request before you choose to accept or decline the request, or block the contact.

Viewing the details of the contact

You can view the details of the contact who have sent a contact request to you.

1. Press the **Menu** softkey.
2. Press **int/realia▷** or **calls/▽** to select **Call History**, and then press the **Select** softkey.
3. Press **calls/▽** to select **Contact request**, and then press the **Select** softkey.
4. The contact's name is displayed. Press the **Options** softkey.
5. Press **calls/▽** to select **Details**, and then press the **Select** softkey.
6. The contact details are displayed. Press the **Back** softkey when finished.

Accepting a contact request

You can accept a contact request.

Contacts

1. Press the **Menu** softkey.
2. Press **int/realia▷** or **calls/▽** to select **Call History**, and then press the **Select** softkey.
3. Press **calls/▽** to select **Contact request**, and then press the **Select** softkey.
4. The contact's name is displayed. Press the **Options** softkey.
5. Press **calls/▽** to select **Accept**, and then press the **Select** softkey.
6. The screen displays **"Successful"**. Press the **OK** softkey.

Declining a contact request

You can decline a contact request.

1. Press the **Menu** softkey.
2. Press **int/realia▷** or **calls/▽** to select **Call History**, and then press the **Select** softkey.
3. Press **calls/▽** to select **Contact request**, and then press the **Select** softkey.
4. The contact's name is displayed. Press the **Options** softkey.
5. Press **calls/▽** to select **Decline**, and then press the **Select** softkey.
6. The screen displays **"Successful"**. Press the **OK** softkey.

Blocking a contact request

You can reject a contact request and block the contact.

1. Press the **Menu** softkey.
2. Press **int/realia▷** or **calls/▽** to select **Call History**, and then press the **Select** softkey.
3. Press **calls/▽** to select **Contact request**, and then press the **Select** softkey.
4. The contact's name is displayed. Press the **Options** softkey.
5. Press **calls/▽** to select **Block**, and then press the **Select** softkey.
6. The screen displays **"Successful"**. Press the **OK** softkey.

NOTE: Once a contact is blocked, you will not receive any further authorization request from the contact even if another contact request is made.

Call history

View call history

You can see all call history information, including missed calls, outgoing calls, incoming calls, contact authorization requests, and voicemails. Whenever there is an entry on one of the lists, you can see the details, such as the phone number, name (when accessible) and a time log indicating when the entry was received. Both PSTN and Skype calls will be registered in all the lists. The call entries are displayed in chronological order with the most recently received call at the top of the list.

NOTE: The phone will not store any call history (except for PSTN calls) if you are not signed into Skype. In addition, the call history lists will be deleted whenever you sign out of Skype. When you sign into Skype again, your phone starts saving new call history under the signed-in account.

Your options under call history are:

Call history information	Meaning
All events	A list containing all missed, incoming and outgoing calls.
Missed calls	A list showing only the missed calls (up to 50 calls).
Incoming calls	A list showing only the incoming calls (up to 50 calls).
Outgoing calls	A list showing only the outgoing calls (up to 20 calls).
Voice mails	For more information on Voicemail, refer to the section <i>Voicemail</i> on page 49.
Contact requests	For more information on contact requests, refer to the section <i>Exchange contact details request</i> on page 43.

Accessing the call history

There are two ways to access the contact list.

Method 1

1. Press the **Menu** softkey.
2. Press \triangleleft int/ redial▷ or calls/▽ to select **Call History**, and then press the **Select** softkey.

Method 2

- Press calls while in idle mode. This is the shortcut to the call history list.

Call history options

1. Press the **Menu** softkey.
2. Press \triangleleft int/ redial▷ or calls/▽ to select **Call History**, and then press the **Select** softkey.

Call history

3. Press calls/▽ to select **Missed calls**, and then press the **Select** softkey.
4. Press calls/▽ to select desired call entry, and then press the **Options** softkey.
5. Press calls/▽ to select desired action, and then press the **Select** softkey.

- **Call** — make a call on the preferred line.
- **SkypeOut Call** — make a SkypeOut call.
- **Regular Call** — make a regular PSTN call.
- **Save to contacts** — save the number to the contact list.
- **Save number** — save the number to the contact list.
- **Details** — view details of caller.
- **Delete** — delete the current call entry.
- **Delete all** — delete all the call entries.

IMPORTANT: Not all options are available for the selected call record. The options that are available vary according to the status of your contact (online, offline) and the type of contact (Online Number versus phone number contact).

Making a call from a call history list

Your phone stores all the call records of the outgoing, incoming, and missed calls. The most recent call record is stored at the top of the list. You can return a call from the missed call or incoming call lists. You can also redial a call you have dialed previously in your outgoing call list.

For outgoing calls, the number is dialed out using the same line as before. For example, if you made the call using SkypeOut, the call will be dialed out using SkypeOut again.

To make a call from a call history list:

1. Press the **Menu** softkey.
2. Press \triangleleft int/ redial▷ or calls/▽ to select **Call History**, and then press the **Select** softkey.
3. Press calls/▽ to select the desired call list, and then press the **Select** softkey.
4. Press calls/▽ to select the desired call entry, and then press  to call.

Saving a call entry to your contact list

You can save a call entry in one of the call history lists to your contact list.

1. Press the **Menu** softkey.
2. Press \triangleleft int/ redial▷ or calls/▽ to select **Call History**, and then press the **Select** softkey.
3. Press calls/▽ to select the desired call list, and then press the **Select** softkey.

Call history

1. Press **calls/▽** to select the desired call entry, and then press the **Options** softkey.
2. Press **calls/▽** to select **Save to contacts**, and then press the **Select** softkey.
3. Enter the name of the contact, and then press the **OK** softkey.
4. The screen displays **Successful**. Press the **OK** softkey.

Deleting a call entry from a call history list

You can delete a call entry in one of the call history lists.

1. Press the **Menu** softkey.
2. Press **int/realial▷** or **calls/▽** to select **Call History**, and then press the **Select** softkey.
3. Press **calls/▽** to select the desired call list, and then press the **Select** softkey.
4. Press **calls/▽** to select the desired call entry, and then press the **Options** softkey.
5. Press **calls/▽** to select **Delete**, then press the **Select** softkey.
6. A message **Confirm?** displays.
7. Press the **Yes** softkey to confirm.

Deleting all the call entries from a call history list

You can delete a call entry in one of the call history lists.

1. Press the **Menu** softkey.
2. Press **int/realial▷** or **calls/▽** to select **Call History**, and then press the **Select** softkey.
3. Press **calls/▽** to select the desired call list, and then press the **Select** softkey.
4. Press **calls/▽** to select the desired call entry, and then press the **Options** softkey.
5. Press **calls/▽** to select **Delete all**, then press the **Select** softkey.
6. A message **Confirm?** displays.
7. Press the **Yes** softkey to confirm.

Voicemail

The voicemail waiting icon  appears on your the screen of your handset when there are new voicemails. When all the voicemails are heard, the icon disappears. You can receive voicemail from both your Skype and PSTN (landline and mobile) callers. The voicemail icon applies to both types of calls. That means it will appear when there are Skype Voicemail™, or VMWI voicemail, or both.

Landline Voicemail

The landline voicemail service number must be defined in your phone before you can make a call to retrieve your voicemail or clear the old voicemail. You need to subscribe to voicemail service from your telecommunications service provider in order to use this feature.

You can define two voicemail service center numbers: **Voicemail 1** and **Voicemail 2**.

Calling a voicemail box

You can listen to your voicemails by calling the voicemail service center number.

1. Press the **Menu** softkey.
2. Press **int/realial▷** or **calls/▽** to select **Call History**, and then press the **Select** softkey.
3. Press **calls/▽** to select **Voice mails**, and then press the **Select** softkey.
4. Press **calls/▽** to select **Landline VM**, and then press the **Select** softkey.
5. Press **calls/▽** to select the desired voice mail center (**Voicemail 1** or **Voicemail 2**), and then press the **Options** softkey.
6. Press **calls/▽** to select **Call**, and then press the **Select** softkey.
7. The voicemail message(s) are played.

Deleting messages in a voicemail box

You can delete voicemails by clearing VMWI.

1. Press the **Menu** softkey.
2. Press **int/realial▷** or **calls/▽** to select **Call History**, and then press the **Select** softkey.
3. Press **calls/▽** to select **Voice mails**, and then press the **Select** softkey.
4. Press **calls/▽** to select **Landline VM**, and then press the **Select** softkey.
5. Press **calls/▽** to select the desired voice mail center (**Voicemail 1** or **Voicemail 2**), and then press the **Options** softkey.
6. Press **calls/▽** to select **Clear VMWI**, and then press the **Select** softkey.

Voicemail

- The voicemail message(s) are deleted.

Skype Voicemail™

Skype Voicemail™ takes your calls when you are busy or offline. You need to subscribe to this service from Skype. For more information, visit www.skype.com.

Options under Skype Voicemail™:

Option	Operation
Play	Play your Skype Voicemail™.
Details	View the details of your Skype Voicemail™ (Name, number, date, time, duration).
Delete	Delete your Skype Voicemail™.
Call	Return a call to the sender.
Send voice mail	Record a Skype Voicemail™ for the sender.
View profile	View profile of the sender.
Add to contacts	Add sender to your contact list (if the sender's contact is not already in your contact list)
My greetings	Play, record, or reset your Skype Voicemail™ greeting.

Creating a Skype Voicemail™ greeting

Skype Voicemail™ has a default voicemail greeting. You can also create your personal welcome greeting, which will be played back to callers when you are busy or offline.

IMPORTANT: You have to pay for a Skype voicemail subscription to use the Skype Voicemail™ service. For more information, visit www.skype.com.

- Press the **Menu** softkey.
△ ▢
- Press **int/ redial▷** or **calls▽** to select **Call History**, and then press the **Select** softkey.
△ ▢
- Press **calls▽** to select **Voice mails**, and then press the **Select** softkey.
△ ▢
- Press **calls▽** to select **Skype VM**, and then press the **Select** softkey.
△ ▢
- Select the desired Skype voicemail and press the **Options** softkey.
△ ▢
- Press **calls▽** to select **My Greetings**, and then press the **Select** softkey.
△ ▢
- Press **calls▽** to select **Options**, and then press the **Select** softkey.
△ ▢
- Press **calls▽** to select **Record**, and then press the **Select** softkey to start recording your new voicemail greeting. To stop recording, press the **OK** softkey.

Voicemail

Playing your Skype Voicemail™ greeting

- Press the **Menu** softkey.
△ ▢
- Press **int/ redial▷** or **calls▽** to select **Call History**, and then press the **Select** softkey.
△ ▢
- Press **calls▽** to select **Voice mails**, and then press the **Select** softkey.
△ ▢
- Press **calls▽** to select **Skype VM**, and then press the **Select** softkey.
△ ▢
- Select the desired Skype voicemail and press the **Options** softkey.
△ ▢
- Press **calls▽** to select **My Greetings**, and then press the **Select** softkey.
△ ▢
- Press **calls▽** to select **Options**, and then press the **Select** softkey.
△ ▢
- Press **calls▽** to select **Play**, and then press the **Select** softkey to start playing your voicemail greeting.

Resetting your Skype Voicemail™ greeting

- Press the **Menu** softkey.
△ ▢
- Press **int/ redial▷** or **calls▽** to select **Call History**, and then press the **Select** softkey.
△ ▢
- Press **calls▽** to select **Voice mails**, and then press the **Select** softkey.
△ ▢
- Press **calls▽** to select **Skype VM**, and then press the **Select** softkey.
△ ▢
- Select the desired Skype voicemail and press the **Options** softkey.
△ ▢
- Press **calls▽** to select **My Greetings**, and then press the **Select** softkey.
△ ▢
- Press **calls▽** to select **Options**, and then press the **Select** softkey.
△ ▢
- Press **calls▽** to select **Reset Default**, and then press the **Select** softkey to reset your voicemail greeting to the default greeting provided by Skype.











Network settings

Your network settings are automatically configured. This menu option is only for advanced users who want to modify their network configurations (e.g. assign a static IP address).

IMPORTANT:

 **Incorrect settings will affect Skype usage on this phone. We recommend that you consult your network administrator or service provider before making any changes to the network settings.**











Viewing your network settings

1. Press the **Menu** softkey.  
2. Press  **int/**  or **calls/**   to select **Settings**, and then press the **Select** softkey.
3. Press **calls/**   to select **Network**, and then press the **Select** softkey.
4. Press **calls/**   to select **Information**, and then press the **Select** softkey.
5. View the information, and then press the **OK** softkey when finished.

DHCP

By default, DHCP is activated. If you configure the network to use your own static IP address, DHCP will be deactivated. You can reactivate DHCP.











Activating DHCP:

1. Press the **Menu** softkey.  
2. Press  **int/**  or **calls/**   to select **Settings**, and then press the **Select** softkey.
3. Press **calls/**   to select **Network**, and then press the **Select** softkey.
4. Press **calls/**   to select **TCP/IP**, and then press the **Select** softkey.
5. An activation message is displayed. Press the **OK** softkey to confirm.
6. Your IP address is displayed and the new setting is saved.

PPPoE

If your Internet service provider requires you to use PPPoE, you can configure your user name and password for the PPPoE connection.

Activating PPPoE:













1. Press the **Menu** softkey.  
2. Press  **int/**  or **calls/**   to select **Settings**, and then press the **Select** softkey.
3. Press **calls/**   to select **Network**, and then press the **Select** softkey.
4. Press **calls/**   to select **PPPoE**, and then press the **Yes** softkey.
5. Enter the user name, and then press the **OK** softkey.

Network settings

6. Enter the password, and then press the **Enter** softkey.
7. An activation message is displayed. Press the **OK** softkey to confirm.
8. The new setting is saved.











Configuring a static IP

You can configure the network to use your own static IP.











1. Press the **Menu** softkey.  
2. Press  **int/**  or **calls/**   to select **Settings**, and then press the **Select** softkey.
3. Press **calls/**   to select **Network**, and then press the **Select** softkey.
4. Press **calls/**   to select **TCP/IP**, and then press the **Select** softkey.
5. Press **calls/**   to select **Static IP**, and then press the **Select** softkey.
6. A confirmation request is displayed. Press the **Yes** softkey to confirm.
7. Follow the on-screen instructions to finish configuring your network.

Configuring individual network settings

After configuring to use your own static IP, you can also make changes to other settings in the network such as subnet mask, gateway address, and DNS, etc.

1. Press the **Menu** softkey.  
2. Press  **int/**  or **calls/**   to select **Settings**, and then press the **Select** softkey.
3. Press **calls/**   to select **Network**, and then press the **Select** softkey.
4. Press **calls/**   to select **TCP/IP**, and then press the **Select** softkey.
5. Select the item you want to change, and then press the **Select** softkey.
6. Edit the information, and then press the **OK** softkey.
7. The setting is saved.

Resetting the network

1. Press the **Menu** softkey.  
2. Press  **int/**  or **calls/**   to select **Settings**, and then press the **Select** softkey.
3. Press **calls/**   to select **Network**, and then press the **Select** softkey.
4. Press **calls/**   to select **Reset network**, and then press the **Select** softkey.
5. A confirmation request is displayed. Press the **Yes** softkey to confirm.
6. The network setting is reset.

Software updates

Whenever there are software updates by Skype, you may need to update the software on your phone as well. You can check for updates, set the phone to automatically receive updates, and view the device information on your phone.

Checking for software updates

1. Press the **Menu** softkey.
2. Press **<int/realid>** or **calls** to select **Settings**, and then press the **Select** softkey.
3. Press **calls** to select **Advanced**, and then press the **Select** softkey.
4. Press **calls** to select **Software update**, and then press the **Select** softkey.
5. Press **calls** to select **Check for update**, and then press the **Select** softkey.
6. If there is a software update available, the screen displays the new Firmware SW version and Skype SW version. The message **"Start upgrade?"** also appears. Press the **Yes** softkey to start the upgrade.
6. The phone downloads the software update from Skype, and then restarts and automatically logs into the Skype account you were using.

Changing the auto update setting

1. Press the **Menu** softkey.
2. Press **<int/realid>** or **calls** to select **Settings**, and then press the **Select** softkey.
3. Press **calls** to select **Advanced**, and then press the **Select** softkey.
4. Press **calls** to select **Software update**, and then press the **Select** softkey.
5. Press **calls** to select **Auto update**, and then press the **Select** softkey.
6. Press **calls** to select **On** or **Off**, and then press the **Select** softkey.
7. The screen displays **"Successful"**. Press the **OK** softkey.
8. You hear a beep sound confirming that you turned on the auto update feature.

Viewing your device information

1. Press the **Menu** softkey.
2. Press **<int/realid>** or **calls** to select **Settings**, and then press the **Select** softkey.
3. Press **calls** to select **Advanced**, and then press the **Select** softkey.
4. Press **calls** to select **Software update**, and then press the **Select** softkey.
5. Press **calls** to select **Device information**, and then press the **Select** softkey.
6. The screen displays the device information (**Firmware version**, **Skype SW version**, **Product ID**, and **Hardware revision**).
7. Press the **OK** softkey when you finish viewing the device information.

Appendix Handset Menu Tree

Main Menu	Sub-menu 1	Sub-menu 2	Sub-menu 3
Contacts	Add contact	(go to Add Contact menu)	
	Online skype contact	Call Send voice mail View profile Rename Remove Block	
	Skypeout contact	Skypeout call Regular call Details Rename Remove Save to Phonebook	(go to Add Contact menu)
	Offline skype contact	Call Send voice mail View profile Rename Remove Block	
	Contact details not known	Request details Call Send voice mail View profile Rename Remove Block	
	Phonebook	Skypeout call Regular call Details Rename Remove Save as SkypeOut contact	(if offline, prompt to log in) (go to Add Contact menu)

Appendix

Call History	All events	Skype contact	Call
			Add to contacts
			Details
			Delete
			Delete all
		PSTN - SkypeOut contact/Shared phonebook	SkypeOut call
			Regular call
			Details
			Delete
			Delete all
		Unknown number to Contacts (Skype contacts)/Shared contacts	SkypeOut call
			Regular call
			Save number
			Details
			Delete
			Delete all
		No number provided	Details
			Delete
			Delete all
	Missed calls		
	Incoming calls		
	Outgoing calls		
	Voicemails	Skype VM	Play
			Details
			Delete
			Call
			Send voice mail
			View profile
			Add to contacts
			My greetings
		Landline VM	Call
			Clear VM/WI
	Contact requests		

Appendix

Skype Status	Switch user/Sign In	<New user> User name 1 User name 2 User name 3 User name 4 Create new account Clear user names	(This option is only available for the Sign In submenu, not the Switch user submenu) Delete all User name 1 User name 2 User name 3 User name 4 User name 5
	Online Status	Online Away Do not disturb Offline	
	My profile	Limited profile Private details	
	Change password		
	Sign out		
	Account status	Skype credit SkypeIn Voicemail	
Add Contact	Skype contact	Enter name:	Searching...
	SkypeOut contact	Enter number:	Enter name:
	Phonebook	Enter number:	Enter name:
	Phone	Preferred line	Regular call
Settings			SkypeOut call
			Always ask (by default)
		Handset name	
		Registration Language	English
			Francais
			Espanol

Appendix

Settings (continued)	Sounds	Ringtone	Skype call -> <i>list of melodies</i> Regular call -> <i>list of melodies</i>
		Ring volume	Intercom -> <i>list of melodies</i> (medium by default)
		Keypad tone	On Off
	Display	Confirmation	On Off
		Backlight	20 seconds 30 seconds (by default) 1 minute
		Screen saver	On Off
	Regular call	Area code	Number:
		Voice-mail	Voice-mail 1 or Voice-mail 2 -> Call , Define number , and Delete .
	Skype call	Voice-mail	Forward unanswered -> On or Off (by default)
		Call Forward	My greetings -> Play , Record , and Reset default Call forward: <On/Off> -> On or Off (by default) -> Enter number: Number: -> Enter number:

Appendix

Settings (continued)	Skype call (continued)	Block calls	Skype calls -> Allow calls from: My contacts or Anyone (by default)		
			Skypein calls -> Allow calls from: Anyone (by default), My contacts , or Known numbers		
			Blocked users -> List of blocked users		
			Time & Date	Time	Set time <time format>
			Time format	12 Hour 24 Hour	
			Date	Set date <date format>	
			Date format	DD/MM/YYYY MM/DD/YYYY YYYY/MM/DD	
			Date separator	. (e.g. 23:02:2008) / (e.g. 02/23/2008) (e.g. 2008/02/23)	
			Network	Information	List information for Static IP, IP address, Subnet mask, Gateway, Primary DNS, Secondary DNS, MAC Address
					DHCP (by default)
	Static IP (The following displays only if Static IP is enabled and DHCP is disabled: IP address, Subnet mask, Gateway, Primary DNS, Secondary DNS)				

Appendix

Settings (continued)	Network (continued)	PPPoE	Username	
Advanced	Network (continued)	Proxy	Password	
		Ports	On (The following displays only if Proxy is On: Host, Port, Authentication)	
		Reset network		
	Country	Canada		
		US		
	Reset settings	Reset all		
		Keep network		
	Software update	Check for update	Skype SW : v1.10	
			Firmware SW : V1.2	
			Start Upgrade ?	
		Auto Upgrade	On (by default)	
			Off	
		Device information	Firmware ver.:	
Skype SW : V1.10				
	Product ID:			
	Hardware rev:			

Appendix

Troubleshooting guide

if your telephone system is not operating properly, first try these general reset procedures:

1. Unplug all power adapters from the power outlets.
2. Disconnect the telephone line cord from the base or modular jack.
3. Remove the battery compartment covers and unplug all handset battery packs.
4. After a few minutes, re-install all handset battery packs, making sure that the connectors are snug and the wires are not pinched before replacing all battery compartment covers.
5. Plug the power adapters for the base and any chargers back into their power outlets. Be sure not to use outlets that are controlled by wall switches or timers.
6. Place all handsets in the chargers to charge without interruption for at least 30 minutes before use.
7. Plug the line cord into the telephone base or modular jack and verify operation.

For product assistance or for more information about accessories, visit our website at www.gephones.com or call our customer service center at **1-877-394-9775 (USA)** or **1-877-395-7907 (Canada)**.

Appendix

General Performance

Problem	Cause/solution
Cannot hear a dial tone	<ul style="list-style-type: none"> • Increase the volume on the handset. • Disconnect the telephone line cord from the base unit and connect it to a known working telephone. If the known working telephone operates properly, contact our customer support center for warranty information.
Handset does not ring	<ul style="list-style-type: none"> • The ringer may be off. Increase the ringer volume. • Make sure your handset is charged.
You experience audible static, noise, or fading in and out	<ul style="list-style-type: none"> • The handset may be near the end of range limit. Move the handset closer to the base unit. • If you are using a line with DSL service, make sure you have properly installed the DSL filters supplied by your service provider. • Try to relocate the base unit and use the handset away from sources of electrical interference.

Caller ID

Problem	Cause/solution
Caller-ID information is not displayed	<ul style="list-style-type: none"> • You must subscribe to Caller ID service from your service provider/telephone company. • Make sure the base unit is plugged directly into a telephone modular jack. If you are using a line with DSL service, make sure you have properly installed the DSL filters supplied by your service provider.
While on a call, new caller-ID information is not displayed	<ul style="list-style-type: none"> • You must subscribe to Caller ID with Call Waiting service from your service provider/telephone company.

Appendix

Skype

Problem	Cause/solution
Cannot sign in to or call through Skype	<ul style="list-style-type: none"> • Skype does not accept your Skype ID and/or password. • Verify that you are using the correct Skype ID and password — these fields are case sensitive. • The software needs to be updated to the latest version. • For more information on how to check for software updates, turn on automatic software updates, or view your device information, refer to the section <i>Software updates</i> on page 55.
I cannot make a Skype call	<ul style="list-style-type: none"> • The Ethernet cable is not connected. • Check that the Ethernet cable is properly connected to the telephone base station and the LAN port on your broadband connection (modem, router, hub, switch, etc.) • The router or the modem is not turned on. Turn on the power for the modem or router and reset the base station. • The base station cannot retrieve the IP address. In Network settings, check that the IP address corresponds to the IP address of your Internet connection or you are behind a proxy server. Check the user manual for the proxy settings for guidance. • You are not signed in as a Skype user. • Go to Skype Status menu and sign in as a Skype user. For more information, refer to the section <i>Signing into Skype</i> on page 19.

Appendix Base and Handset

Problem	Cause/solution
No display	<ul style="list-style-type: none"> The batteries are discharged. Charge or replace the batteries.
Handset is not registering	<ul style="list-style-type: none"> Telephone base station is not ready for registration. Reset the telephone base station by plugging and unplugging the power adapter. The telephone base station is not connected. Make sure the power supply is properly connected to the telephone base station and that it is plugged into a power socket.
No connection between handset and base station	<ul style="list-style-type: none"> You are out of range of the telephone base station. Move closer to the telephone base station. Make sure that the handset is registered. Make sure that the telephone base station is connected to a power supply.
Handset on the charging cradle does not charge	<ul style="list-style-type: none"> Make sure that the power adapter of the charging cradle is plugged into an active power outlet. Make sure the handset is placed properly in the charging cradle. Check that the batteries are inserted properly into the handset.
Handset does not ring	<ul style="list-style-type: none"> The Skype status is set to <i>offline</i> or <i>do not disturb</i>. Set your Skype status to <i>online</i>. The handset ringer may be off. Increase the ringer volume. The handset may be too far away from the telephone base station. Move the handset closer to the telephone base station.

Appendix Frequently Asked Questions

The following is a list of frequently asked questions about your phone.

Question	Answer
What is a Skype phone?	<ul style="list-style-type: none"> Your system combines two phones in one unit, allowing you to use Skype, SkypeOut/SkypeIn as well as traditional telephony via PSTN.
Is it easy to connect my phone to the Internet?	<ul style="list-style-type: none"> Yes. It only requires you to connect the telephone base station to a power outlet and to your Internet connection. However, you might need a router/switch/hub if you want to connect more units to the same Internet connection.
Are there any special requirements on my Internet connection?	<ul style="list-style-type: none"> Yes. You have to use an Internet connection that is "Always On". Some broadband connections demand that you log onto the Internet every time you wish to use it, and the connection will automatically close after some time of inactivity. Your Skype phone does not work with such connections, only with "Always On" connections. Contact your Internet provider and get an "Always On" connection.
Can my phone be updated with new software?	<ul style="list-style-type: none"> Yes. The software on your phone can be updated to always give you access to the latest features.
What Skype services does my phone support?	<ul style="list-style-type: none"> Your phone supports Skype, SkypeOut, SkypeIn, and Skype Voicemail™.

Appendix

<p>What Skype features does my phone support?</p>	<ul style="list-style-type: none"> • Superior Skype sound quality • Calling via Internet: Skype to other Skype users • Calling via SkypeOut to ordinary telephone numbers • Works with Skypeln - enables reception of calls from ordinary telephone numbers (PSTN) • Works with Skype Voicemail™ (view, play, delete, record personal greeting) • Skype conference call (invited party) • View, search, and call Skype contact list • Skype Call Forwarding • Skype Call Waiting • Caller Identity with Skype name of the calling party • Set your Skype online status (Offline, Online, etc.) • View the status of your Skype contacts on the handset display • View Call History or Skype and ordinary calls • Contact list • Create a new Skype account • Manual and automatic sign-in to Skype account • Edit My Profile • View Skype Credits
<p>What is SkypeOut?</p>	<ul style="list-style-type: none"> • SkypeOut allows you to call ordinary phones and mobile phones at very competitive prices. There might be restrictions applying to calls to special service numbers in certain countries.
<p>What is the price of a call to ordinary phones and mobile phones via SkypeOut?</p>	<ul style="list-style-type: none"> • Check the latest rates and plans at http://www.skype.com/intl/en/prices/
<p>Is it expensive to use Skype with a volume based Internet connection?</p>	<ul style="list-style-type: none"> • No. Skype does not take up much bandwidth. • On average, Skype uses 0-0.5 Kbps during standby and 3-16 Kbps during calls.

Appendix

<p>Does Skype work behind a NAT (network address translation) router?</p>	<ul style="list-style-type: none"> • Yes. Skype works behind most NAT routers. We recommend using a PSP friendly router.
<p>Does my Skype phone support several languages in the menu?</p>	<ul style="list-style-type: none"> • Yes, you can choose between 3 languages: English, French, and Spanish.
<p>Does my Skype phone support connections via proxy servers and firewalls with approval?</p>	<ul style="list-style-type: none"> • Yes. Your phone supports HTTP or HTTPS proxies, authenticating HTTPS/SSL and SOCKS5 proxies.
<p>Can I use the Skype phone as a conference phone?</p>	<ul style="list-style-type: none"> • Yes. Your phone has a handsfree speakerphone, and can manage a 3-party call between landline and Skype calls.
<p>Is it safe to call via Skype?</p>	<ul style="list-style-type: none"> • Yes. All your Skype calls are encrypted, thus increasing the safety and protection of personal information.
<p>Is it safe to have my user data on the Skype server?</p>	<ul style="list-style-type: none"> • Yes. All your profile data and your contacts are located on a Skype Server, not on your phone.
<p>Can I make an emergency call via Skype?</p>	<ul style="list-style-type: none"> • No. Skype does not allow emergency calls. Emergency calls can only be made through the landline.
<p>Can I protect myself against harassment via Skype?</p>	<ul style="list-style-type: none"> • Yes. You can always block certain persons from contacting you via Skype. You can also prevent groups of persons from contacting you.
<p>Can my phone use a static IP address?</p>	<ul style="list-style-type: none"> • Yes. You may configure a static IP address.
<p>Can I call ordinary phones and mobile phones via Skype?</p>	<ul style="list-style-type: none"> • Yes. However, this requires that your Skype account supports SkypeOut, a service you can buy at www.skype.com. With SkypeOut you can call ordinary phones and mobile phones at very competitive prices.

Appendix

Can ordinary phones and mobile phones call me via Skype?	<ul style="list-style-type: none"> • Yes. However, this requires that your Skype account supports SkypeIn, a service you can buy at www.skype.com. With SkypeIn you get an ordinary phone number that your contacts can call.
Can I take my Skype phone with me and use it in another country?	<ul style="list-style-type: none"> • Yes. Your phone can be connected to the Internet anywhere with an active Internet connection. The landline connection will also be working in other countries.
Is the handset GAP (Generic Access Profile) compatible?	<ul style="list-style-type: none"> • Your phone uses a number of features specific to Skype. Therefore, we highly recommend that you do not use handsets other than those specified for use with your phone system.
Can I use several handsets with the same base station?	<ul style="list-style-type: none"> • Yes. You will be able to use up to 4 handsets (model number 31590) which can all take advantage of the same Skype account.
Can I divert an incoming Skype call to a different number?	<ul style="list-style-type: none"> • Yes. However, this requires you to have Skype credits on your Skype account.
Can I check my Skype credit status?	<ul style="list-style-type: none"> • Yes, you can check your Skype credits from your handset.
Does my telephone system support Skype Voicemail?	<ul style="list-style-type: none"> • Yes, provided your Skype account supports Voicemail, a service that you can buy via www.skype.com. This allows you to divert all incoming Skype calls to your voicemail.
Can I send instant messages (chat) via my phone.	<ul style="list-style-type: none"> • No.
Can I see my Skype account profile picture on my phone?	<ul style="list-style-type: none"> • No.
How long is the talk time on fully charged batteries?	<ul style="list-style-type: none"> • About 10 hours.

Appendix

How long is the stand by time on fully charged batteries?	<ul style="list-style-type: none"> • Around 144 hours (6 days).
Do I need a computer?	<ul style="list-style-type: none"> • No. A computer is not needed for the operation of the telephone system. However, Skype account management (such as buying Skype Credit and signing up for advanced features) must be done online using a computer.
How many Skype contacts does the Skype phone support?	<ul style="list-style-type: none"> • 200.
How long does it take to fully charge the handset batteries?	<ul style="list-style-type: none"> • The handset batteries are fully charged in 12 to 15 hours.

General Product Care

- Avoid dropping the handset, as well as other rough treatment to the phone.
- Clean the phone only with a dry soft cloth.
- Never use cleaning agents, paint thinner, abrasive powder, alcohol, or other chemical products to clean the unit. Doing so will damage the unit.
- Retain the original packaging in case you need to ship the phone at a later date.

Important Safety Instructions

Some of the following information may not apply to your particular product; however, when using telephone equipment, basic safety precautions should always be followed to reduce the risk of fire, electric shock and injury to persons, including the following:

1. Read and understand all instructions.
2. Follow all warnings and instructions marked on the product.
3. Unplug this product from the wall outlet before cleaning. Do not use liquid cleaners or aerosol cleaners. Use a damp cloth for cleaning.
4. Telephones should not be used while you are in a bathtub, shower or pool. Immersion of the telephone or handset in water could cause an electrical shock.
5. Slots and openings in the cabinet back or bottom are provided for ventilation, to protect it from overheating. Do not block or cover these openings. Do not block the openings by placing the product on a bed, sofa, rug, or other similar surface. Do not place this product in a built-in installation unless proper ventilation is provided.
6. Only operate this product from the type of power source indicated on the marking label. If

Appendix

you are not sure of the type of power supply to your home, consult your dealer or local power company.

7. Plug the adaptor into an easily accessible electrical outlet near the equipment.
8. Do not allow anything to rest on the power cord. Do not locate this product where the cord will be abused by persons walking on it.
9. Do not overload wall outlets and extension cords as this can result in the risk of fire or electric shock.
10. Never push objects of any kind into this product through cabinet slots as they may touch dangerous voltage points or short out parts that could result in a risk of fire or electric shock.
11. Never spill liquid of any kind on the product.
12. To reduce the risk of electric shock, do not disassemble this product. Opening or removing covers may expose you to dangerous voltages or other risks. Incorrect reassembly can cause electric shock when the appliance is subsequently used.
13. Do not expose the product to extreme temperatures such as areas near a hot radiator, stove or in a hot car. Do not place product upon other consumer electronic products such as; computer monitors, power amplifiers, etc.
14. Do not place lighted candles, cigarettes, cigars, etc., on or near the telephone.
15. Never touch uninsulated telephone wires or terminals unless the telephone line has been disconnected at the network interface.
16. Never install or modify telephone wiring during a lightning storm.
17. Never install jacks or telephones in wet locations.
18. Use caution when installing or modifying telephone lines to prevent electrical shock and/or fire.
19. Under the following conditions, unplug this product from the wall outlet and refer servicing to qualified service personnel:
 - A. The power supply cord or plug is damaged or frayed.
 - B. The product has been exposed to rain or water.
 - C. The product does not operate normally by following the operating instructions.
 - D. The product's cabinet has been damaged.
 - E. The product exhibits a distinct change in performance.
20. Avoid using a telephone during an electrical-storm. There may be a remote risk of electric shock from lightning.
21. Do not use the telephone to report a gas leak in the vicinity of the leak.
22. Do not place this product on an unstable cart, stand, or table. The product may fall, causing serious damage to the product.
23. Only use attachments/accessories specified by the manufacturer.

72

Appendix

24. Unplug this apparatus during lightning storms or when unused for long periods of time.

IF YOUR PRODUCT UTILIZES BATTERIES, THE FOLLOWING ADDITIONAL PRECAUTIONS SHOULD BE OBSERVED:

1. Use only the type and size battery(ies) specified in the user's guide.
2. Do not use this product if the battery door is removed or missing.
3. Replace batteries that appear to be swollen or have damaged wiring.
4. Do not dispose of the battery(ies) in fire. They may explode. Check with local codes for possible special disposal instructions.
5. Do not open or mutilate the battery(ies). Released electrolyte is corrosive and may cause damage to the eyes or skin. It may be toxic if swallowed.
6. Exercise care in handling battery(ies) in order not to short out the battery(ies) with conducting materials such as rings, bracelets, and keys. The battery(ies) or conductor may overheat and cause burns.
7. Do not attempt to recharge the battery(ies) provided with or identified for use with this product that are not rechargeable. The battery(ies) may leak corrosive electrolyte or explode.
8. Do not attempt to rejuvenate the battery(ies) provided with or identified for use with this product by heating them. Sudden release of the battery(ies) electrolyte may occur causing burns or irritation to eyes or skin.
9. When replacing battery(ies), all batteries should be replaced at the same time. Mixing fresh and discharged batteries could increase internal cell pressure and rupture the discharged battery(ies). (Applies to products employing more than one separately replaceable primary battery.)
10. When inserting battery(ies) into this product, the proper polarity or direction must be observed. Reverse insertion of battery(ies) may result in leakage or explosion.
11. When inserting battery(ies) into this product, do not twist or pinch the wires or allow wires to become pinched in battery door.
12. If storing over 30 days, remove battery(ies) from this product because the battery(ies) could leak and damage the product.
13. Discard "dead" battery(ies) as soon as possible since "dead" batteries are more likely to leak in a product.
14. Do not store this product, or the battery(ies) provided with or identified for use with this product, in high-temperature areas. Batteries that are stored in a freezer or refrigerator for the purpose of extending shelf life should be protected from condensation during storage and defrosting. Batteries should be stabilized at room temperature prior to use after cold storage.
15. If your product uses rechargeable battery(ies), charge the battery(ies) only in accordance with the instructions and limitation specified in the user's guide.
16. Battery safety precautions

73

Appendix

- Do not burn, disassemble, mutilate, or puncture. Like other batteries of this type, toxic materials could be released which might cause injury to persons or property damage.
- To reduce the risk of fire or personal injury, use only the supplied battery or replacement battery.
- Keep batteries out of the reach of children.
- Remove batteries if storing over 30 days.

Use only the supplied rechargeable battery or replacement battery. Visit our website at www.gephones.com to order a replacement battery if necessary.

SAVE THESE INSTRUCTIONS

Appendix FCC Parts 15, 68 and ACTA

This equipment is in compliance with parts 15 and 68, FCC Rules and Regulations and the Technical Requirements for Telephone Terminal Equipment published by ACTA.

On the bottom of this equipment is a label indicating, among other information, the US number and Ringer Equivalence Number (REN) for the equipment. You must, upon request, provide this information to your telephone company.

The REN is useful in determining the number of devices you may connect to your telephone line and still have all of these devices ring when your telephone number is called. In most (but not all) areas, the sum of the RENs of all devices connected to one line should not exceed 5.

A plug and jack used to connect this equipment to the premises wiring and telephone network must comply with the applicable FCC Part 68 rules and requirements adopted by the ACTA. A compliant telephone cord and modular plug is provided with this product. It is designed to be connected to a compatible modular jack that is also compliant. See installation instructions for details.

This equipment is not intended to be used with Party Lines. If your home has specially wired alarm equipment connected to the telephone line, ensure the installation of this product does not disable your alarm equipment. If you have questions about what will disable alarm equipment, consult your telephone company or a qualified installer.

If this equipment is malfunctioning, it should be unplugged from the modular jack until the problem is corrected. Repairs to this equipment can only be made by the manufacturer or its authorized agents. For information on repair procedures, follow the instructions provided with the limited warranty. Should your equipment cause trouble on your line which may harm the telephone network, the telephone company shall, where practicable, notify you that temporary discontinuance of service may be required. Where prior notice is not practical and the circumstances warrant such action, the telephone company may temporarily discontinue service immediately. In case of such temporary discontinuance, the telephone company must: (1) promptly notify you of such temporary discontinuance; (2) afford you the opportunity to correct the situation; and (3) inform you of your right to bring a complaint to the Commission pursuant to procedures set forth in Subpart E of Part 68, FCC Rules and Regulations.

The telephone company may make changes in its communications facilities, equipment, operations or procedures where such action is required in the operation of its business and not inconsistent with FCC Rules and Regulations. If these changes are expected to affect the use or performance of your telephone equipment, the telephone company must give you adequate notice, in writing, to allow you to maintain uninterrupted service. This device complies with Part 15 of the FCC Rules. Operation is subject to the following two conditions: (1) This device may not cause harmful interference; and (2) This device must accept any interference received, including interference that may cause undesired operation. This equipment has been tested and found to comply with the limits for a Class B digital device, pursuant to Part 15 of the FCC Rules. These limits are designed to provide reasonable protection against harmful interference in a residential installation.

This equipment generates, uses, and can radiate radio frequency energy and, if not installed

Appendix

and used in accordance with the instructions, may cause harmful interference to radio communications. However, there is no guarantee that interference will not occur in a particular installation.

Privacy of Communications may not be ensured when using this product.

If this equipment does cause harmful interference to radio or television reception, which can be determined by turning the equipment off and on, the user is encouraged to try to correct the interference by one or more of the following measures:

- Reorient or relocate the receiving antenna (that is, the antenna for radio or television that is "receiving" the interference).
- Reorient or relocate and increase the separation between the telecommunications equipment and receiving antenna.
- Connect the telecommunications equipment into an outlet on a circuit different from that to which the receiving antenna is connected.

If these measures do not eliminate the interference, please consult an experienced radio/television technician for additional suggestions. **The changes or modifications not expressly approved by the party responsible for compliance could void the user's authority to operate the equipment.**

FCC RF Radiation Exposure Statement

The installation of the base unit should allow at least 20 centimeter between the base and persons to be in compliance with FCC RF exposure guidelines. For body worn operation, the portable part (handset) has been tested and meets FCC RF exposure guidelines.

This device must not be co-located or operating in conjunction with any other antenna or transmitter. The changes or modifications not expressly approved by the party responsible for compliance could void the user's authority to operate the equipment.

Hearing Aid Compatibility (HAC)

This equipment meets FCC standards for Hearing Aid Compatibility

If this product has a memory dialing feature, you may choose to store emergency phone numbers such as police, fire or medical within the memory locations. If you do store or emergency numbers, we suggest you also write these numbers down so that you can still dial the number manually of the memory dialing fails.

This feature is included as a convenience only. The manufacturer assumes no responsibility for customer reliance on the memory feature of this product.

IC Statement

This device complies with Industry Canada license-exempt RSS standard(s). Operation is Subject to the following two conditions: (1) this device may not cause interference, and (2) this device must accept any interference, including interference that may cause undesired operation of the device.

Testing emergency telephone numbers is not recommended. However, if you choose to make a test call to an emergency number, you should:

76

Appendix

- Remain on the line and provide an explanation for the call before you hang up.
- Only make a non emergency test call during off-peak hours during early mornings or late evenings.

To ensure user safety, the FCC has established criteria for the amount of radio frequency energy that can be safely absorbed by a user or bystander according to the intended usage of the equipment. This equipment has been tested and found to comply with the FCC criteria. The handset may be safely held against the ear of the user. The telephone base should be installed and used such that parts of the users body other than the handset are maintained at a distance of approximately 8 inches (20 cm) or more.

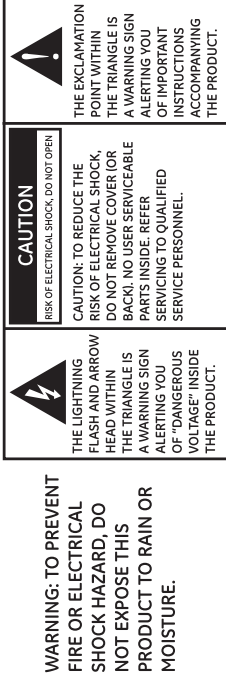

This product meets ENERGY STAR program requirements for energy conservation. Selecting ENERGY STAR products is a responsible way to save energy and money while protecting our environment. ENERGY STAR is a U.S. registered mark.



The RBRC seal on the battery used in your product indicates that CCT is participating in the Rechargeable Battery Recycling Corporation (RBRC) program to collect and recycle rechargeable batteries. We encourage you to explore the easy recycling options available to you in your area. For more information visit www.rbrc.org or call 1-800-8-BATTERY or contact your local recycling center.

In accordance with California Proposition 65, CCT advises that nickel is a chemical known to the State of California to cause cancer.



This product has reduced magnetic noise interference with most T-coil equipped hearing aids and cochlear implants. The TIA-1083 Compliant Logo is a trademark of the Telecommunications Industry Association. Used under license.

Trademarks

Skype, Skypein, SkypeOut, the Skype Logo and the S logo are trademarks of Skype Limited.

Appendix

One Year Limited Warranty

CCT Tech USA Inc. (CCT), the licensed manufacturer of this GE® branded product, warrants this product to the original retail purchaser to be free of material and/or workmanship defects for a period of one year after the date of original retail purchase. Proof of the original purchase is required to obtain a remedy under this limited warranty and the product must be returned to CCT at your expense.

During the limited warranty period, CCT or its authorized service representative will repair or replace at CCT's option, without charge, a materially defective product. We may use new or refurbished replacement parts. If we replace the product, it may be with a new or refurbished product of same or similar design. CCT may keep any removed or defective parts, and/or replaced product. The repaired or replaced product is warranted for the remainder of the original warranty or 90 days, whichever is greater. Repair or replacement of this product at CCT's option is your exclusive remedy.

This limited warranty only applies to products purchased, used and serviced in the United States and its territories, or Puerto Rico. If you purchased this product outside of the United States, its territories or Puerto Rico, contact your dealer for service information.

This is the only warranty applicable to this product. **ALL OTHER WARRANTIES EXPRESS OR IMPLIED INCLUDING ALL IMPLIED WARRANTIES OF MERCHANTABILITY OF FITNESS FOR A PARTICULAR PURPOSE ARE HEREBY DISCLAIMED. CCT IS NOT LIABLE FOR ANY INDIRECT, INCIDENTAL, CONSEQUENTIAL OR SIMILAR DAMAGES INCLUDING, BUT NOT LIMITED TO, LOST PROFITS OR REVENUE, INABILITY TO USE THE PRODUCT, OR ANY OTHER ASSOCIATED EQUIPMENT, THE COST OF SUBSTITUTE EQUIPMENT, AND ANY CLAIMS BY THIRD PARTIES RESULTING FROM THE USE OF THIS PRODUCT.**

This warranty gives you specific legal rights, and you may have other rights that vary from state to state. Some states do not allow the exclusion or limitation of incidental or consequential damages, so the limitations or exclusions stated above may not apply.

What is NOT Covered Under This Limited Warranty

- Normal wear and tear or cosmetic damage.
- Damage due to accidents, misuse, physical force, improper installation or operation, mishandling, neglect, fire, heat, water, humidity, liquids, insect infestation, or other intrusion.
- Products that have been repaired, altered or modified by anyone other than CCT or its authorized service representative.
- Problems caused by signal conditions, radio interference, network reliability, cable or antenna systems.
- Damage caused by use of non CCT accessories or misapplication.
- Products whose serial numbers have been removed, altered or rendered illegible.
- Products purchased, shipped from, used or serviced outside the United States.
- Batteries.
- Products used for business, commercial or institutional purposes.

78

Appendix

- Damage caused by acts of nature such as, but not limited to, lightning damage.
- Products returned without valid proof of purchase.

How To Obtain Warranty Service

Call our customer service center at **1-877-394-9775 (USA)** or **1-877-395-7907 (Canada)**. Our customer service specialist will assist you in obtaining warranty service. Please have a paper and pencil handy to write down the warranty service return instructions.

-OR-

You may visit our web site at **www.gephones.com** for troubleshooting, FAQs, and information on warranty service.

Accessibility

If you have a disability or questions about how CCT's products can accommodate persons with disabilities, please call our customer service center at **1-877-394-9775 (USA)** or **1-877-395-7907 (Canada)**. When calling, please let our specialists know that you have an inquiry about accessibility so your call is routed properly.

79

Appendix Technical specification

Radio frequency band	DECT 6.0 (1910MHz to 1920MHz)
Telephone base input voltage and current	6VDC 500mA
Handset standby time	Around 6 days (144 hours)
Handset talk time	Around 10 hours
Handset charger input voltage and current	6VAC 300mA
Battery specifications	2.4V 550mAh, Ni-MH

Appendix Index

A	<ul style="list-style-type: none"> Accessibility 79 Accessing the call history 47 Account status <ul style="list-style-type: none"> SkypeIn 20 Skype Voicemail 20 Answering a call 31 Area code 38 Assigning a preferred line 27 	<ul style="list-style-type: none"> Making a SkypeID call 31 PSTN contact 42 Removing 44 Renaming 44 Skype ID contact 41 SkypeOut contact 42 Unblocking 44 Contact list <ul style="list-style-type: none"> Accessing 42 Searching a contact 43 Viewing 42 Contact request 45 Accepting 45 Blocking 46 Declining 46 Viewing the details 45
B	<ul style="list-style-type: none"> Battery <ul style="list-style-type: none"> Charging 11 Block user list <ul style="list-style-type: none"> Blocking 38 Viewing 38 	
C	<ul style="list-style-type: none"> Caller ID 33 Call history <ul style="list-style-type: none"> Accessing 47 Deleting all entries 49 Deleting an entry 49 Making a call from 48 Options 47 Saving to contact list 48 Viewing 47 Call Waiting 33 Changing the handset display language 28 Changing the landline country settings 27 Changing your online status 18 Changing your password 19 Characters table 22 Configuring a static IP 54 Confirmation 25 Contact <ul style="list-style-type: none"> Blocking 44 	<ul style="list-style-type: none"> Date 26 Date format 26 Date separator 26 Device information 55 DHCP 53 Display icons <ul style="list-style-type: none"> Handset screen 10, 40 Skype 13
D		
E		<ul style="list-style-type: none"> Emergency calls 12, 27 Ending a call 32
F		<ul style="list-style-type: none"> FAQ (Frequently asked questions) 66 FCC 74
G		<ul style="list-style-type: none"> General product care 70

Appendix

H

- Handset
 - Backlight 28
 - Layout 9
 - Naming 29
 - Paging 29
- I
 - Important safety instructions 70
 - Installing the handset battery 6
 - Installing the handset charger 7
 - Installing the telephone base 4
 - Intercom 34
 - Answering an incoming call 34
 - Making an external call 34

K

- Keypad tone 24

M

- Making a regular call 30
- Menu tree 56
- Microphone 32
- Missed calls
 - Adding to contacts 32
 - Calling 32
 - Delete 32
 - Delete all 32
 - Details 32
 - Muting a call 32

N

- Network settings
 - Configuring 54
 - Resetting 54
 - Viewing 53

O

- Online status
 - Away 18
 - Do not disturb 18
 - Offline 18
 - Online 18

P

- Phonebook 43
- Phonebook entry
 - Saving as SkypeOut contact 43
- PPPoE 53
- Pre-dialing
 - Regular call 30
 - Skype ID call 30
 - SkypeOut call 30
 - Preferred line 27

R

- Registering your handset 28
- Regular call
 - Making 30
 - Pre-dialing 30
- Resetting the phone 33
- Ringtone 24
- Ring volume
 - Setting your country 24

S

- Screen saver 29
- Setting Skype Voicemail greeting 37
- Setting the screen saver 29
- Signing out of Skype 19
- Skype
 - calls 12
 - Display icons 10
 - Signing out 19
 - Trademarks 76
 - Voicemail 2, 20

82

Appendix

- Skype features
 - SkypeIn 13
 - SkypeOut 13
 - Skype Voicemail 13
 - Skype ID call
 - Blocking 37
 - Forwarding 36
 - Pre-dialing 30
 - SkypeIn call
 - Blocking 37
 - SkypeOut call
 - Pre-dialing 30
 - Skype profile
 - Private 18
 - Public 18
 - Skype Voicemail 13, 20, 51
 - Creating a greeting 51
 - Resetting greeting 52
 - Setting greeting 37
- Software updates
 - Checking 55
 - Viewing device information 55
- Speakerphone 32
- Switching Skype user ID 17

T

- Telephone base layout 8
- Three-way Conference call 35
- Time 25
- Time format 25
- Transferring a call 35
- Troubleshooting guide 62

V

- Voicemail
 - Calling 50
 - Deleting messages from 50
 - Landline voicemail 50
 - Sending to Skype ID contact 43
 - Voicemails service center
 - Setting your country 50

83

- Voice message waiting indicator 34
- Volume control
 - Handset earpiece 32
 - Speakerphone 32

W

- Warranty 77

Appendix

Skype account information

Skype account information

After you have created your Skype username and password, record them in the spaces provided.

Account Username/ID Password

visit our website:

www.gephones.com



is a trademark of General Electric Company and is under license by
CCT Tech USA Inc., Irving, TX 75039

Model 31591
P/N: 480-01240-000002
Version 1.07/2011
Printed in China

©2011 CCT Tech USA Inc.
Distributed in the U.S.A. by
CCT Tech USA Inc.