

# CONTENTS

<b>Important Safety Instructions</b>	<b>2</b>
<b>Safety Information</b>	<b>3</b>
<b>Preparation</b>	<b>4</b>
What's Included	4
Front View	5
Rear View	6
Installing the Base Stand	7
Removing the Stand for Wall-Mounting	7
Remote Control	8
<b>Connecting External Devices</b>	<b>9</b>
<b>Basic Operations</b>	<b>10</b>
Initial Setup	10
Menu Operation	12
Picture	13
Sound	15
Function	16
Time	18
Option	19
LOCK	20
Channel	21
<b>Network Setting</b>	<b>24</b>
Internet	27
<b>Digital Media Palyer</b>	<b>32</b>
Introduction	32
<b>Parental Control</b>	<b>33</b>
<b>Troubleshooting</b>	<b>35</b>
<b>Specification</b>	<b>37</b>
<b>Limited Warranty</b>	<b>38</b>

## IMPORTANT SAFETY INSTRUCTIONS

- **Read these instructions** – All the safety and operating instructions should be read before this product is operated.
- **Keep these instructions** – The safety and operating instructions should be retained for future reference.
- **Heed all warnings** – All warnings on the appliance and in the operating instructions should be adhered to.
- **Follow all instructions** – All operating and use instructions should be followed.
- **Do not use this apparatus near water** – The appliance should not be used near water or moisture – for example, in a wet basement or near a swimming pool, and the like.
- Clean only with dry cloth.
- **Do not** block any ventilation openings. Install in accordance with the manufacturer's instructions.
- **Do not** install near any heat sources such as radiators, heat registers, stoves, or other apparatus (including amplifiers) that produce heat.
- **Do not** defeat the safety purpose of the polarized or grounding-type plug. A polarized plug has two blades with one wider than the other. A grounding-type plug has two blades and a third grounding prong. The wide blade or the third prong are provided for your safety. If the provided plug does not fit into your outlet, consult an electrician for replacement of the obsolete outlet.
- Protect the power cord from being walked on or pinched particularly at plugs, convenience receptacles, and the point where they exit from the apparatus.
- Only use attachments/accessories specified by the manufacturer.
- Use only with the cart, stand, tripod, bracket, or table specified by the manufacturer, or sold with the apparatus. When a cart is used, use caution when moving the cart/apparatus combination to avoid injury from tip-over.



- Unplug this apparatus during lightning storms or when unused for long periods of time.

- Refer all servicing to qualified service personnel. Servicing is required when the apparatus has been damaged in any way, such as the power-supply cord or plug is damaged, liquid has been spilled or objects have fallen into the apparatus, the apparatus has been exposed to rain or moisture, does not operate normally, or has been dropped.
- Please keep the unit in a well-ventilated environment.

**WARNING:** To reduce the risk of fire or electric shock, do not expose this apparatus to rain or moisture. The apparatus should not be exposed to dripping or splashing. Objects filled with liquids, such as vases should not be placed on apparatus.

**WARNING:** The batteries shall not be exposed to excessive heat such as sunshine, fire or the like.

**WARNING:** The mains plug is used as disconnect device, the disconnect device shall remain readily operable.

**WARNING:** To reduce the risk of electric shock, do not remove cover (or back) as there are no user-serviceable parts inside. Refer servicing to qualified personnel.

**WARNING:** To prevent injury, this apparatus must be securely attached to the wall in accordance with the installation instruction.



 This lightning flash with arrowhead symbol within an equilateral triangle is intended to alert the user to the presence of non-insulated "dangerous voltage" within the product's enclosure that may be of sufficient magnitude to constitute a risk of electric shock.

 The exclamation point within an equilateral triangle is intended to alert the user to the presence of important operating and maintenance instructions in the literature accompanying the appliance.

 This equipment is a Class II or double insulated electrical appliance. It has been designed in such a way that it does not require a safety connection to electrical earth.

1. The ventilation should not be impeded by covering the ventilation openings with items, such as newspapers, table-cloths, curtains, etc.;
2. No naked flame sources, such as lighted candles, should be placed on the apparatus;
3. The use of apparatus in moderate climates.

## SAFETY INFORMATION

To ensure reliable and safe operation of this equipment, please carefully read all the instructions in this user guide, especially the safety information below.

### Electrical Safety

- The TV set should only be connected to a main power supply with voltage that matches the label at the rear of the product.
- To prevent overload, do not share the same power supply socket with too many other electronic components.
- Do not place any connecting wires where they may be stepped on or tripped over.
- Do not place heavy items on any connecting wire, which may damage the wire.
- Hold the main plug, not the wires, when removing from a socket.
- During a thunderstorm or when not in using the television for long periods, turn off the power switch on the back of the television.
- Do not allow water or moisture to enter the TV or power adapter. Do NOT use in wet, moist areas, such as bathrooms, steamy kitchens or near swimming pools.
- Pull the plug out immediately, and seek professional help if the main plug or cable is damaged, liquid is spilled onto the set, if the TV set accidentally exposed to water or moisture, if anything accidentally penetrates the ventilation slots or if the TV set does not work normally.
- Do not remove the safety covers. There are no user serviceable parts inside. Trying to service the unit yourself is dangerous and may invalidate the product's warranty. Qualified personnel must only service this apparatus.
- To avoid a battery leakage, remove batteries from the remote control, when the remote is not use for long period, or when the batteries are exhausted.
- Do not break open or throw exhausted batteries into a fire.
- For best results, use type AAA (example-alkaline, carbon-zinc, etc.) batteries.
- Install only new batteries of the same type in your product.
- Failure to insert batteries in the correct polarity, as indicated in the battery compartment, may shorten the life of the batteries or cause batteries to leak.
- Do not mix old and new batteries.
- Do not mix Alkaline, Standard (Carbon-Zinc) or Rechargeable (Nickel Cadmium) or (Nickel Metal Hydride) batteries.
- Batteries should be recycled or disposed of as per state and local guidelines.
- Do not attempt to recharge disposable batteries.
- Do not short circuit battery terminals.
- Keep away from children.

### Physical Safety

- Do not block ventilation slots in the back cover. You may place the TV in a cabinet, but ensure at least 5cm (2") clearance all around.
- Do not tap or shake the TV screen, or you may damage the internal circuits. Take good care of the remote control.
- To clean the TV use a soft dry cloth. Do not use solvents or petroleum based fluids.
- Do not install near any heat sources such as radiators, heat registers, stoves or other apparatus (including amplifiers) that produce heat.
- Do not defeat the safety purpose of the polarized or grounding-type plug. A polarized plug has two blades with one wider than the other. A grounding plug has two blades and a third grounding prong, the wide blade, or the third prong is provided for your safety. If the provided plug does not fit into your outlet, consult an electrician for replacement of the obsolete outlet.
- Protect the power cord from being walked on or pinched particularly at plugs.
- Unplug the apparatus during lightning storms or when unused for long periods.
- Refer all servicing to a qualified service personnel. Servicing is required if the apparatus does not operate normally or if the apparatus, including the power supply cord or plug, has been damaged in any way.
- Servicing is also required if liquid has been spilled, or objects have fallen into the apparatus; when the apparatus has been exposed to rain or moisture; or if the apparatus has been dropped.

# PREPARATION

## What's Included

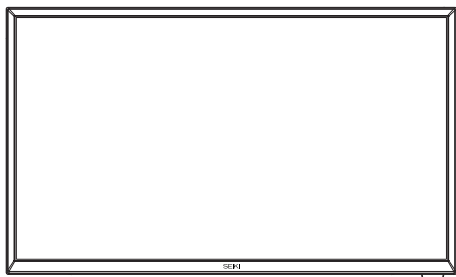

TV Set



Remote Control with Batteries(2\*AAA)

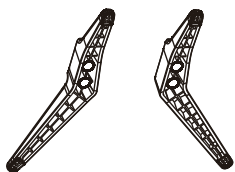

TV Stand

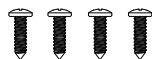

Four Screws(ST4x16mm)

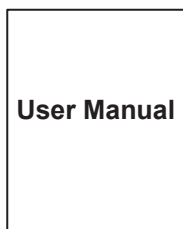

User Manual

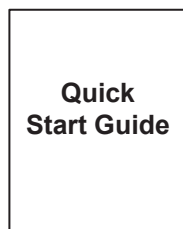

Quick Start Guide

## Front View

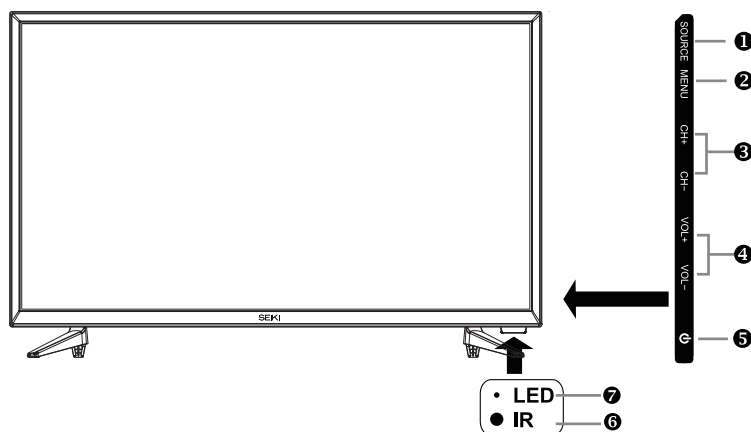

1. **SOURCE**  
Press to select among different input signal sources.
2. **MENU**  
Display the OSD (on screen display) menu.
3. **CH+/-**  
Press to select a channel.
4. **VOL+/-**  
Press to adjust the volume.
5. **POWER**  
Switch the TV between On / Standby mode.
6. **IR (Infrared Receiver)**  
Receive IR signals from the remote control.
7. **POWER Indicator**  
Illuminate red when the TV is in standby mode.

The batteries used with this product contain chemicals that are harmful to the environment. To preserve our environment, dispose of used batteries according to your local laws or regulations.

**Rear View**

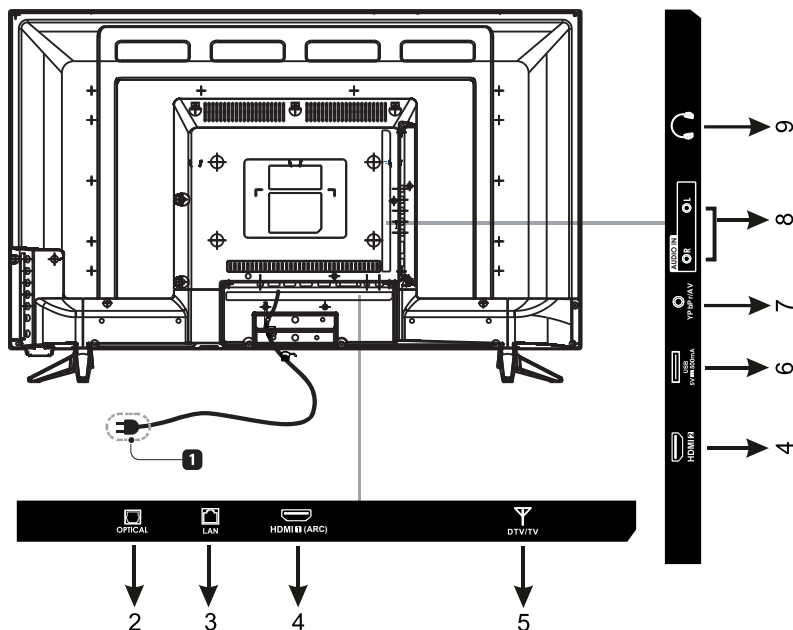

- |  |  |
|--|--|
| <p><b>1. Power Cord</b><br/>Connect to AC power outlet.</p> <p><b>2. OPTICAL Output</b><br/>Connect a digital sound system to this jack.</p> <p><b>3. LAN</b><br/>Network connection port.</p> <p><b>4. HDMI Inputs</b><br/>Connect to a High-Definition (HD) signal input device.</p> <p><b>5. DTV/TV Input</b><br/>Connect to the antenna (75Ω VHF/UHF) socket with the RF coaxial cable.</p> <p><b>6. USB Port</b><br/>Update firmware, Can also play photo files, music files and video files.</p> | <p><b>7. Ypbpr/AV</b><br/>Connect to AV devices with component (Y/Pb/Pr) video and audio output sockets. COMPONENT&amp;VIDEO share with AUDIO IN(L/R)subscribe to. Connect to the composite VIDEO.</p> <p><b>8. AUDIO Input</b><br/>Connect to the AUDIO(L/R) output sockets on external audio device.</p> <p><b>9. Headphone Output Socket</b><br/>Connect to the Headphones.</p> |
|--|--|

Note:HDMI1 with ARC function.This item is used to turn on/off Audio Return Channel. When ARC is on,the TV can return the audio to connected HDMI device.(Amplifier,etc)

## Installing the Base Stand

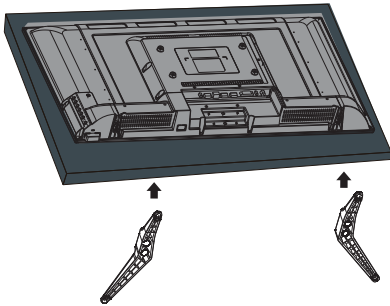

- 1. Lay the TV face-down on a flat, cushioned surface to avoid damaging or scratching.
- 2. Fix the left base stand to the TV using the 2 pcs provided screws(ST4x16mm).
- 3. Fix the right base stand assembly to the TV using the 2 pcs provided screws(ST4x16mm).

## Removing the Stand for Wall-Mounting

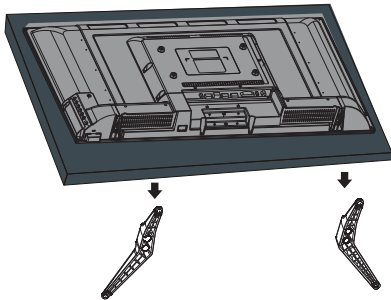

- 1. Lay the TV face-down on a flat, cushioned surface to avoid damaging or scratching.
- 2. Untighten the 4 pcs screws holding the stand assembly and remove them.
- 3. Attach the wall-mount bracket to the TV using the mounting holes on the back of the TV. Mount this TV according to the instructions included in the wall-mount bracket.

**WARNING:** This apparatus is intended to be supported by UL Listed wall mount bracket.

## Wall Mounting

The TV is provided with mounting holes for a VESA approved wall mounting bracket (Not Supplied). Remove the screws holding the base to the base bracket and lift the base away (do not remove the base mounting brackets). Mount the VESA bracket using 4\*M6 isometric threaded screws (Not Supplied).

### WARNING

Never place a television set in an unstable location. A television set may fall, causing serious personal injury or death. Many injuries, particularly to children, can be avoided by taking simple precautions such as:

- Using cabinets or stands recommended by the manufacturer of the television set.
  - Only using furniture that can safely support the television set.
  - Ensuring the television set is not overhanging the edge of the supporting furniture.
  - Not placing the television set on tall furniture(for example, cupboards or bookcases) without anchoring both the furniture and the television set to a suitable support.
  - Not placing the television set on cloth or other materials that may be located between the television set and supporting furniture.
  - Educating children about the dangers of climbing on furniture to reach the television set or its controls.
- If your existing television set is being retained and relocated, the same considerations as above should be applied.



Your new TV is heavy, please consult with professional wall mount installer to perform this installation.

**Remote Control**

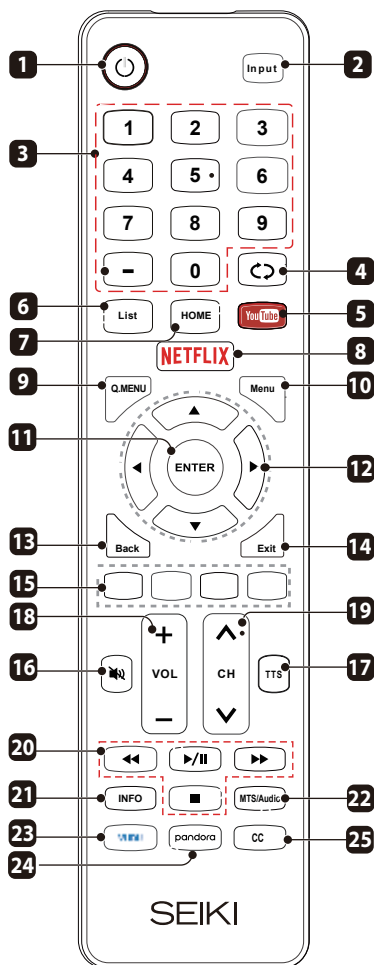

1. **POWER:** Turn the TV on and off.
2. **Input:** This button is used to switch among different sources, Select a source and press ENTER button to confirm.
3. **Digital Buttons(0-9, -):** Directly select channel with digital buttons.
4. **↶↷:** Switch to the previous program.
5. **YouTube:** If network connects, press this key to view YouTube directly.
6. **List:** Press it to show channel list and favorite list on screen.
7. **HOME:** Press it to go to App home page.
8. **NETFLIX:** If network connects, press this key to view NETFLIX directly.
9. **Q.MENU:** Press this key to go to quick menu.
10. **Menu:** Display the main menu or exit the current menu.
11. **ENTER:** Validation key.
12. **Arrow buttons ▲▼◀▶:** Use to select on-screen menu items and change menu values.
13. **Back:** Return.
14. **Exit:** Exit the menu.
15. **Color buttons:** It's used as or Program Edit menu.
16. **MUTE:** Press this button to cut off the sound of the TV set temporarily, press again to resume.
17. **TTS:** Press this button to adjust TTS on or off .
18. **VOL +/-:** Press these buttons to adjust the volume.
19. **CH▼/▲:** Press these buttons to change channel upward or downward.
20. **Digital Media Player control button:** Include play/pause, stop, backward, forward is used in USB mode .  
Please refer to relevant instructions in the section of multimedia player.
21. **INFO:** Display the program information.
22. **MTS/Audio:** In USB mode, press this button to switch audio track when movie is playing. In TV mode, press this button to switch MTS or Audio Language.
23. **VUDU:** Press this button to select VUDU application.
24. **pandora:** Press this button to select pandora application.
25. **CC:** Press this button to adjust CC mode.



# CONNECTING EXTERNAL DEVICES

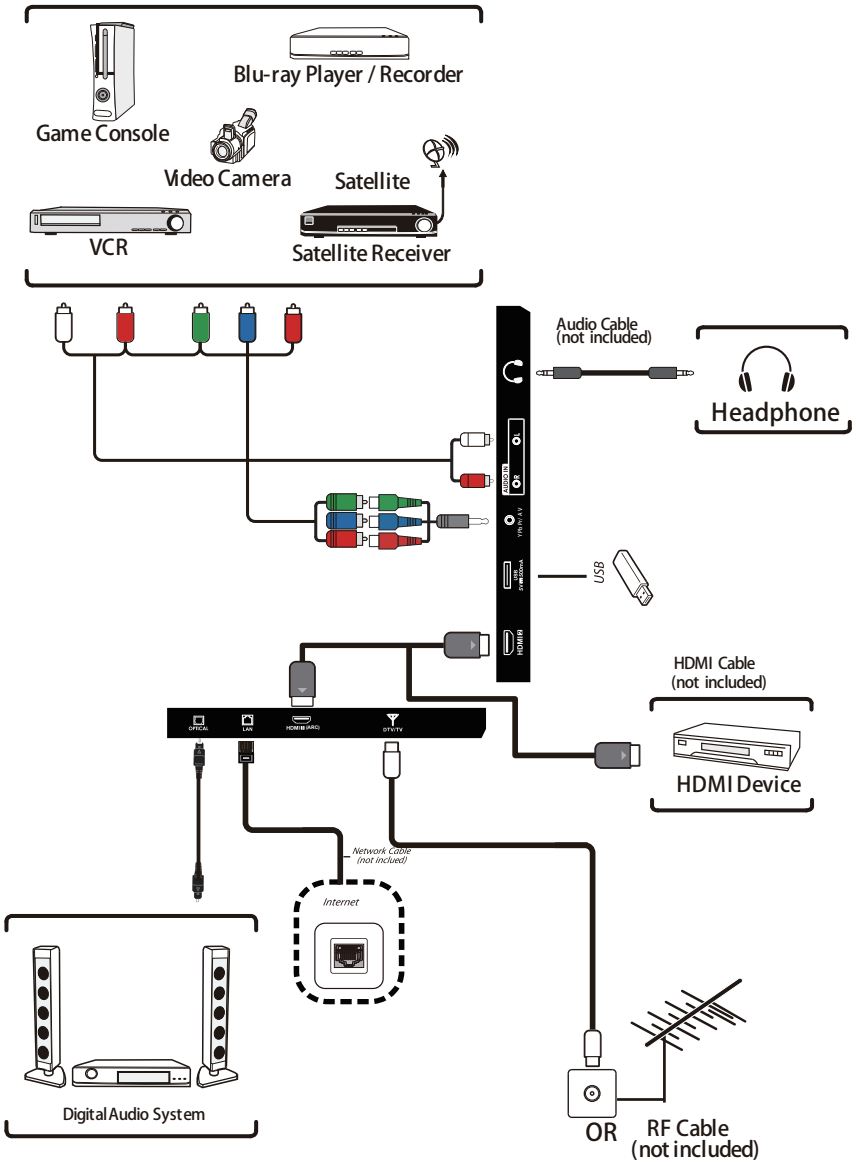

## Basic Operations

### Initial Setup

- Connect the power cord to the power socket after you have completed all the physical connections. At this stage, the TV will enter Standby Mode and the red LED indicator will illuminate.
- In Standby Mode, press the **⏻** button on the main unit or on the remote control to turn the TV on. The red LED indicator will turn off.
- The first time you turn the TV on, it will go into the Setup Wizard. Press **◀/▶** **▲/▼** buttons to select your desired mode and press **ENTER** to confirm.



1



2



3

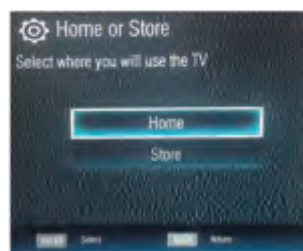

4

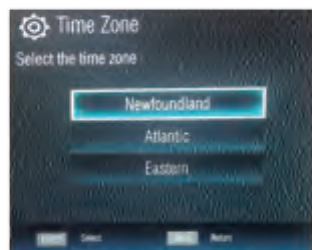

5



6



7



8

**Home Mode** :The picture mode will be Standard if you select this mode.

**Retail Mode** :Select Dynamic Mode if you would like your picture to be brighter.  
At times this mode may use more energy to operate the Volume/Sound Mode and Picture Mode.

• **The SLEEP-MODE Power should be less than 0.5 W.**

## Basic Operations

### Menu Operation

#### 1 Input Setup

Press **INPUT** key on the remote control to enter "INPUT SOURCE" menu. There are these options for you to select: "TV", "AV", "Component", "HDMI1", "HDMI2", "USB". Use ◀▶ key to select a input source and press **ENTER** key to confirm.

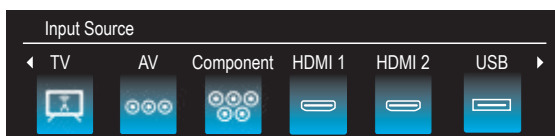

#### 2 Channels Selection

There are four ways to select channel:

- 1) Using number keys, and **ENTER** keys on the remote control to select channel directly.

To select channel 90, press 9 → 0 → **ENTER** .

When you use the number buttons, you can directly select channels that were either erased or not memorized.

- 2) Using **CH▲/▼** key on the remote control or on your TV to select channel.

When you press the **CH▲/▼** key, the TV changes channels in sequence. You will see all the channels that the TV has memorized.

You will not see channels that were either erased or not memorized.

- 3) Press **↺** key to return to previous channel, press it again to return to current channel.

To quickly switch between two channels that are far apart, tune to one channel, then use the number keys to select the second channel. Then use the **↺** button to quickly alternate between them.

**↺** is not activated if no channel has been changed after TV turning on.

- 4) Select channels from "Channels List" or "Favorite List".

Press LIST key to choose from "Channel List" menu.

#### 3 Volume Adjustment and Mute Setup

##### Volume adjustment

Press **VOL +/-** key on the remote control or the TV to display "Volume" menu, adjust the volume of TV between 0 to 100 by using **VOL +/-** key:

- To increase the volume, press **VOL +** key;
- To decrease the volume, press **VOL -** key;



### Mute

Press "**MUTE**" and the sound cuts off. The MUTE icon will appear in the lower-left corner of the screen.

To resume sound, press the "**MUTE**" button again, or simply press the **VOL +** key.

## 4 Current Channel Information

Press "INFO" key on the remote control to view current channel information, the indications of channel information are listed in the following table.

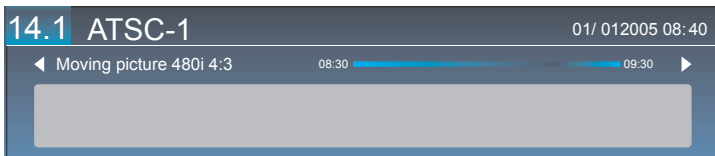

Press "EXIT" key on the remote control to exit this OSD.

### Picture

1. Press **MENU** key to display the main menu on the screen.
2. Press **▲/▼** key to select "Picture" option.
3. Press **▶** key to enter "Picture" submenu.
4. You can also press the **PICTURE** key on the remote control to select one of the picture settings.

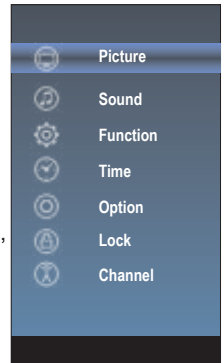

### Picture Mode

Your TV has four picture settings (Vivid, Standard, Movie, Eco Save, User) that are preset at the factory. Only "User" mode can be set to your preference by adjusting particular items such as Contrast, Brightness, Color, Sharpness.

1. Press **▲/▼** key to select "Picture Mode" option.
2. Press **▶** or "ENTER" key to confirm.
3. Press **▲/▼** key to select one picture mode.

## Picture

### User settings for PICTURE

#### (Contrast, Brightness, Color, Sharpness, Tint)

Your set has several settings which allow you to control picture quality.

1. Press ▲/▼ key to select a particular item.
2. Press ◀/▶ key to decrease or increase the value of a particular item.

Note: The adjusted values are stored according to the selected particular item.

Picture Mode	
Contrast	70
Brightness	50
Color	70
Sharpness	20
Tint	0
Backlight	100
Color Temperature	

Contrast: Adjusts the lightness and darkness between objects and the background.  
Brightness: Adjusts the brightness of the picture.  
Color: Adjusts the colors, making them lighter or darker.  
Sharpness: Adjusts the outline of objects to either sharpen them or make them more dull.  
Tint: Adjusts the Tint of the picture.

### Backlight

You can Change the brightness of the entire screen according to your preference.

1. Press ▲/▼ key to select "Backlight" option.
2. Press ◀/▶ key to increase or decrease the backlight value.

Backlight: Adjusts the brightness of the whole screen.

### Color Temperature

You can change the color of the entire screen according to your preference.

1. Press ▲/▼ key to select "Color Temperature" option.
2. Press ▶ or "ENTER" key to confirm.
3. Press ▲/▼ key to select one color temp.

Cool: Makes whites bluish.  
Standard: Makes whites nature  
Warm: Makes whites reddish.

## Sound

1. Press **MENU** key to display the main menu on the screen.
2. Press **▲/▼** key to select "Sound" option.
3. Press **▶** key to enter "Sound" submenu.
4. You can also press the **SOUND** key on the remote control to select one of the sound.

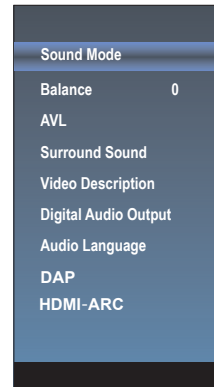

### Sound Mode

You can select the type of the special sound effect to be used when watching a given broadcast. Your TV has five sound settings ("Standard", "Music", "Movie", "Sports", "User") that are preset at the factory.

1. Press **▲/▼** key to select "Sound Mode" option.
2. Press **▶** or "ENTER" key to confirm.
3. Press **▲/▼** key to select one sound mode.

- Standard: Selects the normal sound mode.
- Music: Provides clear and live sound for music.
- Movie: Provides live and full sound for movies.
- Sports: Emphasizes bass over other sounds.
- User: Selects your custom sound settings.

### Balance

If the volumes of the left speaker and the right speaker are not the same, you can adjust the "Balance" to suit your personal preference.

1. Press **▲/▼** key to select "Balance" option.
2. Press **◀/▶** key to decrease or increase the value of the item.

### AVL

Each broadcasting station has its own signal conditions, and it is inconvenient to adjust the volume every time the channel is changed. "AVL" automatically adjusts the volume of the desired channel by lowering the sound output when the modulation signal is high or by raising the sound output when the modulation signal is low.

1. Press **▲/▼** key to select "AVL" option.
2. Press **▶** or "ENTER" key to confirm.
3. Press **▲/▼** key to select "On" or "Off".

### Surround Sound

This is used to turn on surround sound to gain better sound effect.

1. Press **▲/▼** key to select "Surround sound" option.
2. Press **▶** or "ENTER" key to confirm.
3. Press **▲/▼** key to select "Surround" or "Off".

### Video Description

1. Press **▲/▼** key to select "Video Description" option.
2. Press **▶** or "ENTER" key to confirm.
3. Press **▲/▼** key to select "On" or "Off".

## SOUND

### Digital Audio Output

This is used to set digital audio output.

1. Press ▲/▼ key to select "Digital Audio Output" option.
2. Press ► or "ENTER" key to confirm.
3. Press ▲/▼ key to select "Auto" or "PCM".

### Audio Language

You can set the primary and secondary language for audio.

### DAP

You can set DAP on the DAP submenu.

### HDMI-ARC

Turn on or turn off the HDMI-ARC function.

DAP	
DAP Enable	On
DAP Mode	Standard
Surrond Virtualizer	High
Dialog Enhancer	Low
Auto Voulme Control	Off

## Function

1. Press MENU key to display the main menu on the screen.
2. Press ▲/▼ key to select "Function" option.
3. Press ► key to enter "Function" submenu.

### Noise Reduction

Press ▲/▼ key to select the Noise Reduction mode. You can select the right mode to match the pictures.

### MPEG Noise Reduction

Press ▲/▼ key to select the Mpeg Noise Rdeuction mode: off/low/middle/high. The picture will be better when it is in "high" mode.

### Aspect Ratio

1. Press ▲/▼ key to select "Aspect Ratio" option.
2. Press ► or "ENTER" key to confirm.
3. Press ▲/▼ key to change the size of the picture on the size of the picture on the screen.

Noise Reduction
MPEG Noise Reduction
Aspect Ratio
Link Setup
Netflix Deactive
Netflix ESN
Netflix Version
VUDU Deactivation
TTS



## Function

### Link Setup

1. Press ▲/▼ key to select "Link Setup" option.
2. Press ENTER or ►key to enter "Link Setup" submenu.

Enable Link: Press ◀/▶ to turn on/off the link setup.

Auto Power On: When this option is "On" and the TV is in standby mode. To turn on the DVD or other supporting CEC function devices can also turn the TV at the same time.

Auto Standby: When this Option is "On" and the TV is on, to turn off TV can also turn the DVD or other supporting CEC function devices into standby mode.

Link Setup	
Enable link	On
Auto Power On	Off
Auto Standby	Off

### Netflix Deactive

1. Press "▲/▼" key to select "Netflix Deactive" option.
2. Press "►" or "ENTER" key to confirm.
3. Press "Yes" to confirm again, the Netflix will be activated.

### Netflix ESN

Display the Netflix Esn information.

### Netflix Version

Display the Netflix version.

### VUDU Deactivation

1. Press "▲/▼" key to select "VUDU Deactivation" option.
2. Press "►" or "ENTER" key to confirm.

### TTS

You can set TTS information in the TTS menu.

TTS	
TTS	On
Verbosity	Low
Rate Support	Mid
Pitch Support	Mid
	Betty Say

### Time

1. Press **MENU** key to display the main menu on the screen.
2. Press **▲/▼** key to select "Time" option.
3. Press **▶** key to enter "Time" submenu.

#### **Off Time**

In "Off Time" item, press **▶** button or **ENTER** button to enter the submenu, set the day & time to turn off the TV set.

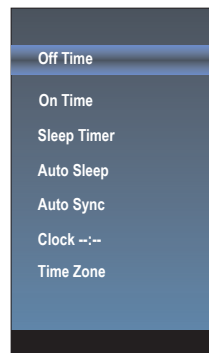

#### **On Time**

In "On Time" item, press **▶** button or **ENTER** button to enter the submenu, set the time to turn on the TV set, when the TV set is in the standby mode. You can also choose which day to control you TV set in a week.

#### **Sleep Timer**

1. Press **▲/▼** key to select "Sleep Timer" option.
2. Press **▶** or "ENTER" key to confirm.
3. Press **▲/▼** key repeatedly until the desired time appears (Off, 10mins, 20mins, 30mins, 60mins, 90mins, 120mins, 180mins, 240mins).

Notes: The sleep timer you have set will be cancelled when the TV turns off or if a power failure occurs.

**Notes:** When the time is less than 60 seconds, remind information will be displayed on the screen. Press any key button to cancel timer function.

#### **Auto Sleep**

Press **▲/▼** key to select whether to open the No signal Power off features. If this function is opened, the TV will power off in ten minutes when there is no signal.

#### **Auto Sync**

You can modify the time of your TV set in Manual mode. In Auto mode, the "clock" is decided by the DTV signal.

#### **Clock --:--**

When Auto Sync is on, the clock is got from DTV streams; Set the clock when Auto Sync is off.

#### **Time Zone**

You can choose it to modify your time zone in the TV set.

1. Press **▲/▼** key to select "Time Zone" option.
2. Press **▲/▼** key to select time zone.

## Option

1. Press **MENU** key to display the main menu on the screen.
2. Press **▲/▼** key to select "Option" option.
3. Press **▶** key to enter "Option" submenu.

### **OSD Language**

1. Press **▲/▼** key to select "OSD Language" option.
2. Press **ENTER** or **▶** key to select a proper language for OSD

### **OSD Time**

Set the preferred amount of time for the OSD to be displayed on the screen.

### **Closed Caption**

1. Press **▲/▼** key to select "Closed Caption" option.
2. Press **ENTER** key to open CC submenu.

### **Reset**

1. Press **▲/▼** key to select "Reset" option.
2. Press **▶** or "ENTER" key to confirm.
3. Press "Yes" to confirm again, TV will turn off automatically and change all setting to factory setting.

### **Network configuration**

Please refer to "Network setting" behind.

### **Software Update(USB)**

When the TV need to be updated, please copy the new software to a USB storage and inset the USB storage to TV, then operating by following steps.

1. Press **▲/▼** key to select "Software Update(USB)" option.
2. Press **▶** or "ENTER" key to confirm.
3. Press "Yes" to confirm again, the TV will update by USB, Please wait a few minutes and don't turn off the power, it will turn off automatically when updating is finish.

### **Internet Update Check**

1. Press **▲/▼** key to select "Internet Update Check" option.
2. Press **▶** or "ENTER" key to confirm.

### **NetworkUpdate Information**

1. Press **▲/▼** key to select "NetworkUpdate Information" option.
2. Press **▶** or "ENTER" key to confirm.

### **User Mode**

1. Press **▲/▼** key to select "User Mode" option.
2. Press **▶** or "ENTER" key to confirm.
3. Switch to use mode "Home" or "Store".

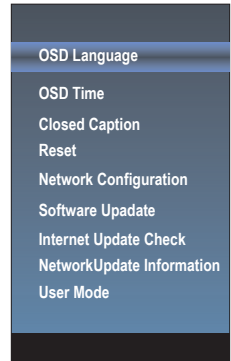

### Lock

The "Lock" feature automatically locks out programming that is deemed inappropriate for children. The user must first enter a Password before any of the lock restrictions can be set up or changed.

1. Press ▲/▼ key to select "Lock" option.
2. Press **ENTER** or ► key to enter "Lock" submenu, "Enter Password" menu will appear, enter your 4-digit password to enter "Lock" submenu (the default and universal password is 0000).

#### **Lock System**

Set the Lock function on or off.

1. Press ▲/▼ key to select "Lock System" option.
2. Press "►" or "ENTER" key to confirm.
3. Press ▲/▼ key to select "On" or "Off".

#### **Set Password**

1. Press ▲/▼ key to select "Set Password" option.
2. Enter your 4-digit password to enter "Set Password" submenu. Choose any 4-digits for your new password and enter them. As soon as the 4 digits are entered, the cursor skipped to "Confirm Password" item, re-enter the same 4 digits, and your new password has been memorized.

When the programs is locked, you can also press the menu key, Info key and so on. Then you can press ◀/▶ key to call back the input-password window.

#### **USA TV**

1. Press ▲/▼ key to select "USA TV" option.
2. Press **ENTER** key to open USA TV menu.

#### **USA MPAA**

1. Press ▲/▼ key to select "USA MPAA" option.
2. Press **ENTER** key to open USA MPAA menu.

#### **Canada English**

1. Press ▲/▼ key to select "Canada English" option.
2. Press **ENTER** key to open Canada English menu.

#### **Canada French**

1. Press ▲/▼ key to select "Canada French" option.
2. Press **ENTER** key to open Canada French menu.

#### **RRT Setting**

1. Press ▲/▼ key to select "RRT Setting" option.
2. Press **ENTER** key to open RRT Setting menu.

#### **RRT Reset**

1. Press ▲/▼ key to select "RRT Seseet" option.
2. Press **ENTER** key to open RRT Seseet menu.

#### **Block Unrated TV**

1. Press ▲/▼ key to select "Block Unrated TV" option.
2. Press **ENTER** key to open Block Unrated TV menu.

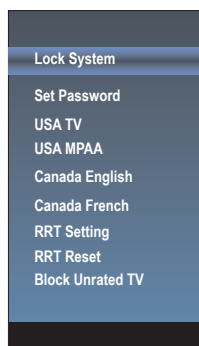
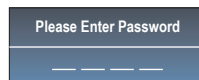

## Channel

Before your television can begin memorizing the available channels, you must specify the type of signal source that is connected to the TV (i.e. an antenna or a cable system).

1. Press **MENU** key to display the main menu on the screen.
2. Press **▲/▼** key to select "Channel" option.
3. Press **ENTER** or **▶** key to enter "Channel" submenu.

### Antenna

1. Press **▲/▼** key to select "Antenna" option.
2. Press **▲/▼** key to select "Antenna" or "CABLE"
3. Press **▶** or "ENTER" key to confirm.

### Auto Search

1. Press **▲/▼** key to select "Auto Search" option.
2. Press **▶** or **ENTER** key to confirm. then a notice window will be displayed on the screen. Select "Start" to start search or "Cancel" to cancel it. When searching, press **EXIT** key to exit tuning at any moment. Press **MENU** key to skip DTV tuning when searching DTV, skip ATV tuning when searching ATV.
3. After all the available channels are stored, the searching menu will exit.

### Program Edit

After the program is searched, select "Program Edit" in the "Channel" menu, press "ENTER" button, program can be edited such as delete or skip according to the user's habit.

#### Skip (Blue) Button

This function can help shield certain program. Program skips when selecting program by the "▲/▼" button on the TV or remote control.

1. Select the program to be shielded in the "Program Edit".
2. Press "Skip" (Blue) button, the skip mark is displayed at the left side of the program and this program is shielded.
3. To cancel the Skip function, enter the channel edit menu, select the shielded program and press "Skip" (Blue) button, the skip mark at the left side of the program disappears then program is recovered.

#### Delete (Red) Button

This function can help delete program.

1. Select the program to be deleted in the "Program Edit".
2. Press "Delete"(Red) button, the program will be deleted.

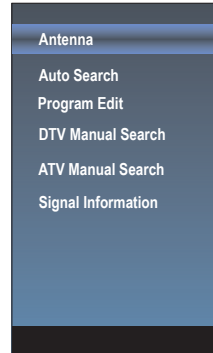

## Menu system instruction

---

### Favorite(Yellow) button

This function can help store the favorite program then these programs can be quickly selected.

1. Select the program which is favorite.
2. Press "Fav"(Yellow) Button, the favorite mark is displayed at the left side of the Program Edit is store into the Favorites.
3. To cancel the Favorite function, enter the program edit menu, select the program and press "Fav"(Yellow) button, the favorite mark at the left side of the program disappears.

### ***DTV Manual Search***

Enter digital number and press "ENTER" to select DTV Channel.

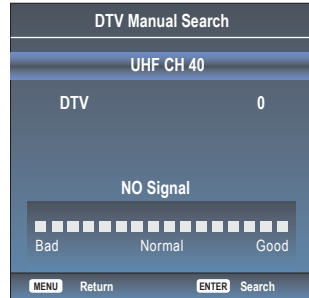

**ATV Manual Search**

1. Press ▲/▼ key to select "ATV Manual Search" option.
2. Press ► or ENTER key to enter submenu.

**Current CH**

1. Press ▲/▼ key to select the Current CH.
2. Press ◀/▶ key to select current channel.

**Fine-Tune**

1. Press ▲/▼ key to select the Fine-Tune.
2. Press ◀/▶ key to select a better frequency for current channel.

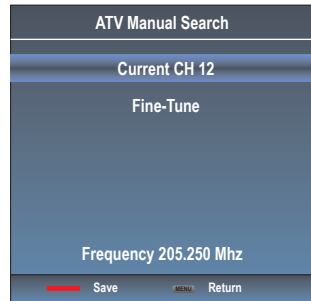
**Signal Information(Used only in DTV)**

1. Press ▲/▼ key to select "Signal Information" option.
2. Press "ENTER" or ► key ,you can see the information of the DTV channel.



## NETWORK SETTING

1. Press the "Menu" to enter, then pitch on the "Option", and press "ENTER" or click the right button to enter the submenu.

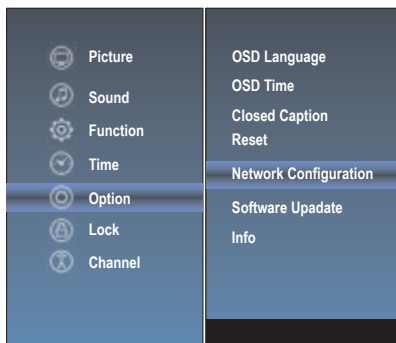

2. Pitch on the "Network Configuration", and press "ENTER" or click right button to enter the "Network Configuration".

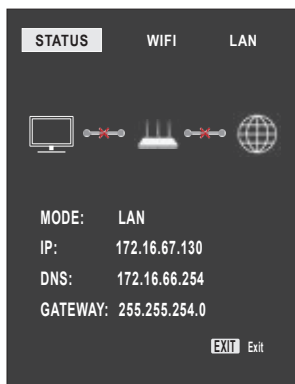

3. When the wired network is used, if select dynamic IP address setting, pitch on the "DHCP" in the "Network Configuration", then click the "Setting", and press the "ENTER" button to enter.

If select static IP address setting, pitch on the "Static" in the "Network configuration", then setting up the IP, Netmask, Gateway and DNS in sequence. When the setting complete, pitch on the "setting" and press the "Enter".



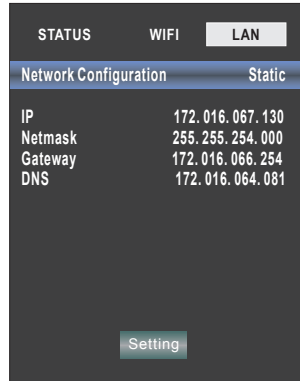

4. If shows "Success", the "WLAN" on the bottom right corner will turn green from red, and it means the network connect successfully; If shows "Fail", it means the network can not connect, please check whether the net wire and router connect successfully or not.

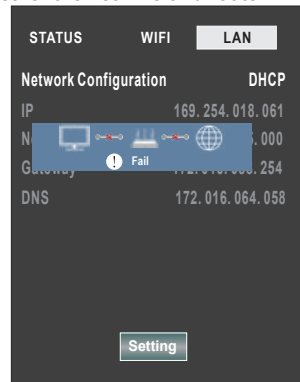

5. Select the "WIFI" in the Network Configuration before using WIFI connecting.

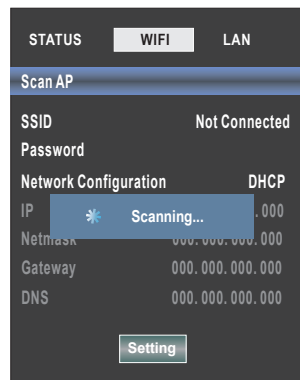

1. Press the menu button, a menu and choose "Option", under the Option menu select "Network Configuration" interface for Network connection.
2. In the network interface "◀ " " ▶" key to switch to WIFI connection interface.
3. Press the "▲ " and " ▼ " key to select Scan for AP, scanning can connect to the AP.
4. The scan is complete there will be a AP list, choose the AP will connect, press "ENTER" key to confirm.
5. Select "Password", there will be a small keyboard, with small keyboard input WIFI Password, input is completed in accordance with the "RETURN" on the keypad.
6. Press the " ▲ " " ▼ " button with each SETTING.

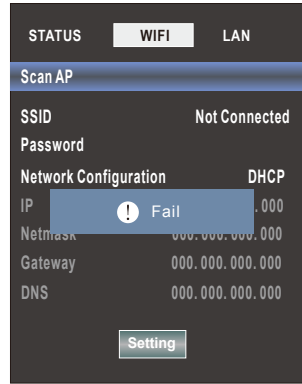

## Press "HOME" key to enter internet interface

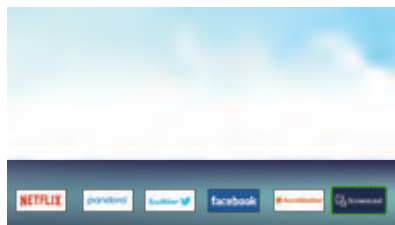
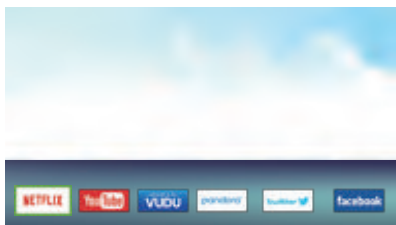

### 1. NETFLIX

- ① Use arrow key to Select  button, then press "ENTER" key to enter NETFLIX.
- ② Input the right Email and password, then select "Next" button and press "ENTER" key to login.

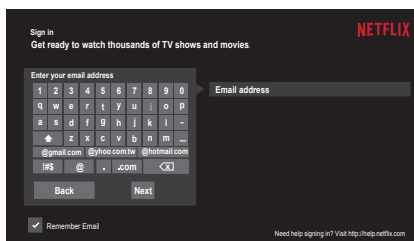

- ③ Use arrow button to select one video and press "ENTER" key to play. Press "MENU" key to exit playing.
- ④ Use arrow key to browse the pages. press "MENU" key to return to main menu and press "EXIT" key to exit.

### 2. Youtube

- ① Use arrow key to Select  button, then press "ENTER" key to enter Youtube.

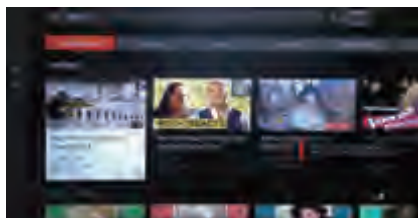

- ② Use arrow button to select one video and press "ENTER" key to play.
- ③ Press ▼ key to open or close control menu when playing.

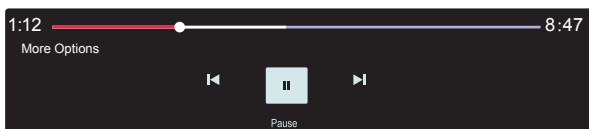

**3. VUDU**

- ① Use arrow key to Select  button, then press "ENTER" key to enter VUDU.



**4. pandora**

- ① Use arrow key to Select  button, then press "ENTER" key to enter pandora.

- ② Input the right Email and password, then select "login" button and press "ENTER" key to login.



## 5. Twitter

- ① Use arrow key to Select  button, then press “ENTER” key to enter Twitter.

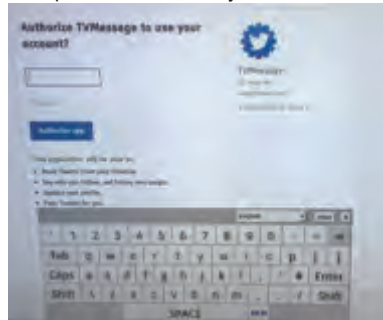

- ② Input the right Email and password, then select “Authorize app” button and press “ENTER” key to log in.

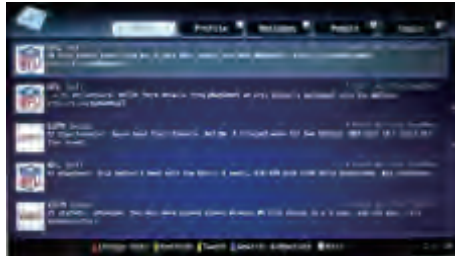

- ③ Use arrow key to browse the pages. press “MENU” key to return to main menu and press “EXIT” key to exit twitter.

Red key: log in or log out twitter.

Green key: refresh current page.

Yellow key: write new tweet.

Blue key: Search tweet.

### 6. Facebook

- 1 Use arrow key to Select  button, then press “ENTER” key to enter Facebook.



- 2 Input the right Email and password, select “log In” button, then press “ENTER” key to log in.



- 3 Press arrow key to browse the pages and press “ENTER” key to view.  
Press “MENU” key to return the main menu.  
Press “EXIT” key to exit Facebook.  
Red key: log in or log out Facebook.

### 7. Accuweather

- 1 Use arrow key to Select  button, then press “ENTER” key to enter Accuweather.



- 2 Input a city or zip code press select to get the weather information.

**8.Screencast**

Use arrow key to Select  button, then press "ENTER" key to enter Screencast.

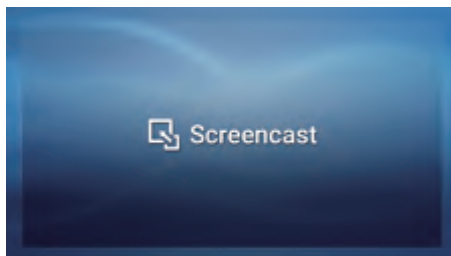

# Digital Media Player

## Introduction

This TV is embedded with one USB port digital media player. It can find the devices support USB1.1/2.0, including flash disk, USB hard disk and digital camera. It supports functions as: Display pictures. Play video files.

### Notice:

1. In order to avoid affecting the user's viewing experience, please use the better quality and shorter USB cable.
2. Play, preview some of the non-standard files may appear abnormal, please understand.

### Explain:

1. Under the USB channel, you can use only the remote control.
2. Play Control menu to enter the playing surface to press the menu button pop-up menu

Data	Format
Picture	JPEG
Video	Motion-JPEG

## Remote Control Button

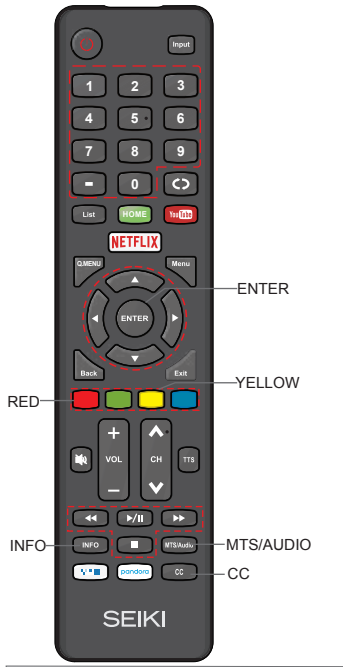

### Description of Buttons:

Buttons	Function
AUDIO	Track switch (video)
CC	Subtitle switch (video)
INFO	Show/Hide movie info (video)
YELLOW	AB Loop (Video)
RED	Goto Time (Video)
▶/	Play/Pause
■	Stop
◀◀	Backward
▶▶	Forward



## PARENTAL CONTROL

Press the **MENU** button on the main unit or on the remote control and then press ◀/▶ buttons to select **LOCK** menu. Use the **0-9** buttons to input the 4-digit password to enter the **LOCK** menu. If used, this option feature can "block" undesirable programming from appearing on the TV. Parental Control offers the user a wide variety of options and settings that restrict or "block" the programming that can appear on the TV. Parental Control allows the user to define which program rating they consider acceptable for younger more sensitive viewer. It can be preset and turned either on or off by the user who specifies the secret 4-number code, the password. The number of hours blocked are specified. General audiences and children blocks should be both programmed into the TV's memory. Separate different viewer ratings are specified for both TV and the motion picture Industry; both rating systems should be used and based on the ages of children.

### Overview

To ensure complete coverage for all TV programs, (movies and regular TV shows) choose a rating for MPAA, from the selections below, as well as ratings from the TV Parental Guidelines Rating Systems below, using the Age Block option for General Audiences, and for children. In addition, you may wish to add additional restrictions from the content block menu, and submenus examples below.

### Things to Consider before Setting up Parental Control

Determine which rating you consider acceptable to the viewer. (For example, if you choose TV-PG, more restrictive ratings will be automatically blocked; the viewer will not be able to see: TV-PG, TV-14, or TV-MA rated programming.) You may block the auxiliary video source entirely. (Blocks the signal sent by the equipment, such as VCR, connected to the TV Audio/Video Input Jacks) or remain unblocked, then choose acceptable ratings. Block program "Content" based on individual parameters such as: Strong Dialog, Bad Language, Sex Scenes, Violence Scenes or Fantasy. Violent Scenes; in Content Blk option. Select a secret password, in the Set Password option, using the numbers keys on the remote control. Save the password, it is the only way to access the Parental Control menu and change rating setting, or turn off Parental Control.

- You can set different Parental Control viewing restrictions for general audiences and for children, both can be active at the same time.
- Simply specifying one content block such as Sex Scenes, will not automatically restrict the programming that appears from the video sources.
- Even if you choose to leave the AUX Inputs unblocked, the ratings you specify will automatically restrict the programming that appears from the video sources.
- You cannot disable Parental Control by disconnecting the TV from power. Block hours will be automatically reset to the original block time setting specified if power is disconnected.

### • Motion Picture Association of America (MPAA) Rating System

Grade	Meaning
<b>G</b>	General Audiences Content not offensive to most viewers.
<b>PG</b>	Parental Guidance Suggested Content is such that parents may not want their children to view the program.
<b>PG13</b>	Parents Strongly Cautioned Program is inappropriate for preteens, with a greater degree of offensive material suggested than a PG rated program.
<b>R</b>	Restricted Not for children under 17-contains strong element of sex and/or violence.
<b>NC-17</b>	No children under age 17 Not for children under 17-under any circumstances. Contains strong sexual content.
<b>X</b>	Hard Core Films Same as NC-17 rating.
<b>No Rating</b>	No Rating MPAA did not rate

### • TV Parental Guideline Rating System

Grade	Meaning
<b>TV-Y</b>	All Children Content not offensive to most viewers.
<b>TV-Y7</b>	Directed to Older Children Considered suitable for children over 7- may contain fantasy violence scenes.
<b>TV-G</b>	General Audience Considered suitable for all audience; children may watch unattended.
<b>TV-PG</b>	Parental Guidance Suggested Suggested unsuitable for younger children-may contain suggestive language, bad language, sex and violence scenes.
<b>TV-14</b>	Parents Strongly Cautioned unsuitable for children under 14 - may contain strong language, bad language, sex, and violence scenes.
<b>TV-MA</b>	Mature Audience Only Adults only- may contain strong language, bad language, sex, and violence scenes.
<b>TV-NONE</b>	Block Unrated TV Only play with levels of TV programs, shielding no levels of TV programs.

#### Canadian Rating:

Canadian English is used throughout all English-speaking Canada (C, C8+,G, PG, 14+, 18+).

Canadian French is used in Quebec (G, 8 ANS+, 13 ANS+, 16 ANS+, 18 ANS+)

**Note:** The V-Chip will automatically block certain categories that are "more restrictive". If you block TV-Y category, then TV-Y7 will be automatically blocked. Similarly, if you block TV-G category, then all the categories in the "young adult" will be blocked (TV-G, TV-PG, TV-14, and TV-MA).

## TROUBLESHOOTING

If your TV does not operate normally or cannot be turned on, please check the following troubleshooting questions. Remember also to check any other connected electronic device, such as DVD or Blu-ray player to pinpoint the problem. If the TV still fails to operate normally, please contact technical support.

The TV does not operate properly	
The TV does not respond when pressing any buttons	<ul style="list-style-type: none"> <li>The TV may freeze up during use. Disconnect the power cord from the power socket for a few minutes. Reconnect the power cord and try to operate it again as usual.</li> </ul>
TV cannot be switched on	<ul style="list-style-type: none"> <li>Check that the TV is connected to the power supply.</li> <li>Make sure all connected AV devices are switched off before switching on your TV.</li> </ul>
The remote control does not work	<ul style="list-style-type: none"> <li>Check to see if there are any objects between the TV and the remote control causing an obstruction. Ensure that you are pointing the remote control directly at the TV.</li> <li>Ensure that the batteries are installed with the correct polarity (+ to +, - to -).</li> <li>Install new batteries.</li> </ul>
Power is suddenly turned off	<ul style="list-style-type: none"> <li>Check the power of the TV. The power supply maybe interrupted.</li> <li>Check if the sleep timer is set.</li> <li>Check whether the Auto Standby is activated.</li> </ul>
The video function does not work	
No picture & No Sound	<ul style="list-style-type: none"> <li>Check whether the TV is switched on.</li> <li>Try another channel. The problem may be caused by the broadcaster.</li> </ul>
Picture appears slowly after switching on	<ul style="list-style-type: none"> <li>This is normal; the image is muted during the TV startup process. Please contact your service centre if the picture has not appeared after five minutes.</li> </ul>
No or poor color or poor picture	<ul style="list-style-type: none"> <li>Adjust the settings in the PICTURE menu.</li> <li>Try another channel. The problem may be caused by the broadcaster.</li> <li>Check if video cables are connected properly.</li> </ul>
Horizontal/Vertical bar or picture shaking	<ul style="list-style-type: none"> <li>Check for local interference such as an electrical appliance or power tool.</li> </ul>
Poor reception on some channels	<ul style="list-style-type: none"> <li>The station or cable channel may be experiencing problems; tune to another station.</li> <li>Station signal may be weak, reposition the antenna for better reception.</li> <li>Check for sources of possible interference.</li> </ul>
Lines or streaks in pictures	<ul style="list-style-type: none"> <li>Check antenna (change the position of the antenna.)</li> </ul>
No pictures when connecting HDMI	<ul style="list-style-type: none"> <li>Check if the input source is HDMI1/HDMI2 .</li> </ul>
Pictures appear in wrong ratio	<ul style="list-style-type: none"> <li>Adjust the Aspect Ratio settings in the FUNCTION menu.</li> </ul>

Picture OK but no sound	<ul style="list-style-type: none"> <li>• Press the VOL +/- buttons.</li> <li>• Sound muted? Press the MUTE button.</li> <li>• Try another channel. The problem may be caused by the broadcaster.</li> </ul>
No output from one of the speakers	<ul style="list-style-type: none"> <li>• Adjust the Balance settings in the AUDIO menu.</li> </ul>
Unusual sound from inside the TV	<ul style="list-style-type: none"> <li>• A change in ambient humidity or temperature may result in an unusual noise when the TV is switched on or off and does not indicate a fault with the TV.</li> </ul>
No sound when connecting HDMI	<ul style="list-style-type: none"> <li>• Check if the input source is HDMI1/HDMI2.</li> </ul>
Audio noise	<ul style="list-style-type: none"> <li>• Keep the RF coaxial cable away from the other connected cables.</li> </ul>
Lost password	<ul style="list-style-type: none"> <li>• Select the SET Password setting in the LOCK menu, then enter the following master password "1980". The master password clears your previous password and allows you to enter a new password.</li> </ul>

## Maintaining

- Do not use your TV in areas that are too hot or too cold, because the cabinet may warp or the screen may malfunction. Your TV works best in temperatures that are comfortable to you.
- Storage temperatures are 32° to 122°F(0° to 50°C)
- Working temperatures are 32° to 95°F(0° to 35°C)
- Do not place your TV in direct sunlight or near a heat source

## SPECIFICATION

Panel Size	31.5 inch diagonally
Display Type	DLED
Panel Technology	TFT
Panel 60 Hz Vs. 120 Hz	60 Hz
Panel Resolution	1366x768
Aspect Ratio	16:9
Dynamic Contrast Ratio-Panel	1000:1
Brightness (Centre Typ.) Cd/M <sup>2</sup>	160~240
Response Time (G To G)	8 ms
Lamp Life (Typ. Hours)	20,000 hours
Horizontal Viewing Angle	100
Vertical Viewing Angle	80
Wall-mount(LxW-mm)	200*100(mm)

### The FCC Wants You to Know



This equipment has been tested and found to comply with the limits for a Class B digital device, pursuant to Part 15 of the FCC Rules. These limits are designed to provide reasonable protection against harmful interference in a residential installation.

This equipment generates, uses, and can radiate radio frequency energy and, if not installed or used in accordance with the instructions, may cause harmful interference to radio communications. However, there is no guarantee that interference will not occur in a particular installation.

If this equipment does cause harmful interference to radio or television reception, which can be determined by turning the equipment off and on, the user is encouraged to try to correct the interference by one or more of the following measures: 1) reorient or relocate the receiving antenna; 2) increase the separation between the equipment and the receiver; 3) connect the equipment to an outlet on a circuit different from that to which the receiver is connected; 4) consult the dealer or an experienced radio/TV technician for additional suggestions.

Any changes or modifications not expressly approved by the party responsible for compliance could void the user's authority to operate the equipment. Where shielded interface cables have been provided with the product or specified additional components or accessories elsewhere defined to be used with the installation of the product, they must be used in order to ensure compliance with FCC regulation.

1. This device complies with Part 15 of the FCC Rules. Operation is subject to the following two conditions:
  - (1) This device may not cause harmful interference, and
  - (2) This device must accept any interference received, including interference that may cause undesired operation.

#### FCC Radiation Exposure Statement

This equipment complies with FCC radiation exposure limits set forth for an uncontrolled environment. This equipment should be installed and operated with minimum distance 20cm between the radiator & your body

## SEIKI TV'S LIMITED WARRANTY TO ORIGINAL CONSUMER

This Product (including any accessories included in the original packaging) as supplied and distributed in new condition, is warranted by SEIKI CORPORATION (SEIKI or the Warrantor) to the original consumer purchaser against defects in material and workmanship ("Warranty") as follows:

- PARTS AND LABOR:** For a period of one (1) year from date of original consumer purchase, if this Product or any functional part is determined by SEIKI, or a SEIKI authorized service provider, to be defective, at SEIKI'S sole option and discretion, SEIKI will (i) repair, at no charge to the original consumer, with new or rebuilt replacement functional parts in exchange for defective functional parts, or (ii) replace the Product, with new or re-certified product of similar or better specification, or (iii) provide refund of original purchase price. Replacement Product or parts are warranted for either the remainder of the original warranty period or ninety (90) days from the date of replacement, whichever is longer. After the applicable Warranty periods, the purchaser must pay for all parts and labor costs.  
\* **For the Regions of Canada, the warranty service will be refund of original purchase price only.**
- SHIPPING COSTS:** Notwithstanding the foregoing, the original consumer is responsible for any shipping charges incurred to ship the Product or part(s) to SEIKI or to a SEIKI authorized customer service provider, for diagnosis, repair, replacement or refund. However, SEIKI will pay for return shipping to the customer. Products shipped back to SEIKI or a SEIKI authorized service provider must be in its original packaging or in packaging with an equal degree of protection. **To obtain Warranty Service and Troubleshooting information, please call the Toll Free Customer Service Line at:**

**1- 888-777-5956**

**Please have your model number and serial number available along with your proof of purchase.**

**You can also visit us online and REGISTER your new SEIKI product at:**

**[www.SEIKI.com](http://www.SEIKI.com)**

**To receive Warranty service, the original consumer purchaser must contact SEIKI for pre-authorization prior to sending any Product to SEIKI or a SEIKI authorized customer service provider, or for obtaining any repair, replacement or refund service. Proof of purchase in the form of a bill of sale or receipted invoice evidencing that the Product is within the applicable Warranty period(s), MUST be presented to SEIKI in order to obtain the requested service.**

### **Exclusions and Limitations:**

This Warranty covers manufacturing defects in materials and workmanship encountered in the normal, non-commercial use of the Product, and does not cover (a) damage or failure caused by or attributable to abuse, misuse, failure to follow instructions, improper installation or maintenance, alteration, accident, or excess voltage or current; (b) improper or incorrectly performed repairs by non-authorized service facilities; (c) onsite consumer instruction or adjustments; (d) transportation, shipping, delivery, insurance, installation or set-up costs; (e) costs of product removal, transportation or reinstallation costs; (f) ordinary wear and tear, cosmetic damage or damage due to acts of nature or accident; (g) commercial use of the Product; (h) modification of, or to any part of the Product. In addition, this Warranty does not cover images "burnt" into the screen. This Warranty applies to the original consumer only and does not cover products sold AS IS or WITH ALL FAULTS, or consumables (e.g., fuses, batteries, bulbs etc.), and the Warranty is invalid if the factory-applied serial number has been altered or removed from the Product. This Warranty is valid only in the United States and Canada, and only applies to products purchased and serviced in the United States and Canada. All replaced parts and products, and products on which a refund is made, become the property of SEIKI.

**NO WARRANTIES, WHETHER EXPRESS OR IMPLIED, INCLUDING, BUT NOT LIMITED TO, ANY IMPLIED WARRANTIES OF MERCHANTABILITY OR FITNESS FOR A PARTICULAR PURPOSE, OTHER THAN THOSE EXPRESSLY DESCRIBED ABOVE SHALL APPLY. THE WARRANTOR FURTHER DISCLAIMS ALL WARRANTIES AFTER THE EXPRESS WARRANTY PERIOD STATED ABOVE. NO OTHER EXPRESS WARRANTY OR GUARANTY GIVEN BY ANY PERSON, FIRM OR ENTITY WITH RESPECT TO THE PRODUCT SHALL BE BINDING ON THE WARRANTOR. REPAIR, REPLACEMENT, OR REFUND OF THE ORIGINAL PURCHASE PRICE, AT THE WARRANTOR'S SOLE DISCRETION, ARE THE EXCLUSIVE REMEDIES OF THE CONSUMER. THE WARRANTOR SHALL NOT BE LIABLE FOR ANY INCIDENTAL OR CONSEQUENTIAL DAMAGES CAUSED BY THE USE, MISUSE OR INABILITY TO USE THE PRODUCT. NOTWITHSTANDING THE FOREGOING, CONSUMER'S RECOVERY SHALL NOT EXCEED THE PURCHASE PRICE OF THE PRODUCT. THIS WARRANTY SHALL NOT EXTEND TO ANYONE OTHER THAN THE ORIGINAL CONSUMER WHO PURCHASED THE PRODUCT AND IS NOT TRANSFERABLE. SEIKI RETAINS THE RIGHT TO CHANGE THIS WARRANTY AT ANY TIME WITHOUT NOTICE.**

Some states do not allow the exclusion or limitation of incidental or consequential damages, or allow limitations on warranties, so the above limitations or exclusions may not apply to you. This Warranty gives you specific rights, and you may have other rights, which vary from state to state.

Please send all correspondence to:  
SEIKI CORPORATION  
c/o SEIKI CORP Customer Service  
[warranty@seiki.com](mailto:warranty@seiki.com)

**SEIKI**

**PLEASE CONTACT CUSTOMER SERVICE TO OBTAIN SHIPPING ADDRESS FOR SERVICE.**