

## Contents

Safety Instructions .....	3
Getting Started .....	5
Desk Mounting .....	8
Wall Mounting .....	9
Cordless Telephone Operation .....	11
Preparing for Use .....	11
[NO LINE] Indicator .....	11
Receiving Calls .....	11
Placing Calls .....	12
Using the Headset Feature .....	13
Redial Feature .....	13
Caller ID System Operation .....	14
Caller ID System .....	14
Viewing Caller Information During Incoming Calls .....	14
[MSG WAITING] (Message Waiting) .....	14
Call Waiting .....	15
Voice Mail Function .....	15
[C-F] (Forwarded Call) .....	15
[L-D-C] (Long Distance Call) .....	15
Caller List .....	15
Viewing the Caller List .....	16
Placing a Call From the Caller List .....	16
Editing the Caller List before Dialing .....	16
Saving the Name and Number in the Caller List into the DIRECTORY .....	17
Deleting All Records in the Caller List .....	17
Selective Deleting in the Caller List .....	17
Name and Telephone Number DIRECTORY .....	17
Viewing the DIRECTORY .....	17
Speed Viewing the DIRECTORY .....	18

## Contents

Saving in the DIRECTORY .....	18
PREFERRED CALLS .....	18
BLOCKED CALLS .....	18
Editing a Name and Number in the DIRECTORY .....	19
Editing the Number in the DIRECTORY before Dialing .....	20
Placing Calls from the DIRECTORY .....	21
Deleting All Records in the DIRECTORY .....	21
Selective Deleting in the DIRECTORY .....	21
Function Operation .....	22
A. Language .....	23
B. Silent On/Off .....	23
C. Time Set .....	23
D. Ringer Volume .....	24
E. LCD Contrast .....	24
F. PBX Number .....	24
G. Flash Time .....	25
H. Pause Time .....	25
I. Voice Mail .....	26
J. MSG Waiting (Message Waiting) .....	26
Telephone Keypad Characters .....	27
Security .....	28
Recharging the Battery Pack .....	29
Changing the Battery Pack .....	30
Problem Solving .....	31
Technical Information .....	32
FCC Requirements .....	33
Warranty .....	35
Wall Mount Template .....	39

## *Safety Instructions*

### **IMPORTANT SAFETY INSTRUCTIONS**

**To reduce the risk of fire, electric shock and/or injury, always follow these basic safety precautions when using your cordless telephone equipment.**

1. Read and understand all instructions.
2. Follow all warnings and instructions marked on the telephone.
3. Unplug this telephone from the wall outlet before cleaning or replacing the BATTERY PACK. Do not use liquid cleaners or aerosol cleaners. Use a damp cloth for cleaning.
4. Do not use this telephone near water, for example, near a bath tub, wash bowl, kitchen sink, or laundry tub, in a wet basement, or near a swimming pool.
5. Place this telephone on a stable surface. Serious damage and/or injury may result if the telephone falls.
6. Do not cover the slots and openings on this telephone. This telephone should not be placed near or over a radiator or heat register. This telephone should not be placed in a built-in installation unless proper ventilation is provided.
7. Operate this telephone using the electrical voltage as stated on the BASE UNIT of the telephone or the Owner's Manual. If you are not sure of the voltage in your home, consult your dealer or local power company.
8. Do not place anything on the power cord. Install the telephone where no one will step or trip on the cord.
9. Do not overload wall outlets or extension cords as this can increase the risk of fire or electric shock.
10. Never push objects of any kind through slots in the telephone. They could touch dangerous voltage points or short out parts that could result in a risk of fire or electric shock. Never spill liquid of any kind on the telephone.
11. To reduce the risk of electric shock do not disassemble this telephone. Take it to a qualified serviceman when service or repair work is required. Opening or removing covers may expose you to dangerous voltages or other risks. Incorrect reassembly can cause electric shock when the telephone is subsequently used.
12. Unplug this telephone from the wall outlet and consult a qualified service representative in any of the following situations:
  - A. When the power supply cord is frayed or damaged.
  - B. If liquid has been spilled into the telephone.
  - C. If the telephone has been exposed to rain or water.
  - D. If the telephone does not operate normally by following the operating instructions. Adjust only those controls that are covered by the operating instructions. Improper adjustment of other controls may result in damage and will often require extensive work by a qualified technician to restore the telephone to normal operation.

## *Safety Instructions*

- E. If the telephone has been dropped or the case has been damaged.
- F. If the telephone exhibits a distinct change in performance.
- 13. Do not use the telephone to report a gas leak in the vicinity of the leak.
- 14. Never install telephone wiring during a lightning storm.
- 15. Never install telephone jacks in wet locations unless the jack is specifically designed for wet locations.
- 16. Never touch uninsulated telephone wires or terminals unless the telephone line has been disconnected at the network interface.
- 17. Use caution when installing or modifying telephone lines.

### **Battery Safety**

#### **CAUTION:**

**Danger of explosion if the BATTERY PACK is incorrectly replaced. Replace only with the same or equivalent type. To reduce the risk of fire or personal injury, read and follow these instructions:**

1. Use only the following type and size of BATTERY PACK:
  - Cordless Telephone BATTERY PACK
  - 3.6V, 600mAh
  - U.S. Electronics Inc.
  - Ni-Mh BATTERY PACK: Model B655
  - (See page 29 for ordering information.)
2. Do not dispose of the BATTERY PACK in a fire. It may explode. Check with local codes for possible special disposal instructions.
3. Do not open or mutilate the BATTERY PACK. Released electrolyte is corrosive and may cause damage to the eyes or skin. Electrolyte may be toxic if swallowed.
4. Exercise care in handling the BATTERY PACK to prevent shorting the BATTERY PACK with conductive materials such as rings, bracelets and keys. The BATTERY PACK or conductor may overheat and cause burns.
5. Charge the BATTERY PACK provided with (or identified for use with) this telephone only in accordance with the instructions and limitations specified in this manual.
6. Observe proper polarity orientation between the BATTERY PACK and BATTERY CHARGER.

### ***SAVE THESE INSTRUCTIONS***

#### **ATTENTION:**

The telephone that you have purchased contains a rechargeable BATTERY PACK. At the end of its useful life, under various state and local laws, it may be illegal to dispose of this BATTERY PACK into the municipal waste stream. Check with your local solid waste officials for details in your area for proper disposal.

## Getting Started

### Connecting Your Phone

This section is a reference guide to the basic functions and operations of your cordless telephone. For more detailed descriptions of the operations and features of this telephone, refer to the Contents on page 1.

1. Carefully remove your cordless telephone from its shipping carton. If there is any visible damage, do not attempt to operate this equipment. Return it to the place of purchase.
2. Check to be sure you have all items that come with this cordless telephone system. You should have a **HANDSET**, **BASE UNIT**, **AC ADAPTER**, **MOUNTING BRACKET**, **TELEPHONE LINE CORD**, **SHORT TELEPHONE LINE CORD**, **BELT CLIP**, and an **OWNER'S MANUAL**.

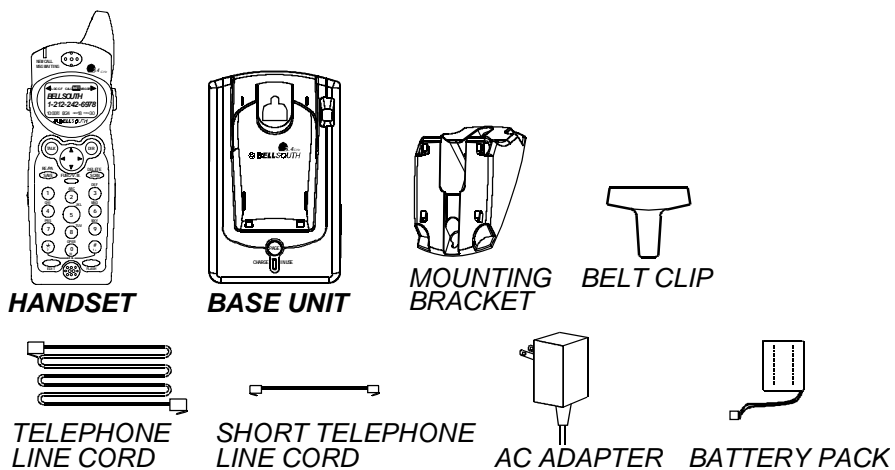

3. Insert the small plug on the end of the **AC ADAPTER** into the **POWER-IN CONNECTION JACK** at the back of the **BASE UNIT**.
4. Plug the **AC ADAPTER** into a 120V AC wall outlet.



**USE ONLY WITH CLASS 2 POWER SOURCE 9V DC, 300mA.**

5. Insert one plug of the **TELEPHONE LINE CORD** into the house **TELEPHONE JACK** and the other end into the **TELEPHONE LINE CONNECTION JACK** at the back of the **BASE UNIT**. (If you have an older 4-prong **TELEPHONE JACK**, you will need an **RJ-11C TELEPHONE JACK ADAPTER**. This adapter is available at the same place you purchased your telephone.)
6. We recommend not placing this unit next to appliances. Doing so may cause interference.

## Getting Started

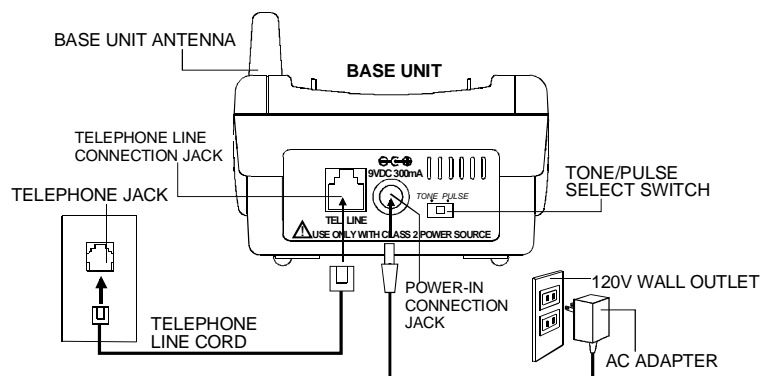

7. Install the BATTERY PACK by plugging it into the BATTERY CONNECTOR inside the BATTERY COMPARTMENT. The **HANDSET LCD** Screen will display "RING: HI".
8. Place the BATTERY PACK inside the BATTERY COMPARTMENT.
9. Slide the **HANDSET** BATTERY COMPARTMENT COVER firmly into place in its closed position.
10. **IMPORTANT: Before initial use, charge the HANDSET for 12 hours.**
11. TONE/PULSE Select Switch:
  - A. If your home is equipped with a tone dialing system, set the TONE/PULSE Select Switch to the TONE position.
  - B. If you have a rotary dialing system, set the TONE/PULSE Select Switch to the PULSE position.
  - C. If you are unsure which system you have, set the TONE/PULSE Select Switch to the TONE position. Press the **TALK** button on the **HANDSET** and make a call. If the call connects, leave the switch as is; otherwise set to the PULSE position.

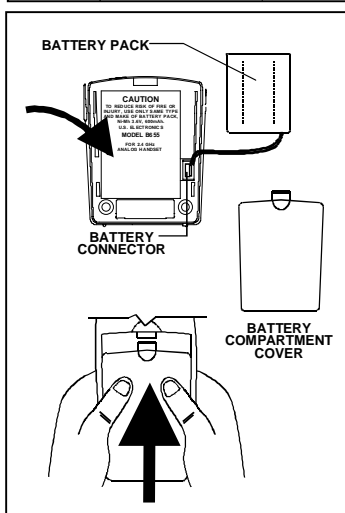
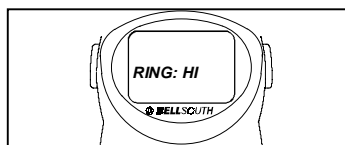

## Getting Started

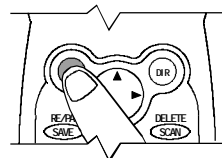
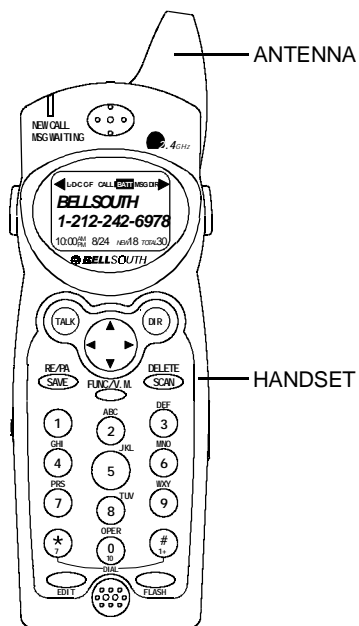

Press the **TALK** button to confirm that you have a dial tone. If you do not get a dial tone, review steps 3 through 11. If you still do not have a dial tone, refer to the Problem Solving section on page 31.

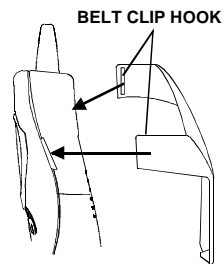

With the back of the **HANDSET** facing up, insert one side of the BELT CLIP HOOK into the matching slot at the top side of the **HANDSET**. Press down on the opposite side of the BELT CLIP until the other HOOK locks into the slot on the side of the **HANDSET**.

13. Set the date and time. (See page 23 for details.)

*You are now ready to use your new  
BellSouth Cordless Telephone.*

### IMPORTANT

In order to utilize the Caller ID feature, you must subscribe to Caller ID service from your local telephone company.

## Desk Mounting

### Desk Mounting

One of the special features of your telephone is the unique design of the MOUNTING BRACKET which can hold your phone at an angle of 30° when desk mounting. There are two positions to choose from:

1. NORMAL POSITION (MOUNTING BRACKET not required):

For the normal position, as shown in Figure 1, place the **BASE UNIT** on any desired but suitable location.

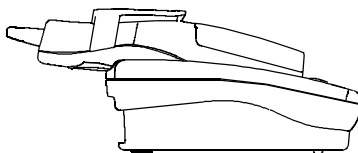

FIGURE 1

2. 30° POSITION (See Figure 2):

With the back of the **BASE UNIT** facing up, insert the hooks of the MOUNTING BRACKET (following the arrow direction for the DESK MOUNT) into the matching slots of the **BASE UNIT** (as shown in Figure 3). Then slide the MOUNTING BRACKET into place as indicated by the arrows.

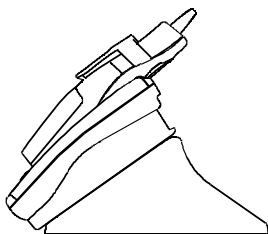

FIGURE 2

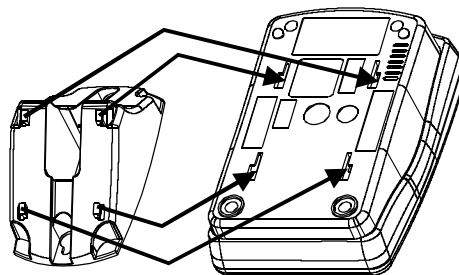

FIGURE 3



## Wall Mounting

### Wall Mounting

You may choose to put the **BASE UNIT** of your cordless telephone on a wall.

1. With the back of the **BASE UNIT** facing up, connect the SHORT TELEPHONE LINE CORD to the TELEPHONE LINE CONNECTION JACK.
2. Insert the free end of the SHORT TELEPHONE LINE CORD through the hole of the MOUNTING BRACKET.
3. Insert the hooks of the MOUNTING BRACKET (following the arrow direction for the WALL MOUNT) into the matching slots of the **BASE UNIT** (as shown below). Then slide the MOUNTING BRACKET into place as indicated by the arrows. Plug the free end of the SHORT TELEPHONE LINE CORD into the MODULAR WALL JACK.
4. Align the upper keyhole on the MOUNTING BRACKET with the upper stud of the wall plate, so that the opening end of the MOUNTING BRACKET matches the lower stud, then pull the **BASE UNIT** down until it is securely seated.

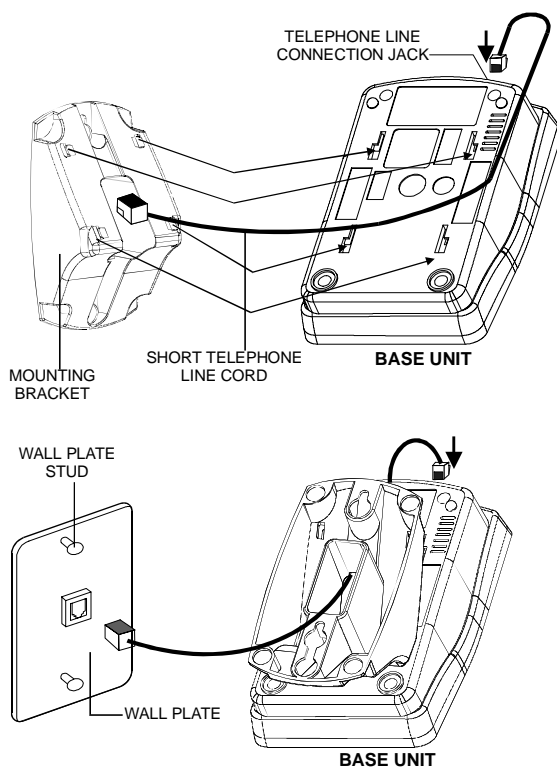

## Wall Mounting

5. This cordless telephone is designed to have a **HANGER KNOB** located on the **BASE UNIT** and a **HANGER HOLE** matching to the **HANGER KNOB** located on the back of the **HANDSET** to secure the **HANDSET** to be sat in position when wall mounting.
  1. Rotate out the **HANDSET KNOB** by your finger tip or a small flat tool. (See Figure 1)
  2. Place the **HANDSET** to the cradle with its LCD Screen facing you. (See Figure 2)

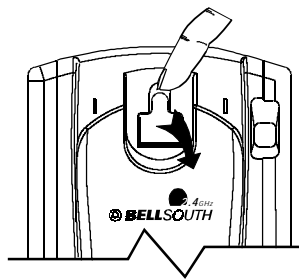

FIGURE 1

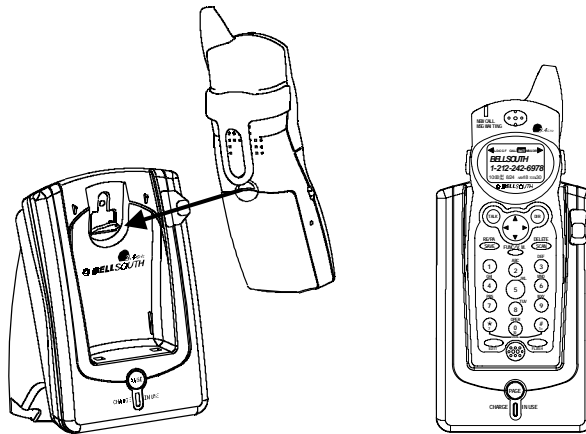

FIGURE 2

**IMPORTANT:** To prevent the **HANDSET** from falling and make sure the **HANDSET** is properly charged, please place the **HANDSET** to its cradle carefully and check there is a beep heard.

## Cordless Telephone Operation

### Preparing for Use

Before you can use your cordless telephone, you must charge the **HANDSET** for 12 hours. Failure to do so will require recharging of the **BATTERY PACK** more often.

1. Place the **HANDSET** on the **BASE UNIT** for 12 hours.
2. After 12 hours, remove the **HANDSET** from the **BASE UNIT**.

**Before you can use your cordless telephone, you must charge the HANDSET for 12 hours. Failure to do so will require more frequent charging of the BATTERY PACK. See page 29 for more information on the BATTERY PACK.**

### NOTE:

Depending on the frequency of use, once the **HANDSET** is fully charged, it remains functional for approximately 4 hours of continuous use and approximately 5 days when the **HANDSET** is off the **BASE UNIT** in **STANDBY** mode.

### □NO LINE□ Indicator

This telephone will always check the **TELEPHONE LINE** connected to it. If □NO LINE□ appears on the **HANDSET LCD Screen** in **STANDBY** mode, it maybe the **TELEPHONE LINE** is not plugged or not properly connected, or the **TELEPHONE LINE** plugged is not workable. When seeing this, you have to check the line connection and make sure the □NO LINE□ is not displayed on the **HANDSET LCD Screen**. Otherwise your cordless telephone can not be used to receive or make a call.

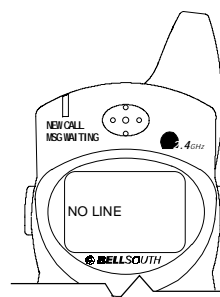

### Receiving Calls

1. When the phone rings, lift the **HANDSET** and press the **TALK** button. The **HANDSET LCD Screen** will display □CALLS□ and □TALKING□, and the **BASE UNIT IN USE LED** indicator will light up.
2. Start your conversation.
3. To end your conversation, either press the **TALK** button or place the **HANDSET** on the **BASE UNIT**. If you place the **HANDSET** on the **BASE UNIT CHARGE CRADLE**, you activate the automatic **STANDBY** feature.

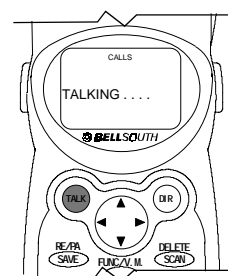

## Cordless Telephone Operation

### NOTE:

1. The Call Timer will start to count once you press the **TALK** button.
2. The LCD Screen emits light for 5 seconds every time you press any of the TELEPHONE KEYPAD buttons.
3. When "CALLS" appears on the LCD Screen, it means that the **HANDSET** is OFF-HOOK (connected to the telephone line).

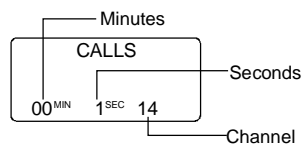

### Placing Calls

1. Press the **TALK** button, the Call Timer starts to count. The **HANDSET** LCD Screen will display [CALLS], and [TALKING], and the **BASE UNIT** IN USE LED indicator will light up.
2. Listen for a dial tone.
3. Dial the phone number.
4. When you have finished with your call, press the **TALK** button again or place the **HANDSET** on the **BASE UNIT**.

### OR

1. Dial the phone number.
2. Press and hold down the DIAL 7 **7\*** or the DIAL 10 **10 OPER 0** or the DIAL 1+ **1+ #** button. The **BASE UNIT** IN USE LED indicator will light up.
3. When you have finished with your call, press the **TALK** button again or place the **HANDSET** on the **BASE UNIT**.

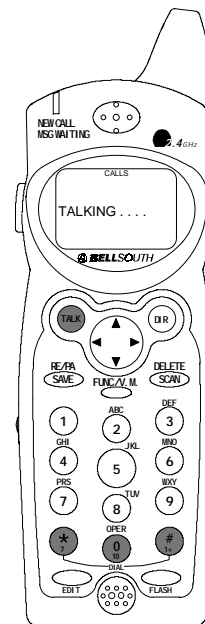

## Cordless Telephone Operation

### Using the Headset Feature

Your telephone can utilize a headset (not included) to be connected to your **HANDSET** for you to enjoy hands-free communication. Insert the small plug at the end of the headset into the **HEADSET JACK** at the right side of the **HANDSET**. Follow the procedures discussed in "Receiving Calls" and "Placing Calls" to receive and place a call.

**NOTE:** When you plug the headset plug into the **HEADSET JACK** it automatically mutes the **MICROPHONE** and **SPEAKER** of the **HANDSET**. Unplug the headset to return the **HANDSET** to normal use.

Headsets are available at most retail outlets that sell telephone equipment. The **HEADSET JACK** is compatible with 2.5 mm headset plugs only.

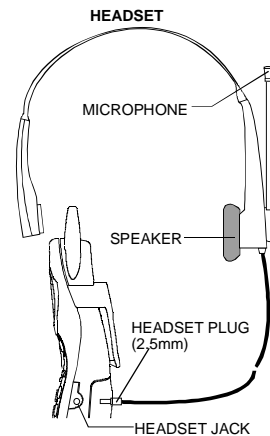

### Redial Feature

1. If you get a busy tone, press the **TALK** button or place the **HANDSET** on the **BASE UNIT** to hang up.
2. Later, press the **TALK** button again.
3. Listen for a dial tone.
4. Press the **RE/PA SAVE** button. This will automatically redial the last telephone number you called in TALK mode.
5. When you have finished with your call, press the **TALK** button again (the **BASE UNIT IN USE** LED indicator will turn off) or place the **HANDSET** on the **BASE UNIT**.

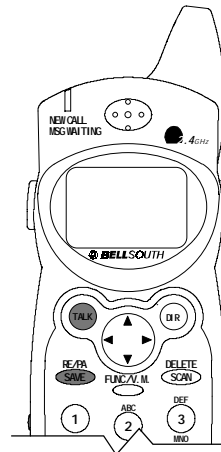

**NOTE:**

If you are too far away from the **BASE UNIT**, the **HANDSET** emits "beep" sounds to warn you that the background noise level is too high for proper communication between the **HANDSET** and the **BASE UNIT**. When you hear this sound, you should move closer to the **BASE UNIT** to reduce the noise level. Otherwise, the call will automatically cut off.

## Caller ID System Operation

### Caller ID System

This telephone automatically displays an incoming caller's name and telephone number together with the date and time of the call. It records up to 80 calls and stores the data in Memory.

**IMPORTANT:** You must subscribe to the Caller ID service from your local telephone company to utilize this feature.

### Viewing Caller Information During Incoming Calls

1. When there is an incoming call, the name and the telephone number of the caller will automatically appear after the second ring. Press the SHIFT RIGHT  button to view a name of more than 11 characters.

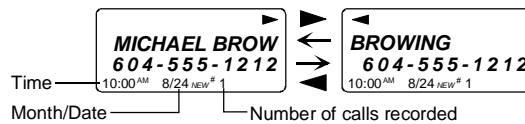

**OR**

Caller's telephone number will appear if the caller's name is not available.

**OR**

OUT OF AREA will appear if the origin of the incoming call does not support the Caller ID system.

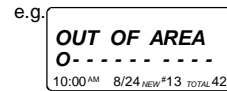

**OR**

UNKNOWN will appear if the origin of the incoming call has no name and does not support the Caller ID system.

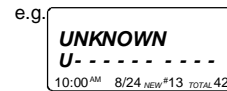

**OR**

PRIVATE and/or P----- will appear if the caller's name and/or telephone number is blocked.

**OR**

DATA ERROR will appear if wrong data was received from the telephone line.

**OR**

The name stored in the DIRECTORY will appear for an incoming call with matching telephone numbers.

### MSG WAITING (Message Waiting)

The MSG WAITING GREEN LED indicator will blink when there is a message for you from your telephone company if you have subscribed to Voice Mail message service and if you have requested Visual Message Indication from your local telephone company. MSG WAITING will appear on the LCD Screen in STANDBY mode. (To remove the MESSAGE WAITING indicator, see page 26 for detail.)

## Caller ID System Operation

### Call Waiting

When you subscribe to a Call Waiting service from your local telephone company, this telephone will display the name and number of the second caller while you are having a conversation with your first caller.

1. When you are having a conversation, this telephone will automatically display the name and number of the second caller. The name will be blinking.
2. Press the **FLASH** button to answer the second caller. The first caller's name and number will be displayed. The name will be blinking.
3. When you have finished, press the **FLASH** button to continue with your conversation with the first caller.

If you do not want to interrupt your phone conversation with the first caller, you can advise the second caller to leave a Voice Mail message instead.

e.g.   
1st Caller

e.g.   
2nd Caller

### Voice Mail Function

When there is a Voice Mail message for you, this telephone detects a Stutter Dial Tone (if applicable) and the **MSG** icon on the LCD Screen and the MESSAGE WAITING LED indicator will blink.

1. To access your Voice Mail message, press the **TALK** button.
2. After you hear a dial tone, press the **FUNC V.M.** button. This will automatically dial the Voice Mail Post Code in your area and connect you to the Voice Mail service provider.

**NOTE:** You must store the Voice Mail Post Code number by using the VOICE MAIL function on page 25. You can also call your Voice Mail service provider by dialing the Voice Mail Access Code number after pressing the **TALK** button.

### **C-F** (Forwarded Call)

Appears on the upper left hand side, when the incoming call has been assigned to your telephone number.

### **L-D-C** (Long Distance Call)

Appears on the upper left hand side, when the incoming call is a long distance call and the service is provided by your local telephone company.

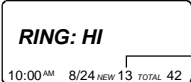

### Caller List

Record call information for up to 80 incoming calls such as caller's name and telephone number together with the date and time of the call. After recording a new incoming call, the NEW CALL indicator will blink and the display will look as shown below:

 No. of new calls  
Maximum calls= 80

## Caller ID System Operation



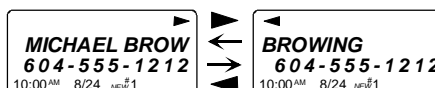

### Viewing the Caller List

1. Press the SCROLL DOWN  button to view the latest Caller ID record, or press the SCROLL UP  button to view the first Caller ID record, press the SHIFT RIGHT  button if the name has more than 11 digits.



2. Press the **DIR** button to go back to STANDBY mode. (If no active buttons are pressed for 20 seconds or you have viewed the last Caller ID record in the Caller's List, the LCD Screen will automatically return to STANDBY mode.)









### Placing a Call from the Caller List

1. Press the SCROLL DOWN  button to select from the latest Caller ID record, or press the SCROLL UP  button to select from the first Caller ID record.
2. Press and hold down the DIAL 7  button for a local call, or the DIAL 10  button for a local call with area code, or the DIAL 1 +  button for a long distance call.
3. To end your conversation, either press the **TALK** button or place the **HANDSET** on the **BASE UNIT**.

To place a call from the Caller List in TALK mode, press the **TALK** button, then follow steps 1 to 3.

**NOTE:** You can edit the number before dialing, but you cannot SAVE any changes in the Caller List.

### Editing the Caller List before Dialing



1. Press the SCROLL UP  or DOWN  button to find the caller.
2. Press the **EDIT** button.
3. Move the cursor by pressing the SHIFT LEFT  or RIGHT  button to the digit you want to change. To erase digits, press the **SCAN DELETE** button. To add digits, use the TELEPHONE KEYPAD  ~  buttons.
4. Press and hold down the DIAL 7  button for a local call, or the DIAL 10  button for a local call with area code, or the DIAL 1 +  button for a long distance call.
5. To end your conversation, either press the **TALK** button or place the **HANDSET** on the **BASE UNIT**.

To save the edited record from the Caller List, follow steps 1 to 3 then press and hold down the **RE/PA SAVE** button.



## Caller ID System Operation

### Saving the Name and Number in the Caller List into the DIRECTORY

1. Press the SCROLL UP  or DOWN  button to find the caller.
2. Press and hold down the  button.





**NOTE:** It is not advisable to save a telephone number without the corresponding name. This will lead to improper display on Anonymous (Private) and Unknown (Out of Area) calls.

### Deleting All Records in the Caller List

1. Press and hold down the  button for at least 3 seconds while in STANDBY mode.
2. The LCD Screen will automatically return to STANDBY mode.



### Selective Deleting in the Caller List

1. Press the SCROLL UP  or DOWN  button to find the Caller ID record while in STANDBY mode.
2. Press and hold down the  button for at least 3 seconds, then the LCD Screen will display the next Caller ID record in the DIRECTORY.
3. Press the  button to return to STANDBY mode.







### Name and Telephone Number DIRECTORY

This DIRECTORY lets you scroll through the list to find the record you need for one touch dialing. You can store up to 40 names and telephone numbers in the memory.

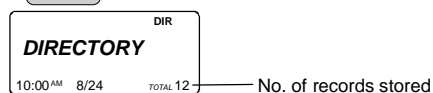
#### Viewing the DIRECTORY

1. Press the  button.



2. Press the SCROLL UP  or DOWN  button to find the one you need, press the SHIFT RIGHT  button if the name or telephone number is more than 11 digits.

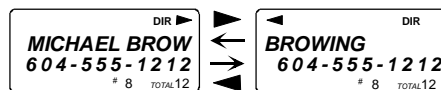

- NOTE:** To exit the DIRECTORY List at anytime, press the  button.









## Caller ID System Operation

### Speed Viewing the DIRECTORY



1. Press the **DIR** button.
2. Enter the first letter of a name. (See Page 27 for detail of entering a letter.)
3. Press the SCROLL DOWN  button to find all names with same first letter.

### Saving in the DIRECTORY



1. Press the **DIR** button.
2. Press the **EDIT** button.
3. Use the TELEPHONE KEYPAD  ~  buttons to enter the name, (see page 27 for detail) you can store up to 15 characters.
4. Press the SCROLL DOWN  button once.
5. Enter the telephone number using the TELEPHONE KEYPAD  ~  buttons.  
You can store up to 16 digits.
6. Press and hold down the  button.
7. Press the **DIR** button to go back to STANDBY mode.  
(If no active buttons are pressed for 20 seconds, the LCD Screen will automatically return to STANDBY mode.)

**NOTE:** It will not save a duplicate telephone number or a name without the corresponding telephone number in the DIRECTORY.

### PREFERRED CALLS

You can assign PREFERRED CALL which will generate a special ringer sound at the start of the second ring to any welcome caller in the DIRECTORY.  
When you are saving the name and number into the DIRECTORY, add a  mark at the beginning of the name by pressing the  button.

### BLOCKED CALLS

You can assign BLOCKED CALL which will disable the ringer sound from the second ring to any caller in the DIRECTORY.  
When you are saving the name and number into the DIRECTORY, add an  mark at the beginning of the name by pressing the  button.

## Caller ID System Operation

### Editing a Name and Number in the DIRECTORY











1. Press the **DIR** button.
2. Press the SCROLL UP  or DOWN  button to find the record you want to edit.



3. Press the **EDIT** button to edit the name.



cursor is blinking

4. Press the SCROLL LEFT  or RIGHT  button to move the cursor to the letter or number you want to change. To erase, press the **SCAN DELETE** button. To add, use the TELEPHONE KEYPAD  ~  buttons. (See page 27 for details.)
5. Press the SCROLL UP  or DOWN  button to edit the number.
6. Press the SCROLL LEFT  or RIGHT  button to move the cursor to the number you want to change. To erase, press the **SCAN DELETE** button. To add, use the TELEPHONE KEYPAD  ~  buttons. (See page 27 for details.)



cursor is blinking



7. Press and hold down the **RE/PA SAVE** button to confirm.

**IMPORTANT:** It is not advisable to save a telephone number without the corresponding name in the DIRECTORY. This will lead to improper displays on PRIVATE and OUT OF AREA calls.

**NOTE:** When no active buttons are pressed for 20 seconds, the LCD Screen will automatically return to STANDBY mode.

## Caller ID System Operation

### *Editing the Number in the DIRECTORY before Dialing*

1. Press the **DIR** button.
2. Press the SCROLL UP  or DOWN  button to find the caller.
3. Press the **EDIT** button to edit the name.
4. Press the SCROLL DOWN  button.



e.g.



5. Press the SCROLL LEFT  or RIGHT  button to move the cursor to the number you want to change.

To erase, press the **SCAN DELETE** button.





To add, use the TELEPHONE KEYPAD  ~  buttons.

6. Press and hold down the DIAL 7  button for a local call, or press and hold down the DIAL 10  button for a local call with area code, or press and hold down the DIAL 1+  button for a long distance call.
7. To end your conversation, either press the **TALK** button or place the **HANDSET** on the **BASE UNIT**.

**NOTE:** If you want to save the edited number in the DIRECTORY, follow steps 1 through 5 and then press and hold down the **RE/PA SAVE** button.

## Caller ID System Operation

### Placing Calls from the DIRECTORY

1. Press the **DIR** button.
2. Press the SCROLL UP  or DOWN  button to find the record you want to call.
3. Press and hold down the DIAL 7  button for a local call, or press and hold down the DIAL 10  button for a local call with area code, or press and hold down the DIAL 1+  button for a long distance call.
4. To end your conversation, either press the **TALK** button or place the **HANDSET** on the **BASE UNIT**.

### Deleting All Records in the DIRECTORY

1. Press the **DIR** button.
2. Press and hold down the **SCAN DELETE** button for at least 3 seconds while in DIRECTORY mode.

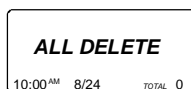

3. Press the **DIR** button to return to STANDBY mode.

### Selective Deleting in the DIRECTORY

1. Press the **DIR** button.
2. Press the SCROLL UP  or DOWN  button to find the record you want to delete.
3. Press and hold down the **SCAN DELETE** button for at least 3 seconds, then the LCD Screen will display the next record in the DIRECTORY.



4. Press the **DIR** button to return to STANDBY mode.

## Caller ID System Operation

### Function Operation

This unit contains the following special functions:

- |                  |                |
|------------------|----------------|
| A. LANGUAGE      | F. PBX NUMBER  |
| B. SILENT ON/OFF | G. FLASH TIME  |
| C. TIME SET      | H. PAUSE TIME  |
| D. RINGER VOLUME | I. VOICE MAIL  |
| E. LCD CONTRAST  | J. MSG WAITING |

To access, press the **FUNC V.M.** button at STANDBY mode, then press the TELEPHONE KEYPAD

**10 OPER 0** ~ **WXYZ 9** button or the SCROLL UP **▲** or DOWN **▼** button.

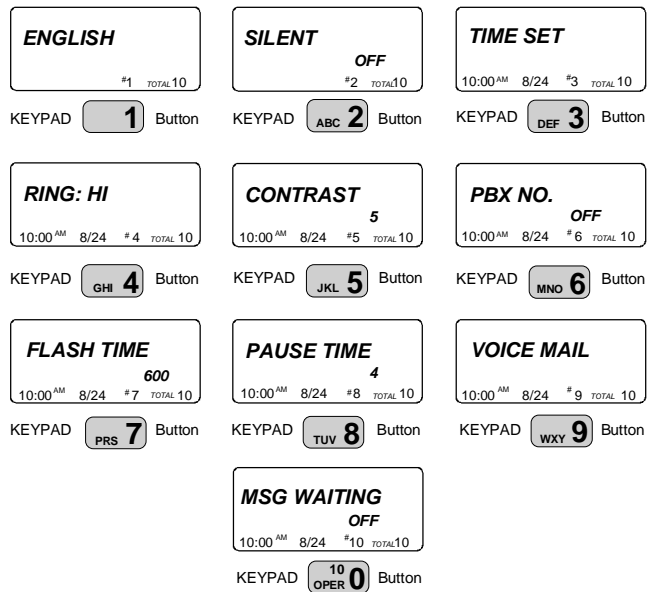

## Caller ID System Operation

### A. Language

This telephone offers English, Spanish, and French languages for your convenience.

1. Press the **FUNC V.M.** button.
2. Press the TELEPHONE KEYPAD **1** button.
3. Press the **EDIT** button.
4. Press the SCROLL UP **▲** or DOWN **▼** button to select the type at language you desire. You can also set the language by pressing the following TELEPHONE KEYPAD buttons; **1** for English, **ABC 2** for Spanish, or **DEF 3** for French. English is the preset language.
5. Press and hold down the **RE/PA SAVE** button.
6. Press the **FUNC V.M.** button to return to STANDBY mode.

### B. Silent On/Off

This telephone will generate the first ring sound even in the BLOCKED CALL mode to indicate that you have an incoming call. To keep the ringer silent in BLOCKED CALL mode, you can turn off the first ring sound.

1. Press the **FUNC V.M.** button.
2. Press the TELEPHONE KEYPAD **ABC 2** button.
3. Press the **EDIT** button.
4. Press the SCROLL UP **▲** or DOWN **▼** button to select the SILENT ON/OFF setting. You can also press the TELEPHONE KEYPAD buttons; **1** for ON or **ABC 2** for OFF. SILENT OFF is the preset mode.
5. Press and hold down the **RE/PA SAVE** button.
6. Press the **FUNC V.M.** button to return to STANDBY mode.

### C. Time Set

Set the date and time.

1. Press the **FUNC V.M.** button.
2. Press the TELEPHONE KEYPAD **DEF 3** button.
3. Press the **EDIT** button.
4. Use the TELEPHONE KEYPAD button to enter the month, date, hour and minute. The cursor moves automatically after entering each item. Press the TELEPHONE KEYPAD **1** for AM setting, or press the TELEPHONE KEYPAD **ABC 2** for PM setting.

## Caller ID System Operation

5. Press and hold down the **RE/PA SAVE** button.
  6. Press the **FUNC V.M.** button to return to STANDBY mode.
- NOTE:** The date and time will automatically set, if you have subscribed to the Caller ID service from your local telephone company.

### D. Ringer Volume

This function enables you to adjust the ringer volume from HI, LOW and OFF as desired.

1. Press the **FUNC V.M.** button.
2. Press the TELEPHONE KEYPAD **GHI 4** button.
3. Press the **EDIT** button.
4. Press the SCROLL UP **▲** or DOWN **▼** button to adjust the ringer volume suitable for your convenience. You can also adjust the ringer volume by pressing the following TELEPHONE KEYPAD buttons; **1** for HI, **ABC 2** for LOW, or **DEF 3** for OFF. HI is the preset ringer volume.
5. Press and hold down the **RE/PA SAVE** button.
6. Press the **FUNC V.M.** button to go back to STANDBY mode.

### E. LCD Contrast

This unit enables you to select 8 brightness levels for the Large LCD Screen.

1. Press the **FUNC V.M.** button.
2. Press the TELEPHONE KEYPAD **JKL 5** button.
3. Press the **EDIT** button.
4. Press the SCROLL UP **▲** or DOWN **▼** button to adjust the brightness of the LCD Screen. Level 5 is the preset brightness.
5. Press and hold down the **RE/PA SAVE** button until a confirmation “beep” is heard.
6. Press the **FUNC V.M.** button to go back to STANDBY mode.





### F. PBX Number



This unit enables you to preset the PBX number (such as an 8 or 9) while you are using a switchboard system.

1. Press the **FUNC V.M.** button.
2. Press the TELEPHONE KEYPAD **MNO 6** button.
3. Press the **EDIT** button.











## Caller ID System Operation

4. Press the SCROLL UP  or DOWN  button. (OFF is the preset PBX number.)  
PBX MODE OFF - set for direct line access.
5. Press and hold down the  button.
6. Press the  button to go back to STANDBY mode.

**NOTE:** When placing a call by using the DIAL 7  or the DIAL 10  or the DIAL 1+  button, this telephone will automatically add the PBX number and a pause time before the dialed telephone numbers.







### G. Flash Time

This unit enables you to select the standard FLASH TIME applicable to your calling area. If you are not sure of the FLASH TIME you are using, call your local telephone company.

1. Press the  button.
2. Press the TELEPHONE KEYPAD  button.
3. Press the  button.
4. Press the SCROLL UP  or DOWN  button to select the FLASH TIME. You can also set the FLASH TIME by entering the FLASH TIME number using the TELEPHONE KEYPAD  ~  buttons. The preset FLASH TIME is 600 milliseconds.
5. Press and hold down the  button.
6. Press the  button to go back to STANDBY mode.

### H. Pause Time

This unit enables you to adjust the PAUSE TIME when placing a call using a switchboard system or dialing long distance calls.

1. Press the  button.
2. Press the TELEPHONE KEYPAD  button.
3. Press the  button.
4. Press the SCROLL UP  or DOWN  button to adjust the pausing time. The preset pause time is 4 seconds.
5. Press and hold down the  button.
6. Press the  button to return to STANDBY mode.

## Caller ID System Operation

### I. Voice Mail

This telephone enables you to store the Voice Mail Access Code number in your area. This will automatically connect you to the Voice Mail service provider with one-touch dialing.

1. Press the **FUNC V.M.** button.
2. Press the TELEPHONE KEYPAD **WXYZ 9** button.
3. Press the **EDIT** button.
4. Enter the Voice Mail Post Code number by using the TELEPHONE KEYPAD **10 OPER 0** ~ **WXYZ 9** buttons.
5. Press and hold down the **RE/PA SAVE** button.
6. Press the **FUNC V.M.** button to go back to STANDBY mode.

### J. MSG Waiting (Message Waiting)

To turn off the Message Waiting LCD Screen indicator.

1. Press the **FUNC V.M.** button.
2. Press the TELEPHONE KEYPAD **10 OPER 0** button.
3. Press the **EDIT** button.
4. Press the SCROLL UP **▲** or DOWN **▼** button.
5. Press and hold down the **RE/PA SAVE** button.
6. Press the **FUNC V.M.** button to go back to STANDBY mode.

**IMPORTANT:** Message Waiting LCD indicator will automatically turn ON, if you have subscribed to Voice Mail message service and if you have Visual Message Indication from your local telephone company.

### IMPORTANT

In order to utilize the Caller ID feature, you must subscribe to Caller ID service from your local telephone company

## Caller ID System Operation







### Telephone Keypad Character

The TELEPHONE KEYPAD  ~  buttons are used to enter characters when entering names. Press the appropriate TELEPHONE KEYPAD button to get the following characters.





KEYPAD BUTTONS	CHARACTERS
1	SPACE & ' ( ) * . 1
2	A B C 2
3	D E F 3
4	G H I 4
5	J K L 5
6	M N O 6
7	P Q R S 7
8	T U V 8
9	W X Y Z 9
*	*
0	0
#	#

#### EXAMPLE:

If you want to enter the character [ACE] on the HANDSET LCD Screen.

1. Press the  button.
2. Press the  button.
3. Press the TELEPHONE KEYPAD  button, [A] will be displayed. Press the SHIFT RIGHT  button to move the cursor to next (See NOTES below.).
4. Press the TELEPHONE KEYPAD  button three times to display [C].
5. Press the TELEPHONE KEYPAD  button two times to display [E].

#### NOTES:

1. To enter the next character, press the appropriate button. If, however, the next character is on the same button as the previous character, you will first need to press the SHIFT RIGHT  button. Pressing the SHIFT RIGHT  button a second time will produce a space.
2. If you want to change any character, you can go back to the incorrect character by pressing the SHIFT LEFT  button. To delete the character inside the cursor [ ] , press the  button.
3. You can store a maximum of 15 characters on the letter icon.
4. You can store a maximum of 16 digits on the number icon.

## *Security*

### *Security System*

Your cordless telephone uses a digital coding security system to prevent unauthorized use of your telephone line by another nearby cordless telephone. The system has its own identifying signal created by microcomputers in both the **BASE UNIT** and the **HANDSET**.

### *Security Code*

This telephone has an internal security code with 65,536 possible combinations.

### *Resetting Security Code and Channel Information*

Communication between the **HANDSET** and the **BASE UNIT** may not be possible in any of the following situations:

1. After a power failure.
2. After relocating the **BASE UNIT** by disconnecting the AC ADAPTER.
3. After replacing the **HANDSET BATTERY PACK**.

To reset, place the **HANDSET** on the **BASE UNIT** for 2 to 5 seconds.

### *Multi-Channel Access*

Your cordless telephone lets you select a channel from the 40 frequencies available to transmit signals between the **BASE UNIT** and **HANDSET**. When you notice interference from other cordless telephones, change to another channel by pressing the  button on the **HANDSET**.

## *Recharging the BATTERY PACK*

### *Battery Type*

Use the following type and size of BATTERY PACK:

Cordless Telephone BATTERY PACK  
3.6V, 600mAh  
U.S. Electronics Inc.  
Ni-Mh Battery Pack: model B655

This BATTERY PACK is available through:

**U.S. Electronics Service Center**  
**105 Madison Avenue**  
**New York, NY 10016**  
**1-800-825-5208**

**NOTE: During a power interruption, the BASE UNIT does not operate, and a phone conversation cannot be made on the HANDSET.**

### *Recharging the Battery Pack*

The nickel metal hydride (Ni-Mh) BATTERY PACK in the **HANDSET** can be recharged many times using the built-in charger in the **BASE UNIT**.

When the BATT LOW symbol appears on the LCD Screen, a [beep] sound will be heard every 10 seconds. This indicates that the BATTERY PACK needs to be recharged.

Charge the BATTERY PACK at least once every 90 days of non-use to avoid battery failure. When the BATTERY PACK can no longer be charged, replacement of the BATTERY PACK will be necessary.

The BATTERY PACK used in your telephone may develop a condition known as [MEMORY]. Once subjected to a regular short discharging routine, the BATTERY PACK assumes the discharging pattern it was subjected to. This is known as a [MEMORY] condition which causes rapid discharging thereby shortening the BATTERY PACK charge span. If you believe your BATTERY PACK has developed a [MEMORY] condition, do not charge the **HANDSET** until the BATT LOW symbol appears on the LCD Screen. When the BATT LOW symbol appears on the LCD Screen, charge the **HANDSET** fully for 12 hours.

### **IMPORTANT**

**In order to get maximum life from the HANDSET BATTERY PACK, be sure to charge the HANDSET for 12 hours before initial use.**

## Changing the BATTERY PACK

### Changing the Battery Pack

The BATTERY PACK provides power for the **HANDSET** of your cordless telephone.

#### To Replace BATTERY PACK:

1. Remove the **HANDSET BATTERY COMPARTMENT COVER** by sliding it down.
2. Pull out the **BATTERY PACK PLUG** and remove the **BATTERY PACK**.
3. Plug the new **BATTERY PACK** into the **BATTERY CONNECTOR**.
4. Slide the **HANDSET BATTERY COMPARTMENT COVER** firmly into place in its closed position.
5. Before use, charge the new **BATTERY PACK** for 12 hours.

#### ATTENTION:

The telephone that you have purchased contains a rechargeable BATTERY PACK. At the end of its useful life, under various state and local laws, it may be illegal to dispose of this BATTERY PACK into the municipal waste stream. Check with your local solid waste officials for details in your area for proper disposal.

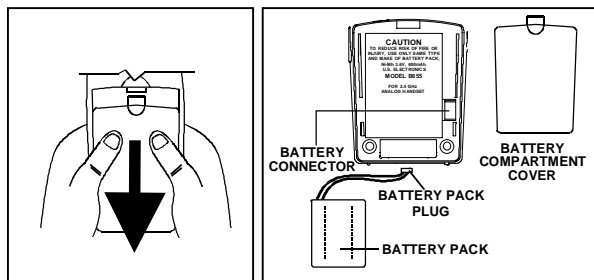

Remove the **HANDSET BATTERY COMPARTMENT COVER** by sliding it down.

## Problem Solving

### *Problem Solving Section*

For your assistance, we have listed below a few common problems.

#### *Phone does not work, check the following:*

1. **BASE UNIT** is plugged into a power source.
2. **HANDSET** is charged.
3. TONE/PULSE Select switch is in the right position.
4. TELEPHONE LINE CORD is plugged into the TELEPHONE JACK.

#### *Range of phone limited, check the following:*

1. **BASE UNIT** is centrally located in your residence.
2. **BASE UNIT** is not located near appliances.

#### *No dial tone, check the following:*

1. TELEPHONE LINE CORD plugs are connected to the TELEPHONE JACK and TELEPHONE LINE CONNECTION JACK.
2. **BASE UNIT** is plugged into power source.
3. If you had a power failure or had unplugged the **BASE UNIT**, replace the **HANDSET** on the **BASE UNIT** for 2 to 5 seconds to reset the system.

#### *Received signal flutters or fades, check the following:*

1. BATTERY PACK in the **HANDSET** is fully charged.
2. **HANDSET** is not too far from the **BASE UNIT**.

#### *Interference on reception, check the following:*

1. Noise may be picked up from electrical products in the home or electrical storms. Generally, this noise is a minor annoyance and should not be interpreted as a defect in your system. (See Technical Information on page 32.)
2. Choose an alternate channel using the **SCAN DELETE** button on the **HANDSET**.
3. Do not use this telephone within 20 ft. of a microwave oven while it is working, as you may experience interference. This is a normal occurrence with 2.4GHz phones and should not be interpreted as a defect in the product.

#### *Long Distance [ L-D-C ] indicator is not ON when receiving a long distance call, check the following:*

1. Your local telephone company can provide the Area Code on an incoming long distance call.

#### *Excess static, check the following:*

1. Check to see that the ANTENNA is not touching another metal object.

#### *If after pressing the **TALK** button, you receive three [ beeps ] and no dial tone, check the following:*

1. **BASE UNIT** is plugged into a power source.
2. If you had a power failure or had unplugged the **BASE UNIT**, replace the **HANDSET** on the **BASE UNIT** for 2 to 5 seconds to reset the system.

**NOTE:** If none of telephones in the house are working, disconnect one set at a time to verify that none of the phones are causing the problem. If you still have a problem after doing this, and your telephone still does not work, please contact your local phone company.

## *Technical Information*

### *Technical Information*

This cordless telephone uses radio frequencies to allow mobility. There are certain difficulties in using radio frequencies with a cordless telephone. While these are normal, the following could affect the operation of your system.

### *Noise*

Electrical pulse noise is present in most homes at one time or another. This noise is most intense during electrical storms. Certain kinds of electrical equipment such as light dimmers, fluorescent bulbs, motors, and fans also generate noise pulses. Because radio frequencies are susceptible to these noise pulses, you may occasionally hear them in your **HANDSET**. Generally they are a minor annoyance and should not be interpreted as a defect in your system.

### *Range*

Because radio frequency is used, the location of the **BASE UNIT** can affect the operating range. Try several locations in your home or office and pick the one that gives you the clearest signal to the **HANDSET**.

### *Interference*

Electronic circuits activate a relay to connect the cordless telephone to your telephone line. These electronic circuits operate in the radio frequency spectrum. While several protection circuits are used to prevent unwanted signals, there may be periods when these unwanted signals enter the **BASE UNIT**. You may hear clicks or hear the relay activate while you are not using the **HANDSET**. If the interference occurs frequently, it can be minimized or eliminated by relocating the **BASE UNIT**. You can check for interference before selecting the final **BASE UNIT** location by plugging in the telephone.

### *NOTICE:*

This cordless telephone uses radio communication between the **HANDSET** and the **BASE UNIT** and may not ensure privacy of communication. Other devices, including another cordless telephones, may interfere with the operation of this cordless telephone or cause noise during operation. Units not containing coded access may be accessed by other radio communication systems. Cordless telephones must not cause interference to any licensed radio service.

### **IMPORTANT**

**When you hear interference, press the  
**SCAN** button to change the operating  
channel.**



## *FCC Requirements*

### *Federal Communications Commission Requirements*

This equipment complies with Part 68 of the FCC rules. A label on the **BASE UNIT** of the equipment contains, among other information, the FCC Registration Number and the Ringer Equivalence Number (REN) for this equipment. You must, upon request, provide this information to your telephone company.

The REN is also useful in determining the number of devices that you may connect to your telephone line and still allow all of these devices to ring when your telephone number is called. In most, but not all areas, the sum of the RENs of all devices connected to one line should not exceed five (5.0). To be certain of the number of devices that you may connect to your line, contact your local telephone company.

If your equipment should cause harm to the telephone network, the telephone company may temporarily disconnect your service. If possible, they will notify you in advance that temporary discontinuance of service may be required.

However, when advance written notice is not possible, the telephone company may temporarily discontinue service without notice if such action is necessary under the circumstances. The telephone company may make changes in its communication facilities, equipment, operations, or procedures where such action is reasonably required in the operation of its business and is not inconsistent with the rules and regulations of the Federal Communications Commission.

**Do not attempt to repair or modify this equipment.**

**Warning:** Changes or modifications not expressly approved by the party responsible for its compliance could void the user's authority to operate the equipment.

Some cordless telephones operate at frequencies that may cause interference to nearby TV's and VCR's. To minimize or prevent such interference, the **BASE UNIT** of the cordless telephone should not be placed on or near a TV or VCR. If interference is experienced, moving the cordless telephone farther away from the TV or VCR will often reduce or eliminate the interference.

This equipment should not be used on coin telephone lines. Connection to party line service is subject to state tariffs. If trouble is experienced, disconnect this equipment from the telephone line to determine if it is causing the malfunction. If the equipment is determined to be malfunctioning, its use should be discontinued until the problem has been corrected.

### **IMPORTANT**

**Placing your BASE UNIT near appliances such as televisions, refrigerators, radios, or microwave ovens may cause interference.**

## *FCC Requirements*

### ***Federal Communications Commission Requirements (continued)***

**NOTE:** This equipment has been tested and found to comply with the limits for a Class B digital device, pursuant to Part 15 of the FCC Rules. These limits are designed to provide reasonable protection against harmful interference in a residential installation. This equipment generates, uses, and can radiate radio frequency energy and, if not installed and used in accordance with the instructions, may cause harmful interference to radio communications. However, there is no guarantee that interference will not occur in a particular installation. If the equipment does cause harmful interference to radio or television reception, which can be determined by turning the equipment off and on, the user is encouraged to try to correct the interference by one or more of the following measures:

- Reorient or relocate the receiving ANTENNA.
- Increase the distance between the equipment and the receiver.
- Connect the equipment into an outlet on a circuit different from that to which the receiver is connected.
- Consult the dealer or an experienced radio/TV technician for help.

This device complies with Part 15 of the FCC Rules. Operation is subjected to the following two conditions:

- (1) this device may not cause harmful interference, and
- (2) this device must accept any interference received including interference that may cause undesired operation.

## Warranty

### *Warranty Information*

#### **BellSouth Products**

#### One-Year Limited Warranty

This limited warranty sets forth all **BellSouth Products** responsibilities regarding your telephone. There are no other expressed or implied warranties from **BellSouth Products**.

### *Warranty Service Provided*

If you purchased the telephone new from a retail vendor, **BellSouth Products** warrants the telephone against defects in material and workmanship for a period of one (1) year from the original date of purchase. This warranty is in lieu of all other express warranties. This warranty begins when you purchase the telephone and continues for one (1) year unless you sell or rent the telephone, in which case the warranty stops.

**BellSouth Products** disclaims any implied warranty, including the warranty of merchantability and the warranty of fitness for a particular purpose, as of the date of 90 days from your original purchase of the telephone. **BellSouth Products** assumes no responsibility for any special, incidental, or consequential damages.

This warranty gives you specific legal rights and you may have other rights which vary from state to state. Some states do not allow the exclusion or limitations of special, incidental or consequential damages, or limitations on how long a warranty lasts, so the above exclusion and limitation may not apply to you.

### *Warranty Service Not Provided*

This warranty does not cover damage resulting from accident, misuse, abuse, improper installation or operation, lack of reasonable care, unauthorized modification, or the affixing of any attachment not provided by **BellSouth Products** with the telephone, and/or loss of parts. This warranty is voided in the event any unauthorized person opens, alters or repairs the telephone.

All **BellSouth** equipment being returned for repair must be suitably packaged.

Telephone companies use different types of equipment and offer various types of services to customers. **BellSouth Products** does not warrant that this telephone is compatible with the type of equipment of any particular telephone company or the services provided by it.

## *Warranty*

### *What To Do for Warranty Service*

During the first thirty (30) days, a defective product is eligible for over-the-counter exchange at the retailer from whom it was purchased. After thirty (30) days, the defective product should be returned to the authorized service center. Please allow 2-3 weeks for the return of your telephone product. The shipping address of the authorized service center is:

U.S. Electronics Consumer Center  
C/O Southern Bonded Warehouse  
7137 Southlake Parkway  
Morrow, GA 30260

**NOTE:** A telephone product received which was not made for **BellSouth Products** or which is not defective as determined by our test procedures will not be repaired and will be returned to you C.O.D., freight collect.

### *To Obtain Warranty Service*

- Provide proof of the date of purchase within the package.
- Prepay all shipping costs to the authorized service center.
- Include a return shipping address within the package.

Please retain your sales receipt, the carton, the packing materials, and the printed material. The original carton is the best shipping container for the telephone should you have to return it.

For your reference:

Serial Number \_\_\_\_\_

Date of Purchase \_\_\_\_\_

Name of Dealer \_\_\_\_\_

**Customer Service Telephone Number:**  
**1-800-210-8950**  
**OUTSIDE THE U.S.A. CALL 1-212-242-6978**

*Notes*

*Notes*

## Wall Mounting Template

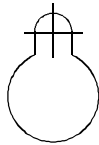

This page serves as a template for attachment of screws to the wall when mounting this telephone on the wall.

1. Cut out this page.
2. Use this template to determine the distance between screws when mounting this phone on the wall. The two cross hairs identify where to attach the screws.

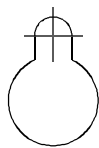

**IMPORTANT**

In order to get maximum life from the **HANDSET BATTERY PACK**, be sure to charge the **HANDSET** for 12 hours before initial use.

**IMPORTANT**

Placing your **BASE UNIT** near appliances such as televisions, refrigerators, radios, or microwave ovens may cause interference.

**IMPORTANT**

When you hear interference, press the **SCAN** button to change the operating channel.

**IMPORTANT**

The **AC ADAPTER** must always be plugged into an electrical outlet.

**IMPORTANT**

If you live in an area which gets frequent thunderstorms, we strongly recommend plugging your **AC ADAPTER** into a surge protector.





## 2.4 GHz CORDLESS CALLER ID TELEPHONE WITH CALL WAITING

40 CHANNEL AUTOSCAN

Model GH9457

OWNER'S MANUAL  
INSTALLATION AND  
OPERATING  
INSTRUCTIONS

**PLEASE READ THIS  
MANUAL CAREFULLY  
BEFORE USE.  
KEEP FOR YOUR  
REFERENCE.**

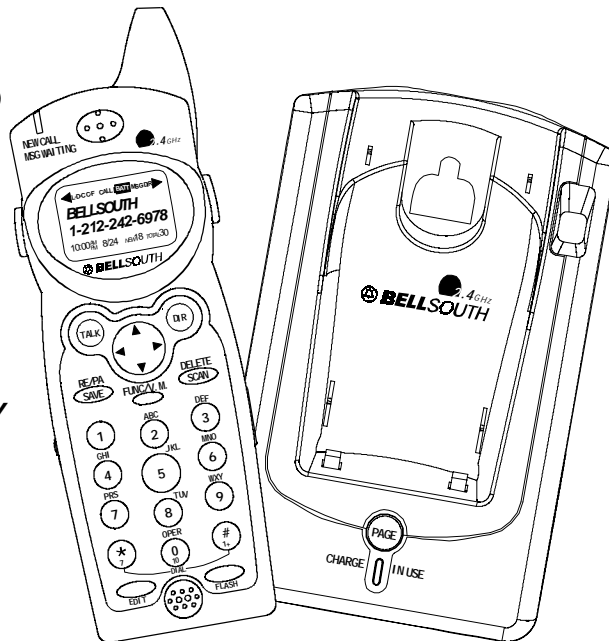

**For installation information, please  
see [Getting Started] instructions  
on page 5 or your separate Quick  
Start Guide.**

© 2002 BellSouth Corporation

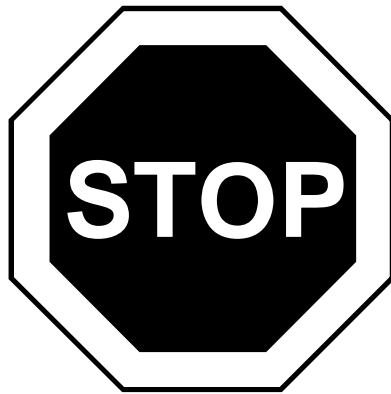

Make certain you receive the best  
performance from your telephone.  
Read this manual first.

 **BELLSOUTH**

Made in China



## Special Features

Congratulations on your selection of a quality **BellSouth** product. With proper care, and by following the set-up and user instructions in this manual, this unit will provide you with years of trouble-free service.

**BellSouth** is committed to providing quality products that fit your needs. We would like to have any comments or suggestions you might have on this product. You may mail your comments to:

**U.S. Electronics  
105 Madison Avenue  
New York, NY 10016**

When examining your new **BellSouth** cordless telephone, you will find an array of special features including:

**Filtered Sound™ System** - Gets considerably less noise than conventional cordless telephones because of a special circuit which delivers the clearest possible reception.

**40 Channel Auto Scan** - Press the **SCAN DELETE** button on the **HANDSET** to find and lock on to the clearest channel for any call.

**Desk or Wall Mount** - Use this equipment as a desk phone or as a wall phone.

**TONE or PULSE Dialing** - Use this phone for either TONE or push-button PULSE (rotary) dialing.

**Automated Functions** - Redial the last number called and automatic STANDBY mode.

**Security** - Ensures greater privacy because a built-in security code with 65,536 combinations prevents use of your telephone line by another nearby cordless phone.

**Dependable Battery** - Recharge your BATTERY PACK many times with the built-in charger. The battery low warning tone tells you when the BATTERY PACK needs recharging. (See page 29.)

**Special Services** - Use the **FLASH** button to access special services such as Call Waiting supplied by your telephone company or company switchboard.

**STANDBY Mode** - When in STANDBY mode (ON-HOOK), the phone is capable of receiving a call. When the **HANDSET** is on the **BASE UNIT**, it is automatically in the STANDBY mode (ON-HOOK). When the **HANDSET** is taken off the **BASE UNIT**, it remains in the STANDBY mode until you activate the **TALK** button.

**Battery Power Saver** - Once fully charged, in STANDBY mode, the **HANDSET** can receive/send calls for a maximum of five days without the need for recharging. Length of charge depends on frequency of use.

**Luminous LCD Screen** - The LCD Screen emits light for 5 seconds every time you press any of the TELEPHONE KEYPAD buttons.

**HANDSET Ringer Level** - Select the ringer volume level (HI, LOW, OFF).

**HANDSET VOLUME CONTROL Switch** - Select the receiver volume level (HI, MID, LOW).

## *Special Features*

**HEADSET JACK** - Your telephone can utilize a headset for hands-free communication.

**BELT CLIP** - Use the **BELT CLIP** to hang your **HANDSET** on your belt.

### *CALLER ID SYSTEM*

**Multi-Function Large LCD Screen** - Shows the number you are dialing, and with Caller ID service (available through subscription from your local telephone company), displays information about the caller before you answer the call.

**Name and Number DIRECTORY** - Stores up to 40 names and numbers so that you can call them with a single key stroke.

**Caller List** - Available with Caller ID service. Stores up to 80 calls to keep track of everyone who called. The name, phone number, time, and date of the call are recorded. Allows you to return their calls with a single key stroke.

**Preferred Calls** - You can mark the name and number of a welcome caller in the **DIRECTORY**. When that number calls in, the caller's name will appear on the **DISPLAY** and a special ring sound will be heard.

**Blocked Calls** - You can mark the name and number of an unwelcome caller in the **DIRECTORY**. When that number calls in, the caller's name will appear on the **DISPLAY** and the ringer will be disabled.

**Repeat Call Indicator** - Shows if a new incoming call has called more than once.

**Out of Area Call Indicator** - Advises you that the incoming call is not in a Caller ID service area, or does not support the Caller ID system.

**Private Call Indicator** - Advises you that the caller's name and/or telephone number of the incoming call is blocked by system.

**Call Waiting Service** - Displays the name and number of the second caller, if you have subscribed for call waiting service from your local telephone company (See page 15).

**Voice Mail** - Indicates message waiting signal if you subscribed to Voice Mail message service and requested Visual Message Indication from your local telephone company (see page 15). This telephone also detects a Stutter Dial Tone signal every time there is a Voice Mail message for your Voice Mail message provider if you have subscribed to Voice Mail message service.



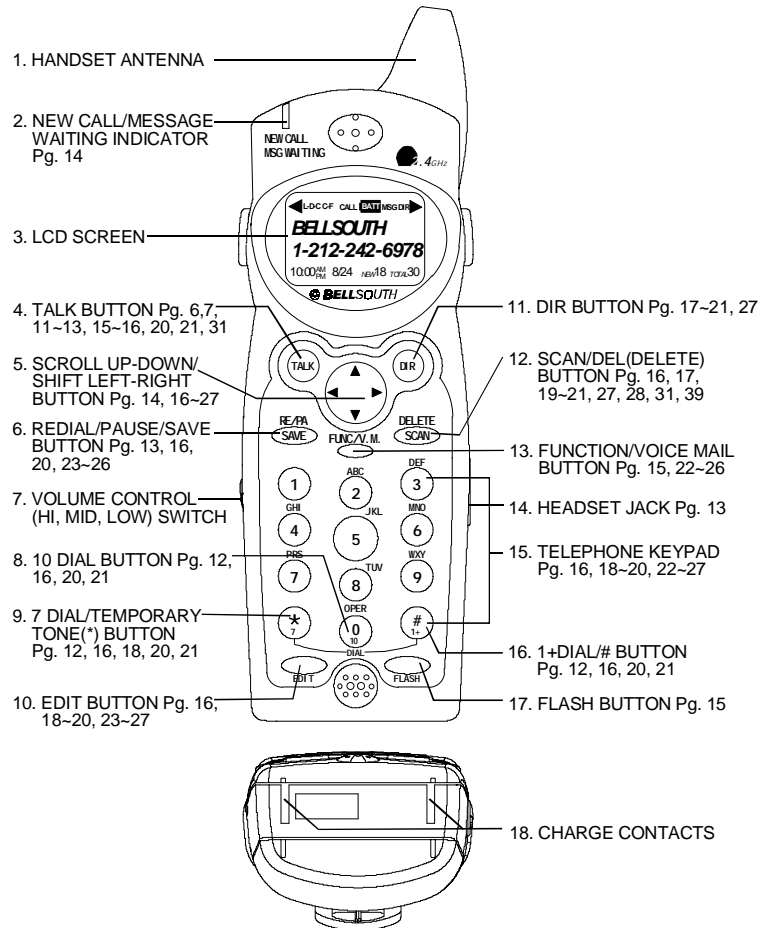







## HANDSET Controls



### HANDSET Control

- HANDSET ANTENNA**
- NEW CALL/MSG (MESSAGE) WAITING LED Indicator:** Blinks when recording a new incoming call or when receiving Message Waiting signal, if you have subscribed to a Voice Mail message service from your local telephone company. (See page 14 for details.)
- LCD Screen:** Shows call information, phone status, prompts and directory items.
- TALK TALK Button:** Press to answer an incoming call or to place a call. Press to end a call.

## HANDSET Controls

5. **SCROLL UP-DOWN, SHIFT LEFT-RIGHT**  **Button:** Press to move around the Large LCD Screen.
6. **SAVE/RE(REDIAL)/PA(PAUSE)**  **Button:** (SAVE) Press and hold down to save the changes on the listed items. (REDIAL) Press to redial the last number you dialed. (PAUSE) Press to insert a pause while dialing. (You will need the  button to dial numbers which use an alternative long distance access code.)
7. **HANDSET VOLUME CONTROL (hi, mid low) Switch:** Select the receiver volume level (HI, MID, LOW).
8. **DIAL 10/0**  **Button:** (DIAL 10) Press and hold down to place a local call with Area Code.
9. **DIAL 7/TEMPORARY TONE**  **Button:** (DIAL 7) Press and hold down to place a local call. (\*) Press to temporarily change the dialing mode from Pulse to Tone for rotary service users. (Press once before entering numbers to access the answering system or electronic banking service, etc.)
10. **EDIT**  **Button:** Press to edit listed items.
11. **DIR (DIRECTORY)**  **Button:** Press to access names and numbers stored in the DIRECTORY. (See page 16 to 21 for details.)
12. **SCAN/DEL**  **(DELETE) Button:** (SCAN) Press to change the operating channel when you hear interference. (DELETE) Press and hold down to delete items or individual characters.
13. **FUNC (FUNCTION)/V.M. (VOICE MAIL)**  **Button:** Press to access special functions operation in STANDBY mode. (For special functions see page 22.)  
(VOICE MAIL) - Press to automatically dial the Voice Mail Post Code in your area to access your Voice Mail message.
14. **HEADSET JACK:** For connecting your headset plug to enjoy hands-free communication. (See page 13 for detail.)
15. **TELEPHONE KEYPAD:** Allows you to make a call depending on pressed button. (For TELEPHONE KEYPAD characters, see page 27.)
16. **DIAL 1+/#**  **Button:** (DIAL 1+) Press and hold down to place a long distance call. (Automatically adds the number 1 at the beginning of the displayed telephone number.)
17. **FLASH**  **Button:** Press to answer a call if you have Call Waiting.
18. **CHARGE CONTACTS:** For charging the BATTERY PACK inside the **HANDSET**. We recommend cleaning the CHARGE CONTACTS periodically with a damp cloth.

## BASE UNIT Controls

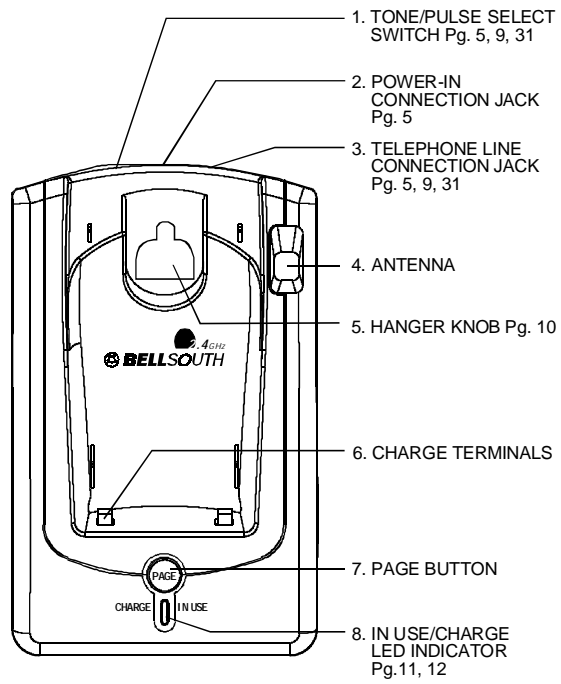

## *BASE UNIT Controls*

1. **TONE/PULSE Select Switch**
2. **POWER-IN CONNECTION JACK**
3. **TELEPHONE LINE CONNECTION JACK**
4. **ANTENNA**
5. **HANGER KNOB:** Use to secure to the **HANDSET** in position when WALL mounting.
6. **CHARGE TERMINALS:** For charging the **HANDSET BATTERY PACK**. For best performance, clean the CHARGE TERMINALS periodically with a damp cloth.
7. **PAGE** **PAGE** Button: Press to page the **HANDSET**.
8. **IN USE/CHARGE LED Indicator:** (IN USE) Lights up to indicate that the **HANDSET** is in TALK mode. (CHARGE) Lights up when the **HANDSET** is placed on the **BASE UNIT** for charging.

### **IMPORTANT**

**Placing your BASE UNIT near appliances such as televisions, refrigerators, radios, or microwave ovens may cause interference.**