

Home Network User Manual

PMN: Wall PAD

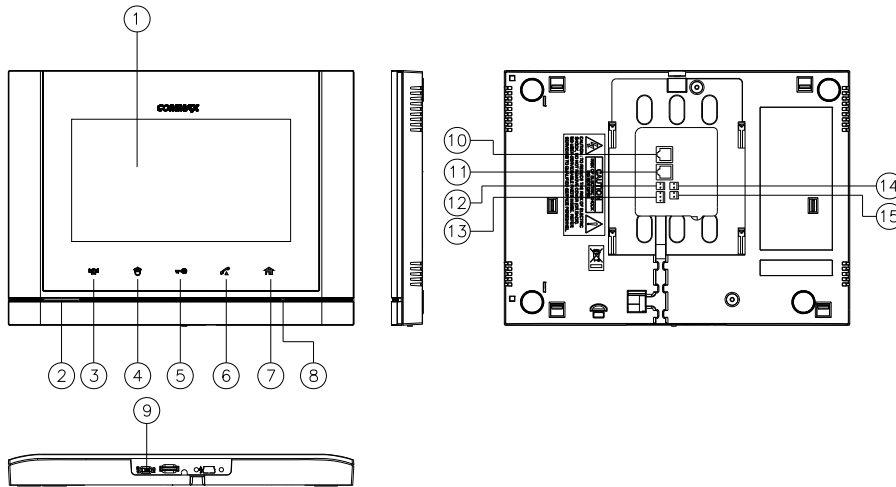

Table of Contents

Introduction	3
Part name	3
Display composition	4
1 Screen Saver	5
1.1. Information provided from the screen saver	5
2 Home Display.....	6
3 Notice	7
4 Control	8
4.1. FCU Control.....	8
5 Application	10
5.1. Intercom.....	11
5.2. Security.....	14
5.3. Home History	16
5.4. ETC.....	17
6 Away/Stay Mode.....	19
7 Appendix	23
7.1. Using the Owner mobile app.....	23
7.2. Using the Guest mobile app.....	27
7.3. Etc.....	30
7.4. Name Search(LOBBY PHONE).....오류! 책갈피가 정의되어 있지 않습니다.	

Introduction

Part name



① TFT LCD	⑩ PoE
② Speaker	⑪ PIR
③ Emergency button	1. Sensor_in, 2. GND, 3. VCC
④ Call guard station	⑫ EM
⑤ Door release button	⑬ RS-485
⑥ Call button	1. TRX-, 2. TRX+, 3.GND
⑦ Home Button	⑭ DDL VCC (OPTION)
⑧ Microphone	⑮ DDL S/W (OPTION)
⑨ Power Switch	

Display composition

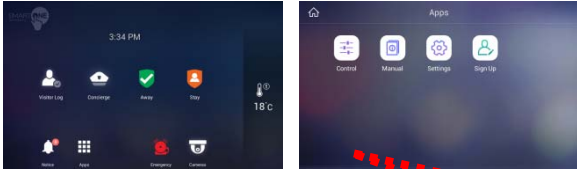

Press the button

Buttons at the Bottom



1 Screen Saver

We will provide information on the screen sequentially

Press the screen saver to go to the home screen.

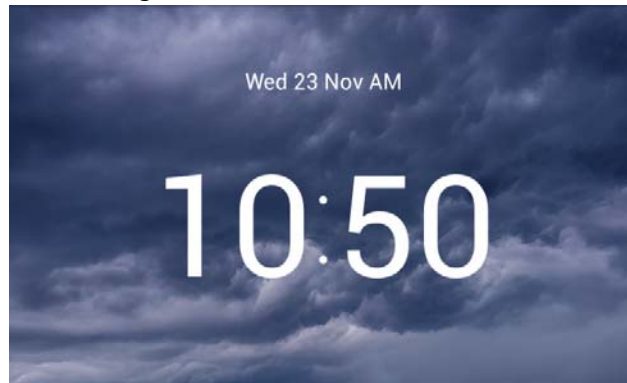

1.1. Information provided from the screen saver



[Today's weather information]



[Indoor humidity]



[Indoor temperature]

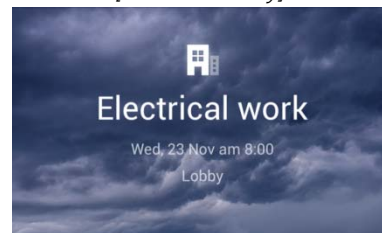







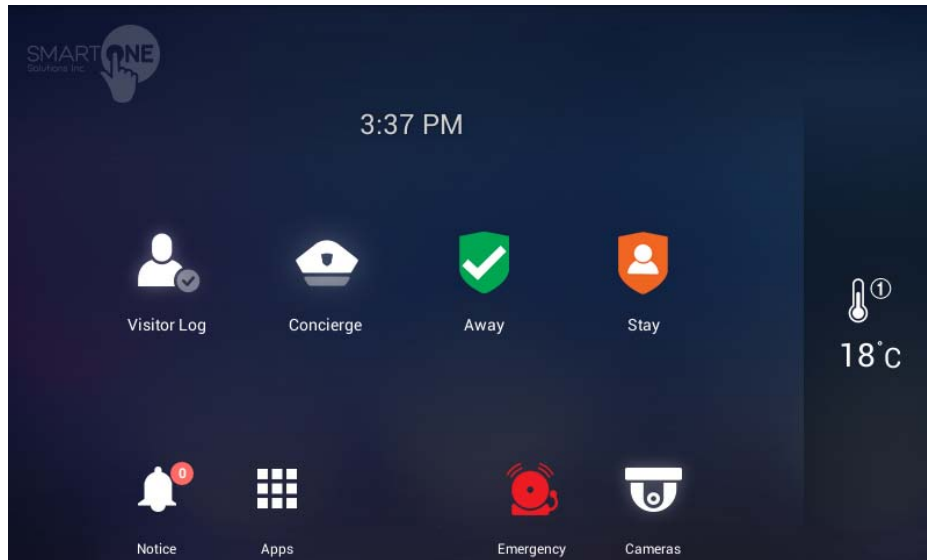

[Notice]

- ※ It is not provided when there is no information.
- ※ Weather information should be connected to the external Internet to the server.

2 Home Display



 Visitor Log	Check recorded images of visitors
 Concierge	Calling the guard station
 Away	Away mode
 Stay	Stay mode
 Notice	Notice
 Apps	The list of installed apps
 Emergency	Panic alert
 Cameras	CCTV Camera

3 Notice

You can check the notices

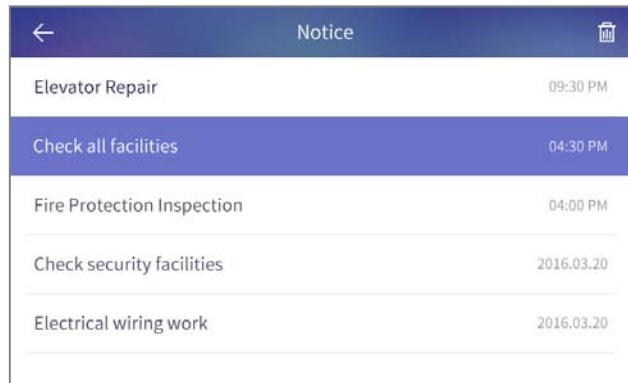

The screenshot shows a mobile application interface titled "Notice". It features a list of five items, each with a description on the left and a date/time on the right. The second item, "Check all facilities", is highlighted with a blue background. The interface includes a back arrow on the top left and a trash icon on the top right.

Notice Title	Date/Time
Elevator Repair	09:30 PM
Check all facilities	04:30 PM
Fire Protection Inspection	04:00 PM
Check security facilities	2016.03.20
Electrical wiring work	2016.03.20

[Notices]

4 Control

4.1. FCU Control

FCU Control

- 1) Go to the [Indoor] tab.
- 2) If cold/heating is in operation, the activated image is displayed, and if it do not work, the disabled image is displayed.
- 3) You can turn on / off all cooling / heating machines by pressing the power button of "whole air conditioning / heating".
- 4) You can enable or disable all cold / heater exit mode by pushing "go out" button of "whole air conditioning / heating".
- 5) You can turn on / off the cooling / heating by pressing the power (1) button of the controlling cold / heater.
- 6) You can set temperature at one degree difference by pressing the button(2) .
- 7) The current temperature is displayed.

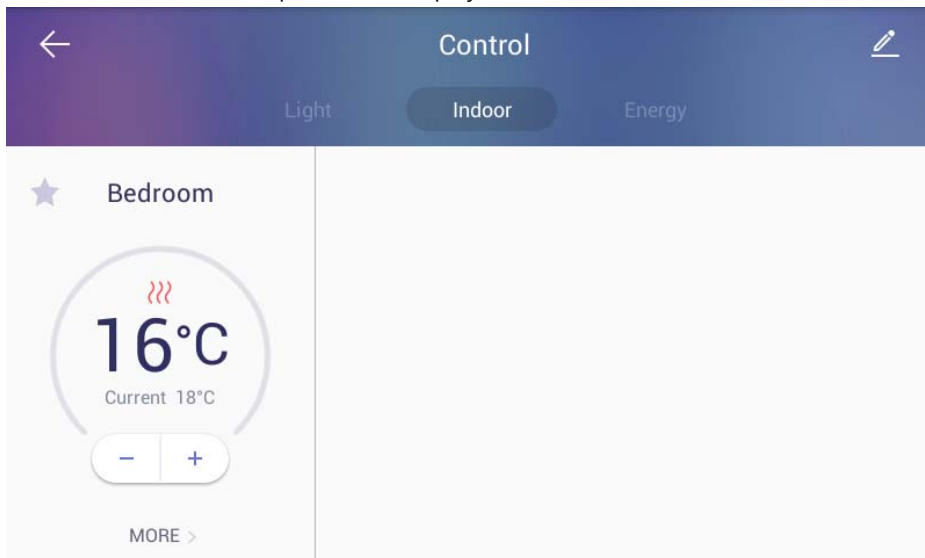

[FCU Control]

FCU Away mode

- 1) Go to the [Indoor] tab
- 2) Press the 'More' button
- 3) Press the "ON" button in the go-out mode to set the go-out mode. Both the cold / heater will be turned off.
- 4) Pressing the "OFF" button in the go-out mode releases the go-out mode. The cold / heating machine will return to the status before going out. (When you turn on / off the power from away mode setting, you will be automatically unlocked.)

Change the FCU mode

- 1) Press the "cooling" button to set the mode for cooling.
- 2) Press the "Heating" button, the mode is set for heating.

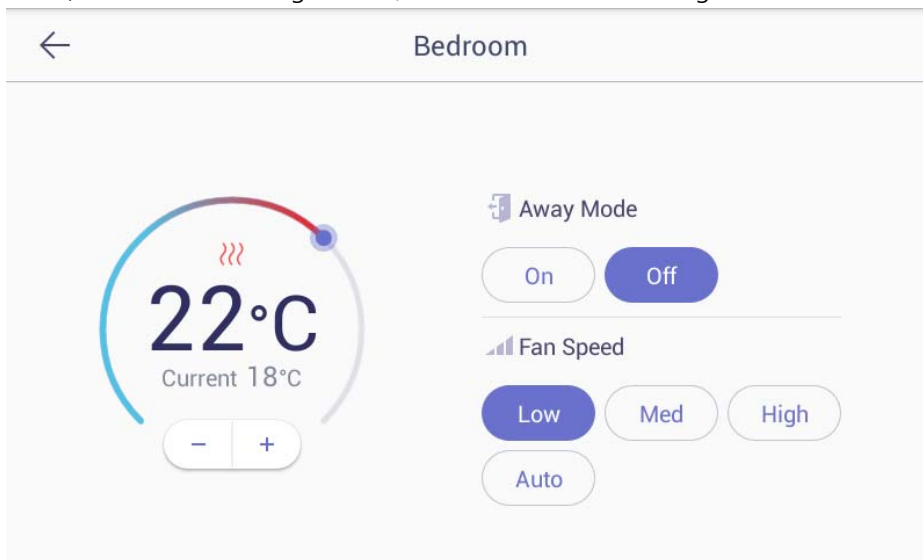

5 Application

5.1. Intercom

 Guard	Calling the security guard station
---	------------------------------------

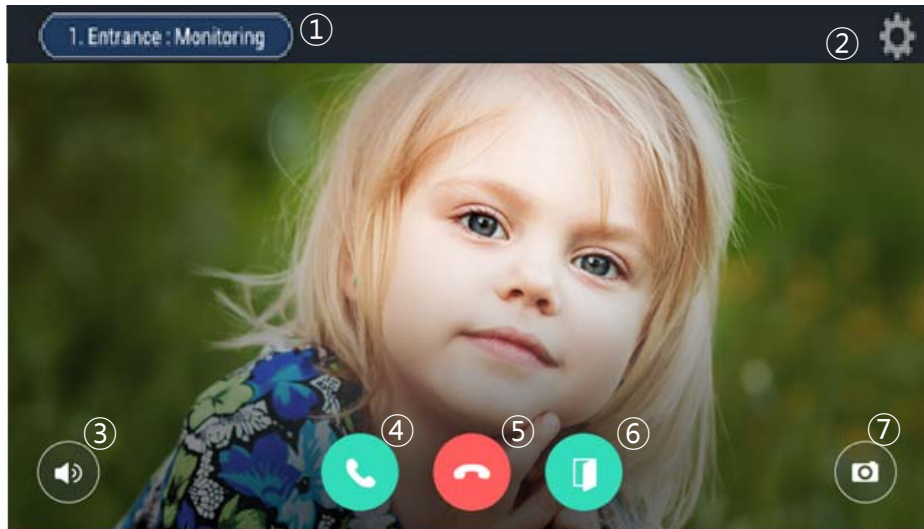

[The screen of calling connection and calling screen]

<ul style="list-style-type: none"> ① Active Call and Call Waiting ② Display of calling connection ③ Volume 	<ul style="list-style-type: none"> ④ Call Start ⑤ Call refusal, Cancel ⑥ Door Open ⑦ Save of Visitor image
---	--

- ※ 'Call display' can be displayed differently by each type of call from guard station and entrance
- ※ Some equipment does not provide CID function.
- ※ Visitors image can be saved in the storage space.
Images can be stored by 128 cuts. (188MByte standards)
- ※ The file is same space for visitors image and CCTV Image.
- ※ Internet telephone cannot be used

5.1.1. Common entrance



Open the door for common entrance

- 1) During the called of individual and common entrance please press  (Door Open) the button.

Recording visitor's image from common entrance

- 1) Press 'Capture an image' button while paging or calling.
- 2) If successfully recorded, the visitor's photos which are confirmed visitors on the home screen will be displayed.

Pick up the phone from Common Entrance

- 1) The visitor will be displayed on the screen with bell sounds
- 2) If pick up the phone please press button  or please reject button.
- 3) If hang up the phone please  press the button.

5.1.2. Guard station



Calling a guard station

Calling a guard station

- 1) To call a guard station, touch 'Guard station' icon or touch 'Guard station' button in dialing mode
- 2) To hang up a call, touch 'End call' button.

Receiving a call from a guard station

- 1) When the call is received from a guard station, the touch panel rings and displays a guard station icon on the screen.
- 2) To receive a call, touch  (Call) button. To reject a call, touch 'Cancel' button.
- 3) To hang up a call, touch 'End call' button.

※ Security office and management office cannot see the user's image.

※ The guard video call is only available for products with video call cameras

※ If you use the call transfer function during the guard station call, the guard station call is automatically terminated

※ Setting of security office -> Connect to COMMAX and control -> setting to number -> Security and management office can be settled.



Call switching function

- 1) If someone calls you during a calling, it will be displayed on the screen.
- 2) Touch  (Switch call) button to answer the call. The previous call is disconnected as you switch the call

※ Some devices do not provide CID functionality (Caller ID).

※ Call transfer is not supported on some calls

5.2. Security

 Emergency operation	Emergency in emergency situation
 Access control	Access control

5.2.1. Emergency



Emergency occurrence

Emergency sensing

An emergency occurs by the user or occurs automatically by the sensor

Touch 'Emergency' button to send a notice of an emergency to Guard station. The emergency notice is processed in three steps such as 'On', 'Off', and 'Reset'

Emergency on

- 1) Emergency can be generated by pressing the emergency icon or by pressing the emergency button on the front of the product. Or automatically by the sensor
- 2) Emergency type is displayed at the top of the screen with a siren sound

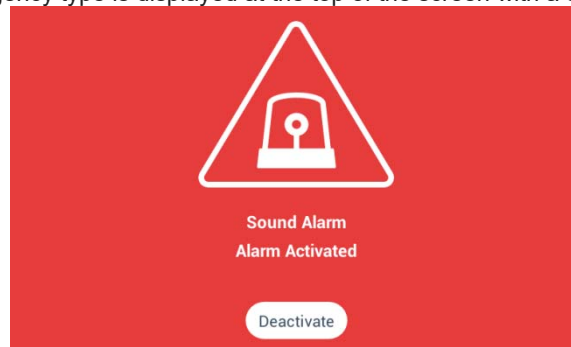

[Emergency]

Emergency stop

- 1) Touch 'Stop' button located at the bottom of Emergency screen.
- 2) Put the password (default password is '1234) and then press enter'.

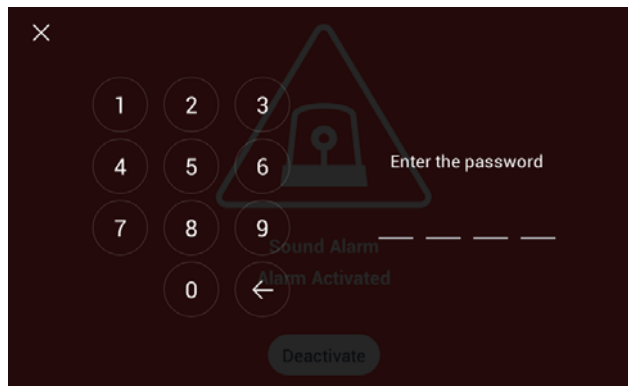

[Password input]

5.3. Home History

 Visitor Log	Viewing recorded images of visitors
---	-------------------------------------

5.3.1. Visitors Viewer



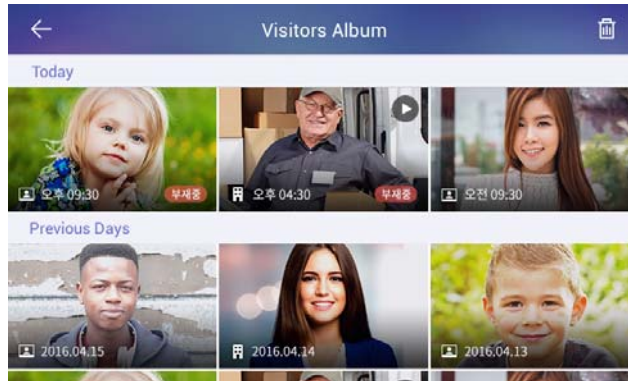

Viewing recorded images of visitors from common entrance.



[Viewing recorded images of visitors]

 Delete	Delete selected images
--	------------------------

You can see where the picture was taken with the icon.

 My house	Picture taken at my house
 Common entrance	Images taken from an common entrance
 Out	In case of go-out (Go out mode settings)



Viewing recorded images

In viewing a visitor mode, all recorded images from a common entrance can be checked including time and date information. You can also check visitors if you set out.

Deleting recorded images

- 1) Touch 'Delete' button.
- 2) Select images or all the images by checking 'Select all' box.
- 3) Touch once more to uncheck the images or 'Select all' box.
- 4) Touch 'Delete' button to delete selected images.

5.4. ETC

 Settings	Settings
 Sign Up	User registration

5.4.1. Sign Up

User registration/ Edit / Reset

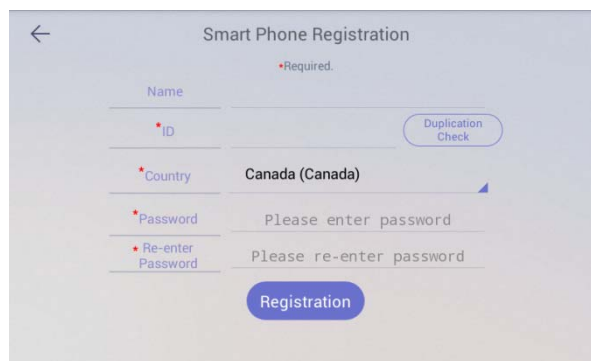

- 1) Enter your ID and touch 'ID check' button to check for validity
- 2) Select your country
- 3) Enter your password and touch 'Confirm' button.

A screenshot of a mobile application registration form titled "Smart Phone Registration". The form includes fields for Name, ID, Country (set to Canada), Password, and Re-enter Password. A "Duplication Check" button is next to the ID field, and a "Registration" button is at the bottom. A red asterisk indicates required fields.

Smart Phone Registration

←

*Required.

Name

*ID Duplication Check

*Country **Canada (Canada)**

*Password Please enter password

* Re-enter Password Please re-enter password

Registration

[Sign Up]

initialize

- 1) If membership has been registered, pressing the "Reset" button deletes the registered member information.

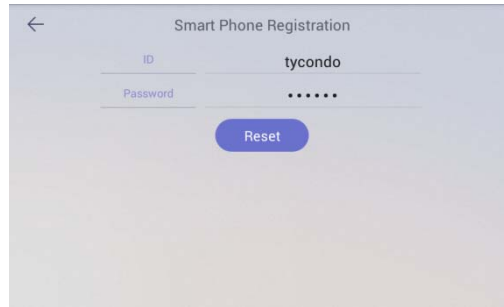

6 Away/Stay Mode

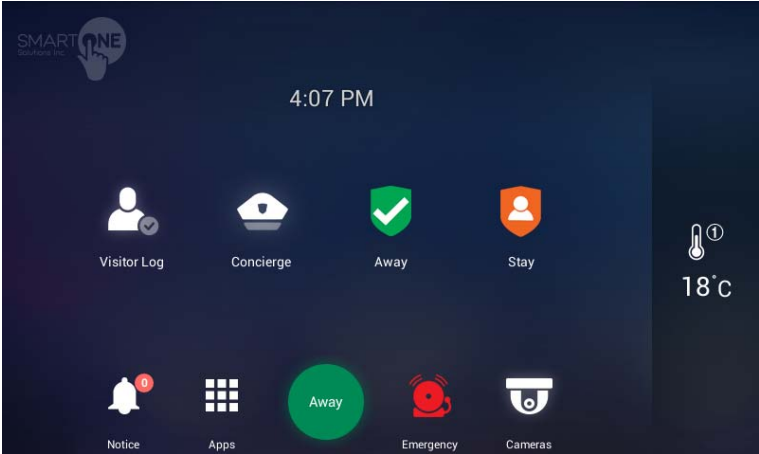

[Away mode]

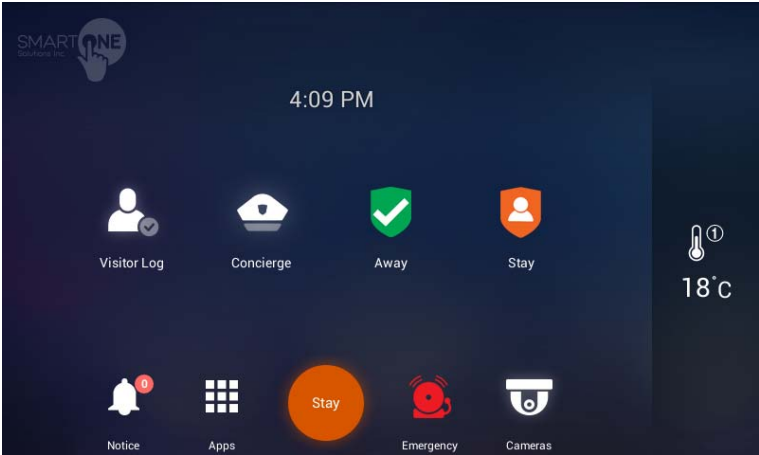

[Stay mode]

6.1.1. Away



Away Mode

The status display of going out setting

When you go out, you can set up these functions security sensor, visitor recording, light off, close gas valve, indirect call etc.

Away mode setting

- 1) Press the icon, away mode will be started.
- 2) The away mode will be executed automatically after the specified away delay time.
- 3) If you want to cancel away mode, press 'CANCEL' button.

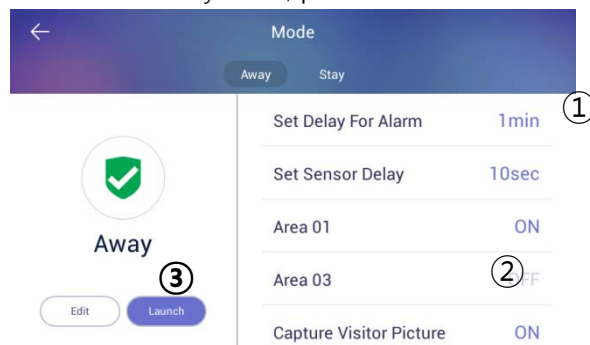

[Go Out mode set-up]

1.Delayed time for go-out	3.Start away mode
2.Action item when going out	

- ※ If security mode is on, away mode cannot be started.
- ※ Return home sensor delay setting is set by setting -> user option -> delayed from adjusted go out time.

Set Go Out mode

- 1) Set items to be executed when go out mode
- 2) Press the 'Option' button on the setting screen of go out mode, the setting screen of go out mode is displayed.
- 3) Check the use security sensor and execution item to use.

- 4) Press 'confirm' button to save.

Restore Go Out mode

- 1) Press "Go Out mode" button
- 2) When it appears on the password input screen, enter the password and click the 'confirm' button.
- 3) If the passwords match, go out mode will be canceled.

6.1.2. Burglar sensor settings



burglar sensor settings on

burglar sensor settings off

- ※ This function will be activated when the security devices have been installed.
- ※ You can set the using security sensors in 'Setting>Connections COMMAX>Sensors'.

Burglar sensor settings

- 1) Check the security sensor to be set by pressing the 'Areas (②)' button.
- 2) After settings, press ①(set) and the burglar sensor in adjusted area will be started.

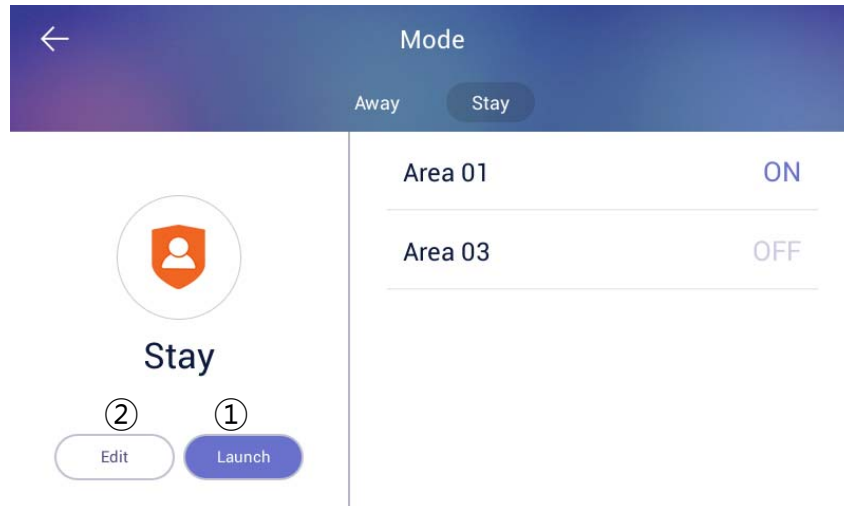

[Burglar sensor settings]

- ※ The number of burglar sensor settings images will be displayed as many as the number of adjusted sensors.

Restore the burglar sensor

- 1) Press the 'Burglar sensor settings' button
- 2) Input the password and press the 'confirms'
- 3) If password is correct, the security mode will be restored

7 Appendix

7.1. Using the Owner mobile app

Login

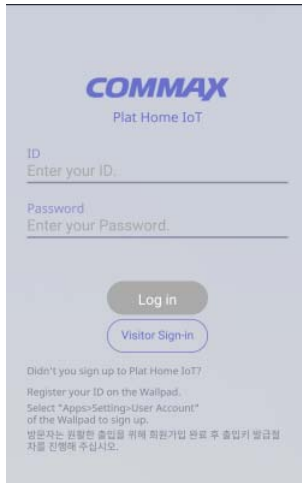

- 1) Enter the ID and password that you registered to in the Wallpad
- 2) Press the "Login" button.
- 3) Enter your nickname and Press the 'OK' button.

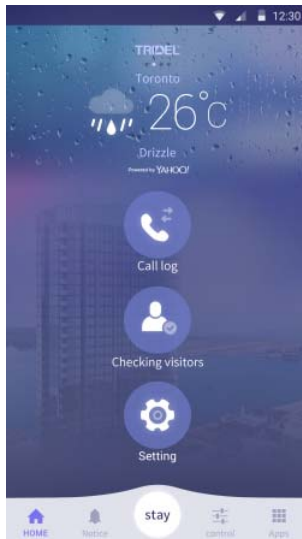

- 4) In the home screen, you can select "Call Log", "Checking visitors", and "Setting".

Issuing Access Keys

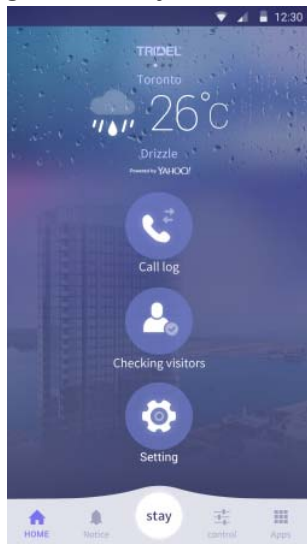

- 1) Press the 'Apps' button on the home screen.

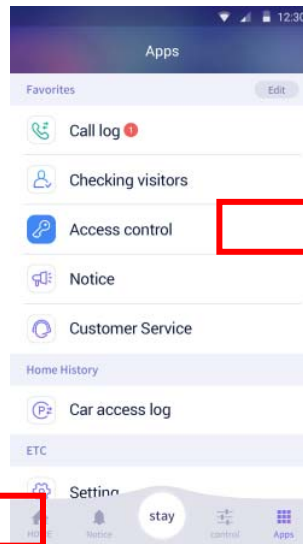

- 2) Press the 'Access Control' button.
- 3) Press the 'Doors management' button.

← Doors management +

← Doors management +



No access key registered.
Please request access key.

- 4) Press the "+" button and the access key will be issued.



- 5) "①" If there is more than one key that has been issued, you can move it by checking the left / right page.
- 6) "②" The expiration date of the access key is displayed.
- 7) "③" If not recognized automatically, press the "Open door" button to open the door.

Guest Visit Key Issued

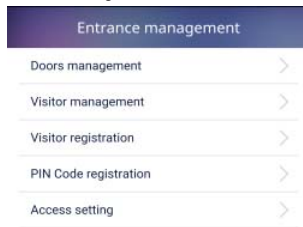

- 1) Press the 'Visitor registration' button.



- 5) Press the 'Visitor management' button.
- 6) After the guest registers, if you enter the authentication key, Guest is displayed in 'Visitor management'.

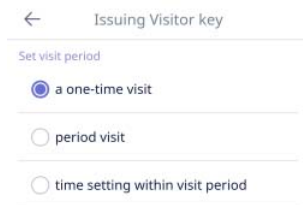

- 7) Press the 'Issuing a key' button
- 8) You can set the visitor's visit time.
 - One-time visit
 - Period visit
 - Time setting within a period



- 2) Press the 'Request' button.
- 3) The issued authentication key will be notified by phone or SMS to the guest within 3 minutes.
- 4) When the validity time has elapsed, the authentication key is reissued.

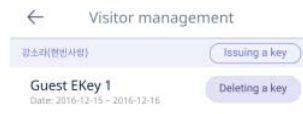

The visitor access notice message

When an owner and guests visit, a push message is provided on the mobile. Notification push messages is displayed as nickname entered you signed up.

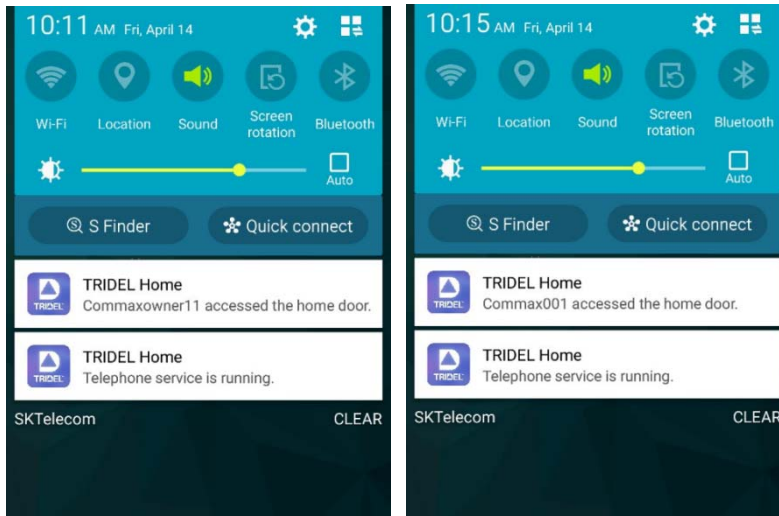

7.2. Using the Guest mobile app

Login



COMMAX
Plat Home IoT

ID
Enter your ID.

Password
Enter your Password.

Log in

Visitor Sign-in

- 1) Press the 'Visitor Sign-in' button.

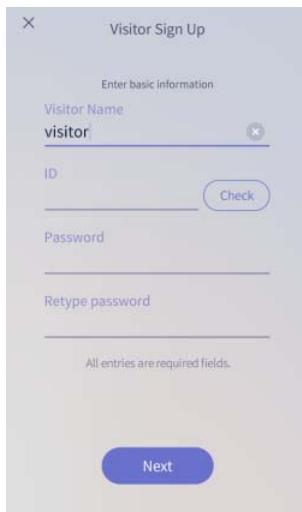

× Visitor Sign Up

Enter basic information

Visitor Name
visitor

ID

Password

Retype password

All entries are required fields.

Next

- 2) Enter 'Visitor Name', 'ID', 'Password', 'Retype password'.
- 3) Press the 'Next' button.
- 4) Press the 'Login' button when the registration is completed.



- 5) Enter the nickname to use and Press the 'Confirm' button.

Request a visit key

← Doors management +



No access key registered.
Please request access key.

- 1) Press the "+" button to request a visit key.

← PIN Code registration

Please enter PIN Code.

- 2) Enter the authentication key received from the owner.
- 3) When the owner confirms and releases the access key, the access key is displayed.

← Doors management +

Validity date ①
2016-12-15 - 2017-12-15



Opening automatic gate

ⓘ In case of bad communication with automatic gate, press the button.

- 4) "①" The expiration date of the access key is displayed.
- 5) "②" If not recognized automatically, press the "Open door" button to open the door.

7.3. Etc

Door Open



- 1) Touch the keypad on the door lock (DDL).
- 2) If the "Auto Setup" is set, the door automatically opens.
- 3) If "Auto Access" has not been set, you can press the "Door open" button on the Mobile Appliance to enter or exit.

Door lock(DDL) setting

Setting Manual Lock



- 1) Touch the keypad of the door lock (DDL).
- 2) Enter the password for the door lock. (Ex) password: 2580)
- 3) Enter ###+7.
(Ex: 2580##7)

Setting Auto Lock

- 1) Touch the keypad of the door lock (DDL).
- 2) Enter the password for the door lock. (Ex) password: 2580)
- 3) Enter ###+4.
(Ex: 2580##4)

※ If you set the door lock (DDL) manually, you must touch the keypad to lock the door when closing the door lock

PRODUCT

SPEC \ MODLE	CIP-700MW
LINE	UTP (CAT.5e)
VOLTAGE	INPUT : PoE DC 48V
TELECOMUNNICATION	AUDIO : VoIP, VIDEO : H.264
LINE & DISTANCE	STANDARD UTP (CAT.5e) 70m (FROM THE PSE)
TEMPERATURE	0°C ~ +40°C

SPECIFICATION

CPU	Dual-Core ARM Cortex-A7
MEMORY	1G DDR3 RAM (512M *2)
FLASH	4G eMMC Flash
LCD	7" TFT LCD, 800 x 480
POWER	PoE

INSTALLATION

▶ Monitor installation

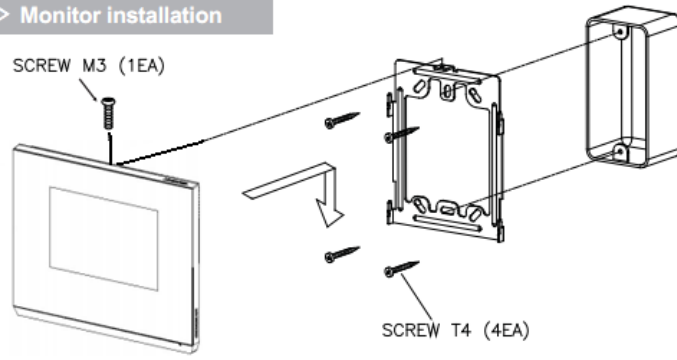

* Note

- Avoid installing the product in the area of direct sunlight.
- The position of the unit's body should fit the standard height range (Recommended height range is 1450 ~ 1500mm.)
- Avoid installing the product exposed to gas exposure, magnetic force, in humid temperatures, as it may damage the condition and performance of the product.

PACKAGE CONTENTS.

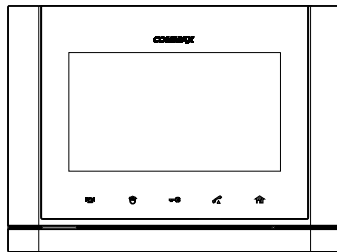

MONITOR (CIP-700MW)

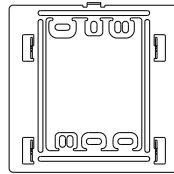

WALL BRACKET

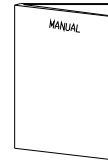

MANUAL

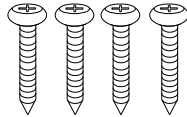

(T) 4 x 18mm
WALL BRACKET
MOUNTING SCREW(4EA)



(M) 3 x 6mm
MONITOR FIXING
SCREW(1EA)

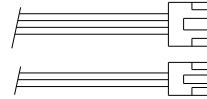

3P(1EA)/2P(1EA)
CONNECTOR

FCC Compliance Statement

This device complies with part 15 of the FCC rules.

Operation is subject to the following two conditions:

- (1) This device may not cause harmful interference, and
- (2) This device must accept any interference received, including interference that may cause undesired operation.

This equipment has been tested and found to comply with the limits for a Class B digital device pursuant to part 15 of the FCC rules. These limits are designed to provide reasonable protection against harmful interference in a residential installation. This equipment generates, uses and can radiate radio frequency energy and, if not installed and used in accordance with the instructions, may cause harmful interference to radio communications. However, there is no guarantee that interference will not occur in a particular installation. If this equipment does cause harmful interference to radio or television reception, which can be determined by turning the equipment on and off, the user is encouraged to try to correct the interference by one or more of the following measures:

- Reorient or relocate the receiving antennae
- Increase the separation between the equipment and the receiver
- Connect the equipment into an outlet on a circuit different from that to which the receiver is connected.
- Consult the dealer or an experienced radio/TV technician for help.

FCC Caution

Any changes or modifications to the equipment not expressly approved by the party responsible for compliance could void user's authority to operate the equipment.

This equipment should be installed and operated with minimum 20 cm between the radiator and your body.

Cet équipement doit être installé et utilisé avec un minimum de 20 cm entre le radiateur et votre corps.

Industry Canada Statement

This device complies with Industry Canada license-exempt RSS standard(s). Operation is subject to the following two conditions:

- (1) This device may not cause interference.
- (2) This device must accept any interference, including interference that may cause undesired operation of the device.

Déclaration de conformité IC (Industrie Canada)

Le présent appareil est conforme aux CNR d'Industrie Canada applicables aux appareils radio exempts de licence. L'exploitation est autorisée aux deux conditions suivantes :

- (1) Cet appareil ne doit pas créer d'interférences.
- (2) Cet appareil doit accepter toutes les interférences reçues, y compris celles qui pourraient entraver son bon fonctionnement.