

Foreword

This appendix is intended to serve as a supplement to the Operator's Manual of the machine and should be read together with the manual. Keep the appendix, together with the Operator's Manual of the machine, in the cab, so that it is always at hand. Replace it immediately, if it is lost.

NOTE!

If this appendix covers more than one machine, the information applies to all machines unless otherwise indicated.

A lot of work has been spent on the machine's design and manufacture to make it as effective and safe as possible. Accidents that occur in despite of this can most often be contributed to the human factor. A safety-conscious person and a well-maintained machine make a safe, efficient, and profitable combination. **Therefore, read the safety instructions and follow them.**

We continuously strive to improve our products and to make them more effective by changes to their design. We reserve the right to do this without committing ourselves to introduce these improvements on already delivered products. We also reserve the right to change data and equipment, as well as instructions for service and maintenance without prior notice.

Safety regulations

It is the operator's obligation to know and follow the applicable national and local safety regulations. The safety instructions in this manual only apply to cases where there are no national or local regulations.

OPERATOR'S MANUAL

Table of contents

Load Assist

TPMS

Alphabetical index

 **DANGER**

The safety symbol combined with this signal word indicates a hazardous situation which, if not avoided, **will result in death or serious injury**. Danger is limited to the most extreme situations.

 **WARNING**

The safety symbol combined with this signal word indicates a hazardous situation which, if not avoided, could result in **death or serious injury**.

 **CAUTION**

The safety symbol combined with this signal word indicates a hazardous situation which, if not avoided, could result in **moderate or minor injury**.

NOTICE

Indicates a potentially hazardous situation which may result in machine damage.

NOTE!

It is used to highlight information for installing, use, or maintenance that is important but is not safety-related.

Table of contents

Foreword	1
Load Assist	5
Screen views	6
Settings	12
Load weighing	38
Task mode	61
Map	69
Rear vision system	117
View selector	118
Messages	119
Maintenance	121
TPMS	122
Settings	124
Alphabetical index	129

Load Assist

Load Assist is intended to be used as an information system to facilitate the user's tasks. This appendix does not release the operator from following the instructions and cautionary measures described in the ordinary operator's manual to the machine.

Load Assist is a feature in the Co-pilot. It is basing on the load weighing system and can be complemented with features like: ■ Task mode, see page 61.

■ Map, see page 69.

■ Rear vision system, see page 117.

Load Weighing is a system that weighs the load in/ on the attachment during a continuous lifting motion. An audible signal confirms that the weight is measured correctly. The system summarizes the load in every cycle and the progress can be followed in the display. For more information, see page 40.

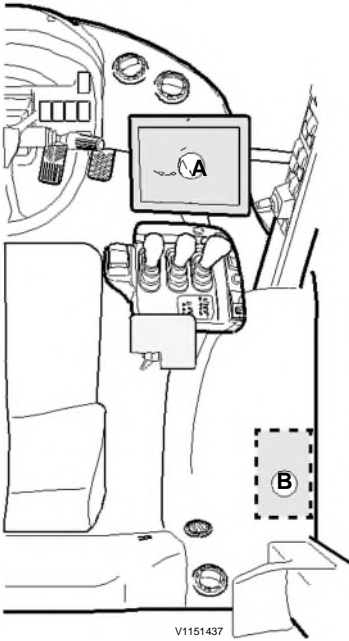

V1151437

A Display

B Recommended location for printer

Running-in instructions

New machines may need up to 200 working hours to reach a stable accuracy due to the initially higher friction in the boom linkage but should be used as normal during the running-in period.

Known weight calibration is recommended after the first 200 working hours to maintain a good weighing accuracy when using these buckets.

Regular greasing is important to maintain a low friction in the lift arm system. Follow the greasing intervals in the machine Operator's Manual.

Central lubrication system is recommended.

Screen views

Main screen

NOTE!

The appearance of the main screen differs depending on the current settings etc.



V1215872

NOTE!

The main screen information here is shown as when Known weight calibrated buckets are used. There are two decimals on load value when Known weight calibrated buckets are used and one decimal when other attachments are used. Appearance and items also differ slightly between these two accuracy levels.

Settings

1. Settings, see page 12.

Load weighing

2. Current load, see page 42.
3. Locked/unlocked load, see page 43.
4. Forced unload, see page 45.
5. Forced partial unloading, see page 46.
6. Attachment type, see page 43.
7. Attachment angle, see page 43.
8. Known weight calibrated buckets, see page 44.
9. Weight adjustment of the current attachment, see page 57.
10. Machine inclination, transversal ("roll"), see page 44.
11. Boom angle, see page 45.
12. Machine inclination, longitudinal ("pitch"), see page 45.

Task mode

13. Task mode, see page 61.
14. Delete last load, see page 65.
15. Pause view, see page 65.
16. Print receipt, see page 65.

Map

17. Centering/Compass view, see page 77.

Rear vision system

18. Rear vision system, see page 117.

Others

19. View selector, see page 118.
20. Messages, see page 119.
21. Action centre, see the Co-Pilot information in the machine Operator's Manual.
22. Quick tips, see page 10.

Simple mode

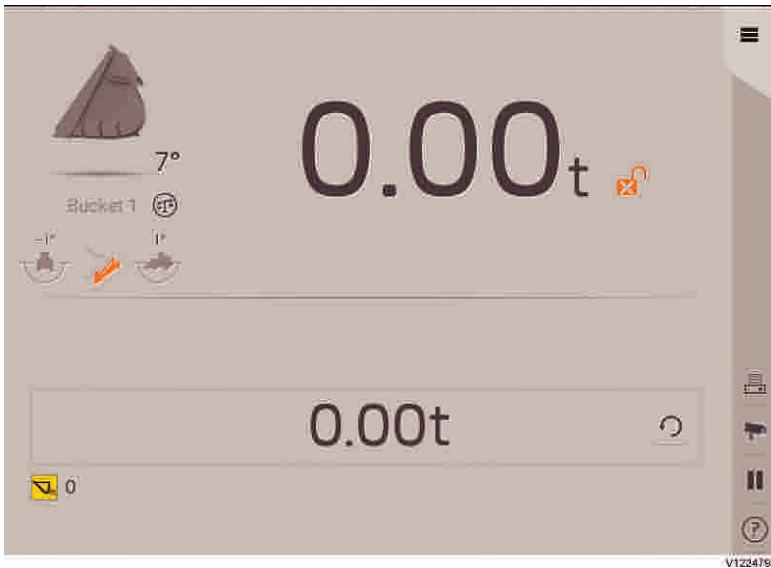

Simple mode, see page 33.

Quick tips

When enabling Quick tips, additional information and explanations for different functions will be available in the Co-Pilot.



NOTE!

Quick tips will be disabled when the machine is moving.



Quick tips on the main screen

1 Help on main screen

- Tap the  symbol on the main screen to activate the quick tips.
- Tap on one of the blue highlighted fields to get additional help and explanations about a function.
- Tap the  symbol again to deactivate the quick tips.
- The  symbol can be disabled from the main screen in the **Settings** → **Application** → **Help on main screen**.



V1205895

Settings

NOTE!

Settings are disabled when the machine speed exceeds 10 km/h (6 mph).

- 1 For Site, see page 12.
- 2 For Project, see page 13.
- 3 For Work results, see page 25.
- 4 For Machine, see page 27.
- 5 For Application, see page 27



V1215198

Site

Settings for the site include:

- 1 Closing icon to exit the menu
- 2 Supplier and Location can be set here. The data entered here will be visible on the printed receipt.
- 3 Map editor, menu to edit maps. See page 69.
- 4 Machine Group, menu selection to manage machine to machine communication. See page 71.

NOTE!

These two menus are password-protected, to reduce the risk of operators making changes by mistake.

For login, see page 12.

Site, login

NOTE!

Only used for the Map functions.

NOTE!

Only those given the task of handling maps and groups should log in to these sections.

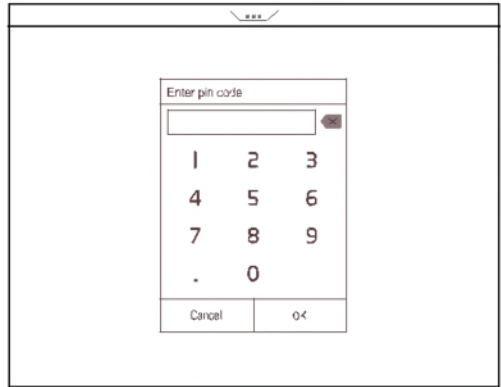

V1203264

The PIN-code for logging in consists of the last four digits in the serial number of the machine's Volvo Co-Pilot.

The PIN-code is found on the back of Volvo Co-Pilot or in the settings for Volvo Co-Pilot. See the settings for Volvo Co-Pilot in the machine Operator's Manual.

Project

Project information includes work order, customer, truck, pile, process and materials. The project information is used when working with different task modes.

For Task mode, see page 61.

In the Project menu, project information can be created, viewed, edited, and deleted, and also activated or deactivated for the Truck Task mode.

- 1 For Work order, see page 14.
- 2 For Customer, see page 15.
- 3 For Truck, see page 15.
- 4 For Pile, see page 19.
- 5 For Process, see page 20.
- 6 For Material, see page 21.

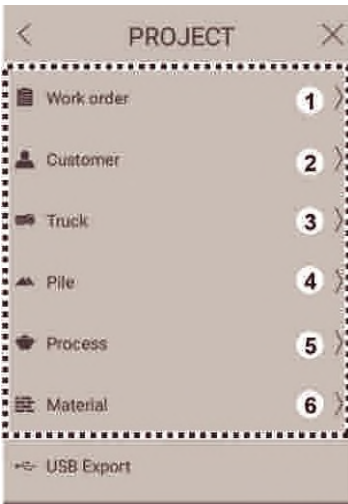

V1215192

14 Load Assist Settings

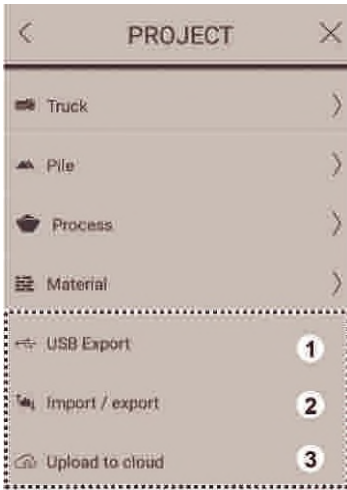

V1215302

Project information can be imported or exported with USB stick, or upload to cloud when cellular network is available (Mini SIM-card is installed). 1 For USB Export, see page 21.

2 For Import / export, see page 22.

3 For Upload to cloud, see page 23.

Work order

The menu to manage work orders can be accessed either via Project menu or by tapping on the Work order icon in the project bar.



V1215108



V1215283

- 1 Icon to add a new work order
- 2 Icon to edit or delete a work order



V1185313

Lists of work orders can be sorted from A-Z and Z-A by pressing the A-Z icon. A third press will sort by the latest loaded entry. The active item will always be highlighted and on top.

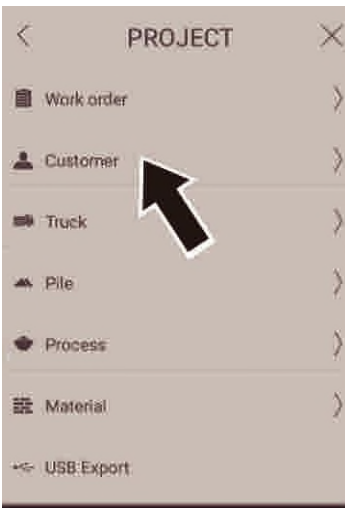

V1215294

Customer

To create, edit or delete a customer, start as follows:

- Go to Settings -> Project -> Customer:



V1215285

- 1 Icon to add a new customer
- 2 Icon to edit or delete a customer

Truck

The menu to manage trucks can be accessed either via the Project menu or by tapping on the Truck icon in the project bar.



- 1 Icon to add a new truck
- 2 Icon to edit or delete a truck

To set more than one compartment to a truck, see page 16.

Truck with multiple compartments

One or two compartments can be added to a truck when there is a need to set up individual compartment loads for one truck.



V1204547

The complete truck is shown as a truck (1) and trailers (2,3) icon in the main screen since it is a common scenario. The compartments do not need to be trailers however – it can be that the dump body of the truck is divided into two or three compartments for example.

Compartment 1 (with the truck-icon) is the first one to load by system default. Select which compartment to load by tapping on the compartment icon.

The capacity for each compartment is set up when the truck is created.

See below for two different ways of setting up trucks with multiple compartments.

18 Load Assist Settings

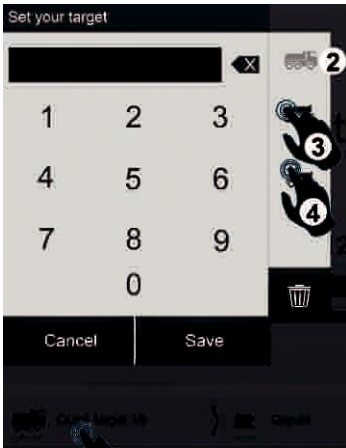

V1204544

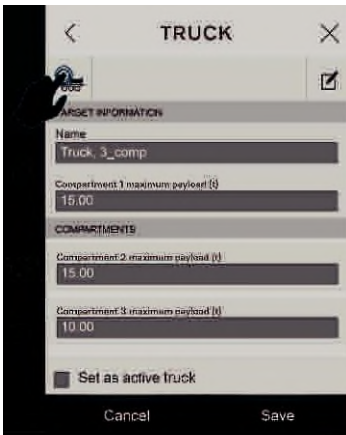

V120666



V120666

Quick add truck via project bar

- 1 Tap to add truck.
- 2 Enter the capacity for the first compartment (shown as a truck).
- 3 Tap to add a second compartment (shown as a trailer) and enter the capacity for that.
- 4 If needed, tap to add a third compartment and enter the capacity for that. Tap on Save to start loading on the truck.

Add truck via the SETTINGS-menu

- 1 Tap SETTINGS > PROJECT > Truck.
- 2 Tap to add truck.
- 3 Name it and specify the capacities.
- 4 Tap on the trailer-icon to add compartments (maximum 2 can be added) and specify the capacities.
- 5 Set the truck as active if wanted.
- 6 Tap on Save to start loading on the truck.

Delete a compartment

It is possible to delete a compartment via the editing functionality for the truck. In the illustration to the left, the third compartment is marked for deletion (which is executed via tapping the “top left trash bin icon” and then saving).



Truck with three compartments (principle)

Loading example

A truck with a dump body with two compartments (1,2) and a trailer (compartment 3) needs to be loaded with different material in each compartments.

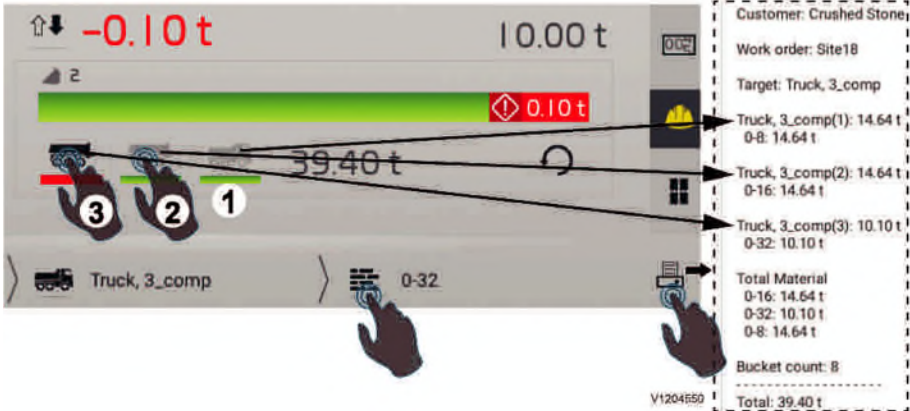

- 1 Load the compartment 1 with material 0-8.
- 2 When compartment 1 is loaded, tap on compartment 2 on the main screen and change material to 0-16.
- 3 Do the same procedure for compartment 3 when compartment 2 is filled (with material 0-32 in this example).
The total loaded material is shown to the right of the compartment icon.
- 4 Tap the printing icon, see page 65.
Check how the receipt is generated (when the entire trailer has been loaded) in this example.

Pile

(Optional equipment)

In this menu, you can add, edit or delete a pile.
1 Icon to add a new pile
2 Icon to edit or delete a pile

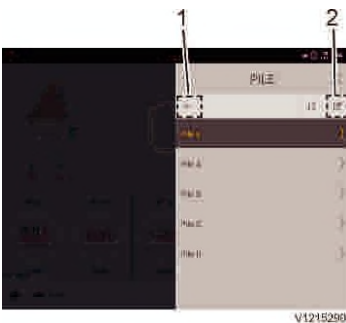

V1215290



V1215289

The Pile menu can also be reached via:

- 1 Select Pile mode in project bar.
- 2 Tap the Pile icon.



V1215288

Process

(Optional equipment)

- In this menu, you can add, edit or delete a process.
- 1 Icon to add a new process
 - 2 Icon to edit or delete a process

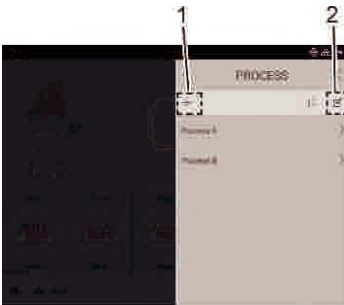

V1215289

The Process menu can also be reached via:

- 1 Select Process mode.
- 2 Tap Process icon.



V1215291



Material

To add, edit or delete a material, or associate a material with a pile or a process, start as follows: - Tap Material icon in the project bar.

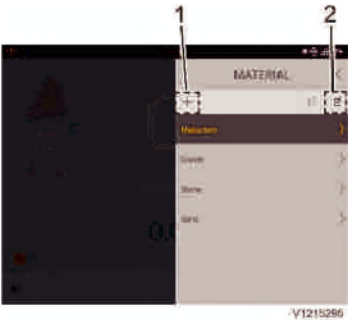
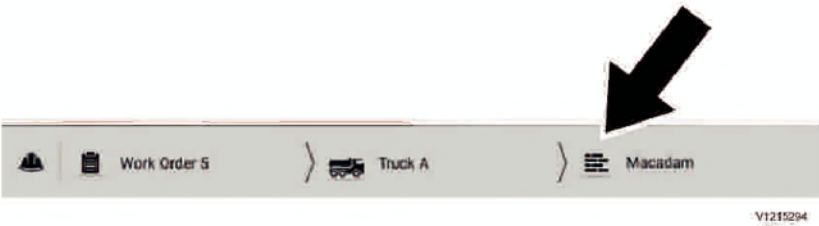

- 1 Icon to add a new material
- 2 Icon to edit or delete a material

USB Export

Project data can be exported to a USB-stick via **USB Export**. It can be used to summarize the current status of all project data, both finished and ongoing work orders will be exported to a report.

USB Export

Every work order will be listed including Name/ Capacity/Material/Customer/progress and so on.

22 Load Assist Settings

Work order will be marked when using known weight calibrated buckets in the exported file.

Name	Capacity (Metric ton (t))	Start time	Stop time	Blue time	Load (Metric ton (t))	Buckets	Material	Material Load (Metric ton (t))	Customer	Misc	Weighing mode
School construction	1500.0	2018-02-10 11:49:06	2018-02-15 10:19:53	2018-02-15 00:00:00	1000.6	311	Gravel 8-16	1000.6	John Construction		1%
The Garage	800.0	2018-03-11 09:02:27	2018-03-13 15:15:07	2018-03-13 00:00:00	800.2	215	Gravel 0-2	800.2	Fitch & Son		3%
The Mail	2000.0	2017-11-27 11:01:03	2017-12-17 13:11:23	2017-12-19 00:00:00	2001.4	493	Gravel 16-32	2001.4	Fitch & Son		3%
Town house	1500.0	2017-11-15 11:11:07	2017-12-09 14:01:16	2017-12-09 00:00:00	1499.2	303	Gravel 16-32	1499.2	John Construction		1%
Road repair	3000.0	2017-11-02 07:12:15	2017-11-26 11:13:69	2017-11-26 00:00:00	3001.5	654	Sand 3-6	3001.5	Road Service Ltd		
Garden house	500.0	2017-10-15 16:19:50	2017-10-15 09:12:30	2017-10-15 00:00:00	500.0	128	Gravel 16-32	500.0	John Construction		3%
Kitchen 1	1200.0	2017-10-10 15:22:43	2017-10-17 11:12:13	2017-10-16 00:00:00	1199.0	257	Gravel 8-16	1199.0	Internal		
Golf course	14000.0	2017-09-27 09:38:30	2017-11-02 14:18:35	2017-11-05 00:00:00	1400.8	3492	Gravel 16-32	1400.8	John Construction		1%

V1195315

Example

Take the following steps to export the data to USB-stick.

- 1 Make sure a USB-stick is inserted in one of the USB ports (1) on the back side of the Co-Pilot.

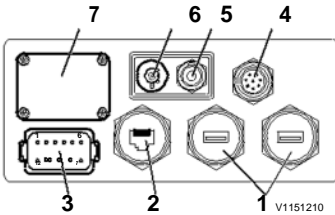

- 1 USB ports

- 2 Go to "SETTINGS" > "PROJECT" > "USB Export".

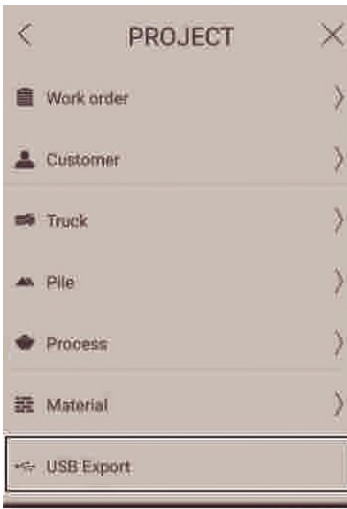

V1218553

- 3 Tap "OK" to export the data to the USB-stick. **NOTE!**

The exported data for the File upload portal is saved in a folder on the USB-stick and can be manually uploaded to the portal.

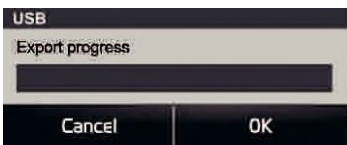

V1180194

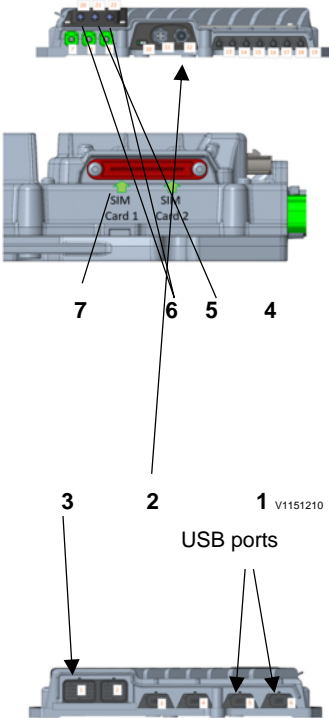

Import / export

Import / export gives the possibility to create new work orders, materials, targets and customers on a computer and transfer the data to one or multiple Co-Pilots by USB-stick. Import / export is intended to be used to update data on the Co-Pilot from the back office and to move project data between machines.

Export data

- 1 Insert a USB-stick into a USB port at the back of the Co-Pilot.
- 2 Go to " SETTINGS " > "Project" and tap on "Import / export".
- 3 Pull out the USB-stick.

Use a computer to add new data to the files that has been created on the USB-stick.

The files must be saved with the same name and format as before.

- 1 Insert the USB-stick into a USB port (#1) at the back of the Co-Pilot.
- 2 Go to " Settings " > "Project" and tap on Import / export.

The system will detect the differences in data and ask for confirmation to import to Co-Pilot.

The same project data can be imported in multiple machines.

NOTE!

No data in the Co-Pilot will be deleted. You can only add new data to the Co-Pilot from back office. Editing or deleting data can only be done in the Co-Pilot.

Upload to cloud

Project data can be exported to cloud via **Upload to cloud** when cellular network is available (Mini SIM-card is installed).

Upload to cloud

'Upload to cloud' will export the data in more detail comparing with 'USB Export', including every single load data and information about which work order/ customer/target/material it belongs to. Work order will also be marked when using known weight calibrated buckets in the exported file.

Machine ID	Date	Time	Load ID	Weight tonne	Weight short ton	Material Name	Material ID	Target Name	Target ID	Customer Name	Customer ID	Work Order Name	Work Order ID	Weighing mode
L150H	2017-05-21	11:42:46	227	5.2	5.7	Gravel 4-18 Red	G418R	FRT 531		Finch & Son	12254	School construction	S-25-AK	3%
L150H	2017-05-21	11:44:39	228	1.5	1.7	Gravel 4-18 Red	G418R	FRT 531		Finch & Son	12254	School construction	S-25-AK	3%
L150H	2017-05-21	11:45:06	229	1.7	1.9	Gravel 4-18 Red	G418R	FRT 531		Finch & Son	12254	School construction	S-25-AK	3%
L150H	2017-05-21	11:46:52	230	2.0	2.2	Gavel 4-18 Red	G418R	DSC 662		Johns Construction	11002	The Garage	G-12-RF	
L150H	2017-05-21	11:48:07	231	5.8	6.3	Gravel 4-18 Red	G418R	DSC 662		Johns Construction	11002	The Garage	G-12-RF	
L150H	2017-05-21	11:50:02	232	6.1	6.8	Gravel 4-18 Red	G418R	DSC 662		Johns Construction	11002	The Garage	G-12-RF	
L150H	2017-05-21	11:51:59	233	6.0	6.6	Gravel 4-18 Grey	G818G	OJK 474		Finch & Son	12254	School construction	S-25-AK	3%
L150H	2017-05-21	11:53:15	234	6.7	7.4	Gravel 4-18 Grey	G818G	OJK 474		Finch & Son	12254	School construction	S-25-AK	3%

V1195314

Example

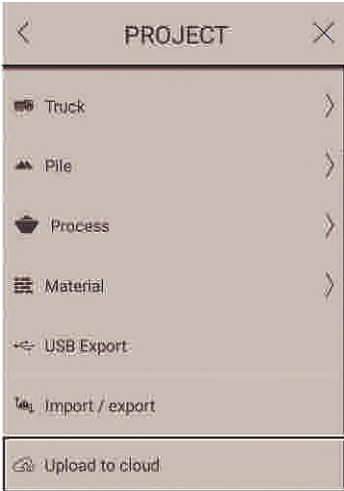

V1216554

Take the following steps to upload the data to cloud.

- 1 Make sure Mini SIM-card is installed, see **SIM card, installing** in the machine Operator's Manual.
- 2 Go to "SETTINGS" > "PROJECT" > "Upload to cloud".
- 3 Tap "OK" to upload the data to cloud.

NOTE!

With internet connection, it is possible to automatically upload the data to the File upload portal at a desired interval, see page 28.

Work results

Work results can be summarized by Load summary, see page 25.

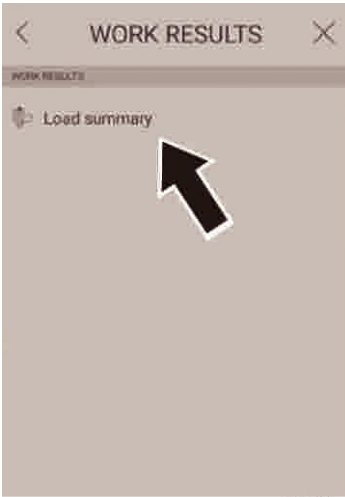

V1215195

Load summary

This functionality makes it possible to create production reports that can be printed or exported as PDF to USB.

To access this menu tap SETTINGS > WORK RESULTS > Load summary

Load summary

- 1 Tap on the field to select the desired time interval for the load data that should be included in the production report, see below.
- 2 Tap on the field to select the desired task mode.

NOTE!

Tasks in Trip mode can not be summarized.

- 3 Tap on each field to select what should be included in the production report and tap on the check boxes (minimum 2) to make a desired grouping.
What is selectable in this field depends on what task mode is selected.
- 4 Tap on the fields to select number of copies (if to be printed) or if only printed loads (Yes/No) should be included on the production report.
- 5 Check that the production report are correct before printing out and/or exporting it to USB.

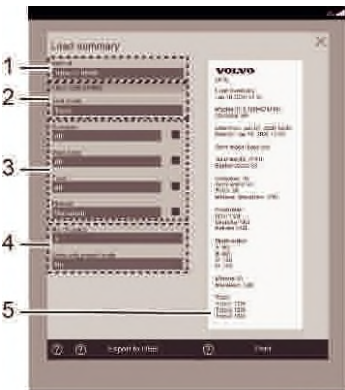

V1215276

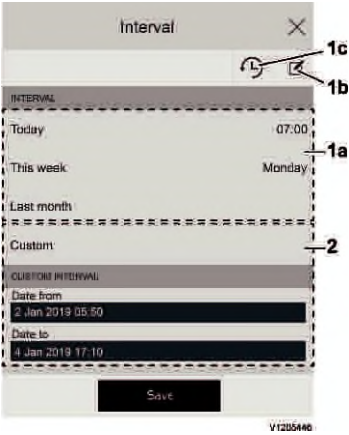

Setting desired time interval

- 1 Tap the edit icon (1b) to edit the start of day or week in the respective fields

NOTE!

The selected interval can be edited (1b) and it is possible to toggle between current interval period and the previous one for all pre-defined intervals (yesterday, last week, last month) with icon 1c.

- 2 Tap this field to set up a customized time interval and edit directly in the fields that are opened.

Machine

In Machine menu:

- 1 The active attachment can be calibrated, see page 49.
Attachment angle can be set here, see page 53.
- 2 Attachments can be created, edited, deleted and also activated.
- 3 Machine name can be changed here by tapping on machine name.
Give the machine a new name and tap OK to save and exit the window.



Application

In the application menu, the following settings can be made (may vary depending on the options installed on the machine):

- 1 Enable/Mute qualified load notification sound
- 2 Enable/Mute map warning sound
- 3 Enable/Mute weight limit warning sound
- 4 Set weight limit
- 5 Enable/Disable reverse before locking load. For more information, see page 59.
- 6 Enable/Disable low load mode. For more information, see page 40

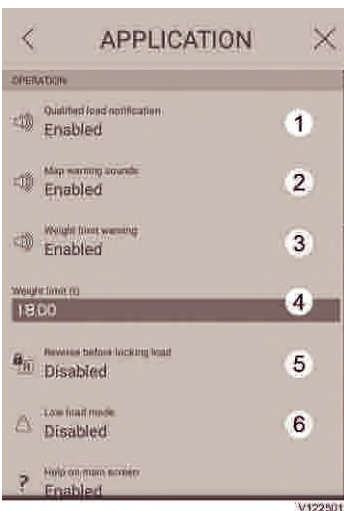

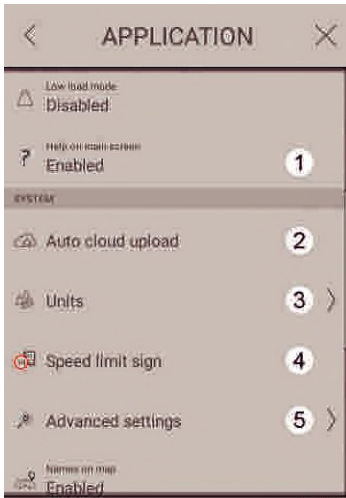

V1228017

- 1 Enable/Disable help on main screen. For more information, see page 10.
- 2 For more information, see page 28.
- 3 For more information, see page 29.
- 4 For more information, see page 29.
- 5 For more information, see page 30 (PIN-code protected).

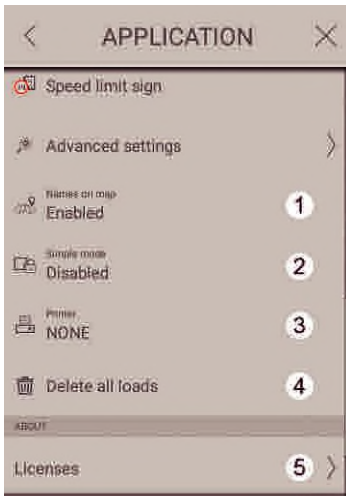

V1228019

- 1 Enable/Disable names on map
- 2 Enable/Disable simple mode. For more information, see page 33.
- 3 Shows the connected printer. For more information, see page 37.
- 4 Delete all stored loads

NOTE!

It is important to check that data has been uploaded or exported before deleting.

- 5 Shows which licenses are included in the software.

Information about the application version, as well as the platform version, are also displayed here.

Auto cloud upload

With Internet connection, it is possible to automatically upload production data from the system to the File upload portal. The data contains information about each individual load and is given in csv file format. Loads produced using known weight calibrated buckets are indicated with "1%" in the files. Take the following steps to automatically upload data at a desired interval.

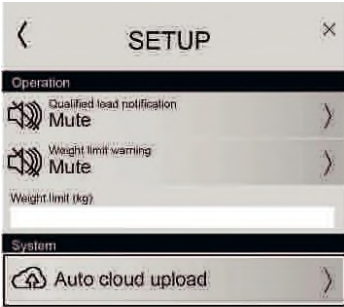

V1194615



V1180055

Window for setting upload interval

- 1 Make sure that internet connection will be possible, see **SIM card, installing** in the Co-Pilot information in the machine Operator's Manual.
- 2 Go to "SETTINGS" > "SETUP" > "Auto cloud upload" to open up the window for setting the interval for the automatic upload.

- 3 Use the slide bar to adjust to the desired automatic upload interval.
- 4 Tap "OK" to save.

NOTE!

At each automatic upload, all data since the last successful upload is uploaded to the File upload portal.

NOTE!

Load data that has not been successfully uploaded (for example due to network issues) can be exported to a USB-stick, and then manually uploaded to the File upload portal, instead, see page 21 and 23.

Application, units

To select units, use the menu for unit settings.

- 1 Closing icon to exit the menu
- 2 Weight units; using the weight unit menu, you can select between metric tons, short tons and pounds. Selected unit is shown on the menu row.
- 3 Distance units; using the distance unit menu, you can select kilometers/meters or miles/feet. Selected unit is shown on the menu row.

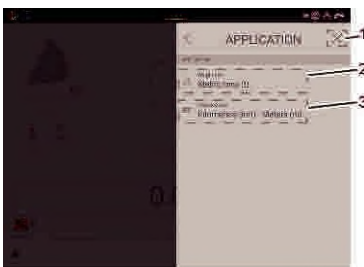

V1216830

Application, speed limit sign

Tapping on one of the two options will select the style of the speed limit sign that will be shown in the map.

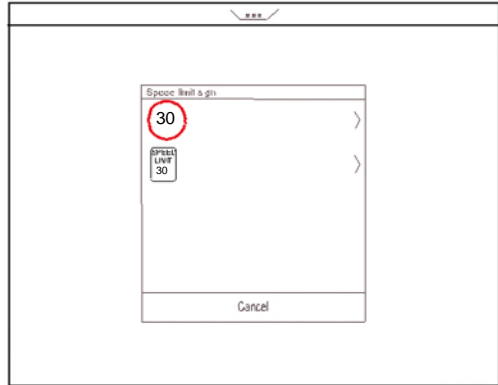

V1203265

Application, advanced

(Optional equipment)

Select **Settings** → **Application** → **Advanced settings** to open the menu. A window for logging in opens, see page 12.

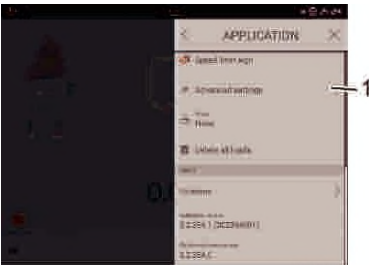

V1215632



- 1 Turn on/off local map
- 2 Turn on/off map speed limiter

Local map

It is possible to have a local map for a machine that does not belong to a machine group. The local map can be uploaded to a machine group at the site. This can be done when the machine is connected to the machine group, if there is no common map for the group already.

- To turn on the feature, select Local map in the menu
- Tap OK to proceed

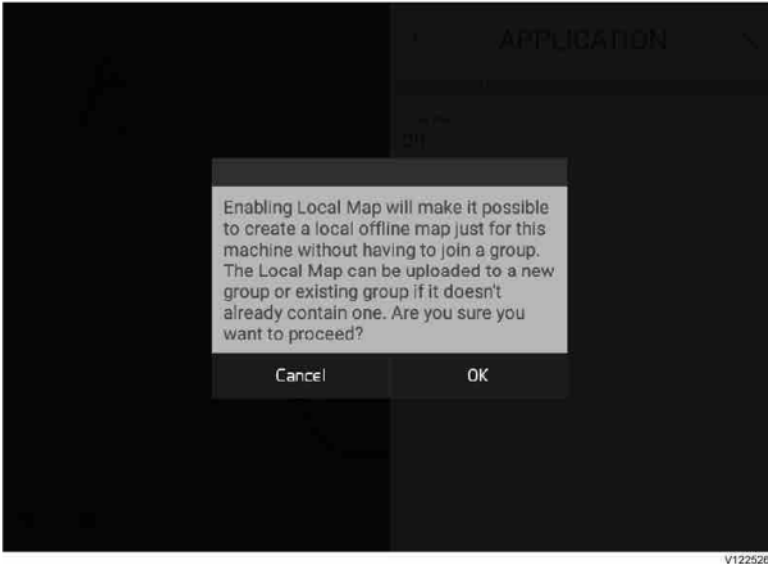

Map speed limiter

For information about Map speed limiter, see page 69.

NOTE!

If needed, it is possible to temporarily disable this function.

- To temporarily disable the feature, select Map speed limiter in the menu
- Tap OK to proceed

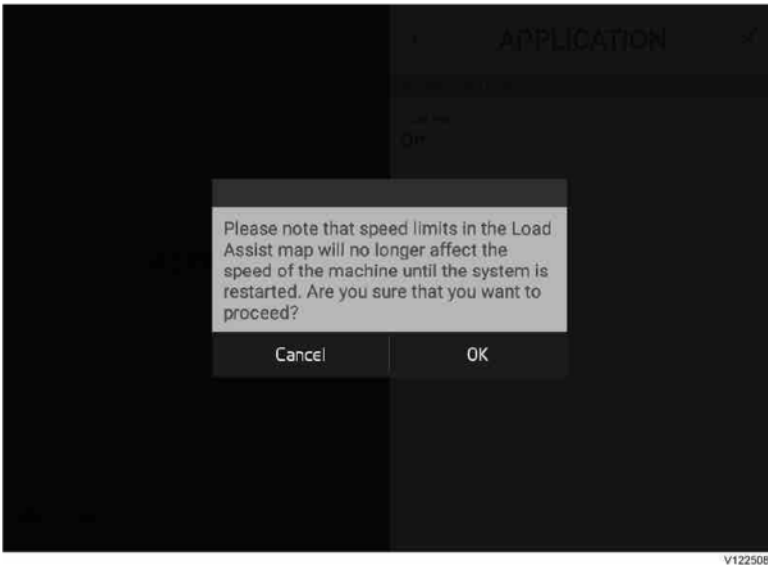

Simple mode

Simple mode is a simplified mode with fewer functions, options and settings. The main functions in Simple mode are to view the current load, the loaded weight and to print simplified receipts.



Simple mode

- 1 For information about the functions in this view, see 8.
- 2 For information about the functions in this view, see 61.

Enable Simple mode

To enable Simple mode, select Simple mode from the Application menu, select the wanted functions and enter the password.

The password consists of the last four digits in the serial number of the machine's Volvo Co-Pilot. The password is found on the back of Volvo Co-Pilot or in the settings for Volvo Co-Pilot.

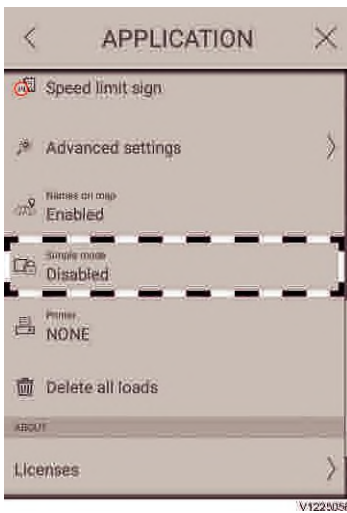

Application menu

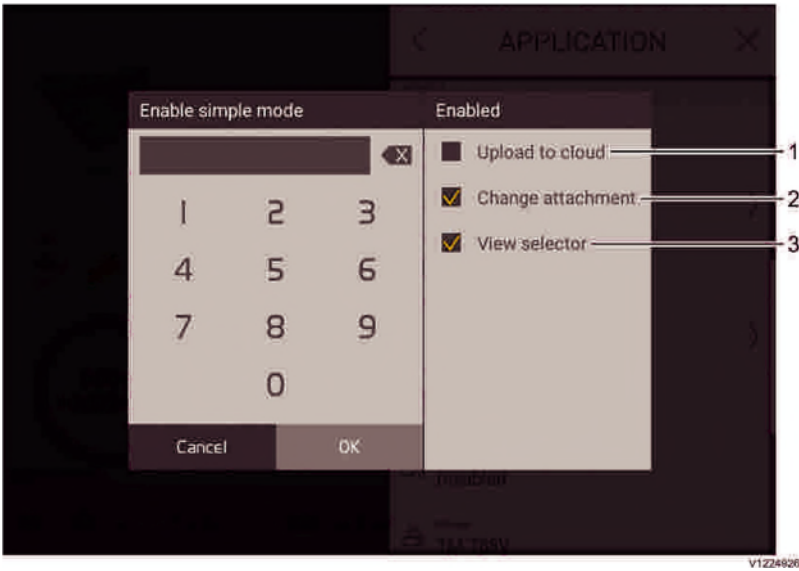

Password menu

- 1 For information, see 23.
- 2 For information, see 43.
- 3 For information, see 118.

Settings

In Simple mode, the following settings can be made:

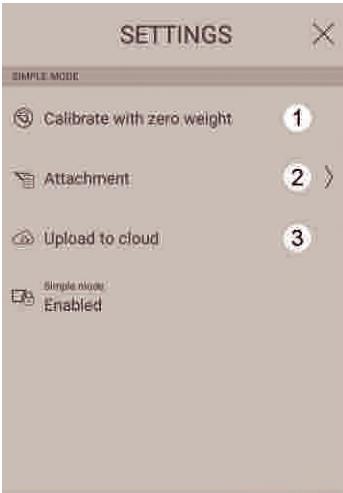

V1225073

Settings menu

- 1 For more information, see page 51.
- 2 For more information, see page 43.
- 3 For more information, see page 23.

Disable Simple mode

To disable Simple mode, select Simple mode from the Settings menu and enter the password.

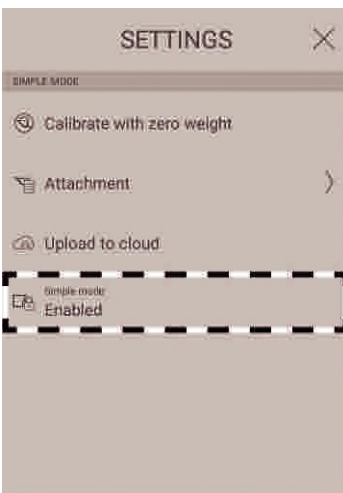

V1224977

Settings menu

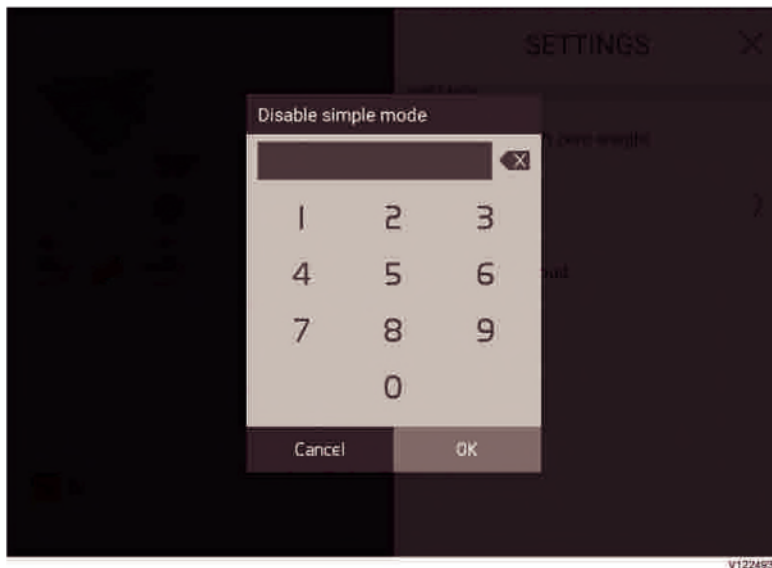

Password menu

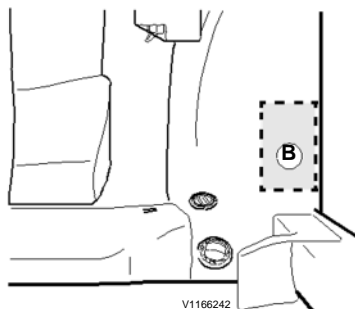

B Recommended printer position

Printer

NOTE!

Printers cannot be bought from Volvo, but supported models and recommended location in the cab are given in the information below.

NOTE!

The printer must be connected with USB-cable to the Co-Pilot.

For information about receipt functionality, see page 65.

Supported printer models from Epson

(Please contact your local Epson dealer for recommendation on what printers are available for a specific country.)

TM-T20	TM-T20II	TM-T20III	TM-T60
TM-T70	TM-T70II	TM-T81II	TM-T82
TM-T82II	TM-T83II	TM-T88V	TM-T88VI
TM-P20	TM-P60	TM-P60II	TM-P80
TM-U220	TM-U330	TM-m30II	TM-m30
		TM-m10	

Load weighing

Weighing accuracy

The typical weighing accuracy depends on how the machine is used and calibrated. Higher accuracy can be met depending on above prerequisites. The accuracy is based on 1% of the maximum pressure sensor capacity.

The typical accuracy level applies as follows (if the conditions are fulfilled):

- $\pm 1\%$ (for known weight calibrated buckets): Based on every load.
- $\pm 2\%$ (for other attachments): Based on an average of 10 loads.
- $\pm 2\%$ (loads at low load mode): Based on an average of 10 loads.

The following conditions must be fulfilled to reach, and maintain, the typical accuracy level given above:

- New machines must be handled according to the running-in instructions, see page 5.
- Calibrations must be performed when needed and according to information, see page 49.
- Loading must be performed in a proper way, see page 40.
- The machine must be maintained a proper way, see page 121.

■ The hydraulic oil temperature must be at least 40 °C (104 °F).

NOTE!

Deviations from normal operating conditions, machine and attachment configurations can lead to that the typical weighing accuracy could not be reached.

NOTE!

The weighing functionality is limited for high tipping buckets and side tipping buckets. The system weighs the load with these buckets, but the weight should be manually added by tapping the symbol, see page 45.

NOTE!

The weighing functionality is limited in block handling since the high lift height required for the system to properly weigh the load is not suitable in this application. It is possible to have the load locked if the lifting motion is stopped when the figures for current load are still grey, but the accuracy can be affected.

Machine model		L110H	L120H	L150H	L180H	L220H	L250H	L260H	L350H
Typical weighing accuracy	kg	+/- 80	+/- 90	+/- 110	+/- 130	+/- 150	+/-180	+/- 190	+/- 260
	lb	+/- 180	+/- 200	+/- 240	+/- 290	+/- 330	+/- 400	+/- 420	+/- 570
Static sensor capacity	kg	8000	9000	11000	13000	15000	18000	19000	26000
	lb	17600	19800	24300	28700	33000	39700	41900	57300
Load range	kg	300 – 6800	300 – 7500	400 – 9300	500 – 11250	500 – 13000	600 – 14000	600 – 14000	800 – 21000
	lb	700 – 15000	700 – 16500	900 – 20500	1100 – 24800	1100 – 28700	1300 – 30900	1300 – 30900	1800 – 46300

40 Load weighing

Load range,	kg	60 – 300	60 – 300	80 – 400	90 – 500	110 – 500	130 – 600	130 – 600	180 – 800
Low load mode	lb	120 – 700	120 – 700	170 – 900	200 – 1100	240 – 1100	280 – 1300	280 – 1300	390 – 1800

NOTE!

The load range figures in the table apply as long as the attachment used when loading has not been given any adjustment value, see page 57.

NOTE!

The system will not show any weight data below the load range limit. The typical weighing accuracy can not be guaranteed above the load range limit.

Loading

Loading should be performed as it normally would be done, however, by following the instruction below will yield the most accurate weighing result.

NOTE!

First, see page 38 for information about the weighing accuracy (not only related to how loading is performed).

- 1 The attachment should be in carrying position during weighing.
- 2 Avoid sudden and intense adjustments in steering and machine speed during weighing.
- 3 Lift the load in a smooth continuous motion at a constant speed until an audible signal (if set) is heard and the locked padlock icon confirms that the weight is measured correctly.
- 4 Make sure that stuck material does not build up in the bucket. The weight of any stuck material that is not unloaded will be added in the system.
- 5 Keep the ground surface, where loading takes place, level and clean.
- 6 Avoid spilling material from that the load is locked to when it is dumped on the target. This is not related to the weighing accuracy of the system itself, but can make a difference when comparing to the results from the weighing bridge.
- 7 To avoid the weight being locked when the bucket is still in the pile, use Reverse before locking load, see page 59.



Padlock (locked / unlocked weight)

The system may not lock the load if the system detects significant variations in the calculation during the weighing.

Some reasons for this are:

- Significant variations in the lifting speed during weighing
- Significant accelerations (quick machine movements) in different directions – as a reference, the entire cycle in short cycle loading should normally take minimum 25 seconds to keep these accelerations to an appropriate level
- Ground smoothness
- High linkage friction
- Modification on attachment, attachment bracket and/or boom
- Movement of the bucket during the lift of the load
- Viscous material which moves around in the bucket

Guidance for locked weight when using Known weight calibrated buckets

The three symbols, shown in the illustrations to the left, work as a guidance for when the system will be able to lock the weight. When the current load is unlocked, the respective icon will be orange when the angle is outside the range for the system to qualify the load (locking the weight).

- Weighing should be performed within $\pm 5^\circ$ transversal machine inclination (“roll”).
- Weighing should be performed within $\pm 5^\circ$ longitudinal machine inclination (“pitch”).
- Weighing should be performed with the boom within $\pm 20^\circ$ from horizontal position.

To allow the operator to operate in a dynamic way, the system could qualify the weight (“lock the weight”) even in rough conditions. This could to some extent affect the typical accuracy of the system. The system can still qualify weights outside the given accuracy levels, see page 38.

Guidance for locked weight when using Low load mode

When Low load mode is enabled, the system can weigh a lower weight than in normal mode. The Low load mode enables a measuring window in a lower weight range than in normal mode, but with a lower accuracy. In the normal weight range the system



works as normal and with the same accuracy as usual. For more information, see page 38. Low load mode is enabled in the Application menu, see page 27.

To be able to lock a weight in Low load mode, the weighing should be performed in the same way as for normal mode but with three additional conditions:

- The active attachment is of type bucket (normal, high or side tip).
- The machine is stationary.
- The boom passes horizontal position during the lifting motion.

If a weight is locked in the lower range enabled by Low load mode, it is not possible to perform partial unload (automatically or manually).

Current load

The current load in/on the attachment. An audible signal confirms that the load is weighed correctly and that the load is locked.

- Grey figures indicate that the system is ready to weigh the load.
- Black figures (or white in night mode) indicate that the load has been weighed, is locked, and is ready to be dumped on the target.
- Red figures indicate that the weighed load is above the manually adjusted overload limit. Constant audible signals are given if this is not turned off in the settings.
- There are two decimals on load value when a known weight calibrated buckets is used and one decimal when an other attachment is used.



- Metric tons (t), short tons (ST) or pounds (lb) can be selected as the unit of measurement.

NOTE!

The figures shown in the display are rounded to the nearest 0.02 t, 0.05 t or 0.1 t depending on machine size and if a known weight calibrated bucket is selected or not. If the selected weight unit is pounds (lb), the figures shown in the display are rounded to the nearest 50 lb or 100 lb depending on machine size

NOTE!

For best accuracy, the starting position for lifting the load should be with the attachment in the carrying position. This should also be used when the attachment is calibrated, see page 49.

Locked/unlocked load

When the load is weighed correctly it is locked, but if material is spilled after that, the load in the bucket must be reweighed before it is dumped on the target. Tap on the icon to unlock it and then reweigh the load.

NOTE!

If the same load is reweighed several times, the friction in the lifting unit might increase and the estimation of the load will change for each qualified load.

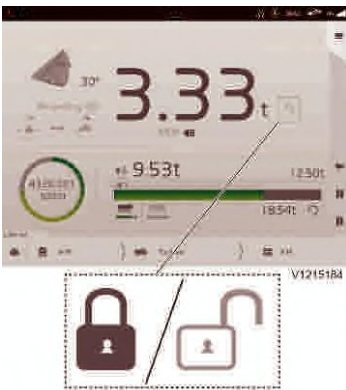

Attachment

Shows the current attachment type. Tap on icon to view, edit or select attachments.



Attachment angle

The figure shows the attachment current angle, where 0° position is set by the operator. It increases when tilting in and decreases when tilting out, so it works as a good reference for the angle of the physical attachment as long as it is first set correctly.

To set attachment angle, see page 53.



Bucket load adjustment

Shows the weight adjustment of the current attachment. For the method to adjust the weight, see page 57.



Known weight calibrated buckets

This icon indicates that known weight calibration has been performed for this bucket, see page 54 and that the weighing accuracy is within $\pm 1\%$, see page 38.



Machine inclination, transversal (“roll”)



Shows the angle for transversal inclination.

- Permitted angle range is within $\pm 5^\circ$ when weighing with known weight calibrated buckets.
- Permitted angle range is within $\pm 2^\circ$ when calibrating.
- The icon will become orange outside permitted angle range.
(Only with known weight calibrated buckets)

Boom angle



Shows the angle of boom.

- Permitted working angle range is $\pm 20^\circ$ when weighing with known weight calibrated buckets.
- The icon will become orange outside permitted angle range.

Machine inclination, longitudinal (“pitch”)



Shows the angle for longitudinal inclination.

- Permitted angle range is within $\pm 5^\circ$ when weighing with known weight calibrated buckets.
- Permitted angle range is within $\pm 2^\circ$ when calibrating.
- The icon will become orange outside permitted angle range.
(Only with known weight calibrated buckets)



Forced unload

NOTE!

This function is only available when a bucket in the category “Side tipping bucket” or “High tipping bucket” has been selected. Depending on bucket type, material, driving style, etc., the function may or may not be used.

- 1 Make sure that the load is weighed and locked.
- 2 Dump the load on the target.

NOTE!

If the load is not automatically added in the system, proceed to next step.

- 3 Tap on the icon.
- 4 Check that the dumped load has been added in the system.

Forced partial unloading

NOTE!

Tap the icon to manually start partial unloading if less than 5% of the current bucket load should be unloaded, see instruction below. The system automatically detects partial unloading scenarios during normal driving when approximately 5% of the locked weight is unloaded.

- 1 Make sure that the load is weighed and locked.
- 2 Tap on the icon to manually start the partial unloading sequence.

- 3 Keep the boom in a horizontal position if possible. Horizontal position $\pm 20^\circ$ is recommended for the most accurate live update of the current load while unloading.
- 4 **Slowly** unload the material (to pile or target) and

follow the figures for current load or exceeding load in the overload indicator (“red flag”) while unloading.

- 5 Reweigh the load so it gets locked again. The partial unload is detected and a message appear.

NOTE!

It is important to tilt back the bucket to weighing position before reweighing the load, or the system may not lock the load.

- 6 If the message is not tapped (or closed), it is assumed that the dumped material is unwanted

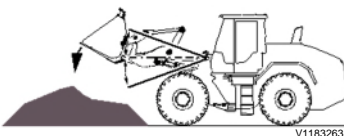

(back to pile). Only tap on the message if the dumped material should be added in the system.

NOTE!

The current load during partial unloading (any situation with grey figures) is an estimated load and might therefore differ from the locked weight in any situation.

For further information about partial unloading, see page 47.

Partial unloading

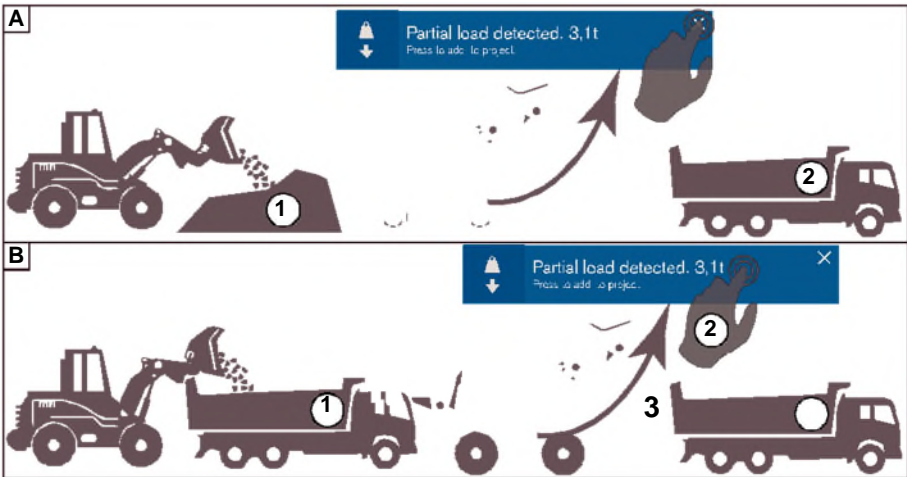

V1165933

When the load is weighed but not all material should be added to the current target, parts of the load (partial unloading) should be dumped either A) back on the pile (unwanted material) or B) on the target(s) (wanted material), depending on what is most suitable. See illustration and check the scenario A and B.

A) Load is weighed, dumping unwanted material back on the pile
NOTE!
Scenario A can typically be used when it is too much material in the last bucket load for the current target and there is no trailer, or waiting trucks, to dump any remaining material on. Scenario A normally gives the best weighing accuracy.

B) Load is weighed, dumping wanted material on targets
NOTE!
Scenario B can typically be used when it is too much material in the last bucket load for the current target but there is a trailer, or a waiting truck, to dump the remaining material on.

48 Load weighing

1 Dump the unwanted material back on the pile (check the weight of the current load while dumping), put the bucket in weighing position again and re-weigh the remaining (wanted) material.

NOTE!

Ignore the message (or close it) – that is, do not add the unwanted material to the system.

2 Dump all the remaining material on the target and it (the wanted material) will be added to the target/work order.

NOTE!

Before re-weighing the load, always remember to tilt back the bucket to weighing position. The system will not confirm the weighing if the bucket is not sufficiently tilted back.

1 Dump the wanted material on the current target, put the bucket in weighing position again and re-weigh the remaining material.

2 When the load is locked, an information message pops up (see above). Tap on the message to add the load to the current target.

NOTE!

Change to the next target before dumping the remaining material.

3 Dump the remaining material on the next target (or trailer).

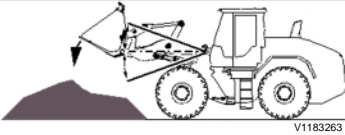

NOTE!

The current load during partial unloading (any situation with grey figures) is an estimated load. Partial unloading can be performed at any boom position but the live update of the current load

during partial unloading is most accurate when the boom is within $\pm 20^\circ$ from horizontal position and can therefore mainly be used for scenario A (dumping unwanted material back to pile). To manually start the partial unload sequence, see page 46.

Attachment, calibrating

NOTE!

The weight of the attachment is included when calibrating it and do not have to be considered, only that the attachment should be empty from material when calibrating it.

Attachment calibration must be performed so that the system can calculate the weight of the attachment (along with friction in the linkages and some resistance in the hydraulic system depending on oil temperature). Calibration should be done either upon request by the system in form of a message (for example at the first start of the day, when connecting a new attachment, or while the hydraulic oil temperature is rising), or via the settings when it is considered needed (for example after changing wear parts, or anything that affects the weight of the attachment). The system will request calibration for any of the following scenarios:

- When choosing an attachment that has not been calibrated before.
- After 24 hours has passed since the last calibration with the selected attachment was done.
- During warm up of the hydraulic oil at temperature below 40°C and difference between previous calibration is equal or more than 30°C .
- When the hydraulic oil is 40°C , or warmer, and the temperature at the previous calibration was below 20°C .

To be able to achieve $\pm 1\%$ accuracy, the bucket **MUST** be calibrated with a known weight. If not then $\pm 2\%$ accuracy will be used.

Accuracy	Supported attachments	Calibration requirements
±1%	Buckets	Calibration with zero weight Calibration with known weight (optional software required) ^(a)
±2%	All available	Calibration with zero weight

a)The optional software is installed if “Calibrate with known weight” is found in the menu. Contact your dealer for further information.

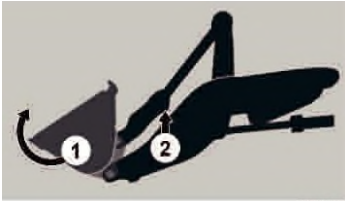

V1166009

Important for a successful calibration is to:

- 1 Set the attachment in carrying position before starting to lift
- 2 Lift in a smooth continues lifting motion and do not press in with the tilt cylinder when lifting

NOTE!

Follow the instructions given on the display carefully when performing a calibration. The first step in the calibration sequence, to set the preferred zero angle for the attachment, will only be needed in the first calibration after adding a new attachment – not in continues calibrations of the same attachment.

The following can be worth noting to achieve the most accurate calibrations:

- Make sure that there is no material left on/in the attachment before calibration is performed.
- Calibrate with the attachment in carrying position.
- Do not tilt back the attachment with high pressure when lifting since this can affect the lift cylinder pressure.
- Raise the attachment at a constant speed until the calibration is completed.

Calibration sequence

The calibration sequence should be followed carefully when performing a calibration. In the example below, a bucket is calibrated. The images

shown in the calibration sequence depend on the type of attachment that is calibrated.

NOTE!

The first step in the calibration sequence, to set the preferred zero angle for the attachment, will only be needed in the first calibration after adding a new attachment – not in continues calibrations of the same attachment.

NOTE!

When following the sequence, remember to first carry out the physical adjustment (tilt, lower, etc.) before making the setting in the screen (“tapping”), as indicated by “1”, “2” and “3” in the example below. For example, if the attachment has not been put in correct position when the calibration is started, the accuracy when weighing will not be optimal.

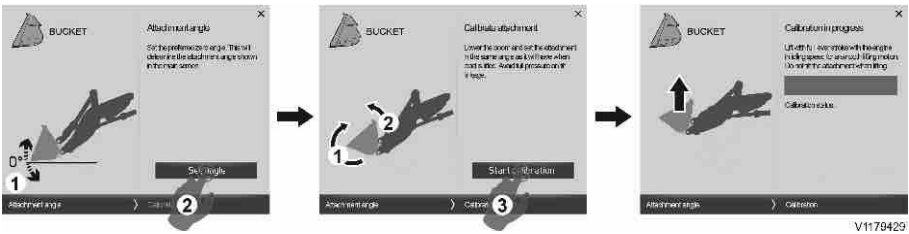

1. Tilt the attachment to the angle preferred as zero angle.
2. When the attachment is put in the angle preferred as zero angle, tap on “Set angle” to save.

1. Put the attachment in carrying position.
2. If the attachment is fully tilted in, tilt out 2–3° to release any built up cylinder pressure.
3. When the attachment is positioned and ready to be lifted, tap on “Start calibration”.

Lift with full lever stroke and the engine in idling speed until the message “Calibration successful” is shown.

Calibrate with zero weight

NOTE!

The weight of the attachment is included when calibrating it and does not have to be considered, only that the attachment should be empty from material when calibrating it.

The system will request zero calibration for any of the following scenarios:

- When choosing an attachment that has not been calibrated before.
- After 24 hours has passed since the last calibration with the selected attachment was done.
- During warm up of the hydraulic oil at temperature below 40 °C (104 °F) and difference compared to the previous calibration is equal to or more than 30 °C (86 °F).
- When the hydraulic oil is 40 °C (104 °F), or warmer, and the temperature at the previous calibration was below 20 °C (68 °F).



Zero weight calibration required in X minutes

Press to start calibration

V1200052

NOTE!

It could be necessary to delay starting a zero weight calibration to finalize a working cycle for example. The information message (to the left) comes up when five minutes remains until the calibration must be performed and the countdown will be visible in the message. When the time is up, the system will register weights but not add it to the total weight. Tap on the message to start the calibration. If the message is closed it will reappear once every minute.

When performing a zero weight calibration, first make sure that the attachment is empty and then follow the calibration sequence in the display carefully.

The illustrations and the information below is tied to the sequence for a bucket. The same type of guidance is given in the sequences for pallet forks and grapples but the exact information presented is suited for these attachments there. Some of the steps shown below may not appear in the sequence in the display because the attachment is already in the correct position for the next step in the sequence.

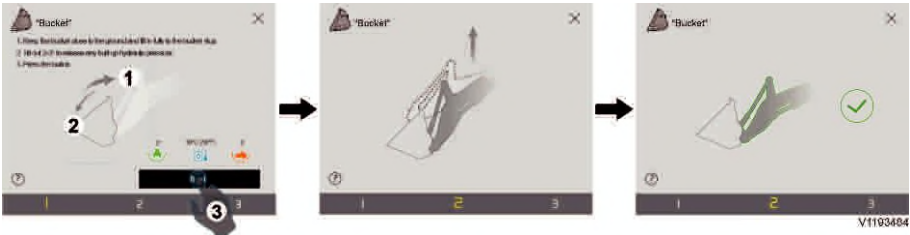

NOTE!

Follow the instruction given in the first step of the sequence and carry out all prerequisites that are needed before tapping on the button.

All three symbols must be green when performing the calibration to facilitate that the typical weighing accuracy can be reached, see page 38.

The symbol for hydraulic oil temperature is blue below 40 °C (104 °F) and the two symbols for machine inclination are orange when outside $\pm 2^\circ$. Since this calibration must be performed daily (for the selected attachment) and during warm up of the hydraulic oil, the calibration can be force started, but it is recommended to always stay within $\pm 2^\circ$ for the machine inclinations when performing this calibration.

When everything is carried out according to the instruction, tap on the next-button and follow the guidance given in the steps that appear in the display.



Lift with a smooth continuous lifting motion all the way up to the target position. To keep the lifting speed constant, it is recommended to use full lever stroke and the engine in idling speed all the way up to the target position where the confirmation is given. If the system does not accept a step it will indicate how to redo that step.

NOTE!

When tapping on the button to finalize the calibration, the system will indicate if the calibration is successful or has failed.

The last step shown here is not part of the calibration sequence and only comes up for buckets that has not been calibrated with a known weight. If the hydraulic oil temperature exceeds 40 °C (104 °F) it is recommended to start the known weight calibration directly.



Enter the menu

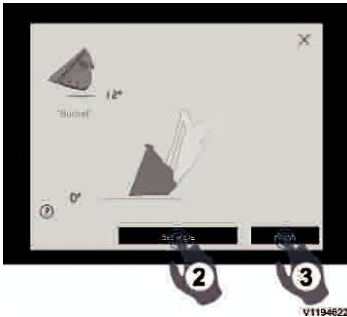
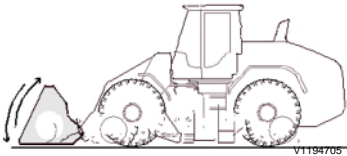

- 1 Tilt in/out to preferred zero angle
- 2 Set angle
- 3 Finish

Set attachment angle

NOTE!

This procedure is separate from the calibrations and does not affect the weighing accuracy. The system will store the attachment angle so it is only needed to set it one time for each attachment.

The attachment angle is shown in the main screen and can therefore work as a good reference for the angle of the physical attachment as long as it is first set correctly.

When setting the attachment angle, the attachment should first be tilted in/out to the preferred zero angle and then the angle is stored when setting the angle (tapping the icon). Then, the attachment angle will always be shown as 0° on the main screen for this attachment in this angle.

Normally, the preferred zero angle is the angle the attachment has when a load should be taken (for example bucket bottom, or pallet forks, parallel to the ground), but it can be set as wanted for the work that should be performed.

Setting the attachment angle is never prompted by the system, but can be manually started by entering the menu for it.

- 1 Enter the menu: "SETTINGS" > "MACHINE" > "Set attachment angle".
- 2 Tilt in/out to the preferred zero angle.
- 3 Tap "Set angle" and check that the attachment angle is shown as 0° in the main screen.
- 4 Tap "Finish".

Calibrate with known weight

(optional software functionality)

NOTE!

This calibration can only be performed for buckets and if the system has been updated with this functionality. The system will have a typical weighing accuracy of $\pm 1\%$ when using a successfully calibrated bucket, see page 38.

The system will only request known weight calibration directly after the first zero weight calibration with a new bucket (and never again for that bucket).

For best accuracy, known weight calibration should also be performed:

- After approximately 200 hours with a new machine.
- Every year for each bucket that is calibrated with known weight.

NOTE!

Make sure that no adjustment value is set for the bucket that should be calibrated with known weight since this will affect the weighing results after the calibration has been done. The adjustment value is intended to be used if a consistent difference between the weight given by the system and the weight given by the weighing bridge is identified. For further information see page 57.

The calibration can be done in two ways:

■ **Using an available weighing bridge:** Here, the material in a full bucket is used as the “known weight” and the weight (measured via the weighing bridge) is entered as the last step in the calibration sequence (shown on the next page). ■ **Using an object with known weight:** Here, an **object already has a known weight that is entered as the last step of the calibration sequence. For best accuracy it is important that the weight of the object is close to the weight of the material in a full bucket and also that the object’s centre of gravity is positioned over the bucket pin.**



·V1193486

NOTE!

Follow the instruction given in the first step of the sequence and carry out all prerequisites that are needed before tapping on the button to proceed.

All three symbols must be green to start the calibration. The symbol for hydraulic oil temperature is blue (for "too cold") below 40 °C (104 °F) and the two symbols for machine inclination are orange when outside $\pm 2^\circ$.

NOTE!

The requirement to have all three symbols green also applies to the zero weight calibration which should be done just before the known weight calibration starts, and within a time period of 10 minutes from a zero weight calibration.

When all preconditions are fulfilled, tap on the button and follow the guidance given in the steps that appear in the display.

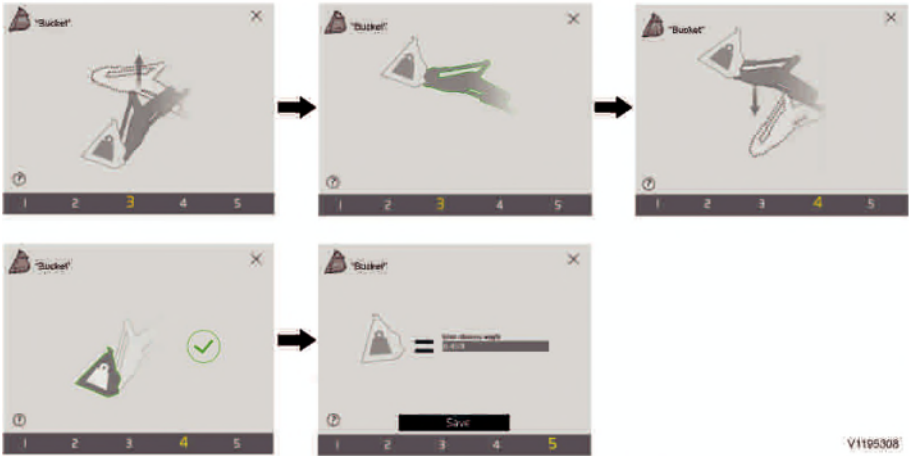

Follow the guidance in the display. Lift with a smooth continuous lifting motion all the way up to the target position. To keep the lifting speed constant, it is recommended to use full lever stroke and the engine at idling speed all the way up to the target position where a confirmation is given. Also lower at a low constant speed all the way down to the target position until the confirmation is given.

The known weight should be entered in the last step of the sequence.

NOTE!

When tapping on the button to finalize the calibration, the system will indicate if the calibration is successful or has failed. After a successful calibration, the display should include the symbol for known weight calibrated buckets and two decimals for all weight indication figures in the system.

Adjusting to reference weight

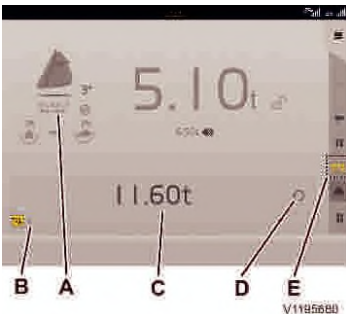

Main screen in trip meter mode

- A Adjustment value
- B Number of bucket loads (since last reset)
- C Weight
- D Reset, weight and bucket counter
- E Trip meter mode



Edit weight adjustment

- 1 Current weight from trip mode
- 2 Reference weight
- 3 Adjustment value

NOTE!

This function should only be used if there is a consistent difference between the weighing that is performed by the system and a known reference weight (for example from the weighbridge that is used). It should not be compared to, or used as, the weighing functionality of certified load weighing systems. Even when an adjustment value is calculated and set, some loads might be outside the typical weighing accuracy, see page 38.

The weighing that is performed by the system can be adjusted to a reference weight by typing in the reference weight in the edit window for the attachment that should be used for loading. The reference weight is usually the weight given by the scale that should be used for the invoicing. When storing the reference weight in the system, an adjustment value (in percentage) is generated that is shown in the main screen below the attachment name.

NOTE!

The adjustment value can also be edited directly.

NOTE!

The adjustment value is tied to the attachment and the scale (weighbridge) that gives the reference weight. If the attachment is changed and/or another scale needs to be used for weighing, the adjustment procedure must be redone. If a new adjustment value is needed for an attachment, the old value must be deleted first.

NOTE!

The adjustment value could differ depending on application and operating style.

Follow the procedure below to adjust to a reference weight:

- 1 Make sure which scale that will be used to get the reference weight and that the attachment that should be used when loading is selected.
- 2 Perform an attachment calibration with the machine in operating temperature, see page 49.
- 3 Select trip meter mode (E) and reset the trip meter (D).

- 4 Carry out minimum 10 unique load cycles to load material that should be weighed for reference weight.

NOTE!

The 10 load cycles should be done in the same way as during normal operation (normal for the specific operator). The 10 cycles should not be done in a slower way for instance.

- 5 When all material has been weighed on the scale go to “SETTINGS” > “MACHINE” > “Attachment” and tap on the attachment that is used to open up the edit window (“Edit weight adjustment”).
- 6 Type in the total weight of the material that has been weighed on the scale under “Reference weight” (2). An “Adjustment value” (3) is given.
- 7 Tap on “OK” to store and the adjustment value should be visible in the main screen under the attachment name.

Reverse before locking load

NOTE! This function is only needed for, and applicable to, buckets. It is possible to enable it for other attachments but it will have no effect.

When loading light materials, the system may indicate a locked weight even though the bucket is still in the pile. In the event that this happens, this setting can be enabled in the setup menu to force the system to lock the load only after reverse gear has been selected.

Tap Reverse before locking load in the menu to enable the function, and tap again to disable it.

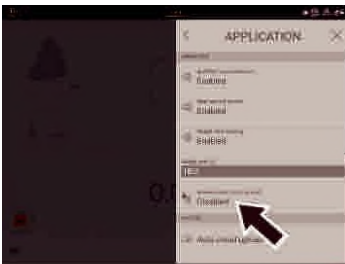

V1216555

60 Load Assist Load weighing



The R-icon beside the lock icon indicates that the function is active.

The reverse gear must have been active at least 1 second after a normal bucket filling motion is detected before the system will allow a new weighing to be performed.



The icon will be orange and the load will not be locked if the system can't weigh the load because one or more of the previously described conditions are not met.

Task mode

Different task mode can be selected as below when loading for different purposes.

Tap on the helmet icon to enter the task mode. What is shown in the display differs depending on what task is selected.

- For Trip, see page 61.
- For Truck, see page 62.
- For Pile, see page 63. (Optional equipment)
- For Process, see page 64.

(Optional equipment)



1 Project bar

Project information is shown in project bar according to the selected task mode. Project information menu can be reached by tapping each icon, or by going to SETTINGS -> PROJECT.

Trip

Tap on the icon to enter Trip mode.





In trip mode, qualified loads will be added to the trip meter.

- 1 Number of bucket loads (since last reset)
- 2 Total loaded weight (since last reset)
- 3 Preliminary total weight with current bucket load
- 4 Reset

With an installed printer, a receipt can be printed in this mode, see page 65.

Truck

Truck mode is used when loading trucks with one or multiple compartments.

Tap on the icon to enter Truck mode.

To store loads in truck mode, a work order and/or a truck must be active in the project bar.



Truck load progress

In truck mode, truck load progress is shown as a bar with sections in different colors.

A Tap on the icon to switch between showing weight already loaded OR weight remaining to load.

B Shows number bucket loads since last reset. C This part shows how much weight has been added to the target.

D This part shows the current load in/on the attachment.

E This part shows how much weight remaining to load.

F This part indicates weight that exceeds the total target load.

G Tap on the icon to reset the weight and the bucket counter.

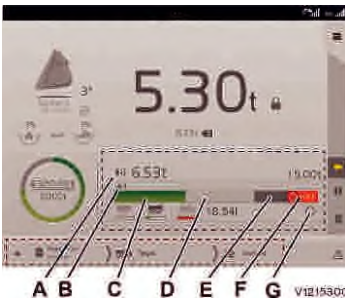

Work order load progress



Shows fulfilment of the target load for the active work order. The green part of the circle shows added load. The target load has been reached when the circle is completely yellow. In case of overload, a notification in red will show the overload in number of tonnes. Tap on the circle to edit and finish the active work order.

With an installed printer, a receipt can be printed in this mode, see page 65.

Pile

(Optional equipment)

Pile mode is used to keep track of piles and materials on your site.

The Pile has a name and connected material to it. The material can be changed to the selected pile if wanted.

Tap on the icon to enter Pile mode.



In pile mode, fulfilment of the target load to piles are shown. The green part of the circle shows added load. The target load has been reached when the circle is completely green.

A On the active pile, you will find the reset icon to reset the load.

B Tap on another pile icon to quickly switch to another pile task and activate the material of that pile.

Pile can be shown or hidden on screen.

1. Tap on the pile icon to go to Pile menu.





V12159899

- By tapping the eye icon, you can show or hide one or several piles.

Process

(Optional equipment)

Process mode is used for instance when loading a crusher or load pockets on the site. The target can be set to know when you have reached the desired amount of material.

The Process has a name and a connected material. The material can be changed to the selected process if wanted.

Tap on the icon to enter Process mode.



V1215627

In process mode, fulfilment of the target load to a crusher is shown.

The green part of the circle shows added load. The target load has been reached when the circle is completely green.

A On the active pile, you will find the reset icon to reset the load.

B Tap on another pile icon to quickly switch to another pile task and activate the material of that process task.



V1215626

Process can be shown or hidden on screen.

- Tap on the process icon to go to Process menu.



V1215670

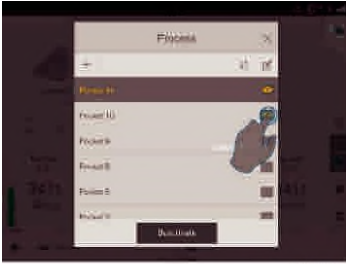

V1215671

2. By tapping the eye icon, you can show or hide one or several piles.

Delete last load

If material has been added to the active project by mistake (that is – dumped on a pile or on other targets than in the active project), it can be deleted. Tap on the icon to delete the last load. After printing a receipt, this icon will be disabled until next bucket has been registered.



V1215185

Pause view

Tap on the icon to enter the pause mode which disables the task mode. Here, only the current load in/on the attachment is measured and visible and no load is added to any task. The pause mode can typically be used when planning or cleaning the work site.

NOTE!

The weighing function is still active here (showing the current load) but not in any tasks, so the weight will not be added to any work orders or targets in this mode.



V1215669

Print receipt

After finishing a target in **Truck mode** or a task in **Trip mode**, a print receipt can be generated by tapping 'Print' icon.

The information shown on the receipt, follow what is activated in the project, and what will also be printed on the receipt. This can be checked in the project bar. It is also possible to print from the trip meter mode.



V1210818



V1205231

More than one copy of a receipt can be printed. Edit the number of copies with this setting.

VOLVO

Ticket number: 20 ————— 1

Supplier: ————— 2
Name: BHF
Address: Bolinder Road 123, 63510
Phone: 016-164100

Operator: Anton ————— 3

Location: Eskilstuna ————— 2

Date: 08/01/2019
Time: 13:20

Customer: Annas Byggbolag

Work order: John

Target: Truck with 2 trailers

Truck with 2 trailers(1): 20.50 t
O-16: 20.50 t ————— 4

Truck with 2 trailers(2): 10.00 t
O-16: 10.00 t

Truck with 2 trailers(3): 10.00 t
O-16: 10.00 t

Total Material
O-16: 40.50 t

Bucket count: 9

Total: 40.50 t

V1205232

- 1 Every receipt has a single Ticket number.
 - The Ticket number can be tracked in history and it is possible to print previous tickets.
- 2 Supplier and Location can be set in Settings - > SITE -> Supplier
 - Supplier's name, address, phone number and additional information can be added and printed on the receipt.
 - More than one location can be created. Location can be selected in the list when printing.
- 3 Operator's name will be shown here if the "operators profile" is used. Otherwise the machine's chassis-ID will be displayed. Regarding how to managing operator profiles in the system, see page *Volvo Co-Pilot, Login*.
- 4 Project information including customer, work order, target and material are listed in the receipt. Regarding how to create/edit project information, see page 13.
- 5 A receipt can also be generated in trip mode. In trip mode, target and customer can be filled in directly on print page.



V1205233

Tickets in history



Receipt can be printed out by printer, or exported as PDF file to USB-stick.

NOTE!

After generating a receipt, the truck or trip meter will be reset automatically.

Map

Map is a function in which a map of the site is created and used. By creating a unique map view of the site it is possible to follow the whereabouts of the connected construction machines/vehicles. It is also possible to see different load zones and dump zones. The map view helps operators to avoid line-ups and incidents since they can see where the machines and vehicles are. This can give a more uniform speed, thus reducing fuel consumption.

NOTE!

Keep in mind that not all machines/vehicles may be connected to the same group/map, and will therefore not be visible on the map. Use the map as a complement when operating the machine.

NOTE!

A GPS connection is required for the system to function.

Map, use

The Map function helps the operator to navigate on a large site and see where other machines/vehicles are located. The site roads are marked on the map, as well as any locations that are of interest to the operator. The map is produced by a user on the site, then the system distributes the map to the connected machines/vehicles.

The operator's own machine/vehicle is shown with an orange ring around it, and the other machines have a blue ring around the symbol.

The site may have speed limits, one for the whole site but also parts of routes or certain areas on the site may have other limits.

The site may have speed limits, either one limit for the whole site or different limits for parts of routes or certain areas on the site.

If the machine is operated at a higher speed than is permitted, a warning will be shown in Volvo Co-Pilot.

In combination with feature Map speed limiter, the system will also send a speed limit to the machine.

The machine then limits the signal of the accelerator pedal so that the machine cannot be driven faster than the maximum permitted speed.

If needed, it is possible to temporarily disable this feature in **Settings** → **Application** → **Advanced settings**, see page 30.



Some roads where the machines/vehicles operate may be so narrow that there is only room for one at a time. When the map is created it is possible to add single-lane roads. When two machines/vehicles are approaching the same single-lane road, warnings will be shown.



When another machine/vehicle is on a single-lane road farther ahead.

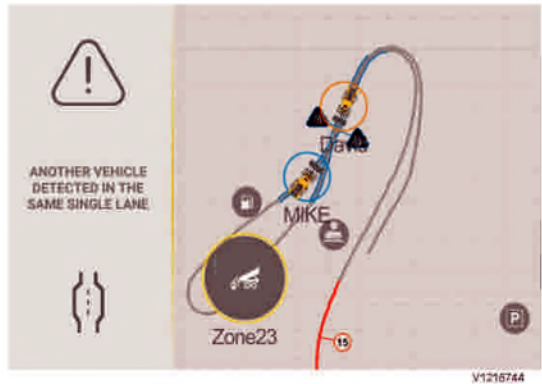

Two machines/vehicles have entered the same single-lane road.
There are other warnings that help operators.





There may be prohibited zones on the site, as well as no-vehicle zones, for example where the ground is too soft or a zone is at risk of collapse. These zones may be marked and warnings may appear on the screen when the machine/vehicle enters the zone.

Machine Group

The machine group is the machines/vehicles on a site that are connected to a map where their position is shown and updated continuously. All machines/vehicles in a group share a map and can see each other's position on the map. The map view must be activated to see each other. The machine group is created as the first step in using the function Map.

Machine Group, Create Machine Group

A machine group is created using settings.

- Click on the symbol at the top right in the status bar. 
- Then click on: SITE 

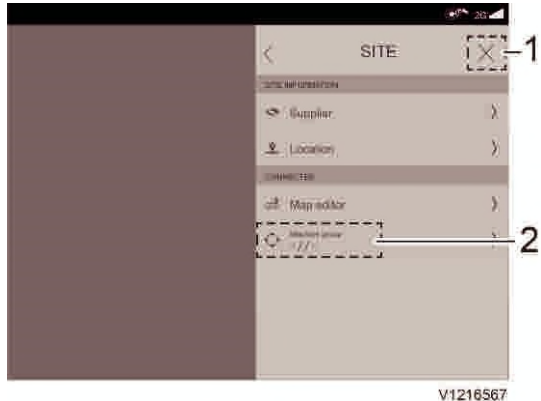

- 1 Closing symbol to exit the menu
- 2 Machine group, menu selection to create groups with machines. The symbol shows that there is no group.

To create a new group, click on Machine group (2)

- The next menu opens.
- Click on New machine group (2)

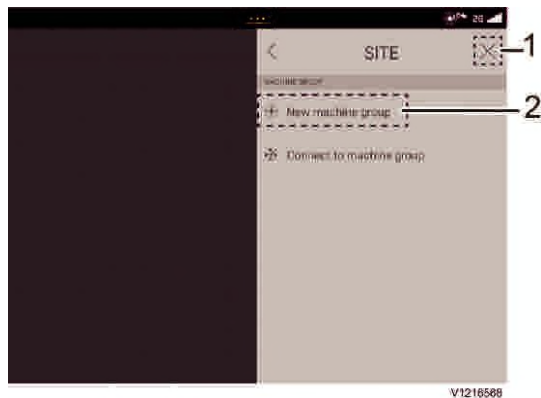

- A window for logging in opens. See page 12

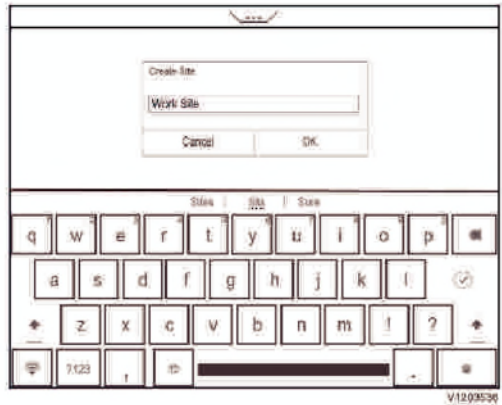

- Save the machine group by giving the group a name and clicking OK



- 1 Group with its name

Machine Group, Add Machine

An invitation code is required to add a machine/vehicle to a machine group. This code can be retrieved from all machines/vehicles that are connected to the group.

Retrieve the invitation code from a machine/vehicle connected to the group. See page 74

- Click on the symbol at the top right in the status bar.
- Then click on the top row: Site
- Click on the machine group's name

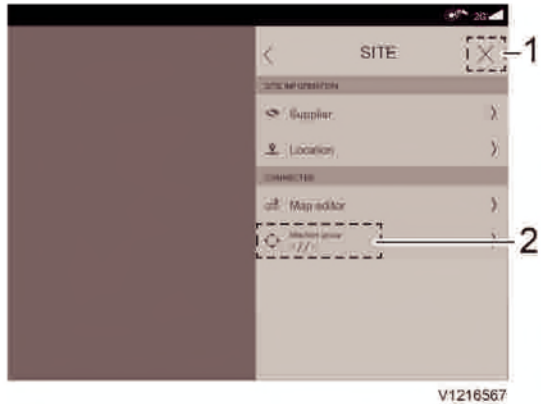

- 1 Closing symbol to exit the menu
 - 2 Machine group, menu selection to create or connect a machine/vehicle to a group
- A window for logging in opens. See page 12

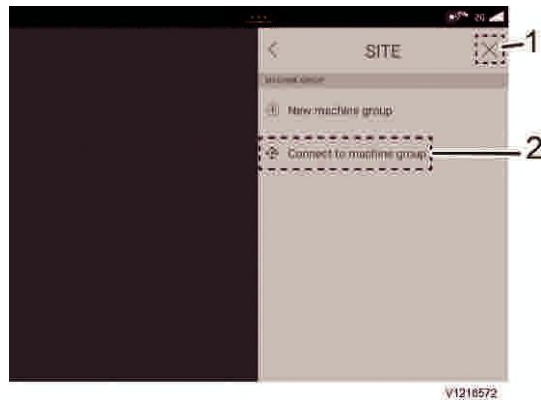

- 1 Closing symbol to exit the menu
 - 2 Connect to machine group
- By clicking on Connect to machine group, the invitation code can be entered and the machine/ vehicle connected to the group.

Machine group, Create Invite code

Create invitation code by:

- Click on the symbol at the top right in the status bar.☰
- Then click on the top row: Site
- Click on the machine group's name

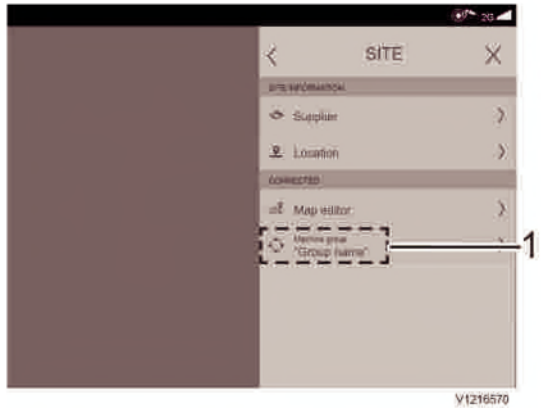

- A window for logging in opens. See page 12



1 Closing symbol to exit the menu

2 Invitation code

- By clicking on Invitation code, a window opens with a unique Invitation code.
- Write down the invitation code to bring it to the machine/vehicle to be invited.

NOTE!

The invitation code is valid for 24 hours and can be used for several machines/vehicles.

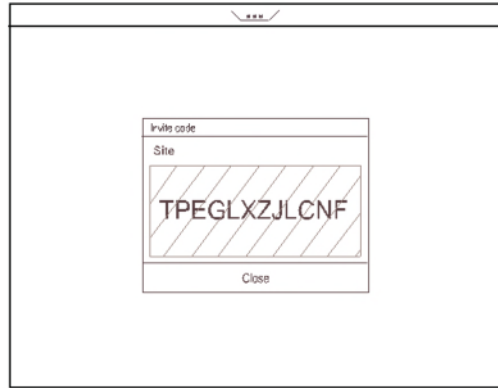

V1203630

Example code

Machine Group, Remove Machine

To remove a machine/vehicle from a machine group, proceed as follows from the machine/vehicle in question:

- Tap on the symbol at the top right in the status bar =
- Tap on “Site” and then on the machine group’s name

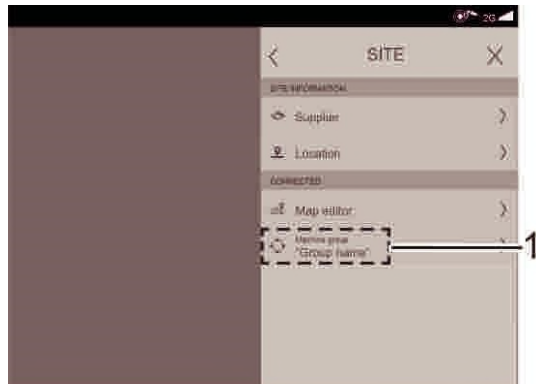

V1216570

- A window for logging in opens, see page 12
- Tap on “Disconnect machine group” and confirm that the machine/vehicle will be removed by tapping OK in the following window

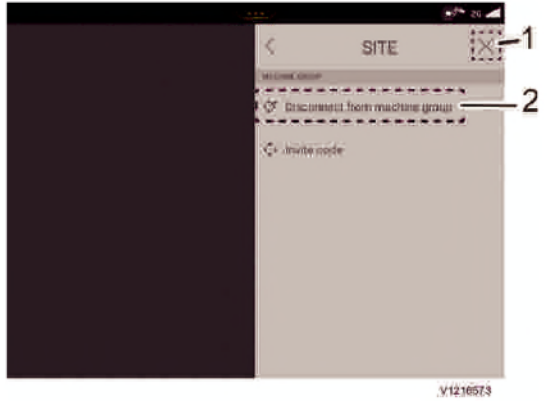

- 1 Closing symbol to exit the menu
- 2 Disconnect group

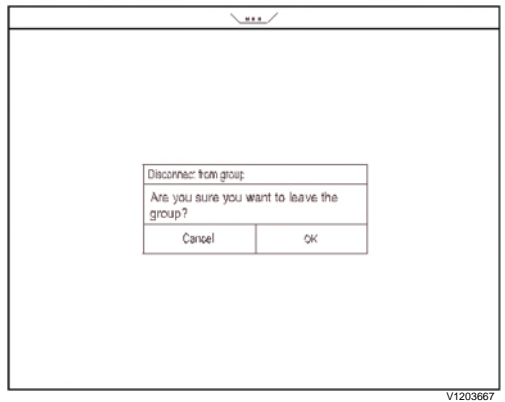

Map view

The map view is the work view for the operator when the map function of the site is used.





Split view with OBW and Map view.

- 1 Centering, symbol that only is visible when the map view is active
- 2 Project view, symbol for the project view in OBW. It is active when it is yellow.

Two views can be active at the same time. See page 118

When reverse gear is engaged, one of the sides is hidden. See page 117

Symbol marked 1 has the following functions:

	Centering deactivated	Centering over the machine is deactivated. Operate the machine, the machine does not follow camera but stops in the position on the map which the user is viewing at the moment. To access this mode, it is enough to drag your finger across the map
	Centering active	Click once on the centering button. The camera view is locked over the machine and follows it on the map when operating.
	Compass view	Click once more on the centering button and the symbol changes to a compass. This indicates that the camera rotates in the machine's direction. The machine model in the map always points up on the screen.

Manage map view

To create a map view, the user logs in to the map editor. See page 12

The first time a map is created of a site:

- 1 Start by creating a group of machines/vehicles. See page 71
- 2 Create a route. See page 79
- 3 Add content to the map. See page 80

4 Add background image. See page 111

Manage map view, create map

Before creating a map it is important to really think about its design:

- 1 What is the purpose of the map?
- 2 Should there be speed areas, or a speed limit on the whole site?
- 3 Size of load zone and dump zone?
- 4 What route is most suitable to operate on to and from load zone and dump zone?
- 5 Are there sections on the route that can only be used by one machine/vehicle at a time? Select these and make sure that they can be seen clearly on the map.
- 6 Are there places with reduced visibility?
- 7 What points of interest should be indicated on the map? These places help orientation on the site. There may be buildings, refuelling depots, masts, or other places that are important to the operator. It can also be places that are important on the site.

Plan the design of the map before starting the work. This makes map creation work easier and improves map quality.

NOTE!

Keep in mind that all maps that are created can be seen in all machines/vehicles connected to the group as soon as they are saved.

To create a map, start by:

- Click on the symbol at the top right in the status bar. 
- Then click on the top row: Site
- Click on Map editor

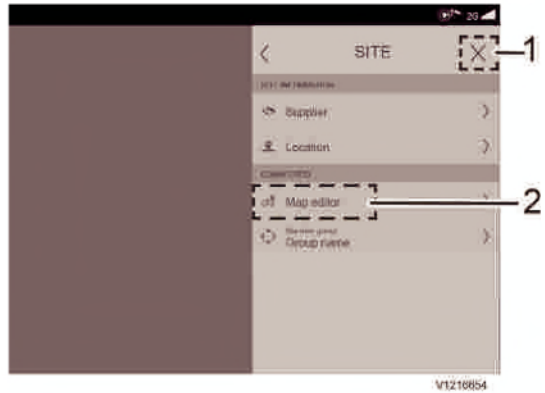

- A window for logging in opens. See page 12

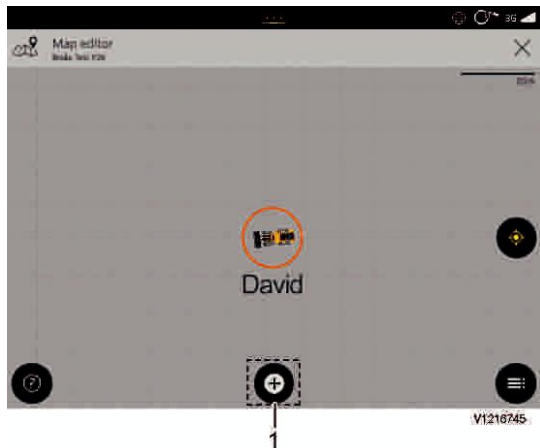

1 Open selection to add content

- Click on + in the middle at the bottom of the page to open the menu with different selections

Manage map view, add content

In the menu "Add content" there are several different selections:

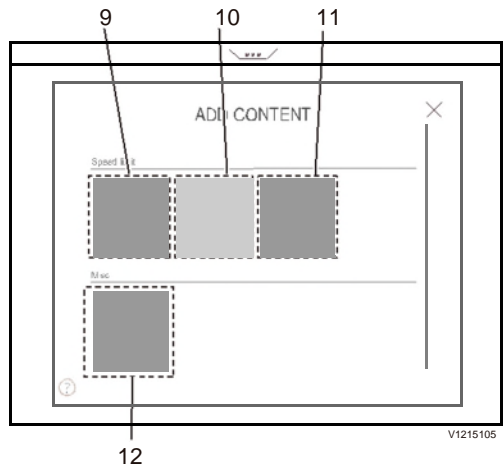
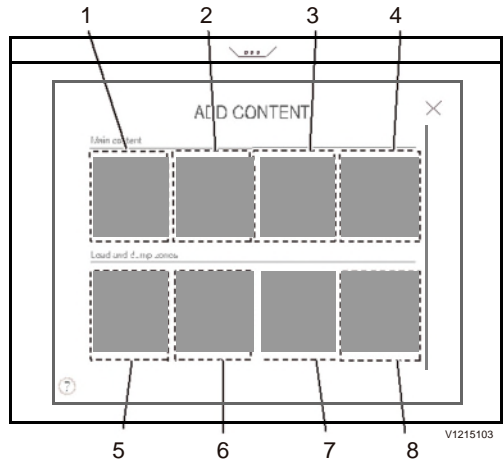

- 1 Add roads, see page 82
- 2 Add Points of interest. See page 88
- 3 Set speed limit on the whole site. See page 90
- 4 Add restricted zone. See page 107
- 5 Add irregularly shaped dump zone. See page 104
- 6 Add dump zone. See page 104
- 7 Add a traffic sign. See page 99
- 8 Add load zone. See page 100
- 9 Add speed limits on parts of road/route. See page 93
- 10 Add speed zone, see page 93
- 11 Add irregularly shaped speed zone. See page 93

12 Add background image to the map. See page 111

By clicking on any of the selections in the menu, new menus/windows are opened, making it possible to create content on the map.

Manage map view, add roads

To create roads is a way to create content on the map. A road may be a shorter section, a haul route between point A and B.

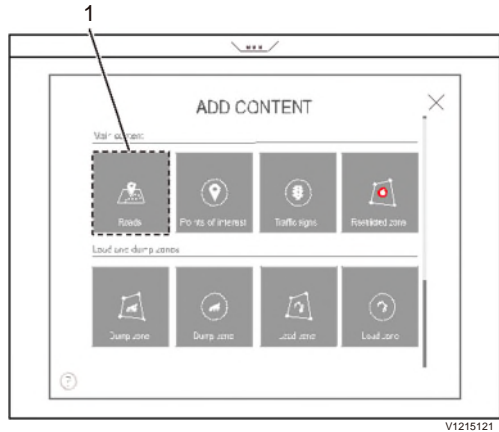

V1215121

1 Symbol to create roads

- To create roads, click on the symbol for roads
- Window for recording road opens. See page 86

Manage map view, modify road

To change the road, open the map editor. See page 79

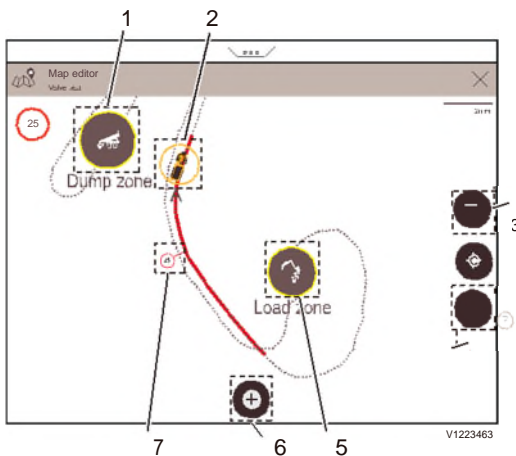

- 1 Dump zone
- 2 Machine/vehicle position
- 3 Menu
- 4 Help mode
- 5 Load Zone
- 6 Open menu to edit the map
- 7 Added Speed zone

NOTE!

Keep in mind that all changes made can be seen in all machines/vehicles connected to the group as soon as they are saved.

Change in the map for road

- Locate the part of the road that is to be changed.
- Change the road
- Save and exit the map editor.

Change the name of a road

- By clicking on the menu (3), a window opens with everything, all that has been created for the map can be seen.

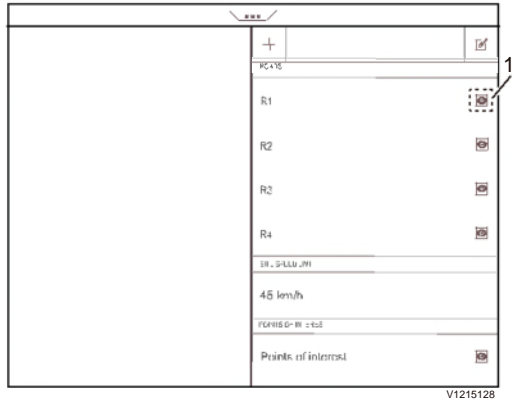

All created objects are listed. The ones shown with a yellow eye are those that can be seen on the map, by all those connected to the group.

- Click on the editing symbol at the top right to access the editing menu.
- Click on the editing symbol for the object that is to change name: 

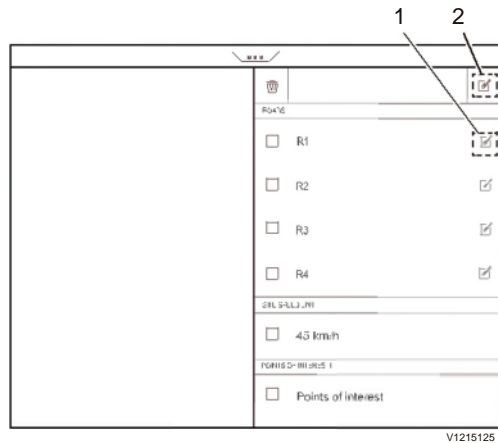

- 1 Road editing icon
- 2 Edit icon

- A window is shown where the name can be changed.
- Click OK to save.

Manage map view, delete road

To remove a road, gain access with the menu button at the bottom right in the map editor

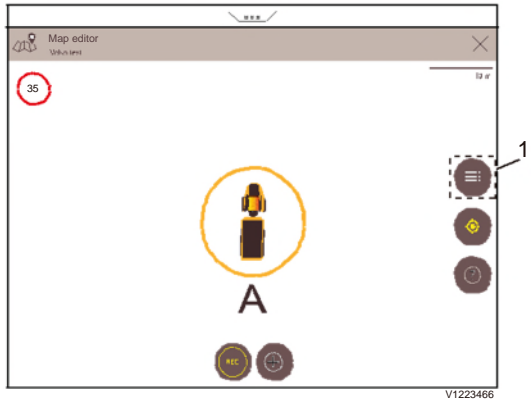

1 Menu

- By clicking on the menu, a window opens where everything that has been created for the map can be seen.

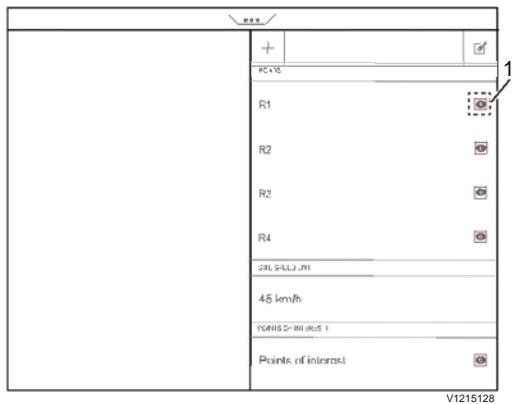

All created objects are listed. The ones shown with a yellow eye are those that can be seen on the map.

NOTE!

Keep in mind that all changes made can be seen in all machines/vehicles connected to the group as soon as they are saved.

- Click on the editing symbol, to the top right (3):

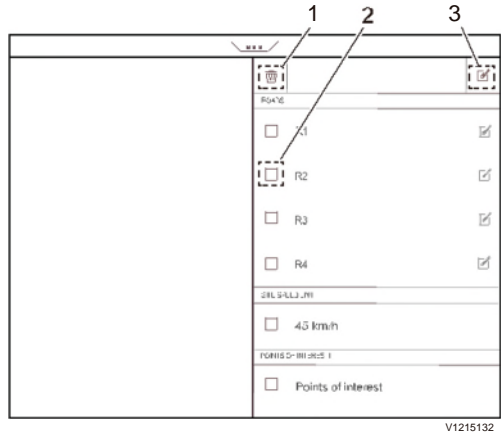
- Select the object to be deleted by clicking in the box. (2)
- Click on the trash can (recycle bin) to delete the object.



- 1 Trash can (recycle bin), symbol for deleting object
- 2 Check box for selection
- 3 Editing icon

Manage map view, record road

When a completely new road is created, begin by driving to the place where the road should start.

- Then click the record button (2) as shown in the figure below.
- Start to operate.

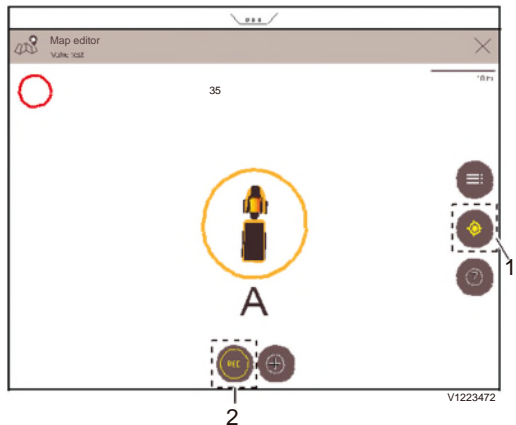

- 1 Centring active, see page 77
- 2 Record button



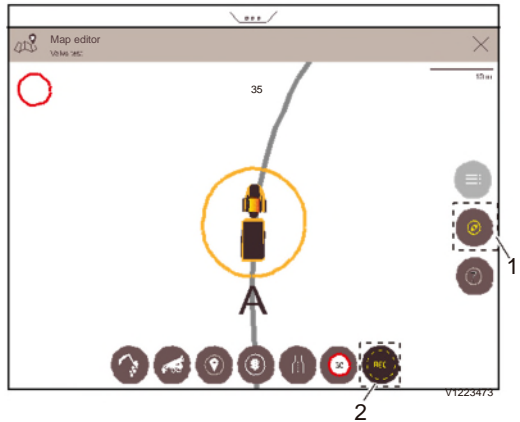







When recording starts, several other symbols will appear at the bottom.



- 1 Compass view. See page 77
 - 2 Symbol indicates that recording is in progress
- While recording, add that which is to be included for the road. For the different points that can be added, see the table below.
 - When the road is done, press the record button again to finish the recording.
 - Give the created object a name and save.

Legend to symbols in the image:

Symbol	Designation	Use
	Help mode	By clicking the symbol and then any of the other symbols, information will appear about the symbols' functions
	Dump zone	Clicking the symbol creates a Dump zone where the machine/vehicle is located. Also indicates where the site's Dump zone is located on the map. It is possible to have several on the map. See page 104
	Load Zone	Clicking the symbol creates a Load Zone where the machine/vehicle is located. Indicates where a Load Zone is located. It is possible to have several on the map. See page 100
	Gate, entrance or exit to a Load Zone or a Dump zone	After having clicked on the symbols for either Load Zone or Dump zone it is possible to choose if there should be gates or a radius for the area. For gates; while recording, stop at the location and click on the symbol to create either an entrance to or an exit from Load Zone or Dump zone. The first click becomes an entrance and the second click becomes an exit. Can be the same location. Used when Load Zone or Dump zone are large areas. The width of the gate is preset.

	Radius, circular Load Zone or Dump zone	After having clicked on the symbols for either Load Zone or Dump zone it is possible to choose if there should be gates or a radius for the area. In case of a smaller more limited Load Zone or Dump zone it is possible to create a circular point on the map. The radius of the area can be added. Can be used to add later and move around by dragging on the map. Can be positioned a distance from the road.
	Geozon Irregularly shaped zone	By clicking on the symbols for Load Zone, Dump zone or Restricted zone with irregular shape, and click on the location on the map where the zone should be. A box appears on the map. It is then possible to add several points and change the shape if necessary. See page 80
	Traffic signs	When you click on the symbol Traffic signs a menu with the available signs opens. See page: <i>Manage map view, add traffic sign</i>
	Points of interest	A menu opens with some preset Points of interest. Used to indicate points on the map to help with orientation. But also to indicate points that are important to the operator. See page 88
	Single-lane road	Shows where on the map it is impossible to meet other machines/vehicles.
	Speed limitation	There are two possible symbols. Can be set. See page 29 On the map the symbol indicates speed limits, as well as the speed which may not be exceeded. See also pages 90 and 93
	Record	Start recording a road section. Recording is started by pressing the symbol.
	Recording in progress	To turn off recording, press the symbol once again.
	Menu	Click this symbol to open the content in the map. Used to enable quick editing of the map's content.
	Centring, Camera view	The button is a multifunction button. In this position it is deactivated. See page 77

Manage map view, add points of interest

To enable easier navigation between the roads it is possible to add different Points of interest. By opening the menu for Points of interest you can easily add them to the map.

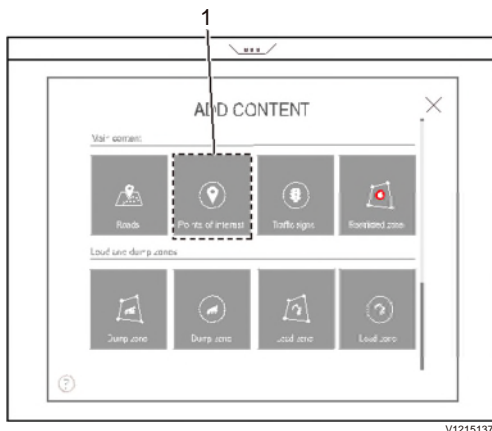

A new window opens with several different selections.

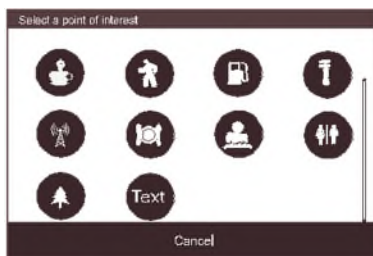
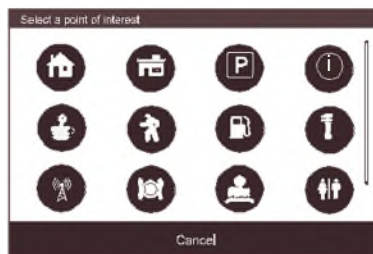

- Click on the type of Points of interest to be added.
- Click on the map where it is to be located.
- Name the place and save.

Manage map view, delete point of interest

The user can change the map view by logging into the map editor. See page *Site, login*.

- Click on the point of interest to be removed
- Click on the recycle bin
- Click on save then close the menu

Manage map view, add speed limit

To set a speed limit for the whole site, start in the same way as when creating the map. See page 79

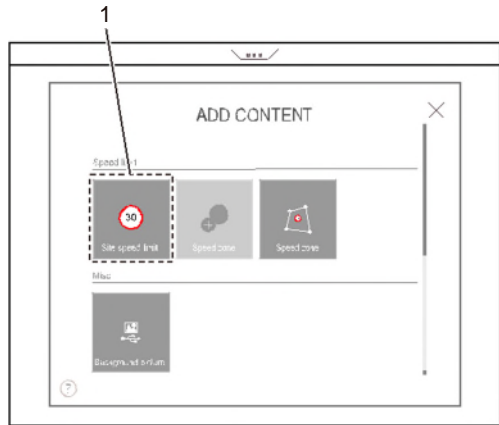

1 Site speed limit

- Select Site speed limit
- A window for setting speed limit opens.

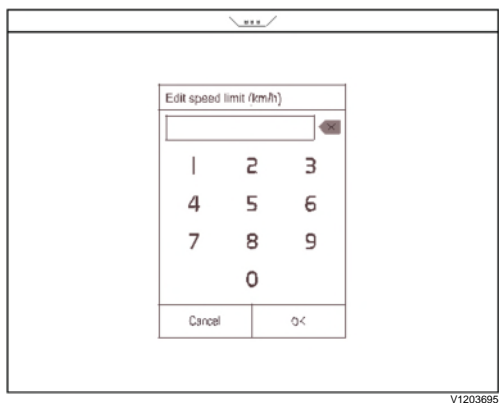

- Write the desired speed limit and click OK to save

Manage map view, modify speed limit

To change speed limit, enter using the menu button, down on the bottom right in the map editor.

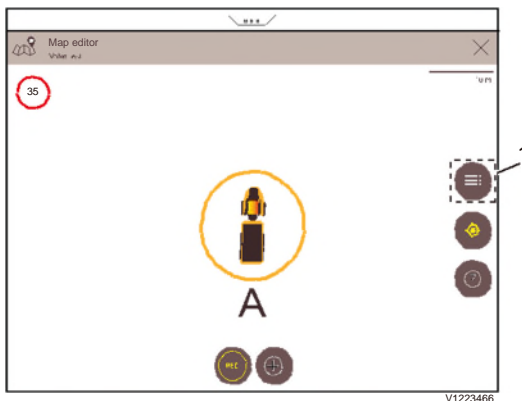

1 Menu

- By clicking on the menu, a window opens where everything that has been created for the map can be seen.

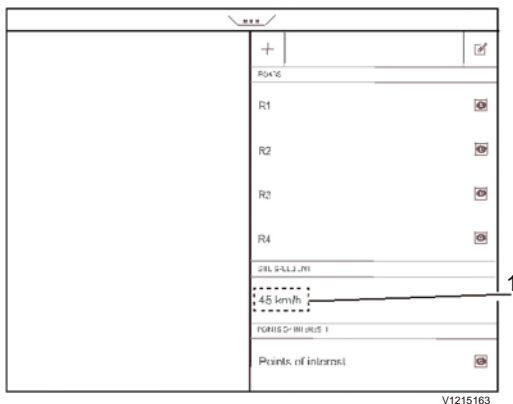

- To change speed limit for the site, click on existing speed.
- A window opens, where new speed can be written.

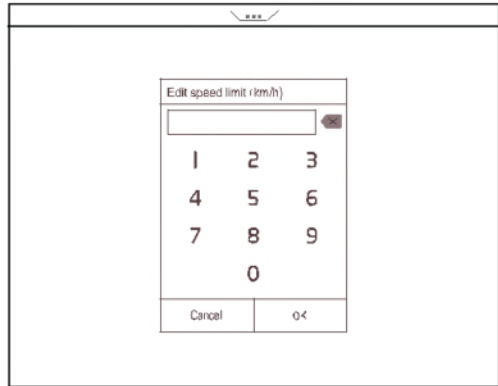

V1203695

- Click OK to save.

Manage map view, delete speed limit

To delete (remove) the speed limit for a site, enter using the menu button, down on the bottom right in the map editor

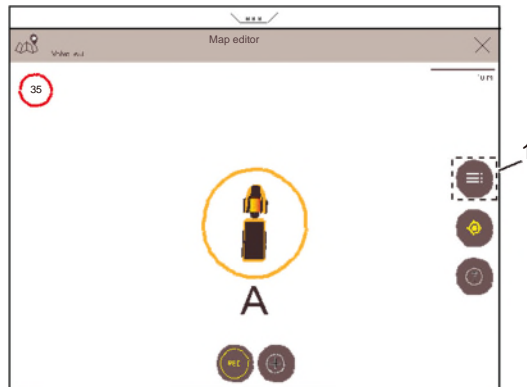

V1223466

1 Menu

- By clicking on the menu, a window opens where everything that has been created for the map can be seen.

The yellow eye markings indicate roads, etc., which can be seen on the map by all those connected to the machine group.

- Click on the edit symbol (2).

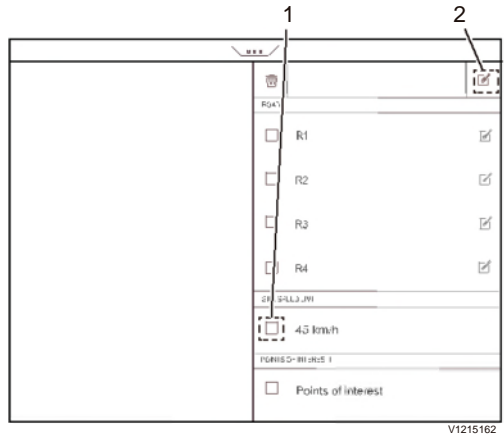

- 1 Box for selection
- 2 Editing symbol

NOTE!

Keep in mind that all changes made can be seen in all machines/vehicles connected to the group as soon as they are saved.

- Select speed (1).
- Click on the trash can (recycle bin) to delete the speed.

Manage map view, add speed zone

Certain road sections may need another speed than other parts. This can sometimes be added as the road is being recorded, or added afterwards.

NOTE!

The speed limit only applies in the direction in which the machine/vehicle was being driven when the road was recorded. If the speed limit is to apply in both directions, the road must be recorded in both directions.

Speed zone when recording road

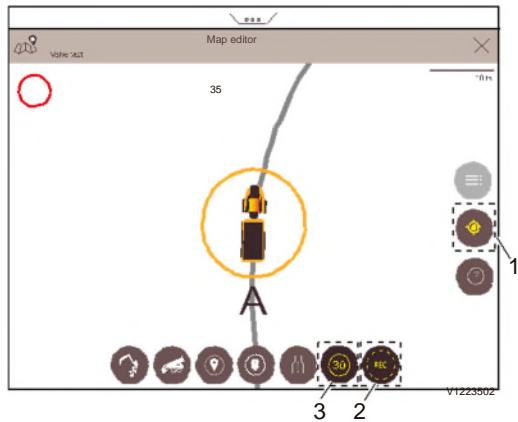

- 1 Centring active, see page 77
 - 2 Symbol indicates that recording is in progress.
 - 3 Symbol for recording Speed zone. Recording in progress.
- When the machine/vehicle reaches a point where a Speed zone is to start. Click on the symbol for start of the zone (3).
 - In the window that opens, write the desired speed.
 - Run the whole distance that the speed is to apply within.
 - Click again on the symbol for Speed zone, to set the end point.

Adding a Speed zone with an irregular shape

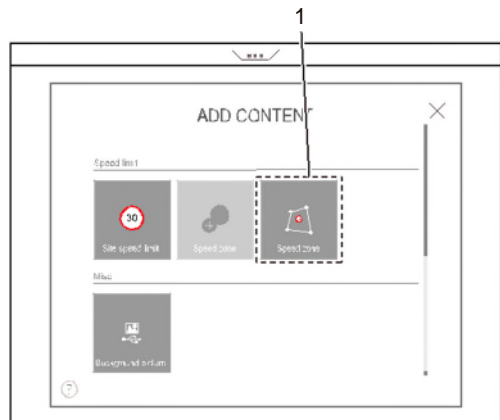

- 1 Button for Speed zone with an irregular shape.
- Click on the location in the zone where a Speed zone is to be positioned, then click on the symbol to start the zone.
 - A box appears on the map.
 - Drag and add more points to obtain the desired shape and size.
 - Enter the selected speed
 - Save the change.

Speed zone for making later entries

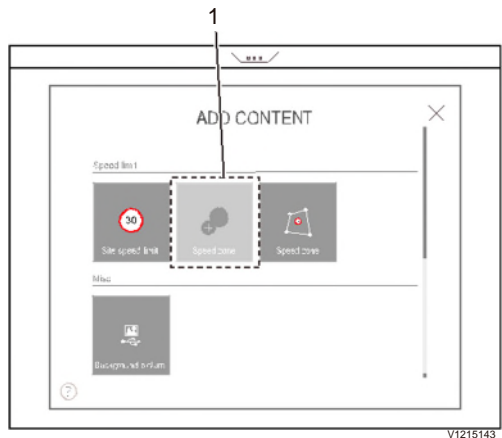

- 1 Button for Speed zone, connected to the recorded road.
- Click on the button for Speed zone.
 - Find the zone on the map that is to be given a Speed zone.
 - Click on a point on the recorded road to indicate the start of the zone.
 - Click on a new point in the recorded road, to indicate the end of the zone.
 - Write selected speed.
 - Save the change.

Manage map view, modify speed zone

NOTE!

Keep in mind that all changes made can be seen in all machines/vehicles connected to the group as soon as they are saved.

To change a Speed zone open the menu to edit the map in the middle at the bottom in the map editor.

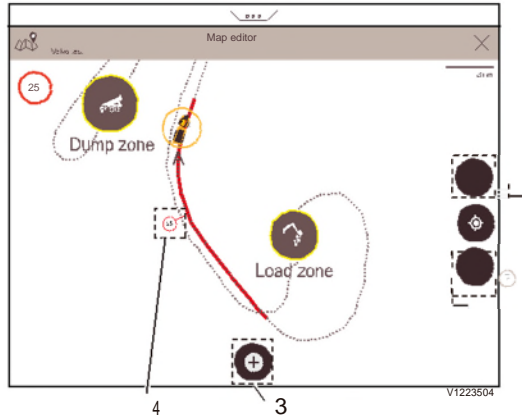

- 1 Menu button
- 2 Help mode
- 3 Open menu to edit the map
- 4 Added Speed zone.

- Find the zone on the map that is to be given a new speed.
- Click on the speed to be changed, position 4.

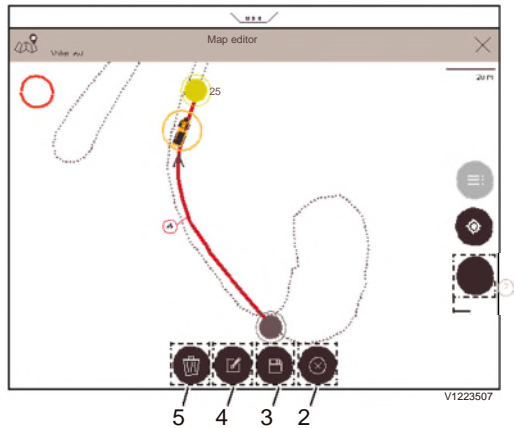

- 1 Help mode
- 2 Close the menu
- 3 Save
- 4 Edit
- 5 Remove

- Click on the edit icon (4).

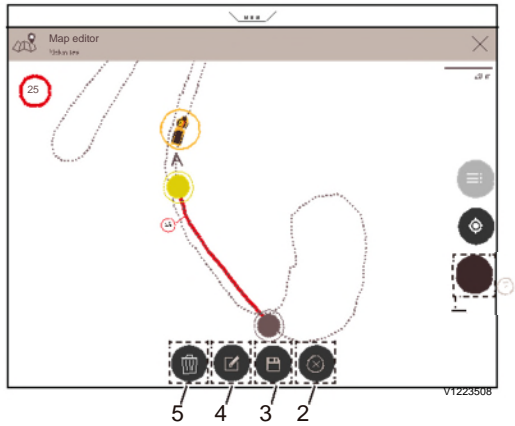

- 1 Help mode
- 2 Close the menu
- 3 Save
- 4 Edit
- 5 Remove

- Click on a new point to shorten or extend the road section with the speed limit.
- Click on save (3) then on the icon to close the editor (2).

Changing a speed zone with an irregular shape

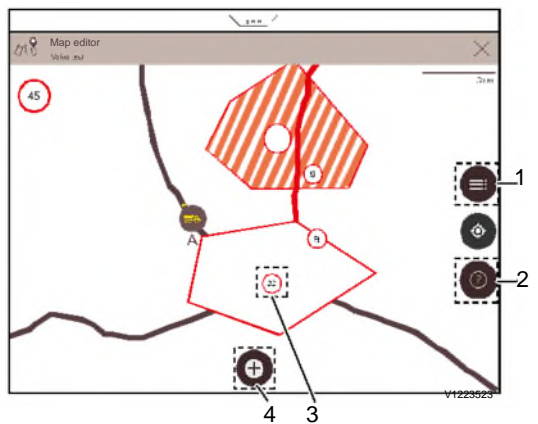

- 1 Menu button
- 2 Help mode
- 3 Added Speed zone.
- 4 Open menu to edit the map

- Find the zone on the map that is to be given a new speed.
- Click on the speed that is to be changed, position 3.

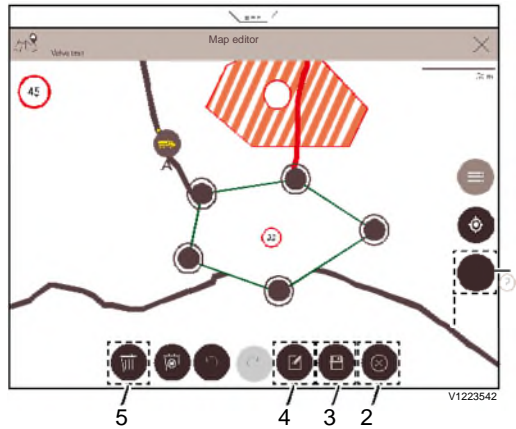

- 1 Help mode
- 2 Close the menu
- 3 Save
- 4 Edit
- 5 Remove

- Click on the edit icon (4).
- Enter the new speed.
- Click on save (3) then on the icon to close the editor (2).

Manage map view, delete speed zone

NOTE!

Keep in mind that all changes made can be seen in all machines connected to the group as soon as the change is saved.

To delete (remove) a Speed zone open the menu to edit the map in the middle at the bottom in the map editor.

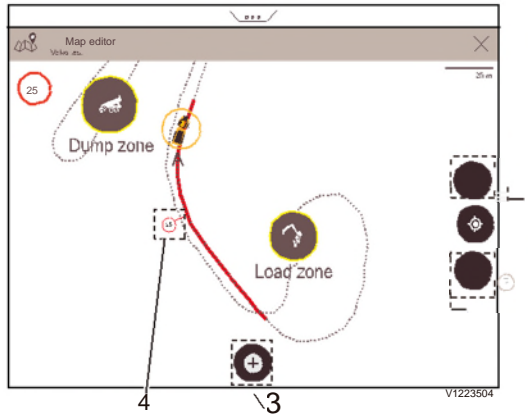

- 1 Menu button
- 2 Help mode
- 3 Open menu to edit the map
- 4 Added Speed zone

- Click on the edit symbol. 

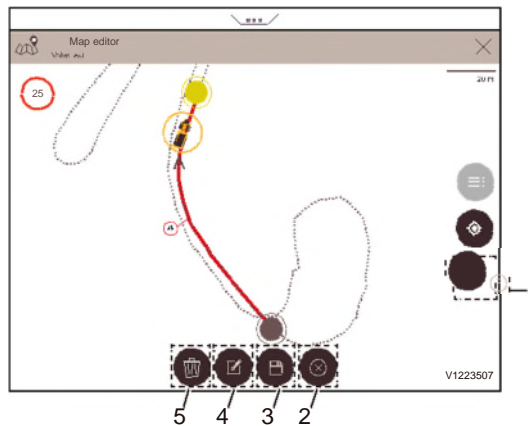

- 1 Help mode
 - 2 Close the menu
 - 3 Save
 - 4 Edit
 - 5 Remove
- Click on the speed that is to be deleted.
 - Click on the trash can (recycle bin).
 - Click on save and then on 'x' to close the editor for speed.

Manage map view, add traffic sign

Traffic signs can be added to the map, to facilitate a good traffic situation at the site and its roads. You can add them on the map by opening the traffic sign menu.

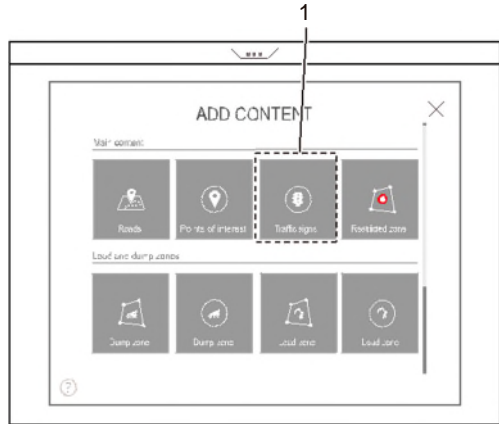

A new window opens with several different selections.

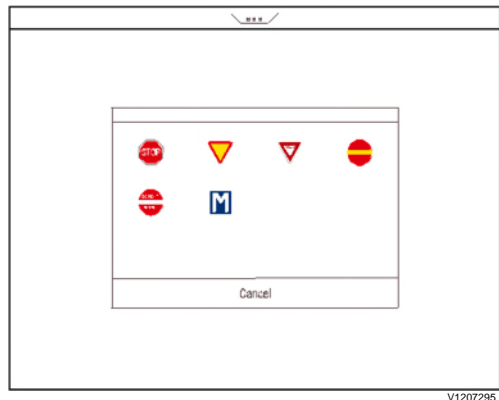

- Click the type of sign to add.
- Click on the map where the sign is to be located.

Manage map view, add load zone

A circular Load Zone or a Load Zone with gates can only be added during recording. Load Zone with an irregular shape can be added later.

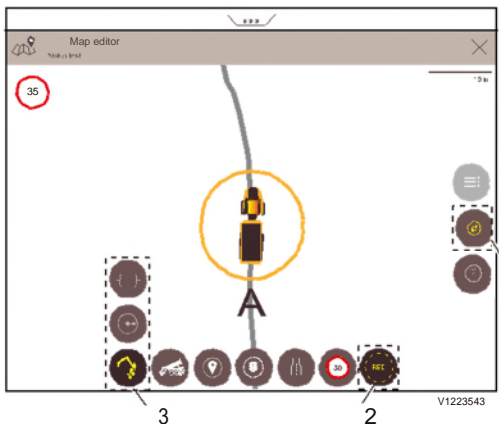

- 1 Compass view. See page 77
- 2 Symbol indicates that recording is in progress.
- 3 Load Zone is created and therefore the submenu with symbols has been opened.
 - Stop, during recording of the map, where a Load Zone is located.
 - By clicking on the symbol for Load Zone two new symbols (3) can be seen
 - Select to create a Load Zone that should be circular or one that is to have gates. A circular is recommended for smaller areas and gates for larger areas.

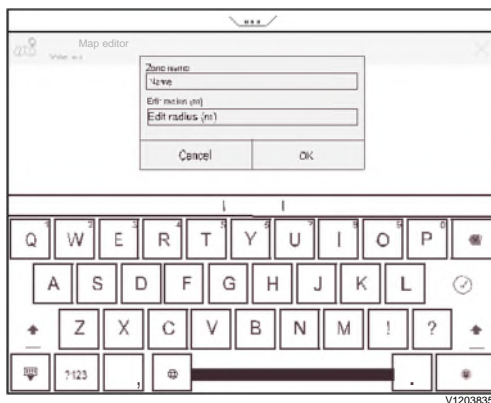

- A zone with radius has been selected in the figure above.
- Give the created Load Zone a name
 - Select which radius the created Load Zone is to have.

- Save by clicking OK.
- A Load Zone is created on the map. Create more if there are several.
- Gates are added in a similar way, but one at the entrance to the Load Zone that was created, and one at the exit. These may be located in the same place, but must be done when entering and exiting the load zone. The gates have a fixed width.

Add Load Zone with an irregular shape

To add an irregularly shaped zone, proceed as follows.

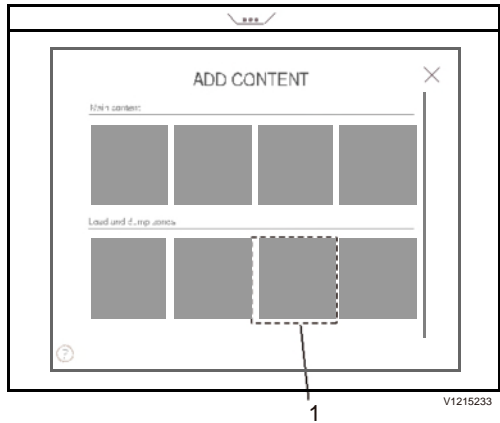

- 1 Button for Load Zone with an irregular shape
- Click on the location on the map where a Load Zone is to be added, then click on the symbol (1).
 - A box is added to the map in the machine location.
 - Drag and add more points to obtain the desired shape and size.
 - Enter a name for the zone.
 - Save the change.

Manage map view, delete load zone

NOTE!

Keep in mind that all changes made can be seen in all machines/vehicles connected to the group as soon as they are saved.

To delete (remove) a Load Zone open the menu to edit the map in the middle at the bottom in the map editor.

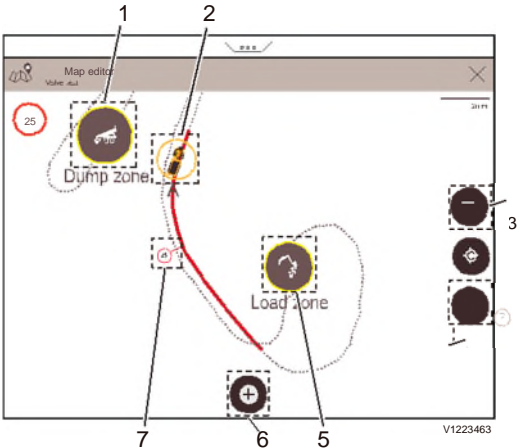

- 1 Dump zone
- 2 Machine/vehicle position
- 3 Menu
- 4 Help mode
- 5 Load Zone
- 6 Open menu to edit the map
- 7 Added Speed zone

- Click on the edit symbol: 

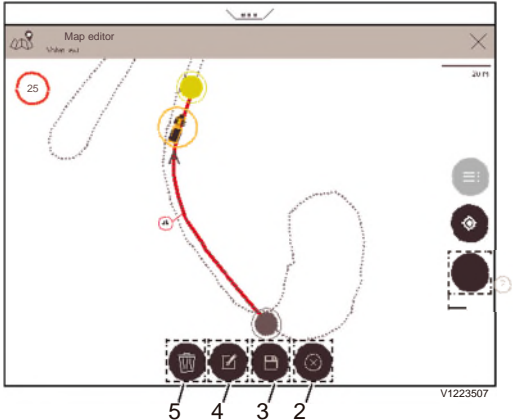

- 1 Help mode
- 2 Close the menu
- 3 Save
- 4 Edit
- 5 Remove

- Locate the Load Zone on the map that is to be deleted.

- Click on the Load zone and then on the trash can (recycle bin).
- Click on save and then on 'x' to close the editor.

Manage map view, add dump zone

A circular Dump zone or a Dump zone with gates can only be added during recording. Dump zone with an irregular shape can be added later.

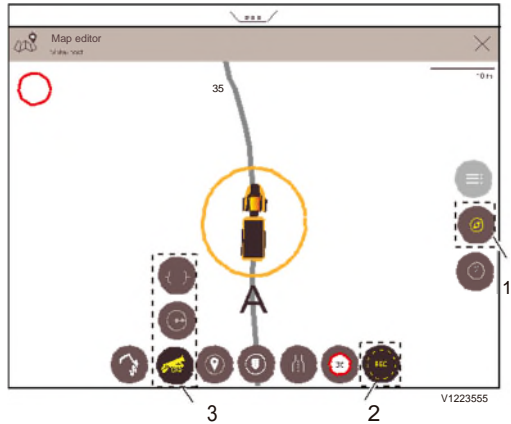

- 1 Compass view. See page 77
- 2 Symbol indicates that recording is in progress.
- 3 Dump zone is created and therefore the submenu with symbols has been opened.
 - Stop, during recording of the map, where a Dump zone is located.
 - By clicking on the symbol for Dump zone two new symbols (3) can be seen
 - Select to create a Dump zone that should be circular or one that is to have gates. A circular is recommended for smaller areas and gates for larger areas.

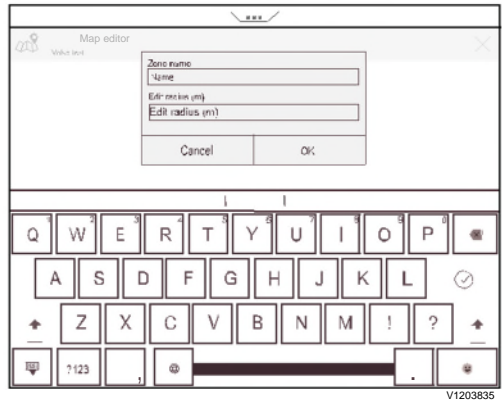

A zone with radius has been selected in the figure above.

- Give the created Dump zone a name.
- Select which radius the created Dump zone is to have.
- Save by clicking OK.
- A Dump zone is created on the map. Create more if there are several.
- Gates are added in a similar way, but one at the entrance to the Dump zone that was created, and one at the exit. These may be located in the same place, but must be done when entering and exiting the dump zone. The gates have a fixed width.

Adding a Dump zone with an irregular shape

The third type of zone has an irregular shape. To add this type of zone, proceed as follows.



- 1 Button for Dump zone with an irregular shape.
- Click on the location on the map where a Dump zone is to be added, then click on the symbol (1).
- A box is added to the map in the machine location.
- Drag and add more points to obtain the desired shape and size.
- Enter a name for the zone.
- Save the change.

Manage map view, delete dump zone

NOTE!

Keep in mind that all changes made can be seen in all machines/vehicles connected to the group as soon as they are saved.

To change or delete (remove) Dump zone enter using the menu button, down on the bottom right in the map editor.

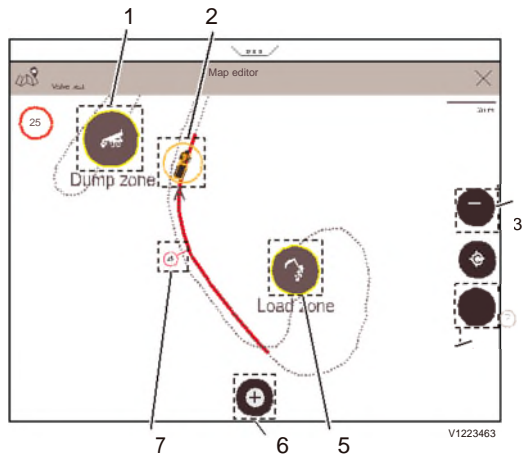

- 1 Dump zone
- 2 Machine/vehicle position
- 3 Menu
- 4 Help mode
- 5 Load Zone
- 6 Open menu to edit the map
- 7 Added Speed zone

- Click on the edit symbol: 

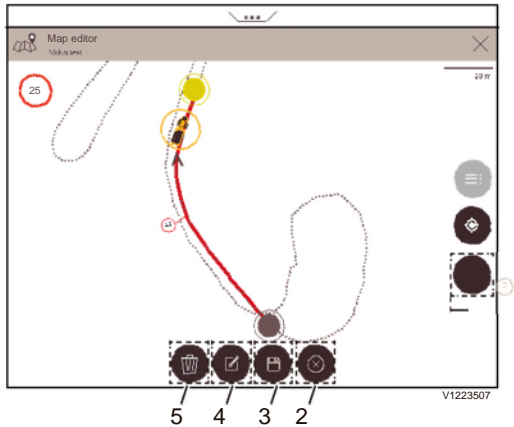

- 1 Help mode
- 2 Close the menu
- 3 Save
- 4 Edit
- 5 Remove

- Locate the Dump zone on the map that is to be deleted.
- Click on Dump zone and then on the trash can (recycle bin).
- Click on save and then on 'x' to close the editor.

Manage map view, add restriction zone

A site may require the addition of a Restricted zone where traffic is prohibited. This type of zone can only have an irregular shape.

A Restricted zone is created when a road is recorded and content is added.

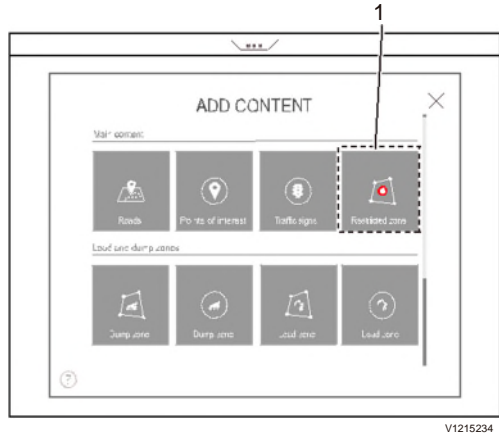

V1215234

1 Button for Restricted zone

- Click on the location on the map where a Restricted zone is to be added, then click on the symbol (1).
- A box is added to the map in the machine location.
- Drag and add more points to obtain the desired shape and size.
- Enter a name for the zone.
- Save the change.

Manage map view, modify restriction zone

NOTE!

Keep in mind that all changes made can be seen in all machines/vehicles connected to the group as soon as the change is saved.

A Restricted zone is changed in the same way as other zones with irregular shapes. Open the menu to edit the map in the middle at the bottom in the map editor.

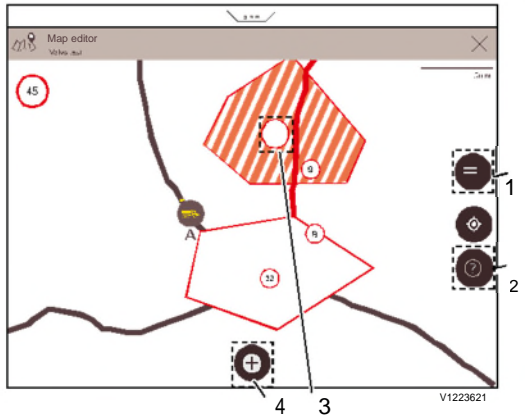

- 1 Menu button
- 2 Help mode
- 3 Restricted zone
- 4 Open menu to edit the map

- Find the zone on the map that is to be changed
- Click in the zone

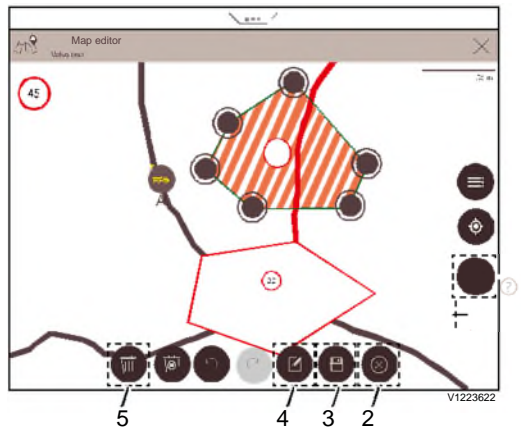

- 1 Help mode
- 2 Close the menu
- 3 Save
- 4 Edit
- 5 Remove

- Click on the edit icon (4).
- Change the size/shape, for example.
- Click on save (3) then on the icon to close the editor (2).

Manage map view, delete restriction zone

NOTE!

Keep in mind that all changes made can be seen in all machines/vehicles connected to the group as soon as the change is saved.

To delete (remove) a Restricted zone, open the menu to edit the map in the middle at the bottom in the map editor.

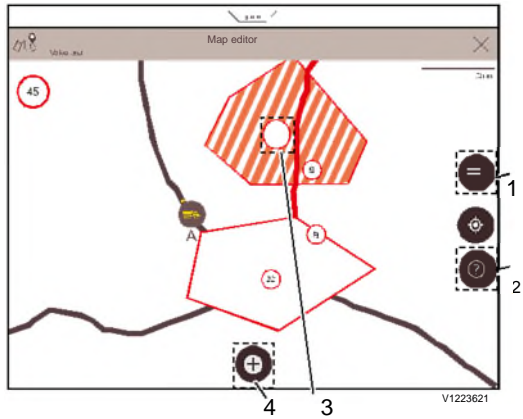

- 1 Menu
 - 2 Help mode
 - 3 Restricted zone
 - 4 Open menu to edit the map
- Find the zone on the map that is to be removed.
 - Click on the zone.

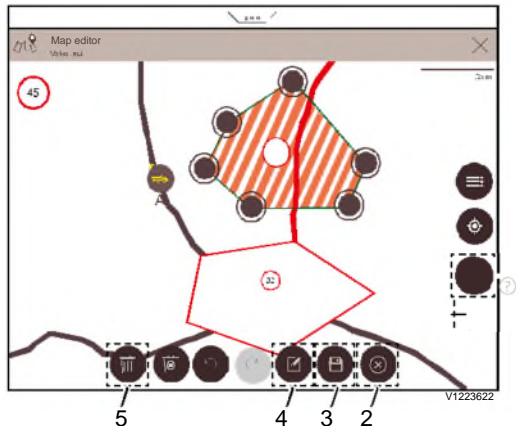

- 1 Help mode
 - 2 Close the menu
 - 3 Save
 - 4 Edit
 - 5 Remove
- Click on Remove (5).
 - Click on save (3) then on the icon to close the editor (2).

Manage map view, add background picture

NOTE!

This feature is available on some markets.

To enable easier recognition of the site, it is possible to add a satellite or drone image under the map.

NOTE!

The image must be added in each machine/vehicle.

This differs from the maps, which are transferred automatically to all machines/vehicles in the group. Here the background image must be loaded manually in all machines/vehicles in the group. The background image can be prepared in a machine/vehicle and fitted to the map, its roads and positions. It is then saved and transferred to the other machines/vehicles.

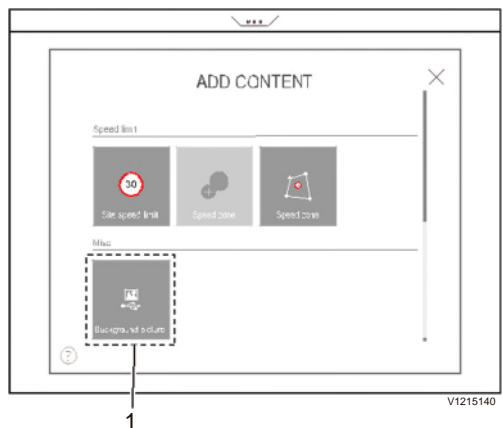

- 1 Button to add image

The image may be in JPG or PNG format, and have maximum size of 15 MB.

- Insert a USB stick with the image in the USB port of Volvo Co-Pilot, on the panel.

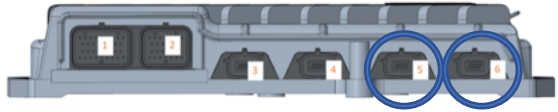

- Click on the button to add image (1)
- A window opens with the content of the USB-memory

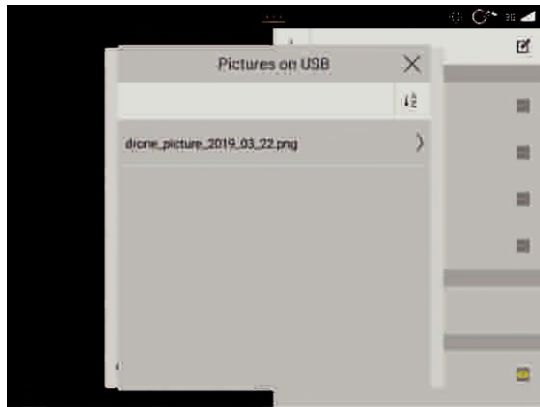

V1205791

- Click on the image name of the image that is to be added.

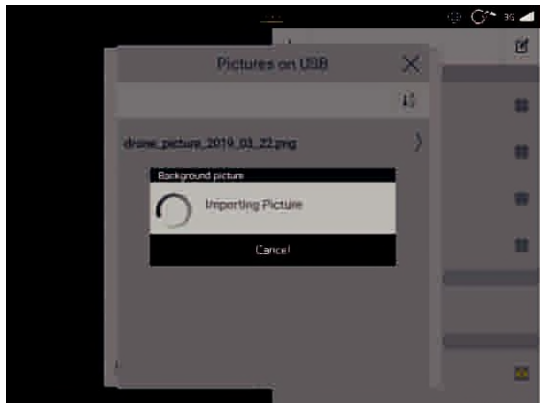

V1203792

- The image is imported

If there is an older image that is to be replaced, this message may open.

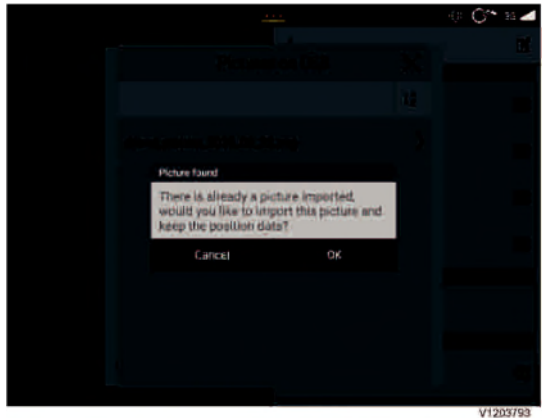

The image is uploaded on the screen.

- For the first machine/vehicle, the background image can be edited when the image is added.
- If this is the second machine or additional machines: Save the image on the machine.











Edit image



- By dragging and turning the image it is possible to fit it to the recorded roads/routes and other added positions.
- Adjust the image's brightness and transparency to obtain a good resolution, so that added roads and positions are clearly visible.
- Save after each change.

- Save the image both on the machine and USB-memory.
- If the image is to be transferred to other machines, download it to a USB-memory.
- Close the menu by clicking 'x'.

Legend to symbols in the image

Symbol	Designation	Use
	Help mode	By clicking the symbol and then any of the other symbols, information will appear about the symbols' functions.
	Undo change	Undo last change
	Transparency	Adjust transparency of the image
	Brightness	Adjust brightness of the image.
	Lock image	Lock image position in the map
	Save	Save image position.
	Download	The symbol is in the same place as Save. Download the image position to USB-memory.
	Menu	Click this symbol to open the content in the map. Used to enable quick editing of the map's content.
	Centring, Camera view	The button is a multifunction button. In this position it is deactivated. See page 77
	Close	Closes the menu.

Manage map view, enabling/disabling item

It is possible to create more roads than those that are active on the map. The various roads can be alternatives to be used with different road conditions. Alternative road selection in case a road is blocked. A change affects all machines/vehicles connected to the machine group, making it possible to activate/deactivate different roads as needed.

To activate/deactivate an object, for example, roads:

- Enter via Settings, Site, see page 12 and page 12

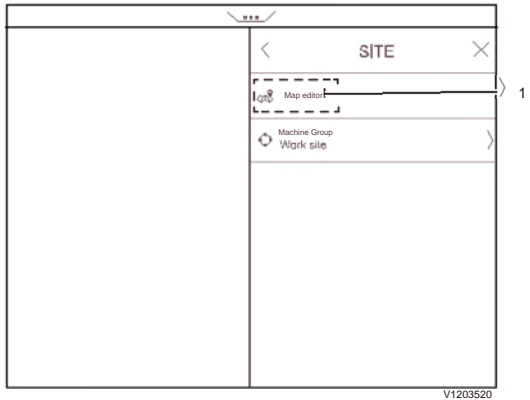

- Click on Map editor (1)
- The page is protected by login. See page 12
- A window opens with everything that was created for the map.

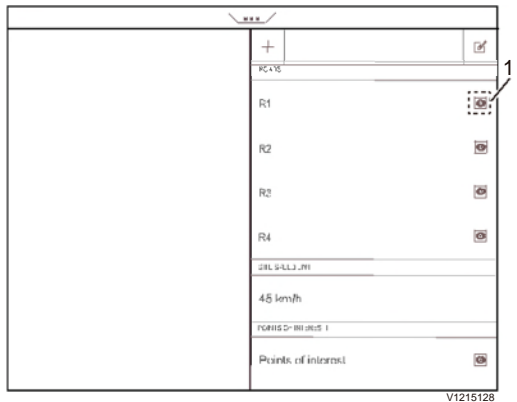

1 Yellow eye indicates selected object

All created objects are listed. The ones shown with a yellow eye in the image are all selected and can be seen on the map by all those connected to the group.

NOTE!

Keep in mind that all changes made can be seen in all machines/vehicles connected to the group as soon as they are saved.

To activate or deactivate any object in the list:

- Click on the box after the name of the object (1).
- If anything is to be activated, click in the grey box (1) so that a yellow eye can be seen.

- If anything is to be deactivated, click the yellow eye to remove it.
- Exit the menu by clicking to the left of the menu or dragging the menu to the right with your finger. Then the map becomes visible.
- The change becomes active for all machines.

Rear vision system

(Optional equipment)

The back-up camera is activated automatically when reverse gear is engaged. It is also possible to choose to have the back-up camera on the screen without reverse gear being engaged.

As an option there is also a radar detection system that detects an area behind the machine if reverse gear is engaged. If there is a risk of reversing in to something, the system warns for that which is detected within the alarm area. The detection area is shown in the back-up camera view.

NOTE!

The rear camera view is always shown when reverse gear is selected.

- Tap on the icon for a constant camera view.
- Tap on the icon again to exit.

The back-up camera can be shown on full screen or half screen, which means that the screen can be split and shared with another function. The selection is made in the function's View selector. See page 118.

See the machine Operator's Manual for information about cameras, visibility and visibility aids.



M1216197

View selector



V1215817



V1215875

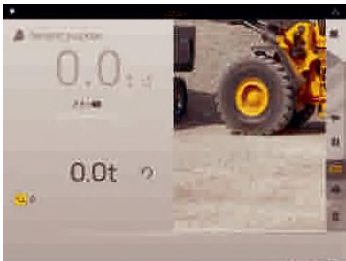

V1195168

Use the symbol View selector to choose between different views:

- Full screen view for a function
- Two views side-by-side vertically with two selected functions

NOTE!

The available functions in the view selector is dependent on installed equipment.

If the rear vision system is installed, it can be activated by selecting Rear camera. This will display the picture on 50% of the screen when neutral or forward gear is activated. Use the view selector to enable half screen reverse camera (with a aspect ratio which is not 4:3).

See the machine Operator's Manual for information about cameras, visibility and visibility aids.

Messages

Error messages

Fault detected Please contact Volvo service technician	Internal error Load Assist not available, please contact Volvo Service Technician
Configuration error Load Assist not available, please contact Volvo Service Technician	Sensor configuration error Load Assist not available, please contact Volvo Service Technician
Machine angle error Load Assist not available, please check sensors and wiring	Boom angle error Load Assist not available, please check sensors and wiring
Attachment angle error Load Assist not available, please check sensors and wiring	Arm angle error Load Assist not available, please check sensors and wiring
Attachment angle error Load Assist not available, please check sensors and wiring	Lift cylinder pressure error Load Assist not available, please check positive pressure sensor and wiring
Lift cylinder pressure error Load Assist not available, please check negative pressure sensor and wiring	

Information messages

Calibration Failed	No attachment chosen Please add attachment
Memory usage high Consider deleting old user data	Memory full Please delete old user data
Attachment calibration required Please start calibration	Boom raised too fast Please redo calibration at a slower rate
Boom movement stopped Calibration movement interrupted, please redo calibration with a continuous movement	Movement too rough Calibration too rough, please redo calibration with a smooth continuous movement
Printer Connection Error Please check that the printer is connected and powered up	Printer out of paper Please replace printer paper
Printer soon out of paper Please replace printer paper	Printer Error Please consult printer user manual for assistance
X t removed Press to undo	Partial unload X t Press to add

120 Messages

File upload error Communication missing, please check your internet connection	Service not enabled, please contact your Volvo dealer
Service not available, please contact Volvo Service Technician	

Maintenance

Regular greasing is important to maintain a low friction in the lift arm system. To secure a good accuracy, follow the greasing intervals in the machine Operator's Manual. Central lubrication system is recommended.

Beside regular maintenance stated in Operator's manual, following items are also needed:

- 1 Clean attachment to get good accuracy during calibration.
- 2 Re-calibration after service and/or cleaning. See page 49.
- 3 Re-calibration after any airbleeding of hydraulic system. See page 49.

TPMS

Information

(Optional equipment)

Tire pressure monitoring system (TPMS) is intended to be used as an information system to facilitate the user's tasks. This appendix does not release the operator from following the instructions and cautionary measures described in the ordinary operator's manual to the machine.

System information

The tire pressure monitoring system consists of a receiver mounted on the outside of the cab and sensors mounted on the tire air valves. The receiver is connected to the load assist wired sensor network to transfer the wireless signals from the pressure sensors.

The sensors are powered by an internal battery, which limits the lifetime of the sensor. Depending on the ambient conditions the lifetime can vary between 1-5 year. This means that the sensors will need to be replaced after some time.

Main screen

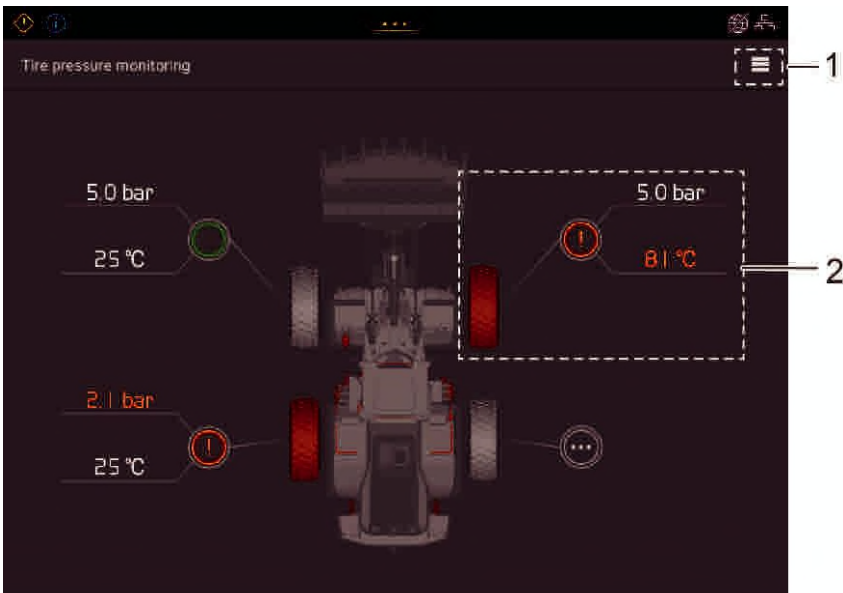

V1215641

- 1 Settings for the application, see 124
- 2 Tire status

Tire status

Current tire pressure and temperature are shown. If the temperature or pressure should go outside the warning levels, a warning symbol will light up for the current tire and the deviating value will light up in red.



V1216086



V1215810

If you tap on a tire symbol an additional menu will be shown for that tire.

Settings

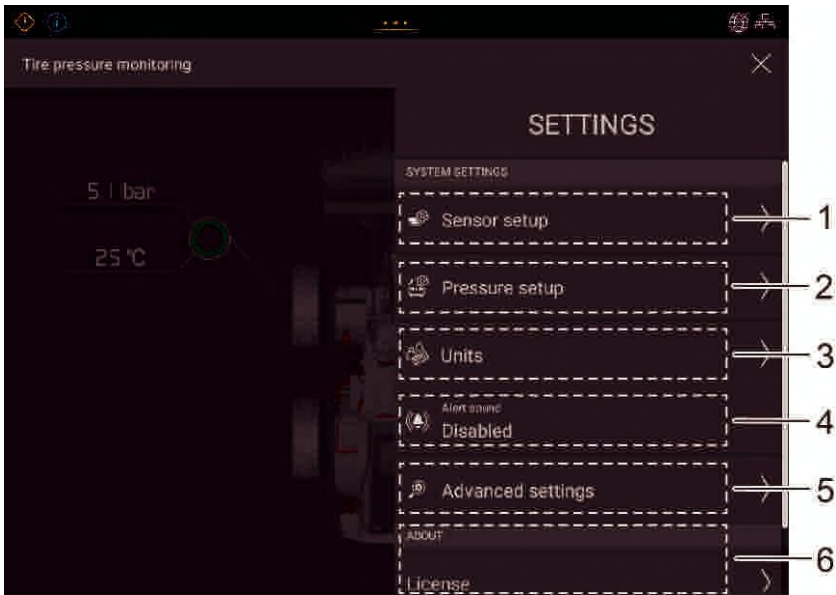

V1215642

- 1 Menu for connect sensor ID to tire position, see 124
- 2 Menu for setting the recommended tire pressure, see 125
- 3 Units, Here can you change pressure and temperature units.
- 4 Enables or disable sound alerts for warnings.
- 5 Advanced settings
- 6 Information about software license and application version.

Sensor setup

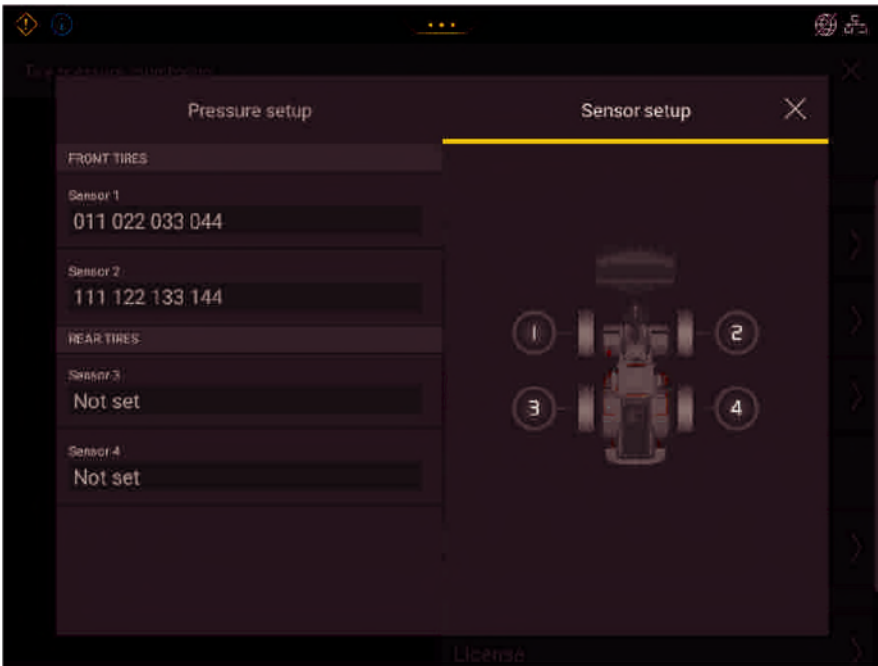

V1215643



V1215811

In order for the system to work, the sensors must be connected to the correct position in the system. This is done by programming the 12 digit number printed on the sensor at the position where it is then mounted.

If you get an error on a sensor, you can temporarily switch off that position in the system by erasing all 12 digits in the input field.

NOTE!

In order to ensure that the values are saved correctly, a correct key switch off is required after completion of setup.

Pressure setup

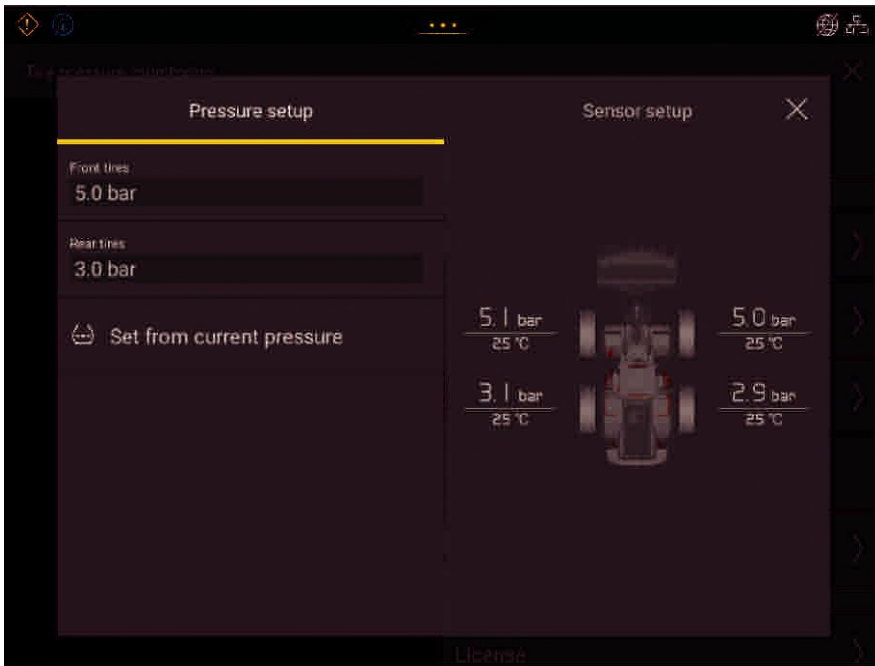

V1215644

The tire pressure target value for the front or rear axle should be set according to the machine operators manual or according to the tire manufacturer's recommendations.

The target value can be set in two ways:

- A You set the value according to the actual value the tire pressure sensors have read for the current axle.
- B The target value is set by entering value manually for each axle.

Advanced settings

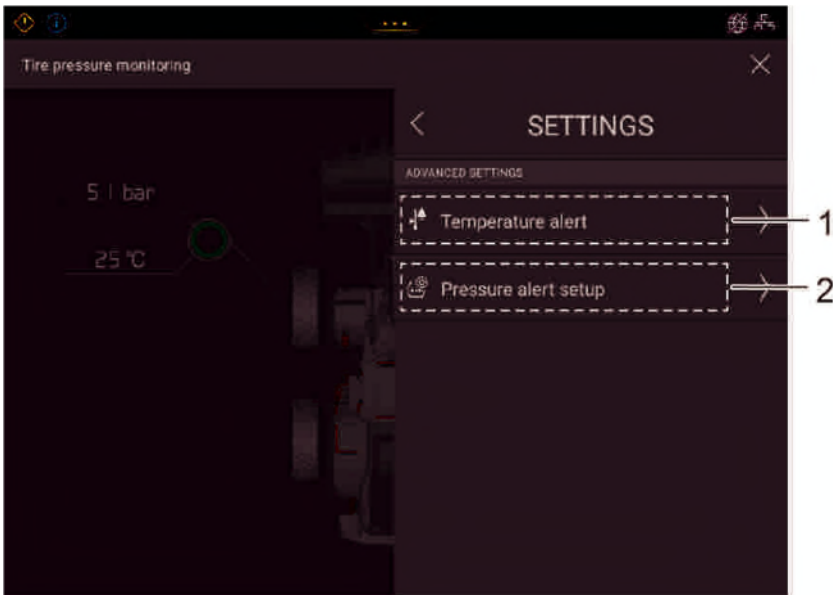

V1215647

- 1 Temperature alert
- 2 Pressure alert setup

Temperature alert

Tire temperature warning is set with two different levels first and second high temperature warning.

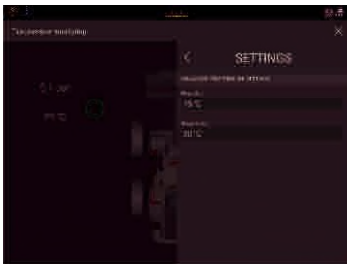

V1215648

Pressure alert setup

Tire pressure warnings shall be set for high or low tire pressure. These are defined according to a percentage of the target value for the tire pressure. There are two warning levels first and second to be set for both high and low pressure.



V1215649

Alphabetical index

A

Adjusting to reference weight.....57
 Advanced settings127
 Application27
 Application, advanced.....30
 Application, speed limit sign.....29
 Application, units.....29
 Attachment.....43
 Attachment angle.....44
 Attachment, calibrating49
 Auto cloud upload28

B

Boom angle.....45
 Bucket load adjustment.....44

C

Calibrate with known weight54
 Calibrate with zero weight.....51
 Current load42
 Customer15

D

Delete last load65

F

Forced partial unloading46
 Forced unload.....46

I

Import / export.....23
 Information.....122

K

Known weight calibrated buckets.....44

L

Load summary25
 Load weighing.....38
 Loading.....40
 Locked/unlocked load43

M

Machine27
 Machine Group71
 Machine Group, Add Machine73
 Machine group, Create Invite code74
 Machine Group, Create Machine Group. 72
 Machine Group, Remove Machine76
 Machine inclination, longitudinal ("pitch")45
 Machine inclination, transversal ("roll") ..45
 Main screen8, 123
 Maintenance121
 Manage map view.....78
 Manage map view, add background picture.....111
 Manage map view, add content.....80

Manage map view, add dump zone 104
 Manage map view, add load zone 100
 Manage map view, add points of interest88
 Manage map view, add restriction zone107
 Manage map view, add roads..... 82
 Manage map view, add speed limit..... 90
 Manage map view, add speed zone 93
 Manage map view, add traffic sign 100
 Manage map view, create map 79
 Manage map view, delete dump zone.. 106
 Manage map view, delete load zone ... 102
 Manage map view, delete point of interest..... 89
 Manage map view, delete restriction zone 110
 Manage map view, delete road.....84
 Manage map view, delete speed limit.... 92
 Manage map view, delete speed zone ..98
 Manage map view, enabling/
 disabling item..... 114
 Manage map view, modify restriction zone 108
 Manage map view, modify road82
 Manage map view, modify speed limit...91
 Manage map view, modify speed zone..95
 Manage map view, record road 86
 Map.....69
 Map view.....77
 Map, use69
 Material21
 Messages119

P

Partial unloading47
 Pause view65
 Pile.....19, 63
 Pressure setup.....126
 Print receipt.....66
 Printer37
 Process.....20, 64
 Project.....13

Q

Quick tips10

R

Rear vision system117
 Reverse before locking load59
 Running-in instructions5

S

Screen views6
 Sensor setup.....125
 Set attachment angle.....54
 Settings.....12, 124
 Simple mode.....33
 Site12

Site, login.....	12
I.....	
Task mode	61
Trip.....	61
Truck.....	16, 62
Truck with multiple compartments.....	16
U.....	
Upload to cloud	23
USB Export.....	21
V.....	
View selector	118
W.....	
Weighing accuracy	38
Work order.....	14
Work results.....	25