



Cadi Scientific Pte Ltd

SMB-800 SmartBridge Instructions For Use

Document No.:

Established Date: 28 October 2009

Revision: B

Cadi Scientific Pte Ltd					
Document:				Document No.:	
Dept. of preparation:		Revision:		Issue Date:	

Notices

Copyright © 2010 Cadi Scientific Pte Ltd.

No part of this manual may be reproduced in any form or by any means (including electronic storage and retrieval or translation into a foreign language) without prior agreement and written consent from Cadi Scientific Pte Ltd as governed by international copyright laws.

Regulatory Information

For customer in the U.S.A and Canada

The SMB-800 SmartBRIDGE (FCC ID: VPE-SMB800) has been tested and found to comply with the limits for a Class B digital device, pursuant to part 15 of the FCC rules. These limits are designed to provide reasonable protection against harmful interference in a residential installation. This equipment generates, uses and can radiate radio frequency energy and, if not installed and used in accordance with the instructions, may cause harmful interference to radio communications. However, there is no guarantee that interference will not occur in a particular installation. If this equipment does cause harmful interference to radio or television reception, which can be determined by turning the equipment off and on, the user is encouraged to try to correct the interference by one or more of the following measures:

- Reorient or relocate the receiving antenna.
- Increase the separation between the equipment and receiver.
- Connect the equipment into an outlet on a circuit different from that to which the receiver is connected.
- Consult the dealer or an experienced radio/TV technician for help.

Operation is subject to the following two conditions:

- (1) This device may not cause harmful interference, and
- (2) This device must accept any interference received, including interference that may cause undesired operation.

This equipment complies with FCC radiation exposure limits set forth for an uncontrolled environment. End users must follow the specific operating instructions for satisfying RF exposure compliance. This transmitter must not be co-located or operating in conjunction with any other antenna or transmitter.

The lithium battery inside this product contains Perchlorate. The following statement is required by the State of California, USA:

Perchlorate Material – special handling may apply.

Changes or modifications not expressly approved by the manufacturer could void the user's authority to operate the equipment.

For customer in Europe

This equipment has been tested and found to comply with the limits set out in the R&TTE Directive.

Cadi Scientific Pte Ltd						
Document:	Quality Objectives and Quality Planning Control Procedures			Document No.:	MDDQP-001-A2	
Dept. of preparation:	Management Representative	Revision:	B01	Issue Date:	28 Oct 2009	Page 4 of 29 Annex II



Where you see this symbol on any of our electrical products/packaging in Europe, it means that at end of life the product/battery must be disposed of in accordance with any applicable laws or requirements for the separate disposal of electrical equipment/batteries.

Cadi Scientific Pte Ltd						
Document:	Quality Objectives and Quality Planning Control Procedures			Document No.:	MDDQP-001-A2	
Dept. of preparation:	Management Representative	Revision:	B01	Issue Date:	28 Oct 2009	Page 5 of 29 Annex II

Product Information

- Product model: CADI SMB-800
- Product name: SmartBridge
- Manufacturing site: 31 Ubi Road 1, #03-00 Aztech Building, Singapore 408694

Version Information

- This version is subject to change or upgrade without notice
- Version: A01
- Issue date: xxxxxxxx

Declaration

Cadi Scientific Pte Ltd reserves the right to change the product described in this Operating Manual. All information contained in this Operating Manual is subject to change without prior notice.

Manufacturer's Responsibility

Cadi Scientific is responsible for the safety, reliability and performance of the device under the following conditions:

Assembling, upgrading, resetting and repairing are performed by Cadi's authorized personnel.

Operating this device following this manual.

Product serial number and labels are intact to verify the product identity as manufactured by Cadi Scientific Pte Ltd.

Product storing environment, operating environment and electrical environment are as described in this manual.

Damages not by misuse of accidental dropping.

Free services apply to products with applicable items within warranty period. For products beyond the description of warranty conditions, service charge applies. Customers are required to pay for any transportation and applicable customs fees of returned goods to Cadi Scientific.

Return Procedures

If return is necessary, take the following steps:

1. Obtain return goods authorization from Cadi Scientific Customer Service Department. Inform Cadi Scientific of the serial number and mark this serial number on the cartons. If the serial number cannot be recognized, the return cannot be accepted. Describe briefly the reasons for return.
2. Freight Charge: customer is responsible for freight charges (including customs) for any returns.

Cadi Scientific Pte Ltd						
Document:	Quality Objectives and Quality Planning Control Procedures			Document No.:	MDDQP-001-A2	
Dept. of preparation:	Management Representative	Revision:	B01	Issue Date:	28 Oct 2009	Page 6 of 29 Annex II

Standards Compliance

This SmartBridge meets the following standards

- EN 60601-1:1990+A1:1993+A2:1995+A13:1996 (Safety)
- EN 60601-1-2:2001 (Electro-Magnetic Compatibility)
- EN 60601-1-4:1996+A1:1999 (Safety)
- IEC60601-1-8:2005 (Alarm)
- EN 60601-2-49:2001 (Safety)
- EN 980:2003 (Symbols for Labeling)
- Waterproof: IPX0
- Environment : WEEE (2002/96/EC)



Cadi Scientific Pte Ltd

31 Ubi Road 1, #03-00 Aztech Building, Singapore 408694

Tel : (65)62762676 Fax: (65)62766216

Email : info@cadi.com.sg URL : www.cadi.com.sg

Cadi Scientific Pte Ltd						
Document:	Quality Objectives and Quality Planning Control Procedures			Document No.:	MDDQP-001-A2	
Dept. of preparation:	Management Representative	Revision:	B01	Issue Date:	28 Oct 2009	Page 7 of 29 Annex II

1. Safety

1.1 Safety Information

This chapter lists all warnings, attentions and basic safety information when using CADI SMB-800 SmartBridge. Other safety information can be found in appropriate chapters.

Danger

- Indicates immediate danger. If not dealt with, may cause death, serious injuries or property damage.

Warning

- Indicates potential danger or unsafe operation. If not dealt with, may cause death, serious injuries or property damage.

Caution

- Indicates potential danger or unsafe operation. If not resolved may cause personal injuries, product malfunction, damage or property damage.

Caution

- Emphasis on attention with explanation on how to better use the product.

1.1.1 **Danger**

There is no safety information on levels of danger.

1.1.2 **Warning**

Only professional doctors and nurses can use this CADI SMB-800 for clinical monitoring under certain conditions.

Before using CADI SMB-800, users must check the device and its accessories to ensure its proper function and safety.

Disposable accessories should be disposed according to the regulations of the hospital.

Do not use CADI SMB-800 in an environment where flammable substances are present.

Users should set alarm settings according to patient types and conditions.

Do not open CADI SMB-800 case. Otherwise, it may cause serious injuries or death.

Do not use on patients during defibrillation. Otherwise, it may cause serious injuries or death.

Ensure patient safety when using CADI SMB-800 with other electrical surgical devices.

Cadi Scientific Pte Ltd						
Document:	Quality Objectives and Quality Planning Control Procedures			Document No.:	MDDQP-001-A2	
Dept. of preparation:	Management Representative	Revision:	B01	Issue Date:	28 Oct 2009	
					Page 8 of 29 Annex II	

The packaging material should be disposed according to local regulations and should be kept in a place where no children can reach.

Connect CADI SMB-800 only with the provided power adapter. Use with any other adapters may cause serious injuries or death.

1.1.3 Caution

Use accessories recommended in this manual to ensure patient safety.

Magnetic fields may affect the performance of CADI SMB-800. Any equipment in use near CADI SMB-800 must be in compliance with EMC standards. Cell phones, X-ray or MRI devices are possible interference sources, as they emit high electro-magnetism radiation.

Before connecting CADI SMB-800 to power, ensure the voltage and frequency are in accordance with the requirements on the adapter label or in the manual.

Install and transport CADI SMB-800 properly to prevent any damages caused by dropping, impact, shakes or other mechanical forces.

This equipment should be installed and operated with minimum distance 20cm between the radiator & your body.

1.1.4 Note

Note

Place this manual next to the CADI SMB-800 for convenience when needed.

The software for the CADI SMB-800 is developed in accordance with IEC60601-1-4 standards to minimize any risks caused by program errors.

Up to **1000** trend data storage.

Place CADI SMB-800 where easy observation, operation and maintenance can be obtained.

Cadi Scientific Pte Ltd						
Document:	Quality Objectives and Quality Planning Control Procedures			Document No.:	MDDQP-001-A2	
Dept. of preparation:	Management Representative	Revision:	B01	Issue Date:	28 Oct 2009	Page 10 of 29 Annex II

2. OVERVIEW

2.1 PRODUCT INTRODUCTION

2.1.1 Application range

CADI SMB-800 is intended for medical device connection. It is intended to connect to devices such as non-invasive blood pressure monitors (NIBP), oxygen saturation of arterial hemoglobin (SpO2) meters, pulse rate monitors, temperature monitors, and other Vital Signs Monitors.

2.1.2 Product structure

CADI SMB-800 is composed of the main unit, and adapter power supply/charger.

CADI SMB-800 has the following functions and features:

1. Connecting up to four (4) medical devices to the RS232 communication ports.
2. Receiving **ThermoSensor** data thru the built-in radio.
3. Upload data thru Wifi 802.11b/g or radio to hospital infrastructure.
4. Display: LCD and LED
5. Battery: internal rechargeable lithium battery, coin cell backup battery.

Cadi Scientific Pte Ltd						
Document:	Quality Objectives and Quality Planning Control Procedures			Document No.:	MDDQP-001-A2	
Dept. of preparation:	Management Representative	Revision:	B01	Issue Date:	28 Oct 2009	Page 11 of 29 Annex II

2.2 PRODUCT VIEW

2.2.1 Front

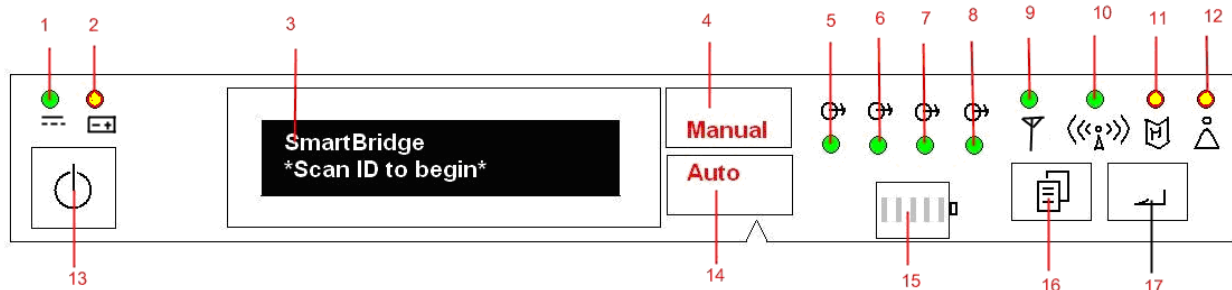

1. DC power indicator: displays green when dc power adapter is connected.
2. Battery indicator: displays green when running on battery, blinks yellow when battery is low.
3. LCD display: shows information on the 2 line display.
4. Manual mode indicator: displays "Manual" in red when device is in Manual mode.
5. Port 1 indicator: displays green when device connected and working properly. Flashes yellow when there is error in this communication port.
6. Port 2 indicator: displays green when device connected and working properly. Flashes yellow when there is error in this communication port.
7. Port 3 indicator: displays green when device connected and working properly. Flashes yellow when there is error in this communication port.
8. Port 4 indicator: displays green when device connected and working properly. Flashes yellow when there is error in this communication port.
9. Wifi indicator: displays green when active, flashes green when communicating, flashes yellow when error.
10. Radio indicator: displays green when active, flashes green when communicating, flashes yellow when error.
11. Memory indicator: flashes green when communicating, flashes yellow when nearing full.
12. Alarm indicator: flashes yellow when alarm condition.
13. Power button: press and hold for at least 2 seconds to turn the CADI SMB-800 on or off.
14. Auto mode indicator: displays "Auto" when device is in Auto mode.
15. Battery charge indicator: indicates battery is charging and quantity of battery electric charge.
16. Menu button: used in combination with Select button to navigate menus and settings.
17. Select button: used in combination with Menu button to navigate menus and settings.

Cadi Scientific Pte Ltd						
Document:	Quality Objectives and Quality Planning Control Procedures			Document No.:	MDDQP-001-A2	
Dept. of preparation:	Management Representative	Revision:	B01	Issue Date:	28 Oct 2009	Page 12 of 29 Annex II

2.2.2 Rear

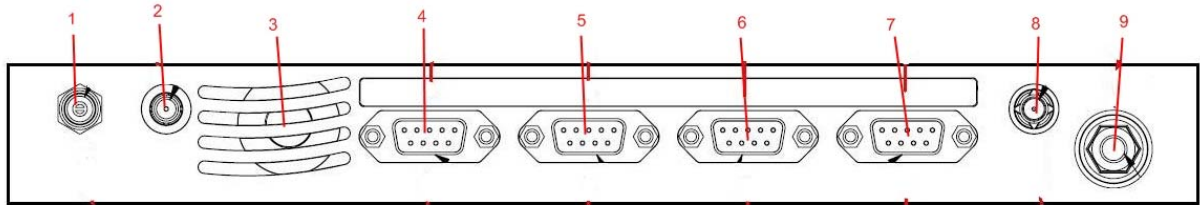

1. DC power socket.
2. Radio antenna connector.
3. Speaker vent.
4. RS232 port 1: used to connect to other device or PC
5. RS232 port 2: used to connect to other device or PC
6. RS232 port 3: used to connect to other device or PC
7. RS232 port 4: used to connect to other device or PC
8. Wifi antenna connector.
9. Common potential terminal (unused)

Cadi Scientific Pte Ltd						
Document:	Quality Objectives and Quality Planning Control Procedures			Document No.:	MDDQP-001-A2	
Dept. of preparation:	Management Representative	Revision:	B01	Issue Date:	28 Oct 2009	Page 13 of 29 Annex II

3. INSTALLATION AND MAINTENANCE

3.1 INSTALLATION

CADI SMB-800 should be installed by authorized personnel. The software of CADI SMB-800 belongs to Cadi Scientific Pte Ltd. No one should, in any manner, alter, copy or exchange the software without prior permission from Cadi Scientific Pte Ltd.

3.1.1 Open box for inspection

Before opening the box, carefully inspect the packaging for any damage during transportation. If found any, contact the shipping company or manufacturer. Open the box carefully and take out CADI SMB800 and accessories against the packing list. Inspect the product for any mechanical damages or any parts missing. For any questions, contact manufacturer.

Note

- Store the packing material for future use.

Warning

- The packing material should be kept away from children. Dispose the packing material according to local regulations or hospital rules.
- The device may be contaminated during storage, transportation or use. Inspect the packing before use. Do not use the device if any damage is found.

3.1.2 Environment requirement

- The environment where CADI SMB800 is used should be in accordance with the requirements specified in A.8. (see Appendix)
- In addition, CADI SMB800 should be used in an environment without excessive noise, dust, flammable or erosion substances. If mounted in a box, ensure there is enough space in the front and back of the box for easy operation, maintenance and services. To ensure good ventilation, CADI SMB800 should have 2 inches (5cm) space with other objects.
- When transporting CADI SMB800 from one place to another with difference in temperature, frosting may occur. If so, CADI SMB800 should be turned on after frosting disappears.

3.1.3 Power requirement

The power requirement should be in accordance with A.6 (see Appendix)

Warning

- CADI SMB800 working environment and power should be in accordance with requirements. Otherwise technical specifications set in Appendix A will not be satisfied. It may cause damage to the device or other unexpected outcome.

Cadi Scientific Pte Ltd						
Document:	Quality Objectives and Quality Planning Control Procedures			Document No.:	MDDQP-001-A2	
Dept. of preparation:	Management Representative	Revision:	B01	Issue Date:	28 Oct 2009	Page 14 of 29 Annex II

- Appropriate power source should be selected to satisfy the system power voltage requirements. Otherwise it may cause serious damage to the system.

3.1.4 Mounting

See related chapter for mounting instructions.

3.1.5 Installation instructions

Warning

- All analogue or digital equipment connected to the CADI SMB800 should be in accordance with IEC standards (IEC 60950 for information technology equipment safety and IEC 60601-1 for medical electrical equipment safety). All equipment should be connected in accordance with IEC 60601-1-1 standards. The personnel in charge of connecting peripheral equipment is responsible for making sure that these standards are followed. In doubt, contact manufacturer.
- When connecting CADI SMB800 with other electrical equipment for functional combination, ensure the safety of all equipment is obtained. If danger (e.g. electric shock due to leakage) cannot be eliminated from the specifications of each equipment, contact manufacturer or experts from the hospital.

Note

Users should have designated personnel to install as needed.

Connect adapter

1. Make sure the original adapter and power cord is used.
2. Plug the adapter into the back of the CADI SMB-800 as shown in figure 3-1.



3. Plug the power cord into a wall outlet.

Warning

Do not plug the into a socket controlled by a switch.

Do not use an adapter plug, use the correct power cord for your country.

Cadi Scientific Pte Ltd						
Document:	Quality Objectives and Quality Planning Control Procedures			Document No.:	MDDQP-001-A2	
Dept. of preparation:	Management Representative	Revision:	B01	Issue Date:	28 Oct 2009	Page 15 of 29 Annex II

Connect devices

Connect vital sign monitor to port 1,2 or 3. Connect barcode scanner to port 4.

3.1.6 Power on

After installation, follow the following steps:

1. Before power on, see 3.1.1 to conduct safety inspection.
2. Press power on/off button. System conducts self test automatically (POST).

Note

During self test (POST), make sure all displays and indicators illuminate.

3. In the self test (POST), display testing takes about 2 seconds.
All indicators illuminate;
All LEDs illuminate;
The LCD light illuminates and the welcome screen is shown.

Note

If there are any indicators or displays that do not illuminate, do not use CADI SMB-800. Contact sales or service representatives.

4. After self test for display functions, the welcome screen in the LCD will display the software version.

The battery might be drained during transportation or storage. If the CADI SMB-800 has been stored for more than 2 months, it is necessary to re-charge the battery before use by plugging the CADI SMB-800 into an AC power outlet for at least 30 minutes.

Regardless whether the CADI SMB-800 is powered off or on, the battery will be fully charged in about 6 hours if the AC power is connected to the CADI SMB-800.

Note

Whenever CADI SMB-800 is connected to AC power, the battery will be charged. Please keep CADI SMB-800 connected with the AC power even when it is not in use to ensure a fully charged battery. A connected unit will show the DC power indicator in green.

When using CADI SMB-800 without sufficient battery power, plug CADI SMB-800 into AC power outlet to charge the battery. CADI SMB-800 can be switched on for normal use.

3.2.2 Inspect battery performance

The battery performance may decrease as the time goes by. Follow the following steps to inspect the battery performance:

1. Disconnect all connections between CADI SMB-800 and other devices. Stop all activity.
2. Connect CADI SMB-800 with AC power and keep charging the battery for more than 6 hours.
3. Disconnect the DC adapter and use the CADI SMB-800 with battery power till the CADI SMB-800 shuts off.

Cadi Scientific Pte Ltd						
Document:	Quality Objectives and Quality Planning Control Procedures			Document No.:	MDDQP-001-A2	
Dept. of preparation:	Management Representative	Revision:	B01	Issue Date:	28 Oct 2009	Page 16 of 29 Annex II

4. The battery power duration reflects the battery performance.

If the fully charged battery life is significantly shorter than 6 hours, please contact authorized service personnel to have the battery replaced.

Note

The life of the battery depends on frequency of usage and duration. With proper maintenance and charge, the normal battery life is about 3 years. Otherwise, the battery life can be shorter. Replacing the battery every 3 years is recommended. The battery power duration depends on CADI SMB-800 set and operation. For example, many connected devices or frequent measuring can shorten the power duration.

3.2.3 Battery disposal

If there is obvious damage to the battery, replace the battery immediately. Dispose the battery properly according to local regulations.

Note

Please contact authorized service personnel to have the battery replaced.



Warning

Contact manufacturer at the time to replace the battery which should be replaced by authorized personnel.

Do not place the battery near or in fire. Burning, explosion or leakage may cause injuries.

Cadi Scientific Pte Ltd						
Document:	Quality Objectives and Quality Planning Control Procedures			Document No.:	MDDQP-001-A2	
Dept. of preparation:	Management Representative	Revision:	B01	Issue Date:	28 Oct 2009	Page 17 of 29 Annex II

3.3 Setting up the device

There are some settings to be done before CADI SMB-800 can be used. A few statistics can also be viewed. The figure below shows the menus available to the user. These can be accessed using the Menu button  and Select button  to navigate.

The menus available are:

- | | |
|---------------------|--|
| 1. Alarm | On/Off, Volume |
| 2. Port x Device | (nothing to set) |
| 4. Upload Mode | Manual/Auto |
| 5. Set Interval | Hours, Minutes (for Auto mode only) |
| 5. Date setting | dd/mth/yy/day of week |
| 6. Time setting | hh:mm, AM/PM |
| 7. Readings saved | Number of records stored (nothing to set) |
| 8. Maintenance mode | (password protected, for service personnel only) |

Cadi Scientific Pte Ltd						
Document:	Quality Objectives and Quality Planning Control Procedures			Document No.:	MDDQP-001-A2	
Dept. of preparation:	Management Representative	Revision:	B01	Issue Date:	28 Oct 2009	Page 18 of 29 Annex II

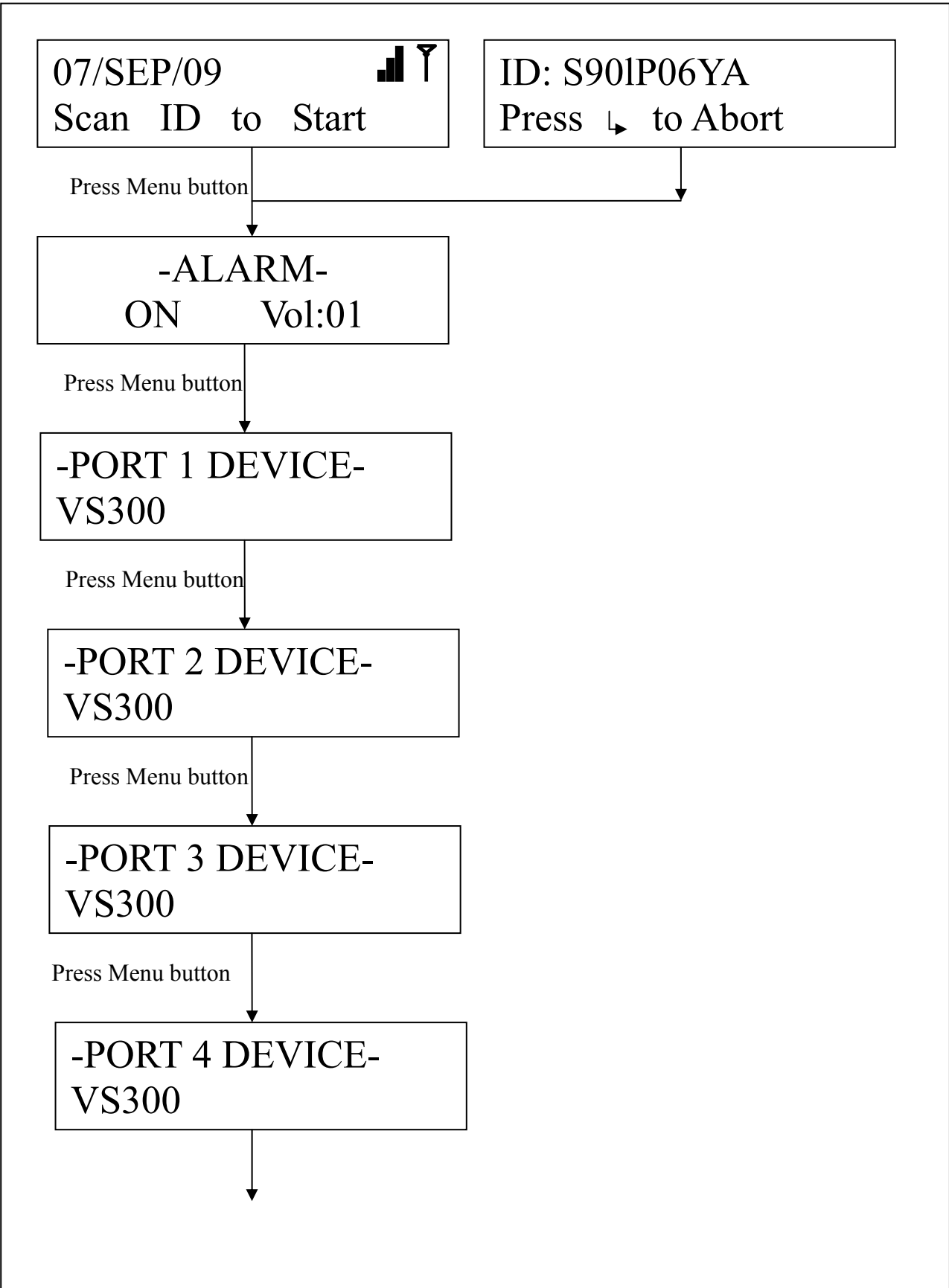

Cadi Scientific Pte Ltd						
Document:	Quality Objectives and Quality Planning Control Procedures			Document No.:	MDDQP-001-A2	
Dept. of preparation:	Management Representative	Revision:	B01	Issue Date:	28 Oct 2009	Page 19 of 29 Annex II

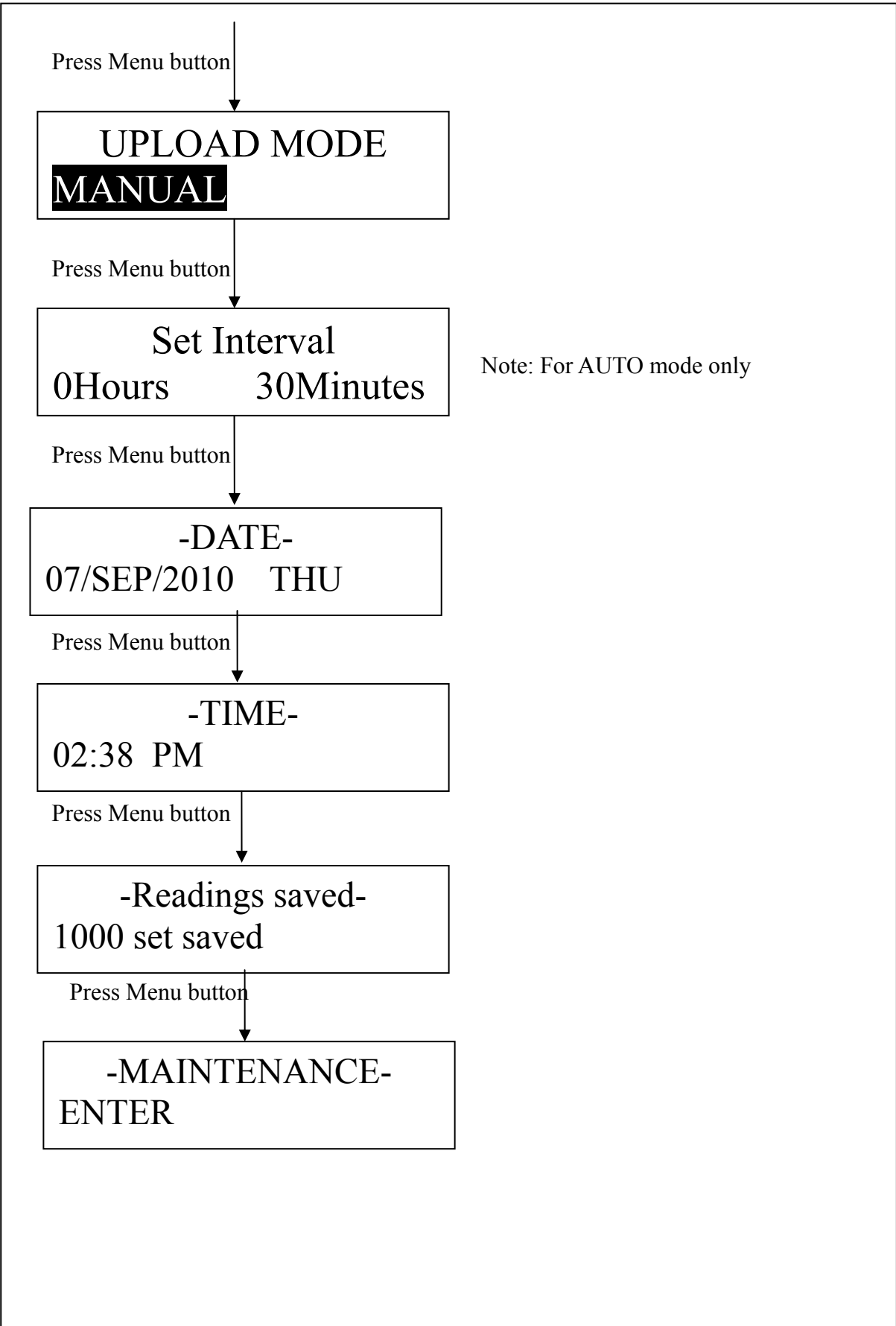

Cadi Scientific Pte Ltd						
Document:	Quality Objectives and Quality Planning Control Procedures			Document No.:	MDDQP-001-A2	
Dept. of preparation:	Management Representative	Revision:	B01	Issue Date:	28 Oct 2009	Page 20 of 29 Annex II

3.4 Using the device

CADI SMB-800 has two modes of operation: 1. MANUAL mode; 2. AUTO mode.

Both can be entered upon power up or by menu navigation.

Upon power up:



Using menu navigation:



Use the Menu button  and Select button  to navigate.

3.4.1 Manual mode

Manual mode is used for spot measurement. Once Manual mode is selected, the "Manual" word will light up and the LCD will show the following screen:

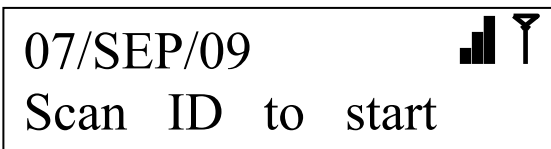

Before each measurement, the user has to scan the ID with the barcode scanner. Once the barcode is scanned, the next screen will show:



After this, activate the attached medical device (refer to the appropriate user manual). If at any time the user wants to abort, just select ESC and press button  here. Otherwise, navigate to SAVE to save and upload reading, or REVIEW to look at the results.

Cadi Scientific Pte Ltd						
Document:	Quality Objectives and Quality Planning Control Procedures			Document No.:	MDDQP-001-A2	
Dept. of preparation:	Management Representative	Revision:	B01	Issue Date:	28 Oct 2009	Page 21 of 29 Annex II

SAVE is selected: The LCD will display upload progress bar. Upload status (upload fail or success) will be shown on screen.

REVIEW is selected: The LCD will display the readings and option to SAVE or DISCARD reading.

$\sqrt{P1: SYS 120}$ $\sqrt{P1: DIA 80}$

<p>Save Measurement?</p> <p>Save Abort</p>

ESC is selected: last measurement is discarded and screen returns to default display:

07/SEP/09  Scan ID to Start
--

If something did not go smoothly, the screen below will flash:

NO MEASUREMENT

If everything goes as normal and the measurement is successfully completed, the next screen will return to the default display:



07/SEP/09  Scan ID to start

Cadi Scientific Pte Ltd						
Document:	Quality Objectives and Quality Planning Control Procedures			Document No.:	MDDQP-001-A2	
Dept. of preparation:	Management Representative	Revision:	B01	Issue Date:	28 Oct 2009	Page 22 of 29 Annex II

3.4.2 Auto mode

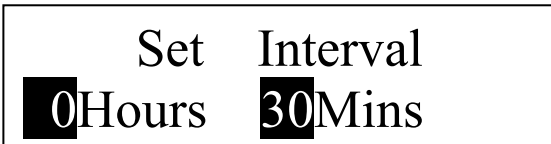
Auto mode is used for single patient use e.g. bedside monitoring. When using Auto mode, make sure the connected medical device is also set to Auto mode (refer to the respective user manuals). Once Auto mode is selected, the “Auto” word will light and the LCD will show the following screen:



The user can set the interval for data upload here. Use the Menu button  for changing the values and Select button  for confirmation. This setting is stored in non-volatile memory. Upon confirmation, the next screen will show the default display:

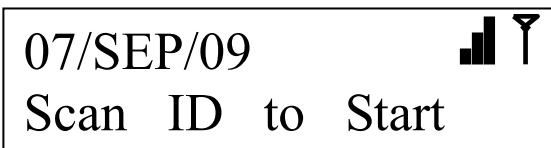

Once the ID has been scanned via the barcode scanner, the next screen will show:



If the connected medical devices have also been set for Auto mode, no further action is necessary. The device will activate measuring at the specified interval.

Cadi Scientific Pte Ltd						
Document:	Quality Objectives and Quality Planning Control Procedures			Document No.:	MDDQP-001-A2	
Dept. of preparation:	Management Representative	Revision:	B01	Issue Date:	28 Oct 2009	Page 23 of 29 Annex II

3.5 MAINTENANCE

Warning

- The organization where **CADI SMB-800** is used should establish complete maintenance plans. Otherwise it may cause device malfunction, other unexpected outcome or even risks of human safety.
- All necessary un-installation of the device for safety inspection or maintenance should be conducted by authorized personnel. Otherwise it may cause device malfunction and risks of human safety.

3.5.1 Inspection

Authorized service personnel should conduct a complete inspection of the **CADI SMB-800** before use, after continuous use for 6 – 12 months, maintenance or upgrades should be done to ensure normal system function and operation.

The inspection should include the following:

- Environment and power requirements are met;
- The **CADI SMB-800** exterior is clean and not contaminated;
- No mechanical damage to the case, buttons, ports and accessories;
- Power cord is not damaged and well insulated;
- Only recommended accessories are used;
- The **CADI SMB-800** clock is set;
- Audio and visual alarms function normally;

Do not use the **CADI SMB-800** if any damages or abnormalities are found. Contact hospital or service personnel.

Cadi Scientific Pte Ltd						
Document:	Quality Objectives and Quality Planning Control Procedures			Document No.:	MDDQP-001-A2	
Dept. of preparation:	Management Representative	Revision:	B01	Issue Date:	28 Oct 2009	Page 24 of 29 Annex II

3.5.2 Cleaning

Warning

- Turn off CADI SMB800 and unplug the cord from the wall outlet before cleaning CADI SMB800

Clean CADI SMB800 regularly. In places with poor environmental conditions, cleaning should be more frequent. Consult hospitals before cleaning for any regulations.

Use clean, soft cloth or cotton sponge dampened with cleaning solutions to wipe the CADI SMB800 exterior. Use the following recommended solutions;

- Diluted soap solution;
- Diluted Ammonia, Sodium hypochlorite (bleaching powder) or diluted formaldehyde (35-37%);
- Alcohol or Glutaraldehyde.

Note

- Sodium hypochlorite with concentration range about 500ppm (Diluted bleaching powder for family use 1:100) to 5000ppm (Diluted bleaching powder for family use 1:10) is very effective. The ppm can be determined by the amount of stain (blood, mucilage glue of animal or plant) on the surface of the CADI SMB800

Follow the following to prevent damage to the CADI SMB800:

- Some solution needs to be diluted before use. Follow the instructions.
- Do not immerse the CADI SMB800 in liquid or any cleaning solutions. Do not pour liquid or cleaning solutions onto the CADI SMB800.
- Do not allow liquid or cleaning solutions to enter the CADI SMB800, switches, ports or any vents.
- Do not use any materials or solutions that will cause damage.

Caution

- Ignoring the above may cause damage to the CADI SMB800 casing or labels and may result in CADI SMB800 malfunction.

Note

- See appropriate chapters or instructions for cleaning accessories.

Cadi Scientific Pte Ltd						
Document:	Quality Objectives and Quality Planning Control Procedures			Document No.:	MDDQP-001-A2	
Dept. of preparation:	Management Representative	Revision:	B01	Issue Date:	28 Oct 2009	Page 25 of 29 Annex II

3.5.3 Disinfection

Warning

- Disinfection of the CADI SMB800 may cause some damage it. Consult disease control personnel or experts of the hospital when disinfection is necessary.
- The recommended cleaning solutions are used for general cleaning. If used for disinfection purpose, manufacturer does not take responsibility for their effectiveness.

Disinfecting the Monitor may cause some damage. Only perform disinfection when deemed necessary in the maintenance plan of the hospital. Clean the CADI SMB800 first before disinfecting it.

Recommended disinfectant includes: Ethanol-Based, 70% alcohol, 70%B-propyl, aldehyde.

Caution

- Follow manufacturer's instructions or use lower concentration solutions.
- Do not pour solutions onto the CADI SMB800 or accessories. Do not immerse the CADI SMB800 into solutions.
- Do not leave excess liquid on the surface of the device and accessories. Use cloth to wipe dry.
- Do not use E to or undiluted formaldehyde for sterilization.
- Do not use high pressure or high temperature for sterilization.

Cadi Scientific Pte Ltd						
Document:	Quality Objectives and Quality Planning Control Procedures			Document No.:	MDDQP-001-A2	
Dept. of preparation:	Management Representative	Revision:	B01	Issue Date:	28 Oct 2009	Page 26 of 29 Annex II

4. ALARM

4.1 OVERVIEW

Alarms are audio and visual indicators generated by the CADI SMB-800 to alert doctors and nurses. These alarms occur when the vital signs of the patients being monitored become abnormal or the CADI SMB-800 itself malfunctions and cannot perform its task.

4.1.1 Alarm types

The alarms are Technical Alarm and Information Prompt.

- Technical Alarm

Technical Alarm means the device or parts are not capable to perform the monitoring task, e.g. device failure.

- Information Prompt

Strictly speaking, Information Prompt is not a type of alarm. The CADI SMB-800 can display some information of the system status, e.g. battery low. This type of information is not related to device failure.

4.1.2 Alarm levels

There are 3 levels of alarm: High, Mid and Low.

- High level alarm

High level alarm indicates life threatening or serious technical problems of the CADI SMB-800.

- Mid level alarm

Mid level alarm occurs when preset thresholds are exceeded.

- Low level alarm

The following situations will prompt low level alarms:

1. CADI SMB-800 malfunction;
2. Battery low (when using battery for power supply);
3. Medical device connection lost.

When battery is low, the indicator will illuminate and there will be sound. All Technical Alarms are default settings which cannot be changed.

Cadi Scientific Pte Ltd						
Document:	Quality Objectives and Quality Planning Control Procedures			Document No.:	MDDQP-001-A2	
Dept. of preparation:	Management Representative	Revision:	B01	Issue Date:	28 Oct 2009	Page 27 of 29 Annex II

4.1.3 Alarm modes

The alarm modes are:

1. Audio alarm;
2. Visual alarm;
3. Information alarm.

These alarm modes indicate alarm levels differently.

4.2 AUDIO ALARM

Audio alarm includes alarm sound, key pressing sound and pulse sound.

Note

When various levels of alarm occur at the same time, alarm sound indicates the high level alarm.

Table 4-1 Alarm Sound Functions

Function	Explanation	Volume	Frequency (Hz)	Width Td(ms)	Interval Ts(ms)	Number of sounds
Self test passed	Power-on self test completed, one sound indicates the test passed.	Cannot be adjusted	1500	150	N/A	One "beep"
Valid key pressing	One sound indicates the key pressing is valid.	Cannot be adjusted	400	150	N/A	One "beep"
High level alarm	One high note sound with rapid "beep"	Adjustable	700	150	N/A	"beep-beep-beep—beep-beep, beep-beep-beep—beep-beep"
Mid level alarm	Two mid, stable beeps	Adjustable	700	150	200	"beep-beep-beep"
Low level alarm	One low, slow beep	Adjustable	700	150	N/A	One "beep"

Cadi Scientific Pte Ltd						
Document:	Quality Objectives and Quality Planning Control Procedures			Document No.:	MDDQP-001-A2	
Dept. of preparation:	Management Representative	Revision:	B01	Issue Date:	28 Oct 2009	Page 28 of 29 Annex II

4.3 VISUAL ALARM

Yellow light is used for visual alarms. 2Hz flashing yellow light indicates communication error and battery low. Other alarms do not have flashing light.

4.4 ALARM SETTINGS

4.5 AUDIO ALARM STATUS

Under normal working conditions, all alarm modes for all levels of alarms can be performed. The user can also set alarms to meet their requirements. The alarm settings can be accessed from the menu. Note that High level alarms cannot be disabled.

Normal audio alarms

When alarms occur, there is a normal alarm sound.

Alarm sound setting

Alarm sound OFF means the sound is silenced. Under the menu, navigate to Alarm screen and select OFF.



Cadi Scientific Pte Ltd						
Document:	Quality Objectives and Quality Planning Control Procedures			Document No.:	MDDQP-001-A2	
Dept. of preparation:	Management Representative	Revision:	B01	Issue Date:	28 Oct 2009	Page 29 of 29 Annex II

SPECIFICATIONS

Power	100 - 240 V AC, 50/60 Hz
Power consumption	Max 40VA
External dimensions (excluding maximum projecting part)	170 x 280 x 40 mm
Internal battery pack	12.6v Li-Ion (SHENZHEN CHAM BATTERY CMICR18650)
Clock backup battery	3v Li-Mn cell CR2450
Mass	Approx. 1.2 kg (2.6 lb)
Operating temperature	20°C - 40°C (68°F - 104°F)
Storage temperature	10°C - 50°C (50°F - 122°F)
Transport temperature	10°C - 50°C (50°F - 122°F)
Inputs/outputs	DC connector x1 DB9F x4
Supplied accessories	DC adapter x1 (SKYNET SNP-A048-M) AC cable x1 DB9 cable x1 Instruction manual x1
Transmission frequency	868.4 MHz (For customer in Europe) 919.8 MHz (For customer in U.S.A) 925.0 MHz (For customer in U.S.A) 2.4 Ghz (For customer in Europe and U.S.A)