

2006 Cadillac XLR Owner Manual

Seats and Restraint Systems	1-1	Navigation System	4-1
Front Seats	1-2	Overview	4-2
Safety Belts	1-5	Features and Controls	4-10
Child Restraints	1-18	Navigation Audio System	4-51
Airbag System	1-32	Voice Recognition	4-75
Restraint System Check	1-45	Driving Your Vehicle	5-1
Features and Controls	2-1	Your Driving, the Road, and Your Vehicle	5-2
Keys	2-2	Towing	5-37
Doors and Locks	2-9	Service and Appearance Care	6-1
Windows	2-15	Service	6-3
Theft-Deterrent Systems	2-18	Fuel	6-5
Starting and Operating Your Vehicle	2-20	Checking Things Under the Hood	6-10
Mirrors	2-34	Rear Axle	6-42
OnStar® System	2-37	Headlamp Aiming	6-43
Universal Home Remote System	2-39	Bulb Replacement	6-45
Storage Areas	2-44	Windshield Replacement	6-46
Retractable Hardtop	2-46	Windshield Wiper Blade Replacement	6-46
Vehicle Personalization	2-56	Tires	6-47
Instrument Panel	3-1	Appearance Care	6-71
Instrument Panel Overview	3-4	Vehicle Identification	6-79
Climate Controls	3-41	Electrical System	6-80
Warning Lights, Gages, and Indicators	3-48	Capacities and Specifications	6-86
Driver Information Center (DIC)	3-64	Maintenance Schedule	7-1
Trip Computer	3-82	Maintenance Schedule	7-2
Audio System(s)	3-82	Customer Assistance and Information	8-1
		Customer Assistance and Information	8-2
		Reporting Safety Defects	8-13
		Index	1

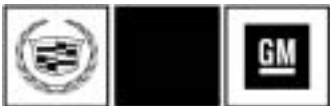

GENERAL MOTORS, GM, the GM Emblem, CADILLAC, the CADILLAC Crest & Wreath, and the name XLR are registered trademarks of General Motors Corporation.

This manual includes the latest information at the time it was printed. We reserve the right to make changes after that time to the product without notice. For vehicles first sold in Canada, substitute the name "General Motors of Canada Limited" for Cadillac Motor Car Division whenever it appears in this manual.

Keep this manual in the vehicle, so it will be there if it is needed while you are on the road. If the vehicle is sold, leave this manual in the vehicle.

Canadian Owners

A French language copy of this manual can be obtained from your dealer or from:

Helm, Incorporated
P.O. Box 07130
Detroit, MI 48207

How to Use This Manual

Many people read the owner manual from beginning to end when they first receive their new vehicle. If this is done, it can help you learn about the features and controls for the vehicle. Pictures and words work together in the owner manual to explain things.

Index

A good place to quickly locate information about the vehicle is the Index in the back of the manual. It is an alphabetical list of what is in the manual and the page number where it can be found.

Safety Warnings and Symbols

There are a number of safety cautions in this book. We use a box and the word CAUTION to tell about things that could hurt you if you were to ignore the warning.



CAUTION:

These mean there is something that could hurt you or other people.

In the caution area, we tell you what the hazard is. Then we tell you what to do to help avoid or reduce the hazard. Please read these cautions. If you do not, you or others could be hurt.

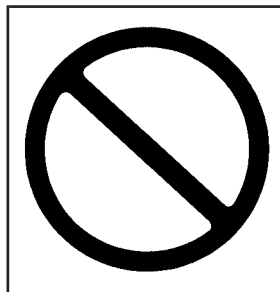

You will also find a circle with a slash through it in this book. This safety symbol means “Do Not,” “Do Not do this” or “Do Not let this happen.”

Vehicle Damage Warnings

Also, in this manual you will find these notices:

Notice: These mean there is something that could damage your vehicle.

A notice tells about something that can damage the vehicle. Many times, this damage would not be covered by your vehicle's warranty, and it could be costly. But the notice will tell what to do to help avoid the damage.

When you read other manuals, you might see CAUTION and NOTICE warnings in different colors or in different words.

There are also warning labels on the vehicle. They use the same words, CAUTION or NOTICE.

































Vehicle Symbols

The vehicle has components and labels that use symbols instead of text. Symbols are shown along with the text describing the operation or information relating to a specific component, control, message, gage, or indicator.

If you need help figuring out a specific name of a component, gage, or indicator, reference the following topics:

- Seats and Restraint Systems in Section 1
- Features and Controls in Section 2
- Instrument Panel Overview in Section 3
- Climate Controls in Section 3
- Warning Lights, Gages, and Indicators in Section 3
- Audio System(s) in Section 3
- Engine Compartment Overview in Section 5

These are some examples of symbols that may be found on the vehicle:

<p>CAUTION POSSIBLE INJURY</p> 	<p>LATCH BOTH LAP AND SHOULDER BELTS TO PROTECT OCCUPANT DO NOT TWIST SAFETY BELT WHEN ATTACHING</p>  	<p>MASTER LIGHTING SWITCH</p> 	<p>ENGINE COOLANT TEMP</p> 	<p>TIRE PRESSURE</p> 	
<p>PROTECT EYES BY SHIELDING</p> 	<p>FASTEN SEAT BELTS</p> 	<p>AIRBAG</p> 	<p>TURN SIGNALS</p> 	<p>BATTERY CHARGING SYSTEM</p> 	<p>FUSE BOX ACCESS</p> 
<p>CAUSTIC BATTERY ACID COULD CAUSE BURNS</p> 	<p>MOVE SEAT FULLY REARWARD SECURE CHILD SEAT</p> 	<p>DO NOT INSTALL A REAR-FACING CHILD RESTRAINT IN THIS SEATING POSITION</p> 	<p>PARKING LAMPS</p> 	<p>HAZARD WARNING FLASHER</p> 	<p>ENGINE COOLANT FAN</p> 
<p>AVOID SPARKS OR FLAMES</p> 	<p>PULL BELT OUT COMPLETELY THEN SECURE CHILD SEAT</p> 	<p>DO NOT INSTALL A FORWARD-FACING CHILD RESTRAINT IN THIS SEATING POSITION</p> 	<p>HAZARD WARNING FLASHER</p> 	<p>COOLANT</p> 	<p>FUEL</p> 
<p>SPARK OR FLAME COULD EXPLODE BATTERY</p> 	<p>POWER WINDOW</p> 	<p>DOOR LOCK UNLOCK</p> 	<p>DAYTIME RUNNING LAMPS</p> 	<p>ENGINE OIL PRESSURE</p> 	<p>OWNER'S MANUAL</p> 
			<p>FOG LAMPS</p> 	<p>ANTI-LOCK BRAKES</p> 	<p>SERVICE MANUAL</p> 

Section 1 Seats and Restraint Systems

Front Seats	1-2	Lower Anchors and Tethers for Children (LATCH)	1-27
Power Seats	1-2	Securing a Child Restraint in the Passenger Seat Position	1-28
Power Lumbar	1-2	Airbag System	1-32
Heated and Cooled Seats	1-3	Where Are the Airbags?	1-34
Power Reclining Seatback	1-4	When Should an Airbag Inflate?	1-37
Safety Belts	1-5	What Makes an Airbag Inflate?	1-38
Safety Belts: They Are for Everyone	1-5	How Does an Airbag Restrain?	1-38
Questions and Answers About Safety Belts	1-9	What Will You See After an Airbag Inflates?	1-39
How to Wear Safety Belts Properly	1-10	Passenger Sensing System	1-40
Driver Position	1-10	Servicing Your Airbag-Equipped Vehicle	1-44
Safety Belt Use During Pregnancy	1-16	Adding Equipment to Your Airbag-Equipped Vehicle	1-44
Passenger Position	1-17	Restraint System Check	1-45
Safety Belt Pretensioners	1-17	Checking the Restraint Systems	1-45
Safety Belt Extender	1-17	Replacing Restraint System Parts After a Crash	1-46
Child Restraints	1-18		
Older Children	1-18		
Infants and Young Children	1-20		
Child Restraint Systems	1-23		

Front Seats

Power Seats

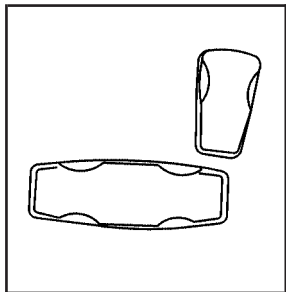

The power seat controls are located on the outboard sides of both the driver's and the passenger's seats.

- Slide the control forward or rearward to move the entire seat forward or rearward.
- Press the vertical control rearward to recline the seatback. Press the vertical control forward to raise the seatback. See *Power Reclining Seatback on page 1-4*.

Power Lumbar

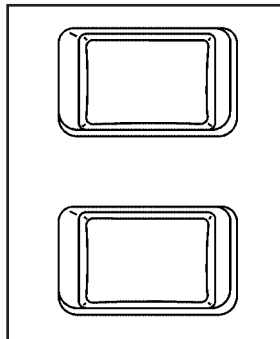

The driver's and passenger's seatback lumbar support switches are located on the outboard sides of the seats.

- Move the front of the horizontal control up or down to adjust the front portion of the cushion.
- Move the rear of the horizontal control up or down to adjust the rear portion of the cushion.

Use the power seat controls first to get the proper position, then continue with the lumbar adjustment.

Use the top lumbar switch to adjust support to the middle seatback and the bottom lumbar switch to adjust support to the lower seatback. Press the front of the switch to increase support and the rear of the switch to decrease support.

Keep in mind that as your seating position changes, as it may during long trips, so should the position of your lumbar support. Adjust the seat as needed.

Heated and Cooled Seats

The buttons for the heated and cooled seats are located on the climate control system.

 **(Heated/Cooled Seat):** Press this button to turn the feature on. The button on the left controls the driver's seat and the button on the right controls the passenger's seat. Each press of the button will take you to a different setting. The settings available in order are HI HEAT, LO HEAT, OFF, HI COOL, LO COOL and OFF. You will be able to feel the temperature change in a few minutes.

The feature will automatically turn off when the vehicle is turned off.

Power Reclining Seatback

The vertical power seat control described earlier allows the seatback to recline. See *Power Seats on page 1-2* for more information.



Do not have a seatback reclined if your vehicle is moving.

CAUTION:

Sitting in a reclined position when your vehicle is in motion can be dangerous. Even if you buckle up, your safety belts cannot do their job when you are reclined like this.

The shoulder belt cannot do its job. In a crash, you could go into it, receiving neck or other injuries.

The lap belt cannot do its job either. In a crash the belt could go up over your abdomen. The belt forces would be there, not at your pelvic bones. This could cause serious internal injuries.

For proper protection when the vehicle is in motion, have the seatback upright. Then sit well back in the seat and wear your safety belt properly.

Safety Belts

Safety Belts: They Are for Everyone

This part of the manual tells you how to use safety belts properly. It also tells you some things you should not do with safety belts.

CAUTION:

Do not let anyone ride where he or she can not wear a safety belt properly. If you are in a crash and you are not wearing a safety belt, your injuries can be much worse. You can hit things inside the vehicle or be ejected from it. You can be seriously injured or killed. In the same crash, you might not be if you are buckled up. Always fasten your safety belt, and check that your passenger's belt is fastened properly too.

CAUTION:

It is extremely dangerous to ride in a cargo area, inside or outside of a vehicle. In a collision, people riding in these areas are more likely to be seriously injured or killed. Do not allow people to ride in any area of your vehicle that is not equipped with seats and safety belts. Be sure everyone in your vehicle is in a seat and using a safety belt properly.



Your vehicle has a light that comes on as a reminder to buckle up. See *Safety Belt Reminder Light* on page 3-50.

In most states and all Canadian provinces, the law says to wear safety belts. Here's why: *They work.*

You never know if you'll be in a crash. If you do have a crash, you don't know if it will be a bad one.

A few crashes are mild, and some crashes can be so serious that even buckled up a person wouldn't survive. But most crashes are in between. In many of them, people who buckle up can survive and sometimes walk away. Without belts they could have been badly hurt or killed.

After more than 30 years of safety belts in vehicles, the facts are clear. In most crashes buckling up does matter...a lot!

Why Safety Belts Work

When you ride in or on anything, you go as fast as it goes.

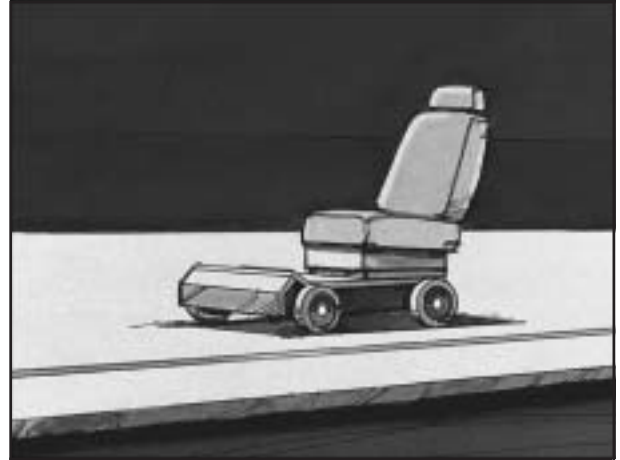

Take the simplest vehicle. Suppose it's just a seat on wheels.



Put someone on it.

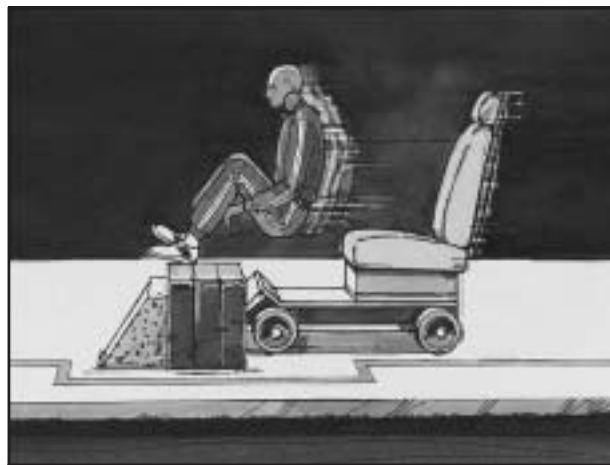

Get it up to speed. Then stop the vehicle. The rider doesn't stop.



The person keeps going until stopped by something.
In a real vehicle, it could be the windshield...



or the instrument panel...



or the safety belts!

With safety belts, you slow down as the vehicle does. You get more time to stop. You stop over more distance, and your strongest bones take the forces. That's why safety belts make such good sense.

Questions and Answers About Safety Belts

Q: Won't I be trapped in the vehicle after an accident if I'm wearing a safety belt?

A: You *could* be — whether you're wearing a safety belt or not. But you can unbuckle a safety belt, even if you're upside down. And your chance of being conscious during and after an accident, so you *can* unbuckle and get out, is *much* greater if you are belted.

Q: If my vehicle has airbags, why should I have to wear safety belts?

A: Airbags are in many vehicles today and will be in most of them in the future. But they are supplemental systems only; so they work *with* safety belts — not instead of them. Every airbag system ever offered for sale has required the use of safety belts. Even if you're in a vehicle that has airbags, you still have to buckle up to get the most protection. That's true not only in frontal collisions, but especially in side and other collisions.

Q: If I'm a good driver, and I never drive far from home, why should I wear safety belts?

A: You may be an excellent driver, but if you're in an accident — even one that isn't your fault — you and your passenger can be hurt. Being a good driver doesn't protect you from things beyond your control, such as bad drivers.

Most accidents occur within 25 miles (40 km) of home. And the greatest number of serious injuries and deaths occur at speeds of less than 40 mph (65 km/h).

Safety belts are for everyone.

How to Wear Safety Belts Properly

This part is only for people of adult size.

Be aware that there are special things to know about safety belts and children. And there are different rules for smaller children and babies. If a child will be riding in your vehicle, see *Older Children on page 1-18* or *Infants and Young Children on page 1-20*. Follow those rules for everyone's protection.

First, you will want to know which restraint systems your vehicle has.

We will start with the driver position.

Driver Position Lap-Shoulder Belt

The driver has a lap-shoulder belt. Here is how to wear it properly.

1. Close the door.
2. Adjust the seat so you can sit up straight.
To see how, see "Seats" in the Index.

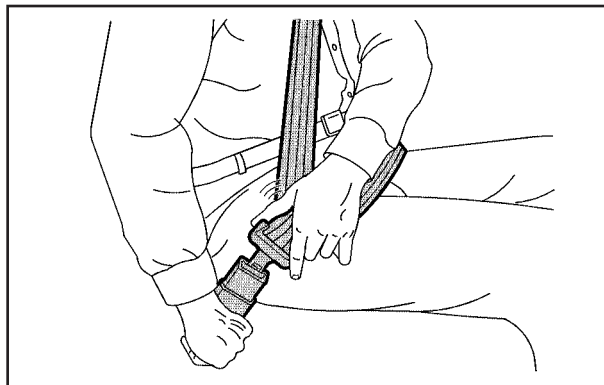

3. Pick up the latch plate and pull the belt across you. Do not let it get twisted.

The shoulder belt may lock if you pull the belt across you very quickly. If this happens, let the belt go back slightly to unlock it. Then pull the belt across you more slowly.

4. Push the latch plate into the buckle until it clicks.
Pull up on the latch plate to make sure it is secure.
If the belt is not long enough, see *Safety Belt Extender on page 1-17*.
Make sure the release button on the buckle is positioned so you would be able to unbuckle the safety belt quickly if you ever had to.

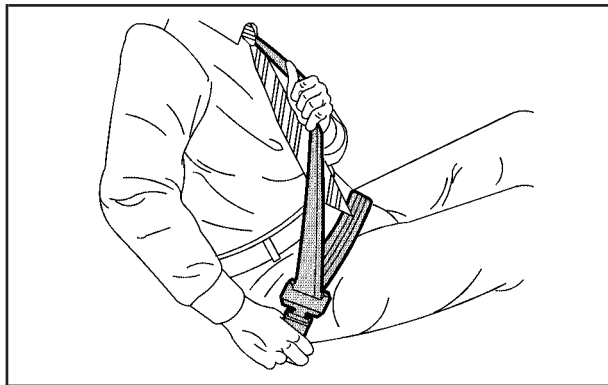

5. To make the lap part tight, pull up on the shoulder belt.

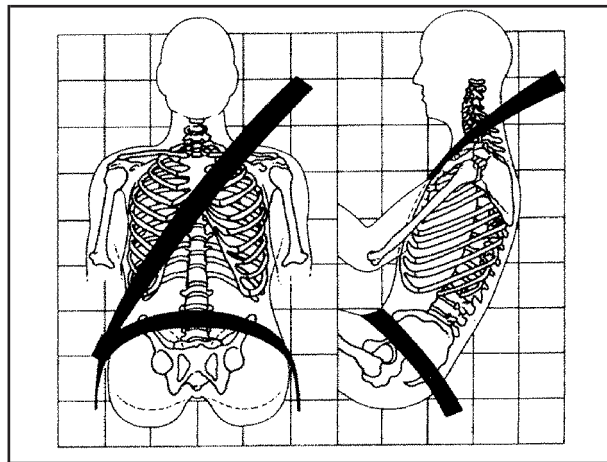

The lap part of the belt should be worn low and snug on the hips, just touching the thighs. In a crash, this applies force to the strong pelvic bones. And you would be less likely to slide under the lap belt. If you slid under it, the belt would apply force at your abdomen. This could cause serious or even fatal injuries. The shoulder belt should go over the shoulder and across the chest. These parts of the body are best able to take belt restraining forces.

The safety belt locks if there is a sudden stop or crash, or if you pull the belt very quickly out of the retractor.

Q: What is wrong with this?

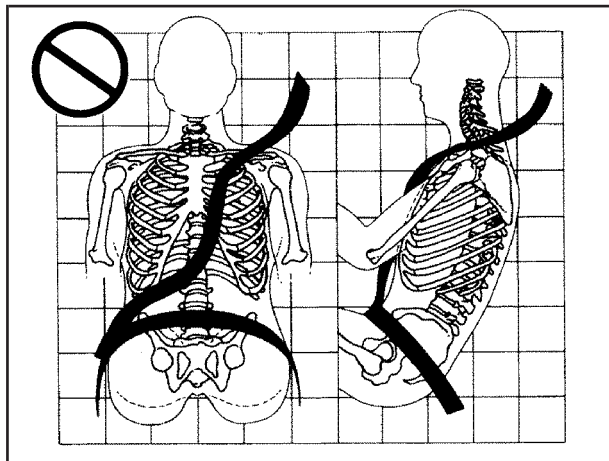

A: The shoulder belt is too loose. It will not give nearly as much protection this way.

⚠ CAUTION:

You can be seriously hurt if your shoulder belt is too loose. In a crash, you would move forward too much, which could increase injury. The shoulder belt should fit against your body.

Q: What is wrong with this?

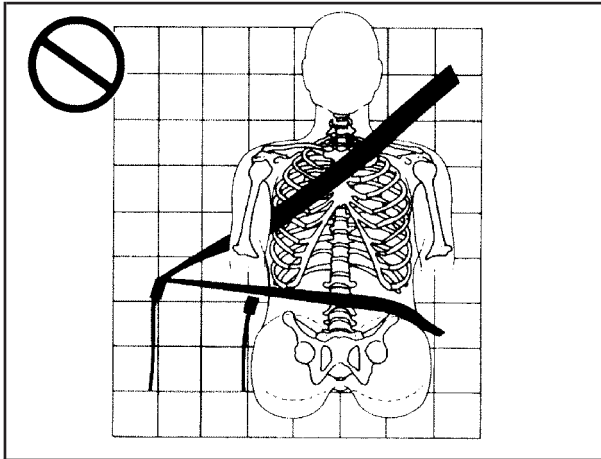

A: The belt is buckled in the wrong place.

⚠ CAUTION:

You can be seriously injured if your belt is buckled in the wrong place like this. In a crash, the belt would go up over your abdomen. The belt forces would be there, not at the pelvic bones. This could cause serious internal injuries. Always buckle your belt into the buckle nearest you.

Q: What is wrong with this?

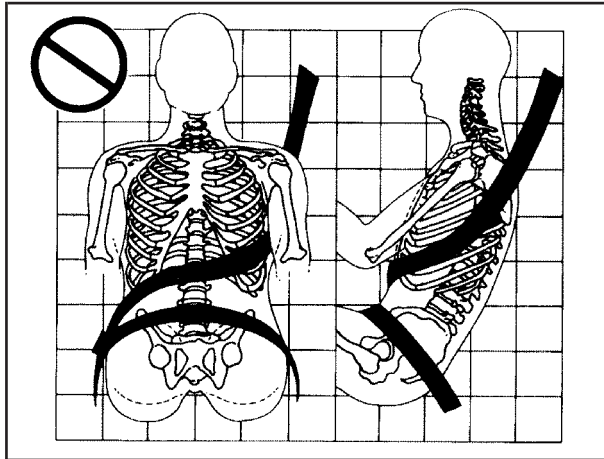

A: The shoulder belt is worn under the arm. It should be worn over the shoulder at all times.

⚠ CAUTION:

You can be seriously injured if you wear the shoulder belt under your arm. In a crash, your body would move too far forward, which would increase the chance of head and neck injury. Also, the belt would apply too much force to the ribs, which are not as strong as shoulder bones. You could also severely injure internal organs like your liver or spleen.

Q: What is wrong with this?

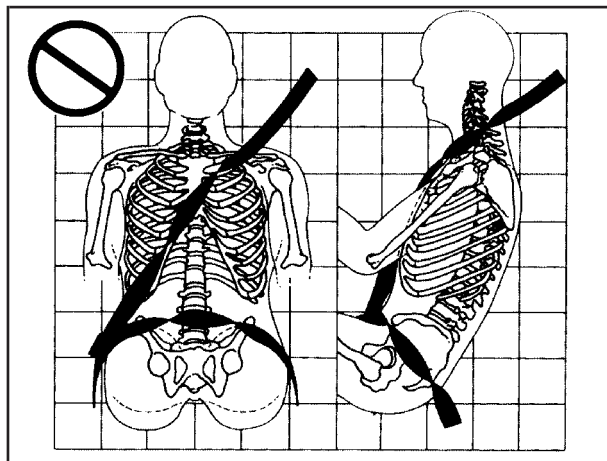

A: The belt is twisted across the body.

⚠ CAUTION:

You can be seriously injured by a twisted belt. In a crash, you would not have the full width of the belt to spread impact forces. If a belt is twisted, make it straight so it can work properly, or ask your dealer to fix it.

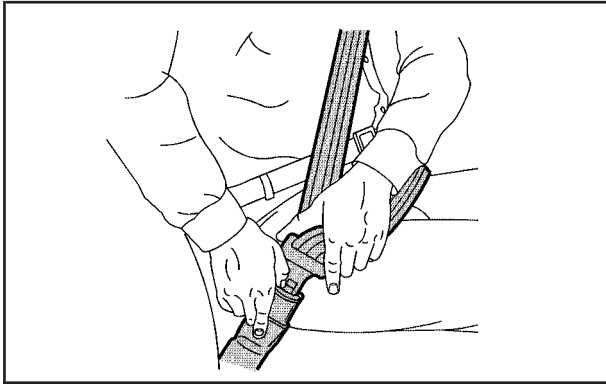

To unlatch the belt, just push the button on the buckle. The belt should go back out of the way.

Before you close the door, be sure the belt is out of the way. If you slam the door on it, you can damage both the belt and your vehicle.

Safety Belt Use During Pregnancy

Safety belts work for everyone, including pregnant women. Like all occupants, they are more likely to be seriously injured if they do not wear safety belts.

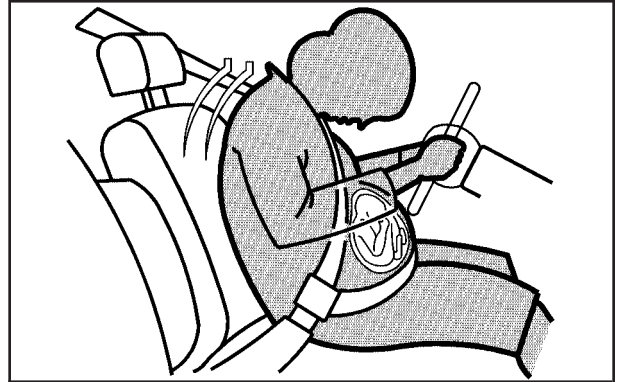

A pregnant woman should wear a lap-shoulder belt, and the lap portion should be worn as low as possible, below the rounding, throughout the pregnancy.

The best way to protect the fetus is to protect the mother. When a safety belt is worn properly, it is more likely that the fetus will not be hurt in a crash. For pregnant women, as for anyone, the key to making safety belts effective is wearing them properly.

Passenger Position

To learn how to wear the passenger's safety belt properly, see *Driver Position on page 1-10*.

The passenger's safety belt works the same way as the driver's safety belt — except for one thing. If you ever pull the shoulder portion of the belt out all the way, you will engage the child restraint locking feature. If this happens, just let the belt go back all the way and start again.

Safety Belt Pretensioners

Your vehicle has safety belt pretensioners for the driver and right front passenger. Although you cannot see them, they are located on the buckle end of the safety belts. They help the safety belts reduce a person's forward movement in a moderate to severe frontal and near frontal crash.

Pretensioners work only once. If they activate in a crash, you will need to get new ones, and probably other new parts for your safety belt system. See *Replacing Restraint System Parts After a Crash on page 1-46*.

Safety Belt Extender

If the vehicle's safety belt will fasten around you, you should use it.

But if a safety belt is not long enough, your dealer will order you an extender. It is free. When you go in to order it, take the heaviest coat you will wear, so the extender will be long enough for you. To help avoid personal injury, do not let someone else use it, and use it only for the seat it is made to fit. The extender has been designed for adults. Never use it for securing child seats. To wear it, just attach it to the regular safety belt. For more information, see the instruction sheet that comes with the extender.

Child Restraints

Older Children



Older children who have outgrown booster seats should wear the vehicle's safety belts.

Q: What is the proper way to wear safety belts?

A: If possible, an older child should wear a lap-shoulder belt and get the additional restraint a shoulder belt can provide. The shoulder belt should not cross the face or neck. The lap belt should fit snugly below the hips, just touching the top of the thighs. It should never be worn over the abdomen, which could cause severe or even fatal internal injuries in a crash.

In a crash, children who are not buckled up can strike other people who are buckled up, or can be thrown out of the vehicle. Older children need to use safety belts properly.

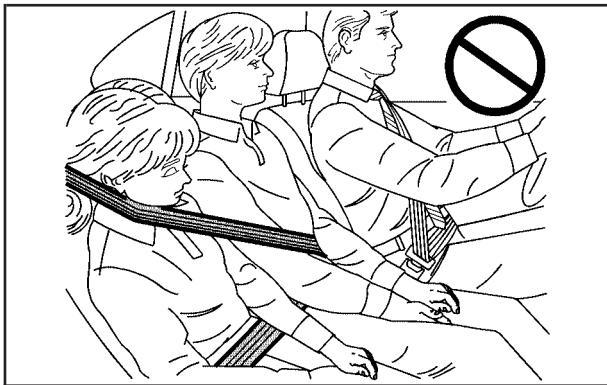

⚠ CAUTION:

Never do this.

Here two children are wearing the same belt. The belt can not properly spread the impact forces. In a crash, the two children can be crushed together and seriously injured. A belt must be used by only one person at a time.

Q: What if a child is wearing a lap-shoulder belt, but the child is so small that the shoulder belt is very close to the child's face or neck?

A: Move the child toward the center of the vehicle, but be sure that the shoulder belt still is on the child's shoulder, so that in a crash the child's upper body would have the restraint that belts provide.



⚠ CAUTION:

Never do this.

Here a child is sitting in a seat that has a lap-shoulder belt, but the shoulder part is behind the child. If the child wears the belt in this way, in a crash the child might slide under the belt. The belt's force would then be applied right on the child's abdomen. That could cause serious or fatal injuries.

The lap portion of the belt should be worn low and snug on the hips, just touching the child's thighs. This applies belt force to the child's pelvic bones in a crash.

Infants and Young Children

Everyone in a vehicle needs protection! This includes infants and all other children. Neither the distance traveled nor the age and size of the traveler changes the need, for everyone, to use safety restraints. In fact, the law in every state in the United States and in every Canadian province says children up to some age must be restrained while in a vehicle.

Every time infants and young children ride in vehicles, they should have the protection provided by appropriate restraints. Young children should not use the vehicle's adult safety belts alone, unless there is no other choice. Instead, they need to use a child restraint.

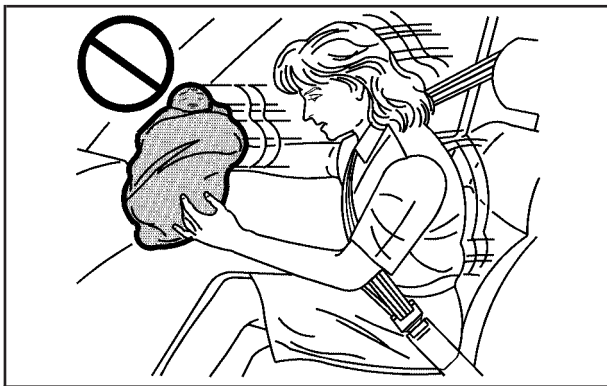

⚠ CAUTION:

People should never hold a baby in their arms while riding in a vehicle. A baby does not weigh much — until a crash. During a crash a baby will become so heavy it is not possible to hold it. For example, in a crash at only 25 mph (40 km/h), a 12 lb (5.5 kg) baby will suddenly become a 240 lb (110 kg) force on a person's arms. A baby should be secured in an appropriate restraint.

⚠ CAUTION:

Children who are up against, or very close to, any airbag when it inflates can be seriously injured or killed. Airbags plus lap-shoulder belts offer protection for adults and older children, but not for young children and infants. Neither the vehicle's safety belt system nor its airbag system is designed for them. Young children and infants need the protection that a child restraint system can provide.

Q: What are the different types of add-on child restraints?

A: Add-on child restraints, which are purchased by the vehicle's owner, are available in four basic types. Selection of a particular restraint should take into consideration not only the child's weight, height and age but also whether or not the restraint will be compatible with the motor vehicle in which it will be used.

For most basic types of child restraints, there are many different models available. When purchasing a child restraint, be sure it is designed to be used in a motor vehicle. If it is, the restraint will have a label saying that it meets federal motor vehicle safety standards.

The restraint manufacturer's instructions that come with the restraint state the weight and height limitations for a particular child restraint. In addition, there are many kinds of restraints available for children with special needs.

 **CAUTION:**

Newborn infants need complete support, including support for the head and neck. This is necessary because a newborn infant's neck is weak and its head weighs so much compared with the rest of its body. In a crash, an infant in a rear-facing seat settles into the restraint, so the crash forces can be distributed across the strongest part of an infant's body, the back and shoulders. Infants always should be secured in appropriate infant restraints.

⚠ CAUTION:

The body structure of a young child is quite unlike that of an adult or older child, for whom the safety belts are designed. A young child's hip bones are still so small that the vehicle's regular safety belt may not remain low on the hip bones, as it should. Instead, it may settle up around the child's abdomen. In a crash, the belt would apply force on a body area that is unprotected by any bony structure. This alone could cause serious or fatal injuries. Young children always should be secured in appropriate child restraints.

Child Restraint Systems

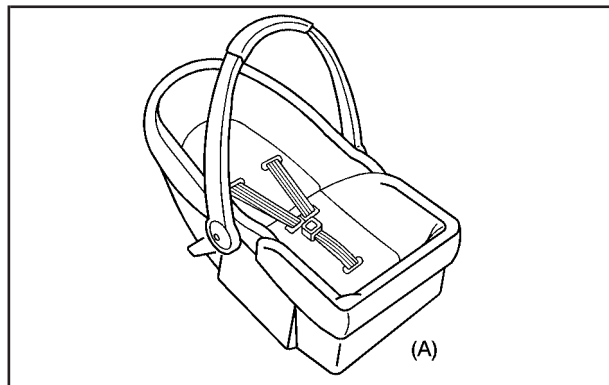

An infant car bed (A), a special bed made for use in a motor vehicle, is an infant restraint system designed to restrain or position a child on a continuous flat surface. Make sure that the infant's head rests toward the center of the vehicle.

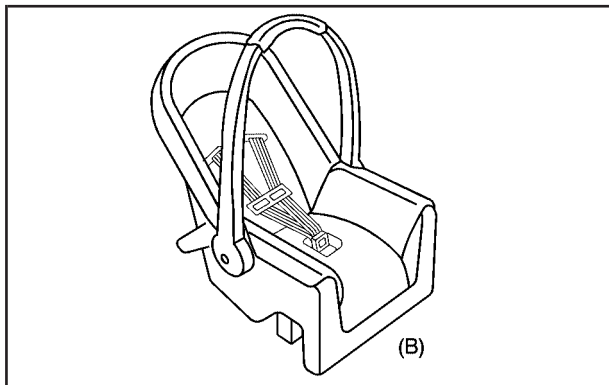

A rear-facing infant seat (B) provides restraint with the seating surface against the back of the infant. The harness system holds the infant in place and, in a crash, acts to keep the infant positioned in the restraint.

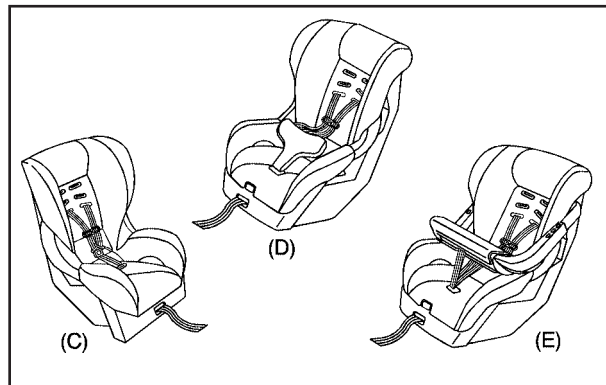

A forward-facing child seat (C-E) provides restraint for the child's body with the harness and also sometimes with surfaces such as T-shaped or shelf-like shields.

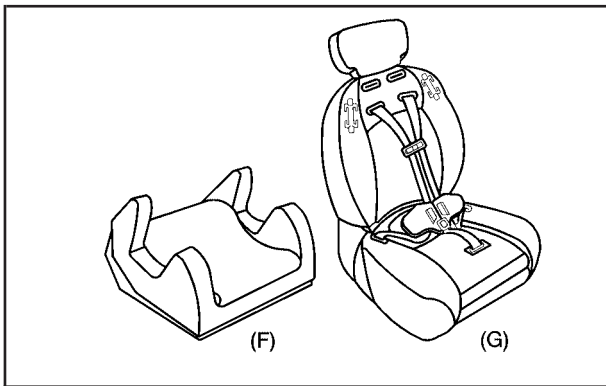

A booster seat (F-G) is a child restraint designed to improve the fit of the vehicle's safety belt system. Some booster seats have a shoulder belt positioner, and some high-back booster seats have a five-point harness. A booster seat can also help a child to see out the window.

Q: How Should I Use a Child Restraint?

A: A child restraint system is any device designed for use in a motor vehicle to restrain, seat, or position children. A built-in child restraint system is a permanent part of the motor vehicle. An add-on child restraint system is a portable one, which is purchased by the vehicle's owner. To help reduce injuries, an add-on child restraint must be secured in the vehicle. With built-in or add-on child restraints, the child has to be secured within the child restraint.

When choosing an add-on child restraint, be sure the child restraint is designed to be used in a vehicle. If it is, it will have a label saying that it meets federal motor vehicle safety standards. Then follow the instructions for the restraint. You may find these instructions on the restraint itself or in a booklet, or both.

Securing an Add-on Child Restraint in the Vehicle

CAUTION:

A child can be seriously injured or killed in a crash if the child restraint is not properly secured in the vehicle. Make sure the child restraint is properly installed in the vehicle using the vehicle's safety belt, following the instructions that came with that restraint, and also the instructions in this manual.

To help reduce the chance of injury, the child restraint must be secured in the vehicle. Child restraint systems must be secured in vehicle seats by lap belts or the lap belt portion of a lap-shoulder belt. A child can be endangered in a crash if the child restraint is not properly secured in the vehicle.

When securing an add-on child restraint, refer to the instructions that come with the restraint which may be on the restraint itself or in a booklet, or both, and to this manual. The child restraint instructions are important, so if they are not available, obtain a replacement copy from the manufacturer.

Keep in mind that an unsecured child restraint can move around in a collision or sudden stop and injure people in the vehicle. Be sure to properly secure any child restraint in your vehicle — even when no child is in it.

Securing the Child Within the Child Restraint

There are several systems for securing the child within the child restraint. One system, the three-point harness, has straps that come down over each of the infant's shoulders and buckle together at the crotch. The five-point harness system has two shoulder straps, two hip straps, and a crotch strap. A shield may take the place of hip straps. A T-shaped shield has shoulder straps that are attached to a flat pad which rests low against the child's body. A shelf- or armrest-type shield has straps that are attached to a wide, shelf-like shield that swings up or to the side.

 **CAUTION:**

A child can be seriously injured or killed in a crash if the child is not properly secured in the child restraint. Make sure the child is properly secured, following the instructions that came with that restraint.

Because there are different systems, it is important to refer to the instructions that come with the restraint. A child can be endangered in a crash if the child is not properly secured in the child restraint.

Lower Anchors and Tethers for Children (LATCH)

Some child restraints have a LATCH system. As part of the LATCH system, your child restraint may have lower attachments and/or a top tether. The LATCH system can help hold the child restraint in place during driving or in a crash. Some vehicles have lower and/or top tether anchors designed to secure a child restraint with lower attachments and/or a top tether.

Some child restraints with a top tether are designed to be used whether the top tether is anchored or not. Other child restraints require that the top tether be anchored. A national or local law may require that the top tether be anchored.

In Canada, the law requires that forward-facing child restraints have a top tether, and that the tether be attached.

Your vehicle does not have lower anchors or top tether anchors to secure a child restraint with the LATCH system. If a national or local law requires that your top tether be anchored, do not use a child restraint in this vehicle because a top tether cannot be properly anchored. You must use the safety belts to secure your child restraint in this vehicle, unless a national or local law requires that the top tether be anchored. Refer to your child restraint instructions and instructions in this manual for securing a child restraint using the vehicle's safety belts.

Securing a Child Restraint in the Passenger Seat Position

Your vehicle has a right front passenger airbag.

In addition, your vehicle has the passenger sensing system. The passenger sensing system is designed to turn off the right front passenger's frontal airbag and side impact airbag when an infant in a rear-facing infant seat or a small child in a forward-facing child restraint or booster seat is detected. See *Passenger Sensing System on page 1-40* and *Passenger Airbag Status Indicator on page 3-52* for more information on this including important safety information.

CAUTION:

A child in a rear-facing child restraint can be seriously injured or killed if the right front passenger's airbag inflates. This is because the back of the rear facing child restraint would be very close to the inflating airbag. Be sure the airbag is off before using a rear-facing child restraint in the right front seat position.

Even though the passenger sensing system is designed to turn off the passenger's airbags if the system detects a rear-facing child restraint, no system is fail-safe, and no one can guarantee that an airbag will not deploy under some unusual circumstance, even though it is turned off. We recommend that rear-facing child restraints be transported in vehicles with a rear seat that will accommodate a rear-facing child restraint, whenever possible.

If you need to secure a forward-facing child restraint in the passenger's position, move the seat as far back as it will go before securing the forward-facing child restraint. See *Power Seats on page 1-2*.

There is no top tether anchor at the passenger's seating position. Do not secure a child seat in this position if a national or local law requires that the top tether be anchored or if the instructions that come with the child restraint say that the top tether must be anchored. See *Lower Anchors and Tethers for Children (LATCH) on page 1-27*.

You will be using the lap-shoulder belt to secure the child restraint in this position. Be sure to follow the instructions that came with the child restraint.

Secure the child in the child restraint when and as the instructions say.

1. Your vehicle has airbags. See *Passenger Sensing System on page 1-40*. General Motors recommends that rear-facing child restraints be secured in a rear seat, even if the airbags are off. If your child restraint is forward-facing, move the seat as far back as it will go before securing the child restraint in this seat. See *Power Seats on page 1-2*.

When the passenger sensing system has turned off the right front passenger's airbags, the off indicator in the passenger airbag status indicator should light and stay lit when the vehicle is started. See *Passenger Airbag Status Indicator on page 3-52*.

2. Put the child restraint on the seat.
3. Pick up the latch plate, and run the lap and shoulder portions of the vehicle's safety belt through or around the restraint. The child restraint instructions will show you how.

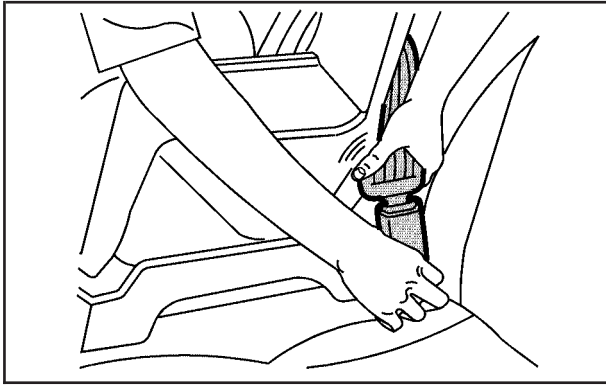

4. Buckle the belt. Make sure the release button is positioned so you would be able to unbuckle the safety belt quickly if you ever had to.

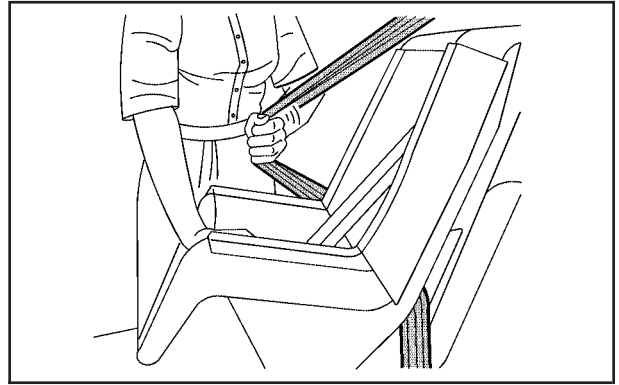

5. Pull the rest of the shoulder belt all the way out of the retractor to set the lock.

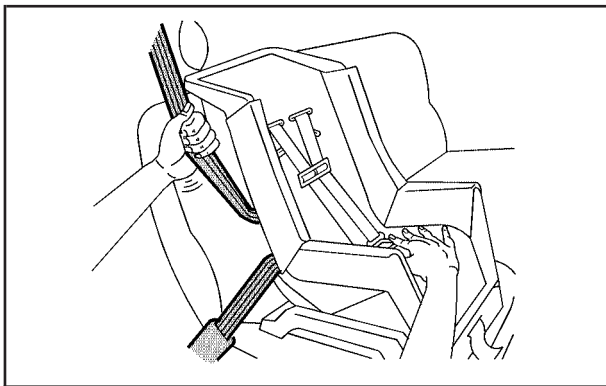

6. To tighten the belt, push down on the child restraint, pull the shoulder portion of the belt to tighten the lap portion of the belt and feed the shoulder belt back into the retractor. If you are using a forward-facing child restraint, you may find it helpful to use your knee to push down on the child restraint as you tighten the belt. You should not be able to pull more of the belt from the retractor once the lock has been set.

7. Push and pull the child restraint in different directions to be sure it is secure.
8. If the airbags are off, the off indicator in the inside rearview mirror will be lit and stay lit when the vehicle is started.

If a child restraint has been installed and the on indicator is lit, turn the vehicle off. Remove the child restraint from the vehicle and reinstall the child restraint.

If after reinstalling the child restraint and restarting the vehicle, the on indicator is still lit, check to make sure that the vehicle's seatback is not pressing the child restraint into the seat cushion. If this happens, slightly recline the vehicle's seatback and adjust the seat cushion if possible.

If the on indicator is still lit, do not secure a child restraint in this vehicle and check with your dealer.

To remove the child restraint, just unbuckle the vehicle's safety belt and let it go back all the way. The safety belt will move freely again and be ready to work for an adult or larger child passenger.

Airbag System

Your vehicle has a frontal airbag for the driver, a frontal airbag for the passenger, a side impact airbag for the driver, and a side impact airbag for the passenger.

Frontal airbags are designed to help reduce the risk of injury from the force of an inflating frontal airbag. But these airbags must inflate very quickly to do their job and comply with federal regulations.

Here are the most important things to know about the airbag system:

CAUTION:

You can be severely injured or killed in a crash if you are not wearing your safety belt — even if you have airbags. Wearing your safety belt during a crash helps reduce your chance of hitting things inside the vehicle or being ejected from it. Airbags are “supplemental restraints” to the safety belts. Airbags are designed to work with safety belts but do not replace them.

CAUTION: (Continued)

CAUTION: (Continued)

Frontal airbags for the driver and passenger are designed to deploy in moderate to severe frontal and near frontal crashes. They are not designed to inflate in rollover, rear crashes, or in many side crashes. And, for some unrestrained occupants, frontal airbags may provide less protection in frontal crashes than more forceful airbags have provided in the past.

Side impact airbags for the driver and passenger are designed to inflate in moderate to severe crashes where something hits the side of your vehicle. They are not designed to inflate in frontal, in rollover or in rear crashes.

Everyone in your vehicle should wear a safety belt properly — whether or not there is an airbag for that person.

 **CAUTION:**

Both frontal and side impact airbags inflate with great force, faster than the blink of an eye. If you are too close to an inflating airbag, as you would be if you were leaning forward, it could seriously injure you. Safety belts help keep you in position for airbag inflation before and during a crash. Always wear your safety belt even with frontal airbags. The driver should sit as far back as possible while still maintaining control of the vehicle. Occupants should not lean on or sleep against the door.

 **CAUTION:**

Anyone who is up against, or very close to, any airbag when it inflates can be seriously injured or killed. Airbags plus lap-shoulder belts offer the best protection for adults, but not for young children and infants. Neither the vehicle's safety belt system nor its airbag system is designed for them. Young children and infants need the protection that a child restraint system can provide. Always secure children properly in your vehicle. To read how, see *Older Children on page 1-18* or *Infants and Young Children on page 1-20*.



There is an airbag readiness light on the instrument panel, which shows the airbag symbol.

The system checks the airbag electrical system for malfunctions. The light tells you if there is an electrical problem. See *Airbag Readiness Light* on page 3-51 for more information.

Where Are the Airbags?



The driver's frontal airbag is in the middle of the steering wheel.



The passenger's frontal airbag is in the instrument panel on the passenger's side.

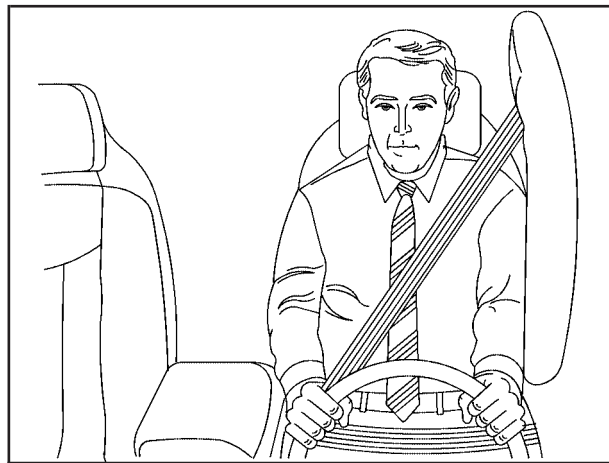

The driver's side impact airbag is in the side of the driver's seatback closest to the door.



The passenger's side impact airbag is in the side of the passenger's seatback closest to the door.

⚠ CAUTION:

If something is between an occupant and an airbag, the airbag might not inflate properly or it might force the object into that person causing severe injury or even death. The path of an inflating airbag must be kept clear. Do not put anything between an occupant and an airbag, and do not attach or put anything on the steering wheel hub or on or near any other airbag covering. Do not let seat covers block the inflation path of a side impact airbag.

When Should an Airbag Inflate?

The driver's and right front passenger's frontal airbags are designed to inflate in moderate to severe frontal or near-frontal crashes. But they are designed to inflate only if the impact exceeds a predetermined deployment threshold. Deployment thresholds take into account a variety of desired deployment and non-deployment events and are used to predict how severe a crash is likely to be in time for the airbags to inflate and help restrain the occupants. Whether your frontal airbags will or should deploy is not based on how fast your vehicle is traveling. It depends largely on what you hit, the direction of the impact and how quickly your vehicle slows down.

In addition, your vehicle has “dual stage” frontal airbags, which adjust the restraint according to crash severity. Your vehicle is equipped with electronic frontal sensors which help the sensing system distinguish between a moderate frontal impact and a more severe frontal impact. For moderate frontal impacts, these airbags inflate at a level less than full deployment. For more severe frontal impacts, full deployment occurs. If the front of your vehicle goes straight into a wall that does not move or deform, the threshold level for the reduced deployment is about 12 to 16 mph (19 to 26 km/h), and the threshold level for a full deployment is about 18 to 24 mph (29 to 38.5 km/h). (The threshold level can vary, however, with specific vehicle design, so that it can be somewhat above or below this range.)

Frontal airbags may inflate at different crash speeds. For example:

- If the vehicle hits a stationary object, the airbags could inflate at a different crash speed than if the vehicle hits a moving object.
- If the vehicle hits an object that deforms, the airbags could inflate at a different crash speed than if the vehicle hits an object that does not deform.
- If the vehicle hits a narrow object (like a pole) the airbags could inflate at a different crash speed than if the vehicle hits a wide object (like a wall).
- If the vehicle goes into an object at an angle the airbags could inflate at a different crash speed than if the vehicle goes straight into the object.

The frontal airbags (driver and right front passenger) are not intended to inflate during vehicle rollovers, rear impacts, or in many side impacts.

The side impact airbags are intended to inflate in moderate to severe side crashes. A side impact airbag will inflate if the crash severity is above the system's designed “threshold level.” The threshold level can vary with specific vehicle design. Side impact airbags are not intended to inflate in frontal or near-frontal impacts, rollovers or rear impacts. A side impact airbag is intended to deploy on the side of the vehicle that is struck.

Vehicles with dual stage airbags are also equipped with seat position sensors which enable the sensing system to monitor the position of the driver's and passenger's seats. The seat position sensor provides information which is used to determine if the airbags should deploy at a reduced level or at full deployment.

In any particular crash, no one can say whether an airbag should have inflated simply because of the damage to a vehicle or because of what the repair costs were. For frontal airbags, inflation is determined by what the vehicle hits, the angle of the impact, and how quickly the vehicle slows down. For side impact airbags, inflation is determined by the location and severity of the impact.

What Makes an Airbag Inflate?

In an impact of sufficient severity, the airbag sensing system detects that the vehicle is in a crash. The sensing system triggers a release of gas from the inflator, which inflates the airbag. The inflator, the airbag and related hardware are all part of the airbag modules inside the steering wheel, the instrument panel, and the side of the front seatbacks closest to the door.

How Does an Airbag Restrain?

In moderate to severe frontal or near frontal collisions, even belted occupants can contact the steering wheel or the instrument panel. In moderate to severe side collisions, even belted occupants can contact the inside of the vehicle. The airbag supplements the protection provided by safety belts. Airbags distribute the force of the impact more evenly over the occupant's upper body, stopping the occupant more gradually. But the frontal airbags would not help you in many types of collisions, including rollovers, rear impacts, and many side impacts, primarily because an occupant's motion is not toward the airbag. Side impact airbags would not help you in many types of collisions, including many frontal or near frontal collisions, and rear impacts, primarily because an occupant's motion is not toward those airbags. Airbags should never be regarded as anything more than a supplement to safety belts, and then only in moderate to severe frontal or near-frontal collisions for the driver's and right front passenger's frontal airbags, and only in moderate to severe side collisions for side impact airbags.

What Will You See After an Airbag Inflates?

After the airbag inflates, it quickly deflates, so quickly that some people may not even realize the airbag inflated. Some components of the airbag module — the steering wheel hub for the driver's airbag, the instrument panel for the passenger's bag, the side of the seatback closest to the door for the driver's and passenger's side impact airbags — may be hot for a short time. The parts of the bag that come into contact with you may be warm, but not too hot to touch. There will be some smoke and dust coming from the vents in the deflated airbags. Airbag inflation does not prevent the driver from seeing out of the windshield or being able to steer the vehicle, nor does it stop people from leaving the vehicle.

CAUTION:

When an airbag inflates, there is dust in the air. This dust could cause breathing problems for people with a history of asthma or other breathing trouble. To avoid this, everyone in the vehicle should get out as soon as it is safe to do so. If you have breathing problems but

CAUTION: (Continued)

CAUTION: (Continued)

cannot get out of the vehicle after an airbag inflates, then get fresh air by opening a window or a door. If you experience breathing problems following an airbag deployment, you should seek medical attention.

In many crashes severe enough to inflate the airbag, windshields are broken by vehicle deformation. Additional windshield breakage may also occur from the passenger airbag.

- Airbags are designed to inflate only once. After an airbag inflates, you will need some new parts for your airbag system. If you do not get them, the airbag system will not be there to help protect you in another crash. A new system will include airbag modules and possibly other parts. The service manual for your vehicle covers the need to replace other parts.
- Your vehicle is equipped with a crash sensing and diagnostic module which records information after a crash. See *Vehicle Data Collection and Event Data Recorders on page 8-9*.
- Let only qualified technicians work on your airbag system. Improper service can mean that an airbag system will not work properly. See your dealer for service.

Passenger Sensing System

Your vehicle has a passenger sensing system. The passenger airbag status indicator will be visible when you start the vehicle. The words ON and OFF or the symbol for on and off, will be visible in the rearview mirror during the system check. When the system check is complete, either the word ON or the word OFF, or the symbol for on or the symbol for off will be visible. See *Passenger Airbag Status Indicator on page 3-52*.



Passenger Airbag Status Indicator – United States

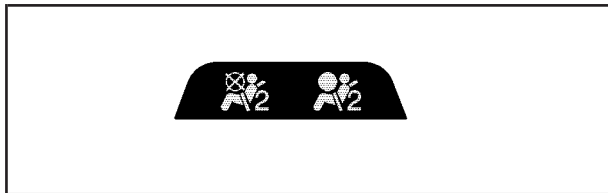

Passenger Airbag Status Indicator – Canada

The passenger sensing system will turn off the right front passenger's frontal airbag and side impact airbag under certain conditions. The driver's airbags are not part of the passenger sensing system.

The passenger sensing system works with sensors that are part of the right front passenger's seat and safety belt. The sensors are designed to detect the presence of a properly seated occupant and determine if the passenger's airbags should be enabled (may inflate) or not.

Accident statistics show that children are safer if they are restrained in the rear rather than the front seat. General Motors recommends that child restraints be secured in a rear seat, including an infant riding in a rear-facing infant seat, a child riding in a forward-facing child seat and an older child riding in a booster seat. Never put a child in a rear-facing child restraint in the right front passenger seat unless the passenger airbag status indicator shows off. Never put a rear-facing child restraint in the right front passenger seat unless the airbags are off.

 **CAUTION:**

A child in a rear-facing child restraint can be seriously injured or killed if the right front passenger's airbag inflates. This is because the back of the rear-facing child restraint would be very close to the inflating airbag. Be sure the airbag is off before using a rear-facing child restraint in the right front seat position.

Even though the passenger sensing system is designed to turn off the passenger's airbags if the system detects a rear-facing child restraint, no system is fail-safe, and no one can guarantee that an airbag will not deploy under some unusual circumstance, even though it is turned off. We recommend that rear-facing child restraints be transported in vehicles with a rear seat that will accommodate a rear-facing child restraint, whenever possible.

If you need to secure a forward-facing child restraint in the right front seat, always move the front passenger seat as far back as it will go. It is better to secure the child restraint in a rear seat.

The passenger sensing system is designed to turn off the right front passenger's frontal airbag and side impact airbag if:

- the right front passenger seat is unoccupied
- the system determines that an infant is present in a rear-facing infant seat
- the system determines that a small child is present in a forward-facing child restraint
- the system determines that a small child is present in a booster seat
- a right front passenger takes his/her weight off of the seat for a period of time
- the right front passenger seat is occupied by a smaller person, such as a child who has outgrown child restraints
- or if there is a critical problem with the airbag system or the passenger sensing system

When the passenger's airbags have been turned off by the passenger sensing system, the off indicator will light and stay lit to remind you that the airbags are off.

If a child restraint has been installed and the on indicator is lit, turn the vehicle off. Remove the child restraint from the vehicle and reinstall the child restraint following the child restraint manufacturer's directions and refer to *Securing a Child Restraint in the Passenger Seat Position on page 1-28*.

If after reinstalling the child restraint and restarting the vehicle, the on indicator is still lit, check to make sure that the vehicle's seatback is not pressing the child restraint into the seat cushion. If this happens, slightly recline the vehicle's seatback and adjust the seat cushion if possible.

If the on indicator is still lit, do not secure the child restraint in this vehicle and check with your dealer.

The passenger sensing system is designed to enable (may inflate) the right front passenger's airbags anytime the system senses that a person of adult size is sitting properly in the right front passenger's seat. When the passenger sensing system has allowed the airbags to be enabled, the on indicator will light and stay lit to remind you that the airbags are active.

For some children who have outgrown child restraints and for very small adults, the passenger sensing system may or may not turn off the right front passenger's airbags, depending upon the person's seating posture and body build. Everyone in your vehicle who has outgrown child restraints should wear a safety belt properly — whether or not there is an airbag for that person.

If a person of adult-size is sitting in the right front passenger's seat, but the off indicator is lit, it could be because that person is not sitting properly in the seat. If this happens, turn the vehicle off and ask the person to place the seatback in the fully upright position, then sit upright in the seat, centered on the seat cushion, with the person's legs comfortably extended. Restart the vehicle and have the person remain in this position for about two minutes. This will allow the system to detect that person and then enable the passenger's airbags.



 **CAUTION:**

If the airbag readiness light in the instrument panel cluster ever comes on and stays on, it means that something may be wrong with the airbag system. If this ever happens, have the vehicle serviced promptly, because an adult-size person sitting in the right front passenger's seat may not have the protection of the airbags. See *Airbag Readiness Light on page 3-51* for more on this, including important safety information.

Aftermarket equipment, such as seat covers, can affect how well the passenger sensing system operates. You may want to consider not using seat covers or other aftermarket equipment if your vehicle has the passenger sensing system. See *Adding Equipment to Your Airbag-Equipped Vehicle on page 1-44* for more information about modifications that can affect how the system operates.

 **CAUTION:**

Stowing of articles under the passenger's seat or between the passenger's seat cushion and seatback may interfere with the proper operation of the passenger sensing system.

Servicing Your Airbag-Equipped Vehicle

Airbags affect how your vehicle should be serviced. There are parts of the airbag system in several places around your vehicle. You do not want the system to inflate while someone is working on your vehicle. Your dealer and the service manual have information about servicing your vehicle and the airbag system. To purchase a service manual, see *Service Publications Ordering Information on page 8-14*.

CAUTION:

For up to 10 seconds after the vehicle is turned off and the battery is disconnected, an airbag can still inflate during improper service. You can be injured if you are close to an airbag when it inflates. Avoid yellow wires, wires wrapped with yellow tape or yellow connectors. They are probably part of the airbag system. Be sure to follow proper service procedures, and make sure the person performing work for you is qualified to do so.

The airbag system does not need regular maintenance.

Adding Equipment to Your Airbag-Equipped Vehicle

Q: Is there anything I might add to the front or sides of the vehicle that could keep the airbags from working properly?

A: Yes. If you add things that change your vehicle's frame, bumper system, front end or side sheet metal or height, they may keep the airbag system from working properly. Also, the airbag system may not work properly if you relocate any of the airbag sensors. If you have any questions about this, you should contact Customer Assistance before you modify your vehicle. The phone numbers and addresses for Customer Assistance are in Step Two of the Customer Satisfaction Procedure in this manual. See *Customer Satisfaction Procedure on page 8-2*.

Q: Because I have a disability, I have to get my vehicle modified. How can I find out whether this will affect my airbag system?

A: Changing or moving any parts of the front seats, safety belts, the airbag sensing and diagnostic module (located under the driver's seat), or the inside rearview mirror can affect the operation of the airbag system. If you have questions, call Customer Assistance. The phone numbers and addresses for Customer Assistance are in Step Two of the Customer Satisfaction Procedure in this manual. See *Customer Satisfaction Procedure* on page 8-2.

Restraint System Check

Checking the Restraint Systems

Now and then, make sure the safety belt reminder light and all your belts, buckles, latch plates, retractors and anchorages are working properly. Look for any other loose or damaged safety belt system parts. If you see anything that might keep a safety belt system from doing its job, have it repaired.

Torn or frayed safety belts may not protect you in a crash. They can rip apart under impact forces. If a belt is torn or frayed, get a new one right away.

Also look for any opened or broken airbag covers, and have them repaired or replaced. (The airbag system does not need regular maintenance.)

Notice: If you damage the covering for the driver's or the passenger's airbag, or the airbag covering on the driver's and passenger's seatback, the airbag may not work properly. You may have to replace the airbag module in the steering wheel, both the airbag module and the instrument panel for the passenger's airbag, or both the airbag module and seatback for the driver's and passenger's side impact airbag. Do not open or break the airbag coverings.

Replacing Restraint System Parts After a Crash

CAUTION:

A crash can damage the restraint systems in your vehicle. A damaged restraint system may not properly protect the person using it, resulting in serious injury or even death in a crash. To help make sure your restraint systems are working properly after a crash, have them inspected and any necessary replacements made as soon as possible.

If you have had a crash, do you need new belts?

After a very minor collision, nothing may be necessary. But if the belts were stretched, as they would be if worn during a more severe crash, then you need new parts.

If belts are cut or damaged, replace them. Collision damage also may mean you will need to have safety belt or seat parts repaired or replaced. New parts and repairs may be necessary even if the belt was not being used at the time of the collision.

If an airbag inflates, you will need to replace airbag system parts. See the part on the airbag system earlier in this section.

If the frontal airbags inflate, you will also need to replace the driver's and passenger's safety belt buckle assembly. Be sure to do so. Then the new buckle assembly will be there to help protect you in a collision.

After a crash you may need to replace the driver and front passenger's safety belt buckle assemblies, even if the frontal airbags have not deployed. The driver and front passenger's safety belt buckle assemblies contain the safety belt pretensioners. Have your safety belt pretensioners checked if your vehicle has been in a collision, or if your airbag readiness light stays on after you start your vehicle or while you are driving. See *Airbag Readiness Light* on page 3-51.

Section 2 Features and Controls

Keys	2-2	Parking Over Things That Burn	2-32
Keyless Access System	2-4	Engine Exhaust	2-33
Keyless Access System Operation	2-5	Running the Engine While Parked	2-33
Doors and Locks	2-9	Mirrors	2-34
Door Locks	2-9	Automatic Dimming Rearview Mirror with	
Power Door Locks	2-11	OnStar®	2-34
Automatic Door Lock	2-11	Outside Power Heated Mirrors	2-35
Programmable Automatic Door Unlock	2-12	Outside Automatic Dimming Mirror	2-35
Lockout Protection	2-12	Outside Curb View Assist Mirror	2-36
Trunk	2-12	Outside Convex Mirror	2-36
Windows	2-15	OnStar® System	2-37
Power Windows	2-16	Universal Home Remote System	2-39
Sun Visors	2-18	Universal Home Remote System Operation	2-40
Theft-Deterrent Systems	2-18	Storage Areas	2-44
Theft-Deterrent System	2-18	Glove Box	2-44
Valet Lockout Switch	2-20	Cupholder(s)	2-44
Starting and Operating Your Vehicle	2-20	Center Console Storage Area	2-44
New Vehicle Break-In	2-20	Map Pocket	2-44
Ignition Positions	2-21	Floor Mats	2-45
Retained Accessory Power (RAP)	2-22	Rear Storage Area	2-45
Starting the Engine	2-22	Convenience Net	2-46
Engine Coolant Heater	2-24	Retractable Hardtop	2-46
Automatic Transmission Operation	2-25	Lowering the Retractable Hardtop	2-47
Parking Brake	2-29	Raising the Retractable Hardtop	2-48
Shifting Into Park (P)	2-30	Vehicle Personalization	2-56
Shifting Out of Park (P)	2-32	Memory Seat, Mirrors and Steering Wheel	2-56

Keys

CAUTION:

Leaving children unattended in a vehicle is dangerous, but it is even more dangerous if the keyless access transmitter is also left in the vehicle. A child or others could be badly injured or even killed.

They could operate the power windows or other controls or even make the vehicle move. If they started the engine and moved the shift lever out of PARK (P), that would release the parking brake.

Do not leave the keyless access transmitter in a vehicle with children.

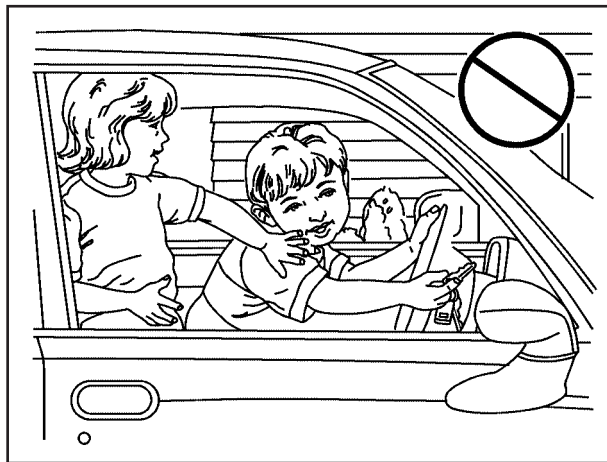

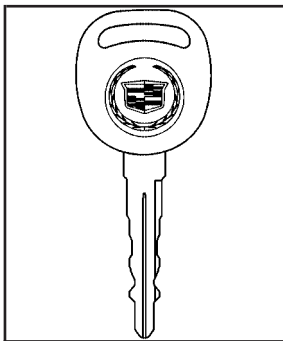

There is a key that works the glove box and can open the trunk if vehicle power is lost. See *Trunk* on page 2-12 for more information.

Your vehicle has a keyless access system with pushbutton start. See *Ignition Positions* on page 2-21 for information on starting the vehicle.

Notice: If you ever lose your transmitter(s) and/or key, it could be difficult to get into your vehicle. You may even have to damage your vehicle to get in. Be sure you have a spare transmitter and/or key.

In an emergency, contact Cadillac Roadside Assistance. See *Roadside Service* on page 8-6.

If your vehicle is equipped with the OnStar[®] system, OnStar[®] may be able to send a command to unlock your vehicle if needed. If the vehicle battery is dead, OnStar[®] will be unable to unlock the vehicle. See *OnStar[®] System* on page 2-37 for more information.

Keyless Access System

Your vehicle has a Keyless Access System that operates on a radio frequency subject to Federal Communications Commission (FCC) Rules and with Industry Canada.

This device complies with Part 15 of the FCC Rules. Operation is subject to the following two conditions:

1. This device may not cause harmful interference.
2. This device must accept any interference received, including interference that may cause undesired operation.

This device complies with RSS-210 of Industry Canada. Operation is subject to the following two conditions:

1. This device may not cause interference.
2. This device must accept any interference received, including interference that may cause undesired operation of the device.

Changes or modifications to this system by other than an authorized service facility could void authorization to use this equipment.

If you ever notice a decrease in the keyless access transmitter range, try doing one of the following:

- Check the distance. You may be too far from your vehicle. You may need to stand closer during rainy or snowy weather.
- Check the location. Other vehicles or objects may be blocking the signal. Take a few steps to the left or right, hold the transmitter higher, and try again.
- Check to determine if battery replacement is necessary. See “Battery Replacement” under *Keyless Access System Operation on page 2-5*.
- Check to make sure that an electronic device such as a cellular phone or lap top computer is not causing interference.
- If you are still having trouble, see your dealer or a qualified technician for service.

Keyless Access System Operation

Your vehicle has a Keyless Access System that allows you to lock and unlock your doors, unlock your trunk lid and disarm or arm your theft-deterrent system. The range distance is as much as 100 feet (30 m) away.

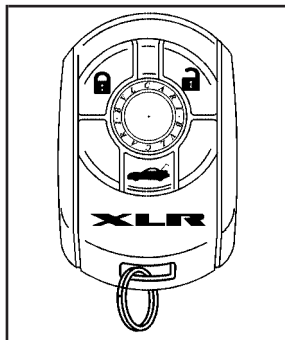

Your vehicle comes with two transmitters, and up to four can be matched to your vehicle. See “Matching Transmitter(s) to Your Vehicle” later in this section.

🔒 (Lock): Press this button to lock the doors. The indicator light on the door will flash once. If this button is pressed twice, the doors will lock, the light will flash once and the horn will sound once.

🔓 (Unlock): Press this button once to unlock the driver's door. The indicator light on the door will flash twice. Press the button twice within 10 seconds to unlock both doors. If it is dark enough outside, your interior lamps will come on.

Your memory settings may also be recalled when you press the unlock button on the keyless access transmitter. See *Memory Seat, Mirrors and Steering Wheel* on page 2-56 for more information.

🚗 (Trunk): Press this button to open the trunk while the engine is turned off or the shift lever is in PARK (P).

Matching Transmitter(s) to Your Vehicle

Each keyless access transmitter is coded to prevent another transmitter from working with your vehicle. If a transmitter is lost or stolen, a replacement can be purchased through your dealer. Remember to bring any remaining transmitters with you when you go to your dealer. Once your dealer has coded the new transmitter, the lost transmitter will not work with your vehicle. Each vehicle can have a maximum of four transmitters matched to it.

To match a new transmitter to your vehicle when you have a recognized transmitter, do the following:

1. The vehicle must be off.
2. Have the recognized and new, unrecognized transmitters on your person.
3. Go to the rear of the vehicle and insert the vehicle key into the key cylinder located on the lower rear fascia on the driver's side of the vehicle. See *Trunk on page 2-12* for more information on the key cylinder.

4. Open the trunk.
5. Turn the key five times within five seconds.
6. The Driver Information Center (DIC) will display READY FOR FOB #X. X can be 2, 3 or 4.
7. Place the new, unrecognized transmitter in the glove box transmitter pocket with the buttons facing to the right.
8. Once the transmitter is programmed, a beep will sound. The DIC will display READY FOR #X, where X can be 3 or 4, or MAX # FOBS LEARNED.
9. Press the ACC button.

The Canadian immobilizer standard requires Canadian owners to see their GM dealer for matching new transmitters when a recognized transmitter is not available. United States owners are permitted to match a new transmitter to their vehicle when a recognized transmitter is not available. The procedure will require three ten minute cycles to complete the matching process. Do the following:

1. The vehicle must be off.
2. Place the new, unrecognized transmitter in the glove box transmitter pocket with the buttons facing to the right.
3. Go to the rear of the vehicle and insert the vehicle key into the key cylinder located on the lower rear fascia on the driver's side of the vehicle.
See *Trunk* on page 2-12 for more information on the key cylinder.
4. Open the trunk.
5. Turn the key five times within five seconds.
6. The DIC message will display OFF-ACC TO LEARN.
7. Press the ACC button.
8. The DIC will read WAIT 10 MINUTES and will count down to zero, one minute at a time.

9. The DIC will display OFF-ACC TO LEARN again.
10. Press the ACC button.
11. The DIC will read WAIT 10 MINUTES and will count down to zero, one minute at a time.
12. The DIC will display OFF-ACC TO LEARN again.
13. Press the ACC button.
14. The DIC will read WAIT 10 MINUTES and will count down to zero, one minute at a time.
15. A beep will sound and the DIC will read READY FOR FOB #1. At this time, all previously known transmitters have been erased.
16. Once the transmitter is recognized and programmed, a beep will sound and the DIC will display READY FOR FOB #2.

If you have additional transmitters to program, take transmitter 1 out of the transmitter pocket and place transmitter 2 in the pocket. This can be done repeatedly until up to four transmitters have been programmed. The DIC will then display MAX # FOBS LEARNED and will exit the programming mode.

When you are done programming transmitters, press the ACC button.

Battery Replacement

Under normal use, the battery in your keyless access transmitter should last about three years.

You can tell the battery is weak if the transmitter will not work at the normal range in any location. If you have to get close to your vehicle before the transmitter works, it is probably time to change the battery.

A weak battery may also cause the DIC to display NO FOBS DETECTED when you try to start the vehicle. If this happens, place the transmitter in the glove box transmitter pocket with the buttons facing to the right. Then, with the vehicle in PARK (P) or NEUTRAL (N), press the brake pedal and the START button. Although this will start the vehicle, it is recommended that you replace the transmitter battery as soon as possible. The DIC may display FOB BATTERY LOW.

Notice: When replacing the battery, use care not to touch any of the circuitry. Static from your body transferred to these surfaces may damage the transmitter.

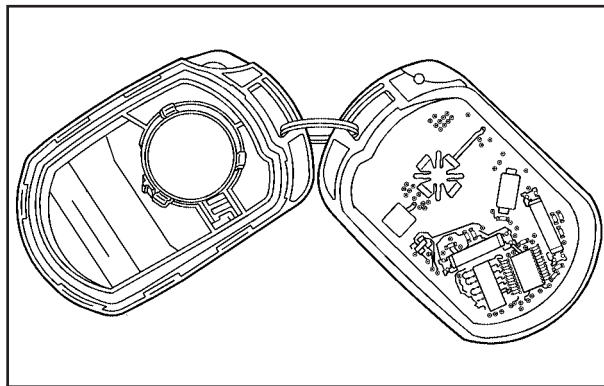

1. Insert a coin or similar object into the slot on the back of the transmitter and gently pry apart the front and back.
2. Gently pull the battery out of the transmitter.
3. Put the new battery in the transmitter, positive (+) side up. Use a battery, type CR2032, or equivalent.
4. Reassemble the transmitter. Make sure to put it together so water will not get in.
5. Test the transmitter.

Doors and Locks

Door Locks

CAUTION:

Unlocked doors can be dangerous.

- **Passengers — especially children — can easily open the doors and fall out of a moving vehicle. When a door is locked it will not open. You increase the chance of being thrown out of the vehicle in a crash if the doors are not locked. So, wear safety belts properly and lock the doors whenever you drive.**
- **Young children who get into unlocked vehicles may be unable to get out. A child can be overcome by extreme heat and can suffer permanent injuries or even death from heat stroke. Always lock your vehicle whenever you leave it.**
- **Outsiders can easily enter through an unlocked door when you slow down or stop your vehicle. Locking your doors can help prevent this from happening.**

To lock or unlock your vehicle from the outside, use the keyless access transmitter and press the appropriate lock or unlock button. You may also unlock and open the door passively when you squeeze the door handle sensor, as long as you have your transmitter with you. Passive entry occurs when the door handle sensor is pressed and the vehicle recognizes your keyless access transmitter. When the passenger door is opened first, the driver's door will also become unlocked.

From the inside, use the power door lock buttons located at the top of the door panel near the window. See *Power Door Locks on page 2-11* for more information.

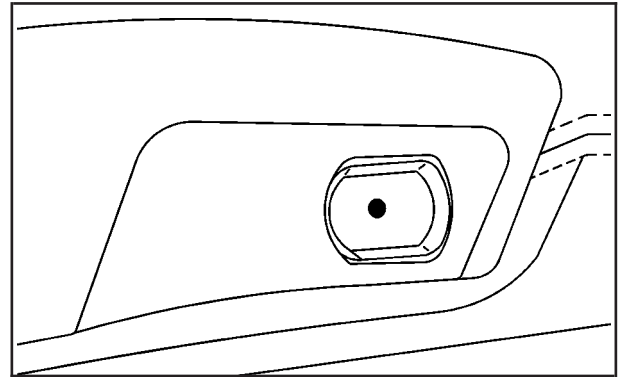

To open a door from the inside, press the button in front of the door handle and push the door open.

If power to the vehicle or the keyless access transmitter is lost, there are two ways to open the door.

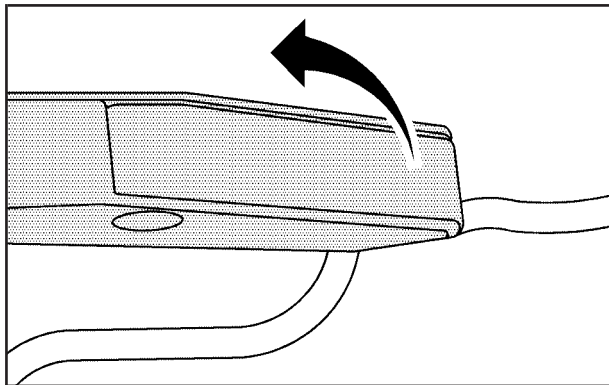

If you are inside the vehicle, use the door release handle located on the floor next to each seat. Pull the handle up to unlock and unlatch the door.

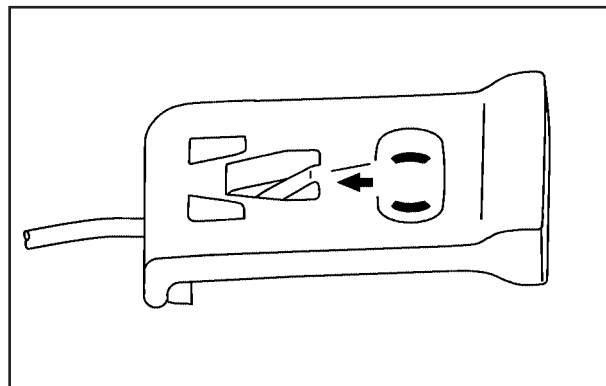

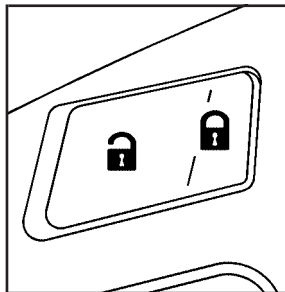

If you are outside the vehicle, there is a door release tab in the trunk. The tab is located behind a panel on the driver's side of the trunk. Pull the handle to unlock and unlatch the driver's door. See *Trunk* on page 2-12 for information on opening the trunk during a loss of power.

Power Door Locks



The power door lock switches are located on the door panels near the windows.

 **(Unlock):** Press this portion of the button to unlock the doors.

 **(Lock):** Press this portion of the button to lock the doors.

There is an indicator light on the rear of the door near the window.

When the lock portion of the button is pressed and the door is closed, a beep will sound and the light will come on for a few seconds, then turn off. If the button is pressed and the door is open, a beep will sound and the light will stay on continuously.

When the unlock portion of the button is pressed and the door is closed, a beep will sound and the light will flash twice. When the button is pressed and the door is open, a beep will sound and the light will flash.

Automatic Door Lock

Your vehicle is programmed so that, when the doors are closed, the ignition is on and the shift lever is moved out of PARK (P), all the doors will lock.

If someone needs to get out while the vehicle is not in PARK (P), have the person use the power door unlock switch. When the door is closed again, the doors will lock either when your foot is removed from the brake or the vehicle speed becomes faster than 8 mph (13 km/h).

Programmable Automatic Door Unlock

Your vehicle is programmed so that, when the shift lever is moved into PARK (P), both doors will unlock.

With the vehicle in PARK (P) and the engine running, door unlocking can be programmed through prompts displayed on the Driver Information Center (DIC). These prompts allow the driver to choose various unlock settings. For programming information, see *DIC Vehicle Personalization on page 3-78*.

Lockout Protection

Your vehicle can be programmed to sound the horn three times and unlock the driver's door when both doors are closed and there is a keyless access transmitter inside the vehicle. When the driver's door is opened, the key in reminder chime will sound continuously. The vehicle will remain locked only when at least one transmitter has been removed from the vehicle and both doors are closed. See *DIC Vehicle Personalization on page 3-78*.

Trunk

CAUTION:

It can be dangerous to drive with the trunk lid open because carbon monoxide (CO) gas can come into your vehicle. You cannot see or smell CO. It can cause unconsciousness and even death. If you must drive with the trunk lid open or if electrical wiring or other cable connections must pass through the seal between the body and the trunk lid:

- **Make sure all other windows are shut.**
- **Turn the fan on your heating or cooling system to its highest speed and select the control setting that will force outside air into your vehicle. See Climate Control System.**
- **If you have air outlets on or under the instrument panel, open them all the way.**

See *Engine Exhaust on page 2-33*.

Trunk Lock Release

CAUTION:

Moving parts of the powered trunk lid can be dangerous. You or others could be injured. Keep yourself and others away from the trunk lid and its mechanism while it is closing.

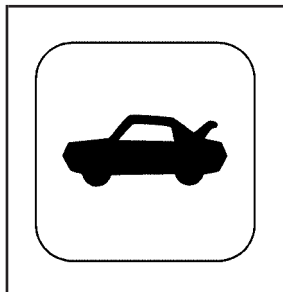

The trunk lock release button is located to the left of the steering wheel on the instrument panel.

Press the button to open the trunk. To use this feature, your vehicle must be in PARK (P) or NEUTRAL (N) and the valet lockout switch must be off.

You can also press the button with the trunk symbol on the keyless access transmitter to open the trunk.

To disable this feature, see “Valet Lockout Switch” under *Theft-Deterrent Systems* on page 2-18.

You may passively enter the trunk when you squeeze the trunk release sensor located on the rear of the trunk lid under the emblem, as long as you have your transmitter with you. The vehicle must be in PARK (P) and the valet lockout switch must be off. See *Valet Lockout Switch* on page 2-20.

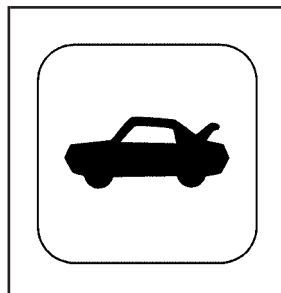

To close the trunk, press the button on the underside of the trunk lid.

To stop the trunk lid while it is closing, do one of the following:

- Press the trunk lock release button located on the instrument panel.
- Use the vehicle key on the rear fascia.
- Squeeze the trunk release sensor located on the rear of the trunk lid.

- Press the button with the trunk symbol on the keyless access transmitter.
- Press the trunk close button on the underside of the trunk lid.

To begin opening the trunk from the stopped position, use any of the methods above, except pressing the trunk close button.

To resume closing the power trunk lid, press the trunk close button on the underside of the trunk lid.

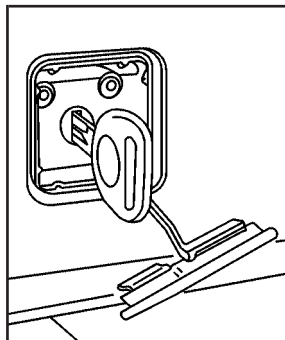

If the vehicle has lost battery power, you can still open the trunk using the key.

The key cylinder is located behind a cover on the lower rear fascia on the driver's side of the vehicle. Use the key to pry open the door to access the key cylinder.

Emergency Trunk Release Handle

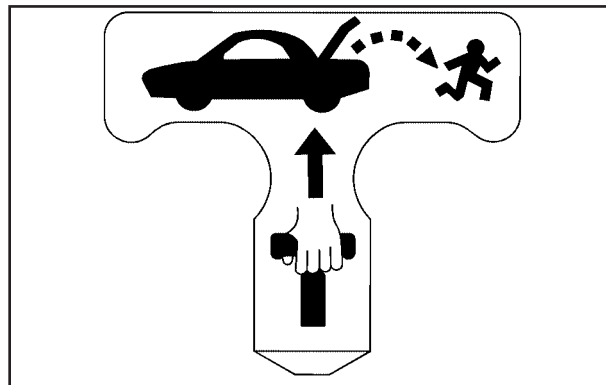

Notice: Do not use the emergency trunk release handle as a tie-down or anchor point when securing items in the trunk as it could damage the handle. The emergency trunk release handle is only intended to aid a person trapped in a latched trunk, enabling them to open the trunk from the inside.

There is a glow-in-the-dark emergency trunk release handle located inside the trunk near the latch. This handle will glow following exposure to light. Pull the release handle and push up on the trunk lid to release the latch from the inside.

Windows

CAUTION:

Leaving children, helpless adults, or pets in a vehicle with the windows closed is dangerous. They can be overcome by the extreme heat and suffer permanent injuries or even death from heat stroke. Never leave a child, a helpless adult, or a pet alone in a vehicle, especially with the windows closed in warm or hot weather.

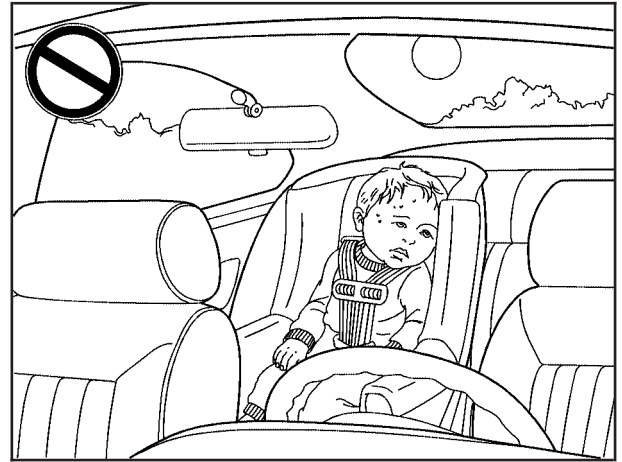

Power Windows

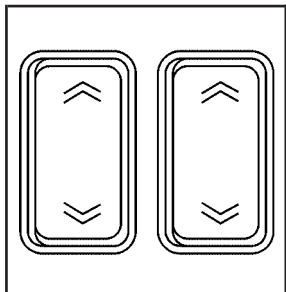

The power window switches are located on each door near the armrest.

Press the up or down arrows on the switches to raise or lower the windows.

Your vehicle has Retained Accessory Power (RAP) that allows you to use the power windows once the ignition has been turned off. For more information, see *Retained Accessory Power (RAP) on page 2-22*.

Power Window Initialize

After a power reconnect such as battery replacement, the express-up and index-up features will not function until the system is initialized. Once power is restored, do the following:

1. Close the door.
2. Raise the window by holding the up arrow on the power window switch.
3. Hold the up arrow for three seconds after the window is closed. Release the switch. Then hold the up arrow again for three seconds.

The express-up system must be initialized to operate the windows with the door open.

Express-Down Window

This feature is on both power windows. Press the down arrow on the switch to the second position to activate the express-down feature. If you want to stop the window as it is lowering, press the switch again.

Express-Up Window

This feature is on both power windows. Press the up arrow on the switch to the second position to activate the express-up feature. If you want to stop the window as it is raising, press the switch again.

Express Window Anti-Pinch Feature

If any object is in the path of the window when the express-up is active, the window will stop at the obstruction and auto-reverse to a preset factory position. Weather conditions such as severe icing may also cause the window to auto-reverse. The window will return to normal operation once the obstruction or condition is removed.

CAUTION:

If express override is activated, the window will not reverse automatically. You or others could be injured and the window could be damaged. Before you use express override, make sure that all people and obstructions are clear of the window path.

Express Window Anti-Pinch Override

In an emergency, the anti-pinch feature can be overridden in a supervised mode. Hold the window switch all the way down in the express position. The window will rise for as long as the switch is held. Once the switch is released, the express mode is re-activated.

In this mode, the window can still close on an object in its path. Use care when using the override mode.

Window Indexing

This feature automatically lowers the window a small amount when the door is opened. Then, when the door is closed, the window will raise to its full up position.

Sun Visors

Notice: Raising or lowering the retractable hardtop with the visor or the visor vanity mirror cover up, may cause damage to the visor or mirror cover. Always return the visor to the center mount or lower the cover on the visor vanity mirror before raising or lowering the retractable hardtop.

Swing down the visor to block out glare. It can also be detached from the center mount and moved to the side.

Lighted Visor Vanity Mirrors

Swing the visor down and lift the cover. The lamp will automatically come on when the cover is opened.

Theft-Deterrent Systems

Vehicle theft is big business, especially in some cities. Although your vehicle has a number of theft-deterrent features, we know that nothing we put on it can make it impossible to steal.

Theft-Deterrent System

Your vehicle is equipped with a theft-deterrent alarm system.

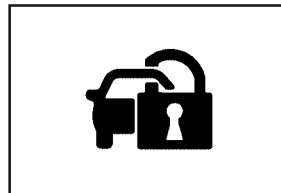

With this system, the security light will flash when the door is open and locked with the power door lock switch.

If this light is on continuously while the engine is running, your vehicle needs service.

Arming the System

Use one of the three following items listed here to arm the system:

- Press the lock button on the keyless access transmitter.
- Open the door. Lock the door with the power door lock switch. The security light should flash. Remove the keyless access transmitter from the interior of the vehicle and close the door. The security light will stop flashing and stay on. After 30 seconds, the light should turn off.
- The vehicle can be programmed to automatically lock the doors and arm the system when you exit the vehicle. See *DIC Vehicle Personalization on page 3-78*.

Now, if a door or the trunk lid is opened without the keyless access transmitter, the alarm will go off. Your horn will sound for two minutes, then it will go off to save battery power. And, your vehicle will not start without a keyless transmitter present.

The theft-deterrent system will not arm if you lock the driver's door with the power door lock switch after the doors are closed.

If your passenger stays in the vehicle when you leave with the keyless access transmitter, have the passenger lock the vehicle after the doors are closed. This way the alarm will not arm, and your passenger will not set it off.

Testing the Alarm

Do the following to test the system:

1. Make sure the trunk lid is latched.
2. Lower the window on the driver's door.
3. Manually arm the system.
4. Close the doors and wait 30 seconds.
5. Reach through the open window and manually pull the release lever on the floor.
6. Turn off the alarm by pressing the unlock button on the transmitter.

If the alarm is inoperative, check to see if the horn works. If not, check the horn fuse. See *Fuses and Circuit Breakers on page 6-80*. If the horn works, but the alarm doesn't go off, see your dealer.

Disarming the System

Always use your keyless access transmitter to unlock a door either by pressing the unlock button on the transmitter or by squeezing the door handle sensor while you have the transmitter with you. Unlocking a door any other way will set off the alarm. If your alarm sounds, press the unlock button on the keyless access transmitter to disarm it.

Valet Lockout Switch

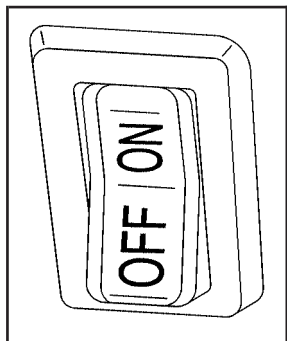

The valet lockout switch is located inside the glove box.

Press the switch to ON to disable the use of the trunk and convertible top. The trunk cannot be opened except by using the key if the valet lockout is on.

Press the switch to OFF to enable the use of the trunk and convertible top.

Locking the glove box with your key will also help to secure your vehicle.

Starting and Operating Your Vehicle

New Vehicle Break-In

Notice: Your vehicle does not need an elaborate break-in. But it will perform better in the long run if you follow these guidelines:

- Keep your speed at 55 mph (88 km/h) or less for the first 500 miles (805 km).
- Do not drive at any one constant speed, fast or slow, for the first 500 miles (805 km). Do not make full-throttle starts. Avoid downshifting to brake, or slow, the vehicle.
- Avoid making hard stops for the first 200 miles (322 km) or so. During this time your new brake linings are not yet broken in. Hard stops with new linings can mean premature wear and earlier replacement. Follow this breaking-in guideline every time you get new brake linings.

Following break-in, engine speed and load can be gradually increased.

Ignition Positions

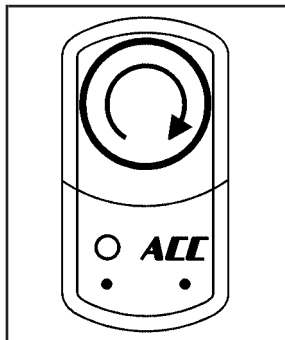

Your vehicle has an electronic keyless ignition with pushbutton start.

Ⓚ (START): Press this button while your foot is on the brake to start the engine. The shifter must be in PARK (P) or NEUTRAL (N) to start the engine and the keyless access transmitter must be in the vehicle for the ignition to work.

○ ACC (OFF/ACCESSORY): When this button is pressed, the engine will turn off even if the shifter is not in PARK (P). If the shifter is in PARK (P), the ignition mode will change to Retained Accessory Power (RAP),

if all doors are closed. The ignition mode will change to OFF, if a front door is opened. See *Retained Accessory Power (RAP) on page 2-22* for more information. If the shifter is not in PARK (P), the ignition mode will change to ACC (Accessory). See *Shifting Into Park (P) on page 2-30*.

When the engine is off, press this button to place the vehicle in accessory mode. ACCESSORY MODE ON will display on the Driver Information Center (DIC). This mode allows you to use things like the radio and the windshield wipers while the engine is off. Use accessory mode if you must have your vehicle in motion while the engine is off, for example, if your vehicle is being towed. If the door is open while in accessory mode, the key in reminder chime will sound continuously.

If the push-button start is not working, your vehicle may be near a strong radio antenna signal causing interference to the keyless access system. See *DIC Warnings and Messages on page 3-67* for more information.

After being in ACC for about 20 minutes, the vehicle will automatically enter RAP or will turn off, depending on if the doors are opened or closed.

Retained Accessory Power (RAP)

The following accessories on your vehicle may be used for up to 10 minutes after the engine is turned off:

- Radio
- Power Windows
- Audio Steering Wheel Controls

Power to these accessories stops after 10 minutes or if a door is opened. If you want power for another 10 minutes, close all the doors and press the ACC button to place the vehicle in accessory mode. Press the button again and the vehicle will return to RAP.

Starting the Engine

Move your shift lever to PARK (P) or NEUTRAL (N). Your engine will not start in any other position — that is a safety feature. To restart when you are already moving, use NEUTRAL (N) only.

The keyless access transmitter must be in the vehicle for the ignition to work.

Notice: Do not try to shift to PARK (P) if your vehicle is moving. If you do, you could damage the transmission. Shift to PARK (P) only when your vehicle is stopped.

1. With your foot on the brake pedal, press the START button located on the instrument panel. If there is not a keyless access transmitter present, the DIC will display NO FOB DETECTED. See *DIC Warnings and Messages on page 3-67* for more information. When the engine begins cranking, let go of the button. The idle speed will go down as your engine gets warm.

If the battery in the keyless access transmitter is weak, the DIC will display FOB BATTERY LOW. You can still drive the vehicle. See “Battery Replacement” under *Keyless Access System Operation on page 2-5* for more information.

Notice: Holding the button in for longer than 15 seconds at a time will cause the vehicle's battery to be drained much sooner. This can also cause damage to the starter motor. Wait 15 seconds between each try to avoid draining your vehicle's battery or damaging the starter.

2. If the engine does not start and no DIC message is displayed, wait 15 seconds before trying again.

Notice: Your engine is designed to work with the electronics in your vehicle. If you add electrical parts or accessories, you could change the way the engine operates. Before adding electrical equipment, check with your dealer. If you do not, your engine might not perform properly. Any resulting damage would not be covered by your vehicle's warranty.

Stopping Your Engine

Move the shift lever to PARK (P) and press the ACC button located on the instrument panel. If the shifter is not in PARK (P), the vehicle will go into the accessory mode, the engine will turn off and the DIC will display SHIFT TO PARK. When the shifter is moved to PARK (P), the vehicle will go into the RAP mode, if all doors are closed. The ignition mode will change to OFF, if a front door is opened. See *Retained Accessory Power (RAP)* on page 2-22 for more information.

If the keyless access transmitter is not detected while going to off, the DIC will display NO FOB – OFF OR RUN?.

See *DIC Warnings and Messages* on page 3-67 for more information.

Engine Coolant Heater

Your vehicle may be equipped with an engine coolant heater.

In very cold weather, 0°F (-18°C) or colder, the engine coolant heater can help. You will get easier starting and better fuel economy during engine warm-up.

Usually, the coolant heater should be plugged in a minimum of four hours prior to starting your vehicle. At temperatures above 32°F (0°C), use of the coolant heater is not required. Your vehicle may also have an internal thermostat in the plug end of the cord. This will prevent operation of the engine coolant heater when the temperature is at or above 0°F (-18°C) as noted on the cord.

To Use the Engine Coolant Heater

1. Turn off the engine.
2. Open the hood and unwrap the electrical cord.
The electrical cord is located on the driver's side of the engine compartment, in front of the engine coolant surge tank.
3. Plug it into a normal, grounded 110-volt AC outlet.

CAUTION:

Plugging the cord into an ungrounded outlet could cause an electrical shock. Also, the wrong kind of extension cord could overheat and cause a fire. You could be seriously injured. Plug the cord into a properly grounded three-prong 110-volt AC outlet. If the cord will not reach, use a heavy-duty three-prong extension cord rated for at least 15 amps.

4. Before starting the engine, be sure to unplug and store the cord as it was before to keep it away from moving engine parts. If you do not, it could be damaged.

How long should you keep the coolant heater plugged in? The answer depends on the outside temperature, the kind of oil you have, and some other things. Instead of trying to list everything here, we ask that you contact your dealer in the area where you will be parking your vehicle. The dealer can give you the best advice for that particular area.

Automatic Transmission Operation



There are several different positions for your shift lever.

PARK (P): This position locks your rear wheels. It is the best position to use when you start your engine because your vehicle cannot move easily.

CAUTION:

It is dangerous to get out of your vehicle if the shift lever is not fully in PARK (P) with the parking brake firmly set. Your vehicle can roll.

Do not leave your vehicle when the engine is running unless you have to. If you have left the engine running, the vehicle can move suddenly. You or others could be injured.

To be sure your vehicle will not move, even when you are on fairly level ground, always set your parking brake and move the shift lever to PARK (P). See *Shifting Into Park (P)* on page 2-30.

Be sure the shift lever is fully in PARK (P) before starting the engine. Your vehicle has an automatic transmission shift lock control system.

You have to fully apply your regular brakes before you can shift from PARK (P) when the vehicle is running. If you cannot shift out of PARK (P), ease pressure on the shift lever and push the shift lever all the way into PARK (P) as you maintain brake application. Then move the shift lever into the gear desired. See *Shifting Out of Park (P)* on page 2-32.

REVERSE (R): Use this gear to back up.

Notice: Shifting to REVERSE (R) while your vehicle is moving forward could damage the transmission. The repairs would not be covered by your warranty. Shift to REVERSE (R) only after your vehicle is stopped.

To rock your vehicle back and forth to get out of snow, ice, or sand without damaging your transmission, see *If Your Vehicle is Stuck in Sand, Mud, Ice or Snow* on page 5-32.

NEUTRAL (N): In this position, your engine does not connect with the wheels. To restart when you are already moving, use NEUTRAL (N) only. Also, use NEUTRAL (N) when your vehicle is being towed.

CAUTION:

Shifting into a drive gear while your engine is running at high speed is dangerous. Unless your foot is firmly on the brake pedal, your vehicle could move very rapidly. You could lose control and hit people or objects. Do not shift into a drive gear while your engine is running at high speed.

Notice: Shifting out of PARK (P) or NEUTRAL (N) with the engine running at high speed may damage the transmission. The repairs would not be covered by your warranty. Be sure the engine is not running at high speed when shifting your vehicle.

AUTOMATIC OVERDRIVE (D): This position is for normal driving.

Notice: Spinning the tires or holding the vehicle in one place on a hill using only the accelerator pedal may damage the transmission. If you are stuck, do not spin the tires. When stopping on a hill, use the brakes to hold the vehicle in place.

Maximum engine speed is limited to protect driveline components from improper operation.

Driver Shift Control (DSC)

The Driver Shift Control (DSC) feature lets you manually control over the operation of the transmission.



To use this feature, move the shift lever from the AUTOMATIC OVERDRIVE (D) position to the left and into the driver shift control gate.

A plus symbol will also appear on the shift console above the AUTOMATIC OVERDRIVE (D) indicator and minus symbol will appear below the indicator.

To request an upshift in DSC, briefly move the shift lever up toward the plus symbol. To request a downshift, briefly move the shift lever down toward the minus symbol. The Head-Up Display (HUD) will display the change in gear, though the actual upshift or downshift may be delayed until the engine speed is correct for that gear.

The gear displays on the HUD until the next time you upshift or downshift.

The gear selected and shown in the HUD is one of a number of gears available. It does not mean that the vehicle will operate only in that specific gear. The actual gear the vehicle shifts to depends on a combination of the driver-requested gear range, vehicle speed and throttle position.

Notice: If you drive your vehicle at high RPMs without upshifting while using Driver Shift Control (DSC), you could damage your vehicle. Always upshift when necessary while using DSC.

If you do not upshift as the engine approaches the red line on the engine rpm gage, the engine speed is controlled to limit the engine rpm.

Not all manual downshift requests will be accepted by the transmission. To prevent excessive engine rpms, each gear has a maximum vehicle speed associated with it. Any downshift request above this speed will not be allowed by the transmission.

If shifting is prevented for any reason, the current gear will flash multiple times in the DIC, indicating that the transmission has not shifted gears.

Some automatic downshifts may occur to maintain minimum engine speed. This only happens the vehicle is left in too high of a gear for the vehicle's speed. For example, if you have been driving in fifth gear range and come to a stop without manually downshifting, fifth gear will continue to display in the HUD. The transmission will automatically downshift to second gear. As you begin to drive and accelerate, the transmission will automatically upshift as quickly as possible to the selected fifth gear.

In higher gears, an automatic downshift will occur if you press the accelerator pedal to the floor. This feature provides adequate acceleration capabilities if you forget to downshift manually.

Automatic upshifts and downshifts will not display in the HUD.

DSC can be used while using cruise control, but transmission shifting will be different while the cruise control is on. This is not a malfunction and is necessary to allow proper operation of the cruise control.

To return to fully automatic operation, move the shift lever to the right and back into the AUTOMATIC OVERDRIVE (D).

When accelerating your vehicle from a stop in snowy and icy conditions, you may want to shift into second gear. A higher gear allows you to gain more traction on slippery surfaces.

Parking Brake



The parking brake pedal is located to the left of the regular brake pedal, near the driver's door.

To set the parking brake, hold the regular brake pedal down with your right foot and push the parking brake pedal down with your left foot.

If the ignition is on, the parking brake indicator light on the instrument panel cluster should come on. If it does not, you need to have your vehicle serviced.

When you move out of PARK (P) or NEUTRAL (N) and the engine is running, the parking brake should release. If the parking brake has not been fully released and you try to drive off with the parking brake on, the parking brake indicator light will come on and stay on.

If the parking brake does not fully release, you can manually release the pedal.

CAUTION:

Always shift to PARK (P) before pulling the manual release lever. If your hand or arm is in the way of the pedal you could be hurt. The pedal springs back quickly. Keep your hand and arm away when you use the manual release lever.

Before releasing the manual parking brake, be sure to put the vehicle in PARK (P) and turn the ignition off.

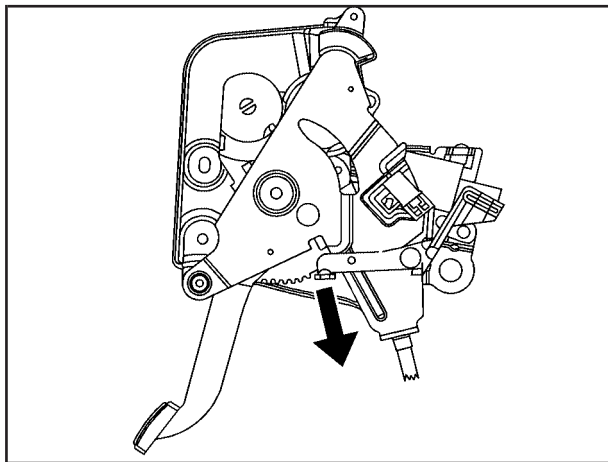

Reach under the driver's side of the instrument panel and pull down on the manual release lever, which is located behind the parking brake pedal. Pull down on the yellow tab. If the parking brake does not release, you should have your vehicle towed to your dealer for service.

Notice: Driving with the parking brake on can overheat the brake system and cause premature wear or damage to brake system parts. Verify that the parking brake is fully released and the brake warning light is off before driving.

Shifting Into Park (P)

CAUTION:

It can be dangerous to get out of your vehicle if the shift lever is not fully in PARK (P) with the parking brake firmly set. Your vehicle can roll. If you have left the engine running, the vehicle can move suddenly. You or others could be injured. To be sure your vehicle will not move, even when you are on fairly level ground, use the steps that follow.

1. Hold the brake pedal down with your right foot and set the parking brake.
2. Move the shift lever into PARK (P) by pushing the lever all the way toward the front of the vehicle.
3. Turn the ignition off.

Leaving Your Vehicle With the Engine Running

CAUTION:

It can be dangerous to leave your vehicle with the engine running. Your vehicle could move suddenly if the shift lever is not fully in PARK (P) with the parking brake firmly set. And, if you leave the vehicle with the engine running, it could overheat and even catch fire. You or others could be injured. Do not leave your vehicle with the engine running.

If you have to leave your vehicle with the engine running, be sure your vehicle is in PARK (P) and your parking brake is firmly set before you leave it. After you have moved the shift lever into PARK (P), hold down the regular brake pedal. See if you can move the shift lever away from PARK (P) without first pulling it toward you. If you can, it means that the shift lever was not fully locked into PARK (P).

Torque Lock

If you are parking on a hill and you do not shift your transmission into PARK (P) properly, the weight of the vehicle may put too much force on the parking pawl in the transmission. You may find it difficult to pull the shift lever out of PARK (P). This is called “torque lock.” To prevent torque lock, set the parking brake and then shift into PARK (P) properly before you leave the driver’s seat. To find out how, see “Shifting Into PARK (P)” listed previously in this section.

When you are ready to drive, move the shift lever out of PARK (P) before you release the parking brake.

If torque lock does occur, you may need to have another vehicle push yours a little uphill to take some of the pressure from the parking pawl in the transmission, so you can pull the shift lever out of PARK (P).

Shifting Out of Park (P)

Your vehicle has an automatic transmission shift lock control system. You have to fully apply your regular brake before you can shift from PARK (P) when the vehicle is running. See *Automatic Transmission Operation on page 2-25*.

If you cannot shift out of PARK (P), ease pressure on the shift lever – push the shift lever all the way into PARK (P) and release the shift lever button as you maintain brake application. Then press the shift lever button and move the shift lever into the gear you wish.

If you ever hold the brake pedal down but still cannot shift out of PARK (P), try this:

1. Press the ACC button twice to place the ignition in accessory mode.
2. Apply and hold the brake until the end of Step 4.
3. Shift to NEUTRAL (N).
4. Start the engine and then shift to the drive gear you want.
5. Have your vehicle inspected by your dealer as soon as possible.

Parking Over Things That Burn

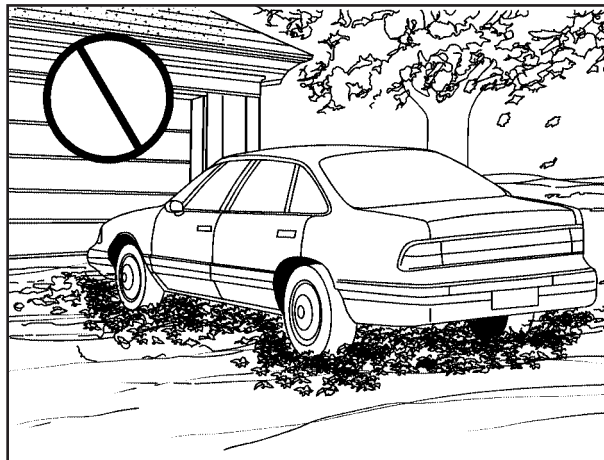

CAUTION:

Things that can burn could touch hot exhaust parts under your vehicle and ignite. Do not park over papers, leaves, dry grass, or other things that can burn.

Engine Exhaust

CAUTION:

Engine exhaust can kill. It contains the gas carbon monoxide (CO), which you cannot see or smell. It can cause unconsciousness and death.

You might have exhaust coming in if:

- Your exhaust system sounds strange or different.
- Your vehicle gets rusty underneath.
- Your vehicle was damaged in a collision.
- Your vehicle was damaged when driving over high points on the road or over road debris.
- Repairs were not done correctly.
- Your vehicle or exhaust system had been modified improperly.

If you ever suspect exhaust is coming into your vehicle:

- Drive it only with all the windows down to blow out any CO; and
- Have your vehicle fixed immediately.

Running the Engine While Parked

It is better not to park with the engine running. But if you ever have to, here are some things to know.

CAUTION:

Idling the engine with the climate control system off could allow dangerous exhaust into your vehicle. See the earlier caution under *Engine Exhaust on page 2-33*.

Also, idling in a closed-in place can let deadly carbon monoxide (CO) into your vehicle even if the climate control fan is at the highest setting. One place this can happen is a garage. Exhaust — with CO — can come in easily. **NEVER** park in a garage with the engine running.

Another closed-in place can be a blizzard. See *Winter Driving on page 5-27*.

 **CAUTION:**

It can be dangerous to get out of your vehicle if the shift lever is not fully in PARK (P) with the parking brake firmly set. Your vehicle can roll. Do not leave your vehicle when the engine is running unless you have to. If you have left the engine running, the vehicle can move suddenly. You or others could be injured. To be sure your vehicle will not move, even when you are on fairly level ground, always set your parking brake and move the shift lever to PARK (P).

Follow the proper steps to be sure your vehicle will not move. See *Shifting Into Park (P)* on page 2-30.

Mirrors

Automatic Dimming Rearview Mirror with OnStar[®]

Your vehicle has an automatic dimming inside rearview mirror. The mirror also contains OnStar[®] controls. For more information about OnStar[®], see *OnStar[®] System* on page 2-37.

 **(On/Off):** This button, located on the lower left side of the mirror, is for the automatic dimming functions.

Mirror Operation

The automatic dimming feature is active each time the vehicle is started.

To turn the automatic dimming feature on or off, press and release the on/off button. The indicator light will illuminate when this feature is active.

Cleaning the Mirror

When cleaning the mirror, use a paper towel or similar material dampened with glass cleaner. Do not spray glass cleaner directly on the mirror as that may cause the liquid cleaner to enter the mirror housing.

Outside Power Heated Mirrors

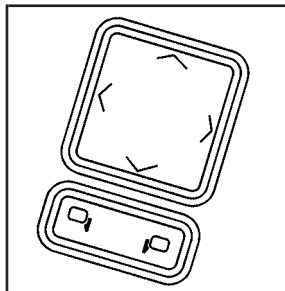

The controls for the outside power mirrors are located on the driver's door armrest.

Move the selector switch, located below the four-way control pad, to the left or the right to choose the driver's side or passenger's side mirror. Use the arrows located on the four-way control pad to adjust the position of the mirror. Adjust each outside mirror so that a little of the vehicle and the area behind it can be seen while sitting in a comfortable driving position. Keep the selector switch in the center position when not adjusting either outside mirror.

Both mirrors have a heated feature to rid them of snow, ice, or condensation. They will heat when the rear window defogger is turned on. See "Rear Window Defogger" under *Dual Climate Control System* on page 3-41. If the vehicle has the memory option, the preferred mirror position can be stored. See *Memory Seat, Mirrors and Steering Wheel* on page 2-56.

Both mirrors can be manually folded inward by pulling them toward the vehicle. This feature may be useful when going through a car wash or a confined space. Push the mirrors away from the vehicle, to the normal position, before driving.

Outside Automatic Dimming Mirror

The driver's side mirror will adjust for the glare of headlamps behind you. This feature is controlled by the on and off settings on the inside automatic dimming rearview mirror. See *Automatic Dimming Rearview Mirror with OnStar®* on page 2-34.

Outside Curb View Assist Mirror

The passenger's side mirror is also capable of performing the curb view assist feature. This feature will cause the mirror to tilt to a factory programmed position when the vehicle is in REVERSE (R).

This feature may be useful in allowing you to view the curb when you are parallel parking.

If further adjustment is needed after the mirror is tilted, the mirror switch may be used. The mirror will then return to this new position when the vehicle is shifted into REVERSE (R).

When the vehicle is shifted out of REVERSE (R) and a five-second delay has occurred, the passenger's side mirror will return to its original position.

This feature can be enabled/disabled through the Driver Information Center (DIC). See "Park Assist" under *DIC Vehicle Personalization on page 3-78* for more information.

Outside Convex Mirror

CAUTION:

A convex mirror can make things (like other vehicles) look farther away than they really are. If you cut too sharply into the right lane, you could hit a vehicle on your right. Check your inside mirror or glance over your shoulder before changing lanes.

The passenger's side mirror is convex. A convex mirror's surface is curved so more can be seen from the driver's seat. It also makes things look farther away than they really are.

OnStar® System

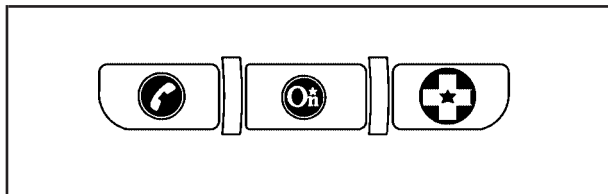

OnStar® uses global positioning system (GPS) satellite technology, wireless communications, and live advisors to provide you with a wide range of safety, security, information, and convenience services. If your airbags deploy, the system is designed to make an automatic call to OnStar® Emergency where we can request emergency services be sent to your location. If you lock your keys in the car, call OnStar® at 1-888-4-ONSTAR and they can send a signal to unlock your doors. If you need roadside assistance, press the OnStar® button and they will get you the help you need.

A complete OnStar® User's Guide and the Terms and Conditions of the OnStar® Subscription Service Agreement are included in the vehicle's glove box literature. For more information, visit www.onstar.com or www.onstar.ca. Contact OnStar® at 1-888-4-ONSTAR (1-888-466-7827), or press the OnStar® button to speak to an OnStar® advisor 24 hours a day, 7 days a week.

Terms and conditions of the Subscription Service Agreement can be found at www.onstar.com or www.onstar.ca.

OnStar® Services

The OnStar® Directions and Connections Plan is included on new vehicles for the first year from the date of purchase. You can extend this plan beyond the first year to meet your needs. For more information, press the OnStar® button to speak with an advisor.

Directions and Connections Plan

- Automatic Notification of Airbag Deployment
- Emergency Services
- Roadside Assistance
- Stolen Vehicle Tracking
- AccidentAssist
- Remote Door Unlock/Vehicle Alert
- Remote Diagnostics
- Online Concierge
- Driving Directions
- RideAssist
- Information and Convenience Services

OnStar® Personal Calling

As an OnStar® subscriber, the Personal Calling capability allows you to make hands-free calls using a wireless system that is integrated into the vehicle. Calls can be placed nationwide using simple voice commands with no additional contracts and no additional roaming charges. To find out more about OnStar® Personal Calling, refer to the OnStar® User's Guide in the vehicle's glove box, visit www.onstar.com or www.onstar.ca, or speak to an OnStar® advisor by pressing the OnStar® button or calling 1-888-4-ONSTAR (1-888-466-7827).

OnStar® Virtual Advisor

Your vehicle may have Virtual Advisor. It is a feature of OnStar® Personal Calling that uses your minutes to access weather, local traffic reports and sports updates. By pressing the phone button and giving a few simple voice commands, you can browse through the various topics. Customize your information profile at www.myonstar.com. See the OnStar® user's guide for more information.

OnStar® Steering Wheel Controls

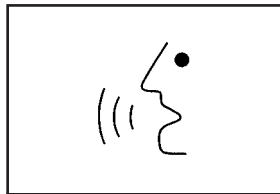

Your vehicle may be equipped with a Talk/Mute button that can be used to interact with OnStar®. See *Audio Steering Wheel Controls* on page 3-84 for more information.

When calling into voice mail systems or to dial directory numbers, press the control, wait for the “number please” response, say the number(s) to be dialed, wait for the number(s) to be repeated and then say “dial.”

See the OnStar® User's Guide for more information.

Universal Home Remote System

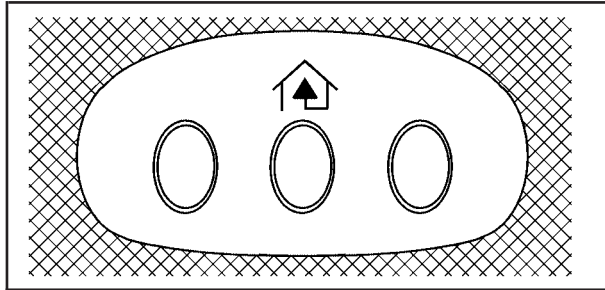

The control buttons, for the Universal Home Remote System, are located on the driver's sun visor.

The Universal Home Remote System, a combined universal transmitter and receiver, provides a way to replace up to three hand-held transmitters used to activate devices such as gate operators, garage door openers, entry door locks, security systems, and home lighting.

If your vehicle is equipped with the Universal Home Remote Transmitter, it complies with Part 15 of the FCC Rules. Operation is subject to the following two conditions: (1) this device may not cause harmful interference, and (2) this device must accept any interference received, including interference that may cause undesired operation.

This device complies with RSS-210 of Industry Canada. Operation is subject to the following two conditions: (1) this device may not cause interference, and (2) this device must accept any interference, including interference that may cause undesired operation of the device.

Changes and modifications to this system by other than an authorized service facility could void authorization to use this equipment.

Universal Home Remote System Operation

Do not use the Universal Home Remote with any garage door opener that does not have the “stop and reverse” feature. This includes any garage door opener model manufactured before April 1, 1982. If you have a newer garage door opener with rolling codes, please be sure to follow Steps 6 through 8 to complete the programming of your Universal Home Remote Transmitter.

Read the instructions completely before attempting to program the Universal Home Remote. Because of the steps involved, it may be helpful to have another person available to assist you in the programming steps.

Keep the original hand-held transmitter for use in other vehicles as well as for future Universal Home Remote programming. It is also recommended that upon the sale of the vehicle, the programmed Universal Home Remote buttons should be erased for security purposes. See “Erasing Universal Home Remote Buttons” later in this section or, for assistance, see *Customer Assistance Offices on page 8-4*.

Be sure that people and objects are clear of the garage door or gate operator you are programming. When programming a garage door, it is advised to park outside of the garage.

It is recommended that a new battery be installed in your hand-held transmitter for quicker and more accurate transmission of the radio-frequency signal.

Programming Universal Home Remote

Follow these steps to program up to three channels:

1. Press and hold down the two outside Universal Home Remote buttons, releasing only when the Universal Home Remote indicator light begins to flash, after 20 seconds. Do not hold down the buttons for longer than 30 seconds and do not repeat this step to program a second and/or third hand-held transmitter to the remaining two Universal Home Remote buttons.
2. Position the end of your hand-held transmitter about 1 to 3 inches (3 to 8 cm) away from the Universal Home Remote buttons while keeping the indicator light in view.
3. Simultaneously press and hold both the desired Universal Home Remote button and the hand-held transmitter button. Do not release the buttons until Step 4 has been completed.

Some entry gates and garage door openers may require you to substitute Step 3 with the procedure noted in “Gate Operator and Canadian Programming” later in this section.

4. The indicator light will flash slowly at first and then rapidly after Universal Home Remote successfully receives the frequency signal from the hand-held transmitter. Release both buttons.
5. Press and hold the newly-trained Universal Home Remote button and observe the indicator light.
If the indicator light stays on constantly, programming is complete and your device should activate when the Universal Home Remote button is pressed and released.
To program the remaining two Universal Home Remote buttons, begin with Step 2 under “Programming Universal Home Remote.” Do not repeat Step 1 as this will erase all of the programmed channels.
If the indicator light blinks rapidly for two seconds and then turns to a constant light, continue with Steps 6 through 8 following to complete the programming of a rolling-code equipped device, most commonly, a garage door opener.
6. Locate in the garage, the garage door opener receiver (motor-head unit). Locate the “Learn” or “Smart” button. This can usually be found where the hanging antenna wire is attached to the motor-head unit.

7. Firmly press and release the “Learn” or “Smart” button. The name and color of the button may vary by manufacturer.

You will have 30 seconds to start Step 8.

8. Return to the vehicle. Firmly press and hold the programmed Universal Home Remote button for two seconds, then release. Repeat the press/hold/release sequence a second time, and depending on the brand of the garage door opener, or other rolling code device, repeat this sequence a third time to complete the programming.

The Universal Home Remote should now activate your rolling-code equipped device.

To program the remaining two Universal Home Remote buttons, begin with Step 2 of “Programming Universal Home Remote.” You do not want to repeat Step 1, as this will erase all previous programming from the Universal Home Remote buttons.

Gate Operator and Canadian Programming

Canadian radio-frequency laws require transmitter signals to time out or quit after several seconds of transmission. This may not be long enough for Universal Home Remote to pick up the signal during programming. Similarly, some U.S. gate operators are manufactured to time out in the same manner.

If you live in Canada, or you are having difficulty programming a gate operator or garage door opener by using the “Programming Universal Home Remote” procedures, regardless of where you live, replace Step 3 under “Programming Universal Home Remote” with the following:

Continue to press and hold the Universal Home Remote button while you press and release every two seconds (cycle) the hand-held transmitter button until the frequency signal has been successfully accepted by the Universal Home Remote. The Universal Home Remote indicator light will flash slowly at first and then rapidly. Proceed with Step 4 under “Programming Universal Home Remote” to complete.

Using Universal Home Remote

Press and hold the appropriate Universal Home Remote button for at least half of a second. The indicator light will come on while the signal is being transmitted.

Erasing Universal Home Remote Buttons

To erase programming from the three Universal Home Remote buttons do the following:

1. Press and hold down the two outside buttons until the indicator light begins to flash, after 20 seconds. Do not hold the two outside buttons for longer than 30 seconds.
2. Release both buttons.

The Universal Home Remote is now in the train (learning) mode and can be programmed at any time beginning with Step 2 under “Programming Universal Home Remote” shown earlier in this section.

Individual buttons cannot be erased, but they can be reprogrammed. See “Reprogramming a Single Universal Home Remote Button” following this section.

Reprogramming a Single Universal Home Remote Button

To program a device to Universal Home Remote using a Universal Home Remote button previously trained, follow these steps:

1. Press and hold the desired Universal Home Remote button. Do not release the button.
2. The indicator light will begin to flash after 20 seconds. While still holding the Universal Home Remote button, proceed with Step 2 under “Programming Universal Home Remote” shown earlier in this section.

For additional information on Universal Home Remote, see *Customer Assistance Offices on page 8-4*.

Storage Areas

Glove Box

To open the glove box, lift up on the lever. The glove box has a light inside. Use the key to lock and unlock.

Cupholder(s)

The cupholders are located under a lid in the front console to the right of the shift lever. Press the left side of the lid and it will open automatically.

Center Console Storage Area

There is a center console storage area located between the seats. To open this storage area, push the latch button and lift the lid.

There is also an upright center console storage area between the seatbacks. To open the storage area, press and release the button near the top so it extends out. Then, turn the button in either direction to unlatch the lid and pull the console lid down. After you close the lid, press the release button back in.

Map Pocket

The map/storage pockets are located on each door behind a cover.

Floor Mats

The driver's side floor mat is held in place by two snaps and the passenger's side is held in place by one.

Remove and Replace the Floor Mats

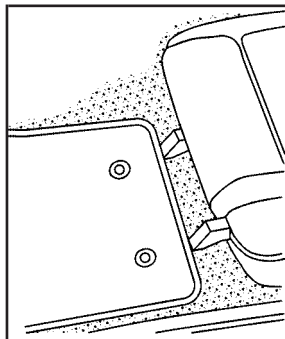

To remove the floor mats, pull up on the rear of the mat to disconnect from the snaps.

To reinstall the floor mats, line up the openings in the floor mat over the snaps and push down into place.

Be sure that the driver's side floor mat is properly placed on the floor so that it does not block the movement of the accelerator pedal.

Rear Storage Area

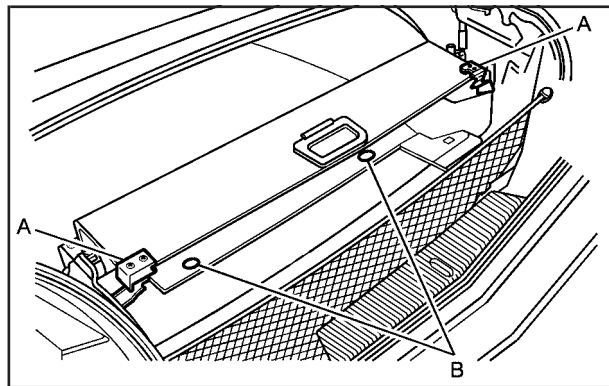

There is a cargo divider located in the trunk to keep cargo from getting in the way of the retractable hardtop. The cargo divider must be in place for the top to move.

To install the cargo divider, snap the bottom of the divider onto the snaps (B) located on the floor of the trunk. Then, swing the divider up and place the pins on each side of the divider into the notches (A) on either side of the trunk.

There is also a storage compartment located in the trunk on the passenger's side.

To access the storage compartment, unsnap the lid. To reinstall the lid, line up the opening in the lid over the snap and push down into place.

Convenience Net

Your vehicle is equipped with a convenience net. The convenience net attaches to the floor of the trunk. Put small loads, like grocery bags, behind the net.

The net is not for larger, heavier loads. Store them in the trunk as far forward as you can. When not using the net, hook the net to the tabs securing it to the sill plate.

Retractable Hardtop

The following procedures explain the proper operation of the retractable hardtop. The retractable hardtop will not operate if the valet lockout switch is on.

If the retractable hardtop is lowered or raised multiple times, the engine should be running while doing so to prevent drain on the vehicle's battery.

CAUTION:

Moving parts of the retractable hardtop can be dangerous. People can be injured by the hardtop and its mechanism. Keep people away from your vehicle when you are lowering or raising the top.

Lowering the Retractable Hardtop

Notice: Leaving the retractable hardtop down and exposing the interior of your vehicle to outdoor conditions may cause damage. Always close the retractable hardtop if leaving your vehicle outdoors.

1. Park on a level surface and shift the transmission into PARK (P).
2. The vehicle's engine must be on or in ACC.
3. Lower both sun visors.

Notice: Raising or lowering the top while the vehicle is in motion can cause damage to the top or top mechanism. Make sure the vehicle is in PARK (P) to lower or raise the top.

Notice: Lowering the top if it is damp, wet, or dirty can cause stains, mildew, and damage to the inside of your vehicle. Dry off the top before lowering it.

4. Make sure that nothing or no one is on or around the top. Make sure the trunk cargo cover is in place with nothing on top or in front of the cargo cover. See *Rear Storage Area on page 2-45* for more information. Also, make sure the valet lockout switch is off.

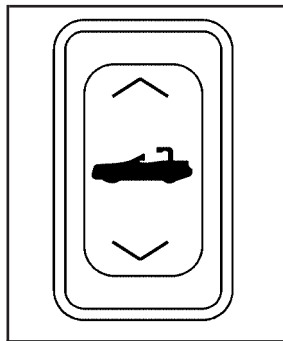

5. Push and hold the bottom of the retractable hardtop button located on the console behind the shifter lever. The windows will automatically lower and the top will automatically lower into the storage area. A chime will sound when the top has lowered completely.

If the radio is on, the sound may be muted briefly while the retractable top is lowered. This occurs because a new audio system equalization is being loaded.

Under certain conditions, the Driver Information Center (DIC) may display a message regarding the retractable hardtop. If this happens, see *DIC Warnings and Messages on page 3-67* for more information.

Raising the Retractable Hardtop

1. Park on a level surface. Shift the transmission into PARK (P).
2. The vehicle's engine must be on or in ACC.
3. Lower both sun visors.

Notice: Raising or lowering the top while the vehicle is in motion can cause damage to the top or top mechanism. Make sure the vehicle is in PARK (P) to lower or raise the top.

4. Make sure nothing or no one is on or around the top. Make sure the trunk cargo cover is in place with no cargo on top of or in front of the cargo cover. See *Rear Storage Area on page 2-45* for more information. Also, be sure the valet lockout switch is off.

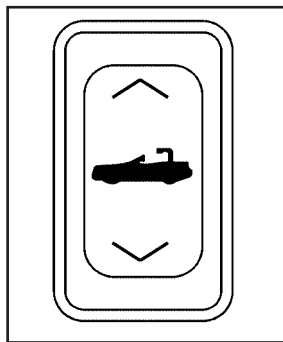

5. Push and hold the top of the retractable hardtop button located behind the shift lever. The windows will automatically lower and the top will raise. A chime will sound when the top has raised completely.

After the top is fully raised, release the retractable hardtop button. If you press the button again within five seconds, the windows will automatically close.

If your radio is on, you may notice a brief mute in sound. This is normal and due to a new audio system equalization being loaded for the vehicle with the top raised.

Under certain conditions, the Driver Information Center (DIC) may display a message regarding the retractable hardtop. If this happens, see *DIC Warnings and Messages on page 3-67* for more information.

Manually Raising the Retractable Hardtop

If your vehicle has a power loss, such as a dead battery, you can still raise the top manually by doing the following:

1. Lower both sun visors and open both doors.
2. Use the key to open the trunk. See *Keys on page 2-2* and *Trunk on page 2-12* for more information.
3. Raise the trunk by hand.
4. Remove the wrench located inside the passenger's side storage compartment.

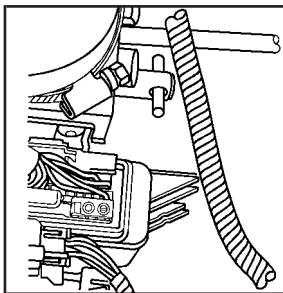

5. Find the hydraulic pump under the carpet on the rear driver's side of the trunk. Open the valve by turning it counterclockwise with your hand until it stops.

Notice: Pressing the retractable hardtop button when the hydraulic pump valve is open could damage the pump. Always close the hydraulic pump valve after the retractable hardtop has been closed manually.

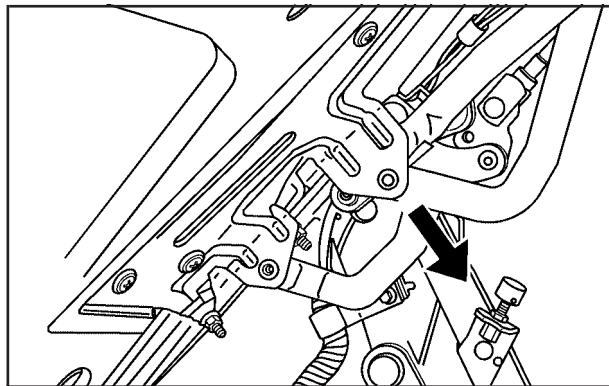

6. Pull both sides of the rear tonneau over-center link down to unlock the linkage.

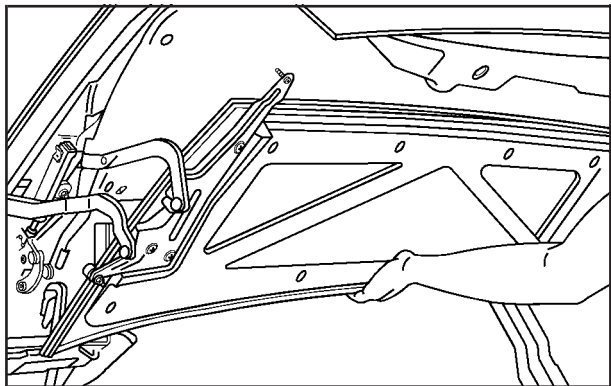

7. Move the rear tonneau rearward and up to the stored position. Pull from the center of the tonneau to keep pressure even. The rubber bumper on each corner will fit against the underside of the trunk decklid.

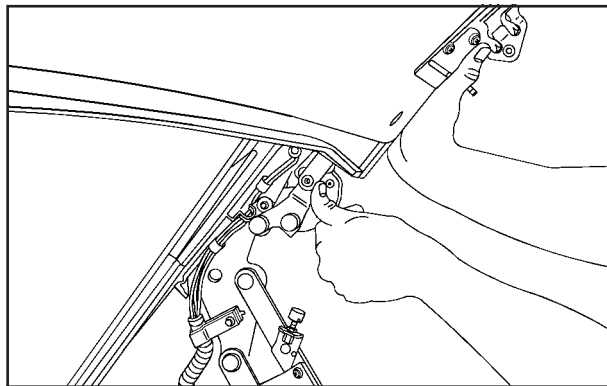

8. Push both sides of the rear tonneau over-center link up until they stop to lock the linkage.
9. Close the hydraulic pump valve by turning it clockwise with your hand until it stops.

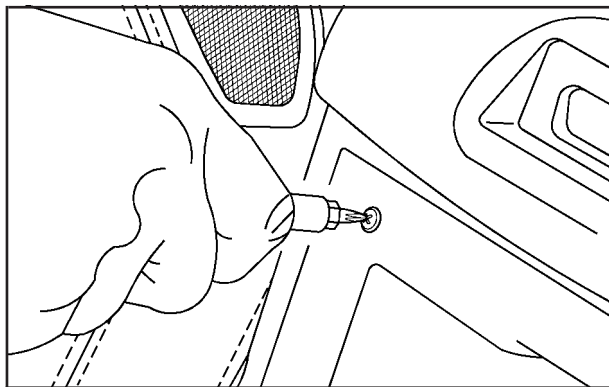

10. Remove the upright center storage compartment. Use the wrench to remove the four screws holding the storage area in place.

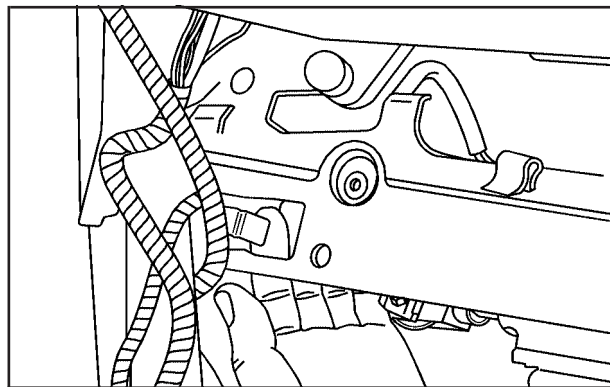

11. Reach behind the square hole and push the front tonneau over-center link up. The front tonneau should pull up easily. If it does not, push the over-center link up more.

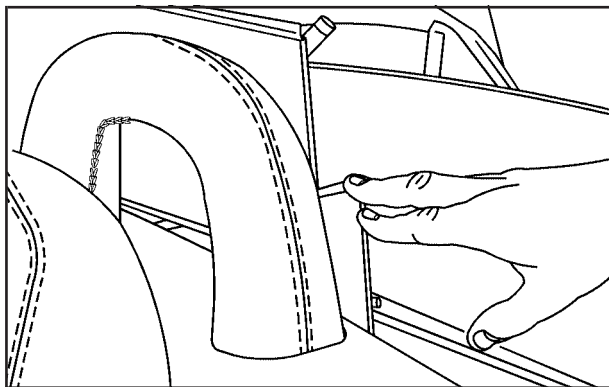

12. Manually move the front tonneau to the open position. Once the front tonneau is open, fold the side wings in by gently pressing them in. Do not force the wings. If they are hard to move, make sure the front tonneau is open all the way.

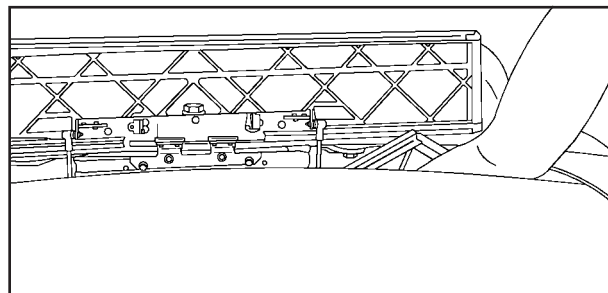

13. Reach in from the side of the vehicle and under the top to remove the headliner plug. The plug will be located in the center of the top near the front.
14. Insert the wrench into the bolt beneath the plug location. Turn the wrench about one-quarter turn counterclockwise until it stops while gently pulling up on the center of the top to release it.

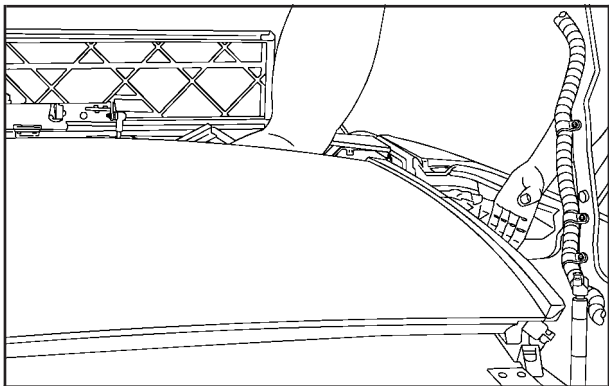

15. Hold the top in the front and side and lift the top out of the stored position.

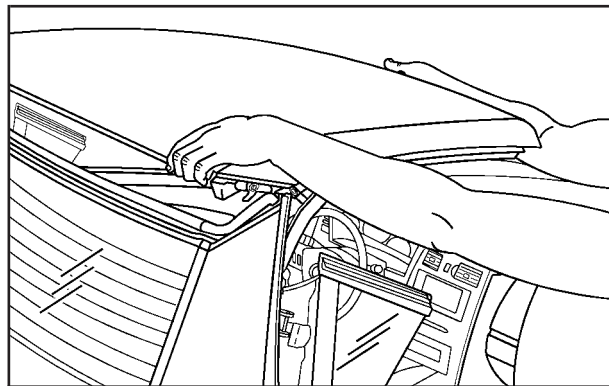

16. Hold the top in the front and the rear and lift the top until it is almost closed. Be careful not to pinch your fingers between the rear of the top and the rear window.

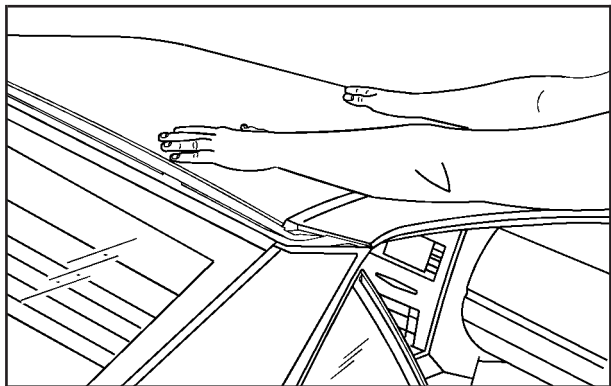

17. Place your hands on the top and guide the top into the closed position.

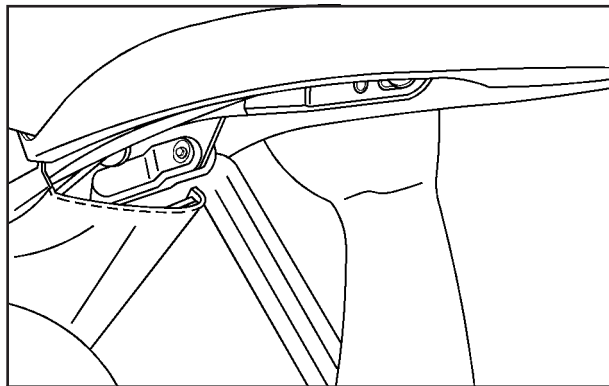

18. While sitting in the driver's seat, pull down on the rear of the top.

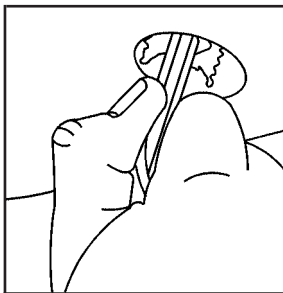

19. While holding the rear of the top down, insert the wrench into the bolt in the plug opening in the headliner. Turn the wrench counterclockwise until it stops to fully open the latch jaws around the pins.

20. Pull down on the roof with the latch rotated open. Turn the wrench clockwise until it stops to lock the top into position. Push up on the roof. If it moves away from the windshield header it is not latched and you will need to repeat the previous steps.

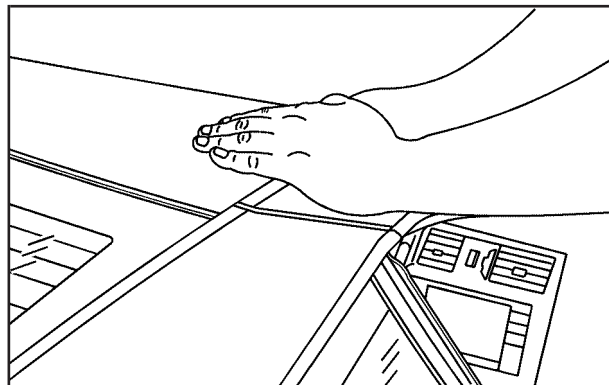

21. From outside the vehicle, push down on both rear corners of the top to make sure it is completely locked into place.
22. From inside the vehicle, reach behind the headrest and gently pull the wings out a small amount. Then, fold the front tonneau to the closed position.
23. Manually close the trunk.

Vehicle Personalization

In addition to the following features, your vehicle may also have features that can be programmed through the Driver Information Center (DIC). See *DIC Vehicle Personalization on page 3-78* for more information.

Memory Seat, Mirrors and Steering Wheel

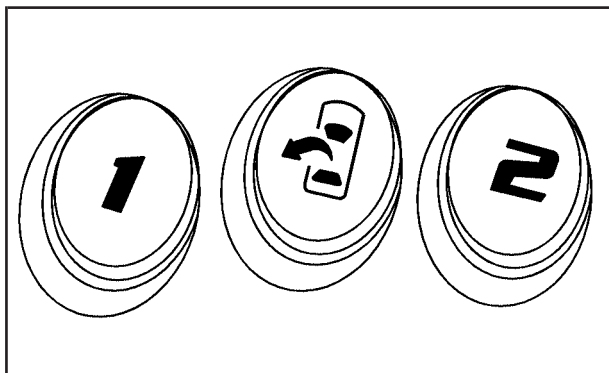

Your vehicle is equipped with the memory package. The controls for these features are located on the driver's seat, and are used to program and recall memory settings for the driver's seating positions.

Use the following steps to program each button:

1. Adjust the driver's seat including the seatback recliner, lumbar and head restraint, both outside mirrors and the steering wheel to a comfortable position.
2. Press and hold button 1 until two beeps are heard, then release the button.

A second mirror, seating and steering wheel position can be programmed by repeating the above steps and pressing button 2 (for driver 2). Each time a memory button is pressed and released, a single beep will sound. Each time button 1 or 2 is pressed and released while the vehicle is in PARK (P), the memory positions will be recalled after a brief delay. If the vehicle is not in PARK (P), three beeps will be heard and the memory position will not be recalled.

When the engine is started, the seat, mirrors, and steering wheel may automatically adjust to their programmed positions.

To stop recall movement of the memory feature at any time, press one of the power seat controls, power mirror control buttons, memory buttons, or power steering column control.

Two personalized exit positions can be set by first recalling the driving position (by pressing 1 or 2), then positioning the steering wheel and seat in the desired exit positions and then pressing and holding the exit button until two beeps are heard. The exit button is located between buttons 1 and 2. With the vehicle in PARK (P), the exit position for the previously set driver can be recalled by pressing the exit button.

When you use the keyless access transmitter to unlock your vehicle, automatic seat and steering wheel movement to the exit position may occur. The numbers on the back of the transmitter, 1 and 2, corresponds to the numbers on the memory buttons.

Further programming for automatic seat and mirror movement can be done using the Driver Information Center (DIC).

For programming information, see *DIC Vehicle Personalization* on page 3-78.

Section 3 Instrument Panel

Instrument Panel Overview	3-4	Courtesy Lamps	3-33
Hazard Warning Flashers	3-6	Entry/Exit Lighting	3-33
Other Warning Devices	3-6	Reading Lamps	3-33
Horn	3-6	Battery Run-Down Protection	3-34
Power Tilt Wheel and Telescopic Steering Column	3-6	Head-Up Display (HUD)	3-34
Turn Signal/Multifunction Lever	3-7	Ultrasonic Rear Parking Assist (URPA)	3-38
Turn and Lane-Change Signals	3-7	Accessory Power Outlet(s)	3-40
Headlamp High/Low-Beam Changer	3-8	Ashtray(s) and Cigarette Lighter	3-41
Flash-to-Pass	3-8	Climate Controls	3-41
Windshield Wipers	3-9	Dual Climate Control System	3-41
Rainsense™ Wipers	3-10	Outlet Adjustment	3-47
Windshield Washer	3-11	Passenger Compartment Air Filter	3-47
Headlamp Washer	3-11	Warning Lights, Gages, and Indicators	3-48
Cruise Control	3-12	Instrument Panel Cluster	3-49
Adaptive Cruise Control	3-15	Speedometer and Odometer	3-50
Exterior Lamps	3-28	Trip Odometer	3-50
Wiper Activated Headlamps	3-29	Tachometer	3-50
Headlamps on Reminder	3-29	Safety Belt Reminder Light	3-50
Daytime Running Lamps (DRL)	3-30	Airbag Readiness Light	3-51
Adaptive Forward Lighting System	3-31	Passenger Airbag Status Indicator	3-52
Fog Lamps	3-31	Voltmeter Gage	3-54
Twilight Sentinel®	3-32	Brake System Warning Light	3-54
Exterior Lighting Battery Saver	3-33	Anti-Lock Brake System Warning Light	3-55
Instrument Panel Brightness	3-33	Traction Control System (TCS) Warning Light	3-56

Section 3 Instrument Panel

Engine Coolant Temperature Gage	3-57	Trip Computer	3-82
Tire Pressure Light	3-57	Oil Life Indicator	3-82
Malfunction Indicator Lamp	3-58	Audio System(s)	3-82
Engine Oil Pressure Gage	3-61	Theft-Deterrent Feature	3-84
Security Light	3-62	Audio Steering Wheel Controls	3-84
Fog Lamp Light	3-62	Radio Reception	3-85
Lights On Reminder	3-62	Care of Your CDs	3-86
Highbeam On Light	3-62	Care of the CD Player	3-86
Fuel Gage	3-63	Diversity Antenna System	3-86
Driver Information Center (DIC)	3-64	XM™ Satellite Radio Antenna System	
DIC Controls and Displays	3-64	(Trunk Mounted)	3-86
DIC Warnings and Messages	3-67	XM™ Satellite Radio Antenna System	
Other Messages	3-77	(Diversity System)	3-86
DIC Vehicle Personalization	3-78		

Instrument Panel Overview

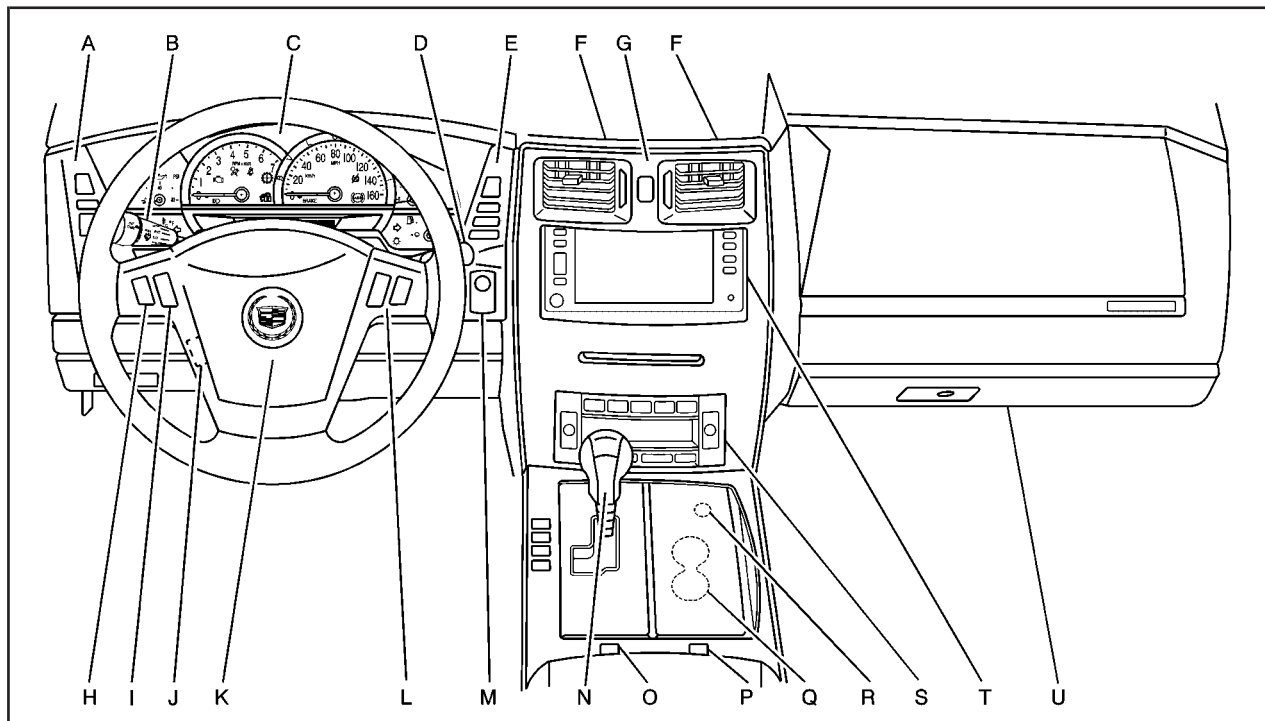

The main components of the instrument panel are the following:

- A. Head-Up Display (HUD) Controls/Instrument Panel Brightness Controls. See *Head-Up Display (HUD) on page 3-34* or *Instrument Panel Brightness on page 3-33*.
- B. Turn Signal/Multifunction Lever. See *Turn Signal/Multifunction Lever on page 3-7*.
- C. Instrument Panel Cluster. See *Instrument Panel Cluster on page 3-49*.
- D. Windshield Wiper/Washer Lever. See “Windshield Wipers” under *Turn Signal/Multifunction Lever on page 3-7*.
- E. Driver Information Center (DIC) Controls/Interior Lamps. See *DIC Controls and Displays on page 3-64*.
- F. Air Outlets. See *Outlet Adjustment on page 3-47*.
- G. Hazard Warning Flasher Button. See *Hazard Warning Flashers on page 3-6*.
- H. Voice Commands/Audio Controls. See *OnStar® System on page 2-37* or *Audio Steering Wheel Controls on page 3-84*.
- I. Adaptive Cruise Controls. See “Adaptive Cruise Control (ACC)” under *Turn Signal/Multifunction Lever on page 3-7*.
- J. Power Tilt Wheel and Telescopic Steering Button. See *Power Tilt Wheel and Telescopic Steering Column on page 3-6*.
- K. Horn. See *Horn on page 3-6*.
- L. Audio Steering Wheel Controls. See *Audio Steering Wheel Controls on page 3-84*.
- M. Ignition Switch. See *Ignition Positions on page 2-21*.
- N. Shift Lever. See *Automatic Transmission Operation on page 2-25*.
- O. Traction Control Button. See *Traction Control System (TCS) on page 5-9*.
- P. Retractable Hardtop Button. See *Retractable Hardtop on page 2-46*.
- Q. Cupholders. See *Cupholder(s) on page 2-44*.
- R. Cigarette Lighter. See *Ashtray(s) and Cigarette Lighter on page 3-41*.
- S. Climate Controls. See *Dual Climate Control System on page 3-41*.
- T. Audio/Navigation System. See *Navigation System Overview on page 4-2*.
- U. Glove Box. See *Glove Box on page 2-44*.

Hazard Warning Flashers

Your hazard warning flashers let you warn others. They also let police know you have a problem. Your front and rear turn signal lamps will flash on and off.

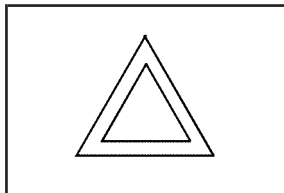

The hazard warning flasher button is located near the center of the instrument panel.

Your hazard warning flashers work no matter what mode the ignition is in, even if the ignition is turned off.

Press the button to make the front and rear turn signal lamps flash on and off. Press the button again to turn the flashers off.

When the hazard warning flashers are on, your turn signals will not work.

Other Warning Devices

If you carry reflective triangles, you can set them up at the side of the road about 300 feet (100 m) behind your vehicle.

Horn

Press near or on the horn symbols on your steering wheel pad to sound the horn.

Power Tilt Wheel and Telescopic Steering Column

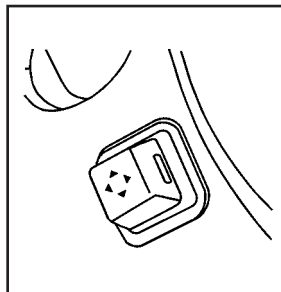

The power tilt wheel control is located on the outboard side of the steering column.



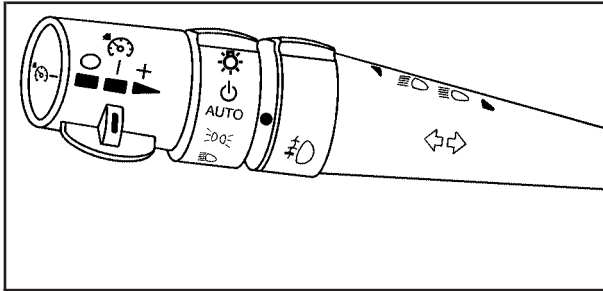

To operate the power tilt feature, push the control up and the steering wheel will tilt up. Push the control down and the steering wheel will go down.

Push the control forward and the steering wheel moves toward the front of the vehicle. Push the control rearward and the steering wheel moves toward the rear of the vehicle. To set the memory position, see *DIC Vehicle Personalization* on page 3-78 and *Memory Seat, Mirrors and Steering Wheel* on page 2-56.

Turn Signal/Multifunction Lever



The lever on the left side of the steering column includes the following:

-  Turn and Lane-Change Signals. See *Turn and Lane-Change Signals* on page 3-7.
-  Headlamp High/Low-Beam Changer. See *Headlamp High/Low-Beam Changer* on page 3-8.
-  Fog Lamps. See *Fog Lamps* on page 3-31.
- Flash-to-Pass Feature. See *Flash-to-Pass* on page 3-8.
-  Cruise Control. See *Cruise Control* on page 3-12.
-  Exterior Lamps Control. See *Exterior Lamps* on page 3-28.

Turn and Lane-Change Signals

The turn signal has two upward (for right) and two downward (for left) positions. These positions allow you to signal a turn or a lane change.

To signal a turn, move the multifunction lever all the way up or down. When the turn is finished, the lever will return automatically.

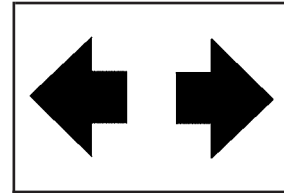

An arrow on the instrument panel cluster will flash in the direction of the turn or lane change.

To signal a lane change, just raise or lower the lever until the arrow starts to flash. Hold it there until you complete your lane change. The lever will return by itself when you release it.

If you signal a turn or a lane change and the arrows flash faster than normal, a signal bulb may be burned out. Other drivers will not see the turn signal.

Replace burned-out bulbs to help avoid possible accidents. If the arrows do not go on at all when you signal a turn, check the fuses and check for burned-out bulbs. See *Fuses and Circuit Breakers* on page 6-80.

Turn Signal on Chime

A chime will remind you if you leave the turn signal on for more than 3/4 mile (1.2 km) of driving.

If you need to leave the turn signal on for more than 3/4 mile (1.2 km), turn off the signal and then turn it back on.

Headlamp High/Low-Beam Changer

To change the headlamps from low beam to high, push the turn signal lever all the way forward.

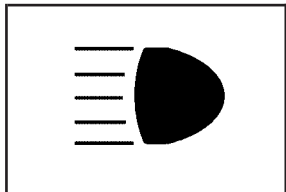

When the high beams are on, this light on the instrument panel cluster also will be on. To change the headlamps from high to low, pull the lever rearward.

Flash-to-Pass

This feature lets you use the high-beam headlamps to signal the driver in front of you that you want to pass. Pull and hold the turn signal lever toward you to use. When you do, the following will occur:

- If the low-beam headlamps are on, the high-beam headlamps will turn on. They will stay on as long as you hold the lever there. Release the lever to turn them off.
- If the headlamps are on high-beam, they will switch to low-beam. To return to high beam, push the lever away from you.

Windshield Wipers

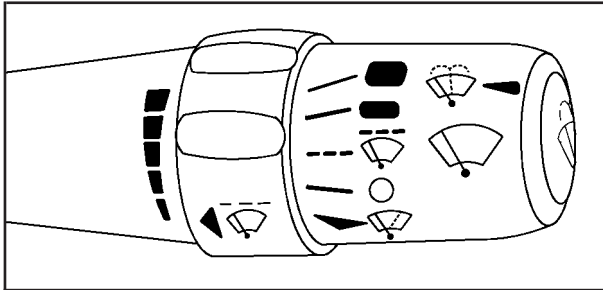

Use the lever located on the right side of the steering column to operate the windshield wipers.

■ (High Speed): Move the lever to this position for steady wiping at high speed.

■ (Low Speed): Move the lever to this position for steady wiping at low speed.

☒ (Delay): Move the lever to this position to activate the Rainsense™ function. Adjustments in this region change the sensitivity of the Rainsense™ system.

○ (Off): Move the lever to this position to turn off the windshield wipers.

☒ (Mist): Move the lever all the way down to mist and release for a single wiping cycle. The windshield wipers will stop after one wipe. If you want more wipes, hold the band on mist longer.

Heavy snow or ice can overload the wipers. If this occurs, a circuit breaker will stop the wipers until the motor cools. So, be sure to clear any ice and snow from the windshield wiper blades before using them. If the wiper blades are frozen to the windshield, carefully loosen them or warm the windshield before turning the wipers on. If your blades do become worn or damaged, see *Windshield Wiper Blade Replacement on page 6-46*.

Rainsense™ Wipers

Your vehicle has Rainsense™ wipers. The moisture sensor for this feature is mounted on the interior side of the windshield below the rearview mirror and is used to automatically operate the wipers by monitoring the amount of moisture build-up on the windshield. Wipes occur as needed to clear the windshield depending on driving conditions and the sensitivity setting. In light rain or snow, fewer wipes will occur. In heavy rain or snow, wipes will occur more frequently. The Rainsense™ wipers operate in a delay mode as well as a continuous low or high speed as needed. If the system is left on for long periods of time, occasional wipes may occur without any moisture on the windshield. This is normal and indicates that the Rainsense™ system is activated.

The Rainsense™ system is also sensitive to vibration. The system may activate if something hits the windshield or if the vehicle hits a bump.

The Rainsense™ system can be activated by moving the wiper lever up to the delay position and turning the delay adjust band to one of the five sensitivity levels. The bottom delay adjust position is the lowest sensitivity setting, level one. This allows more rain or snow to collect on the windshield between wipes. Turning the delay adjust band away from you to the higher sensitivity levels allows less rain or snow to collect on the windshield between wipes.

The top position is the highest sensitivity setting, level five. A single wipe will occur each time you turn the delay adjust band to a higher sensitivity level to indicate that the sensitivity level has been increased.

Notice: Going through an automatic car wash with the wipers on can damage them. Turn the wipers off when going through an automatic car wash.

The mist and wash cycles operate as normal and are not affected by the Rainsense™ function. The Rainsense™ system can be overridden at any time by manually changing the wiper control to low or high speed.

When Rainsense™ is active, the headlamps will turn on automatically. If it is dark, they will remain on. See “Wiper-Activated Headlamps” under *Exterior Lamps* on page 3-28 for more information.

Notice: Do not place stickers or other items on the exterior glass surface directly in front of the moisture sensor. Doing this could cause the moisture sensor to malfunction.

Windshield Washer

 **(Washer Fluid):** The lever on the right side of the steering column also controls the windshield washer. There is a button at the end of the lever. To spray washer fluid on the windshield, press the button and hold it. The washer will spray until you release the button. The wipers will continue to clear the window for about six seconds after the button is released and then stop or return to your preset speed.

CAUTION:

In freezing weather, do not use your washer until the windshield is warmed. Otherwise the washer fluid can form ice on the windshield, blocking your vision.

If the fluid in the windshield washer fluid reservoir is low, the message LOW WASHER FLUID will appear on the Driver Information Center (DIC) display. It will take 60 seconds after the bottle is refilled for this message to turn off. For information on the correct washer fluid mixture to use, see *Windshield Washer Fluid on page 6-32* and *Recommended Fluids and Lubricants on page 7-11*.

Headlamp Washer

The headlamps washer only functions every fourth time the washer button is depressed and if the headlamps are on.

Cruise Control

Your vehicle is equipped with cruise control.

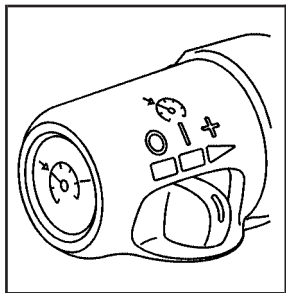

○ **(Off):** This position turns the system off.

| **(On):** This position activates the system.

+ (Resume/Accelerate): Move the lever to this symbol to make the vehicle accelerate or resume to a previously set speed.

Ⓢ (Set): Press this button at the end of the lever to set the speed.

With cruise control, you can maintain a speed of about 25 mph (40 km/h) or more without keeping your foot on the accelerator. This can really help on long trips. Cruise control does not work at speeds below about 25 mph (40 km/h).

Cruise control will not work if your parking brake is set, or if the master cylinder brake fluid level is low.

If you apply your brakes, the cruise control will shut off.

CAUTION:

Cruise control can be dangerous where you cannot drive safely at a steady speed. So, do not use your cruise control on winding roads or in heavy traffic.

Cruise control can be dangerous on slippery roads. On such roads, fast changes in tire traction can cause needless wheel spinning, and you could lose control. Do not use cruise control on slippery roads.

If your vehicle is in cruise control when the traction control system (if equipped) begins to limit wheel spin, the cruise control will automatically disengage. See *Traction Control System (TCS) on page 5-9*. When road conditions allow you to safely use it again, you may turn cruise control back on.

Setting Cruise Control

CAUTION:

If you leave your cruise control on when you are not using cruise, you might hit a button and go into cruise when you do not want to. You could be startled and even lose control. Keep the cruise control switch off until you want to use cruise control.

1. Move the cruise control switch to on.
2. Get up to the speed you want.
3. Press in the set button at the end of the lever and release it.
4. Take your foot off the accelerator pedal.

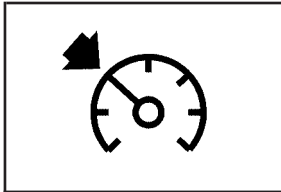

The cruise symbol on the instrument panel will illuminate when the cruise control is engaged.

Resuming a Set Speed

Suppose you set your cruise control at a desired speed and then you apply the brake. This, of course, disengages the cruise control. But you don't need to reset it.

Once you're going about 25 mph (40 km/h) or more, you can move the cruise control switch briefly from on to resume/accelerate.

You'll go right back up to your chosen speed and stay there.

If you hold the switch at resume/accelerate the vehicle will keep going faster until you release the switch or apply the brake. So unless you want to go faster, don't hold the switch at resume/accelerate.

Increasing Speed While Using Cruise Control

There are two ways to go to a higher speed:

- Use the accelerator pedal to get to the higher speed. Press the set button at the end of the lever, then release the button and the accelerator pedal. You'll now cruise at the higher speed. If the accelerator pedal is held longer than 60 seconds, cruise control will turn off.
- Move the cruise switch from on to resume/accelerate. Hold it there until you get up to the speed you want, and then release the switch. To increase your speed in very small amounts, move the switch briefly to resume/accelerate. Each time you do this, your vehicle will go about 1 mph (1.6 km/h) faster.

Reducing Speed While Using Cruise Control

- Press and hold the set button until you reach the lower speed you want, then release it.
- To slow down in very small amounts, briefly press the set button. Each time you do this, you'll go about 1 mph (1.6 km/h) slower.

Passing Another Vehicle While Using Cruise Control

Use the accelerator pedal to increase your speed. When you take your foot off the pedal, your vehicle will slow down to the cruise control speed you set earlier.

Using Cruise Control on Hills

How well your cruise control will work on hills depends upon your speed, load and the steepness of the hills. When going up steep hills, you may want to step on the accelerator pedal to maintain your speed. When going downhill, you may have to brake or shift to a lower gear to keep your speed down. Of course, applying the brake takes you out of cruise control. Many drivers find this to be too much trouble and don't use cruise control on steep hills.

Ending Cruise Control

There are two ways to turn off the cruise control:

- Step lightly on the brake pedal
- Move the cruise control switch to off

Erasing Speed Memory

When you turn off the cruise control or the ignition, your cruise control set speed memory is erased.

Adaptive Cruise Control

If your vehicle has this feature, be sure to read this entire section before using it.

The system operates on a radio frequency subject to Federal Communications Commission (FCC) Rules and with Industry Canada.

This device complies with Part 15 of the FCC Rules. Operation is subject to the following two conditions:

1. This device may not cause interference.
2. This device must accept any interference received, including interference that may cause undesired operation of the device.

This device complies with RSS-210 of Industry Canada. Operation is subject to the following two conditions:

1. This device may not cause interference.
2. This device must accept any interference received, including interference that may cause undesired operation of the device.

Changes or modifications to this system by other than an authorized service facility could void authorization to use this equipment.

Adaptive Cruise Control is an enhancement to traditional cruise control and is not a safety system. It allows you to keep cruise control engaged in moderate traffic conditions without having to constantly reset your cruise control. Adaptive Cruise Control uses radar to detect

a vehicle directly ahead in your path, within a distance of 328 ft (100 m), and operates at speeds above 25 mph (40 km/h). When it is engaged by the driver, the system can apply limited braking or acceleration of the vehicle, automatically, to maintain a selected follow distance to the vehicle ahead. Braking is limited to 0.3 g's (2.95 m/sec²) of deceleration, which is comparable to moderate application of the vehicle's brakes. To disengage Adaptive Cruise Control, apply the brake. If there is not a vehicle in your path, your vehicle will react like traditional cruise control.

CAUTION:

Adaptive Cruise Control will not apply hard braking or bring the vehicle to a complete stop. It will not respond to stopped vehicles, pedestrians or animals. When you are approaching a vehicle or object, Adaptive Cruise Control may not have time to slow your vehicle enough to avoid a collision. Your complete attention is always required while driving and you should be ready to take action and apply the brakes. For more information, see *Defensive Driving* on page 5-2.

CAUTION:

- On winding roads, Adaptive Cruise Control may not detect a vehicle ahead. You could crash into a vehicle ahead of you. Do not use Adaptive Cruise Control on winding roads.
- Adaptive Cruise Control may not have time to slow your vehicle enough to avoid a crash when you are driving in conditions where vehicles may suddenly slow or stop ahead of you, enter your lane, or cross your vehicle's path. If you are driving in these conditions, do not use Adaptive Cruise Control. The warning beep and alert symbol may indicate that you are driving in conditions where Adaptive Cruise Control should not be used. See "Alerting the Driver" in this section.
- On slippery roads, fast changes in tire traction can cause needless wheel spinning, and you could lose control. Do not use cruise control on slippery roads.

CAUTION: (Continued)

CAUTION: (Continued)

- When weather limits visibility, such as when in fog, rain, or snow conditions, Adaptive Cruise Control performance is limited. There may not be enough distance to adapt to the changing traffic conditions. Do not use cruise control when visibility is low.

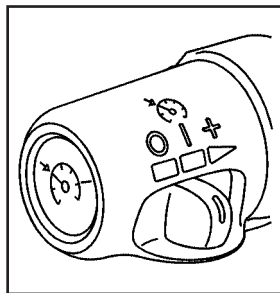

Some of the Adaptive Cruise controls are located on the end of the multifunction lever.

○ (Off): This position turns the system off.

| (On): This position turns the system on.

+ **(Resume/Increase):** Push the switch to this symbol to make the vehicle resume to a previously set speed or to increase the set speed when Adaptive Cruise Control is already active.

 **(Set/Decrease):** Press this button to set the speed or to decrease the set speed when Adaptive Cruise Control is already active.

Engaging Adaptive Cruise Control With the Set Button

CAUTION:

If you leave your Adaptive Cruise Control switch on when you are not using cruise, you might hit a button and go into cruise when you do not want to. You could be startled and even lose control. Keep the Adaptive Cruise Control switch off until you want to use cruise control.

CAUTION:

If you operate Adaptive Cruise Control without your Head-up Display (HUD) on and properly adjusted, your Adaptive Cruise Control settings will not be visible. You could forget your settings and be startled by Adaptive Cruise Control response and even lose control. Keep your HUD on and properly adjusted when using Adaptive Cruise Control.

The set speed is selected by the driver. This is the speed you will travel if there is not a vehicle detected in your path.

To set Adaptive Cruise Control, do the following:

1. Make sure the Head-Up Display (HUD) is on and properly adjusted. See *Head-Up Display (HUD)* on page 3-34 for more information.
2. Move the switch to on.
3. Get up to the speed you want.
4. Press in the set button at the end of the lever and release it.
5. Take your foot off the accelerator pedal.

Once Adaptive Cruise Control is set, it may immediately apply the brakes if it detects a vehicle ahead is too close or moving slower than your vehicle.

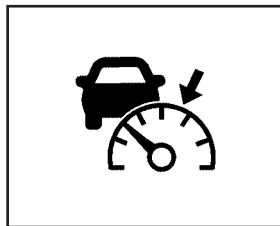

This symbol will appear on the Head-Up Display (HUD) to indicate that Adaptive Cruise Control is active. See *Head-Up Display (HUD)* on page 3-34 for more information.

Make sure the set speed is visible on the HUD so you know the speed your vehicle will accelerate to if a vehicle is not detected in your path. Keep in mind speed limits, surrounding traffic speeds and weather conditions when adjusting your set speed.

If your vehicle is in Adaptive Cruise Control when the traction control system begins to limit wheel spin, the Adaptive Cruise Control will automatically disengage. See *Traction Control System (TCS)* on page 5-9 and *StabiliTrak® System* on page 5-11. When road conditions allow you to safely use it again, you may turn the Adaptive Cruise Control back on.

Increasing Set Speed While Using Adaptive Cruise Control

There are two ways to increase the set speed:

- Use the accelerator to get to the higher speed. Press the set button at the end of the lever, then release the button and the accelerator pedal. You will now cruise at the higher speed.
- Move the Adaptive Cruise Control switch from on to resume/increase. Hold it there until the desired set speed is displayed in the HUD, then release the switch. To increase your set speed in very small amounts, move the switch briefly to resume/increase. Each time you do this, your vehicle set speed will increase by 1 mph (1.6 km/h).

Your vehicle will not reach the set speed until the system determines there is not a vehicle in front of you. At that point, your vehicle speed will increase to the set speed.

Decreasing Set Speed While Using Adaptive Cruise Control

Press in the set/decrease button on the end of the lever until you reach the lower speed you want, then release it.

To slow down in very small amounts, briefly press the set/decrease button. Each time you do this, your set speed will be 1 mph (1.6 km/h) slower.

Resuming a Set Speed

Suppose you set your Adaptive Cruise Control at a desired speed and then you apply the brake. This will disengage the Adaptive Cruise Control. But you do not need to reset it.

Once you are going about 25 mph (40 km/h) or more, you can move the Adaptive Cruise Control switch briefly from on to resume/increase. Adaptive Cruise Control will be engaged with the previously chosen set speed.

Selecting the Follow Distance (GAP)

When the system detects a slower moving vehicle, it will adjust your vehicle's speed and maintain the follow distance (gap) you select.

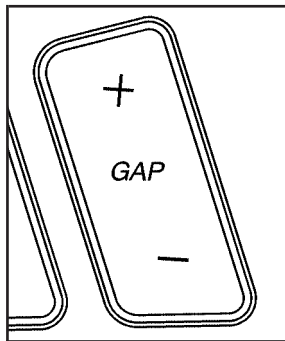

Use the GAP button on the steering wheel to adjust the follow distance.

Press the top of the button to increase the distance or the bottom of the button to decrease the distance. The first button press will show you the current follow distance setting on the HUD. Your current follow distance setting will be maintained until you change it.

There are six follow distances to choose from. The follow distance selection ranges from near to far (1 second to 2 seconds follow time). The distance maintained for a selected follow distance will vary based on vehicle speed.

The faster the vehicle speed the further back you will follow. Consider traffic and weather conditions when selecting the follow distance. The range of selectable distances may not be appropriate for all drivers and driving conditions. If you choose to travel at a distance farther than Adaptive Cruise Control allows, disengage the system and drive manually.

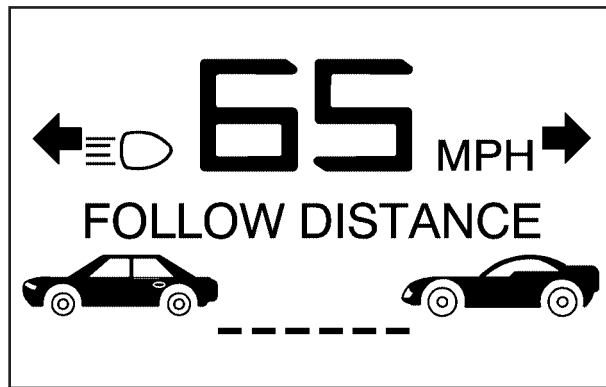

A graphic on the HUD indicates the selected follow distance. This picture shows a maximum follow distance. The vehicles will move closer as you select a smaller follow distance.

Alerting the Driver

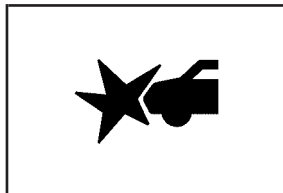

The alert symbol will flash on the HUD and a warning beep will sound when driver action is required.

Driver action is required when:

- Adaptive Cruise Control cannot apply sufficient braking because you are approaching a vehicle too rapidly.
- The vehicle speed drops below about 20 mph (32 km/h).
- A temporary condition prohibits Adaptive Cruise Control from operating. See *DIC Warnings and Messages on page 3-67* for more information.
- A malfunction is detected in the system. See *DIC Warnings and Messages on page 3-67* for more information.

See *Defensive Driving on page 5-2* for more information.

CAUTION:

Adaptive Cruise Control has only limited braking ability to slow your vehicle. In some cases, Adaptive Cruise Control may not have time to slow your vehicle enough to avoid a collision. Be ready to take action and apply the brakes yourself. See *Defensive Driving on page 5-2*.

Approaching and Following a Vehicle

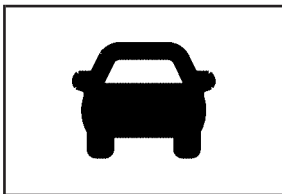

The vehicle ahead symbol will only appear on the HUD when a vehicle ahead is detected in your path.

If this symbol does not appear, or disappears briefly, Adaptive Cruise Control will not respond to vehicles you may see ahead.

CAUTION:

When the Adaptive Cruise Control radar is blocked by snow, ice, or dirt, it may not detect a vehicle ahead. Adaptive Cruise Control may not have time to slow your vehicle enough to avoid a collision. Do not use Adaptive Cruise Control when the radar is blocked by snow, ice, or dirt. Keep your radar clean. See “Cleaning the System” later in this section.

Adaptive Cruise Control will automatically slow your vehicle down when approaching a slower moving vehicle. It will then adjust your speed to follow the vehicle in front at the selected follow distance. Your speed will increase or decrease to follow the vehicle in front of you but will not exceed the set speed. The system may apply limited braking if necessary. When braking is active, your brake lights will come on. It may feel or sound different than if you were applying the brakes yourself. This is normal.

Stationary or Very Slow-Moving Objects

CAUTION:

Adaptive Cruise Control may not detect and react to stationary or slow-moving vehicles or other objects ahead of you. You could crash into an object ahead of you. Do not use Adaptive Cruise Control when approaching stationary or slow-moving vehicles or other objects.

 **CAUTION:**

Adaptive Cruise Control may not detect and react to stationary or slow-moving vehicles or other objects ahead of you. Your vehicle may accelerate toward objects, such as a stopped vehicle that suddenly appears after the lead vehicle changes lanes. Your complete attention is always required while driving and you should be ready to take action and apply the brakes.

Low-Speed Deactivation

If your speed falls below 20 mph (32 km/h) while following a vehicle ahead, Adaptive Cruise Control will begin to disengage. The driver alert symbol on the HUD will flash and the warning beep will sound. The driver must take action since Adaptive Cruise Control will not slow the vehicle to a stop.

Passing a Vehicle

If you need to increase speed to pass a vehicle, use the accelerator pedal. While your foot is on the accelerator pedal, the system will not automatically apply the brakes. Once you pass the vehicle and remove your foot from the accelerator pedal, Adaptive Cruise Control will return to normal operation and be able to apply the brakes, if needed.

 **CAUTION:**

If you rest your foot on the accelerator pedal, the system will not automatically apply the brakes. You could crash into a vehicle ahead of you. Do not rest your foot on the accelerator pedal when using Adaptive Cruise Control.

Curves in the Road

CAUTION:

Due to Adaptive Cruise Control limitations in curves, it may respond to a vehicle in another lane, or may not have time to react to a vehicle ahead of you, or lose control of your vehicle. You could crash into a vehicle ahead of you, or lose control of your vehicle. Give extra attention in curves and be ready to use the brakes if necessary. Select an appropriate speed while driving in curves.

Adaptive Cruise Control may operate differently in a sharp curve.

The system may reduce your speed in a curve if the curve is too sharp. The TIGHT CURVE message will also display on the HUD. See *Head-Up Display (HUD)* on page 3-34 for more information.

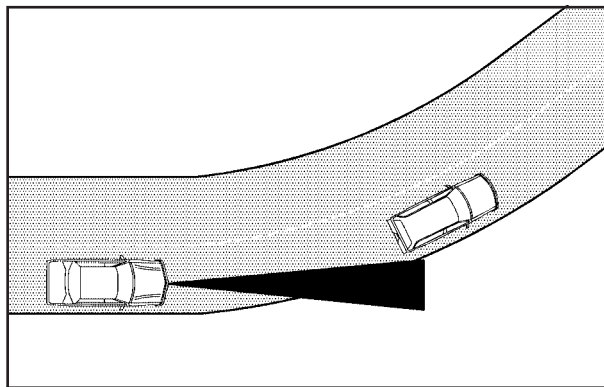

When following a vehicle and entering a curve, Adaptive Cruise Control could lose track of the vehicle in your lane and accelerate your vehicle. When this happens, the vehicle ahead symbol will not appear on the HUD.

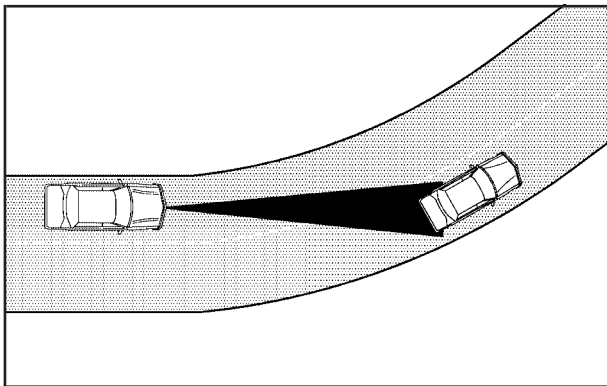

Adaptive Cruise Control may detect a vehicle that is not in your lane and apply the brakes.

Adaptive Cruise Control may, occasionally, provide a driver alert and/or braking that you consider unnecessary. It could respond to signs, guardrails and other stationary objects when entering or exiting a curve. This is normal operation. Your vehicle does not need service.

Highway Exit Ramps

CAUTION:

Adaptive Cruise Control may lose track of the vehicle ahead and accelerate up to your set speed while entering or on highway exit ramps. You could be startled by this acceleration and even lose control of the vehicle. Disengage Adaptive Cruise Control before entering a highway exit ramp. Do not use Adaptive Cruise Control while entering or on exit ramps.

Other Vehicle Lane Changes

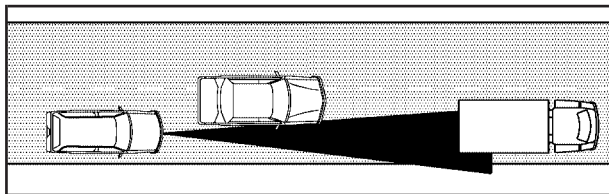

If another vehicle enters the same lane as you, Adaptive Cruise Control will not detect the vehicle until it is completely in the lane. Be ready to take action and apply the brakes yourself.

Using Adaptive Cruise Control on Hills

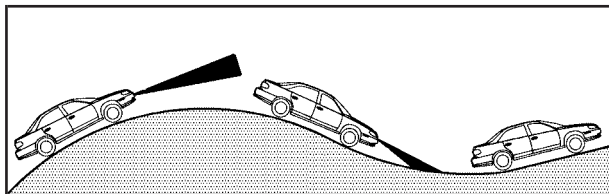

How well Adaptive Cruise Control will work on hills depends on your speed, vehicle load, traffic conditions and the steepness of the hills. It may not detect a vehicle in your lane while driving on hills.

When going up steep hills, you may want to use the accelerator pedal to maintain your speed. When going downhill, you may have to brake to keep your speed down. Applying the brake disengages the system. You may choose not to use Adaptive Cruise Control on steep hills.

Disengaging Adaptive Cruise Control

To disengage the system, apply the brake pedal or move the Adaptive Cruise Control switch to off. Adaptive Cruise Control information will not appear on the HUD when the system is not engaged.

Erasing Set Speed Memory

When you turn the Adaptive Cruise Control switch or the ignition off, the set speed memory is erased.

Other Messages

There are three messages that may appear in the Driver Information Center (DIC). They are SERVICE RADAR CRUISE, CRUISE NOT READY and CLEAN RADAR CRUISE. These messages will only appear to indicate a problem if Adaptive Cruise Control is active. See *DIC Warnings and Messages on page 3-67* for more information.

You may also see CRUISE SPEED LIMITED displayed in the HUD. See *Head-Up Display (HUD) on page 3-34* for more information.

Cleaning the System

The radar can become blocked by snow, ice or dirt. If so, you may need to turn off the engine and clean the lens.

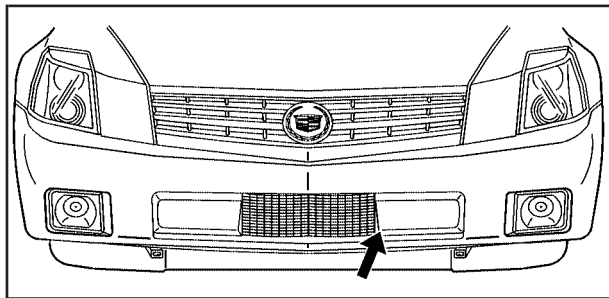

The lens is located on the driver's side of the front fascia.

Clean the surface with a 50/50 mixture of isopropyl alcohol and water on a dampened cloth. After cleaning the fascia lens, try to engage Adaptive Cruise Control. If this does not fix the problem, you may have to remove the fascia lens and clean the inside of the fascia lens and radar lens.

To clean the inside of the fascia lens and radar lens, insert a screwdriver or similar object into one of the small slots on the inboard side of the lens and pop the lens out. Clean the surface with a 50/50 mixture of isopropyl alcohol and water on a dampened cloth. After cleaning the lens, set the lens back in place and press until it snaps in.

Exterior Lamps

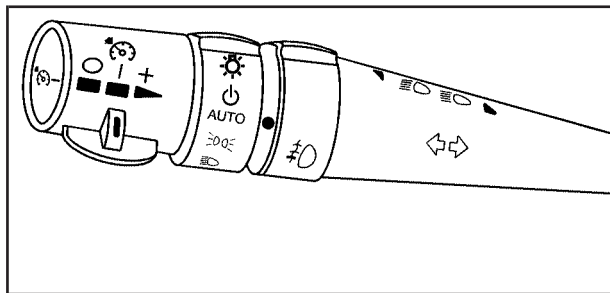

The exterior lamp control is located to the left of the steering wheel on the multifunction lever.

 **(Exterior Lamp Control):** Turn the band with this symbol on it to operate the exterior lamps.

The exterior lamp band has four positions:

 **(Off):** Turning the band to this position turns off all lamps.

AUTO (Automatic): Turning the band to this position sets the exterior lamps in automatic mode. AUTO mode will turn the exterior lamps on and off depending on how much light is available outside the vehicle. Turning the band to AUTO mode also enables the Adaptive Forward Lighting system. See *Adaptive Forward Lighting System* on page 3-31.

To override AUTO mode, turn the control to off.

To reset to AUTO mode turn the control to exterior lamps and then back to AUTO. Automatic mode will also reset when your vehicle is turned off and then back on again when the control is left in the AUTO position.

See *Twilight Sentinel[®]* on page 3-32.

 **(Parking Lamp):** Turning the band to this position turns on the parking lamps together with the following:

- Sidemarker Lamps
- Taillamps
- License Plate Lamps
- Instrument Panel Lights

The parking brake indicator light will come on and stay on when the parking lamps are on with the engine off and the ignition to ACC.

 **(Headlamps):** Turning the control to this position turns on the headlamps, together with the previously listed lamps and lights.

Wiper Activated Headlamps

This feature activates the headlamps and parking lamps after the windshield wipers have been in use for approximately six seconds and the multifunction lever is in the AUTO position. See *Exterior Lamps on page 3-28*.

When the exterior lamp control has been turned off or is in the parking lamp position and the wiper control is on delay, low speed or high speed, the HEADLAMPS SUGGESTED message will appear on the Driver Information Center (DIC).

When the ignition is turned off, the wiper-activated headlamps will immediately turn off.

Headlamps on Reminder

A warning chime will sound if the exterior lamp control is left on in either the headlamp or parking lamp position and the driver's door is opened with the ignition off.

Daytime Running Lamps (DRL)

Daytime Running Lamps (DRL) can make it easier for others to see the front of your vehicle during the day. DRL can be helpful in many different driving conditions, but they can be especially helpful in the short periods after dawn and before sunset. Fully functional daytime running lamps are required on all vehicles first sold in Canada.

The DRL system will make the front turn signal lamps come on when the following conditions are met:

- It is still daylight and the ignition is on,
- the exterior lamp control is in the off position and
- the transmission is not in PARK (P).

When DRL are on, only the front turn signal lamps will be on. No other exterior lamps such as the parking lamps, taillamps, etc. will be on when the DRL are being used. Your instrument panel will not be lit up either.

When it is dark enough outside, the front turn signal lamps will turn off and normal low-beam headlamps will turn on.

When it is bright enough outside, the regular lamps will go off, and the front turn signal lamps will take over. If you start your vehicle in a dark garage, the automatic headlamp system will come on immediately. Once you leave the garage, it will take approximately one minute for the automatic headlamp system to change to DRL if it is light outside. During that delay, your instrument panel cluster may not be as bright as usual. Make sure your instrument panel brightness knob is in the full bright position. See *Instrument Panel Brightness on page 3-33* for more information.

If it is dark enough outside and the exterior lamp control is off, a HEADLAMPS SUGGESTED message will display on the Driver's Information Center (DIC). This message informs the driver that turning on the exterior lamps is recommended.

Turning the exterior lamp control to off a second time, or turning on the headlamps will remove the HEADLAMPS SUGGESTED message. If the parking lamps or the fog lamps were turned on instead, the HEADLAMPS SUGGESTED message will continue to be displayed.

As with any vehicle, you should turn on the regular headlamp system when you need it.

Adaptive Forward Lighting System

The Adaptive Forward Lighting System (AFS) swivels the headlamps horizontally to provide greater road illumination while turning. AFS will operate when the vehicle speed is greater than 2 mph (3 km/h). AFS will not operate when the transmission is in REVERSE (R). AFS is not immediately operable after starting the vehicle; driving a short distance is required to calibrate the AFS. To enable AFS, set the exterior lamp switch on the multifunction lever to the AUTO position. Moving the switch out of the AUTO position will deactivate the system. See *Exterior Lamps on page 3-28*.

Fog Lamps

Use fog lamps for better vision in foggy or misty conditions.

The fog lamps control is located on the multifunction lever next to the exterior lamp control.

 **(Fog Lamps):** Turning the band to this position will turn the fog lamps on.

When you turn the fog lamps on, the fog lamp light will appear on the instrument panel cluster to indicate that the fog lamps and the parking lamps are on.

If you turn the high-beam headlamps on, the fog lamps will turn off. They will turn on again when you switch to low-beam headlamps.

The ignition must be on for the fog lamps to operate. The fog lamps will turn off when the ignition is turned off.

Some localities have laws that require the headlamps to be on along with the fog lamps.

Twilight Sentinel®

Twilight Sentinel® can turn your lamps on and off for you. A light sensor on top of the instrument panel makes the Twilight Sentinel® work, so be sure it is not covered.

With Twilight Sentinel® you will see the following happen:

- When it is dark enough outside, the front turn signal lamps (DRL) will go off, and the headlamps and parking lamps will come on. The other lamps that come on with headlamps will also come on.
- When it is bright enough outside, the headlamps will go off, and the front turn signal lamps (DRL) will come on, as long as the exterior lamp switch is in the AUTO position.

If you start your vehicle in a dark garage, the automatic headlamp system will come on immediately. Once you leave the garage, it will take approximately one minute for the automatic headlamp system to change to DRL if it is light outside. During that delay, your instrument panel cluster may not be as bright as usual. Make sure your instrument panel brightness control is in full bright position. See *Instrument Panel Brightness on page 3-33* for more information.

You can idle the vehicle with the lamps off, even when it is dark outside. After starting the vehicle, turn the exterior lamp control band to off, then release it. The lamps will remain off until you turn the control band to off again.

Twilight Sentinel® also provides exterior illumination as you leave the vehicle. If Twilight Sentinel® has turned on the lamps when you turn off the ignition, your lamps will remain on until:

- The exterior lamp switch is moved from OFF to the parking lamp position, or
- a delay time that you select has elapsed.

See *Driver Information Center (DIC) on page 3-64* to select the delay time that you want. You can also select no delay time.

If you turn off the ignition with the exterior lamp switch in the parking lamp or headlamp position, the Twilight Sentinel® delay will not occur. The lamps will turn off as soon as the switch is turned off.

As with any vehicle, you should turn on the regular headlamp system when you need it.

Exterior Lighting Battery Saver

If the manual parking lamps or headlamps have been left on, the exterior lamps will turn off as soon as the ignition is turned off or RAP is active. This protects against draining the battery in case you have accidentally left the headlamps or parking lamps on. The battery saver does not work if the headlamps are turned on after the ignition switch is turned to off.

If you need to leave the lamps on, use the exterior lamp control to turn the lamps back on.

Instrument Panel Brightness

The button for this feature is located on the instrument panel to the left of the steering column.

+☀ - (Brightness): Press this button to change the brightness of the instrument panel lights.

Press the DIMMER button until PANEL DIMMING appears on the Driver Information Center (DIC). Then use the brightness button to adjust the instrument panel brightness. Press the top of the button to brighten the lights or the bottom of the button to dim the lights.

See *Head-Up Display (HUD)* on page 3-34 for more information.

Be sure not to have the brightness turned all the way down with the lamps on during the day. Your DIC may not be visible.

Courtesy Lamps

When any door or the trunk lid is opened, the interior lamps will go on unless it is bright outside.

You can also turn the courtesy lamps on by pressing the interior lamp button on the right side of the instrument panel cluster.

Press this button if the courtesy lamps will not go off.

Entry/Exit Lighting

With entry lighting, the interior lamps will come on when entering the vehicle. The interior lamps will come on for about 20 seconds when the engine is turned off.

You can turn exit and entry lighting off by quickly turning the courtesy lamps on and off.

Reading Lamps

Your inside rearview mirror includes two reading lamps. The lamps will go on when a door is opened. When the doors are closed, each lamp can be turned on individually by pressing the button for that lamp.

Battery Run-Down Protection

Your vehicle has a feature to help prevent you from draining the battery in case the underhood lamp, vanity mirror lamps, cargo lamps, reading lamps, console or glove box lamps are accidentally left on or in case something is plugged into the accessory power outlet or cigarette lighter. If you leave any of these lamps on, they will automatically time-out after about 20 minutes. To reset it, all of the above lamps must be turned off or the ignition key must be in ON.

Head-Up Display (HUD)

CAUTION:

If the HUD image is too bright, or too high in your field of view, it may take you more time to see things you need to see when it is dark outside. Be sure to keep the HUD image dim and placed low in your field of view.

The Head-Up Display (HUD) allows you to see some of the driver information that appears on your instrument panel cluster.

The information may be displayed in English or metric units and appears as an image focused out toward the front of your vehicle. To change from English to metric units, see *Driver Information Center (DIC)* on page 3-64.

The HUD consists of the following information:

- Speedometer
- Turn Signal Indicators
- High-Beam Indicator Symbol
- Tap-Up/Tap-Down Transmission Feature
- Check Gages Icon
- Adaptive Cruise Control Features and Indicators
- Radio Features



Be sure to continue scanning your displays, controls and driving environment just as you would in a vehicle without HUD. If you never look at your instrument panel cluster, you may not see something important, such as a warning light. Under important warning conditions, the CHECK GAGES message will display in the HUD. View your Driver Information Center (DIC) for more information.

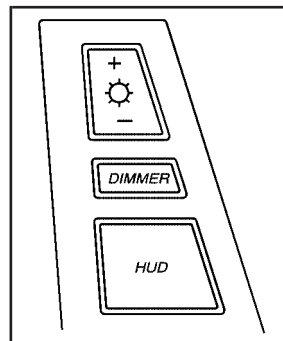

The HUD controls are located to the left of the steering wheel.

+  - (Brightness): This button is used to adjust the brightness of the HUD and the instrument panel cluster.

DIMMER: This button is used to select the HUD or the instrument panel cluster to adjust the brightness.

HUD: This button is used to adjust the vertical position of the HUD display.

To adjust the HUD so you can see it properly, do the following:

1. Adjust the seat to a comfortable driving position. If you change your seat position later, you may have to re-adjust your HUD.
2. Start your engine and press the top or bottom of the HUD button to center the HUD image in your view.
The HUD image can only be adjusted up and down, not side-to-side.
3. Press the DIMMER button until the DIC reads HUD DIMMING. Then use the brightness button to adjust the desired intensity.

The brightness of the HUD image is determined by the light conditions in the direction your vehicle is facing and where you have the HUD set. If you are facing a dark object or a heavily shaded area, your HUD may anticipate that you are entering a dark area and may begin to dim.

To turn off the HUD, press the brightness button down until the image disappears.

Polarized sunglasses could make the HUD image harder to see.

As light shines out from the HUD, it is possible for light to shine back in. In rare occurrences, when the sun is at a specific angle and position, the sun's rays can shine back into the HUD. When this occurs, the display device within the HUD will be temporarily illuminated. The event will end when the vehicle's angle to the sun changes.

Clean the inside of the windshield as needed to remove any dirt or film that reduces the sharpness or clarity of the HUD image.

To clean the HUD, spray household glass cleaner on a soft, clean cloth. Wipe the HUD lens gently, then dry it. Do not spray cleaner directly on the lens because the cleaner could leak into the unit.

If the ignition is on and you cannot see the HUD image, check to see if:

- Something is covering the HUD unit.
- The brightness is adjusted properly.
- The HUD image is adjusted to the proper height.
- Ambient light in the direction your vehicle is facing is low.
- A fuse is blown. See *Fuses and Circuit Breakers on page 6-80*.

Keep in mind that your windshield is part of the HUD system. See *Windshield Replacement on page 6-46*.

The following Adaptive Cruise Control (ACC) messages may appear in the HUD:

CRUISE SPEED LIMITED: This message indicates that your vehicle speed has been reduced below your set speed due to ACC limitations. Your set speed is too high and ACC cannot detect other vehicles at far enough distances for the system to operate properly.

TIGHT CURVE: This message indicates that ACC has reduced your vehicle speed due to a tight curve in the road. Once the road straightens, ACC will return to your selected set speed or follow distance setting. See “Adaptive Cruise Control (ACC)” under *Turn Signal/Multifunction Lever on page 3-7* for more information.

You may also see an ACC active symbol, alert symbol or vehicle ahead symbol. See “Adaptive Cruise Control (ACC)” under *Turn Signal/Multifunction Lever on page 3-7* for more information.

Ultrasonic Rear Parking Assist (URPA)

Ultrasonic Rear Parking Assist can help you to determine how close an object is to your rear bumper within a given area, making parking easier.

CAUTION:

Even with the Ultrasonic Rear Park Assist system, the driver must check carefully before backing up. The system does not operate above typical backing speeds of 3 mph (5 km/h) while parking. And, the system does not detect objects that are more than 5 feet (1.5 meters) behind the vehicle.

So, unless you check carefully behind you before and when you back up, you could strike children, pedestrians, bicyclists or pets behind you, and they could be injured or killed.

Whether or not you are using rear park assist, always check carefully behind your vehicle before you back up and then watch closely as you do.

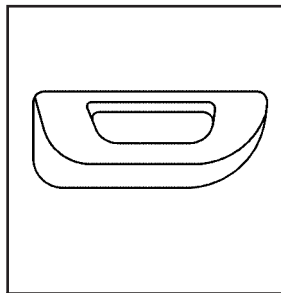

The URPA display is located inside the vehicle, on the center console. It has three color-coded lights that can be seen through the rearview mirror or by turning around.

How the System Works

URPA comes on automatically when the shift lever is moved into REVERSE (R) and the vehicle speed is less than 3 mph (5 km/h). When the system comes on, the three lights on the display will illuminate to let you know that the system is working. URPA senses how close your vehicle is to an object. The distance is determined by the four ultrasonic sensors located on the rear bumper.

When you shift into REVERSE (R) and an object is detected, the following will occur in sequence depending on the distance from the object:

- At 5 feet (1.5 m) a chime will sound and one amber light will be lit;
- at 40 inches (1.0 m) both amber lights will be lit;
- at 20 inches (0.5 m) a continuous chime will sound and all three lights (amber/amber/red) will be lit; and
- at 1 foot (0.3 m) a continuous chime will sound and all three lights (amber/amber/red) will flash.

URPA can detect objects 3 inches (7.6 cm) and wider, and at least 10 inches (25.4 cm) tall, but it cannot detect objects that are above trunk level. In order for the rear sensors to recognize an object, it must be within operating range.

If the URPA system is not functioning properly, the display will flash red, indicating that there is a problem. The light will also flash red while driving if a trailer is attached to your vehicle, or a bicycle or object is on the back of, or hanging out of your trunk. The light will continue to flash until the trailer or the object is removed and your vehicle is driven forward at least 15 mph (25 km/h).

It may also flash red if the ultrasonic sensors are not kept clean. So be sure to keep your rear bumper free of mud, dirt, snow, ice and slush or materials such as paint or the system may not work properly. If after cleaning the rear bumper and driving forward at least 15 mph (25 km/h), the display continues to flash red, see your dealer. For cleaning instructions, see *Washing Your Vehicle on page 6-74*.

It may also flash red if your vehicle is moving in REVERSE (R) at a speed greater than 3 mph (5 km/h). Other conditions that may affect system performance include things like the vibrations from a jackhammer or the compression of air brakes on a very large truck.

As always, drivers should use care when backing up a vehicle. Always look behind you, being sure to check for other vehicles, obstructions and blind spots.

Accessory Power Outlet(s)

The accessory power outlet can be used to connect electrical equipment such as a cellular phone or CB radio.

The accessory power outlet is located inside the center console storage compartment, on the forward left side.

To use the outlet, remove the tethered cap. When not using it, always cover the outlet with the protective cap.

Notice: When using an accessory power outlet, maximum electrical load must not exceed 20 amps. Always turn off any electrical equipment when not in use. Leaving electrical equipment on for extended periods will drain your vehicle's battery.

Certain electrical accessories may not be compatible with the accessory power outlet and could result in blown vehicle or adapter fuses. If you experience a problem, see your dealer for additional information on accessory power outlets.

Notice: Adding any electrical equipment to your vehicle may damage it or keep other components from working as they should. The repairs would not be covered by your warranty. Do not use equipment exceeding maximum amperage rating. Check with your dealer before adding electrical equipment.

When adding electrical equipment, be sure to follow the installation instructions included with the equipment.

We recommend that you see a qualified technician or your dealer for the proper installation of your equipment.

Notice: Improper use of the power outlet can cause damage not covered by your warranty. Do not hang any type of accessory or accessory bracket from the plug because the power outlets are designed for accessory power plugs only.

Ashtray(s) and Cigarette Lighter

The ashtray and cigarette lighter are located under a lid in the front console to the right of the shift lever. Press the left side of the lid and it will open automatically.

Notice: If you put papers, pins, or other flammable items in the ashtray, hot cigarettes or other smoking materials could ignite them and possibly damage your vehicle. Never put flammable items in the ashtray.

Loose objects, such as paper clips, can lodge behind and beneath the ashtray lid and prevent movement of the lid. You should avoid putting small, loose objects near the ashtray.

To use the cigarette lighter, push it in all the way and let go. When it is ready, it will pop back out by itself.

Notice: Holding a cigarette lighter in while it is heating will not allow the lighter to back away from the heating element when it is hot. Damage from overheating may occur to the lighter or heating element, or a fuse could be blown. Do not hold a cigarette lighter in while it is heating.

Climate Controls

Dual Climate Control System

With this system you can control the heating, cooling and ventilation for your vehicle.

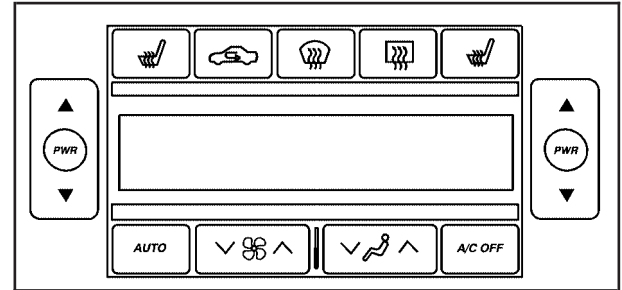

When your vehicle is first started, the system will recall the last temperature fan and mode settings for that driver.

Automatic Operation

AUTO (Automatic): When this button is pressed and the temperature is set, the system will automatically control the inside temperature, the air delivery mode, the air-conditioning compressor and the fan speed. AUTO will appear on the display.

1. Press the AUTO button.
2. Adjust the temperature to a comfortable setting between 70°F (21°C) and 80°F (27°C).

Choosing the warmest or coldest temperature setting will not cause the system to heat or cool any faster. If you set the system at the warmest or coldest temperature setting, the system will remain in manual mode at that temperature and it will not go into automatic mode.

In cold weather, the system will start at reduced fan speeds to avoid blowing cold air into your vehicle until warmer air is available. The system will start out blowing air at the floor but may change modes automatically as the vehicle warms up to maintain the chosen temperature setting. The length of time needed for warm up will depend on the outside temperature and the length of time that has elapsed since your vehicle was last driven.

3. Wait for the system to regulate. This may take from 10 to 30 minutes. Then adjust the temperature, if necessary.

You can switch from English to metric units through the Driver Information Center (DIC). See *DIC Controls and Displays on page 3-64* for more information.

The air-conditioning system removes moisture from the air, so you may sometimes notice a small amount of water dripping underneath your vehicle while idling or after turning off the engine. This is normal.

Do not cover the solar sensor located in the center of the instrument panel, near the windshield. For more information on the solar sensor, see “Sensors” later in this section.

Manual Operation

△ PWR ▽ (Power/Temperature): Press the PWR button on the left side of the climate control panel to turn the entire climate control system on or off. Press the up or down arrow on the switch to manually increase or decrease the temperature inside the vehicle.

Press the PWR button on the right side of the climate control panel to turn the passenger's climate control system on or off. Press the up or down arrow on the switch to manually increase or decrease the temperature for the passenger.

If the passenger's PWR button is off, the driver's temperature switch controls the temperature for the entire vehicle.

 **(Fan):** Press this switch to increase or decrease the fan speed. Pressing this switch cancels automatic operation and places the system in manual mode. Press AUTO to return to automatic operation.

If the airflow seems low when the fan speed is at the highest setting, the passenger compartment air filter may need to be replaced. For more information, see *Passenger Compartment Air Filter on page 3-47* and *Scheduled Maintenance on page 7-4*.

 **(Mode):** Pressing the switch and changing the mode cancels automatic operation and places the system in manual mode. Press the AUTO button to return to automatic operation.

To change the current mode, select one of the following:

 **(Vent):** This mode directs air to the instrument panel outlets.

 **(Bi-Level):** This mode directs approximately half of the air to the instrument panel outlets, and then directs most of the remaining air to the floor outlets. In automatic operation, cooler air is directed to the upper outlets and warmer air to the floor outlets.

 **(Floor):** This mode directs most of the air to the floor outlets with some air directed to the side window outlets, and a little air directed to the windshield.

The mode switch can also be used to select the defog mode. Information on defogging and defrosting can be found later in this section.

A/C OFF (Air Conditioning): Press this button to turn off the air conditioning compressor. Press AUTO to return to automatic operation. The compressor cannot be turned off in either the defrost or floor/defog mode.

 **(Heated/Cooled Seat):** Press this button to turn the feature on. The button on the left controls the driver's seat and the button on the right controls the passenger's seat. Each press of the button will take you to a different setting. The settings available in order are HI HEAT, LO HEAT, OFF, HI COOL, LO COOL and OFF. You will be able to feel the temperature change in a few minutes.

The feature will automatically turn off when the vehicle is turned off.

 **(Recirculation):** Press this button to turn the recirculation mode on or off. The air-conditioning compressor also comes on. This mode keeps outside air from coming in the vehicle. It can be used to prevent outside air and odors from entering your vehicle or to help cool the air inside your vehicle more quickly.

Recirculation is not available in defrost or floor/defog modes.

Using recirculation for long periods of time may cause the air inside your vehicle to become too dry. To prevent this from happening, after the air in your vehicle has cooled, turn the recirculation mode off.

Sensors

There are sensors to measure the temperature and sun's effect on passenger comfort.

The solar sensor on your vehicle monitors the solar radiation then uses the information to maintain the selected temperature when operating in AUTO mode by initiating needed adjustments to the temperature, the fan speed and the air delivery system. The system may also supply cooler air to the side of the vehicle facing the sun. The recirculation mode will also be activated, as necessary. Do not cover the solar sensor located on the top of the instrument panel near the windshield or the system will not work properly.

There is also a sensor located behind the front bumper. This sensor reads the outside air temperature and helps maintain the temperature inside the vehicle. The outside temperature will be displayed in the navigation system only when the engine is running. Any cover on the front of the vehicle could give a false reading of the temperature.

If the outside temperature goes up, the display temperature will not change until:

- The vehicle's speed is above 10 mph (16 km/h) for five minutes.
- The vehicle's speed is above 32 mph (51 km/h) for two and one-half minutes.

These delays prevent false readings. If the temperature goes down, the outside temperature will be shown when you start the vehicle. If it has been turned off for less than three hours, the temperature will be recalled from the previous vehicle operation.

There is also an inside temperature sensor located to the left of the ignition button. The automatic climate control system uses this sensor to receive information, so if you block or cover it, the system will not function properly.

Defogging and Defrosting

Fog on the inside of windows is a result of high humidity (moisture) condensing on the cool window glass.

This can be minimized if the climate control system is used properly. There are two modes to clear fog or frost from your windshield. Use the floor/defog mode to clear the windows of fog or moisture and warm the passengers. Use defrost to remove fog or frost from the windshield more quickly.

 **(Floor/Defog):** Press the mode button until the defog mode appears on the display. This mode directs the air between the windshield, floor outlets and side windows. When you select this mode, the system turns off recirculation and runs the air-conditioning compressor unless the outside temperature is near or below freezing. The recirculation mode cannot be selected while in the floor/defog mode.

 **(Defrost):** Press this button to direct most of the air to the windshield, with some air directed to the side windows. In this mode, the system will automatically turn off the recirculation and run the air-conditioning compressor, unless the outside temperature is near or below freezing. Recirculation cannot be selected while in the defrost mode. Do not drive the vehicle until all the windows are clear.

Rear Window Defogger

The rear window defogger uses a warming grid to remove fog or frost from the rear window.

The rear window defogger will only work when the engine is running.

 **(Rear Window Defogger):** Press this button to turn the rear window defogger on or off. Be sure to clear as much snow from the rear window as possible.

The rear window defogger will turn off approximately 10 minutes after the button is pressed when traveling less than 30 mph (48 km/h). If turned on again, the defogger will only run for approximately five minutes before turning off. The defogger can also be turned off by pressing the button again or by turning off the engine.

The heated outside rearview mirrors will heat to help clear fog or frost from the surface of the mirrors when the rear window defogger is on.

The rear window defogger and heated mirrors are automatically disabled when the retractable hardtop is moving or down.

Notice: Do not use anything sharp on the inside of the rear window. If you do, you could cut or damage the warming grid, and the repairs would not be covered by your warranty. Do not attach a temporary vehicle license, tape, a decal or anything similar to the defogger grid.

Outlet Adjustment

Use the thumbwheel to open or close the outlets.

Operation Tips

- Clear away any ice, snow or leaves from the air inlets at the base of the windshield that may block the flow of air into your vehicle.
- Use of non-GM approved hood deflectors may adversely affect the performance of the system.
- Keep the area around the base of the instrument panel console and air path under the seats clear of objects to help circulate the air inside of your vehicle more effectively.

Passenger Compartment Air Filter

The passenger compartment air filter removes certain odor and particles from the air including pollen and dust particles. Reductions in airflow, which may occur more often in dusty areas, indicate that the filter may need to be replaced early.

The filter should be replaced as part of the routine scheduled maintenance. See *Scheduled Maintenance on page 7-4* for more information.

To check or replace the air filter, do the following:

1. With the hood open, unlatch and remove the access panel.

The passenger compartment air filter and access panel are located on the passenger's side of the engine compartment near the battery. See *Engine Compartment Overview on page 6-12* for more information on location.

2. Pull the old filter out of the housing.
3. Insert the new filter into the housing. The filter should be fully inserted with the arrows pointing up.
4. Reinstall the air filter access panel.

Warning Lights, Gages, and Indicators

This part describes the warning lights and gages that may be on your vehicle. The pictures will help you locate them.

Warning lights and gages can signal that something is wrong before it becomes serious enough to cause an expensive repair or replacement. Paying attention to your warning lights and gages could also save you or others from injury.

Warning lights come on when there may be or is a problem with one of your vehicle's functions. As you will see in the details on the next few pages, some warning lights come on briefly when you start the engine just to let you know they are working. If you are familiar with this section, you should not be alarmed when this happens.

Gages can indicate when there may be or is a problem with one of your vehicle's functions. Often gages and warning lights work together to let you know when there is a problem with your vehicle.

When one of the warning lights comes on and stays on when you are driving, or when one of the gages shows there may be a problem, check the section that tells you what to do about it. Please follow this manual's advice. Waiting to do repairs can be costly — and even dangerous. So please get to know your warning lights and gages. They are a big help.

Your vehicle may also have a Driver Information Center that works along with the warning lights and gages. See *Driver Information Center (DIC) on page 3-64*.

Instrument Panel Cluster

Your instrument panel cluster and Driver Information Center (DIC) are designed to let you know at a glance how the vehicle is running. You will know how fast you are going, about how much fuel you have left and many other things you will need to know to drive safely and economically. The instrument panel cluster indicator warning lights, gages and DIC messages are explained on the following pages.

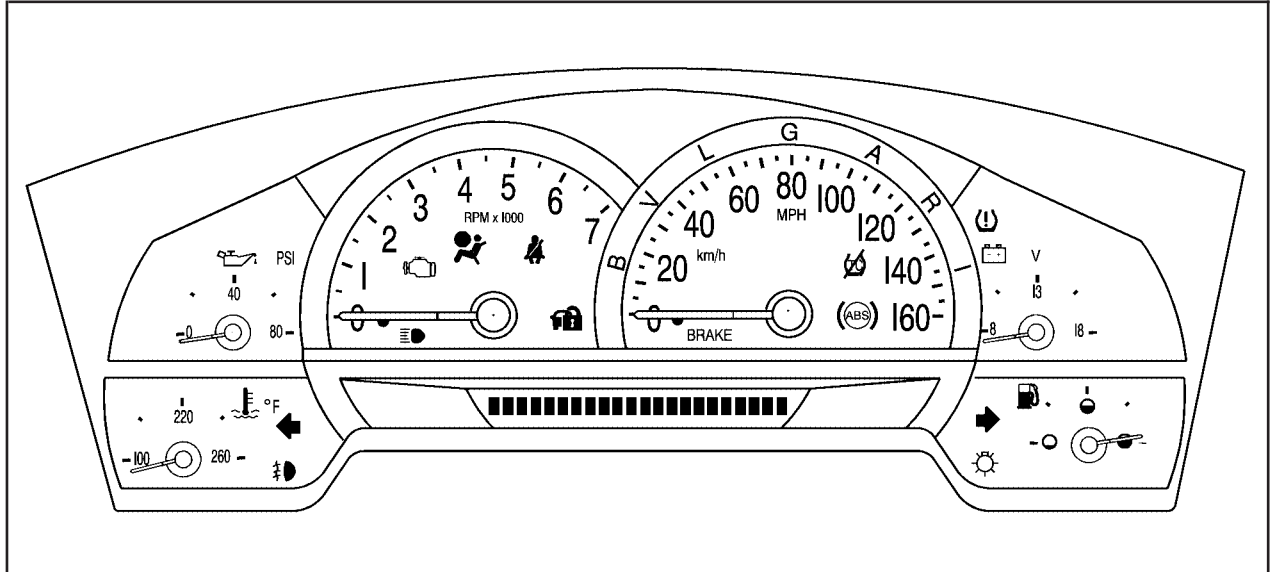

United States shown, Canada similar

Speedometer and Odometer

Your speedometer lets you see your speed in either miles per hour (mph) or kilometers per hour (km/h).

There is only one scale for mph and km/h. Use the Driver Information Center (DIC) controls to switch between mph and km/h. See *DIC Controls and Displays on page 3-64* for more information. The cluster will calculate the proper speed and move the needle to the correct position. Either the MPH or the km/h telltale will illuminate, depending on which measurement you choose.

The odometer is part of the Driver Information Center (DIC). See *DIC Controls and Displays on page 3-64* for more information.

Trip Odometer

The trip odometer is part of the Driver Information Center (DIC). See *DIC Controls and Displays on page 3-64* for more information.

Tachometer

The tachometer displays the engine speed in thousands of revolutions per minute (rpm).

Fuel will shut off at about 6700 rpm.

If you continue to drive your vehicle at the fuel shut off rpm, you could damage your engine. Be sure to operate your vehicle below the fuel shut off rpm or reduce your rpm quickly when the fuel shuts off.

Safety Belt Reminder Light

When the ignition button is pressed to START, a chime will be provided for several seconds to remind people to buckle their safety belts. The driver safety belt light will also be provided and stay on for several seconds, then it will flash for several more. You should buckle your seat belt.



This chime and light will be repeated if the driver remains unbuckled and the vehicle is in motion.

If the driver's belt is buckled, neither the chime nor the light will be provided.

Airbag Readiness Light

There is an airbag readiness light on the instrument panel, which shows a deployed airbag symbol. The system checks the airbag's electrical system for malfunctions. The light tells you if there is an electrical problem. The system check includes the airbag modules, the wiring and the diagnostic module. For more information on the airbag system, see *Airbag System* on page 1-32.

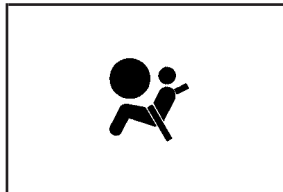

This light will come on when you start your vehicle, and it will flash for a few seconds. Then the light should go out. This means the system is ready.

If the airbag readiness light stays on after you start the vehicle or comes on when you are driving, your airbag system may not work properly. Have your vehicle serviced right away.

CAUTION:

If the airbag readiness light stays on after you start your vehicle, it means the airbag system may not be working properly. The airbags in your vehicle may not inflate in a crash, or they could even inflate without a crash. To help avoid injury to yourself or others, have your vehicle serviced right away if the airbag readiness light stays on after you start your vehicle.

The airbag readiness light should flash for a few seconds when you turn the vehicle on. If the light does not come on then, have it fixed so it will be ready to warn you if there is a problem.

Passenger Airbag Status Indicator

Your rearview mirror has a passenger airbag status indicator.

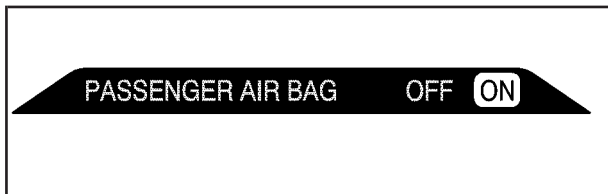

Passenger Airbag Status Indicator – United States

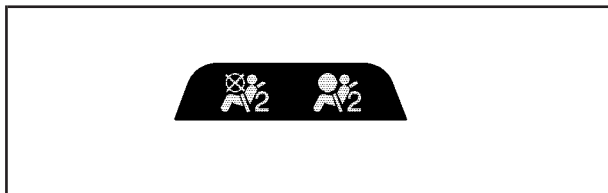

Passenger Airbag Status Indicator – Canada

When the vehicle is started, the passenger airbag status indicator will light ON and OFF, or the symbol for on and off, for several seconds as a system check.

Then, after several more seconds, the status indicator will light either ON or OFF, or either the on or off symbol to let you know the status of the passenger's airbags.

If the word ON or the on symbol is lit on the passenger airbag status indicator, it means that the passenger's airbags are enabled (may inflate).

CAUTION:

If the on indicator comes on when you have a rear-facing child restraint installed in the right front passenger's seat, it means that the passenger sensing system has not turned off the passenger's airbags. A child in a rear-facing child restraint can be seriously injured or killed if the right front passenger's airbag inflates. This is because the back of the rear-facing child restraint would be very close to the inflating airbag. Do not use a rear-facing child restraint in the right front passenger's seat if the airbag is turned on.

 **CAUTION:**

Even though the passenger sensing system is designed to turn off the passenger's airbags if the system detects a rear-facing child restraint, no system is fail-safe, and no one can guarantee that an airbag will not deploy under some unusual circumstance, even though it is turned off. We recommend that rear-facing child restraints be transported in vehicles with a rear seat that will accommodate a rear-facing child restraint, whenever possible.

If the word OFF or the off symbol is lit on the passenger airbag status indicator, it means that the passenger sensing system has turned off the passenger's airbags. See *Passenger Sensing System on page 1-40* for more on this, including important safety information.

If, after several seconds, all status indicator lights remain on, or if there are no lights at all, there may be a problem with the lights or the passenger sensing system. See your dealer for service.

 **CAUTION:**

If the airbag off indicator and the airbag readiness light ever come on together, it means that something may be wrong with the airbag system. If this ever happens, have the vehicle serviced promptly, because an adult-size person sitting in the right front passenger seat may not have the protection of the airbags. See *Airbag Readiness Light on page 3-51*.

Voltmeter Gage

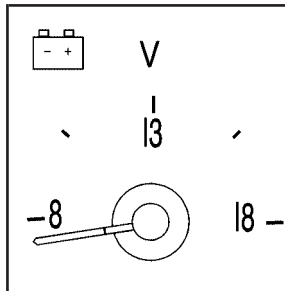

When the vehicle is in accessory mode, the voltmeter shows the voltage output of your battery. When the engine is running, it shows the voltage output of the charging system.

The reading will change as the rate of charge changes (with engine speed, for example), but if the voltmeter reads at 9 volts or below, your instrument panel cluster and other systems may shut down. The Driver Information Center (DIC) will read **LOW VOLTAGE** when your vehicle is at 10 volts or below. Have it checked right away. Driving with the voltmeter reading at 10 volts or below could drain your battery and disable your vehicle.

Brake System Warning Light

Your vehicle's hydraulic brake system is divided into two parts. If one part is not working, the other part can still work and stop you. For good braking, though, you need both parts working well.



United States

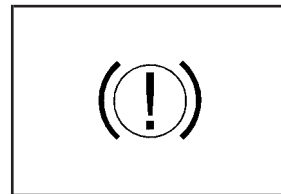

Canada

This light should come on when you start the engine. If it does not come on then, have it fixed so it will be ready to warn you if there is a problem.

If this warning light stays on after you start the engine, the parking brake may still be set or there could be a brake problem. Refer to *Parking Brake* on page 2-29 to see if it is set. If the parking brake is not set, have your brake system inspected right away.

If the light comes on while you are driving and you have a LOW BRAKE FLUID message showing on the DIC, pull off the road and stop carefully. You may notice that the pedal is harder to push. Or, the pedal may go closer to the floor. It may take longer to stop. If the light is still on, have the vehicle towed for service. See *Towing Your Vehicle on page 5-37*.

 **CAUTION:**

Your brake system may not be working properly if the brake system warning light is on. Driving with the brake system warning light on can lead to an accident. If the light is still on after you have pulled off the road and stopped carefully, have the vehicle towed for service.

Anti-Lock Brake System Warning Light

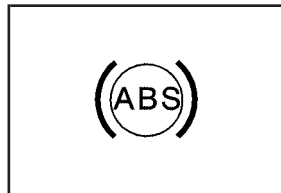

With the anti-lock brake system, the light will come on when your engine is started and may stay on for several seconds. That is normal.

If the light stays on, turn the ignition off. Or, if the light comes on when you are driving, stop as soon as possible and turn the ignition off. Then start the engine again to reset the system. If the light still stays on, or comes on again while you are driving, your vehicle needs service. If the regular brake system warning light is not on, you still have brakes, but you do not have anti-lock brakes. If the regular brake system warning light is also on, you do not have anti-lock brakes and there is a problem with your regular brakes. See “Service ABS” under *DIC Warnings and Messages on page 3-67*.

The anti-lock brake system warning light will come on briefly when you turn the ignition on. This is normal. If the light does not come on then, have it fixed so it will be ready to warn you if there is a problem.

Traction Control System (TCS) Warning Light

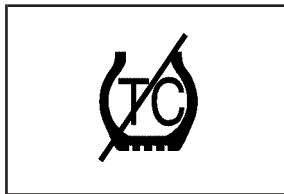

This light should come on briefly as you start the engine. If the light does not come on then, have it fixed so it will be ready to warn you if there is a problem.

The light will also come on while the StabiliTrak[®] system warms up and the STABILITRAK WARMING message will be displayed in the Driver Information Center (DIC).

If it stays on, or comes on and the DIC shows a SERVICE TRACTION SYS message when you are driving, there is a problem with your TCS and your vehicle needs service. When this light is on, the system will not limit wheel spin. Adjust your driving accordingly. If the driver turns off TCS by pressing the button on the console, the TCS system light will come on and the TRACTION SYSTEM-OFF message will show on the DIC.

If the light stays on or comes on while you are driving, a chime sounds and a SERVICE STABILITRAK message appears on the DIC, there is a problem with your StabiliTrak[®] and the vehicle needs service.

You can acknowledge this message by pressing the RESET button. When the SERVICE STABILITRAK message is displayed, the StabiliTrak[®] system will not assist you in controlling the vehicle. You should have the system serviced as soon as possible. Adjust your driving accordingly.

When the system is working, you will see the STABILITRAK ACTIVE message displayed in the DIC. You may also feel or hear the system working. This is normal.

If you turn off the StabiliTrak[®] system, by pressing the front part of the button on the console for five seconds, the traction control system light will come on, a chime will sound and the TRAC/STABILITRAK OFF message will be displayed in the DIC. The Traction Control System will also be turned off. See *DIC Warnings and Messages on page 3-67* for more information.

If the StabiliTrak[®] system and Traction Control System are turned off, pressing the console button momentarily will turn both systems on. The DIC will display the TRAC/STABILITRAK ON message, the instrument cluster light will be off and a chime will sound. See *DIC Warnings and Messages on page 3-67* for more information.

Engine Coolant Temperature Gage

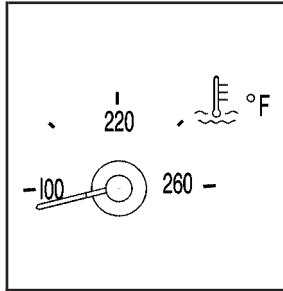

United States

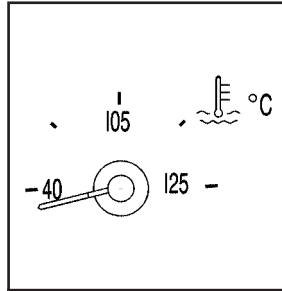

Canada

This gage shows the engine coolant temperature.

As the pointer nears 260°F (125°C), your engine coolant temperature is high. A message may display on the Driver Information Center (DIC) depending on how high the temperature is. See *DIC Warnings and Messages on page 3-67* for more information.

See *Engine Overheating on page 6-23* for more information.

Tire Pressure Light

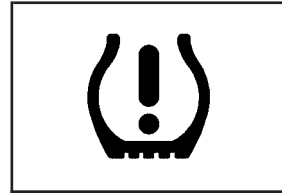

This light should come on briefly as you start the engine. It will then come on only when a flat or low tire pressure condition exists.

See *Tire Pressure Monitor System on page 6-55* for more information.

Malfunction Indicator Lamp

Check Engine Light

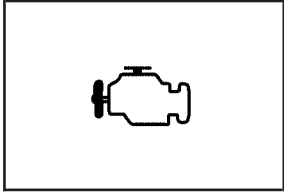

Your vehicle is equipped with a computer which monitors operation of the fuel, ignition, and emission control systems.

This system is called OBD II (On-Board Diagnostics-Second Generation) and is intended to assure that emissions are at acceptable levels for the life of the vehicle, helping to produce a cleaner environment. The Check Engine light comes on to indicate that there is a problem and service is required. Malfunctions often will be indicated by the system before any problem is apparent. This may prevent more serious damage to your vehicle. This system is also designed to assist your service technician in correctly diagnosing any malfunction.

Notice: If you keep driving your vehicle with this light on, after awhile, your emission controls may not work as well, your fuel economy may not be as good, and your engine may not run as smoothly. This could lead to costly repairs that may not be covered by your warranty.

Notice: Modifications made to the engine, transmission, exhaust, intake, or fuel system of your vehicle or the replacement of the original tires with other than those of the same Tire Performance Criteria (TPC) can affect your vehicle's emission controls and may cause this light to come on. Modifications to these systems could lead to costly repairs not covered by your warranty. This may also result in a failure to pass a required Emission Inspection/Maintenance test. See *Accessories and Modifications* on page 6-3.

This light should come on briefly, as a check to show you it is working, as you start the engine. If the light does not come on, have it repaired. This light will also come on during a malfunction in one of two ways:

- **Light Flashing** — A misfire condition has been detected. A misfire increases vehicle emissions and may damage the emission control system on your vehicle. Diagnosis and service may be required.
- **Light On Steady** — An emission control system malfunction has been detected on your vehicle. Diagnosis and service may be required.

If the Light Is Flashing

The following may prevent more serious damage to your vehicle:

- Reducing vehicle speed
- Avoiding hard accelerations
- Avoiding steep uphill grades

If the light stops flashing and remains on steady, see “If the Light Is On Steady” following.

If the light continues to flash, when it is safe to do so, stop the vehicle. Find a safe place to park your vehicle. Turn the engine off, wait at least 10 seconds and restart the engine. If the light remains on steady, see “If the Light Is On Steady” following. If the light is still flashing, follow the previous steps, and see your dealer for service as soon as possible.

If the Light Is On Steady

You also may be able to correct the emission system malfunction by considering the following:

Did you recently put fuel into your vehicle?

If so, reinstall the fuel cap, making sure to fully install the cap. See *Filling the Tank on page 6-7*. The diagnostic system can determine if the fuel cap has been left off or improperly installed.

A loose or missing fuel cap will allow fuel to evaporate into the atmosphere. A few driving trips with the cap properly installed should turn the light off.

Did you just drive through a deep puddle of water?

If so, your electrical system may be wet. The condition will usually be corrected when the electrical system dries out. A few driving trips should turn the light off.

Have you recently changed brands of fuel?

If so, be sure to fuel your vehicle with quality fuel. See *Gasoline Octane on page 6-5*. Poor fuel quality will cause your engine not to run as efficiently as designed. You may notice this as stalling after start-up, stalling when you put the vehicle into gear, misfiring, hesitation on acceleration, or stumbling on acceleration. (These conditions may go away once the engine is warmed up.) This will be detected by the system and cause the light to turn on.

If you experience one or more of these conditions, change the fuel brand you use. It will require at least one full tank of the proper fuel to turn the light off.

If none of the above steps have made the light turn off, your dealer can check the vehicle. Your dealer has the proper test equipment and diagnostic tools to fix any mechanical or electrical problems that may have developed.

Emissions Inspection and Maintenance Programs

Some state/provincial and local governments have or may begin programs to inspect the emission control equipment on your vehicle. Failure to pass this inspection could prevent you from getting a vehicle registration.

Here are some things you need to know to help your vehicle pass an inspection:

Your vehicle will not pass this inspection if the Check Engine light is on or not working properly.

To perform a Check Engine light bulb check with the keyless ignition, make sure the transmitter fob is in the passenger compartment. See *Ignition Positions on page 2-21*. Press the bottom of the ACC button on the instrument panel and hold the button down for five seconds. The instrument panel, including the

Check Engine light, will light up and the ignition will be on, but the engine will not start — if you press the bottom of the ACC button only briefly, less than five seconds, the accessory mode will be turned on, but not the ignition. After the bulb check, be sure to press and release the ACC button again to turn the ignition off and avoid draining the vehicle's battery.

Your vehicle will not pass this inspection if the OBD (on-board diagnostic) system determines that critical emission control systems have not been completely diagnosed by the system. The vehicle would be considered not ready for inspection. This can happen if you have recently replaced your battery or if your battery has run down. The diagnostic system is designed to evaluate critical emission control systems during normal driving. This may take several days of routine driving. If you have done this and your vehicle still does not pass the inspection for lack of OBD system readiness, your GM dealer can prepare the vehicle for inspection.

Engine Oil Pressure Gage

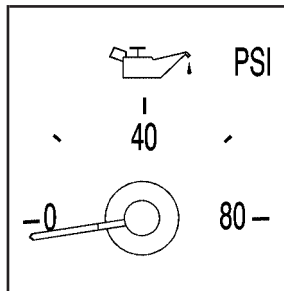

United States

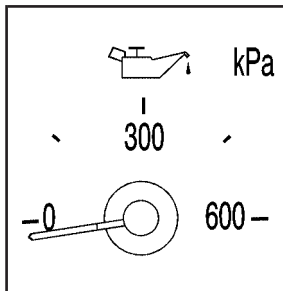

Canada

The engine oil pressure gage shows the engine oil pressure in psi (pounds per square inch) or kPa (kilopascals) when the engine is running.

Oil pressure should be 20 to 80 psi (140 to 550 kPa). In certain situations such as long, extended idles on hot days, it could read as low as 6 psi (40 kPa) and still be considered normal. It may vary with engine speed, outside temperature and oil viscosity.

The Driver Information Center (DIC) may display messages regarding the oil condition. See *DIC Warnings and Messages* on page 3-67 and *Engine Oil* on page 6-13.

CAUTION:

Do not keep driving if the oil pressure is low. If you do, your engine can become so hot that it catches fire. You or others could be burned. Check your oil as soon as possible and have your vehicle serviced.

Notice: Lack of proper engine oil maintenance may damage the engine. The repairs would not be covered by your warranty. Always follow the maintenance schedule in this manual for changing engine oil.

Security Light

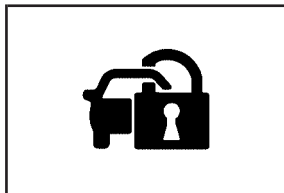

For information regarding this light, see *Theft-Deterrent Systems* on page 2-18.

Fog Lamp Light

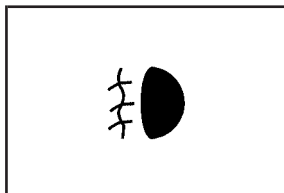

The fog lamps light will come on when the fog lamps are in use.

The light will go out when the fog lamps are turned off. See *Fog Lamps* on page 3-31 for more information.

Lights On Reminder

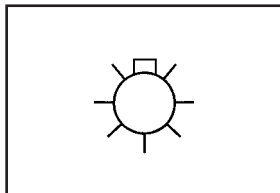

This light comes on whenever the headlamps are on.

United States Only

Highbeam On Light

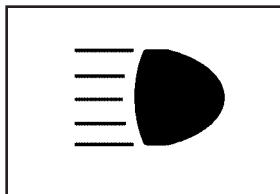

This light will come on when the high-beam headlamps are in use.

See *Headlamp High/Low-Beam Changer* on page 3-8.

Fuel Gage

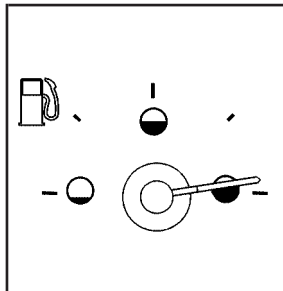

Your fuel gage tells you about how much fuel you have left when the ignition is on.

When the needle approaches the low fuel symbol, LOW FUEL will appear on the Driver Information Center (DIC) display. At this time, you still have a little fuel left, but you should get more soon.

Press RESET to acknowledge a DIC message(s). Pressing RESET will also turn off a DIC message but the LOW FUEL message will come on again in 10 minutes if you have not added fuel to the vehicle.

Here are five things that some owners ask about. All these things are normal and do not indicate that anything is wrong with the fuel gage.

- At the gas station, the gas pump shuts off before the gage reads the full symbol.
- It takes more (or less) fuel to fill up than the gage reads. For example, the gage reads half full, but it took more (or less) than half of the tank's capacity to fit it.
- The gage pointer may move while cornering, braking or speeding up.
- The gage may not indicate the tank is empty when the ignition is turned off.
- The gage reading may change slightly within the first several minutes after starting the vehicle.

You can use the Driver Information Center (DIC) to display more detailed fuel information. While scrolling through the DIC, you will also find:

- **AVERAGE XX.X MPG (Average Miles Per Gallon):**
The fuel economy calculated for the last 20 gallons (76 L) of fuel used, or since you last reset the display.
- **INST XX.X MPG (Instantaneous Miles Per Gallon):**
The fuel economy calculated for your current driving conditions.
- **RANGE XXX MI:** The approximate distance you can drive before refueling.

See *DIC Controls and Displays* on page 3-64 for more information.

You should reset the fuel information display every time you refuel. To reset AVERAGE, use the information up or down button to scroll to AVE FUEL ECON and hold the reset button. RANGE will automatically reset.

Driver Information Center (DIC)

This display gives you the status of many of your vehicle's systems. The DIC is also used to display driver personalization features and warning/status messages. All messages will appear in the DIC display, located at the bottom of the instrument panel cluster.

DIC Controls and Displays

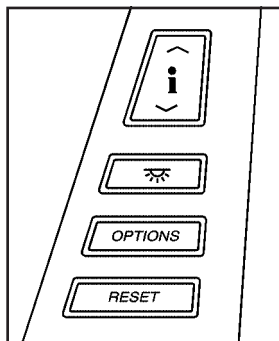

The Driver Information Center (DIC) buttons are located to the right of the steering wheel on the instrument panel, near the air outlets.

 **(Information):** Press the top or bottom of this button to scroll through the available features which include the odometer, trip odometers, fuel range, miles per gallon, average speed, timer, tire pressure, and remaining oil life.

 **(Interior Lamps):** Press this button to turn the interior lamps on and off.

OPTIONS: Press this button to choose personal options that are available on your vehicle.

RESET: Press this button to reset a feature. It is also used to switch between English and Metric options.

Use the information button to scroll through the following options:

ODOMETER: This feature shows how far the vehicle has been driven in either miles (mi) or kilometers (km). Use the ENG/METRIC feature to switch between English and Metric units.

TRIP A: This feature will record the distance traveled since the last time it was reset. Press and hold the RESET button to return to zero. If your vehicle is first sold in the United States, the trip odometer will return to zero after 999.9 miles (1 609 km). If your vehicle is first sold in Canada, the trip odometer will return to zero after 1,242 miles (1 999 km).

TRIP B: This feature allows you to record the distance traveled during a second trip and functions the same as TRIP A.

RANGE xxx MI: This feature shows about how many miles (mi) or kilometers (km) you can drive without refilling your fuel tank. Once the range drops below 40 miles (64 km) remaining, the display will show LOW.

If the vehicle has been idling for a long time, the range displayed on the DIC could be abnormally low. The vehicle must be driven 5-10 miles (8-16 km) to get an accurate reading.

AVERAGE xx.x MPG (Average Miles Per Gallon): This feature shows the approximate fuel economy the vehicle has averaged since the last time the value was reset. To reset the average miles per gallon, press the information button to display AVERAGE xx.x MPG, then press and hold the RESET button until AVERAGE 00.0 MPG is displayed.

INST xx.x MPG (Instantaneous Miles Per Gallon): This feature shows the instantaneous fuel economy which varies with your driving conditions, such as acceleration, braking, and the grade of the road being traveled. The RESET button does not function in this mode.

AVERAGE SPEED: This feature shows the average speed the vehicle has traveled since the last time the value was reset. To reset the value, press the information button to display AVERAGE SPEED, then press and hold the RESET button until AVERAGE SPEED 00.0 is displayed.

ELAPSED TIME: This feature is like a stopwatch, in that you can clock the time it takes to get from one point to another.

To operate, press the information button to display ELAPSED TIME. Each of the fields for the hours, minutes, and seconds are two numeric digits.

Once ELAPSED TIME 00:00:00 is displayed, press the RESET button to start the timing feature. Press the RESET button again to stop it. If you will be starting and stopping your vehicle, during a trip for instance, the ELAPSED TIME feature will automatically start timing where it left off when you last stopped. To reset it, press and hold the RESET button until the display reads ELAPSED TIME 00:00:00. Press the information button to exit from the ELAPSED TIME display.

FRONT Lxx Rxx PSI: This feature shows the tire pressure for the front left and right tires.

REAR Lxx Rxx PSI: This feature shows the tire pressure for the rear left and right tires.

OIL LIFE: This feature shows the estimated oil life remaining. See *Oil Life Indicator on page 3-82* for more information. To reset the engine oil life system, see *Engine Oil Life System on page 6-16*. This only needs to be reset after you have had the oil changed.

In addition to the engine oil life system monitoring oil life, additional maintenance is recommended in the Maintenance Schedule in this manual. See *Scheduled Maintenance on page 7-4* and *Engine Oil on page 6-13* for more information.

ENG/METRIC (English/Metric): This feature allows you to switch the DIC displays between English and Metric. Press the RESET button to switch the display between English and Metric. There will be an arrow next to the option that is selected.

DIC Warnings and Messages

These messages will appear if there is a problem detected in one of your vehicle's systems. You must then press RESET to clear the display screen for further use. However, be sure to take any message that appears on the display screen seriously and remember that pressing the RESET button will only make the message disappear, not the problem.

DIC messages can also be displayed in English, French, German, Italian, and Spanish.

ABS (Anti-Lock Brake System) ACTIVE: When your anti-lock system is adjusting brake pressure to help avoid a braking skid, the ABS ACTIVE message will be displayed.

Slippery road conditions may exist if this message is displayed, so adjust your driving accordingly. The message may stay on for a few seconds after the system stops adjusting brake pressure.

BATTERY SAVER ACTIVE: This message is displayed when the vehicle has detected that the battery voltage is dropping beyond a reasonable point. The battery saver system will start reducing certain features of the vehicle that you may not be able to notice. At the point that features are disabled, this message is displayed. It means that the vehicle is trying to save the charge in the battery. Turn off unnecessary accessories to allow the battery to recharge.

BUCKLE PASSENGER: This message reminds you to buckle the passenger's seat belt.

This message will display and a chime will sound when the ignition is on, the driver's seat belt is buckled, the passenger's seat belt is unbuckled with the passenger airbag enabled, and the vehicle is in motion. You should have the passenger buckle their seat belt.

The reminder will be repeated if the ignition is on, the vehicle is in motion, the driver is buckled and the passenger is still unbuckled, and the passenger airbag is enabled. If the passenger's seat belt is already buckled, this message and chime will not come on.

BUCKLE SEAT BELT: This message reminds you to buckle the driver's seat belt.

This message will display and a chime will sound when the ignition is on, the driver's seat belt is unbuckled, and the vehicle is in motion. You should buckle your seat belt.

If the driver remains unbuckled when the ignition is on and the vehicle is in motion, the reminder will be repeated. If the driver's seat belt is already buckled, this message and chime will not come on.

This message is an additional reminder to the Safety Belt Reminder Light in the instrument panel cluster. See *Safety Belt Reminder Light on page 3-50* for more information.

CHANGE OIL NOW: This means that the life of the engine oil has expired. See *Scheduled Maintenance on page 7-4*. After an oil change, the Oil Life Indicator must be reset. See *Oil Life Indicator on page 3-82* and *Engine Oil Life System on page 6-16*.

CHARGE SYSTEM FAULT: This message will display when a problem with the charging system has been detected. Have your vehicle serviced by your GM dealer.

CHECK GAS CAP: This message will appear if the gas cap has not been fully tightened. You should recheck your gas cap to ensure that it is on properly.

CLEAN RADAR CRUISE: This message indicates the Adaptive Cruise Control (ACC) system is disabled because the radar is blocked and cannot detect vehicles in your path. It may also activate during heavy rain or due to road spray. To clean the system, see "Adaptive Cruise Control (ACC)" under *Turn Signal/Multifunction Lever on page 3-7*.

CLOSE CARGO DIVIDER: This message indicates that the cargo divider is not in place. Open the trunk and make sure the cargo divider is secure and no objects are on the divider. See *Rear Storage Area on page 2-45* for more information.

COOLANT OVER TEMP (Temperature): This message will appear when the engine coolant temperature is too hot. Stop and allow your vehicle to idle in PARK (P) until it cools down and the message is removed. Do not increase engine speed above a normal idle. If it does not cool down, turn off the engine and have it serviced by your GM dealer before driving it again. Severe engine damage can result from an overheated engine. See *Engine Overheating on page 6-23*.

CRUISE NOT READY: This message indicates that ACC will not activate due to a temporary condition. Your vehicle does not require service. If this message appears when you attempt to activate the system, continue driving for several minutes then try again to activate the system.

DRIVER NO. X (1 OR 2): This message will be displayed when the vehicle is started or when there is a change of driver. The message will show which driver is activating the personalization feature. It will only stay on for five seconds.

ENGINE HOT, STOP ENGINE: This message will appear when the engine has overheated. Stop and turn the engine off immediately to avoid severe engine damage. See *Engine Overheating on page 6-23*. A multiple chime will also sound when this message is displayed.

ENGINE PROTECTION REDUCE ENGINE RPM: If this message appears, the control system has determined that continued operation at the existing engine speed may lead to engine overheating. Therefore, you should lower the engine speed by upshifting the transmission or drive at a lower speed.

HEADLAMPS SUGGESTED: If it is dark enough outside and the headlamps and Twilight Sentinel® controls are off, this message will display on the DIC. This message informs the driver that turning on the exterior lamps is recommended. It has become dark enough outside to require the headlamps and/or other exterior lamps. This message will also appear if the optional Rainsense™ wiping feature is on and the Twilight Sentinel® is off.

HIGH TRANS (Transmission) TEMP (Temperature): This message indicates that the transmission fluid in your vehicle is too hot. Stop and allow your vehicle to idle until it cools down or until this message is removed.

HIGH VOLTAGE: This message shows that the electrical charging system is overcharging. To avoid being stranded, have the electrical system checked by your GM dealer. You can reduce the charging overload by using the accessories. Turn on the lamps and radio, set the climate control on AUTO and the fan speed on HI, and turn the rear window defogger on. You can monitor battery voltage on the DIC by pressing the information button. The normal range is 11.5 to 15.5 volts when the engine is running.

HOT ENGINE–A/C OFF: This message displays when the engine coolant becomes hotter than the normal operating temperature. To avoid added strain on a hot engine, the air conditioning compressor is automatically turned off. When the coolant temperature returns to normal, the A/C operation will automatically resume. You can continue to drive your vehicle. If this message continues to appear, have the system repaired by your GM dealer as soon as possible to avoid compressor damage.

ICE POSSIBLE: This message appears when the outside air temperature is cold enough to create icy road conditions.

LEFT DOOR AJAR: This message will display anytime the vehicle engine is running, the transmission is not in PARK (P) and the driver's door is open or ajar. A chime will sound when the vehicle's speed is greater than 3 mph (4.8 km/h).

LOW BRAKE FLUID: This message will display if the vehicle is running to inform the driver that the brake fluid level is low. Have the brake system serviced by your GM dealer as soon as possible. See "Brake Fluid" under *Brakes on page 6-33*.

LOW COOLANT: This message will appear when there is a low level of engine coolant. Have the cooling system serviced by your GM dealer as soon as possible. See *Engine Coolant on page 6-20*.

LOW FUEL: This message will appear when the fuel supply is less than 5 gallons (18.9 L) and the display is turned off. A single chime will also sound when this message is displayed.

LOW OIL LEVEL: For correct operation of the low oil sensing system, your vehicle should be on a level surface. A false LOW OIL LEVEL message may appear if the vehicle is parked on a grade. The oil level sensing system does not check for actual oil level if the engine has been off for a short period of time, and the oil level is never checked while the engine is running. If the LOW OIL LEVEL message appears, and your vehicle has been parked on level ground with the engine off for at least 30 minutes, the oil level should be checked by observing the oil dipstick. Prior to checking the oil level, be sure the engine has been off for a few minutes and your vehicle is on a level surface. Then check the dipstick and add oil if necessary. See *Engine Oil on page 6-13*.

LOW OIL PRESSURE: If this message appears while the engine is running, stop the engine and do not operate it until the cause of low oil pressure is corrected. Severe damage to the engine can result. A multiple chime will sound when this message is displayed.

LOW VOLTAGE: This message will appear when the electrical system is charging less than 10 volts or if the battery has been drained. If this message appears immediately after starting, it is possible that the generator can still recharge the battery. The battery should recharge while driving but may take a few hours to do so. Consider using an auxiliary charger to boost the battery after returning home or to a final destination. Be sure to follow the manufacturer's instructions. If this message appears while driving or after starting your vehicle and stays on, have it checked immediately by your GM dealer to determine the cause of this problem.

To help the generator recharge the battery quickly, you can reduce the load on the electrical system by turning off the accessories. You can monitor battery voltage on the DIC by pressing the INFO button. The normal range is 11.5 to 15.5 volts.

LOW WASHER FLUID: This message means that your vehicle is low on windshield washer fluid. See *Windshield Washer Fluid* on page 6-32.

MAX (Maximum) SPEED XX MPH (XX KM/H):
A failure in the magnetic ride control system has occurred when this message appears. The Powertrain Control Module (PCM) determines the speed to which your vehicle is limited. Have your vehicle serviced by your GM dealer if this message appears.

NO FOB DETECTED: This message is displayed if the vehicle does not detect the presence of a keyless access transmitter when you have attempted to start the vehicle or a vehicle door has just closed. The following conditions may cause this message to appear:

- Driver-added equipment plugged into the accessory power outlet on the center console is causing interference. Examples of these devices are cell phones and cell phone chargers, two-way radios, power inverters, or similar items. Try moving the keyless access transmitter away from these devices when starting the vehicle. In addition, PDA devices and remote garage and gate openers may also generate Electromagnetic Interference (EMI) that may interfere with the keyless access transmitter. Do not carry the keyless access transmitter in the same pocket or bag as these devices.

- The vehicle is experiencing Electromagnetic Interference (EMI). Some locations, such as airports, automatic toll booths, and some gas stations, have EMI fields which may interfere with your keyless access transmitter.

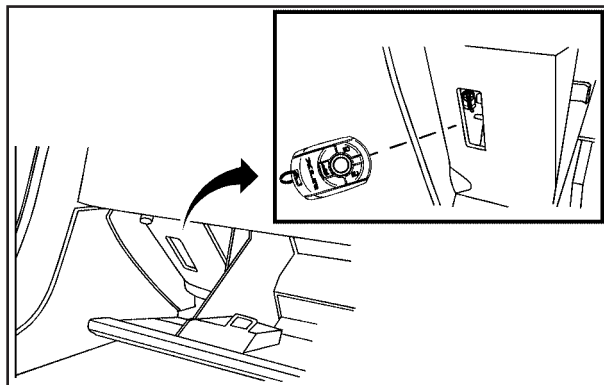

If moving the transmitter to different locations within the vehicle does not help, place the transmitter in the glove box transmitter pocket with the buttons facing to the right and then press the START button.

NO FOB, OFF OR RUN?: When this message displays, it means that the keyless access transmitter is not detected inside the vehicle while you are trying to turn the ignition off. Your vehicle may be near a strong radio antenna signal causing the keyless access system to be jammed. The vehicle will remain in ACC until off or START has been pressed or five minutes has expired. If you turn the ignition off and you cannot find the keyless access transmitter, you will not be able to restart the vehicle. The keyless access transmitter needs to be inside of the vehicle in order for the vehicle to start. See *Starting the Engine on page 2-22* for more information.

OVER SPEED WARNING: This message is displayed when the vehicle speed exceeds a certain limit as required by some export countries. A chime will sound when this message is displayed.

PRESS BRAKE TO START: The brake pedal must be applied to start the vehicle. Make sure you are pressing the brake pedal all the way down.

REDUCED ENGINE POWER: This message informs you that the vehicle is reducing engine power because the transmission is being placed in gear under conditions that may cause damage to the vehicle's engine, transmission, or ability to accelerate.

RIGHT DOOR AJAR: The passenger's door is open or ajar when this message appears. The vehicle must be running and the transmission not in PARK (P) for this message to display. A chime will sound if the vehicle's speed is greater than 3 mph (5 km/h).

SERVICE A/C: This message appears when the electronic sensors that control the air conditioning and heating systems are no longer working. Have the climate control system serviced by your GM dealer if you notice a drop in heating and air conditioning efficiency.

SERVICE ABS (Anti-Lock Brake System): If the SERVICE ABS message is displayed when you are driving, stop as soon as possible and turn the ignition off. Then start the engine again to reset the system. If the message stays on, or comes back on again while you are driving, your vehicle is in need of service. See your GM dealer.

If the SERVICE ABS message is being displayed, your Traction Control System and StabiliTrak[®] System will also be disabled. The Driver Information Center will scroll three messages: SERVICE ABS, SERVICE TRACTION SYS and SERVICE STABILITRAK, and the anti-lock brake system and traction control warning lights on the instrument panel cluster will be illuminated. See *Anti-Lock Brake System Warning Light on page 3-55* and *Traction Control System (TCS) Warning Light on page 3-56*. The driver can acknowledge these messages by pressing the RESET button three times.

When the service message is displayed, the computer controlled systems will not assist the driver and you should have the system repaired by your GM dealer as soon as possible. Adjust your driving accordingly.

SERVICE AFS LAMPS: This message indicates that the Adaptive Forward Lighting System (AFS) is disabled and needs service. See your GM dealer. See *Adaptive Forward Lighting System on page 3-31* for more information.

SERVICE ELECT (Electrical) SYSTEM: This message will display if an electrical problem has occurred within the Powertrain Control Module (PCM). Have your vehicle serviced by your GM dealer.

SERVICE FUEL SYSTEM: The Powertrain Control Module (PCM) has detected a problem within the fuel system when this message appears. Have your vehicle serviced by your GM dealer. This message will also be displayed when the cluster is not getting fuel information from the PCM.

SERVICE RADAR CRUISE: This message indicates that the Adaptive Cruise Control (ACC) system is disabled and needs service. See your GM dealer.

SERVICE RIDE CONTROL: This message indicates there is a problem with the Magnetic Ride Control System. Have your vehicle serviced by your GM dealer.

SERVICE TRACTION SYS (System): This message indicates there is a problem with the Traction Control System (TCS). Have your vehicle serviced by your GM dealer.

SERVICE STABILITRAK: If this message appears, it means there may be a problem with your stability enhancement system. If you see this message, try to reset the system. Stop, turn off the engine, then start the engine again. If the SERVICE STABILITRAK message still comes on, it means there is a problem. You should see your GM dealer for service. Reduce your speed and drive accordingly. A single chime will also sound when this message is displayed.

SERVICE TRANSMISSION: This message indicates that there is a problem with the transmission. Have your vehicle serviced by your GM dealer.

SERVICE VEHICLE SOON: This message is displayed when a non-emissions related powertrain malfunction occurs. Have your vehicle serviced by your GM dealer as soon as possible.

SHIFT TO PARK: This message indicates that the vehicle is not in PARK (P) when the engine is being turned off. The vehicle will be in accessory mode. Once the shifter is moved to PARK (P), the vehicle will turn off.

STABILITRAK ACTIVE: You may see the STABILITRAK ACTIVE message on the DIC. It means that an advanced, computer-controlled system has come on to help your vehicle continue to go in the direction in which you are steering. This stability enhancement system activates when the computer senses that your vehicle is just starting to spin, as it might if you hit a patch of ice or other slippery spot on the road. When the system is on, you may hear a noise or feel a vibration in the brake pedal. This is normal.

When the STABILITRAK ACTIVE message is on, you should continue to steer in the direction you want to go. The system is designed to help you in bad weather or other difficult driving situations by making the most of whatever road conditions will permit. If the STABILITRAK ACTIVE message comes on, you will know that something has caused your vehicle to start to spin, so you should consider slowing down. A single chime will also sound when this message is displayed.

STABILITRAK READY: If this message appears and a chime sounds, the system has completed the functional check of the StabiliTrak[®] System.

STABILITRAK WARMING: When you first start your vehicle and drive away, especially during cold winter weather, the STABILITRAK WARMING message may be displayed in the DIC along with a chime and the traction control warning light. This is normal. You can acknowledge this message by pressing the RESET button. The StabiliTrak[®] performance is affected until the STABILITRAK READY message is displayed in the DIC, which can take up to 15 minutes.

SVC (Service) TIRE MONITOR: If this message comes on, a part on the Tire Pressure Monitor (TPM) is not working properly. If you drive your vehicle while any of the four sensors are missing or inoperable, the warning will come on in approximately 10 minutes. If all four sensors are missing, the warning will come on in approximately 15 to 20 minutes. All the sensors would be missing, for example, if you put different wheels on your vehicle without transferring the sensors. If the warning comes on and stays on, there may be a problem with the TPM. See your GM dealer.

TOO COLD TO MOVE TOP: This message will display when the retractable hardtop button is pressed and the hardtop pump motor temperature is below -4°F (-20°C). Wait for the hardtop pump motor to warm up before using the retractable hardtop.

TOP INOP (Inoperative) – VALET ON: This message will display when the retractable hardtop button is pressed and the valet switch is on. Turn off the valet switch before using the retractable hardtop.

TOP INOP (Inoperative) OUT OF PARK: This message will display if the retractable hardtop button is pressed while the vehicle is not in PARK (P).

TOP MOTOR OVER TEMP (Temperature): This message will display when the retractable hardtop button is pressed and the hardtop pump motor temperature is over 221°F (105°C). Wait for the hardtop pump motor to cool down before using the retractable hardtop.

TOP NOT SECURE: This message will display when the retractable hardtop button is released before the top open or close operation is complete. Press and hold the retractable hardtop button to fully open or close the top.

TRAC (Traction) SYSTEM ACTIVE: When your traction control system is limiting wheel spin, the TRACTION SYSTEM ACTIVE message will be displayed. Slippery road conditions may exist if this message is displayed, so adjust your driving accordingly. This message will stay on for a few seconds after the traction control system stops limited wheel spin.

TRAC (Traction)/STABILITRAK OFF: This message indicates that both the Traction Control System (TCS) and StabiliTrak® are off. The message will remain until the systems are turned on again.

TRAC (Traction)/STABILITRAK ON: This message indicates that both the Traction Control System (TCS) and the StabiliTrak® are on.

TRACTION SYSTEM OFF: This message indicates that the Traction Control System (TCS) is off but StabiliTrak® remains on.

TRACTION SYSTEM ON: This message indicates that the Traction Control System (TCS) is on.

TRUNK AJAR: This message indicates that the trunk is open while the vehicle is running and not in PARK (P).

WAIT FOR STABILITRAK: This message will be displayed after driving 19 mph (30 km/h) for 10 seconds if the steering is not centered. StabiliTrak® is not available until the steering centers itself and the STABILITRAK READY message is displayed in the DIC.

Other Messages

Here are more messages that you can receive on your Driver Information Center (DIC). To acknowledge a message and read another message that may have come on at the same time, press the RESET button.

- ACCESSORY MODE ON
- CHANGE OIL SOON

(See Engine Oil on page 6-13 and Engine Oil Life System on page 6-16.)

- FOB BATTERY LOW
- HIGH TIRE PRESS LF
- HIGH TIRE PRESS RF
- HIGH TIRE PRESS LR
- HIGH TIRE PRESS RR
- INTRUSION SENSOR OFF
- INTRUSION SENSOR ON
- KNOWN FOB

- LEFT FRONT TIRE FLAT MAX SPD 55, REDUCED HNDLG
- LEFT REAR TIRE FLAT MAX SPD 55, REDUCED HNDLG
- LOW TIRE PRESS LF
- LOW TIRE PRESS RF
- LOW TIRE PRESS LR
- LOW TIRE PRESS RR
- MAX # FOBS LEARNED
- OFF-ACC TO LEARN
- READY FOR FOB #X
- RIGHT FRT TIRE FLAT MAX SPD 55, REDUCED HNDLG
- RIGHT REAR TIRE FLAT MAX SPD 55, REDUCED HNDLG
- WAIT XX MINUTES

DIC Vehicle Personalization

Your vehicle is equipped with personalization capabilities that allows you to program certain features to a preferred setting for up to two drivers. The back of the keyless access transmitters are labelled 1 or 2.

The current driver's preferences are recalled when one of the following occurs:

- The lock or unlock button on the keyless access transmitter, programmed as 1 or 2, is pressed.
- The appropriate memory button, 1 or 2, located on the driver's seat is pressed. See *Memory Seat, Mirrors and Steering Wheel on page 2-56* for more information.
- A valid keyless access transmitter is detected upon opening the driver's door.

If more than one valid keyless access transmitter is detected upon opening the driver's door, the driver preferences for the lowest driver number will be recalled.

If a keyless access transmitter is programmed as #3 or #4, the personalization system will not recognize the transmitter. The Driver Information Center (DIC) will not display a current driver number and the features that are normally programmed through the DIC will be set to the default states. Also, if the OPTIONS button

is pressed, the DIC does not display the menus used to set personalizations, but instead displays OPTIONS UNAVAILABLE for a few seconds.

Feature Programming

To change feature preferences, make sure the vehicle is running and in PARK (P). Press the OPTIONS button and the Driver Information Center (DIC) will display the current driver for a few seconds, then display the first personalization menu item. You can now use the OPTIONS button to change the setting of the displayed feature. Press the top or bottom of the information button to scroll up or down the list of features. When you get to a feature you want to change, press the OPTIONS button again. When you are finished, press the RESET button to exit the personalization menu. If no button is pressed within 45 seconds, the DIC will exit the personalization menu.

The following are DIC options that will be available in the personalization menu.

Auto Recall

This feature allows the steering column, outside mirrors and the driver's seat to automatically move to the current driver's set position when the engine starts. The DIC will display AUTO RECALL OFF or AUTO RECALL ON. Press the OPTIONS button to change the setting.

Auto Exit Recall

This feature allows the steering column and driver's seat to automatically move to the current driver's exit position when one of the following occurs:

- The vehicle is turned off or in RAP or accessory mode and the driver's door is opened.
- The vehicle is turned off or in RAP and the unlock button on the keyless access transmitter is pressed.

The DIC will display AUTO EXIT RECALL OFF or AUTO EXIT RECALL ON. Press the OPTIONS button to change the setting.

Approach Lights

This feature activates the parking lamps, front fog lamps and back-up lamps during low light periods when the unlock button on the keyless access transmitter is pressed, both doors are closed and the vehicle is off or in RAP. The lamps remain on for 20 seconds or until a door is opened, the lock button on the keyless access transmitter is pressed or the vehicle is no longer off or in RAP.

The DIC will display APPROACH LIGHTS OFF or APPROACH LIGHTS ON. Press the OPTIONS button to change the setting.

Exit Lights

This feature activates the parking lamps and front fog lamps for 15, 30 or 90 seconds. This will occur when the vehicle is off or in RAP and the headlamps are on due to the automatic headlamp system. The parking lamps and front fog lamps will remain on until the driver selected time period expires, the exterior lamp control is activated or the vehicle is no longer off or in RAP.

The DIC will display EXIT LIGHTS OFF, EXIT LIGHTS - 15 SEC, EXIT LIGHTS - 30 SEC or EXIT LIGHTS - 90 SEC. Press the OPTIONS button to change the setting.

Flash at Unlock

This feature activates the front and rear turn signals for two short flashes when the unlock or trunk button on the keyless access transmitter is pressed or when OnStar[®] unlocks the doors. This will only occur when the vehicle is off.

The DIC will display NO FLASH AT UNLOCK or FLASH AT UNLOCK. Press the OPTIONS button to change the setting.

Flash at Lock

This feature activates the front and rear turn signals for one long flash when the lock button on the keyless access transmitter is pressed. This will only occur when the vehicle is off. If the lock button is pressed again within five seconds, the horn will sound regardless of which setting you have selected.

The DIC will display NO FLASH AT LOCK or FLASH AT LOCK. Press the OPTIONS button to change the setting.

FOB Reminder

This feature sounds the horn three times when the driver door is closed and there is a keyless access transmitter inside the interior of the vehicle. This will only occur when the vehicle is off.

The DIC will display FOB REMINDER OFF or FOB REMINDER HORN. Press the OPTIONS button to change the setting.

Passive Locking

This feature allows you to select whether the doors automatically lock when the ignition is turned off, the keyless access transmitter has been removed from the interior of the vehicle, and the doors have been closed for eight seconds. If a keyless access transmitter is left inside of the vehicle, the doors will not lock.

You may temporarily disable the passive door locking feature by pressing a door unlock switch for three seconds while a door is open. Passive door locking will then remain disabled until a door lock switch is pressed or until the power mode transitions from the off power mode.

You can select to not have the horn sound when the passive lock occurs. If you choose this setting, the doors will automatically lock eight seconds after you turn the ignition off, remove the keyless access transmitter from the interior of the vehicle and close both doors.

You can also select to have the horn sound once when the passive lock occurs. If you choose this setting, the doors will automatically lock and the horn will chirp eight seconds after you turn the ignition off, remove the keyless access transmitter from the interior of the vehicle and close both doors.

If you are parking in a quiet area and do not want the horn to sound when the doors lock, press the lock button on the keyless access transmitter immediately after removing it from the interior and closing the doors. This will lock the doors and cancel the passive locking for this ignition cycle.

The DIC will display PASSIVE LOCKING OFF, SILENT PASSIVE LOCK or HORN AT PASSIVE LOCK. Press the OPTIONS button to change the setting.

Passive Unlocking

This feature allows you to select which doors will automatically unlock when you approach and open the driver's door with your keyless access transmitter. You can choose to have the driver's door unlock or both doors unlock. See *Door Locks on page 2-9* for more information.

The DIC will display **PASSIVE UNLK DRIVER** or **PASSIVE UNLK BOTH**. Press the **OPTIONS** button to change this setting.

Auto Unlock

This feature automatically unlocks either the driver's door or both doors, depending on the setting, when the shift lever is moved to **PARK (P)**.

The DIC will display **AUTO UNLOCK OFF**, **AUTO UNLOCK DRIVER** or **AUTO UNLOCK BOTH**. Press the **OPTIONS** button to change the setting.

Park Assist

This feature tilts the passenger's side mirror downward when the shifter is moved to **REVERSE (R)**. This can help you to see the curb while backing up. If you adjust the mirror while in **REVERSE (R)**, the new position will be saved as the park assist position.

The DIC will display **PARK ASSIST OFF** or **PARK ASSIST ON**.

Language

This feature allows you to select the language the DIC and Head-Up Display (HUD), uses to display messages.

The DIC will display **ENGLISH**, **FRENCH**, **GERMAN**, **ITALIAN**, **JAPANESE** or **SPANISH**. Press the **OPTIONS** button to change the setting.

If you become stuck in a language that you do not understand, hold the **OPTIONS** and **RESET** button for five seconds. The DIC will scroll through all available languages for as long as the buttons are held. Each language option will display in its own language. For example, English will be displayed as **ENGLISH**, Spanish as **ESPAÑOL**, etc. When the desired language is available, release the buttons and the DIC will set to this language.

Trip Computer

Oil Life Indicator

This feature lets you know when to change the engine oil. It is based on the engine oil temperatures and your driving patterns.

To see the display, press the information button several times until OIL LIFE appears. If you see 99% OIL LIFE, 99 percent of your current oil life remains.

The DIC may display a CHANGE OIL NOW message. If you see CHANGE OIL NOW, it means the oil life is gone. For more information, see *Scheduled Maintenance on page 7-4* and *Engine Oil on page 6-13*.

When the oil is changed, you will need to reset the system. See *Engine Oil Life System on page 6-16*. Always keep a written record of the mileage and date when you changed your oil.

Audio System(s)

Determine which radio your vehicle has and then read the pages following to familiarize yourself with its features.

Driving without distraction is a necessity for a safer driving experience. See *Defensive Driving on page 5-2*. By taking a few moments to read this manual and get familiar with your vehicle's audio system, you can use it with less effort, as well as take advantage of its features. While your vehicle is parked, set up your audio system by presetting your favorite radio stations, setting the tone and adjusting the speakers. Then, when driving conditions permit, you can tune to your favorite stations using the presets and steering wheel controls (if equipped).

CAUTION:

This system provides you with a far greater access to audio stations and song listings. Giving extended attention to entertainment tasks while driving can cause a crash and you or others can be injured or killed. Always keep your eyes on the road and your mind on the drive — avoid engaging in extended searching while driving.

Keeping your mind on the drive is important for safe driving. For more information, see *Defensive Driving on page 5-2*. Get familiar with your vehicle's audio system so you can use it with less effort and take full advantage of its features.

Here are some ways in which you can help avoid distraction while driving.

While your vehicle is parked:

- Familiarize yourself with all of its controls.
- Familiarize yourself with its operation.
- Set up your audio system by presetting your favorite radio stations, setting the tone, and adjusting the speakers. Then, when driving conditions permit, you can tune to your favorite radio stations using the presets and steering wheel controls (if equipped).

Notice: Before adding any sound equipment to your vehicle, such as an audio system, CD player, CB radio, mobile telephone, or two-way radio, make sure that it can be added by checking with your dealer. Also, check federal rules covering mobile radio and telephone units. If sound equipment can be added, it is very important to do it properly. Added sound equipment may interfere with the operation of your vehicle's engine, radio, or other systems, and even damage them. Your vehicle's systems may interfere with the operation of sound equipment that has been added.

Your vehicle has a feature called Retained Accessory Power (RAP). With RAP, the audio system can be played even after the ignition is turned off. See *Retained Accessory Power (RAP) on page 2-22* for more information.

Theft-Deterrent Feature

THEFTLOCK® is designed to discourage theft of your vehicle's radio. The feature works automatically by learning a portion of the Vehicle Identification Number (VIN). If the radio is moved to a different vehicle, it will not operate. If the radio is removed from your vehicle, the original VIN in the radio can be used to trace the radio back to your vehicle.

With THEFTLOCK® activated, the radio will not operate if stolen.

Audio Steering Wheel Controls

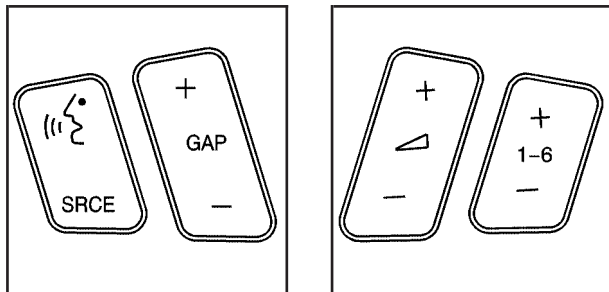

Some audio controls can be adjusted at the steering wheel. They include the following:

🗣️ **(Voice Recognition):** See “OnStar® Steering Wheel Controls” under *OnStar® System on page 2-37* or *OnStar® System on page 4-47* for more information.

SRCE (Source): Press this button to switch between FM1, FM2, AM, or XM1 or XM2 (if equipped), CD, or DVD.

+ ◀ – (Volume): Press this button to increase or to decrease the volume.

+ 1-6 – (Preset Stations): Press this button to play stations that are programmed on the radio preset pushbuttons. The radio will only seek preset stations with a strong signal that are in the selected band.

When a CD is playing, press this button to go to the next track.

Radio Reception

You may experience frequency interference and static during normal radio reception if items such as cellphone chargers, vehicle convenience accessories, and external electronic devices are plugged into the accessory power outlet. If there is interference or static, unplug the item from the accessory power outlet.

AM

The range for most AM stations is greater than for FM, especially at night. The longer range can cause station frequencies to interfere with each other. For better radio reception, most AM radio stations will boost the power levels during the day, and then reduce these levels during the night. Static can also occur when things like storms and power lines interfere with radio reception. When this happens, try reducing the treble on your radio.

FM Stereo

FM stereo will give the best sound, but FM signals will reach only about 10 to 40 miles (16 to 65 km). Tall buildings or hills can interfere with FM signals, causing the sound to fade in and out.

XM™ Satellite Radio Service

XM™ Satellite Radio Service gives digital radio reception from coast-to-coast in the 48 contiguous United States, and in Canada (if available). Just as with FM, tall buildings or hills can interfere with satellite radio signals, causing the sound to fade in and out. In addition, traveling or standing under heavy foliage, bridges, garages, or tunnels may cause loss of XM signal for a period of time. The radio may display NO XM SIGNAL to indicate interference.

Cellular Phone Usage

Cellular phone usage may cause interference with your vehicle's radio. This interference may occur when making or receiving phone calls, charging the phone's battery, or simply having the phone on. This interference is an increased level of static while listening to the radio. If static is received while listening to the radio, unplug the cellular phone and turn it off.

Care of Your CDs

Handle CDs carefully. Store them in their original cases or other protective cases and away from direct sunlight and dust. The CD player scans the bottom surface of the disc. If the surface of a CD is damaged, such as cracked, broken, or scratched, the CD will not play properly or not at all. If the surface of a CD is soiled, take a soft, lint free cloth or dampen a clean, soft cloth in a mild, neutral detergent solution mixed with water, and clean it. Make sure the wiping process starts from the center to the edge.

Do not touch the bottom side of a CD while handling it; this could damage the surface. Pick up CDs by grasping the outer edges or the edge of the hole and the outer edge.

Care of the CD Player

The use of CD lens cleaners for CD players is not advised, due to the risk of contaminating the internal lens of the CD optics with lubricants.

Diversity Antenna System

The AM-FM antennas are located under the decklid surface in the trunk compartment. The antennas are hidden from view and are not accessible.

If adding an aftermarket cellular telephone to your vehicle, do not attach the antenna to the rear glass. This would interfere with the convertible top retraction operation and could cause damage to the finished/painted surfaces.

XM™ Satellite Radio Antenna System (Trunk Mounted)

Your vehicle may have the XM™ Satellite Radio antenna that is located on the trunk of your vehicle. Keep this antenna clear of snow and ice build up for clear radio reception.

XM™ Satellite Radio Antenna System (Diversity System)

Your vehicle may have the XM™ Satellite Radio antennas that are located in the outside rear view mirrors. These antennas are hidden from view and are not accessible.

Section 4 Navigation System

Overview	4-2	Keyless Access System	4-47
Navigation System Overview	4-2	OnStar® System	4-47
Getting Started	4-4	Global Positioning System (GPS)	4-48
Features and Controls	4-10	Vehicle Positioning	4-49
Using the Navigation System	4-10	Problems with Route Guidance	4-50
Setup Menu	4-13	If the System Needs Service	4-50
Plan Route	4-18	Ordering Map DVDs	4-50
Edit Memory Point	4-19	Database Coverage Explanations	4-50
Edit Waypoint	4-23	Navigation Audio System	4-51
Edit Avoid Point/Area	4-25	Six-Disc CD Changer	4-66
Enter Destination	4-27	CD/DVD Player	4-69
Route Preference	4-36	Radio Personalization with Home and	
Maps	4-38	Away Feature	4-74
Symbols	4-42	Voice Recognition	4-75

Overview

Navigation System Overview

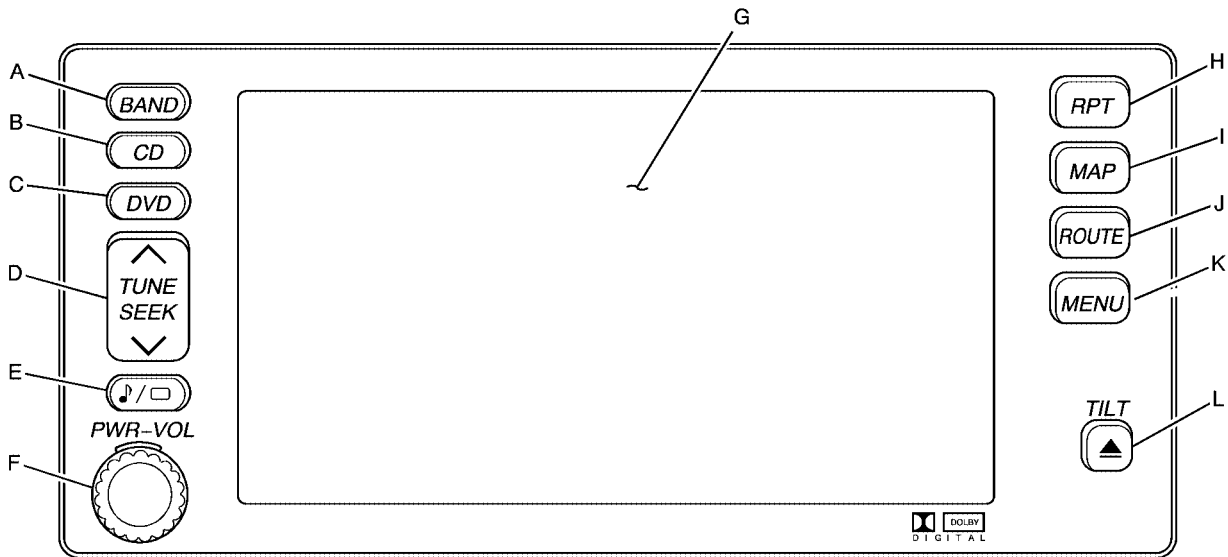

- A. BAND Key. See “Finding a Station” under *Navigation Audio System on page 4-51*.
- B. CD Key. See *Navigation Audio System on page 4-51* or *CD/DVD Player on page 4-69*.
- C. DVD Key. See “Playing a DVD” under *CD/DVD Player on page 4-69*.
- D. TUNE/SEEK Key. See “Playing the Radio” under *Navigation Audio System on page 4-51*.
- E. Audio/Adjust Key. See “Main Audio Menu” under *Navigation Audio System on page 4-51*.
- F. Power-Volume Knob. See “Hard Keys” under *Using the Navigation System on page 4-10*.
- G. Navigation System Screen
- H. RPT (Repeat) Key. See “Hard Keys” under *Using the Navigation System on page 4-10*.
- I. MAP Key. See “Hard Keys” under *Using the Navigation System on page 4-10*.
- J. ROUTE Key. See “Hard Keys” under *Using the Navigation System on page 4-10*.
- K. MENU Key. See “Hard Keys” under *Using the Navigation System on page 4-10*.
- L. TILT Key. See “Hard Keys” under *Using the Navigation System on page 4-10*.

Getting Started

Before you begin to operate the navigation system, read this manual thoroughly to become familiar with it and to understand how the system works.

Keeping your mind on the drive is important for safe driving. See *Defensive Driving on page 5-2* for more information. Get familiar with your vehicle's navigation system so you can use it with less effort and take full advantage of its features. Your navigation system includes not only navigation, but also audio functions.

While your vehicle is parked:

- Familiarize yourself with all of its controls: hard keys on the faceplate and touch-sensitive screen buttons.
- Familiarize yourself with its operation.
- Set up your audio by presetting your favorite stations, setting the tone, and adjusting the speakers. Then, when driving conditions permit, you can tune to your favorite stations using the presets and steering wheel controls (if equipped).
- Set up the navigation features that can only be done before you begin driving, such as entering an address or a preset destination.

Entering a destination or alphanumeric text requires many steps, so you can only perform these operations when the vehicle is in PARK (P). You will notice that touch-sensitive screen buttons leading to the alphanumeric keyboard are dimmed out while driving.

Other functions may also be locked out while driving and they too will appear grayed out on the screen — but all functions are available when parked. Some functions can be performed while driving, as long as you can do so without diverting too much of your attention from your driving.



CAUTION:

This system provides you with a far greater access to audio stations and song listings. Giving extended attention to entertainment tasks while driving can cause a crash and you or others can be injured or killed. Always keep your eyes on the road and your mind on the drive — avoid engaging in extended searching while driving.

 **CAUTION:**

Looking at the moving map on the navigation screen frequently or for too long while driving can cause a crash and you or others can be injured or killed. Keep your eyes and mind on the road and avoid looking too long or too often at the moving map on the navigation screen. Use the voice guidance directions whenever possible.

The navigation system allows you to do the following:

- Plan a route with provided turn-by-turn route and map guidance with voice prompts. See *Plan Route on page 4-18* for more information.
- Select a destination using various methods and choices.
- Receive broadcast announcements on traffic and emergency alert communications.

The information in the system may not always be complete. Road conditions such as prohibited turns, detours, and construction zones, change frequently. It is important to consider whether you can follow the directions given by the system for the current conditions.

When getting started, you may set the navigation system to your preference using various options. You will also need to know how to perform various functions to begin route guidance. Reference the following topics for further information:

- To adjust screen appearance, language, clock, English/metric measurements, or other options, see “Main Audio Menu” under *Navigation Audio System on page 4-51*.
- To adjust voice guidance volume or other navigation settings, see *Setup Menu on page 4-13*.

Setting Radio Station Presets



To set preset radio stations, do the following:

1. Press the PWR/VOL knob to turn the system on.
2. Press the audio source screen button (AM, FM1, FM2, etc.) and select the desired band (AM, FM1, FM2, XM1, or XM2 (if equipped), or WX (weather) (if equipped)).
3. Use the TUNE/SEEK arrows to tune to the desired station.
4. Press and hold one of the six preset screen buttons, at the bottom of the screen, until you hear a beep or see the station displayed on the selected preset button.
5. Repeat the steps for each preset.

See “Preset Station Menu” under *Navigation Audio System on page 4-51* for more information.

Setting the Time

To set the time, do the following:

1. Press the PWR/VOL knob to turn the system on.
2. Press the  /  (Audio/Adjust) hard key.
3. Press the  clock symbol screen button.
4. Select the 12H or 24H screen button to display the time in standard or military time.
5. Press and hold the HOUR and MIN. (minute) arrow buttons to increase or to decrease the time.
6. Select the appropriate time zone screen button.
7. Select the Daylight Saving Time screen button, if necessary.

The radio will use the GPS satellite to set the time. The vehicle needs to be in an open area to receive the signal. See “Clock Adjust Menu” under *Navigation Audio System on page 4-51* for more information.

Setting the Search Area, Entering an Address and Point of Interest, Storing a Home Destination, and Using Your Home or Previous Destinations

Before entering an Address, Point of Interest, Home, or Preset Destination, select the appropriate region that contains the final destination. Your vehicle must be stopped to perform this operation.

Setting the Search Area

To set the search area, do the following:

1. Press the PWR/VOL knob to turn the system on.
2. Insert the DVD map disc. See “Regional Maps” under *Maps on page 4-38* for more information.
3. A notice may appear. Touch the I AGREE screen button to proceed.

If the radio is already on with a map disc inserted, press the ROUTE hard key.

4. Press the Enter Destination screen button.

5. Press the Change screen button.
6. Select the appropriate region numbered screen button that contains your final destination.

The system will return to the Destination menu. See *Enter Destination on page 4-27* for more information.

Entering an Address

To set a destination by entering a street address, do the following:

1. Press the PWR/VOL knob to turn the system on.
2. Insert the DVD map disc. See “Regional Maps” under *Maps on page 4-38* for more information.
3. A notice may appear. Touch the I AGREE screen button to proceed.

If the radio is already on with a map disc inserted, press the ROUTE hard key.
4. Press the Enter Destination screen button. Verify that the selected Search Area is correct.
5. Press the Address screen button.

6. Press the Street screen button, then enter the street name using the alpha keypad on the screen.

Do not enter directional information or street type, and use the space screen button between street or city names. For example, the street name N. Royal Oak Rd. should be entered as royal oak.

Use the backspace () screen button if an incorrect character has been entered.

7. Select the desired street name with the correct designation (Dr., Ln., St., etc.) from the list.
8. If there is more than one city, the system will display the list of cities that have that street name. Select a city from the list or select the City screen button to input the city name.
9. Enter the house number using the numeric keypad on the screen and touch the Enter screen button. The system will list the house number range that is available for the street.
10. Press the Enter screen button to plan your route.

See “Address” under *Enter Destination on page 4-27* for more information.

Entering a Point of Interest (POI)

To set a destination by entering a Point of Interest (POI), do the following:

1. Press the power/volume knob to turn the system on.
2. Insert the DVD map disc. See “Regional Maps” under *Maps on page 4-38* for more information.
3. A notice may appear. Touch the I AGREE screen button to proceed.
If the radio is already on with a map disc inserted, press the ROUTE hard key.
4. Press the Enter Destination screen button. Verify that the selected Search Area is correct.
5. Press the All Points of Interest screen button.
6. Enter the specific title of the POI in the Name space (i.e. Washington Monument) using the alpha keypad on the screen.
7. Select the POI from the list.
8. Press the Enter screen button to plan your route.
Using the Category or City selections will aid the system in finding your POI by limiting the search options.

See “All Points of Interest” under *Enter Destination on page 4-27* for more information.

Storing a Home Destination

1. Press the power/volume knob to turn the system on.
2. Insert the DVD map disc. See “Regional Maps” under *Maps on page 4-38* for more information.
3. A notice may appear. Touch the I AGREE screen button to proceed.

If the radio is already on with a map disc inserted, press the ROUTE hard key.

4. Press the Edit Memory Point screen button.
5. Press the Home screen button.
6. Press the Register screen button.

Select a method for entering a destination. See *Enter Destination on page 4-27* for more information.

7. Press the Enter screen button to store the Home destination.

The  Home icon will be highlighted on the DESTINATION screen. See “Using Your Home or Previous Destinations” next to use the home or previous destinations as a route.

Using Your Home or Previous Destinations

These destinations are available for selection while driving.

1. Press the power/volume knob to turn the system on.
2. Insert the DVD map disc. See “Regional Maps” under *Maps on page 4-38* for more information.
3. A notice may appear. Touch the I AGREE screen button to proceed.

If the radio is already on with a map disc inserted, press the ROUTE hard key.

4. Press the Enter Destination screen button. Verify that the selected Search Area is correct.
5. Select the  (Home symbol) or the Previous Destination screen button.

If the Previous Destination screen button is selected, a list of the last 10 previous destinations will appear. Select the screen button next to the desired destination.

6. Press the Enter screen button to plan your route.

See “Home” and “Previous Destination” under *Enter Destination on page 4-27* for more information.

Canceling Your Current Route

Guidance will be canceled once you arrive at your final destination. To cancel the current route prior to arrival at the final destination, do the following:

1. Press the ROUTE hard key.
2. Press the Route Preference screen button.
3. Press the Cancel Route screen button.
4. Press the Yes screen button to confirm cancellation.

Guidance Volume

To adjust the volume of voice guidance prompts, do the following:

1. Press the MENU hard key.
2. Press the ON screen button to turn voice volume on.
3. Select the desired volume or select the OFF screen button. The system will play back the new volume level.

See “Voice Guidance Volume Settings” under *Setup Menu* on page 4-13 for more information.

Features and Controls

Using the Navigation System

This section presents basic information you will need to know to operate the navigation system.

Use the keys located on each side of the navigation screen, as well as the available touch-sensitive screen buttons, to operate the system. See *Navigation System Overview* on page 4-2 for more information on location.

Once the vehicle is moving, various functions will be disabled to reduce driver distraction.

Hard Keys

The following hard keys are located to the left of the navigation screen:

BAND: Press the BAND key to access the band screen and switch between AM, FM1, FM2, XM1, XM2, and WX, if equipped. See “Finding a Station” under *Navigation Audio System* on page 4-51.

CD: Press the CD key to play a CD. The CD screen will be displayed. See *Six-Disc CD Changer* on page 4-66 or *CD/DVD Player* on page 4-69.

DVD: Press the DVD key to play a DVD. The DVD screen will be displayed. See *CD/DVD Player on page 4-69*.

∧ TUNE/SEEK ∨ : Press the TUNE/SEEK up or down arrows to go to the next or previous radio station and stay there. See “Finding a Station” under *Navigation Audio System on page 4-51*.

🎵 / □ : Press the audio/adjust key to view the main audio menu. See “Main Audio Menu” under *Navigation Audio System on page 4-51*.

PWR-VOL (Power/Volume Knob): Press the power/volume knob to turn the audio and navigation systems on and off. Turn the knob to increase or decrease the volume to the audio system.

The following hard keys are located to the right of the navigation screen:

RPT: Press the repeat key to repeat the current voice guidance navigation prompt.

MAP: Press the MAP key to view the map screen showing current vehicle position.

The map screen can also display the following information:

- North or Heading Up symbol. See *Symbols on page 4-42*.
- Map scale. See *Maps on page 4-38*.
- Distance to destination.
- GPS symbol if GPS signal is not being received. See *Global Positioning System (GPS) on page 4-48*.
- Options you have selected for reaching your current destination.
- Driver Information.
- Radio band and presets.

ROUTE: Press the ROUTE key to display the PLAN ROUTE menu. See *Plan Route on page 4-18*.

MENU: Press the MENU key to display the SETUP MENU. See *Setup Menu on page 4-13*.

TILT▲ : Press the TILT key to open the navigation system faceplate for loading or removing the map DVD, a video DVD, or an audio CD. This key can only be used while the vehicle is in PARK (P).

Alpha-Numeric Keypad

Letters of the alphabet, symbols, punctuation, and numbers, when available to you, will be displayed on the navigation screen as an alpha or numeric keypad. The alpha keypad will be displayed when the system needs you to input a city or street name. You can also touch Char at the bottom of the alpha keypad to access the numeric keypad when inputting a house address, punctuation mark, or other character. Touch A - Z to return to the alpha keypad.

All characters are touch-sensitive screen buttons. Touch a character to select it.

Select the space symbol to enter a space between characters or the words of a name.

: Select the backspace symbol if you have selected an incorrect character.

To make your name selections easier, the system will only allow you to select a character which can follow the last one entered. For example, if you enter Z, you would not be allowed to follow it with T. The system will highlight the available characters and darken the unavailable characters.

If you are unsuccessful when inputting a name, it may need to be selected differently. It is also possible that the map DVD database may not contain that information or the correct search area has not been selected. See *Database Coverage Explanations on page 4-50* for more information.

Touch Sensitive Buttons

Touch-sensitive buttons, or screen buttons, are located on the screen. When you have successfully selected a screen button, a beep will be heard. These buttons will be highlighted when a feature is available and dim when they are unavailable. There are some toggle screen buttons that will be light blue when active and dark blue when inactive.

Setup Menu

MENU: Press the MENU key located to the right of the navigation screen to access the SETUP MENU.

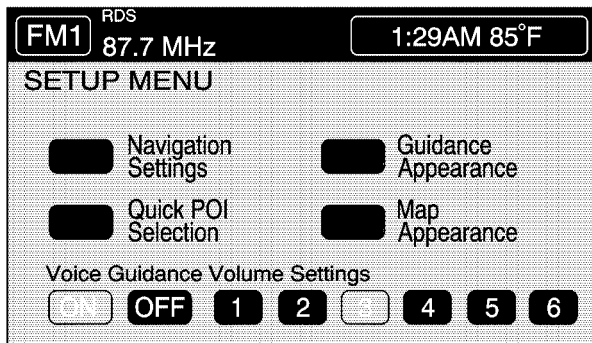

The SETUP MENU allows you to adjust such things as map appearance, navigation settings, and voice guidance volume.

Navigation Settings

This menu allows you to change the following options for the navigation system.

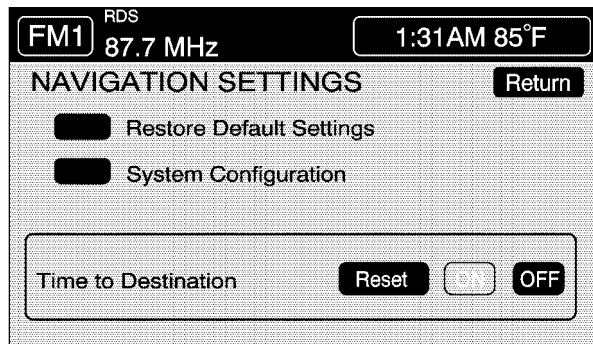

Restore Default Settings

This feature will automatically reset the system to the default values.

To restore the default settings, do the following:

1. Touch the Restore Default Settings screen button.
2. Touch Enter.
3. Touch Return to exit this menu.

System Configuration

This feature allows you to reconfigure the navigation system. If you begin to drive your vehicle during this procedure, the system will not be able to adjust the position or direction of your vehicle.

Touch the System Configuration screen button to view the following choices:

Adjust Vehicle Position: To correct the position of your vehicle on the map or to change vehicle position, do the following:

1. Touch the Adjust Vehicle Position screen button. The system will display Position Adjustment. The vehicle location symbol and the scroll symbol will appear on the map.
2. Use the scroll symbol and the zoom in/zoom out feature to locate the vehicle position on the map.
3. Touch Enter to set the vehicle position. The system will display Position Adjustment and two arrows will appear on the map screen.
4. Touch the arrows to adjust the direction of the vehicle. As you touch the arrows, you will see the vehicle symbol direction changing.

5. When you have set the vehicle to the correct direction, touch Enter. Relocation Complete will be displayed.
6. Touch Return to exit this menu.

Calibrate Vehicle Speed Signal: If there are tire pressure differences or if a spare tire is installed, the navigation system will automatically recalibrate the system. You may also choose to calibrate it yourself by doing the following:

1. Touch Start to begin calibration.
2. Touch Return to exit this menu.

Time to Destination

This feature allows you to view the estimated time to travel from your current position to the destination, and to reset the average speed to factory default settings. Estimated travel time is based on calculated route information and the vehicle's average speed. Touch ON to turn this feature on, OFF to turn this feature off, or Reset to restore vehicle speed default settings. With this feature on, the estimated travel time to destination will display along with the distance to destination.

Quick POI (Point of Interest) Selection

This menu allows you to choose a point of interest (POI), such as gas stations, restaurants, hotels, etc. to be displayed on the map screen. You can also set a destination to a specific POI.

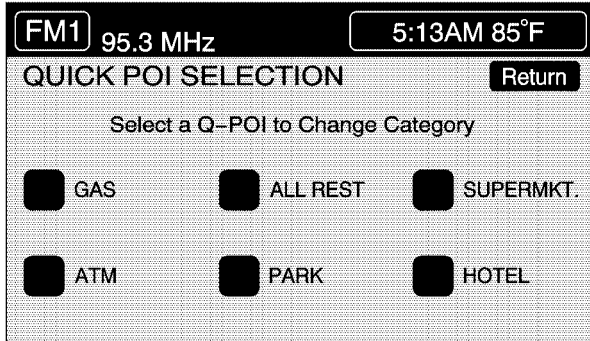

Setting the Quick POI menu

To set the Quick POI list displayed on the map screen, do the following:

1. Select the category you would like to replace.

2. Select a Quick POI category from the Quick POI selection menu list. The system will return to the Quick POI selection screen when a POI is selected.
3. Touch Return to save the setting and return to previous menu.

Displaying Quick POI Icons

To display POI icons of a category on the map screen, do the following:

1. Touch the map screen once.
2. Touch the POI button. The Quick POI Selection list will be displayed.
3. Select a category type or touch List Categories Or All Local POIs to display the icons of the selected category on the map screen.

Removing Quick POI Icons

To remove POI icons from the map screen, do the following:

1. Touch the map screen once.
2. Touch the POI OFF screen button. The current POI icons will be removed from the map screen.

Setting a Destination Using Quick POI

This feature will allow you to choose a POI as your destination. To set a destination using a POI, do the following:

1. Touch the POI icon on the map screen that you wish to set as a destination.
The selected icon will be surrounded by a blinking box, and the name of the icon will be displayed. You may also touch INFO to view the POI name, address, city, and phone number, if available.
2. Touch the ENT DEST screen button.
If a final destination has already been entered, you can add the POI as a waypoint. See *Edit Waypoint on page 4-23* for more information.
3. Touch Enter to start planning your route.
4. To start route guidance, touch Start or begin driving the vehicle. Route guidance will automatically begin after a short distance.

If you wish to cancel the route you have just set, do the following:

1. Press the ROUTE hard key.
2. Touch the Route Preference screen button.
3. Touch the Cancel Route screen button.
4. Select YES to cancel or NO to continue.

Guidance Appearance

This menu allows you to set the guidance appearance screen options. This screen is displayed on the map while on a planned route. The current settings will appear as light blue.

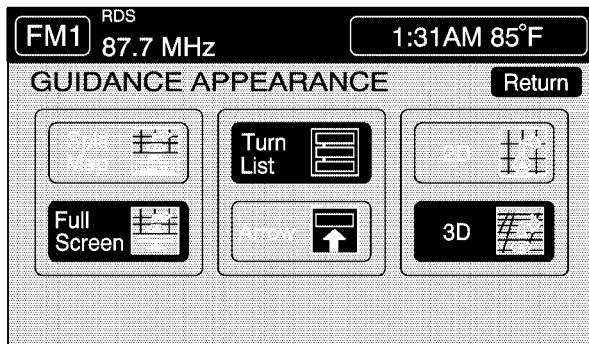

Split Map: Select this feature to display the guidance screen on the map at all times.

Full Screen: Select this feature to display the guidance screen on the map when approaching a maneuver.

Turn List: Select this feature to have the guidance screen display several upcoming turns. Directional arrows, street name, and distance to the next turn will be displayed. As you approach the next turn, the system will display a closer view of the upcoming maneuver.

Arrow: Select this feature to have the guidance screen display the next turn. A directional arrow, street name, and distance to the turn will be displayed. As you approach the turn, the system will display a closer view of the upcoming maneuver.

2D: Select this feature to display the guidance screen as a two-dimensional view.

3D: Select this feature to display the guidance screen as a three-dimensional view.

Map Appearance

This menu allows you to set the map appearance screen options. The current setting will appear as light blue.

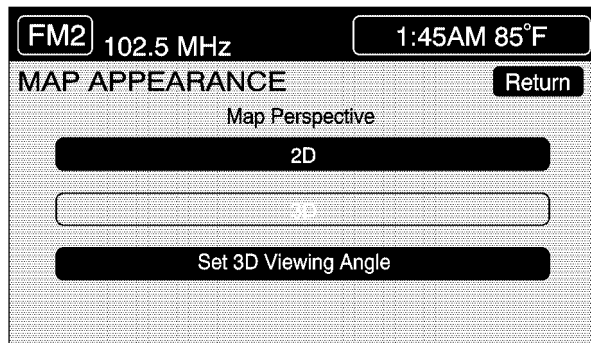

2D: Select this feature to display the map as a two-dimensional view.

3D: Select this feature to display the map as a three-dimensional view.

Set 3D Viewing Angle: This feature allows you to adjust the 3D viewing angle. To do so, do the following:

1. Touch 3D on the MAP APPEARANCE menu.
2. Touch Set 3D Viewing Angle.
The map screen with the 3D viewing angle bar will be displayed.
3. Touch the up or down arrows to set the viewing angle.
4. Touch Return to save your settings and to exit this menu or touch Reset to restore the viewing angle to the default setting.

Voice Guidance Volume Settings

This feature allows you to set the voice prompt volume level or to turn voice prompts on or off.

Set the voice prompt volume level by touching the numbered buttons to increase or decrease the volume level. You may also choose to turn the voice prompts off. Then touch Return to save your setting and to return to the SETUP MENU.

If a voice prompt is active while the audio system is on, the audio system volume will decrease and the voice prompt will be heard through the driver's side front speaker.

Voice prompts will not be heard while using voice recognition.

Plan Route

To plan a route, press the ROUTE key. The PLAN ROUTE menu will be displayed.

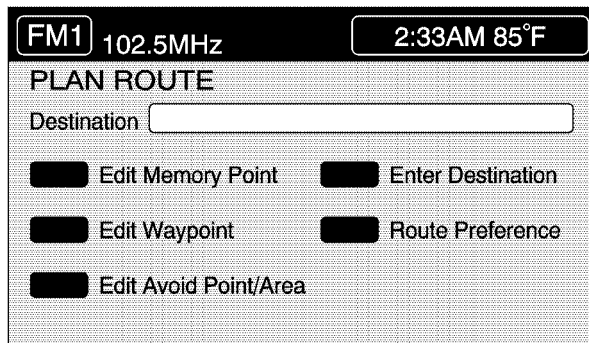

You may use one of several destination entry methods to plan a route. See *Enter Destination on page 4-27* for more information.

Edit Memory Point

This feature allows you to store, delete, and edit memory points. Touch the Edit Memory Point screen button from the PLAN ROUTE menu to access the EDIT MEMORY POINT screen.

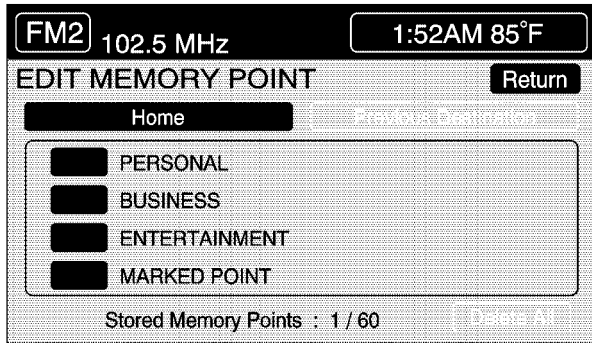

You can store memory points in four different categories, personal, business, entertainment, and marked point.

Memory points are stored when you select either START or MARK when setting a destination on the map or when you are storing destinations in memory.

A total of 60 locations can be stored. The last 10 destinations entered will be stored under Previous Destination. In addition, one memory point can be stored under the Home category.

If all 60 stored points are entered, the system will notify you that there is no available storage left in memory points. A memory point must be removed before storing additional memory points.

Registering Memory Points

To store a memory point, do the following:

1. Select a category from the EDIT MEMORY POINT menu.
2. Touch REGISTER.
3. Select a method for entering a destination. A map will appear displaying the memory point's location.
4. If available, touch INFO to view the address information for the memory point.
5. Touch Enter to store the point.

Editing Memory Points

This feature allows you to edit the contents stored in memory. The following options are available:

Icon Editing of a Memory Point

Each memory point is displayed with a default icon. To edit an icon, do the following:

1. Select the category of the memory point.
2. Select the item you want to edit.
3. Touch the icon. The EDIT MEMORY POINT icon screen will appear.
4. Touch the icon you would like to use. The system will then return to the EDIT MEMORY POINT menu.
5. Touch Return to go back to the previous screen.

You will see the new memory point icon on the map.

When selecting an icon, you can choose from 18 different icons, three of which are sound icons. The same icon may be used for other memory points as well.

Name Editing of a Memory Point

To modify the name of a stored memory point, do the following:

1. Select the category of the memory point.
2. Select the item you want to edit.
3. Touch the NAME screen button and use the alpha keypad to edit the name. Names may contain up to 15 alpha and/or numeric characters.
4. Touch Return to go to the previous screen.

Moving Memory Points

To move a memory point from one category to another, do the following:

1. Select the category of the memory point.
2. Select the memory point you want to edit.
3. Touch CATEGORY. A list of categories will appear. The current category for the item will be highlighted and cannot be selected.
4. Touch the screen button for the category you want the memory point placed in. A pop-up window will appear displaying the change in category.
5. Touch Return to go back to the previous screen.

Adjusting a Memory Point

To relocate a memory point's location, do the following:

1. Select the category of the memory point.
2. Select the memory point you want to edit.
3. Touch POSITION. A map screen with the position of this memory point will appear.
4. Touch anywhere on the screen to activate the scroll feature and relocate the memory point. See *Maps on page 4-38*.
5. Touch Enter to save the memory point's new location.
6. Touch Return to go back to the previous screen.

Changing the Phone Number of a Memory Point

To edit or add the phone number of a memory point, do the following:

1. Select the category of the memory point.
2. Select the memory point you want to edit.
3. Touch PHONE and use the numeric keypad to edit or add the number.
4. Touch the RETURN button to take you back to the previous screen when you have finished.

Deleting Single Memory Points

To delete a single memory point, do the following:

1. Press the ROUTE key.
2. Touch EDIT MEMORY POINT.
3. Select the category of the memory point.
4. Touch DELETE.
5. Select the memory point you want to delete. A confirmation window will appear.
6. Touch YES to delete the memory point or NO to return to the previous menu.
7. Touch Return to go back to the previous screen.

Deleting All Memory Points

To delete all of the memory points in a category, do the following:

1. Press the ROUTE key.
2. Touch EDIT MEMORY POINT.
3. Select the desired category.
4. Touch the DELETE ALL screen button. A confirmation window will appear.
5. Touch YES to delete the memory points or NO to return to the previous menu.
6. Touch Return to go back to the previous screen.

Edit Category

To edit the name of a category, do the following:

1. Press the ROUTE key.
2. Touch EDIT MEMORY POINT.
3. Select the category you want to edit.
4. Touch the EDIT CATEGORY screen button and use the alpha keypad to edit the category name.
The name can consist of up to 15 alpha and/or numeric characters.
5. Touch Return to go back to the previous screen.

Marked Point

A marked point is a memory point which has been stored by selecting the MARK screen button while traveling on a planned route. You can also use the scroll feature to plan a destination on the map after reaching the destination, or by moving a memory point to a marked point category. See “Editing Memory Points” earlier in this section for more information.

Previous Destination Memory

Each time you select Start from the map screen, that destination will be stored as a memory point under PREVIOUS DESTINATION. This category will store up to 10 destinations.

When the Previous Destination category contains more than 10 destinations, the system will remove the oldest destination stored and add the most recent one selected to the list.

If you do not want a previous destination to be lost, you must move the destination into a memory point category. See “Moving Memory Points” earlier in this section for more information.

Home Memory

This memory point is stored by selecting Home from the EDIT MEMORY POINT screen. See “Registering Memory Points” earlier in this section and “Home” under *Enter Destination on page 4-27* for more information.

Edit Waypoint

Waypoints are destinations you can set along the way to your final destination. This feature allows you to add, edit, and delete waypoints.

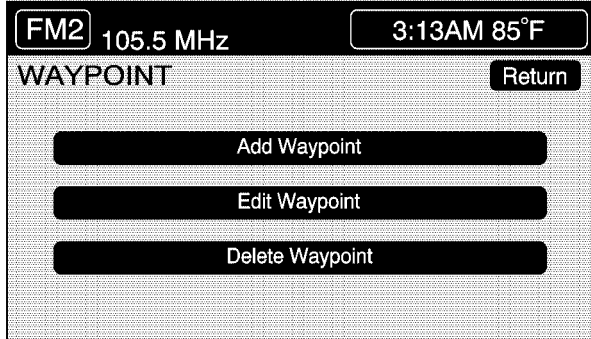

You may set up to five waypoints on the way to your final destination.

To access the WAYPOINT menu, do the following:

1. Press the ROUTE key.
2. Touch Edit Waypoint.

Adding a Waypoint

To add a waypoint to your route, do the following:

1. Touch Add Waypoint.
2. Enter a destination. See *Enter Destination on page 4-27*.
A map will appear showing the location of the waypoint.
3. Touch Enter to add your waypoint.
4. Touch the ADD screen button to insert the waypoint in the desired order.
5. The system will display the ROUTE INFORMATION screen. From this screen, several options are available.

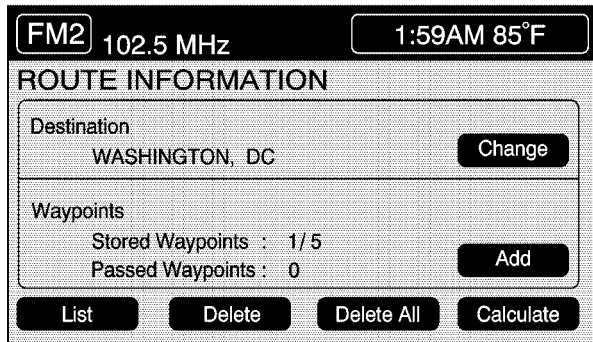

List: Touch List to view the waypoint on the map or to change the order of the waypoints and final destination. To change the order, touch CHG ORDER, then touch the blank screen button next to the destination to select the order of the waypoints and final destination. Press the MAP key to view the destination and waypoints on the map screen.

Delete: Touch Delete to delete a waypoint or the final destination. A confirmation window will appear. Touch YES to delete the point or NO to return to the previous screen.

Delete All: Touch Delete All to delete all of the waypoints and the final destination. A confirmation window will appear. Touch YES to delete all waypoints or NO to return to the previous screen.

Change: Touch Change to change the final destination. Enter a destination. See *Enter Destination on page 4-27*.

Add: Touch Add to add additional waypoints. Refer to the steps for adding a waypoint listed previously in this section.

Calculate: Touch Calculate to begin route calculation. This feature will only be available if the final destination has been set.

Editing a Waypoint

This feature allows you to edit waypoints that have already been set. To edit a waypoint, do the following:

1. Touch Edit Waypoint.
2. Touch the MAP key to view the destination location on the map screen.
3. Touch CHANGE ORDER to change the order of the waypoints and the final destination.

You can also use the map scroll to change a waypoint from one location to another.

Deleting a Waypoint

To delete a waypoint from your route, do the following:

1. Touch Delete Waypoint.
2. Select the waypoint you want to delete.
A confirmation window will appear.
3. Touch YES to delete the waypoint or NO to return to the previous menu.

Edit Avoid Point/Area

From this menu you can register, edit, and delete an area to be avoided while planning a route. These areas can also be saved so the system can automatically avoid them when planning a route.

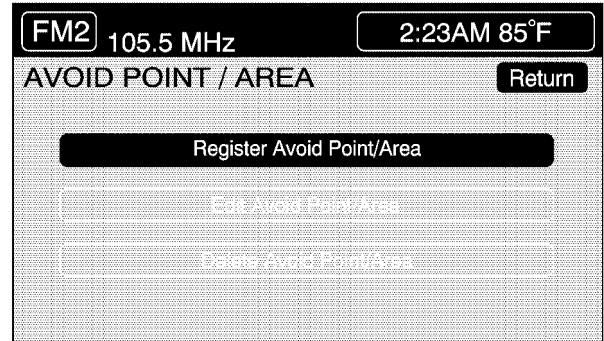

To access the AVOID POINT/AREA menu, do the following:

1. Press the ROUTE key.
2. Touch Edit Avoid Point/Area.

Registering an Avoid Point/Area

To store an avoid point/area, do the following:

1. Touch Register Avoid Point/Area.
2. Enter a location. See *Enter Destination on page 4-27*.
3. If desired, reduce or enlarge the area around the point you want to avoid by using the REDUCE or ENLARGE screen buttons.
If an avoid point cannot be avoided, the system will display "Avoid Point and Area Stored. Route May Not Avoid the Avoid Point and Areas."
4. Touch Enter to set the area as an avoid point area. When using the REDUCE or ENLARGE buttons, a box will appear to represent the area or an X will appear to represent the area avoided. When an avoid point is set, the square will appear as green.
5. Touch Return to go back to the previous screen.

Editing an Avoid Point/Area

To edit an avoid point/area, do the following:

1. Touch Edit Avoid Point/Area. A list of avoided points will appear.
2. Select the avoided point/area you want to change. A map of the avoided area will appear.
3. Use REDUCE or ENLARGE to edit the avoided point.
4. Touch Enter to set your new avoided area. The system will display "Area Adjusted."
5. Touch Return to go back to the previous screen.

Deleting an Avoid Point/Area

To delete an avoid point/area, do the following:

1. Touch Delete Avoid Point/Area. A list of avoided points will appear.
2. Select the avoided point/area you want to delete.
3. The system will ask you to confirm your selection. Touch Yes to delete the avoid point/area or No to cancel.
If Yes is selected, the area will no longer be avoided when traveling on a planned route.
4. Touch Return to go back to the previous screen.

Enter Destination

The DESTINATION menu will give you several ways to plan a route. Touch the Enter Destination screen button from the PLAN ROUTE menu to display the DESTINATION menu.

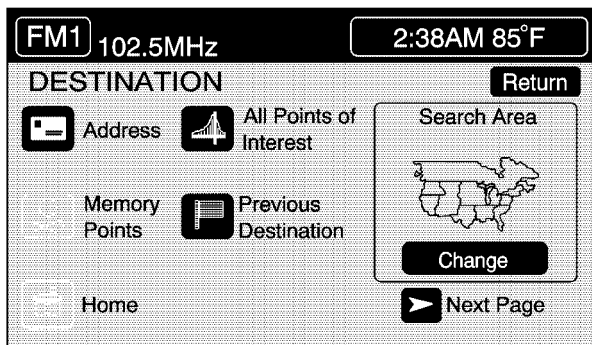

For destination entry methods listed on the second page of the DESTINATION menu, touch the Next Page arrow. Touch the Prev. Page arrow to return to the first page.

To enter a destination, choose from one of the destination entry methods following in this section.

After entering a destination, If available, the system will display up to three routes in a pop-up window indicating the total mileage and time to destination for each route. Select a route by touching NEXT. The map will display each route in a different color. The selected route will be highlighted in red.

To start route guidance, touch Start or begin driving your vehicle. Route guidance will automatically begin after a short distance.

If you touch CHG ROUTE before touching Start, you will be able to change route preferences. See *Route Preference on page 4-36* for more information.

When a route has been planned, it will be highlighted and a bulls-eye symbol will appear on the map to show your final destination.

If you wish to cancel a route that has been set, see "Cancel Route" under *Route Preference on page 4-36*.

Easy Planning Route

With this destination entry method, you can select a destination using the scroll symbol on the map screen. See *Maps on page 4-38*.

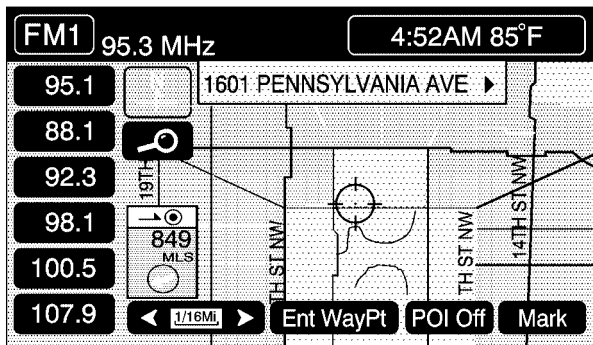

To use this destination entry method, do the following:

1. Press the MAP key.
2. Touch the map screen twice for the scroll symbol to appear. Touch the map or drag the scroll symbol toward your destination.
3. Touch the map screen continuously to scroll through the map faster. The address of the location on the map will appear at the top of the screen.
If needed, use the zoom feature to locate your destination. See "Map Scales" under *Maps on page 4-38* for more information.
4. Touch ENT DEST to set this location as your destination. You may also touch MARK to store this location as a memory point.
5. Touch Enter to plan your route.

Address

This destination entry method allows you to input an address by providing the system with a house number, street name, and city. Select Street to begin entering the desired address.



To use this destination entry method, do the following:

1. Enter the street name using the alpha keypad. See “Alpha-Numeric Keypad” under *Using the Navigation System on page 4-10* for more information.

Do not include name extensions such as N. or Drive. For example, the street name N. Civic Center Drive should be entered as Civic Center. As information is entered, the system will automatically search for available names, and List will become available.

2. Touch List to view name choices or continue to spell the street name to further reduce the number of available items. Select a street name.
3. If the street name you entered exists in more than one city on the DVD database, a list of cities will appear. You can select a city from the list, or enter the city name by selecting City. As you begin to enter the city name, you can select the desired city from the list which will appear, or continue to spell the city name to further reduce the number of available items.
4. Once the city name has been selected, enter the house number using the numeric keypad.
The system will list the house number range that is available for the street.
5. When you have finished entering all of the address information, touch Enter to plan your route.

All Points of Interest

This destination entry method allows you to choose a destination from the point of interest (POI) list. Selecting All Points Of Interest from the DESTINATION menu will bring up the alpha keypad. While inputting a POI or city name, the List option will become available. As information is entered, the system will search for available POI and city names based on the information given. The system will supply a list of names to make a selection from when the choices are five or less.

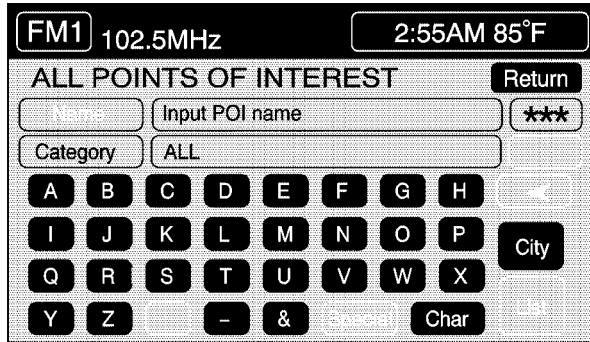

You may search for a POI using the following three methods:

- Touch NAME to type in a POI by name using the alpha key pad. As you type in a name, the system will search for an available match to your input. Select the desired POI.
- Select a POI by touching CATEGORY. Use the arrows to scroll through the categories listed. Select a category along with any appropriate sub-categories. If the list of available POIs for the selected category is too long, you may need to enter the POI's name or city.
- Select CITY, then type in the city you wish to select a POI from. Choose a city from the list of cities that will appear. If the list of POIs for the selected city is too long, enter the POI's name or choose a category.

While inputting a POI or city name, the List option will become available. Touch List to view the list of name choices, or continue to spell the name to further reduce the list of available items.

The system will list all POIs available. You can sort by name using NAME SORT or touch DIST SORT to list POIs by distance from your current location.



Select a location from the list. The system will show the selected POI on the map. If available, a pop-up window will be displayed. Touch INFO to view the POI's name, address, city, and phone number, if available.

Touch Enter to plan your route.

Memory Points

This destination entry method allows you to set a memory point as your destination. Each time you store a destination from the map screen, the destination is stored under MARKED POINT. See *Edit Memory Point on page 4-19* for more information.

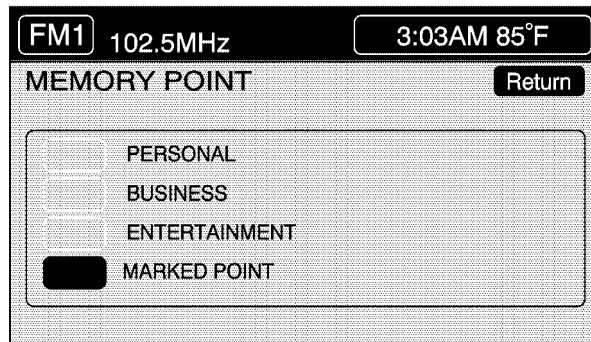

You must have destinations stored as memory points to select from PERSONAL, BUSINESS, ENTERTAINMENT, or MARKED POINT. If you have renamed the memory point category name(s), the name(s) will appear as you changed them.

To select a destination using this entry method, do the following:

1. Touch the Memory Points symbol.
2. Select a category.
3. Select a destination. Use the arrows to scroll through the memory points. They can be sorted by date, name, distance, and icon.
4. Touch Enter to plan your route.

Previous Destination

This destination entry method allows you to select a destination by choosing from a list of the last 10 destinations entered into the system.



To select a previous destination, do the following:

1. Touch the Previous Destination symbol.
2. Touch the screen button next to the desired destination to select it.
Use the arrows if necessary to view the entire list of previous destinations.
3. Touch Enter to plan your route.

Previous Starting Point

This destination entry method allows you to select the last start point as your destination. To select the previous start point as your destination, do the following:

1. Touch Previous Destination.
2. Touch the Previous starting point screen button.
3. Touch Enter to plan your route.

Home

This destination entry method allows you to select a destination that has been previously stored as Home.

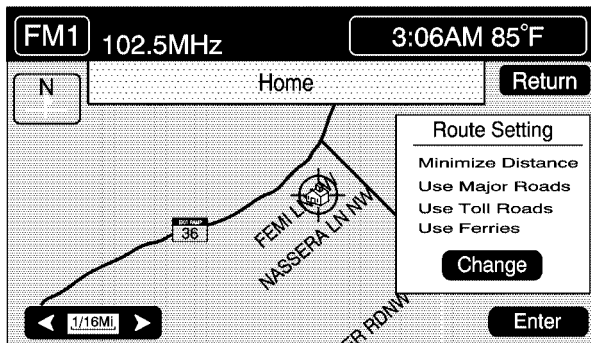

To choose Home as your destination, do the following:

1. Touch the Home symbol.
2. Touch Enter to plan your route.

Set by Map

This destination entry method allows you to select a destination by using the scroll symbol.

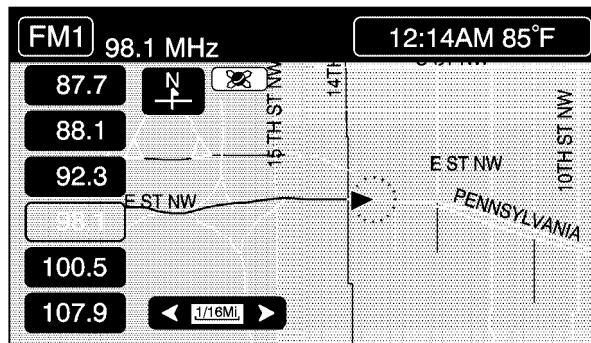

To use this feature, do the following:

1. Touch the Set By Map symbol. Current vehicle position will be shown on the map screen.
2. Use the scroll symbol to select the desired destination. The zoom in and zoom out feature can be used to assist you in finding the desired location. See "Map Scales" under *Maps on page 4-38*.
3. Touch Enter to plan your route.

Freeway Entrance/Exit

This destination entry method allows you to select either a freeway entrance or an exit as a destination.



To enter a freeway name, do the following:

1. Touch the Freeway Entrance/Exit symbol.
2. Enter the freeway name using the alpha key pad.
Freeways sometimes have a name and a number associated with them which you may need to refer to when entering freeway information. Freeways are also referred to by their abbreviated names. For example, Interstate 75 in the U.S. is selected by entering I-75.
As you enter a freeway name, the List option will become available.

3. Touch List to view the list of available name choices or continue to spell the name to further reduce the list of available items. The system will supply a list of names when the choice is five or less.

If you are unsuccessful when inputting a name, the name may need to be input differently, the map DVD database may not contain this information, or the name may be misspelled.

4. Select a freeway from the list.
5. The ENTRANCE or EXIT options will appear. Choose ENTRANCE to select the entrance to the freeway, or EXIT to select the exit ramp of the freeway.

When either button is touched, it will give an alphabetical list of freeway entrance and exit ramps on the freeway you entered. You may touch DIST SORT to sort the list by distance from your current location, or NAME SORT to sort the list by name.

6. Select the desired freeway entrance or exit from the list. A map will appear with the destination shown.
7. Touch Enter to plan your route.

Intersection

This destination entry method allows you to select a destination by inputting the intersecting roads you wish to travel to.



To enter an intersection, do the following:

1. Touch the Intersection symbol.
2. Using the alpha keypad, enter the name of the first street in the intersection.

3. To view a list of choices, touch List or continue to spell the name to further reduce the list of available items. The system will display a list of the intersecting streets if the number of intersecting streets is five or less.
4. Select the first street.
5. Now enter the second street name.
6. Select the second street name from the list of intersecting streets. To view a list of choices, touch List or continue to spell the name to further reduce the list of available items. The system will display a list of intersecting streets if the number of intersecting streets is five or less.
If there are multiple intersections with the same two roads, the system will display a list of cities to choose from. Choose a city from this list. A map with the intersections for that city will appear.
7. Touch Enter to plan your route.

Route Preference

To change your planning options, use the following instructions.

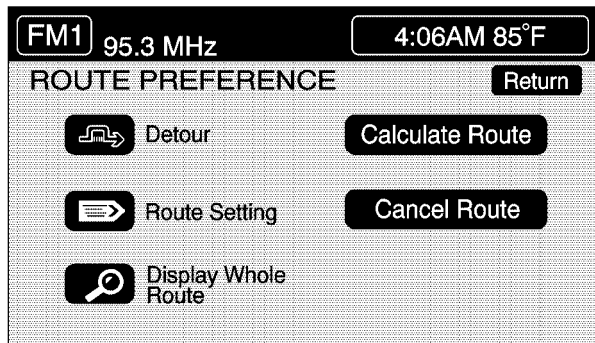

1. Press the ROUTE key.
2. Touch Route Preference.

The following options will be available from the ROUTE PREFERENCE menu:

Detour

This feature allows you to choose a distance in miles/kilometers to detour. Select the detour distance desired for residential roads and freeways.

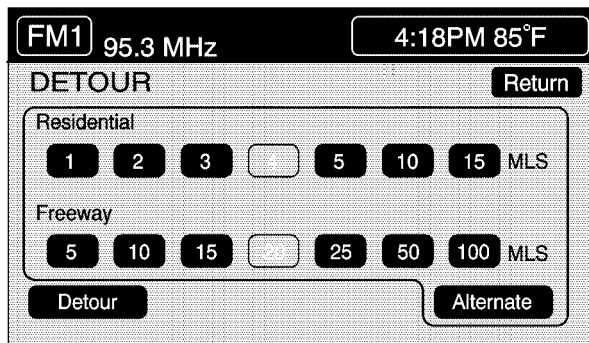

The system will retain these settings for the next time you use Detour, unless you change them.

You may also touch Alternate to provide a new route that does not use previously stored detour settings.

Touch Return to go back to the previous screen.

Route Setting

This feature allows you to display and change the planning methods used each time you plan a route. With planning method options, you are able to select the fastest route based on time or distance, using only major roads, toll roads, and using ferries based on the navigation system's information and information contained on the map DVD.

FM1 95.3 MHz	4:23PM 85°F
ROUTE SETTING	
	Return
Minimize Time/Dist.	<input type="button" value="Time"/> <input checked="" type="button" value="Dist"/>
Use Major Roads	<input type="button" value="Yes"/> <input checked="" type="button" value="No"/>
Use Toll Roads	<input type="button" value="Yes"/> <input checked="" type="button" value="No"/>
Use Ferries	<input checked="" type="button" value="Yes"/> <input type="button" value="No"/>

The following options will be available from the ROUTE SETTING menu:

Minimize Time/Distance: The system will calculate the fastest route or shortest route possible. Choose Time for the fastest route or Dist for the shortest route.

Use Major Roads: Choose Yes to calculate the best route using only major roads unless a route cannot be found without the use of a secondary road. This selection will not always offer the shortest distance or time to your destination.

Use Toll Roads: Choose Yes to calculate the best route using toll roads wherever possible. This selection will not always offer the shortest distance or time to your destination.

Use Ferries: Choose Yes to calculate the best route using ferries when possible. This selection will not always offer the shortest distance or time to your destination.

Display Whole Route

This feature allows you to display your entire planned route. Total mileage and time to destination for the planned route will be displayed on the map screen. Touch Return to go back to the previous menu.

Calculate Route

This feature allows you to begin route calculation for the selected destination.

Cancel Route

If you are traveling on a planned route and would like to cancel it, touch Cancel Route. The system will ask you to confirm by touching YES. Touch YES to confirm cancellation of your planned route or touch Return to keep your planned route.

Maps

This section includes basic information you need to know about the map database.

Regional Maps

The maps are stored on a DVD-ROM. The 48 contiguous United States and portions of Canada are contained on one disc. The U.S. map database includes interstate freeways, state highways, country roads, and major and general streets.

Refer to the "Navigation System Map Disc" manual to view the explanation of map coverage and detailed city lists in each region. The map disc manual will be in your map DVD case when the vehicle is delivered from the factory.

When your vehicle is delivered from the factory, the dealer may have installed the map DVD. If the map DVD was not installed in your vehicle when first purchased, do the following:

1. Turn the ignition on.
2. With the vehicle in PARK (P), press and hold the TILT key until a beep is heard. The system's faceplate will open.
3. If already loaded, the map DVD or a CD will eject from the slot.
4. Load the map DVD into the slot by inserting it partway. The system will pull it in.
5. Press and release the TILT key to close the faceplate.

Notice: Shifting out of PARK (P) with the system's faceplate open will cause the faceplate to close automatically. This could cause damage to a CD, DVD or the system if it is partially loaded. Before shifting out of PARK (P), make sure that the DVD or CD is loaded properly. The vehicle must be shifted back into PARK (P) to close the faceplate.

Once the map DVD is inserted correctly, you will have the following two choices:

- LANGUAGE
- I AGREE

You can change the language at this time. See "Language" under *Navigation Audio System on page 4-51* for more information on choosing a language. Once a language has been selected, touch I AGREE to plan a route. The map will appear showing your current vehicle position.

Setting the Search Area

To determine or change the system's search area, do the following:

1. Press the ROUTE key.
2. Touch the Enter Destination screen button.
3. Touch Change under the Search Area heading. The system will display a map with each region represented.

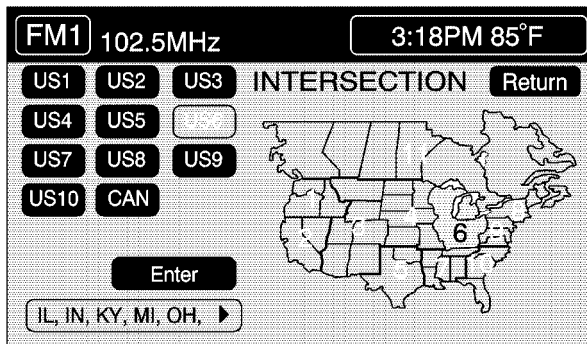
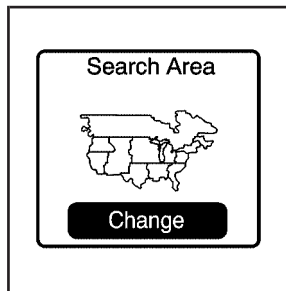

4. Select the desired region by touching the appropriate screen button to the left of the U.S. map. The name of the states or the country included in the selected region will be displayed at the bottom of the screen and the region will be highlighted.
5. Touch Enter to set the region as the search area.
6. Touch Return to go back to the previous screen.

Map Adjustments

The system allows you to adjust the scale of view on the map. The map will scroll automatically based on the direction you are traveling.

Map Scales

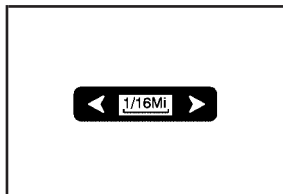

To view a larger or smaller scale of the map, touch the map scale arrows.

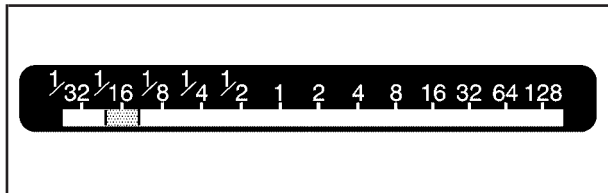

You may also adjust the scale of the map by touching the scale on the bar. The scale of a map can range from 1/32 of a mile (0.05 km) to 128 miles (256 km).

Scrolling the Map

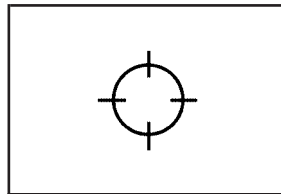

Touch anywhere on the map screen twice to display the scroll symbol.

Place your finger on the map screen in any direction outside of the scroll symbol to scroll in that direction. The map will continue to scroll until you remove your finger.

If your vehicle is in PARK (P), the system will initially scroll at a slower rate. The rate will increase if you continue to touch the map screen.

If your vehicle is in motion, there is one scroll speed and a limited distance to scroll. You must keep touching the map screen to scroll a longer distance.

If your vehicle icon becomes lost while scrolling, press the MAP key to show the vehicle's current location.

You may also use the scroll feature to set a destination. See "Set by Map" under *Enter Destination on page 4-27*.

Symbols

The following symbols are the most common that appear on a map screen.

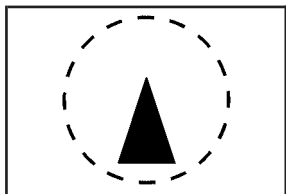

Your vehicle is shown as this symbol. It indicates the current position and heading direction of your vehicle on the map.

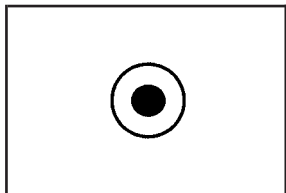

This symbol will appear on the map to show your destination after a route has been planned.

See *Enter Destination* on page 4-27 for more information on planning a route.

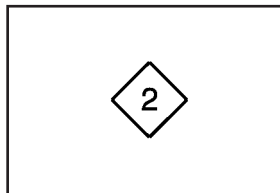

You will see this type of symbol on the map when a waypoint has been planned.

The waypoint symbol will be numbered from 1 through 5 depending on how many waypoints have been set. See *Edit Waypoint* on page 4-23 for more information on adding waypoints.

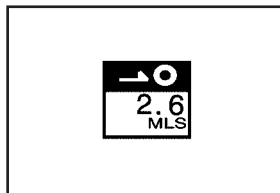

This symbol indicates the distance to your final destination.

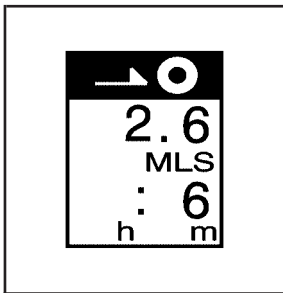

This symbol indicates the distance and estimated travel time to your final destination. The Estimated Travel Time feature must be on for estimated travel time to be displayed.

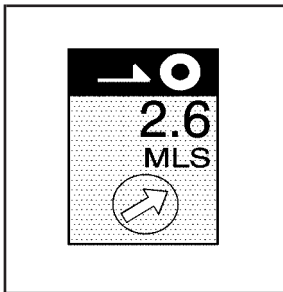

This symbol indicates the distance to your final destination in a straight line.

This symbol will appear before route guidance begins or if you are on a road where route guidance is not available.

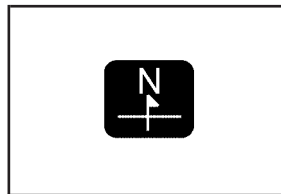

This symbol indicates the map with North up.

While in North up mode, North will always be at the top of the map screen regardless of which direction the vehicle is traveling.

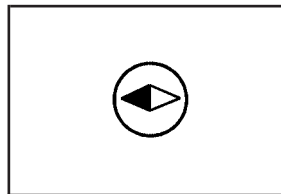

This symbol indicates the map with the vehicle travel direction up, or Heading up.

The shaded triangle indicates North. While in Heading up mode, the direction your vehicle is traveling will always be at the top of the map screen.

Touch either the North Up heading symbol or the vehicle Heading Up symbol to alternate between settings.

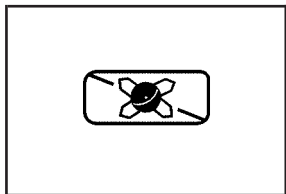

This symbol will appear when the navigation system is unable to receive the GPS signal.

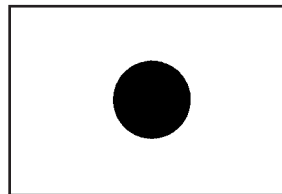

This symbol indicates the position of the next turn instruction.

See *Global Positioning System (GPS)* on page 4-48 for more information.

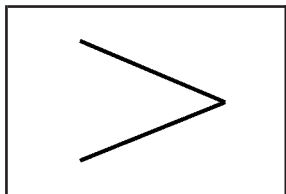

When a point of interest (POI) or street address name is too long to be displayed, an arrow will appear.



While on a planned route, touch this symbol to display the DEST MAP, WHOLE, and TURN LIST options.

Touch the right or left arrow to scroll through the entire name.

With these options, you can do the following:

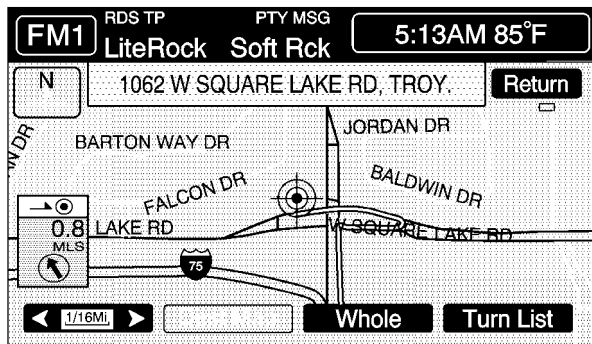

Dest (Destination) Map: This option allows you to view the final destination location. The destination's name or address will be displayed on the map screen. Touch Return when finished.



Whole: This option allows you to view the entire planned route. The distance to destination will be displayed on the map screen. Touch Return when finished.

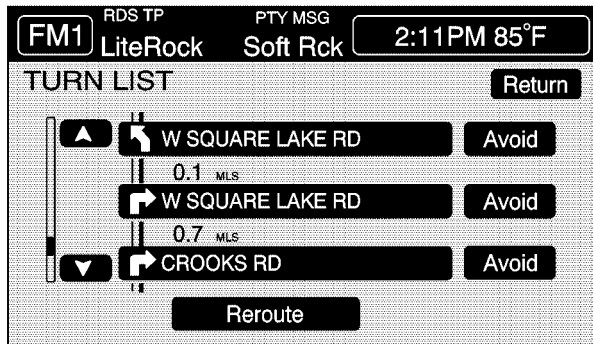

Turn List: This option allows you to view a step-by-step listing of upcoming street names, the distance that you will travel on the road, and turns you will need to make during your planned route.

After touching Turn List, the system may take some time to create the list. The length of time will vary depending on the length of your route and the planning methods you have selected.

The turn list will read from bottom to top. The bottom street name is the street you are currently on. The system automatically updates this screen as you make each turn. You may also touch the scroll up and down arrows providing scroll is available. Touching the down arrow will bring you to your current location. Touching the up arrow will give you upcoming streets. At times, there may not be names available for entrance or exit ramps.

To avoid a turn, touch AVOID next to the turn you want to avoid. You can use REDUCE or ENLARGE to edit the avoided point. Touch Reroute or press the MAP key to calculate your new route.

Touch Return to view your current position and to turn the turn list screen off.

Touch REROUTE or press the MAP key to calculate a new route.

Auto Reroute

When your destination is set and you travel off of the planned route, the system will automatically begin to reroute you. You will see the new route highlighted on the screen.

Traveling Across Regions

If you plan to drive across several states, you may have to change the selected region to represent the area you are traveling to.

There are two ways you can plan a destination when traveling across regions.

The following method is suggested and provides the most route guidance and map display functions:

1. Change the selected search area region when you get closer to the area you are traveling to. See “Setting the Search Area” under *Maps on page 4-38*.
2. Enter your destination and route settings. See *Enter Destination on page 4-27* for more information.

If you do not want to use the first method, keep your currently selected search area region and enter your destination. This method allows you only to select a destination from the easy planning route method or from the All Points of Interest (POI) categories with the “All Search Areas” comment for US Only. For example, Tourist is a category that features this comment. See *Enter Destination on page 4-27* for more information.

If you are traveling in or to Canada and you cross the regional border, the only map scale views available are 4 mi, 8 mi, 31 mi, and 128 mi (8 km, 16 km, 64 km and 256 km). Change the selected search area region when you get closer to the area you are traveling to. See “Setting the Search Area” under *Maps on page 4-38* for more information.

Keyless Access System

When the engine is started, Driver 1 or Driver 2 will display on the screen. A message will not appear on the screen if the driver is unknown. The number on the back of the transmitter corresponds to driver 1 or driver 2. The navigation system can store memory points for drivers 1 and 2 individually. See *Keyless Access System on page 2-4* for more information.

OnStar[®] System

When using the OnStar[®] system, the audio system will be muted and the navigation voice prompts will be disabled during the call. The volume of the OnStar[®] call can be adjusted by using the steering wheel volume controls. See *OnStar[®] System on page 2-37* for more information.

Global Positioning System (GPS)

The navigation system determines the position of your vehicle by using satellite signals, various vehicle signals, and map data.

The Global Positioning System (GPS) locates the current position of your vehicle using signals sent by the United States Department of Defense GPS satellites. While your vehicle is receiving signals from these satellites, the GPS symbol will not appear on the map screen. See *Symbols on page 4-42* for more information on the GPS symbol.

However, at times, other interferences such as the satellite condition, road configuration, the condition of the vehicle, and/or other circumstances can interfere with the system's ability to determine the accurate position of the vehicle. This is when the GPS symbol will appear on the map screen.

This system may not be available/or interferences may occur if any of the following are true:

- Signal are obstructed by tall buildings, large trucks, or a tunnels.
- Satellites are being repaired or improved.
- Objects are located on the rear shelf.
- After-market glass tinting has been applied to the vehicle's windows.

Notice: Do not apply after-market glass tinting to the vehicle's windows. Glass tinting will interfere with the system's ability to receive GPS signals and cause the system to malfunction. You might have to replace the window to correct the problem. This would not be covered by your warranty.

If you are experiencing a problem, see *Vehicle Positioning on page 4-49* or *Problems with Route Guidance on page 4-50* for more information.

Vehicle Positioning

At times, the position of the vehicle on the map may be inaccurate due to one or more of the following reasons:

- The road system has changed.
- The vehicle is traveling on slippery road surfaces such as sand, gravel, and/or snow.
- The vehicle is being driven on winding roads.
- The vehicle is being driven on a long straight road.
- The vehicle is approaching a tall building or a large vehicle.
- The surface streets run parallel to a freeway.
- The vehicle has just been transferred by a vehicle carrier or a ferry.
- The current position calibration is set incorrectly.
- The vehicle is being driven at high speeds.
- The vehicle is repeating a change of direction by going forward and backward, or turning on a turn table in a parking lot.
- The vehicle is entering and/or exiting a parking lot or garage with a roof.
- The vehicle has a roof carrier, ski, or bike rack installed on it.
- The vehicle has tire chains on it.
- The tires have been replaced.
- The tire pressure is incorrect.
- The tires are worn.
- The battery is disconnected.
- The vehicle is driven in heavy traffic where driving is at low speeds and the vehicle is stopped and started repeatedly.

Problems with Route Guidance

Inappropriate route guidance may occur under any of the following conditions:

- You have not turned onto the road indicated by the system.
- Route guidance is not available for the next turn.
- The route is not changed during automatic rerouting.
- Plural names of places are displayed.
- You are driving at high speeds, which may cause the automatic rerouting to operate more slowly.
- The route prohibits the entry of a vehicle due to a regulation by time or season or any other regulation which may be given.
- A route cannot be found.
- A road is new, was recently changed or is not listed on the DVD. The route to the destination may not be shown. See *Ordering Map DVDs on page 4-50*.

If the System Needs Service

If you are still experiencing difficulty with the navigation system after reading this information, see your GM dealer for assistance.

Ordering Map DVDs

The map DVD in your vehicle is the most up-to-date information available when your vehicle was purchased. The map DVD is updated periodically, provided that the map information has changed. To order a new map DVD, contact your dealer.

Database Coverage Explanations

Coverage areas vary with respect to the level of map detail available for any given area. Some areas will feature greater levels of detail than others. If this happens, it does not mean there is a problem with the system. As the map DVD is updated, more detail may become available for areas which previously had limited detail. See *Ordering Map DVDs on page 4-50*.

Navigation Audio System



Notice: Before adding any sound equipment to your vehicle, such as an audio system, CD player, CB radio, mobile telephone, or two-way radio, make sure that it can be added by checking with your dealer. Also, check federal rules covering mobile radio and telephone units. If sound equipment can be added, it is very important to do it properly. Added sound equipment may interfere with the operation of your vehicle's engine, radio, or other systems, and even damage them. Your vehicle's systems may interfere with the operation of sound equipment that has been added.

Your vehicle has a feature called Retained Accessory Power (RAP). With RAP, the audio system can be played even after the ignition is turned off. See *Retained Accessory Power (RAP)* on page 2-22 for more information.

The audio system is operated using navigation system menus. The audio menus are explained in this section.

Main Audio Menu



 /  **(Audio/Adjust):** Press this key to view the main audio screen.

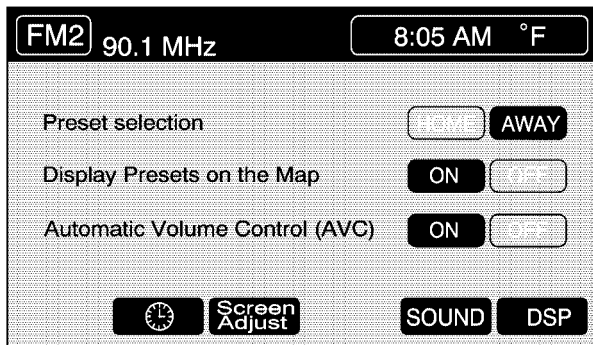

Preset Selection: Here you can program the audio system's presets to recall your home settings by touching HOME. You can also recall the presets you use when traveling to another area by touching AWAY. See "Preset Station Menu" later in this section for more information on how to store preset stations.

The Home and Away feature is not available for the XM™ Satellite Radio source, if equipped.

Display Presets on the Map: With this feature on, your audio system presets for the current audio source will be displayed on the left of the map screen. Touch ON to turn this feature on. You may also choose to turn this feature off.

With this feature on, you can recall your preset radio stations from the map screen. You cannot store preset stations from the map screen. You must do this from the audio screen. See "Preset Station Menu" later in this section for more information on storing presets.

Automatic Volume Control (AVC): To use AVC, touch the ON button. AVC automatically adjusts the volume level of the audio so that it always sounds the same to you. This feature is most effective at lower volume settings where background noise may be louder than the audio. At high volume settings there may be little or no change in the audio level. In some cases where the noise level changes quickly, you may hear the audio level changing. This is normal.

 **(Clock):** Touch this screen button to get to the CLOCK ADJUST menu. See "Clock Adjust Menu" later in this section for more information.

SCREEN ADJUST: To adjust the brightness or contrast of the screen, touch SCREEN ADJUST to display the screen adjust menu. See "Screen Adjust Menu" later in this section for more information.

SOUND: Touch this screen button to access the Sound menu. See "Sound Menu" later in this section for more information.

DSP (Digital Signal Processing): Touch this screen button to access the DSP menu. See "Adjusting the Speakers" later in this section for more information.

Clock Adjust Menu

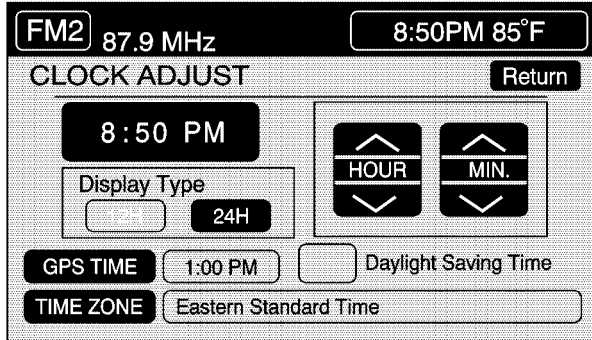

The following options are available from this menu:

HOUR/MIN.: Touch the up or down arrows to increase or decrease the hour or minutes. If you touch and hold one of the arrows, the numbers will advance quickly.

12H/24H: Touch 12H to set the clock in standard time or 24H to set the clock in military time.

GPS TIME: The current GPS time will be displayed to the right of this screen button. Touch GPS TIME to set the navigation system time to match current GPS time. If the seconds for the present minute are greater than thirty when GPS TIME is selected, the clock will round up to the next minute.

Daylight Saving Time: Touch this screen button to increase the time setting by one hour. Then touch GPS TIME to save the new setting. If the screen button is light blue, the daylight savings time feature is on. If the button is dark blue, the daylight savings time feature is off.

TIME ZONE: The selected time zone will appear to the right of this screen button. Touch this screen button to toggle between time zones and select the desired one. The time of the selected zone will be displayed to the right of the GPS TIME screen button. To set the clock to the new setting, touch GPS TIME.

If the system is not receiving GPS information, you can still set the time manually as described above but the GPS time and Daylight Saving Time features will not be available.

Touch Return to go back to the previous menu.

Screen Adjust Menu

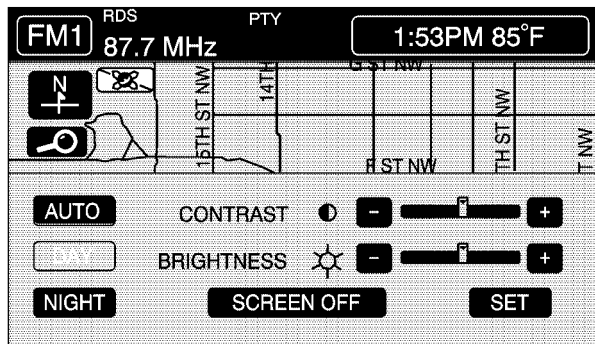

The following options are available from this menu:

CONTRAST: Touch the plus (+) or minus (-) signs to adjust the contrast of the screen.

You will see the screen change. Touch SET to confirm the setting.

BRIGHTNESS: Touch the plus (+) or minus (-) signs to adjust the brightness of the screen.

You will see the screen change. Touch SET to confirm the setting.

AUTO: This setting automatically adjusts the contrast and brightness of the screen depending on exterior lighting conditions.

DAY: This setting leaves the screen in day mode. Day mode is best suited for daylight conditions.

NIGHT: This setting leaves the screen in night mode. Night mode is best suited for nighttime conditions.

SCREEN OFF: Touch SCREEN OFF to turn off the screen. Press any hard key to turn the screen back on.

SET: Touch SET to save your choices and exit the CLOCK ADJUST menu.

Language

Your vehicle has been set for the English language. If you wish to change the language, you must do so through the Driver Information Center (DIC). See *Driver Information Center (DIC) on page 3-64* for more information.

If the language is changed from English, a majority of the voice guidance prompts and screen text will change to the selected language. Remember, the menu screens will not match word-for-word as they appear in this manual.

Playing the Radio

PWR-VOL (Power-Volume): Press this knob to turn the audio and navigation systems on and off. Turn the knob to increase or decrease the volume to the audio system.

∧ **TUNE/SEEK** ∨ : Press the up or down arrow to go to the next or previous station and stay there.

BAND: Press this key to switch between AM, FM1, FM2, XM1, XM 2, or WX, if equipped. If you are on a map screen and press this key, the screen will not change but the audio source will.

Finding a Station

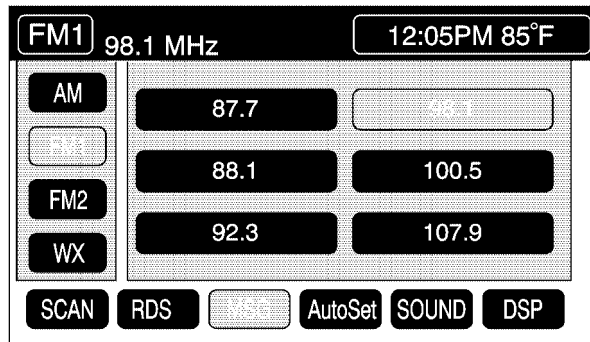

FM1 audio source shown, other sources similar

Press the BAND key to switch between AM, FM1, FM2, XM1, XM2, or WX, if equipped. Touch the desired audio source to select it.

Preset Station Menu

Up to 36 stations, 6 AM, 6 FM 1, 6 FM 2, 6 XM 1, 6 XM 2, and 6 WX, if equipped, can be programmed for home and for away. To store presets, do the following:

1. Turn the audio system on.
2. Touch AM, FM, XM, or WX, if equipped, to display the desired source. The preset station menu will appear.
3. Tune to the desired station by using the TUNE/SEEK arrows.
4. Touch SOUND to set the bass, mid-range, treble, and DSP for your preset, if desired. See “Sound Menu” later in this section for more information.
5. Touch and hold one of the six numbered preset buttons for more than two seconds until you hear a beep.
6. Repeat the steps for each preset and source.

SCAN: To scan stations, touch SCAN. The radio will go to a station, play for a few seconds, then go on to the next station. Touch SCAN again to stop scanning.

To scan preset stations, touch and hold SCAN for two seconds. It will only scan the audio source it is in, with the exception of FM 1 and FM 2, which will both be scanned if in that source. Touch SCAN again to stop scanning.

RDS (Radio Data System): See “Radio Data System (RDS)” later in this section for more information.

MSG (Message): See “Radio Data System (RDS)” later in this section for more information.

AutoSet: Touch AutoSet to replace currently stored preset stations with the strongest stations available in the immediate area. Touch AutoSet again to return to the original preset stations.

SOUND: See “Sound Menu” following for more information.

DSP: See “Adjusting the Speakers” later in this section for more information.

Sound Menu

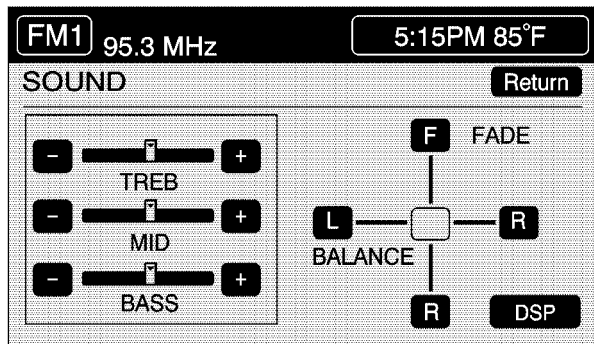

Touch **SOUND** at the bottom of the main audio screen, source menu, or DSP menu to change the tone, DSP, if equipped, fade, and balance for all sources. The audio system has a separate setting for these features for each source preset. However, the audio system keeps one fade and one balance setting for all audio sources.

To adjust sound settings, do the following:

1. Touch the plus (+) or minus (-) signs to adjust treble, mid-range, and bass.
2. Touch the L for left or R for right to adjust the balance of the speakers.
3. Touch the F for front or R for rear to adjust the fade of the speakers.
4. Touch DSP to adjust your DSP, if equipped.
See "Adjusting the Speakers" later in this section for more information.

After adjustments are made, touch any source screen button. This will take you back to the preset station menu. Whenever you touch that screen button, the previously stored information you have entered for each preset station will be recalled.

To adjust the tone for each preset, do the following:

1. Press the BAND key.
2. Touch AM, FM1, FM2, XM1, XM2, or WX, if equipped, to access the desired preset screen.
3. Touch SOUND.
4. Touch the plus (+) or minus (-) signs to adjust treble, mid-range, and bass.
5. Touch Return to exit. This will take you to the preset station menu.
6. Touch and hold one of the six preset screen buttons for more than two seconds until you hear a beep. Whenever you touch that preset for less than two seconds, the station and previously stored information you have entered for each preset station will be recalled.
7. Repeat the steps for additional presets.

Adjusting the Speakers

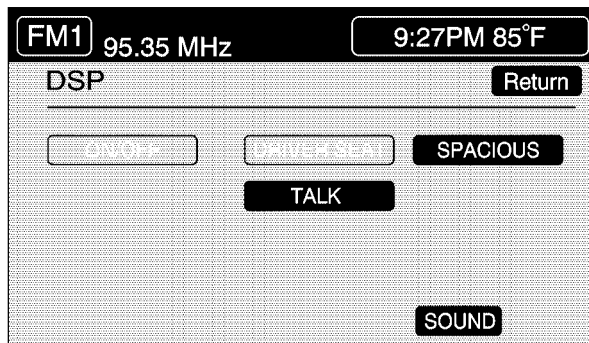

DSP (Digital Signal Processing): The DSP feature is used to provide a choice of four different listening experiences. DSP can be used while listening to the audio system or the CD player. The audio system can store separate DSP settings for each source and preset station, except WX, which is always set to TALK.

To save DSP settings for your preset stations, use the SOUND menu or touch DSP from the preset station menu to access the DSP menu. See “Sound Menu” listed previously in this section for more information.

Touch DSP to change the following options:

ON/OFF: Touch ON/OFF to turn DSP on and off.

DRIVER SEAT: Touch this button to adjust the audio to give the driver the best possible sound quality.

TALK: TALK makes spoken words sound very clear. Touch this button when listening to non-musical material such as news, talk shows, and sports broadcasts.

SPACIOUS: Touch this button to make the listening space seem larger.

SOUND: Touch SOUND to access the Sound menu. See “Sound Menu” listed previously in this section for more information.

Radio Data Systems (RDS)

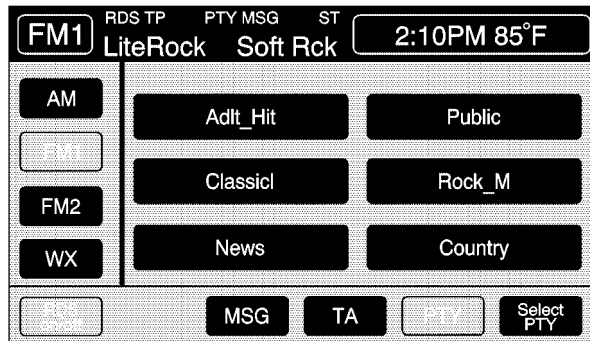

The audio system has a Radio Data System (RDS). RDS features are available for use only on FM stations that broadcast RDS information. With RDS, the radio can do the following:

- Seek to stations broadcasting the selected type of programming
- Receive announcements concerning local and national emergencies
- Display messages from radio stations
- Seek to stations with traffic announcements

RDS: Touch RDS to use alternate RDS functions located in the preset menu. When you touch RDS, you will only have about five seconds to choose RDS ON/OFF, TA, MSG, PTY, or SEL PTY. If you do not make a selection, the system will return to the previous menu.

If you are tuned to a station broadcasting RDS information, the station's Program Service (PS) and Program Type (PTY) will replace the station's frequency on the status line at the top of the display. After about five seconds, if available, the PTY will be replaced on the display by the station's PTY name. The PTY and PTY name may be the same or different.

If the audio system is tuned to a station that is not broadcasting RDS information, the station's frequency will remain on the display. While RDS is on, the audio system will search for a stronger station in the network if a station gets too weak for listening.

The RDS feature relies upon receiving specific information from RDS stations. These features will only work when RDS information is available.

TA (Traffic): Touch TA to receive traffic announcements. The audio system will turn on the TA display. TA will appear on the display if the current station broadcasts traffic announcements. You may also receive traffic announcements from stations in the network related to the current station. If the current station does not broadcast traffic announcements, the audio system will seek to a station which will. When the audio system finds a station which broadcasts traffic announcements, it will stop. If no station is found, TA will turn off.

While a traffic announcement plays, the audio system uses TA volume. To increase TA volume, touch the VOL button on your steering wheel or use the VOL up or down buttons during the announcement. See "Voice Guidance Volume Settings" under *Setup Menu on page 4-13* for more information.

When a traffic announcement comes on the current radio station or a related network station, you will hear it even if the volume is muted or a CD is playing. If the audio system tunes to a related network station for a traffic announcement, it will return to the original station when the announcement is finished. If the CD player was being used, the CD will stay in the player and resume play at the point where it stopped.

Touch RDS followed by TA again to turn TA off.

MSG (Message): When RDS is on, if the current station has a message, MSG will appear on the display. Touch MSG from the preset menu to view the message. If the whole message does not appear on the display, parts of the message will appear every three seconds until the message is completed. Once the complete message has been displayed, MSG will disappear from the display until another new message is received. MSG will remain available to allow you to display the entire message again.

PTY: PTY allows you to seek only stations with types of programs you want to listen to. This button is used to turn on and off Program Type (PTY) features.

With RDS on, touch RDS, followed by PTY. The PTY display will turn on. Touch RDS followed by this button again to turn the PTY display off.

Select PTY (Select Program Type): With RDS and PTY on, touch RDS, then SEL PTY. The PTY menu will appear. Use the up and down arrows to select a PTY. Touch your PTY selection and the system will return you to the screen with the preset stations shown. See Steps 1 through 7 under “Preset Station Menu” to store the selected PTYs. The selected PTY is then stored on the preset. You can now touch the PTY preset to recall your settings.

When the PTY display is on, press TUNE/SEEK and SCAN to find radio stations of the PTY selected. The last PTY selected will be used for seek and scan modes. If a station with the selected PTY is not found, NONE FOUND will appear on the display. If both PTY and TA are on, the audio system will search for stations with traffic announcements and the selected PTY.

PTY (Program Type) Presets: The six presets let you return to your favorite PTYs. These presets have factory PTY preset stations. See “RDS Program Type (PTY) Selections” later in this section. You can set up to 12 PTYs, 6 FM 1 and 6 FM2. To save a PTY preset, do the following:

1. Touch FM1 or FM2.
2. Touch RDS to enter the RDS menu.
3. Touch RDS ON/OFF to turn RDS on.
4. Touch PTY.
5. Touch SEL PTY and select the desired PTY from the list.
6. Touch and hold one of the six presets for more than two seconds until you hear a beep. Whenever you touch that numbered preset for less than two seconds, the PTY you set will return.
7. Repeat the steps for each preset.

Once you have stored a PTY for each of your preset stations, you can recall a PTY preset by touching the preset station for less than two seconds. Then use TUNE/SEEK or SCAN to locate a station for that PTY selection.

ALERT: This type of announcement warns of national or local emergencies. You will not be able to turn off alert announcements. Alert announcements will come on even if RDS mode is turned off. ALERT appears on the display when an alert announcement plays. The audio system uses TA volume during these announcements. To increase volume, touch the VOL button on your steering wheel or use the VOL up and down buttons during the announcement. See "Voice Guidance Volume Settings" under *Setup Menu on page 4-13* for more information. When an alert announcement comes on the tuned radio station or a related network station, you will hear it even if the volume is muted or a CD is playing. If the audio system tunes to a related network station for an alert announcement, it will return to the original station when the announcement is finished. If the CD player is playing, the player will stop for the announcement and resume when the announcement is finished.

XM™ Satellite Radio Service

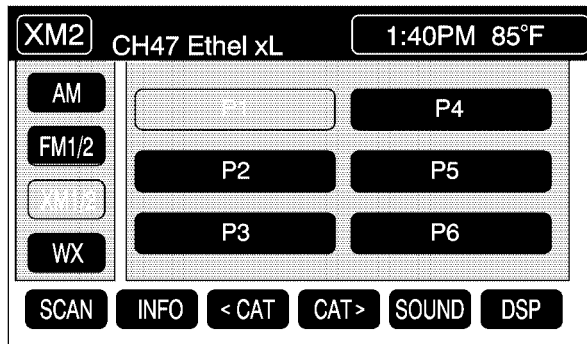

XM™ is a satellite radio service that is based in the 48 contiguous United States and in Canada (if available). XM™ offers 100 coast-to-coast channels including music, news, sports, talk, and children's programming. XM™ provides digital quality audio and text information, including song title and artist name. A service fee is required in order to receive the XM™ service. For more information, contact XM™ at www.xmradio.com or call 1-800-852-XMXM (9696).

INFO (Information): Touch INFO while in XM™ mode to retrieve various pieces of information related to the current song or channel. By touching INFO, you may retrieve four different categories of information: Artist Name/Feature, Song/Program Title, Channel Category, and other Additional Information that may be broadcast on that channel. Additional Information messages may only be available at certain times or on certain programs. If an Additional Information message is being broadcast on the tuned channel, INFO will appear on the display.

Each of the four information types may have multiple pages of text. To reach a category, touch INFO repeatedly until the desired type is displayed. If there are multiple pages of text for the information selected type, the radio will automatically display all the pages for that type at a rate of about one page every three seconds before timing out and returning to the default display. You may override this feature by touching INFO to review all of the pages at your own pace.

XL (Explicit Language Channels): XL on the radio display, after the channel name, indicates content with explicit language. These channels, or any others, can be blocked at a customer's request, by calling 1-800-852-XXMX (9696).

Setting Program Type (PTY) Preset Stations

< CAT > (Category): Press the arrows to select a category.

Once the desired category is displayed, press TUNE/SEEK to select the category and take you to the category's first station. If you want to go to another station within that category, press TUNE/SEEK once.

Touch and hold one of the desired P1-P6 presets to store the selected station as a preset. If PTY times out and is no longer on the display, start again.

SCAN: Use this button to scan through the channels within a category or scan through the preset stations. To scan through the channels in a category, do the following:

1. Select a category by using the category arrows.
2. Once the desired category is displayed, touch SCAN. The radio will begin scanning within the chosen category.
3. Touch SCAN again to stop scanning.

To scan through your preset stations, touch and hold SCAN. Touch SCAN again to stop scanning.

XM Radio Messages

Radio Display Message	Condition	Action Required
XM Updating	Updating encryption code	The encryption code in your receiver is being updated, and no action is required. This process should take no longer than 30 seconds.
No XM Signal	Loss of signal	Your system is functioning correctly, but you are in a location that is blocking the XM signal. When you move into an open area, the signal should return.
Loading XM	Acquiring channel audio (after 4 second delay)	Your radio system is acquiring and processing audio and text data. No action is needed. This message should disappear shortly.
Channel Off Air	Channel not in service	This channel is not currently in service. Tune in to another channel.
Channel Unavail	Channel no longer available	This previously assigned channel is no longer assigned. Tune to another station. If this station was one of your presets, you may need to choose another station for that preset button.
No Artist Info	Artist Name/Feature not available	No artist information is available at this time on this channel. Your system is working properly.
No Title Info	Song/Program Title not available	No song title information is available at this time on this channel. Your system is working properly.
No CAT Info	Category Name not available	No category information is available at this time on this channel. Your system is working properly.

Radio Display Message	Condition	Action Required
Not Found	No channel available for the chosen category	There are no channels available for the category you selected. Your system is working properly.
No Information	No Text/Informational message available	No text or informational messages are available at this time on this channel. Your system is working properly.
XM Theftlocked	Theft lock active	The XM receiver in your vehicle may have previously been in another vehicle. For security purposes, XM receivers cannot be swapped between vehicles. If you receive this message after having your vehicle serviced, check with the servicing facility.
XM Radio ID	Radio ID label (channel 0)	If you tune to channel 0, you will see this message alternating with your XM Radio 8 digit radio ID label. This label is needed to activate your service.
Unknown	Radio ID not known (should only be if hardware failure)	If you receive this message when you tune to channel 0, you may have a receiver fault. Consult with your dealer.
Check XM Receivr	Hardware failure	If this message does not clear within a short period of time, your receiver may have a fault. Consult with your retail location.

Six-Disc CD Changer

With the compact disc changer, you can play up to six normal size discs continuously.

When the radio is turned on, the changer will begin checking for discs. This will continue for up to one and a half minutes, depending on the number of discs loaded. You may hear noise, but this is normal. The CD changer is initializing.

Press the CD hard key to access the six-disc CD changer screen. You can also use the system's DVD player for single CD play once the map DVD is removed. See *CD/DVD Player on page 4-69* for more information.

If no CD is loaded in the CD/DVD Player and you press the CD hard key, the message "No CD Loaded" will appear on the display.



CD Changer Screen

Once you access the CD changer screen, you can select one of the numbered buttons to go from one compact disc to another among those loaded in the CD changer and use the arrows to rewind or fast forward through the disc selected.

The following features are also available from this screen:

- LOAD
- EJECT
- SCAN THE DISCS or SCAN THE TRACKS
- and RANDOM ALL or RANDOM DISC.

The numbered buttons (1 through 6) represent the order of the discs loaded in the changer. If there are only two CDs loaded, buttons 1 and 2 will only be available to choose from.

LOAD: Touch this button once each time you wish to load a CD into the changer. It may take up to 10 seconds for the changer to accept the CD into the slot depending on the changer initializing. Repeat this procedure for loading up to six discs. Press and hold the LOAD button until a beep is heard to put the changer in LOAD ALL mode. Once the Insert CD message is displayed, you can load all six discs, one after the other.

▶ **(Play):** Touch this button to begin playing a CD.

RANDOM DISC: Touch this button to hear the tracks in random, rather than sequential, order on the disc selected. Press the TUNE/SEEK hard key to randomly seek through the tracks on this disc. Touch RANDOM DISC again to turn off random play mode.

SCAN TRACKS: Touch this button to hear the first 10 seconds of each track on the selected disc. Touch this button again to stop scanning. The CD will mute while scanning.

◀ **(Rewind):** Touch this button to rewind quickly through a track selection.

EJECT: Touch this button once to eject the chosen CD. The chosen CD may be selected by first touching one of the numbered buttons from 1 to 6. Repeat this procedure for ejecting up to six discs from the changer. If you press and hold the EJECT button until a beep is heard, The system will begin to eject all of the discs from the player. Once the CD is removed the next will come out until they are all ejected.

|| (Pause): Touch this button to pause CD play. Touch it again to resume play or touch the play button.

RANDOM ALL: Touch this button to hear the tracks on all of the discs in the CD changer in random, rather than sequential, order. Press the TUNE/SEEK hard key while RANDOM ALL is on to randomly seek within that disc. Touch RANDOM ALL again to turn off random mode.

SCAN DISCS: Touch this button to hear the first 10 seconds of first track on each disc. Touch this button again to stop scanning. The CD will mute while scanning.

▶ (Forward): Touch this button to fast forward quickly through a track selection.

∧ TUNE SEEK ∨ : Press the up arrow on the TUNE/SEEK switch to seek to the next selection on the compact disc. If playing last track of disc, pressing the up arrow will seek to the first track of the next disc. Press the down arrow to seek to the previous selection on the compact disc. If playing the first track of disc, pressing the down arrow will seek to the last track on the selected disc. The sound will mute while seeking.

RDS (Radio Data Systems): See “Radio Data Systems (RDS)” listed previously for information on this button.

SOUND: See “Sound Menu (Tone, DSP, Fade and Balance)” for information on this button.

DSP (Digital Signal Processing): See “Adjusting the Speakers” listed previously for information on this button.

CD Changer Errors

CDX ERROR could be displayed for the following:

- The road is too rough. The disc should play when the road is smoother.
- The disc is dirty, scratched, wet or not loaded label side up.
- The air is very humid. If so, wait about an hour and try again.

If any error occurs repeatedly or if an error cannot be corrected, please contact your GM dealer. If your audio system displays an error number, write it down and provide this information to your dealer when reporting the error.

CD/DVD Player

The player that is used for the navigation map DVD can also be used as a single music CD player or a video DVD player.

CD Player

To use the player as a single music CD player, you must first remove the navigation map DVD. While playing a CD in the CD/DVD Player, the navigation system is not available. The message “The disc installed is not a map DVD” will appear on the display if any of the navigation hard keys are pressed.

To remove the navigation map DVD and load a music CD, use the following steps:

1. Start the vehicle.
2. Press the TILT hard key until you hear a beep. This will open the faceplate of the system.
3. If one is loaded, the navigation map DVD will eject from the slot.
4. Gently remove the navigation map DVD from the slot and return it to its case.
5. Insert the music CD into the slot. The system will pull the CD into the player.
6. Press and release the TILT hard key to close the faceplate.

Notice: Shifting out of PARK (P) with the system’s faceplate open will cause the faceplate to close automatically. This could cause damage to a CD, DVD or the system if it is partially loaded. Before shifting out of PARK (P), make sure that the DVD or CD is loaded properly. The vehicle must be shifted back into PARK (P) to close the faceplate.

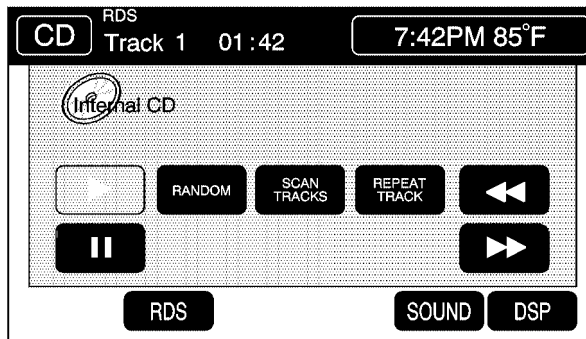

CD Player Screen

Once a music CD is loaded, the CD player menu will appear on the display. When using the system as a single CD player, the CD hard key will alternate between the CD player and the six-disc CD changer if CDs are loaded.

▶ **(Play):** Touch this button to begin playing a CD.

RANDOM: Touch this button to hear the tracks in random, rather than sequential, order on the disc. Touch RANDOM again to turn off random mode.

SCAN TRACKS: Touch this button to hear the first 10 seconds of each track on the disc. Touch this button again to stop scanning. The CD will mute while scanning.

REPEAT TRACK: Touch this button to repeat the selected track.

◀◀ **(Rewind):** Touch this button to rewind quickly through a track selection.

|| **(Pause):** Touch this button to pause CD play. Touch it again to resume play or touch the play button.

▶▶ **(Forward):** Touch this button to fast forward quickly through a track selection.

∧ **TUNE SEEK** ∨ : Touch the up arrow on the TUNE/SEEK hard key to seek to the next selection on the compact disc. If playing the last track of the disc, touching the up arrow will seek to the first track of the disc. Touch the down arrow to seek to the previous selection on the compact disc. If playing the first track of the disc, touching the down arrow will seek to the last track of the disc. The sound will mute while seeking.

DVD Player

To use the player as a video DVD player, you must first remove the navigation map DVD or music CD. While playing a video DVD, the navigation system is not available. The message “The disc installed is not a map DVD” will appear on the display if any of the navigation hard keys are pressed.

This feature will not operate unless the vehicle is in PARK (P).

To remove the navigation map DVD and load a video DVD, use the following steps:

1. With the vehicle in PARK (P) and the vehicle running, press the TILT hard key until a beep is heard. The faceplate of the system will open.
2. If a map DVD or a music CD is loaded, the system will automatically eject it. Gently remove it from the slot and return it to its case.
3. Load the video DVD into the slot. The system will pull the DVD into the player.
4. Press and release the TILT hard key to close the faceplate.

Notice: Shifting out of PARK (P) with the system's faceplate open will cause the faceplate to close automatically. This could cause damage to a CD, DVD or the system if it is partially loaded. Before shifting out of PARK (P), make sure that the DVD or CD is loaded properly. The vehicle must be shifted back into PARK (P) to close the faceplate.

Once the faceplate is closed and a video DVD is loaded, the system will automatically play the DVD.

Playing a DVD

There are three ways to play a DVD depending on which screen you are on. They are the following:

- Once a DVD is inserted, the system will automatically play the DVD.
- If you are on a map screen, touch the DVD source button.
- From the audio screen, press the DVD hard key.

DVD Menu Options

To display the menu choices while a DVD is playing, touch anywhere on the screen and the menu will appear.



IMAGE: Touch this button to either start playing a DVD or to remove the DVD menu screen.

AUDIO PROGRAM: Touch this button to change the audio language heard.

VIEWING ANGLE: Touch this button to adjust the viewing angle of the DVD. Some DVDs allow you to change the camera angle. This may not be available on all DVDs. Depending on the type of DVD you are using, this button may or may not be available.

SUBTITLE: Touch this button to playback the video with subtitles. This may not be available on all DVDs. Depending on the type of DVD you are using, this button may or may not be available.

SCREEN ADJUST: Touch this button to adjust the brightness, contrast and red/green color adjustments.

CURSOR: Touch this button to access the left/right and up/down cursors on the screen. The cursors allow you to navigate menu options on the screen.

MENU: Touch this button to access the DVDs menu options. Depending on the type of DVD you are using, this button may or may not be available. Touch the button labeled one, two or blank to change the image size displayed on the screen.

TITLE: Touch this button to display the title of the DVD. Depending on the type of DVD you are using, this button may or may not be available.

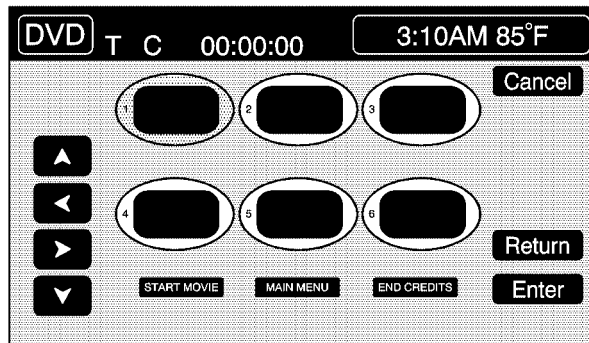

If TITLE is available, this button will allow you to navigate through chapters or the DVD features. Once the appropriate title or track has been selected, press the Return button then the IMAGE button on the DVD menu to view the movie in full screen.

SETTING: Touch this button to adjust the following:

- LANGUAGE PREFERENCES
- PARENTAL LOCK

Under LANGUAGE PREFERENCES, you can select different languages for AUDIO, SUBTITLE and DVD MENUS.

1. To change languages, first select the option you wish to change.
2. Select a language from the list given.
3. Touch RETURN to end out the menu.
Your language is now saved.

Under PARENTAL LOCK, you can select SET RATING LIMIT and SET PIN.

To SET RATING, first touch the button. Then, make your selection. Touch RETURN to end out the menu. Your selection is now saved.

To use PARENTAL LOCK, first touch the button. Then, enter a four-digit numeric password. Touch RETURN to end out the menu.

SEARCH: Touch this button to search to a certain scene on the DVD. Depending on the type of DVD you are using, this button may or may not be available.

◀ (Rewind): Touch this button to rewind through a scene during playback.

▶ (Resume): Touch this button to resume playing a DVD.

■ (Stop): Touch this button to stop the DVD.

|| (Pause): Touch this button to pause the DVD.

▶▶ (Forward): Touch this button to advance rapidly during playback.

▶ (Frame Advance): Touch this button to advance by chapter during playback.

Radio Personalization with Home and Away Feature

With this feature, you can recall the latest audio system settings as adjusted the last time your vehicle was operated. This feature allows two different drivers to store and recall their own audio system settings.

The settings recalled by the audio system are determined by which transmitter (1 or 2) was used to enter the vehicle. The number on the back of the transmitter corresponds to driver 1 or to driver 2. The audio system settings will automatically adjust to where they were last set by the identified driver. The settings can also be recalled by briefly pressing the MEMORY seat switches 1 or 2 located on the driver's door.

Your audio system can store HOME and AWAY preset stations. HOME and AWAY preset stations allow you to use one set of preset radio settings in the area where you live, and another set when you go out of town. That way, you will not need to reprogram your preset stations every time you travel.

To select HOME and AWAY preset stations, do the following:

1. With the audio system on, touch the Audio hard key and turn the audio system off.
2. Touch the HOME or AWAY button from the main audio screen.

The next time the audio system is turned on, the system will recall the last active preset selection.

When battery power is removed and later applied, you will not have to reset your home audio system preset stations because the audio system remembers them. However, you will have to reset your away radio preset stations.

Voice Recognition

The navigation system's voice recognition allows for hands-free operation of navigation and audio system features. Voice recognition can be used when the ignition is on or when Retained Accessory Power (RAP) is active.

This feature only works if the map DVD is inserted and I AGREE has been selected. If you try to use voice recognition without the map DVD inserted, the system will display "Please insert the navigation map DVD to use the voice recognition feature."

To use navigation voice recognition, do the following:

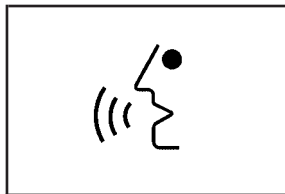

1. Press the talk symbol steering wheel control and release it, when you hear a beep. The audio system, if on, will mute.

2. Clearly state one of the commands listed on the following pages. For example, say "FM1".
3. The system will tell you the command being implemented. For example, the system will say "FM1 Radio" and change the audio system to the FM1 source.

You can end voice recognition by not speaking any commands. After about five seconds of silence, the system will automatically cancel voice recognition.

At times, the system may not understand a spoken command. If this happens, try saying the command again. If a spoken command is not available, the system will provide feedback based on availability.

While using voice recognition, make sure to keep interior noise levels to a minimum. Otherwise, the system might not recognize voice commands.

The system will only recognize commands spoken in English.

Voice Recognition Commands

The following list shows all of the voice commands available for the navigation system with a brief description of each. To use the voice commands, refer to the instructions listed previously.

Help Commands

These commands are universal and will enable you to use the help prompts available from the system.

Map Help: This command will enable the system to provide the available commands for the map screen.

Destination Help: This command will enable the system to provide the available commands for entering a destination.

Guidance Help: This command will enable the system to provide the available commands for the guidance method.

Radio Help: This command will enable the system to provide the available commands for the radio.

Disc Help: This command will enable the system to provide the available commands for the CD changer.

Radio Commands

Radio: This command will change the audio system to the next radio audio source.

AM: This command will change the audio system to the AM audio source.

FM1: This command will change the audio system to the FM1 audio source.

FM2: This command will change the audio system to the FM2 audio source.

XM1: This command will change the audio system to the XM1 audio source.

XM2: This command will change the audio system to the XM2 audio source.

CD Changer: This command will change the audio system to the CD changer audio source.

WX, Weather Band: These commands will change the audio system to the weather band audio source.

Power On, Audio On: These commands will turn the system's power on.

Power Off, Audio Off: These commands will turn the system's power off.

Seek Up: This command will cause the selected audio source to seek up to the next strongest signal.

Seek Down: This command will cause the selected audio source to seek down to the next strongest signal.

Stop Scan: This command will cause the audio source to stop scanning for the next strongest signal.

CD Changer Commands

Track Up: This command will cause the CD changer to skip up to the next track.

Previous Track, Track Down: This command will cause the CD changer to go to the previous track.

Screen Commands

Screen Day Mode, Day Mode On: These commands will adjust the system's screen setting to the day mode.

Screen Night Mode, Night Mode On: These commands will adjust the system's screen setting to the night mode.

Screen Auto Mode, Auto Mode On: These commands will adjust the system's screen setting to auto mode.

Screen Off: This command will turn the system's screen display off.

Position Commands

Current Position, Current Location, Show Current Position, Show Current Location: These commands will cause the system to display the vehicle's current location on the map screen.

Map: This command will cause the system to display the map screen.

Map Commands

Zoom In: This command will cause the system to zoom in when on the map screen.

Zoom Out: This command will cause the system to zoom out when on the map screen.

Maximum Scale: This command will cause the system to zoom out to the maximum available map scale when on the map screen.

Minimum Scale: This command will cause the system to zoom in to the minimum available map scale when on the map screen.

Heading Up, Change to Heading Up: These commands will cause the system to display the Vehicle Up heading when on the map screen. The map scale should be set for under 2 miles (4 km).

North Up, Change to North Up: These commands will cause the system to display the North Up heading when on the map screen if the map scale is set to 2 miles (4 km) or less.

Map Direction, Change Map Direction: These commands will cause the system to change the vehicle's direction from North Up to Heading Up or Heading Up to North Up on the map screen if the map scale is set to 2 miles (4 km) or less.

Mark, Mark This Point: These commands will cause the system to mark the location as a memory point while on the map screen.

Destination Commands

Home, Go Home: These commands will cause the system to enter the Home destination, if one is set.

Go To Starting Point, Previous Starting Point: These commands will cause the system to enter the last available starting point as a destination.

Guidance Commands

Repeat Guidance, Repeat Voice: These commands will cause the system to repeat the last available voice prompt guidance command if a destination has been set.

Louder: This command will cause the system to increase the volume of the navigation voice prompts if a destination has been set.

Softer: This command will cause the system to decrease the volume of the navigation voice prompts if a destination has been set.

Voice Guidance Off: This command will cause the system to turn off the navigation voice prompts if a destination has been set.

Voice Guidance On: This command will cause the system to turn on the navigation voice prompts if a destination has been set.

Open Guidance, Open Guidance Screen, Open Guide, Open Guide Screen: These commands will cause the system to open the Guidance Appearance menu if a destination has been set.

Close Guidance, Close Guidance Screen, Close Guide, Close Guide Screen: These commands will cause the system to close the Guidance Appearance menu if a destination has been set.

Arrow Guidance, Arrow Guide, Change To Arrow Guidance, Change To Arrow Guide: These commands will cause the system to change to Arrow Guidance screen view in the Guidance Menu if a destination has been set.

Turn List Guidance, Turn List Guide, Change to Turn List Guidance, Change to Turn List Guide: These commands will cause the system to change to Turn List Guidance screen view in the Guidance Menu if a destination has been set.

Entire Route, Entire Route Map, Route Overview: These commands will cause the system to display the entire route if a destination has been set.

Reroute: This command will cause the system to generate an alternate route to a set destination while on a planned route.

Detour, Detour Entire Route: These commands will cause the system to activate the detour feature when driving a planned route.

Delete Destination, Cancel Destination: These commands will cancel a destination if one has been set.

Next Waypoint Map: This command will cause the system to display the map view of the next waypoint location if one has been set.

First Waypoint Map: This command will cause the system to display the map view of the first waypoint location if one has been set.

Second Waypoint Map: This command will cause the system to display the map view of the second waypoint location if more than one waypoint has been set.

Third Waypoint Map: This command will cause the system to display the map view of the third waypoint location if more than two waypoints have been set.

Fourth Waypoint Map: This command will cause the system to display the map view of the fourth waypoint location if more than three waypoints have been set.

Fifth Waypoint Map: This command will cause the system to display the map view of the fifth waypoint location if more than four waypoints have been set.

Destination Map: This command will cause the system to display the map view of the final destination location if one has been set.

Point of Interest (POI) Commands

The following commands will cause the system to display icons if they are available on the map screen when the map scale is set to a half mile (eight-tenths km) or less.

Restaurant, I'm Hungry: These commands will cause the system to display restaurant POI icons.

American Restaurant, American Food: These commands will cause the system to display American restaurant POI icons.

Chinese Restaurant, Chinese Food: These commands will cause the system to display Chinese restaurant POI icons.

Continental Restaurant, Continental Food: These commands will cause the system to display Continental restaurant POI icons.

French Restaurant, French Food: These commands will cause the system to display French restaurant POI icons.

Italian Restaurant, Italian Food: These commands will cause the system to display Italian restaurant POI icons.

Japanese Restaurant, Japanese Food: These commands will cause the system to display Japanese restaurant POI icons.

Mexican Restaurant, Mexican Food: These commands will cause the system to display Mexican restaurant POI icons.

Seafood Restaurant, Seafood: These commands will cause the system to display Seafood restaurant POI icons.

Other Restaurant, Other Food: These commands will cause the system to display other types of restaurant POI icons.

Shopping, Shopping Mall: These commands will cause the system to display mall POI icons.

Grocery Store: This command will cause the system to display grocery store POI icons.

Gas Station, Gas: These commands will cause the system to display gas station POI icons.

Parking Garage: This command will cause the system to display parking garage POI icons.

Parking Lot: This command will cause the system to display parking lot POI icons.

Rental Car Agency: This command will cause the system to display rental car POI icons.

Automobile Club, Triple A: These commands will cause the system to display auto club POI icons.

Auto Service And Maintenance, Auto Service, Maintenance: These commands will cause the system to display auto service POI icons.

Hotel: This command will cause the system to display hotel POI icons.

Golf Course: This command will cause the system to display golf course POI icons.

Ski Resort, Skiing: These commands will cause the system to display ski resort POI icons.

Amusement Park: This command will cause the system to display amusement park POI icons.

Sport Complex, Stadium: These commands will cause the system to display sports complex POI icons.

Casino: This command will cause the system to display casino POI icons.

Marina: This command will cause the system to display marina POI icons.

Tourist Attraction: This command will cause the system to display tourist attraction POI icons.

Winery: This command will cause the system to display winery POI icons.

City Hall: This command will cause the system to display city hall POI icons.

Police Station: This command will cause the system to display police station POI icons.

Library: This command will cause the system to display library POI icons.

Hospital: This command will cause the system to display hospital POI icons.

Park & Recreation, Parks & Recreation: These commands will cause the system to display parks and recreation POI icons.

Civic Center, Community Center: These commands will cause the system to display community center POI icons.

Convention Center, Exhibition Center: These commands will cause the system to display convention center POI icons.

Court House: This command will cause the system to display court house POI icons.

Train Station: This command will cause the system to display train station POI icons.

Airport: This command will cause the system to display airport POI icons.

Bus Station: This command will cause the system to display bus station POI icons.

Commuter Rail Station: This command will cause the system to display commuter rail station POI icons.

Ferry Terminal: This command will cause the system to display ferry terminal POI icons.

Park & Ride: This command will cause the system to display park & ride POI icons.

Rest Area, Rest Stop: These commands will cause the system to display rest area POI icons.

Tourist Information: This command will cause the system to display tourist information POI icons.

Historical Monument: This command will cause the system to display historical monument POI icons.

Performing Arts: This command will cause the system to display performing arts POI icons.

Museum: This command will cause the system to display museum POI icons.

Bank: This command will cause the system to display bank POI icons.

School: This command will cause the system to display school POI icons.

ATM: This command will cause the system to display ATM POI icons.

Higher Education, University, College: These commands will cause the system to display higher education POI icons.

Business Facility: This command will cause the system to display business facility POI icons.

City Center: This command will cause the system to display city center POI icons.

POI Off: This command will cause the system to turn off POIs so they do not appear on the map screen.

Section 5 Driving Your Vehicle

Your Driving, the Road, and Your Vehicle	5-2	Driving in Rain and on Wet Roads	5-20
Defensive Driving	5-2	City Driving	5-22
Drunken Driving	5-3	Freeway Driving	5-23
Control of a Vehicle	5-6	Before Leaving on a Long Trip	5-24
Braking	5-6	Highway Hypnosis	5-25
Anti-Lock Brake System (ABS)	5-7	Hill and Mountain Roads	5-26
Braking in Emergencies	5-9	Winter Driving	5-27
Traction Control System (TCS)	5-9	If Your Vehicle is Stuck in Sand, Mud, Ice or Snow	5-32
Magnetic Ride Control	5-11	Rocking Your Vehicle to Get It Out	5-32
Limited-Slip Rear Axle	5-11	Loading Your Vehicle	5-33
StabiliTrak® System	5-11	Towing	5-37
Steering	5-13	Towing Your Vehicle	5-37
Off-Road Recovery	5-15	Recreational Vehicle Towing	5-37
Passing	5-16	Towing a Trailer	5-37
Loss of Control	5-17		
Driving at Night	5-18		

Your Driving, the Road, and Your Vehicle

Defensive Driving

The best advice anyone can give about driving is: Drive defensively.

Please start with a very important safety device in your vehicle: Buckle up. See *Safety Belts: They Are for Everyone* on page 1-5.

CAUTION:

Defensive driving really means “Be ready for anything.” On city streets, rural roads, or expressways, it means “Always expect the unexpected.” Assume that pedestrians or other drivers are going to be careless and make mistakes. Anticipate what they might do and be ready. Rear-end collisions are about the most preventable of accidents. Yet they are common. Allow enough following distance. Defensive driving requires that a driver concentrate on the driving task. Anything that distracts from the driving task makes proper defensive driving more difficult and can even cause a collision, with resulting injury. Ask a passenger to help do these things, or pull off the road in a safe place to do them. These simple defensive driving techniques could save your life.

Drunken Driving

Death and injury associated with drinking and driving is a national tragedy. It is the number one contributor to the highway death toll, claiming thousands of victims every year.

Alcohol affects four things that anyone needs to drive a vehicle:

- Judgment
- Muscular Coordination
- Vision
- Attentiveness

Police records show that almost half of all motor vehicle-related deaths involve alcohol. In most cases, these deaths are the result of someone who was drinking and driving. In recent years, more than 16,000 annual motor vehicle-related deaths have been associated with the use of alcohol, with more than 300,000 people injured.

Many adults — by some estimates, nearly half the adult population — choose never to drink alcohol, so they never drive after drinking. For persons under 21, it is against the law in every U.S. state to drink alcohol. There are good medical, psychological, and developmental reasons for these laws.

The obvious way to eliminate the leading highway safety problem is for people never to drink alcohol and then drive. But what if people do? How much is “too much” if someone plans to drive? It is a lot less than many might think. Although it depends on each person and situation, here is some general information on the problem.

The Blood Alcohol Concentration (BAC) of someone who is drinking depends upon four things:

- The amount of alcohol consumed
- The drinker’s body weight
- The amount of food that is consumed before and during drinking
- The length of time it has taken the drinker to consume the alcohol

According to the American Medical Association, a 180 lb (82 kg) person who drinks three 12 ounce (355 ml) bottles of beer in an hour will end up with a BAC of about 0.06 percent. The person would reach the same BAC by drinking three 4 ounce (120 ml) glasses of wine or three mixed drinks if each had 1-1/2 ounces (45 ml) of liquors like whiskey, gin, or vodka.

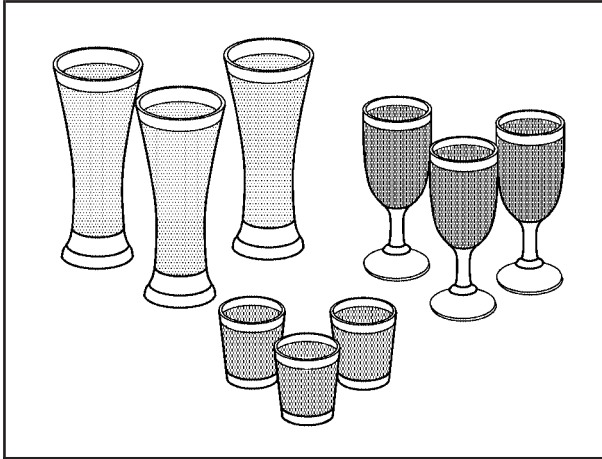

It is the amount of alcohol that counts. For example, if the same person drank three double martinis (3 ounces or 90 ml of liquor each) within an hour, the person's BAC would be close to 0.12 percent. A person who consumes food just before or during drinking will have a somewhat lower BAC level.

There is a gender difference, too. Women generally have a lower relative percentage of body water than men. Since alcohol is carried in body water, this means that a woman generally will reach a higher BAC level than a man of her same body weight will when each has the same number of drinks.

The law in most U.S. states, and throughout Canada, sets the legal limit at 0.08 percent. In some other countries, the limit is even lower. For example, it is 0.05 percent in both France and Germany. The BAC limit for all commercial drivers in the United States is 0.04 percent.

The BAC will be over 0.10 percent after three to six drinks (in one hour). Of course, as we have seen, it depends on how much alcohol is in the drinks, and how quickly the person drinks them.

But the ability to drive is affected well below a BAC of 0.10 percent. Research shows that the driving skills of many people are impaired at a BAC approaching 0.05 percent, and that the effects are worse at night. All drivers are impaired at BAC levels above 0.05 percent. Statistics show that the chance of being in a collision increases sharply for drivers who have a BAC of 0.05 percent or above. A driver with a BAC level of 0.06 percent has doubled his or her chance of having a collision. At a BAC level of 0.10 percent, the chance of this driver having a collision is 12 times greater; at a level of 0.15 percent, the chance is 25 times greater!

The body takes about an hour to rid itself of the alcohol in one drink. No amount of coffee or number of cold showers will speed that up. “I will be careful” is not the right answer. What if there is an emergency, a need to take sudden action, as when a child darts into the street? A person with even a moderate BAC might not be able to react quickly enough to avoid the collision.

There is something else about drinking and driving that many people do not know. Medical research shows that alcohol in a person’s system can make crash injuries worse, especially injuries to the brain, spinal cord, or heart. This means that when anyone who has been drinking — driver or passenger — is in a crash, that person’s chance of being killed or permanently disabled is higher than if the person had not been drinking.

 **CAUTION:**

Drinking and then driving is very dangerous. Your reflexes, perceptions, attentiveness, and judgment can be affected by even a small amount of alcohol. You can have a serious — or even fatal — collision if you drive after drinking. Please do not drink and drive or ride with a driver who has been drinking. Ride home in a cab; or if you are with a group, designate a driver who will not drink.

Control of a Vehicle

You have three systems that make your vehicle go where you want it to go. They are the brakes, the steering, and the accelerator. All three systems have to do their work at the places where the tires meet the road.

Sometimes, as when you are driving on snow or ice, it is easy to ask more of those control systems than the tires and road can provide. That means you can lose control of your vehicle. See *Traction Control System (TCS)* on page 5-9 and *StabiliTrak® System* on page 5-11.

Adding non-GM accessories can affect your vehicle's performance. See *Accessories and Modifications* on page 6-3.

Braking

See *Brake System Warning Light* on page 3-54.

Braking action involves perception time and reaction time.

First, you have to decide to push on the brake pedal. That is perception time. Then you have to bring up your foot and do it. That is reaction time.

Average reaction time is about three-fourths of a second. But that is only an average. It might be less with one driver and as long as two or three seconds or more with another. Age, physical condition, alertness, coordination, and eyesight all play a part. So do alcohol, drugs, and frustration. But even in three-fourths of a second, a vehicle moving at 60 mph (100 km/h) travels 66 feet (20 m). That could be a lot of distance in an emergency, so keeping enough space between your vehicle and others is important.

And, of course, actual stopping distances vary greatly with the surface of the road, whether it is pavement or gravel; the condition of the road, whether it is wet, dry, or icy; tire tread; the condition of your brakes; the weight of the vehicle; and the amount of brake force applied.

Avoid needless heavy braking. Some people drive in spurts — heavy acceleration followed by heavy braking — rather than keeping pace with traffic. This is a mistake. Your brakes may not have time to cool between hard stops. Your brakes will wear out much faster if you do a lot of heavy braking. If you keep pace with the traffic and allow realistic following distances, you will eliminate a lot of unnecessary braking. That means better braking and longer brake life.

If your engine ever stops while you are driving, brake normally but do not pump your brakes. If you do, the pedal may get harder to push down. If your engine stops, you will still have some power brake assist. But you will use it when you brake. Once the power assist is used up, it may take longer to stop and the brake pedal will be harder to push.

Adding non-GM accessories can affect your vehicle's performance. See *Accessories and Modifications* on page 6-3.

Anti-Lock Brake System (ABS)

Your vehicle has anti-lock brakes. ABS is an advanced electronic braking system that will help prevent a braking skid.

When you start your engine and begin to drive away, your anti-lock brake system will check itself. You may hear a momentary motor or clicking noise while this test is going on, and you may even notice that your brake pedal moves a little. This is normal.

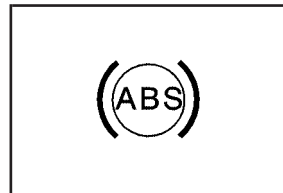

If there is a problem with the anti-lock brake system, this warning light will stay on. See *Anti-Lock Brake System Warning Light* on page 3-55.

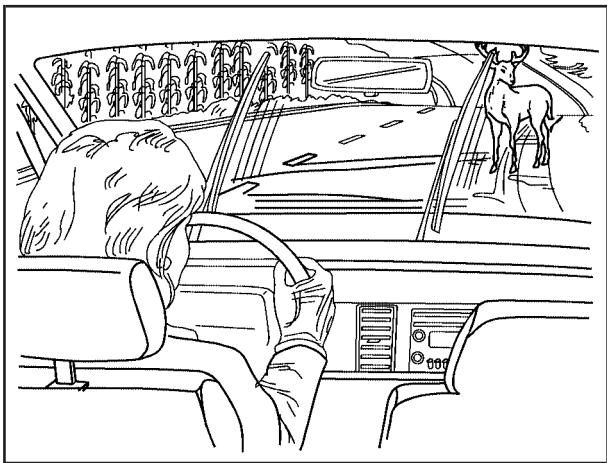

Let us say the road is wet and you are driving safely. Suddenly, an animal jumps out in front of you. You slam on the brakes and continue braking. Here is what happens with ABS:

A computer senses that wheels are slowing down. If one of the wheels is about to stop rolling, the computer will separately work the brakes at each wheel.

The anti-lock system can change the brake pressure faster than any driver could. The computer is programmed to make the most of available tire and road conditions. This can help you steer around the obstacle while braking hard.

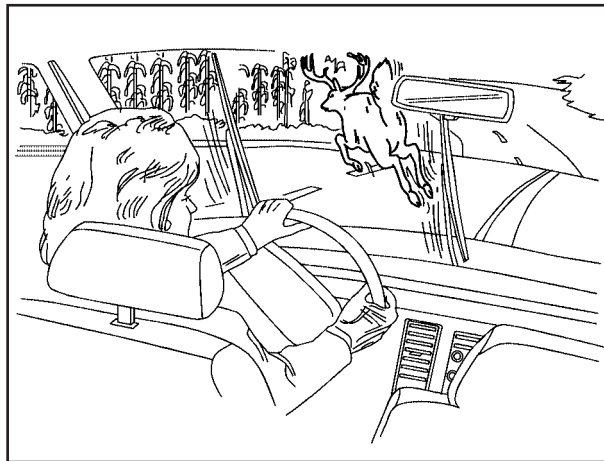

As you brake, your computer keeps receiving updates on wheel speed and controls braking pressure accordingly.

Remember: Anti-lock does not change the time you need to get your foot up to the brake pedal or always decrease stopping distance. If you get too close to the vehicle in front of you, you will not have time to apply your brakes if that vehicle suddenly slows or stops. Always leave enough room up ahead to stop, even though you have anti-lock brakes.

Using Anti-Lock

Do not pump the brakes. Just hold the brake pedal down firmly and let anti-lock work for you. You may hear a motor or clicking noise and feel the brake pedal move a little during a stop, but this is normal.

Braking in Emergencies

With anti-lock brakes, you can steer and brake at the same time. In many emergencies, steering can help you more than even the very best braking.

Traction Control System (TCS)

Your vehicle has a traction control system that limits wheel spin. This is especially useful in slippery road conditions. The system operates only if it senses that one or both of the rear wheels are spinning or beginning to lose traction. When this happens, the system works the rear brakes and reduces engine power to limit wheel spin.

The TRAC SYSTEM ACTIVE message will display on the Driver Information Center (DIC) when the traction control system is limiting wheel spin. See *DIC Warnings and Messages on page 3-67*. You may feel or hear the system working, but this is normal.

If your vehicle is in cruise control when the traction control system begins to limit wheel spin, the cruise control will automatically disengage. When road conditions allow you to safely use it again, you may reengage the cruise control. See *Adaptive Cruise Control on page 3-15*.

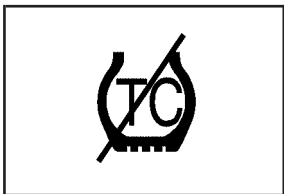

This warning light will come on to let you know if there is a problem with your traction control system.

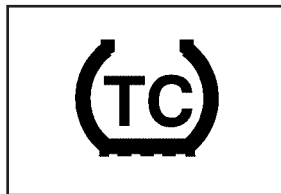

To turn the system off, press the front part of the traction control button located on the center console.

See *Traction Control System (TCS) Warning Light* on page 3-56. When this warning light is on, the system will not limit wheel spin. Adjust your driving accordingly.

The traction control system automatically comes on whenever you start your vehicle. To limit wheel spin, especially in slippery road conditions, you should always leave the system on. But you can turn the traction control system off if you ever need to. You should turn the system off if your vehicle ever gets stuck in sand, mud or snow and rocking the vehicle is required.

See *Rocking Your Vehicle to Get It Out* on page 5-32 and *If Your Vehicle is Stuck in Sand, Mud, Ice or Snow* on page 5-32 for more information.

The TRACTION SYSTEM-OFF message will display on the DIC and the traction control system warning light will come on. If the system is limiting wheel spin when you press the button, the TRACTION SYSTEM-OFF message will display – but the system will not turn off right away. It will wait until there is no longer a current need to limit wheel spin.

You can turn the system back on at any time by pressing the button again. The TRACTION SYSTEM-ON message should display briefly on the Driver Information Center.

Adding non-GM accessories can affect your vehicle's performance. See *Accessories and Modifications* on page 6-3 for more information.

Magnetic Ride Control

Magnetic Ride Control automatically adjusts the ride of your vehicle. Automatic ride control is achieved through a computer used to control and monitor the suspension system. The controller receives input from various sensors to determine the proper system response. If the controller detects a problem within the system, the DIC will display a SERVICE RIDE CONTROL message. See *DIC Warnings and Messages on page 3-67* for more information. See your dealer for service.

Limited-Slip Rear Axle

Your limited-slip rear axle can give you additional traction on snow, mud, ice, sand or gravel. It works like a standard axle most of the time, but when one of the rear wheels has no traction and the other does, this feature will allow the wheel with traction to move the vehicle.

StabiliTrak[®] System

The StabiliTrak[®] System is a computer controlled system that helps the driver maintain directional control of the vehicle in difficult driving conditions. This is accomplished by selectively applying any one of the vehicle's brakes.

When you first start your vehicle and begin to drive away (6 mph (10 km/h)), especially during cold weather, the message STABILITRAK WARMING may be displayed in the Driver Information Center (DIC), the instrument cluster light will be on, and a chime will sound. This is normal. You can acknowledge this message by pressing the RESET button. The StabiliTrak[®] System performance is affected until the message, STABILITRAK READY, is displayed in the DIC. This can take up to 15 minutes.

The WAIT FOR STABILITRAK message may be displayed in the DIC after exceeding 19 mph (30 km/h) for 10 seconds if the steering is not centered. The system is off until the STABILITRAK ACTIVE message is displayed.

The STABILITRAK ACTIVE message will come on when the system is operating. See *DIC Warnings and Messages on page 3-67* for more information. You may also feel or hear the system working. This is normal.

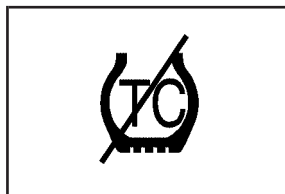

The instrument cluster light will come on and a chime will sound to let you know if there is a problem with the system.

The SERVICE STABILITRAK message will also be displayed. See *DIC Warnings and Messages on page 3-67* for more information.

When this light and the SERVICE STABILITRAK message are on, the system is not operational. Adjust your driving accordingly.

The system comes on automatically whenever you start your vehicle. To help maintain directional control of the vehicle, you should always leave the system on. You can turn the system off if you ever need to. If you turn the STABILITRAK[®] System off, the Traction Control System will also be turned off. Adjust your driving accordingly.

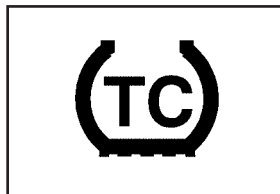

To turn the system off, press and hold the front part of the traction control button on the console for five seconds with the vehicle stopped.

You can turn the system back on at any time by pressing the button. The DIC will display the appropriate message when you push the button, either TRAC/STABILITRAK ON or TRAC/STABILITRAK OFF.

Steering

Power Steering

If you lose power steering assist because the engine stops or the system is not functioning, you can steer but it will take much more effort.

Magnetic Speed Variable Assist Steering

Your vehicle is equipped with a steering system that continuously adjusts the effort you feel when steering at all vehicle speeds. It provides ease when parking, yet a firm, solid feel at highway speeds.

Steering Tips

It is important to take curves at a reasonable speed.

A lot of the “driver lost control” accidents mentioned on the news happen on curves. Here is why:

Experienced driver or beginner, each of us is subject to the same laws of physics when driving on curves.

The traction of the tires against the road surface makes it possible for the vehicle to change its path when you turn the front wheels. If there is no traction, inertia will keep the vehicle going in the same direction. If you have ever tried to steer a vehicle on wet ice, you will understand this.

The traction you can get in a curve depends on the condition of your tires and the road surface, the angle at which the curve is banked, and your speed. While you are in a curve, speed is the one factor you can control.

Suppose you are steering through a sharp curve. Then you suddenly accelerate. Both control systems — steering and acceleration — have to do their work where the tires meet the road. Adding the sudden acceleration can demand too much of those places. You can lose control. See *Traction Control System (TCS)* on page 5-9.

What should you do if this ever happens? Ease up on the accelerator pedal, steer the vehicle the way you want it to go, and slow down.

Speed limit signs near curves warn that you should adjust your speed. Of course, the posted speeds are based on good weather and road conditions. Under less favorable conditions you will want to go slower.

If you need to reduce your speed as you approach a curve, do it before you enter the curve, while your front wheels are straight ahead.

Try to adjust your speed so you can “drive” through the curve. Maintain a reasonable, steady speed. Wait to accelerate until you are out of the curve, and then accelerate gently into the straightaway.

Adding non-GM accessories can affect your vehicle’s performance. See *Accessories and Modifications on page 6-3*.

Steering in Emergencies

There are times when steering can be more effective than braking. For example, you come over a hill and find a truck stopped in your lane, or a car suddenly pulls out from nowhere, or a child darts out from between parked cars and stops right in front of you. You can avoid these problems by braking — if you can stop in time. But sometimes you cannot; there is not room. That is the time for evasive action — steering around the problem.

Your vehicle can perform very well in emergencies like these. First apply your brakes.

See *Braking on page 5-6*. It is better to remove as much speed as you can from a possible collision. Then steer around the problem, to the left or right depending on the space available.

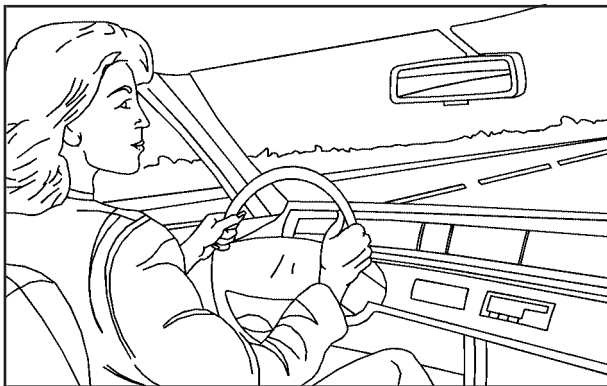

An emergency like this requires close attention and a quick decision. If you are holding the steering wheel at the recommended 9 and 3 o'clock positions, you can turn it a full 180 degrees very quickly without removing either hand. But you have to act fast, steer quickly, and just as quickly straighten the wheel once you have avoided the object.

The fact that such emergency situations are always possible is a good reason to practice defensive driving at all times and wear safety belts properly.

Off-Road Recovery

You may find that your right wheels have dropped off the edge of a road onto the shoulder while you are driving.

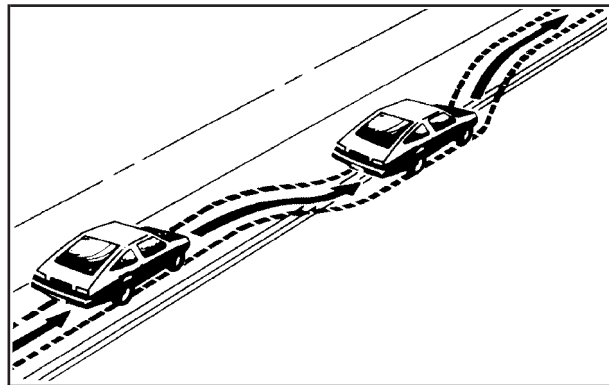

If the level of the shoulder is only slightly below the pavement, recovery should be fairly easy. Ease off the accelerator and then, if there is nothing in the way, steer so that your vehicle straddles the edge of the pavement. You can turn the steering wheel up to one-quarter turn until the right front tire contacts the pavement edge. Then turn your steering wheel to go straight down the roadway.

Passing

The driver of a vehicle about to pass another on a two-lane highway waits for just the right moment, accelerates, moves around the vehicle ahead, then goes back into the right lane again. A simple maneuver?

Not necessarily! Passing another vehicle on a two-lane highway is a potentially dangerous move, since the passing vehicle occupies the same lane as oncoming traffic for several seconds. A miscalculation, an error in judgment, or a brief surrender to frustration or anger can suddenly put the passing driver face to face with the worst of all traffic accidents — the head-on collision.

So here are some tips for passing:

- Drive ahead. Look down the road, to the sides and to crossroads for situations that might affect your passing patterns. If you have any doubt whatsoever about making a successful pass, wait for a better time.
 - Watch for traffic signs, pavement markings and lines. If you can see a sign up ahead that might indicate a turn or an intersection, delay your pass. A broken center line usually indicates it is all right to pass, providing the road ahead is clear. Never cross a solid line on your side of the lane or a double solid line, even if the road seems empty of approaching traffic.
- Do not get too close to the vehicle you want to pass while you are awaiting an opportunity. For one thing, following too closely reduces your area of vision, especially if you are following a larger vehicle. Also, you will not have adequate space if the vehicle ahead suddenly slows or stops. Keep back a reasonable distance.
 - When it looks like a chance to pass is coming up, start to accelerate but stay in the right lane and do not get too close. Time your move so you will be increasing speed as the time comes to move into the other lane. If the way is clear to pass, you will have a running start that more than makes up for the distance you would lose by dropping back. And if something happens to cause you to cancel your pass, you need only slow down and drop back again and wait for another opportunity.
 - If other vehicles are lined up to pass a slow vehicle, wait your turn. But take care that someone is not trying to pass you as you pull out to pass the slow vehicle. Remember to glance over your shoulder and check the blind spot.

- Check your mirrors, glance over your shoulder, and start your left lane change signal before moving out of the right lane to pass. When you are far enough ahead of the passed vehicle to see its front in your inside mirror, activate your right lane change signal and move back into the right lane. Remember that your passenger side outside mirror is convex. The vehicle you just passed may seem to be farther away from you than it really is.
- Try not to pass more than one vehicle at a time on two-lane roads. Reconsider before passing the next vehicle.
- Do not overtake a slowly moving vehicle too rapidly. Even though the brake lamps are not flashing, it may be slowing down or starting to turn.
- If you are being passed, make it easy for the following driver to get ahead of you. Perhaps you can ease a little to the right.

Loss of Control

Let us review what driving experts say about what happens when the three control systems — brakes, steering, and acceleration — do not have enough friction where the tires meet the road to do what the driver has asked.

In any emergency, do not give up. Keep trying to steer and constantly seek an escape route or area of less danger.

Skidding

In a skid, a driver can lose control of the vehicle. Defensive drivers avoid most skids by taking reasonable care suited to existing conditions, and by not overdriving those conditions. But skids are always possible.

The three types of skids correspond to your vehicle's three control systems. In the braking skid, your wheels are not rolling. In the steering or cornering skid, too much speed or steering in a curve causes tires to slip and lose cornering force. And in the acceleration skid, too much throttle causes the driving wheels to spin.

A cornering skid is best handled by easing your foot off the accelerator pedal.

Remember: Any traction control system helps avoid only the acceleration skid. If your traction control system is off, then an acceleration skid is also best handled by easing your foot off the accelerator pedal.

If your vehicle starts to slide, ease your foot off the accelerator pedal and quickly steer the way you want the vehicle to go. If you start steering quickly enough, your vehicle may straighten out. Always be ready for a second skid if it occurs.

Of course, traction is reduced when water, snow, ice, gravel, or other material is on the road. For safety, you will want to slow down and adjust your driving to these conditions. It is important to slow down on slippery surfaces because stopping distance will be longer and vehicle control more limited.

While driving on a surface with reduced traction, try your best to avoid sudden steering, acceleration, or braking, including engine braking by shifting to a lower gear. Any sudden changes could cause the tires to slide. You may not realize the surface is slippery until your vehicle is skidding. Learn to recognize warning clues — such as enough water, ice, or packed snow on the road to make a mirrored surface — and slow down when you have any doubt.

Remember: Any Anti-Lock Brake System (ABS) helps avoid only the braking skid.

Driving at Night

Night driving is more dangerous than day driving. One reason is that some drivers are likely to be impaired — by alcohol or drugs, with night vision problems, or by fatigue.

Here are some tips on night driving.

- Drive defensively.
- Do not drink and drive.
- Adjust the inside rearview mirror to reduce the glare from headlamps behind you.
- Since you cannot see as well, you may need to slow down and keep more space between you and other vehicles.
- Slow down, especially on higher speed roads. Your vehicle's headlamps can light up only so much road ahead.
- In remote areas, watch for animals.
- If you are tired, pull off the road in a safe place and rest.

No one can see as well at night as in the daytime. But as we get older these differences increase. A 50-year-old driver may require at least twice as much light to see the same thing at night as a 20-year-old.

What you do in the daytime can also affect your night vision. For example, if you spend the day in bright sunshine you are wise to wear sunglasses. Your eyes will have less trouble adjusting to night. But if you are driving, do not wear sunglasses at night. They may cut down on glare from headlamps, but they also make a lot of things invisible.

You can be temporarily blinded by approaching headlamps. It can take a second or two, or even several seconds, for your eyes to re-adjust to the dark. When you are faced with severe glare, as from a driver who does not lower the high beams, or a vehicle with misaimed headlamps, slow down a little. Avoid staring directly into the approaching headlamps.

Keep the windshield and all the glass on your vehicle clean — inside and out. Glare at night is made much worse by dirt on the glass. Even the inside of the glass can build up a film caused by dust. Dirty glass makes lights dazzle and flash more than clean glass would, making the pupils of your eyes contract repeatedly.

Remember that the headlamps light up far less of a roadway when you are in a turn or curve. Keep your eyes moving; that way, it is easier to pick out dimly lighted objects. Just as the headlamps should be checked regularly for proper aim, so should your eyes be examined regularly. Some drivers suffer from night blindness — the inability to see in dim light — and are not even aware of it.

Driving in Rain and on Wet Roads

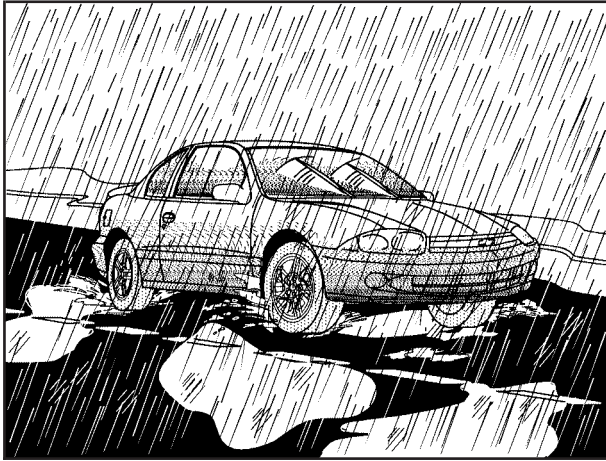

Rain and wet roads can mean driving trouble. On a wet road, you cannot stop, accelerate, or turn as well because your tire-to-road traction is not as good as on dry roads. And, if your tires do not have much tread left, you will get even less traction. It is always wise to go slower and be cautious if rain starts to fall while you are driving. The surface may get wet suddenly when your reflexes are tuned for driving on dry pavement.

The heavier the rain, the harder it is to see. Even if your windshield wiper blades are in good shape, a heavy rain can make it harder to see road signs and traffic signals, pavement markings, the edge of the road, and even people walking.

It is wise to keep your windshield wiping equipment in good shape and keep your windshield washer fluid reservoir filled with washer fluid. Replace your windshield wiper inserts when they show signs of streaking or missing areas on the windshield, or when strips of rubber start to separate from the inserts.

 **CAUTION:**

Wet brakes can cause accidents. They will not work as well in a quick stop and may cause pulling to one side. You could lose control of the vehicle.

After driving through a large puddle of water or a car wash, apply your brake pedal lightly until your brakes work normally.

Driving too fast through large water puddles or even going through some car washes can cause problems, too. The water may affect your brakes. Try to avoid puddles. But if you cannot, try to slow down before you hit them.

Hydroplaning

Hydroplaning is dangerous. So much water can build up under your tires that they can actually ride on the water. This can happen if the road is wet enough and you are going fast enough. When your vehicle is hydroplaning, it has little or no contact with the road.

Hydroplaning does not happen often. But it can if your tires do not have much tread or if the pressure in one or more is low. It can happen if a lot of water is standing on the road. If you can see reflections from trees, telephone poles, or other vehicles, and raindrops dimple the water's surface, there could be hydroplaning.

Hydroplaning usually happens at higher speeds. There just is not a hard and fast rule about hydroplaning. The best advice is to slow down when it is raining.

Driving Through Deep Standing Water

Notice: If you drive too quickly through deep puddles or standing water, water can come in through your engine's air intake and badly damage your engine. Never drive through water that is slightly lower than the underbody of your vehicle. If you cannot avoid deep puddles or standing water, drive through them very slowly.

Driving Through Flowing Water

CAUTION:

Flowing or rushing water creates strong forces. If you try to drive through flowing water, as you might at a low water crossing, your vehicle can be carried away. As little as six inches of flowing water can carry away a smaller vehicle. If this happens, you and other vehicle occupants could drown. Do not ignore police warning signs, and otherwise be very cautious about trying to drive through flowing water.

Some Other Rainy Weather Tips

- Besides slowing down, allow some extra following distance. And be especially careful when you pass another vehicle. Allow yourself more clear room ahead, and be prepared to have your view restricted by road spray.
- Have good tires with proper tread depth. See *Tires* on page 6-47.

City Driving

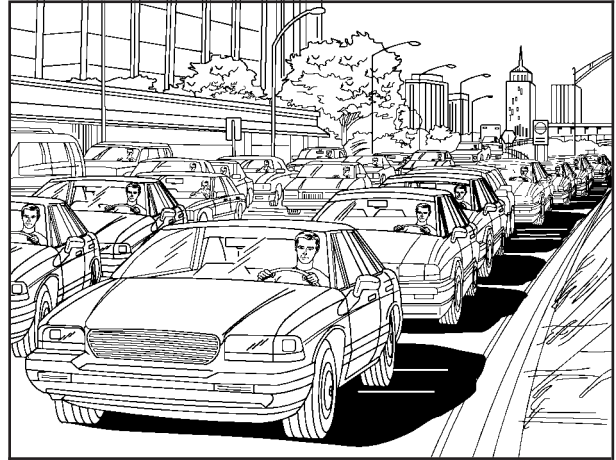

One of the biggest problems with city streets is the amount of traffic on them. You will want to watch out for what the other drivers are doing and pay attention to traffic signals.

Here are ways to increase your safety in city driving:

- Know the best way to get to where you are going. Get a city map and plan your trip into an unknown part of the city just as you would for a cross-country trip.
- Try to use the freeways that rim and crisscross most large cities. You will save time and energy. See *Freeway Driving* on page 5-23.
- Treat a green light as a warning signal. A traffic light is there because the corner is busy enough to need it. When a light turns green, and just before you start to move, check both ways for vehicles that have not cleared the intersection or may be running the red light.

Freeway Driving



Mile for mile, freeways — also called thruways, parkways, expressways, turnpikes, or superhighways — are the safest of all roads. But they have their own special rules.

The most important advice on freeway driving is: Keep up with traffic and keep to the right. Drive at the same speed most of the other drivers are driving. Too-fast or too-slow driving breaks a smooth traffic flow. Treat the left lane on a freeway as a passing lane.

At the entrance, there is usually a ramp that leads to the freeway. If you have a clear view of the freeway as you drive along the entrance ramp, you should begin to check traffic. Try to determine where you expect to blend with the flow. Try to merge into the gap at close to the prevailing speed. Switch on your turn signal, check your mirrors, and glance over your shoulder as often as necessary. Try to blend smoothly with the traffic flow.

Once you are on the freeway, adjust your speed to the posted limit or to the prevailing rate if it is slower. Stay in the right lane unless you want to pass.

Before changing lanes, check your mirrors. Then use your turn signal.

Just before you leave the lane, glance quickly over your shoulder to make sure there is not another vehicle in your blind spot.

Once you are moving on the freeway, make certain you allow a reasonable following distance.

Expect to move slightly slower at night.

When you want to leave the freeway, move to the proper lane well in advance. If you miss your exit, do not, under any circumstances, stop and back up. Drive on to the next exit.

The exit ramp can be curved, sometimes quite sharply. The exit speed is usually posted. Reduce your speed according to your speedometer, not to your sense of motion. After driving for any distance at higher speeds, you may tend to think you are going slower than you actually are.

Before Leaving on a Long Trip

Make sure you are ready. Try to be well rested. If you must start when you are not fresh — such as after a day's work — do not plan to make too many miles that first part of the journey. Wear comfortable clothing and shoes you can easily drive in.

Is your vehicle ready for a long trip? If you keep it serviced and maintained, it is ready to go. If it needs service, have it done before starting out. Of course, you will find experienced and able service experts in GM dealerships all across North America. They will be ready and willing to help if you need it.

Here are some things you can check before a trip:

- *Windshield Washer Fluid:* Is the reservoir full? Are all windows clean inside and outside?
- *Wiper Blades:* Are they in good shape?
- *Fuel, Engine Oil, Other Fluids:* Have you checked all levels?
- *Lamps:* Are they all working? Are the lenses clean?
- *Tires:* They are vitally important to a safe, trouble-free trip. Is the tread good enough for long-distance driving? Are the tires all inflated to the recommended pressure?
- *Weather Forecasts:* What is the weather outlook along your route? Should you delay your trip a short time to avoid a major storm system?
- *Maps:* Do you have up-to-date maps?

Highway Hypnosis

Is there actually such a condition as highway hypnosis? Or is it just plain falling asleep at the wheel? Call it highway hypnosis, lack of awareness, or whatever.

There is something about an easy stretch of road with the same scenery, along with the hum of the tires on the road, the drone of the engine, and the rush of the wind against the vehicle that can make you sleepy. Do not let it happen to you! If it does, your vehicle can leave the road in less than a second, and you could crash and be injured.

What can you do about highway hypnosis? First, be aware that it can happen.

Then here are some tips:

- Make sure your vehicle is well ventilated, with a comfortably cool interior.
- Keep your eyes moving. Scan the road ahead and to the sides. Check your rearview mirrors and your instruments frequently.
- If you get sleepy, pull off the road into a rest, service, or parking area and take a nap, get some exercise, or both. For safety, treat drowsiness on the highway as an emergency.

Hill and Mountain Roads



Driving on steep hills or mountains is different from driving in flat or rolling terrain.

If you drive regularly in steep country, or if you are planning to visit there, here are some tips that can make your trips safer and more enjoyable.

- Keep your vehicle in good shape. Check all fluid levels and also the brakes, tires, cooling system, and transmission. These parts can work hard on mountain roads.

CAUTION:

If you do not shift down, your brakes could get so hot that they would not work well. You would then have poor braking or even none going down a hill. You could crash. Shift down to let your engine assist your brakes on a steep downhill slope.

CAUTION:

Coasting downhill in **NEUTRAL (N)** or with the ignition off is dangerous. Your brakes will have to do all the work of slowing down. They could get so hot that they would not work well. You would then have poor braking or even none going down a hill. You could crash. Always have your engine running and your vehicle in gear when you go downhill.

- Know how to go down hills. The most important thing to know is this: let your engine do some of the slowing down. Shift to a lower gear when you go down a steep or long hill.
- Know how to go uphill. You may want to shift down to a lower gear. The lower gears help cool your engine and transmission, and you can climb the hill better.
- Stay in your own lane when driving on two-lane roads in hills or mountains. Do not swing wide or cut across the center of the road. Drive at speeds that let you stay in your own lane.
- As you go over the top of a hill, be alert. There could be something in your lane, like a stalled car or an accident.
- You may see highway signs on mountains that warn of special problems. Examples are long grades, passing or no-passing zones, a falling rocks area, or winding roads. Be alert to these and take appropriate action.

Winter Driving



Here are some tips for winter driving:

- Have your vehicle in good shape for winter.
- You may want to put winter emergency supplies in your vehicle.

Also see *Tires* on page 6-47.



Include an ice scraper, a small brush or broom, a supply of windshield washer fluid, a rag, some winter outer clothing, a small shovel, a flashlight, a red cloth, and a couple of reflective warning triangles. And, if you will be driving under severe conditions, include a small bag of sand, a piece of old carpet, or a couple of burlap bags to help provide traction. Be sure you properly secure these items in your vehicle.

Driving On Snow or Ice

Most of the time, those places where the tires meet the road probably have good traction.

However, if there is snow or ice between the tires and the road, you can have a very slippery situation. You will have a lot less traction, or grip, and will need to be very careful.

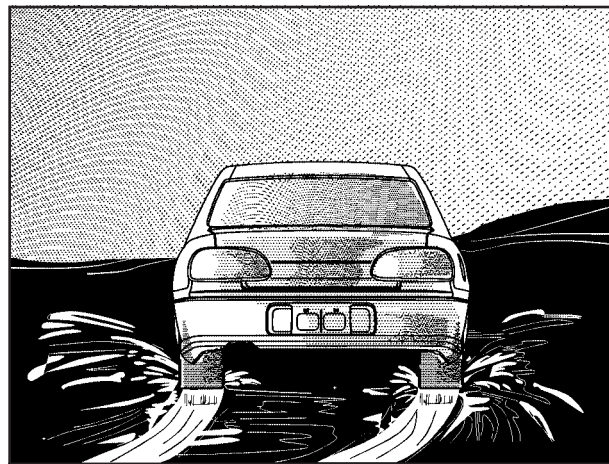

What is the worst time for this? Wet ice. Very cold snow or ice can be slick and hard to drive on. But wet ice can be even more trouble because it may offer the least traction of all. You can get wet ice when it is about freezing, 32°F (0°C), and freezing rain begins to fall. Try to avoid driving on wet ice until salt and sand crews can get there.

Whatever the condition — smooth ice, packed, blowing, or loose snow — drive with caution.

Traction control improves your ability to accelerate when driving on a slippery road. Even though your vehicle has the Traction Control System (TCS), you will want to slow down and adjust your driving to the road conditions. Under certain conditions, you may want to turn the TCS off, such as when driving through deep snow and loose gravel, to help maintain vehicle motion at lower speeds. See *Traction Control System (TCS)* on page 5-9. The StabiliTrak® System may also activate. See *StabiliTrak® System* on page 5-11.

Your Anti-Lock Brake System (ABS) improves your vehicle's stability when you make a hard stop on a slippery road. Even though you have ABS, you will want to begin stopping sooner than you would on dry pavement. See *Anti-Lock Brake System (ABS)* on page 5-7.

- Allow greater following distance on any slippery road.
- Watch for slippery spots. The road might be fine until you hit a spot that is covered with ice. On an otherwise clear road, ice patches may appear in shaded areas where the sun cannot reach, such as around clumps of trees, behind buildings, or under bridges. Sometimes the surface of a curve or an overpass may remain icy when the surrounding roads are clear. If you see a patch of ice ahead of you, brake before you are on it. Try not to brake while you are actually on the ice, and avoid sudden steering maneuvers.

If You Are Caught in a Blizzard

If you are stopped by heavy snow, you could be in a serious situation. You should probably stay with your vehicle unless you know for sure that you are near help and you can hike through the snow. Here are some things to do to summon help and keep yourself and your passengers safe:

- Turn on your hazard flashers.
- Tie a red cloth to your vehicle to alert police that you have been stopped by the snow.
- Put on extra clothing or wrap a blanket around you. If you do not have blankets or extra clothing, make body insulators from newspapers, burlap bags, rags, floor mats — anything you can wrap around yourself or tuck under your clothing to keep warm.

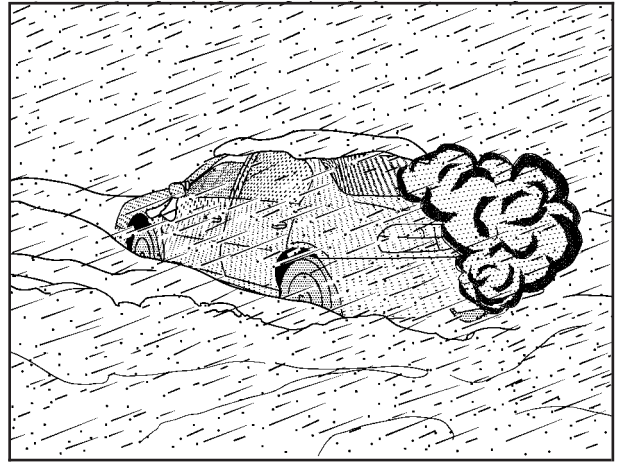

You can run the engine to keep warm, but be careful.

 **CAUTION:**

Snow can trap exhaust gases under your vehicle. This can cause deadly CO (carbon monoxide) gas to get inside. CO could overcome you and kill you. You cannot see it or smell it, so you might not know it is in your vehicle. Clear away snow from around the base of your vehicle, especially any that is blocking your exhaust pipe. And check around again from time to time to be sure snow does not collect there.

Open a window just a little on the side of the vehicle that is away from the wind. This will help keep CO out.

Run your engine only as long as you must. This saves fuel. When you run the engine, make it go a little faster than just idle. That is, push the accelerator slightly. This uses less fuel for the heat that you get and it keeps the battery charged. You will need a well-charged battery to restart the vehicle, and possibly for signaling later on with your headlamps. Let the heater run for a while.

Then, shut the engine off and close the window almost all the way to preserve the heat. Start the engine again and repeat this only when you feel really uncomfortable from the cold. But do it as little as possible. Preserve the fuel as long as you can. To help keep warm, you can get out of the vehicle and do some fairly vigorous exercises every half hour or so until help comes.

If Your Vehicle is Stuck in Sand, Mud, Ice or Snow

In order to free your vehicle when it is stuck, you will need to spin the wheels, but you do not want to spin your wheels too fast. The method known as rocking can help you get out when you are stuck, but you must use caution.

CAUTION:

If you let your tires spin at high speed, they can explode, and you or others could be injured. And, the transmission or other parts of the vehicle can overheat. That could cause an engine compartment fire or other damage. When you are stuck, spin the wheels as little as possible. Do not spin the wheels above 35 mph (55 km/h) as shown on the speedometer.

Notice: Spinning your wheels can destroy parts of your vehicle as well as the tires. If you spin the wheels too fast while shifting your transmission back and forth, you can destroy your transmission.

For more information about using tire chains on your vehicle, see *Tire Chains* on page 6-64.

Rocking Your Vehicle to Get It Out

First, turn your steering wheel left and right. That will clear the area around your front wheels. You should turn your traction control system off. See *Traction Control System (TCS)* on page 5-9. Then shift back and forth between REVERSE (R) and a forward gear, spinning the wheels as little as possible. Release the accelerator pedal while you shift, and press lightly on the accelerator pedal when the transmission is in gear. By slowly spinning your wheels in the forward and reverse directions, you will cause a rocking motion that may free your vehicle. If that does not get you out after a few tries, you may need to be towed out. If you do need to be towed out, see *Towing Your Vehicle* on page 5-37.

Loading Your Vehicle

It is very important to know how much weight your vehicle can carry. This weight is called the vehicle capacity weight and includes the weight of all occupants, cargo, and all nonfactory-installed options. Two labels on your vehicle show how much weight it may properly carry, the Tire and Loading Information label and the Certification label.

CAUTION:

Do not load your vehicle any heavier than the Gross Vehicle Weight Rating (GVWR), or either the maximum front or rear Gross Axle Weight Rating (GAWR). If you do, parts on your vehicle can break, and it can change the way your vehicle handles. These could cause you to lose control and crash. Also, overloading can shorten the life of your vehicle.

Tire and Loading Information Label

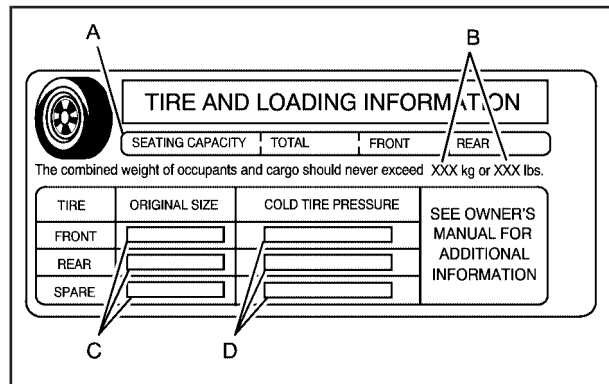

Label Example

A vehicle specific Tire and Loading Information label is attached to the center pillar (B-pillar) of your vehicle. With the driver's door open, you will find the label attached below the door latch. This label shows the number of occupant seating positions (A), and the maximum vehicle capacity weight (B) in kilograms and pounds.

The Tire and Loading Information label also shows the size of the original equipment tires (C) and the recommended cold tire inflation pressures (D). For more information on tires and inflation see *Tires on page 6-47* and *Inflation - Tire Pressure on page 6-54*.

There is also important loading information on the vehicle Certification label. It tells you the Gross Vehicle Weight Rating (GVWR) and the Gross Axle Weight Rating (GAWR) for the front and rear axle. See “Certification Label” later in this section.

Steps for Determining Correct Load Limit

1. Locate the statement “The combined weight of occupants and cargo should never exceed XXX kg or XXX lbs” on your vehicle’s placard.
2. Determine the combined weight of the driver and passengers that will be riding in your vehicle.
3. Subtract the combined weight of the driver and passengers from XXX kg or XXX lbs.
4. The resulting figure equals the available amount of cargo and luggage load capacity. For example, if the “XXX” amount equals 1400 lbs and there will be five 150 lb passengers in your vehicle, the amount of available cargo and luggage load capacity is 650 lbs (1400 – 750 (5 x 150) = 650 lbs).
5. Determine the combined weight of luggage and cargo being loaded on the vehicle. That weight may not safely exceed the available cargo and luggage load capacity calculated in Step 4.

6. If your vehicle will be towing a trailer, the load from your trailer will be transferred to your vehicle. Consult this manual to determine how this reduces the available cargo and luggage load capacity of your vehicle.

Your vehicle is neither designed nor intended to tow a trailer.

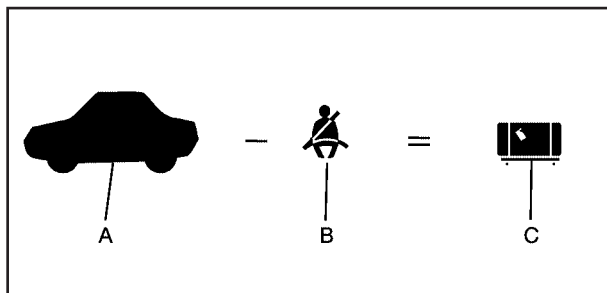

Example 1

Item	Description	Total
A	Vehicle Capacity Weight for Example 1 =	400 lbs (181 kg)
B	Subtract Occupant Weight @ 150 lbs (68 kg) x 1 =	150 lbs (68 kg)
C	Available Occupant and Cargo Weight =	250 lbs (113 kg)

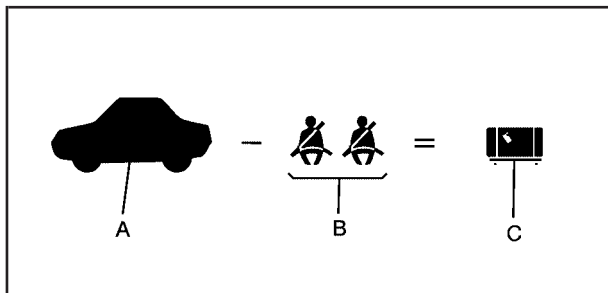

Example 2

Item	Description	Total
A	Vehicle Capacity Weight for Example 2 =	400 lbs (181 kg)
B	Subtract Occupant Weight @ 150 lbs (68 kg) x 2 =	300 lbs (136 kg)
C	Available Cargo Weight =	100 lbs (45 kg)

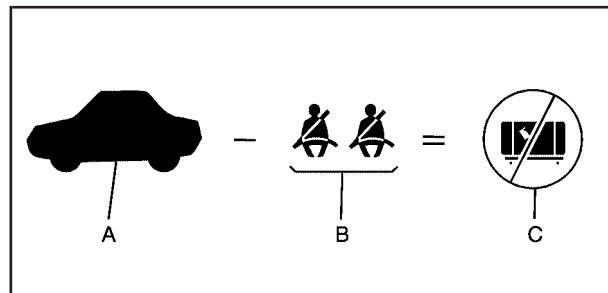

Example 3

Item	Description	Total
A	Vehicle Capacity Weight for Example 3 =	400 lbs (181 kg)
B	Subtract Occupant Weight @ 200 lbs (91 kg) x 2 =	400 lbs (181 kg)
C	Available Cargo Weight =	0 lbs (0 kg)

Refer to your vehicle's tire and loading information label for specific information about your vehicle's capacity weight and seating positions. The combined weight of the driver, passengers, and cargo should never exceed your vehicle's capacity weight.

Certification Label

MFD BY GENERAL MOTORS CORP

DATE	GVWR	GAWR FRT	GAWR RR
<input type="text"/>	<input type="text"/>	<input type="text"/>	<input type="text"/>

THIS VEHICLE CONFORMS TO ALL APPLICABLE U.S. FEDERAL MOTOR VEHICLE SAFETY, BUMPER, AND THEFT PREVENTION STANDARDS IN EFFECT ON THE DATE OF MANUFACTURE SHOWN ABOVE.

200 TYPE PASS CAR

A vehicle specific Certification label is attached to the rear edge of the driver's door. It tells you the gross weight capacity of your vehicle, called the Gross Vehicle Weight Rating (GVWR). The GVWR includes the weight of the vehicle, all occupants, fuel, and cargo. Never exceed the GVWR for your vehicle, or the Gross Axle Weight Rating (GAWR) for either the front or rear axle.

And, if you do have a heavy load, you should spread it out. Do not carry more than 61 lbs (28 kg) in the rear area of your vehicle.

CAUTION:

Do not load your vehicle any heavier than the Gross Vehicle Weight Rating (GVWR), or either the maximum front or rear Gross Axle Weight Rating (GAWR). If you do, parts on your vehicle can break, and it can change the way your vehicle handles. These could cause you to lose control and crash. Also, overloading can shorten the life of your vehicle.

Notice: Overloading your vehicle may cause damage. Repairs would not be covered by your warranty. Do not overload your vehicle.

If you put things inside your vehicle — like suitcases, tools, packages, or anything else — they will go as fast as the vehicle goes. If you have to stop or turn quickly, or if there is a crash, they will keep going.



CAUTION:

Things you put inside your vehicle can strike and injure people in a sudden stop or turn, or in a crash.

- **Put things in the rear area of your vehicle. Try to spread the weight evenly.**
- **Never stack heavier things, like suitcases, inside the vehicle so that some of them are above the tops of the seats.**
- **Do not leave an unsecured child restraint in your vehicle.**
- **When you carry something inside the vehicle, secure it whenever you can.**

Towing

Towing Your Vehicle

Consult your dealer or a professional towing service if you need to have your disabled vehicle towed. See *Roadside Service* on page 8-6.

Recreational Vehicle Towing

Recreational vehicle towing means towing your vehicle behind another vehicle — such as behind a motorhome. The two most common types of recreational vehicle towing are known as “dinghy towing” (towing your vehicle with all four wheels on the ground) and “dolly towing” (towing your vehicle with two wheels on the ground and two wheels up on a device known as a “dolly”).

Your vehicle was not designed to be towed with any of its wheels on the ground. If your vehicle must be towed, see “Towing Your Vehicle” earlier in this section.

Towing a Trailer

Your XLR is neither designed nor intended to tow a trailer.

Section 6 Service and Appearance Care

Service	6-3	Overheated Engine Protection	
Accessories and Modifications	6-3	Operating Mode	6-25
California Proposition 65 Warning	6-3	Cooling System	6-26
Doing Your Own Service Work	6-4	Power Steering Fluid	6-31
Adding Equipment to the Outside		Windshield Washer Fluid	6-32
of Your Vehicle	6-4	Brakes	6-33
Fuel	6-5	Battery	6-36
Gasoline Octane	6-5	Jump Starting	6-37
Gasoline Specifications	6-5	Rear Axle	6-42
California Fuel	6-5	Headlamp Aiming	6-43
Additives	6-6	Headlamp Vertical Aiming	6-44
Fuels in Foreign Countries	6-6	Bulb Replacement	6-45
Filling the Tank	6-7	Windshield Replacement	6-46
Filling a Portable Fuel Container	6-10	Windshield Wiper Blade Replacement	6-46
Checking Things Under the Hood	6-10	Tires	6-47
Hood Release	6-11	Tire Sidewall Labeling	6-48
Engine Compartment Overview	6-12	Tire Terminology and Definitions	6-50
Engine Oil	6-13	Run-Flat Tires	6-52
Engine Oil Life System	6-16	Inflation - Tire Pressure	6-54
Engine Air Cleaner/Filter	6-18	Tire Pressure Monitor System	6-55
Automatic Transmission Fluid	6-19	Tire Inspection and Rotation	6-57
Engine Coolant	6-20	When It Is Time for New Tires	6-58
Coolant Surge Tank Pressure Cap	6-23		
Engine Overheating	6-23		

Section 6 Service and Appearance Care

Buying New Tires	6-58	Finish Care	6-75
Different Size Tires and Wheels	6-60	Windshield and Wiper Blades	6-75
Uniform Tire Quality Grading	6-60	Aluminum or Chrome-Plated Wheels	6-76
Wheel Alignment and Tire Balance	6-62	Tires	6-77
Wheel Replacement	6-62	Sheet Metal Damage	6-77
Tire Chains	6-64	Finish Damage	6-77
Lifting Your Vehicle	6-65	Underbody Maintenance	6-77
If a Tire Goes Flat	6-69	Chemical Paint Spotting	6-77
Appearance Care	6-71	Vehicle Care/Appearance Materials	6-78
Cleaning the Inside of Your Vehicle	6-71	Vehicle Identification	6-79
Fabric/Carpet	6-72	Vehicle Identification Number (VIN)	6-79
Leather	6-73	Service Parts Identification Label	6-79
Instrument Panel, Vinyl, and Other Plastic Surfaces	6-73	Electrical System	6-80
Wood Panels	6-73	Add-On Electrical Equipment	6-80
Speaker Covers	6-74	Windshield Wiper Fuses	6-80
Care of Safety Belts	6-74	Power Windows and Other Power Options	6-80
Weatherstrips	6-74	Fuses and Circuit Breakers	6-80
Washing Your Vehicle	6-74	Instrument Panel Fuse Block	6-81
Cleaning Exterior Lamps/Lenses	6-75	Underhood Fuse Block	6-83
		Capacities and Specifications	6-86

Service

Your dealer knows your vehicle best and wants you to be happy with it. We hope you will go to your dealer for all your service needs. You will get genuine GM parts and GM-trained and supported service people.

We hope you will want to keep your GM vehicle all GM. Genuine GM parts have one of these marks:

ACDelco

GM Parts

GM
Goodwrench

GM Accessories

Accessories and Modifications

When you add non-GM accessories to your vehicle they can affect your vehicle's performance and safety, including such things as, braking, stability, ride and handling, emissions systems, aerodynamics, durability, and electronic systems like antilock brakes, traction control and stability control. Some of these accessories may even cause malfunction or damage not covered by warranty.

GM Accessories are designed to complement and function with other systems on your vehicle. Your GM dealer can accessorize your vehicle using genuine GM Accessories. When you go to your GM dealer and ask for GM Accessories, you will know that GM-trained and supported service technicians will perform the work using genuine GM Accessories.

California Proposition 65 Warning

Most motor vehicles, including this one, contain and/or emit chemicals known to the State of California to cause cancer and birth defects or other reproductive harm. Engine exhaust, many parts and systems (including some inside the vehicle), many fluids, and some component wear by-products contain and/or emit these chemicals.

Doing Your Own Service Work

CAUTION:

You can be injured and your vehicle could be damaged if you try to do service work on a vehicle without knowing enough about it.

- **Be sure you have sufficient knowledge, experience, the proper replacement parts, and tools before you attempt any vehicle maintenance task.**
- **Be sure to use the proper nuts, bolts, and other fasteners. English and metric fasteners can be easily confused. If you use the wrong fasteners, parts can later break or fall off. You could be hurt.**

If you want to do some of your own service work, you will want to use the proper service manual. It tells you much more about how to service your vehicle than this manual can. To order the proper service manual, see *Service Publications Ordering Information on page 8-14*.

Your vehicle has an airbag system. Before attempting to do your own service work, see *Servicing Your Airbag-Equipped Vehicle on page 1-44*.

You should keep a record with all parts receipts and list the mileage and the date of any service work you perform. See *Maintenance Record on page 7-14*.

Adding Equipment to the Outside of Your Vehicle

Things you might add to the outside of your vehicle can affect the airflow around it. This may cause wind noise and affect windshield washer performance. Check with your dealer before adding equipment to the outside of your vehicle.

Fuel

Use of the recommended fuel is an important part of the proper maintenance of your vehicle.

Gasoline Octane

Use premium unleaded gasoline with a posted octane rating of 91 or higher. You may also use regular unleaded gasoline rated at 87 octane or higher, but your vehicle's acceleration may be slightly reduced, and you may notice a slight audible knocking noise, commonly referred to as spark knock. If the octane is less than 87, you may notice a heavy knocking noise when you drive. If this occurs, use a gasoline rated at 87 octane or higher as soon as possible. Otherwise, you might damage your engine. If you are using gasoline rated at 87 octane or higher and you hear heavy knocking, your engine needs service.

Gasoline Specifications

At a minimum, gasoline should meet ASTM specification D 4814 in the United States or CAN/CGSB-3.5 in Canada. Some gasolines may contain an octane-enhancing additive called methylcyclopentadienyl manganese tricarbonyl (MMT). General Motors recommends against the use of gasolines containing MMT. See *Additives on page 6-6* for additional information.

California Fuel

If your vehicle is certified to meet California Emissions Standards, it is designed to operate on fuels that meet California specifications. See the underhood emission control label. If this fuel is not available in states adopting California emissions standards, your vehicle will operate satisfactorily on fuels meeting federal specifications, but emission control system performance may be affected. The malfunction indicator lamp may turn on and your vehicle may fail a smog-check test. See *Malfunction Indicator Lamp on page 3-58*. If this occurs, return to your authorized GM dealer for diagnosis. If it is determined that the condition is caused by the type of fuel used, repairs may not be covered by your warranty.

Additives

To provide cleaner air, all gasolines in the United States are now required to contain additives that will help prevent engine and fuel system deposits from forming, allowing your emission control system to work properly. In most cases, you should not have to add anything to your fuel. However, some gasolines contain only the minimum amount of additive required to meet U.S. Environmental Protection Agency regulations. To help keep fuel injectors and intake valves clean, or if your vehicle experiences problems due to dirty injectors or valves, look for gasoline that is advertised as TOP TIER Detergent Gasoline. Also, your GM dealer has additives that will help correct and prevent most deposit-related problems.

Gasolines containing oxygenates, such as ethers and ethanol, and reformulated gasolines may be available in your area. General Motors recommends that you use these gasolines if they comply with the specifications described earlier. However, E85 (85% ethanol) and other fuels containing more than 10% ethanol must not be used in vehicles that were not designed for those fuels.

Notice: Your vehicle was not designed for fuel that contains methanol. Do not use fuel containing methanol. It can corrode metal parts in your fuel system and also damage the plastic and rubber parts. That damage would not be covered under your warranty.

Some gasolines that are not reformulated for low emissions may contain an octane-enhancing additive called methylcyclopentadienyl manganese tricarbonyl (MMT); ask the attendant where you buy gasoline whether the fuel contains MMT. General Motors recommends against the use of such gasolines. Fuels containing MMT can reduce the life of spark plugs and the performance of the emission control system may be affected. The malfunction indicator lamp may turn on. If this occurs, return to your authorized GM dealer for service.

Fuels in Foreign Countries

If you plan on driving in another country outside the United States or Canada, the proper fuel may be hard to find. Never use leaded gasoline or any other fuel not recommended in the previous text on fuel. Costly repairs caused by use of improper fuel would not be covered by your warranty.

To check the fuel availability, ask an auto club, or contact a major oil company that does business in the country where you will be driving.

Filling the Tank

CAUTION:

Fuel vapor burns violently and a fuel fire can cause bad injuries. To help avoid injuries to you and others, read and follow all the instructions on the pump island. Turn off your engine when you are refueling. Do not smoke if you are near fuel or refueling your vehicle. Keep sparks, flames, and smoking materials away from fuel. Do not leave the fuel pump unattended when refueling your vehicle — this is against the law in some places. Keep children away from the fuel pump; never let children pump fuel.

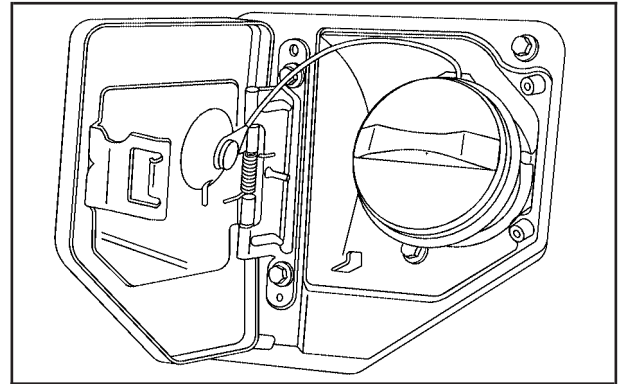

The tethered fuel cap is located behind a hinged fuel door on the driver's side of the vehicle.

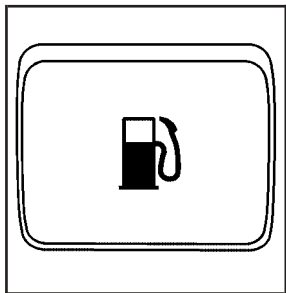

The fuel door release button is located on the left side of the instrument panel. The button only works when the vehicle is in PARK (P) or NEUTRAL (N) and the valet lockout button is in OFF.



An alternate fuel door release is located inside the trunk behind a panel on the driver's side of the vehicle. Pull the handle to release the fuel door.

To remove the fuel cap, turn it slowly counterclockwise. The fuel cap has a spring in it; if the cap is released too soon, it will spring back to the right.

While refueling, hang the tethered fuel cap from the hook on the fuel door.

 **CAUTION:**

If you spill fuel and then something ignites it, you could be badly burned. Fuel can spray out on you if you open the fuel cap too quickly. This spray can happen if your tank is nearly full, and is more likely in hot weather. Open the fuel cap slowly and wait for any hiss noise to stop. Then unscrew the cap all the way.

Be careful not to spill fuel. Do not top off or overfill the tank and wait a few seconds after you have finished pumping before removing the nozzle. Clean fuel from painted surfaces as soon as possible. See *Washing Your Vehicle on page 6-74*.

When replacing the fuel cap, turn it clockwise until it clicks. Make sure the cap is fully installed. The diagnostic system can determine if the fuel cap has been left off or improperly installed. This would allow fuel to evaporate into the atmosphere. See *Malfunction Indicator Lamp on page 3-58*.

The CHECK GAS CAP message in the Driver Information Center (DIC) will be displayed if the fuel cap is not properly installed.

 **CAUTION:**

If a fire starts while you are refueling, do not remove the nozzle. Shut off the flow of fuel by shutting off the pump or by notifying the station attendant. Leave the area immediately.

Notice: If you need a new fuel cap, be sure to get the right type. Your dealer can get one for you. If you get the wrong type, it may not fit properly. This may cause your malfunction indicator lamp to light and may damage your fuel tank and emissions system. See *Malfunction Indicator Lamp on page 3-58*.

Filling a Portable Fuel Container

CAUTION:

Never fill a portable fuel container while it is in your vehicle. Static electricity discharge from the container can ignite the gasoline vapor. You can be badly burned and your vehicle damaged if this occurs. To help avoid injury to you and others:

- Dispense gasoline only into approved containers.
- Do not fill a container while it is inside a vehicle, in a vehicle's trunk, pickup bed, or on any surface other than the ground.
- Bring the fill nozzle in contact with the inside of the fill opening before operating the nozzle. Contact should be maintained until the filling is complete.
- Do not smoke while pumping gasoline.

Checking Things Under the Hood

CAUTION:

An electric fan under the hood can start up and injure you even when the engine is not running. Keep hands, clothing and tools away from any underhood electric fan.

CAUTION:

Things that burn can get on hot engine parts and start a fire. These include liquids like fuel, oil, coolant, brake fluid, windshield washer and other fluids, and plastic or rubber. You or others could be burned. Be careful not to drop or spill things that will burn onto a hot engine.

Hood Release

To lift the hood, use the following steps:

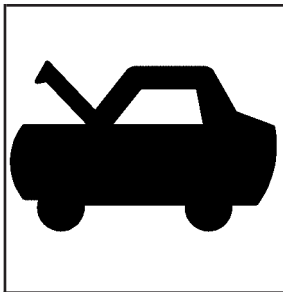

1. Pull the lever with this symbol on it. It is located on the lower left side of the instrument panel.

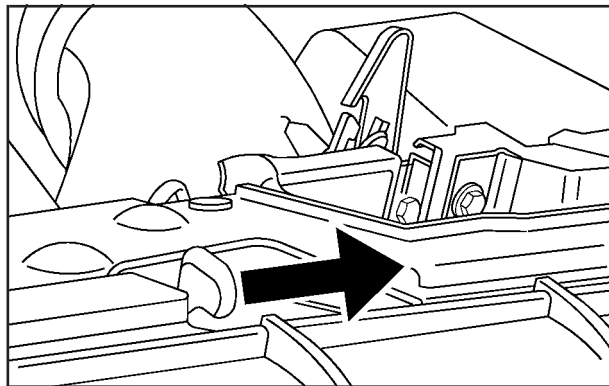

2. Then go to the front of the vehicle and find the secondary hood release lever. The lever is located under the hood near the center of the vehicle. Move the release lever to the right and raise the hood.

Before closing the hood, be sure all filler caps are on properly. Then pull the hood down and close it firmly.

Engine Compartment Overview

When you open the hood, here is what you will see:

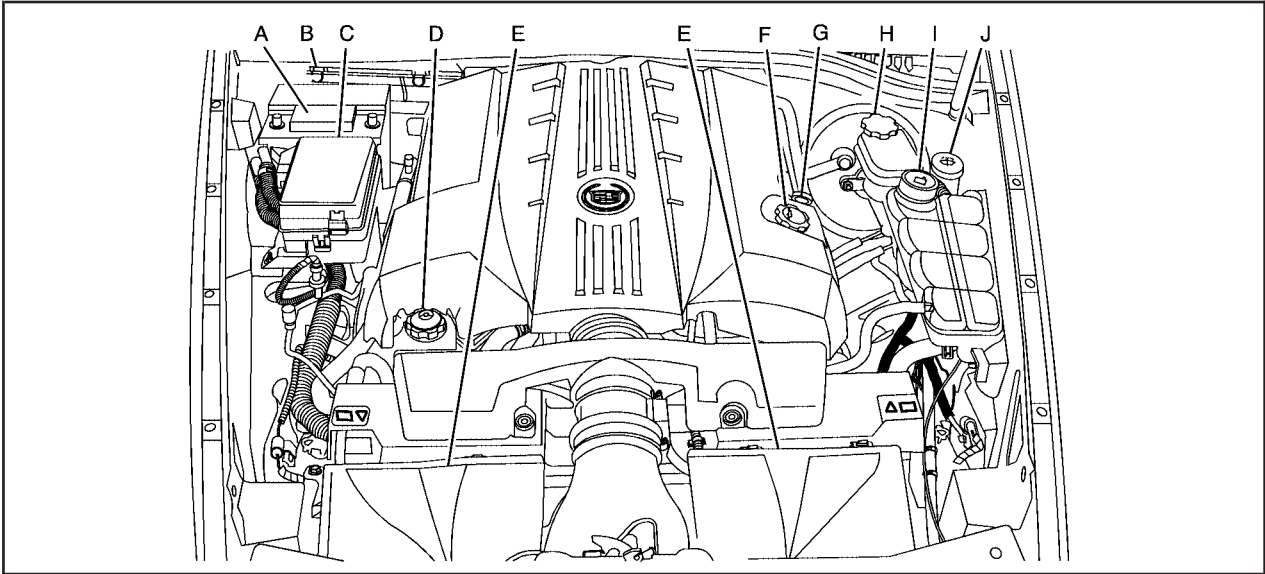

- A. Battery. See *Battery on page 6-36*.
- B. Passenger Compartment Air Filter. See *Passenger Compartment Air Filter on page 3-47*.
- C. Underhood Fuse Block. See *Underhood Fuse Block on page 6-83*.
- D. Power Steering Fluid. See *Power Steering Fluid on page 6-31*.
- E. Engine Air Cleaner/Filter. See *Engine Air Cleaner/Filter on page 6-18*.
- F. Engine Oil Fill Cap. See “When to Add Engine Oil” under *Engine Oil on page 6-13*.
- G. Engine Oil Dipstick. See “Checking Engine Oil” under *Engine Oil on page 6-13*.
- H. Brake Master Cylinder Reservoir. See “Brake Fluid” under *Brakes on page 6-33*.
- I. Engine Coolant Surge Tank and Pressure Cap. See *Coolant Surge Tank Pressure Cap on page 6-23*.
- J. Windshield Washer Fluid Reservoir. See “Adding Washer Fluid” under *Windshield Washer Fluid on page 6-32*.

Engine Oil

If the LOW OIL LEVEL or LOW OIL PRESSURE message on the Driver Information Center appears (DIC), it means you need to check your engine oil level right away. For more information, see LOW OIL LEVEL and LOW OIL PRESSURE under *DIC Warnings and Messages on page 3-67*.

You should check your engine oil level regularly; this is an added reminder.

Checking Engine Oil

It is a good idea to check your engine oil every time you get fuel. In order to get an accurate reading, the oil must be warm and the vehicle must be on level ground.

The engine oil dipstick handle is a yellow loop. See *Engine Compartment Overview on page 6-12* for the location of the engine oil dipstick.

1. Turn off the engine and give the oil several minutes to drain back into the oil pan. If you do not do this, the oil dipstick might not show the actual level.
2. Pull out the dipstick and clean it with a paper towel or cloth, then push it back in all the way. Remove it again, keeping the tip down, and check the level.

When to Add Engine Oil

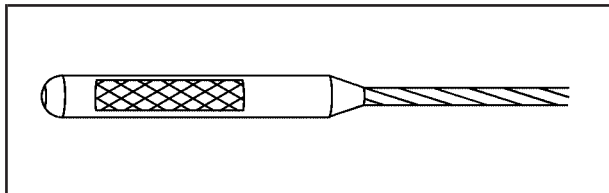

If the oil is below the cross-hatched area at the tip of the dipstick, you will need to add at least one quart/liter of oil. But you must use the right kind. This section explains what kind of oil to use. For engine oil crankcase capacity, see *Capacities and Specifications* on page 6-86.

Notice: Do not add too much oil. If the engine has so much oil that the oil level gets above the cross-hatched area that shows the proper operating range, the engine could be damaged.

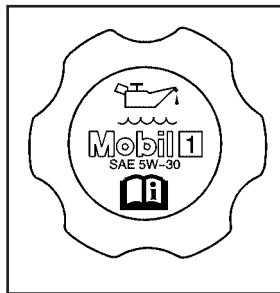

See *Engine Compartment Overview* on page 6-12 for the location of the engine oil fill cap.

Be sure to add enough oil to put the level somewhere in the proper operating range. Push the dipstick all the way back in when you are through.

What Kind of Engine Oil to Use

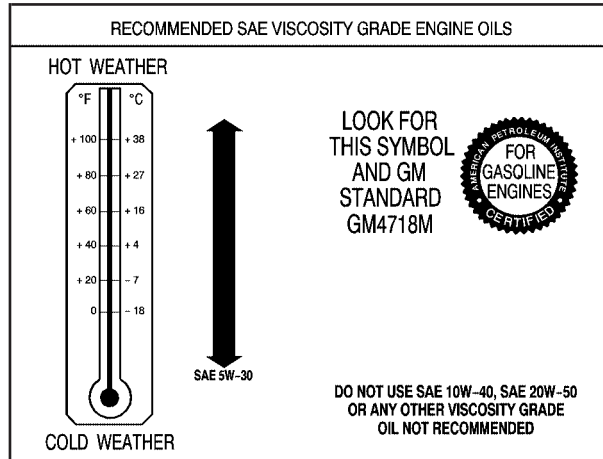

Look for two things:

- GM4718M

Your vehicle's engine requires a special oil meeting GM Standard GM4718M. Oils meeting this standard may be identified as synthetic. However, not all *synthetic* oils will meet this GM standard. You should look for and use only an oil that meets GM Standard GM4718M.

Notice: If you use oils that do not have the GM4718M Standard designation, you can cause engine damage not covered by your warranty.

- SAE 5W-30

As shown in the viscosity chart, SAE 5W-30 is best for your vehicle.

These numbers on an oil container show its viscosity, or thickness. Do not use other viscosity oils such as SAE 20W-50.

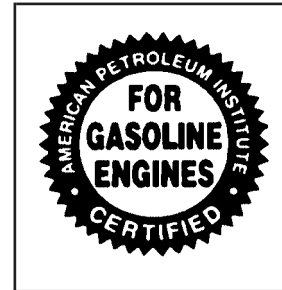

Oils meeting these requirements should also have the starburst symbol on the container. This symbol indicates that the oil has been certified by the American Petroleum Institute (API).

You should look for this on the oil container, and use *only* those oils that are identified as meeting GM Standard GM4718M and have the starburst symbol on the front of the oil container.

Your vehicle's engine is filled at the factory with a Mobil 1[®] synthetic oil, which meets all requirements for your vehicle.

Substitute Engine Oil: When adding oil to maintain engine oil level, oil meeting GM Standard GM4718M may not be available. You can add substitute oil designated SAE 5W-30 with the starburst symbol at all temperatures. Substitute oil not meeting GM Standard GM4718M should not be used for an oil change.

Engine Oil Additives

Do not add anything to your oil. The recommended oils with the starburst symbol that meet GM Standard GM4718M are all you will need for good performance and engine protection.

Engine Oil Life System

When to Change Engine Oil

Your vehicle has a computer system that lets you know when to change the engine oil and filter. This is based on engine revolutions and engine temperature, and not on mileage.

Based on driving conditions, the mileage at which an oil change will be indicated can vary considerably. For the oil life system to work properly, you must reset the system every time the oil is changed.

When the system has calculated that oil life has been diminished, it will indicate that an oil change is necessary. A CHANGE OIL NOW message in the DIC will come on. See *DIC Warnings and Messages on page 3-67*. Change your oil as soon as possible within the next 600 miles (1 000 km). It is possible that, if you are driving under the best conditions, the oil life system may not indicate that an oil change is necessary for over a year. However, your engine oil and filter must be changed at least once a year and at this time the system must be reset. Your dealer has GM-trained service people who will perform this work using genuine GM parts and reset the system. It is also important to check your oil regularly and keep it at the proper level.

If the system is ever reset accidentally, you must change your oil at 3,000 miles (5 000 km) since your last oil change. Remember to reset the oil life system whenever the oil is changed.

How to Reset the Engine Oil Life System and the Oil Life Indicator

The Engine Oil Life System calculates when to change your engine oil and filter based on vehicle use. Anytime your oil is changed, reset the system so it can calculate when the next oil change is required. If a situation occurs where you change your oil prior to a CHANGE OIL NOW message in the DIC being turned on, reset the system.

After the oil has been changed, the CHANGE OIL NOW message and the oil life indicator must be reset.

To reset the message use the following procedure:

1. Press the up or down arrow to scroll the DIC to show OIL LIFE.
2. Once the XXX% ENGINE OIL LIFE menu item is highlighted, press and hold the RESET button until the percentage shows 100%.

If the percentage does not return to 100% or if the CHANGE OIL NOW message comes back on when you start your vehicle, the engine oil life system has not reset. Repeat the procedure.

What to Do with Used Oil

Used engine oil contains certain elements that may be unhealthy for your skin and could even cause cancer. Do not let used oil stay on your skin for very long. Clean your skin and nails with soap and water, or a good hand cleaner. Wash or properly dispose of clothing or rags containing used engine oil. See the manufacturer's warnings about the use and disposal of oil products.

Used oil can be a threat to the environment. If you change your own oil, be sure to drain all the oil from the filter before disposal. Never dispose of oil by putting it in the trash, pouring it on the ground, into sewers, or into streams or bodies of water. Instead, recycle it by taking it to a place that collects used oil. If you have a problem properly disposing of your used oil, ask your dealer, a service station or a local recycling center for help.

Engine Air Cleaner/Filter

See *Engine Compartment Overview on page 6-12* for the location of the engine air cleaner/filters.

When to Inspect the Engine Air Cleaner/Filters

Inspect the air cleaner/filters at the Maintenance II intervals and replace them at the first oil change after each 50,000 mile (83 000 km) interval. See *Scheduled Maintenance on page 7-4* for more information. If you are driving in dusty/dirty conditions, inspect the filters at each engine oil change.

How to Inspect the Engine Air Cleaner/Filters

To inspect the air cleaner/filters, remove the filters from the vehicle and lightly shake the filters to release loose dust and dirt. If the filters remain caked with dirt, new filters are required.

To inspect or replace the filters, do the following:



1. Flip the clasps on the top of the engine air cleaner/filter cover forward to unlatch the cover.
2. Lift the front of the cover at an angle and remove. This is necessary due to the four tabs located on the rear of the cover.
3. Remove the engine air cleaner/filter element and any loose debris that may be found in the air cleaner base.
4. Inspect or replace the filter.
5. Repeat the procedure for the second air cleaner/filter.

Follow these steps to reinstall the covers to the engine air cleaner/filter housings:

1. Align the four tabs located on the back of the cover with the three slots on the back of the housing.
2. Push the cover slightly down and towards the engine to engage the tabs in the slots and align the two wing screws.
3. Engage and tighten the two clasps on the top of the engine air cleaner/filter cover.



CAUTION:

Operating the engine with the air cleaner/filter off can cause you or others to be burned. The air cleaner not only cleans the air; it helps to stop flames if the engine backfires. If it is not there and the engine backfires, you could be burned. Do not drive with it off, and be careful working on the engine with the air cleaner/filter off.

Notice: If the air cleaner/filter is off, a backfire can cause a damaging engine fire. And, dirt can easily get into your engine, which will damage it. Always have the air cleaner/filter in place when you are driving.

Automatic Transmission Fluid

How to Check Automatic Transmission Fluid

It is not necessary to check the transmission fluid level. A transmission fluid leak is the only reason for fluid loss. If a leak occurs, take the vehicle to the dealership service department and have it repaired as soon as possible.

There is a special procedure for checking and changing the transmission fluid. Because this procedure is difficult, you should have this done at the dealership service department. Contact your dealer for additional information or the procedure can be found in the service manual. To purchase a service manual, see *Service Publications Ordering Information on page 8-14*.

Notice: Use of the incorrect automatic transmission fluid may damage your vehicle, and the damages may not be covered by your warranty. Always use the automatic transmission fluid listed in *Recommended Fluids and Lubricants on page 7-11*.

Change the fluid and filter at the intervals listed in *Additional Required Services on page 7-6*, and be sure to use the fluid listed in *Recommended Fluids and Lubricants on page 7-11*.

Engine Coolant

The cooling system in your vehicle is filled with DEX-COOL[®] engine coolant. This coolant is designed to remain in your vehicle for five years or 150,000 miles (240 000 km), whichever occurs first, if you add only DEX-COOL[®] extended life coolant.

The following explains your cooling system and how to add coolant when it is low. If you have a problem with engine overheating, see *Engine Overheating* on page 6-23.

A 50/50 mixture of clean, drinkable water and DEX-COOL[®] coolant will:

- Giving freezing protection down to -34°F (-37°C).
- Give boiling protection up to 265°F (129°C).
- Protect against rust and corrosion.
- Help keep the proper engine temperature.
- Let the warning lights and gages work as they should.

Notice: Using coolant other than DEX-COOL[®] may cause premature engine, heater core, or radiator corrosion. In addition, the engine coolant may require changing sooner, at the first maintenance service after each 25,000 miles (41 500 km) or 24 months, whichever occurs first. Any repairs would not be covered by your warranty. Always use DEX-COOL[®] (silicate-free) coolant in your vehicle.

What to Use

Use a mixture of one-half clean, drinkable water and one-half DEX-COOL[®] coolant which will not damage aluminum parts. If you use this coolant mixture, you do not need to add anything else.

 **CAUTION:**

Adding only plain water to your cooling system can be dangerous. Plain water, or some other liquid such as alcohol, can boil before the proper coolant mixture will. Your vehicle's coolant warning system is set for the proper coolant mixture. With plain water or the wrong mixture, your engine could get too hot but you would not get the overheat warning. Your engine could catch fire and you or others could be burned. Use a 50/50 mixture of clean, drinkable water and DEX-COOL[®] coolant.

Notice: If you use an improper coolant mixture, your engine could overheat and be badly damaged. The repair cost would not be covered by your warranty. Too much water in the mixture can freeze and crack the engine, radiator, heater core and other parts.

If you have to add coolant more than four times a year, have your dealer check your cooling system.

Notice: If you use extra inhibitors and/or additives in your vehicle's cooling system, you could damage your vehicle. Use only the proper mixture of the engine coolant listed in this manual for the cooling system. See *Recommended Fluids and Lubricants on page 7-11* for more information.

Checking Coolant

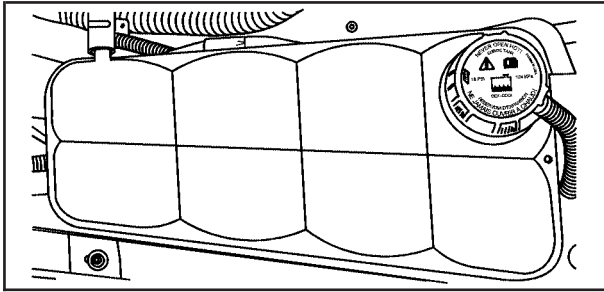

The engine coolant surge tank is located toward the rear of the engine compartment on the driver's side of the vehicle. For more information on location, see *Engine Compartment Overview on page 6-12*.

CAUTION:

Turning the surge tank pressure cap when the engine and radiator are hot can allow steam and scalding liquids to blow out and burn you badly. Never turn the surge tank pressure cap — even a little — when the engine and radiator are hot.

The vehicle must be on a level surface. When your engine is cold, the coolant level should be at the FULL COLD mark, located on the side of the surge tank that faces the front.

If the LOW COOLANT message on the Driver Information Center (DIC) comes on and stays on, it means you are low on engine coolant. See *DIC Warnings and Messages on page 3-67* for more information.

Adding Coolant

If you need more coolant, add the proper DEX-COOL[®] coolant mixture at the surge tank, but only when the engine is cool.

CAUTION:

You can be burned if you spill coolant on hot engine parts. Coolant contains ethylene glycol, and it will burn if the engine parts are hot enough. Do not spill coolant on a hot engine.

When replacing the pressure cap, press down and turn it clockwise until you hear a clicking sound. Make sure the cap is hand-tight and fully seated.

Coolant Surge Tank Pressure Cap

Notice: If the pressure cap is not tightly installed, coolant loss and possible engine damage may occur. Be sure the cap is properly and tightly secured.

The coolant surge tank pressure cap must be fully installed on the coolant surge tank. See *Engine Compartment Overview* on page 6-12 for more information on location.

Engine Overheating

You will find a COOLANT OVER TEMP message or an ENGINE HOT, STOP ENGINE message displayed in the Driver Information Center (DIC). See *DIC Warnings and Messages* on page 3-67. You will also hear a chime.

There is also an engine coolant temperature gage on the instrument panel cluster. See *Engine Coolant Temperature Gage* on page 3-57.

If Steam Is Coming From Your Engine

CAUTION:

Steam from an overheated engine can burn you badly, even if you just open the hood. Stay away from the engine if you see or hear steam coming from it. Just turn it off and get everyone away from the vehicle until it cools down. Wait until there is no sign of steam or coolant before you open the hood.

If you keep driving when your engine is overheated, the liquids in it can catch fire. You or others could be badly burned. Stop your engine if it overheats, and get out of the vehicle until the engine is cool.

See *Overheated Engine Protection Operating Mode* on page 6-25 for information on driving to a safe place in an emergency.

Notice: If your engine catches fire because you keep driving with no coolant, your vehicle can be badly damaged. The costly repairs would not be covered by your warranty. See *Overheated Engine Protection Operating Mode* on page 6-25 for information on driving to a safe place in an emergency.

If No Steam Is Coming From Your Engine

An overheat warning, along with a low coolant message, can indicate a serious problem.

If you get an engine overheat warning with no low coolant message, but see or hear no steam, the problem may not be too serious. Sometimes the engine can get a little too hot when you:

- Climb a long hill on a hot day.
- Stop after high-speed driving.
- Idle for long periods in traffic.
- Tow a trailer.

If you get the overheat warning with no sign of steam, try this for a minute or so:

1. In heavy traffic, let the engine idle in NEUTRAL (N) while stopped. If it is safe to do so, pull off the road, shift to PARK (P) or NEUTRAL (N) and let the engine idle.
2. Set the climate controls to the highest heat setting and fan speed and open the windows as necessary.

If you no longer have the overheat warning, you can drive. Just to be safe, drive slower for about 10 minutes. If the warning does not come back on, you can drive normally.

If the warning continues, pull over, stop, and park your vehicle right away.

If there is still no sign of steam, idle the engine for three minutes while you are parked. If you still have the warning, turn off the engine and get everyone out of the vehicle until it cools down. Also, see “Overheated Engine Protection Operating Mode” later in this section.

You may decide not to lift the hood but to get service help right away.

Overheated Engine Protection Operating Mode

This operating mode allows your vehicle to be driven to a safe place in an emergency situation. If an overheated engine condition exists and the DIC message ENGINE HOT, STOP ENGINE is displayed, an overheat protection mode which alternates firing groups of cylinders helps prevent engine damage. In this mode, you will notice a significant loss in power and engine performance. Driving extended miles (km) in the overheat protection mode should be avoided.

Notice: After driving in the overheated engine protection operating mode, to avoid engine damage, allow the engine to cool before attempting any repair. The engine oil will be severely degraded. Repair the cause of coolant loss, change the oil and reset the oil life system. See *Engine Oil on page 6-13*.

Cooling System

When you decide it is safe to lift the hood, here is what you will see:



- A. Electric Engine Cooling Fan
- B. Coolant Surge Tank with Pressure Cap

CAUTION:

An electric engine cooling fan under the hood can start up even when the engine is not running and can injure you. Keep hands, clothing and tools away from any underhood electric fan.

If the coolant inside the coolant surge tank is boiling, do not do anything else until it cools down. The vehicle should be parked on a level surface.

A low coolant level should be indicated by a LOW COOLANT message on the Driver Information Center (DIC). If it is, you may have a leak at the pressure cap or in the radiator hoses, heater hoses, radiator, water pump, or somewhere else in the cooling system.

 **CAUTION:**

Heater and radiator hoses, and other engine parts, can be very hot. Do not touch them. If you do, you can be burned.

Do not run the engine if there is a leak. If you run the engine, it could lose all coolant. That could cause an engine fire, and you could be burned. Get any leak fixed before you drive the vehicle.

If there seems to be no leak, with the engine on, check to see if the electric engine cooling fan is running. If the engine is overheating, the fan should be running. If it is not, your vehicle needs service.

Notice: Engine damage from running your engine without coolant is not covered by your warranty. See *Overheated Engine Protection Operating Mode* on page 6-25 for information on driving to a safe place in an emergency.

Notice: Using coolant other than DEX-COOL[®] may cause premature engine, heater core or radiator corrosion. In addition, the engine coolant may require changing sooner, at 30,000 miles (50 000 km) or 24 months, whichever occurs first. Any repairs would not be covered by your warranty. Always use DEX-COOL[®] (silicate-free) coolant in your vehicle.

How to Add Coolant to the Coolant Surge Tank

If you have not found a problem yet, check to see if coolant is visible in the surge tank. If coolant is visible but the coolant level is not at the FULL COLD mark on the front of the coolant surge tank, add a 50/50 mixture of clean, drinkable water and DEX-COOL® coolant at the coolant surge tank, but be sure the cooling system, including the coolant surge tank pressure cap, is cool before you do it. See *Engine Coolant* on page 6-20 for more information.

If no coolant is visible in the surge tank, add coolant as follows:

CAUTION:

Steam and scalding liquids from a hot cooling system can blow out and burn you badly. They are under pressure, and if you turn the coolant surge tank pressure cap — even a little — they can come out at high speed.

CAUTION: (Continued)

CAUTION: (Continued)

Never turn the cap when the cooling system, including the coolant surge tank pressure cap, is hot. Wait for the cooling system and coolant surge tank pressure cap to cool if you ever have to turn the pressure cap.

CAUTION:

Adding only plain water to your cooling system can be dangerous. Plain water, or some other liquid such as alcohol, can boil before the proper coolant mixture will. Your vehicle's coolant warning system is set for the proper coolant mixture. With plain water or the wrong mixture, your engine could get too hot but you would not get the overheat warning. Your engine could catch fire and you or others could be burned. Use a 50/50 mixture of clean, drinkable water and DEX-COOL® coolant.

Notice: In cold weather, water can freeze and crack the engine, radiator, heater core and other parts. Use the recommended coolant and the proper coolant mixture.

⚠ CAUTION:

You can be burned if you spill coolant on hot engine parts. Coolant contains ethylene glycol and it will burn if the engine parts are hot enough. Do not spill coolant on a hot engine.



1. You can remove the coolant surge tank pressure cap when the cooling system, including the coolant surge tank pressure cap and upper radiator hose, is no longer hot. Turn the pressure cap slowly counterclockwise.
If you hear a hiss, wait for that to stop. A hiss means there is still some pressure left.
2. Then keep turning the cap and remove it.



3. Fill the coolant surge tank with the proper mixture until the level inside the surge tank stabilizes at the FULL COLD mark on the front of the surge tank.

4. With the coolant surge tank pressure cap off, start the engine and let it run until you can feel the upper radiator hose getting hot. Watch out for the engine cooling fan.

By this time, the coolant level inside the coolant surge tank may be lower. If the level is lower, add more of the proper mixture to the coolant surge tank until the level stabilizes at the FULL COLD mark on the coolant surge tank.

5. Then replace the pressure cap. Be sure the cap is hand-tight and fully seated.

If the LOW COOLANT message does not appear on the Driver Information Center (DIC) after two minutes, the coolant is at the proper fill level. If a LOW COOLANT message does appear, repeat Steps 1 through 3 then reinstall the pressure cap, or see your dealer.

Power Steering Fluid

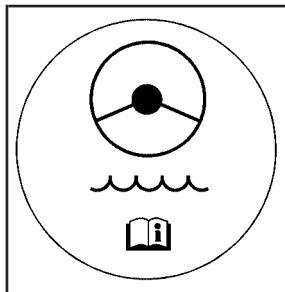

See *Engine Compartment Overview* on page 6-12 for reservoir location.

When to Check Power Steering Fluid

It is not necessary to regularly check power steering fluid unless you suspect there is a leak in the system or you hear an unusual noise. A fluid loss in this system could indicate a problem. Have the system inspected and repaired.

How to Check Power Steering Fluid

To check the power steering fluid, do the following:

1. Turn the key off and let the engine compartment cool down.
2. Wipe the cap and the top of the reservoir clean.
3. Unscrew the cap and wipe the dipstick with a clean rag.
4. Replace the cap and completely tighten it.
5. Remove the cap again and look at the fluid level on the dipstick.

The level should be at the FULL COLD mark. If necessary, add only enough fluid to bring the level up to the mark.

What to Use

To determine what kind of fluid to use, see *Recommended Fluids and Lubricants* on page 7-11. Always use the proper fluid. Failure to use the proper fluid can cause leaks and damage hoses and seals.

Windshield Washer Fluid

What to Use

When you need windshield washer fluid, be sure to read the manufacturer's instructions before use. If you will be operating your vehicle in an area where the temperature may fall below freezing, use a fluid that has sufficient protection against freezing.

Adding Washer Fluid

The LOW WASHER FLUID message will be displayed on the Driver Information Center (DIC) when the fluid is low.

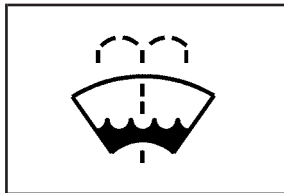

Open the cap with the washer symbol on it. Add washer fluid until the tank is full. See *Engine Compartment Overview* on page 6-12 for reservoir location.

Notice:

- When using concentrated washer fluid, follow the manufacturer's instructions for adding water.
- Do not mix water with ready-to-use washer fluid. Water can cause the solution to freeze and damage your washer fluid tank and other parts of the washer system. Also, water does not clean as well as washer fluid.
- Fill your washer fluid tank only three-quarters full when it is very cold. This allows for expansion if freezing occurs, which could damage the tank if it is completely full.
- Do not use engine coolant (antifreeze) in your windshield washer. It can damage your washer system and paint.

Brakes

Brake Fluid

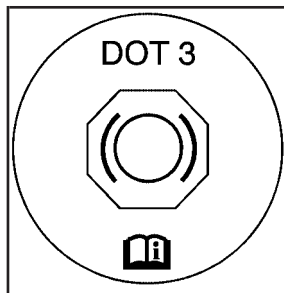

Your brake master cylinder reservoir is filled with DOT-3 brake fluid. See *Engine Compartment Overview* on page 6-12 for the location of the reservoir.

There are only two reasons why the brake fluid level in the reservoir might go down. The first is that the brake fluid goes down to an acceptable level during normal brake lining wear. When new linings are put in, the fluid level goes back up. The other reason is that fluid is leaking out of the brake system. If it is, you should have your brake system fixed, since a leak means that sooner or later your brakes will not work well, or will not work at all.

So, it is not a good idea to top off your brake fluid. Adding brake fluid will not correct a leak. If you add fluid when your linings are worn, then you will have too much fluid when you get new brake linings. You should add or remove brake fluid, as necessary, only when work is done on the brake hydraulic system.

CAUTION:

If you have too much brake fluid, it can spill on the engine. The fluid will burn if the engine is hot enough. You or others could be burned, and your vehicle could be damaged. Add brake fluid only when work is done on the brake hydraulic system. See “Checking Brake Fluid” in this section.

Refer to the Maintenance Schedule to determine when to check your brake fluid. See *Scheduled Maintenance* on page 7-4.

Checking Brake Fluid

You can check the brake fluid without taking off the cap. Look at the brake fluid reservoir. The fluid level should be above the MIN mark on the reservoir. If it is not, have your brake system checked to see if there is a leak.

After work is done on the brake hydraulic system, make sure the level is between the MIN and MAX marks.

What to Add

When you do need brake fluid, use only DOT-3 brake fluid. Refer to *Recommended Fluids and Lubricants* on page 7-11. Use new brake fluid from a sealed container only.

Always clean the brake fluid reservoir cap and the area around the cap before removing it. This will help keep dirt from entering the reservoir.

CAUTION:

With the wrong kind of fluid in your brake system, your brakes may not work well, or they may not even work at all. This could cause a crash. Always use the proper brake fluid.

Notice:

- **Using the wrong fluid can badly damage brake system parts. For example, just a few drops of mineral-based oil, such as engine oil, in your brake system can damage brake system parts so badly that they will have to be replaced. Do not let someone put in the wrong kind of fluid.**
- **If you spill brake fluid on your vehicle's painted surfaces, the paint finish can be damaged. Be careful not to spill brake fluid on your vehicle. If you do, wash it off immediately. See *Washing Your Vehicle* on page 6-74.**

Brake Wear

Your vehicle has four-wheel disc brakes.

Disc brake pads have built-in wear indicators that make a high-pitched warning sound when the brake pads are worn and new pads are needed. The sound may come and go or be heard all the time your vehicle is moving, except when you are pushing on the brake pedal firmly.



CAUTION:

The brake wear warning sound means that soon your brakes will not work well. That could lead to an accident. When you hear the brake wear warning sound, have your vehicle serviced.

Notice: Continuing to drive with worn-out brake pads could result in costly brake repair.

Some driving conditions or climates may cause a brake squeal when the brakes are first applied or lightly applied. This does not mean something is wrong with your brakes.

Brake linings should always be replaced as complete axle sets.

Brake Pedal Travel

See your dealer if the brake pedal does not return to normal height, or if there is a rapid increase in pedal travel. This could be a sign of brake trouble.

Brake Adjustment

As you make brake stops, your disc brakes automatically adjust for wear.

Replacing Brake System Parts

The braking system on a vehicle is complex. Its many parts have to be of top quality and work well together if the vehicle is to have really good braking. Your vehicle was designed and tested with top-quality GM brake parts. When you replace parts of your braking system — for example, when your brake linings wear down and you need new ones put in — be sure you get new approved GM replacement parts. If you do not, your brakes may no longer work properly. For example, if someone puts in brake linings that are wrong for your vehicle, the balance between your front and rear brakes can change — for the worse. The braking performance you have come to expect can change in many other ways if someone puts in the wrong replacement brake parts.

Battery

Your vehicle has a maintenance free battery. When it is time for a new battery, get one that has the replacement number shown on the original battery's label. We recommend an ACDelco® replacement battery.

For battery replacement, see your dealer or the service manual. To purchase a service manual, see *Service and Owner Publications* in *Service Publications Ordering Information* on page 8-14.

Warning: Battery posts, terminals, and related accessories contain lead and lead compounds, chemicals known to the State of California to cause cancer and reproductive harm. Wash hands after handling.

Vehicle Storage

If you are not going to drive your vehicle for 25 days or more, remove the black, negative (-) cable from the battery. This will help keep your battery from running down.

CAUTION:

Batteries have acid that can burn you and gas that can explode. You can be badly hurt if you are not careful. See *Jump Starting on page 6-37* for tips on working around a battery without getting hurt.

You must close all doors and the trunk before reconnecting the battery. After reconnecting the battery, you must press the unlock button on the keyless access transmitter. Failure to follow this procedure may result in the alarm sounding. Pressing unlock on the keyless access transmitter would stop the alarm.

Jump Starting

If your vehicle's battery has run down, you may want to use another vehicle and some jumper cables to start your vehicle. Be sure to use the following steps to do it safely.

CAUTION:

Batteries can hurt you. They can be dangerous because:

- They contain acid that can burn you.
- They contain gas that can explode or ignite.
- They contain enough electricity to burn you.

If you do not follow these steps exactly, some or all of these things can hurt you.

Notice: If you try to start your vehicle by pushing or pulling it, you could damage your vehicle. Do not push or pull your vehicle to start it; instead, use the jump starting procedure in this manual to start your vehicle when the battery has run down.

1. Check the other vehicle. It must have a 12-volt battery with a negative ground system.

Notice: If the other vehicle's system is not a 12-volt system with a negative ground, both vehicles can be damaged. Only use vehicles with 12-volt systems with negative grounds to jump start your vehicle.

2. Get the vehicles close enough so the jumper cables can reach, but be sure the vehicles are not touching each other. If they are, it could cause a ground connection you do not want. You would not be able to start your vehicle, and the bad grounding could damage the electrical systems.

To avoid the possibility of the vehicles rolling, set the parking brake firmly on both vehicles involved in the jump start procedure. Put an automatic transmission in PARK (P) or a manual transmission in NEUTRAL before setting the parking brake.

Notice: If you leave your radio or other accessories on during the jump starting procedure, they could be damaged. The repairs would not be covered by your warranty. Always turn off your radio and other accessories when jump starting your vehicle.

3. Turn off the ignition on both vehicles. Unplug unnecessary accessories plugged into the cigarette lighter or the accessory power outlet. Turn off the radio and all lamps that are not needed. This will avoid sparks and help save both batteries. And it could save the radio!
4. Open the hoods and locate the batteries. Find the positive (+) and negative (-) terminal locations on each vehicle. See *Engine Compartment Overview* on page 6-12 for more information on location.

 **CAUTION:**

An electric fan can start up even when the engine is not running and can injure you. Keep hands, clothing and tools away from any underhood electric fan.

 **CAUTION:**

Using a match near a battery can cause battery gas to explode. People have been hurt doing this, and some have been blinded. Use a flashlight if you need more light.

Be sure the battery has enough water. You do not need to add water to the battery installed in your new vehicle. But if a battery has filler caps, be sure the right amount of fluid is there. If it is low, add water to take care of that first. If you do not, explosive gas could be present.

Battery fluid contains acid that can burn you. Do not get it on you. If you accidentally get it in your eyes or on your skin, flush the place with water and get medical help immediately.

 **CAUTION:**

Fans or other moving engine parts can injure you badly. Keep your hands away from moving parts once the engine is running.

5. Check that the jumper cables do not have loose or missing insulation. If they do, you could get a shock. The vehicles could be damaged too.

Before you connect the cables, here are some basic things you should know. Positive (+) will go to positive (+) or to a remote positive (+) terminal if the vehicle has one. Negative (-) will go to a heavy, unpainted metal engine part or to a remote negative (-) terminal if the vehicle has one.

Do not connect positive (+) to negative (-) or you will get a short that would damage the battery and maybe other parts too. And do not connect the negative (-) cable to the negative (-) terminal on the dead battery because this can cause sparks.

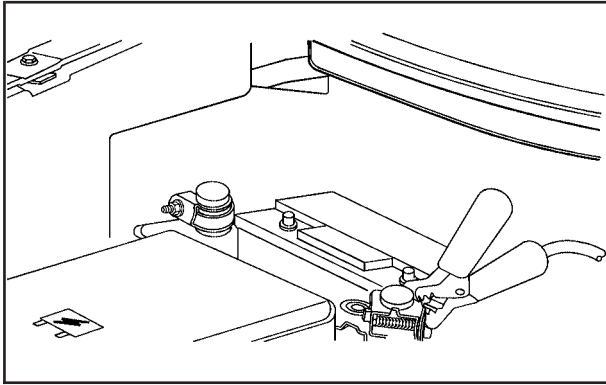

6. Connect the red positive (+) cable to the positive (+) terminal of the dead battery. Use a remote positive (+) terminal if the vehicle has one.
7. Do not let the other end touch metal. Connect it to the positive (+) terminal of the good battery. Use a remote positive (+) terminal if the vehicle has one.

8. Now connect the black negative (-) cable to the negative (-) terminal of the good battery. Use a remote negative (-) terminal if the vehicle has one.
Do not let the other end touch anything until the next step. The other end of the negative (-) cable does not go to the dead battery. It goes to a heavy, unpainted metal engine part or to a remote negative (-) terminal on the vehicle with the dead battery.
9. Connect the other end of the negative (-) cable at least 18 inches (45 cm) away from the dead battery, but not near engine parts that move. The electrical connection is just as good there, and the chance of sparks getting back to the battery is much less.
10. Now start the vehicle with the good battery and run the engine for a while.
11. Try to start the vehicle that had the dead battery. If it will not start after a few tries, it probably needs service.

Notice: If the jumper cables are connected or removed in the wrong order, electrical shorting may occur and damage the vehicle. The repairs would not be covered by your warranty. Always connect and remove the jumper cables in the correct order, making sure that the cables do not touch each other or other metal.

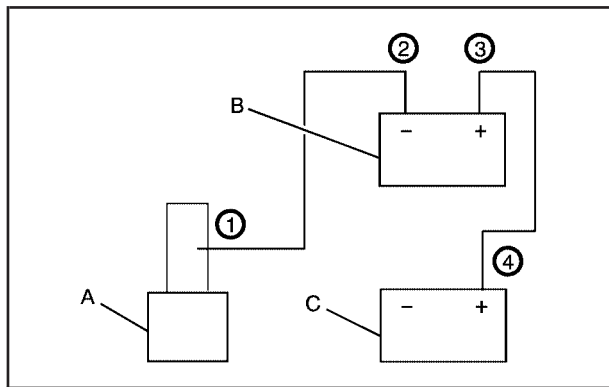

Jumper Cable Removal

- A. Heavy, Unpainted Metal Engine Part
- B. Good Battery
- C. Dead Battery

To disconnect the jumper cables from both vehicles, do the following:

1. Disconnect the black negative (-) cable from the vehicle that had the dead battery.
2. Disconnect the black negative (-) cable from the vehicle with the good battery.
3. Disconnect the red positive (+) cable from the vehicle with the good battery.
4. Disconnect the red positive (+) cable from the other vehicle.

Rear Axle

When to Check Lubricant

It is not necessary to regularly check rear axle fluid unless you suspect there is a leak or you hear an unusual noise. A fluid loss could indicate a problem. Have it inspected and repaired.

How to Check Lubricant

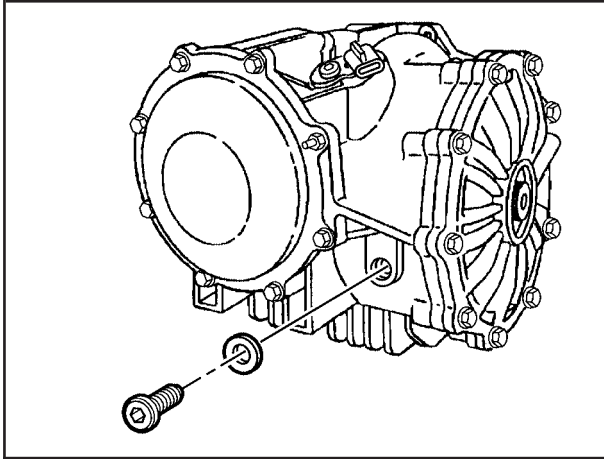

To get an accurate reading, the vehicle should be on a level surface.

If the level is below the bottom of the filler plug hole, you will need to add some lubricant. Add enough lubricant to raise the level to the bottom of the filler plug hole.

What to Use

To add lubricant when the level is low, use SAE 75W-90 Synthetic Gear Lubricant (GM Part No. 12378261) or equivalent meeting GM Specification 9986115. To completely refill after draining, add 4 ounces (118 ml) of Limited-Slip Differential Lubricant Additive (GM Part No. 1052358) or equivalent. Then fill to the bottom of the filler plug hole with the Synthetic Gear Lubricant.

Headlamp Aiming

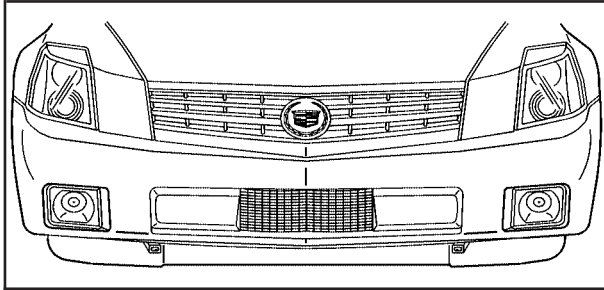

Your vehicle has a visual optical headlamp aiming system equipped with horizontal aim indicators. The aim has been preset at the factory and should need no further adjustment. This is true even though your horizontal aim indicators may not fall exactly on the "0" (zero) marks on their scales.

If your vehicle is damaged in an accident, the headlamp aim may be affected. Aim adjustment to the low beam may be necessary if it is difficult to see lane markers (for horizontal aim), or if oncoming drivers flash their high beams at you (for vertical aim). If you believe your headlamps need to be re-aimed, we recommend that you take your vehicle to your dealer for service. However, it is possible for you to re-aim your headlamps as described in the following procedure.

Notice: To make sure your headlamps are aimed properly, read all the instructions before beginning. Failure to follow these instructions could cause damage to headlamp parts.

The vehicle should be properly prepared as follows:

- The vehicle should be placed so the headlamps are 25 ft. (7.6 m) from a light colored wall or other flat surface.
- The vehicle must have all four tires on a perfectly level surface which is level all the way to the wall or other flat surface.
- The vehicle should be placed so it is perpendicular to the wall or other flat surface.
- The vehicle should not have any snow, ice or mud attached to it.
- The vehicle should be fully assembled and all other work stopped while headlamp aiming is being done.
- The vehicle should be normally loaded with a full tank of fuel and one person or 160 lbs (75 kg) on the driver's seat.
- Tires should be properly inflated.
- Start the vehicle and rock it to level the suspension.

Headlamp aiming is done with the low-beam headlamps. The high-beam headlamps will be correctly aimed if the low-beam headlamps are aimed properly.

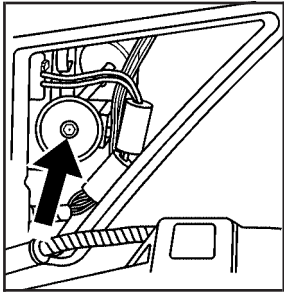

The headlamp aiming devices are under the hood near the headlamps.

If you believe your headlamps need vertical (up/down) adjustment, follow the vertical aiming procedure.

Adjustment screws can be turned with an E8 Torx[®] socket or T15 Torx screwdriver.

Headlamp Vertical Aiming

Notice: Horizontal aiming must be performed before making any adjustments to the vertical aim. Adjusting the vertical aim first will result in an incorrect headlamp aim.

1. Find the aim dot on the lens of the low-beam headlamp.
2. Measure the distance from the ground to the aim dot on each low-beam headlamp. Record this distance.
3. At the wall or other flat surface, measure from the ground upward the recorded distance from Step 2 and draw or tape a horizontal line the width of the vehicle.

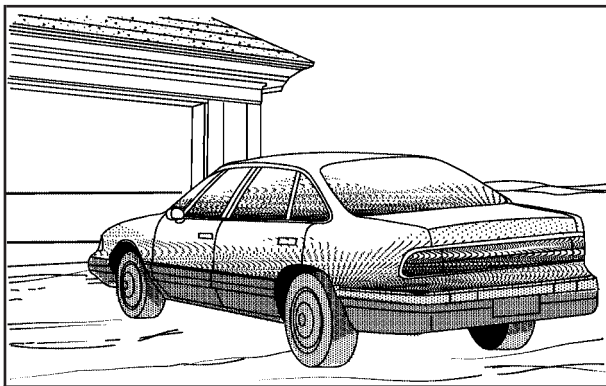

Notice: Do not cover a headlamp to improve beam cut-off when aiming. Covering a headlamp may cause excessive heat build-up which may cause damage to the headlamp.

4. Turn on the low-beam headlamps and place a piece of cardboard or equivalent in front of the headlamp not being aimed. This should allow only the beam of light from the headlamp being aimed to be seen on the flat surface.

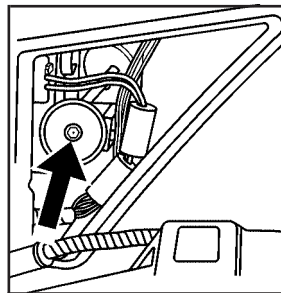

5. Turn the vertical aiming screw until the headlamp beam is aimed to the horizontal tape line. The top edge of the cut-off should be positioned at the bottom edge of the horizontal tape line.

6. Repeat Steps 4 and 5 for the opposite headlamp.

Bulb Replacement

It is recommended that all bulbs be replaced by your dealer.

Windshield Replacement

Keep in mind that your windshield is part of the Head-Up Display (HUD) system. If you ever have to get your windshield replaced, be sure to get one that is designed for HUD or your HUD image may look blurred or out of focus.

Windshield Wiper Blade Replacement

Windshield wiper blades should be inspected for wear or cracking. See *Scheduled Maintenance on page 7-4*.

It is a good idea to clean or replace the wiper blade assembly on a regular basis or when worn. For proper windshield wiper blade length and type, see *Normal Maintenance Replacement Parts on page 7-13*.

To replace the wiper blade assembly, do the following:

1. Place the vehicle in accessory mode and turn the wipers on. Position the wipers on the windshield in the mid-wipe position. Then with a door open, turn the vehicle off.

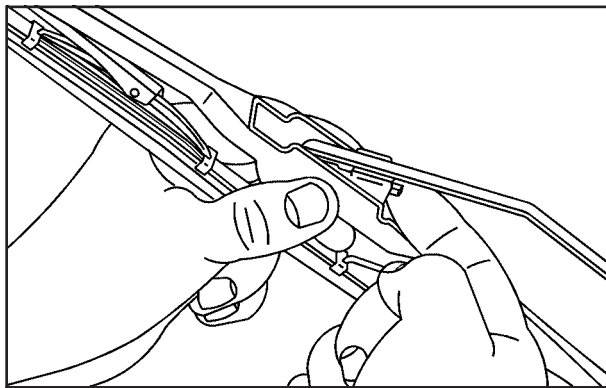

2. Tip the blade up and pull up on the tab to release the wiper blade assembly.
3. To install, align the wiper blade with the loop on the wiper blade assembly, and push up to snap it into place.

Tires

Your new vehicle comes with high-quality tires made by a leading tire manufacturer. If you ever have questions about your tire warranty and where to obtain service, see your GM Warranty booklet for details. For additional information refer to the tire manufacturer's booklet included with your vehicle's Owner Manual.



CAUTION:

Poorly maintained and improperly used tires are dangerous.

- **Overloading your tires can cause overheating as a result of too much friction. You could have an air-out and a serious accident. See *Loading Your Vehicle* on page 5-33.**

CAUTION: (Continued)

CAUTION: (Continued)

- **Underinflated tires pose the same danger as overloaded tires. The resulting accident could cause serious injury. Check all tires frequently to maintain the recommended pressure. Tire pressure should be checked when your tires are cold. See *Inflation - Tire Pressure* on page 6-54.**
- **Overinflated tires are more likely to be cut, punctured, or broken by a sudden impact — such as when you hit a pothole. Keep tires at the recommended pressure.**
- **Worn, old tires can cause accidents. If your tread is badly worn, or if your tires have been damaged, replace them.**

Tire Sidewall Labeling

Useful information about a tire is molded into its sidewall. The example below shows a typical passenger (p-metric) tire sidewall.

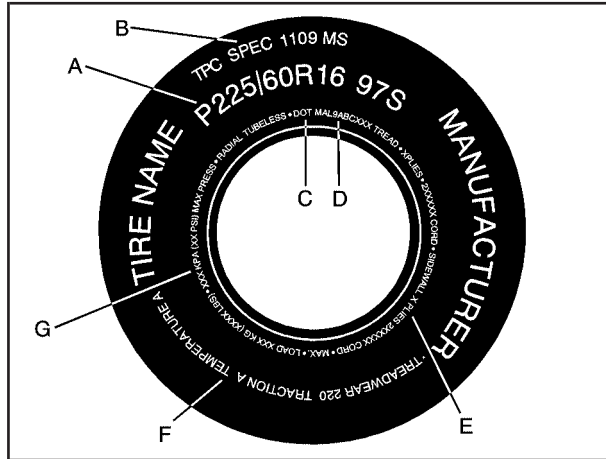

Passenger (P-Metric) Tire Example

(A) Tire Size: The tire size is a combination of letters and numbers used to define a particular tire's width, height, aspect ratio, construction type and service description. See the "Tire Size" illustration later in this section for more detail.

(B) TPC Spec (Tire Performance Criteria Specification): Original equipment tires designed to GM's specific tire performance criteria have a TPC specification code molded onto the sidewall. GM's TPC specifications meet or exceed all federal safety guidelines.

(C) DOT (Department of Transportation): The Department of Transportation (DOT) code indicates that the tire is in compliance with the U.S. Department of Transportation Motor Vehicle Safety Standards.

(D) Tire Identification Number (TIN): The letters and numbers following DOT code are the Tire Identification Number (TIN). The TIN shows the manufacturer and plant code, tire size, and date the tire was manufactured. The TIN is molded onto both sides of the tire, although only one side may have the date of manufacture.

(E) Tire Ply Material: The type of cord and number of plies in the sidewall and under the tread.

(F) Uniform Tire Quality Grading (UTQG): Tire manufacturers are required to grade tires based on three performance factors: treadwear, traction and temperature resistance. For more information see *Uniform Tire Quality Grading on page 6-60*.

(G) Maximum Cold Inflation Load Limit: Maximum load that can be carried and the maximum pressure needed to support that load.

Tire Size

The following illustration shows an example of a typical passenger (p-metric) vehicle tire size.

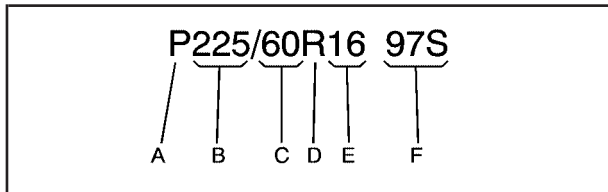

(A) Passenger (P-Metric) Tire: The United States version of a metric tire sizing system. The letter P as the first character in the tire size means a passenger vehicle tire engineered to standards set by the U. S. Tire and Rim Association.

(B) Tire Width: The three-digit number indicates the tire section width in millimeters from sidewall to sidewall.

(C) Aspect Ratio: A two-digit number that indicates the tire height-to-width measurements. For example, if the tire size aspect ratio is 60, as shown in item C of the illustration, it would mean that the tire's sidewall is 60 percent as high as it is wide.

(D) Construction Code: A letter code is used to indicate the type of ply construction in the tire. The letter R means radial ply construction; the letter D means diagonal or bias ply construction; and the letter B means belted-bias ply construction.

(E) Rim Diameter: Diameter of the wheel in inches.

(F) Service Description: These characters represent the load range and speed rating of the tire. The load index represents the load carry capacity a tire is certified to carry. The load index can range from 1 to 279. The speed rating is the maximum speed a tire is certified to carry a load. Speed ratings range from A to Z.

Tire Terminology and Definitions

Air Pressure: The amount of air inside the tire pressing outward on each square inch of the tire. Air pressure is expressed in pounds per square inch (psi) or kilopascal (kPa).

Accessory Weight: This means the combined weight of optional accessories. Some examples of optional accessories are, automatic transmission, power steering, power brakes, power windows, power seats, and air conditioning.

Aspect Ratio: The relationship of a tire's height to its width.

Belt: A rubber coated layer of cords that is located between the plies and the tread. Cords may be made from steel or other reinforcing materials.

Bead: The tire bead contains steel wires wrapped by steel cords that hold the tire onto the rim.

Bias Ply Tire: A pneumatic tire in which the plies are laid at alternate angles less than 90 degrees to the centerline of the tread.

Cold Inflation Pressure: The amount of air pressure in a tire, measured in pounds per square inch (psi) or kilopascals (kPa) before a tire has built up heat from driving. See *Inflation - Tire Pressure on page 6-54*.

Curb Weight: This means the weight of a motor vehicle with standard and optional equipment including the maximum capacity of fuel, oil and coolant, but without passengers and cargo.

DOT Markings: A code molded into the sidewall of a tire signifying that the tire is in compliance with the U.S. Department of Transportation (DOT) motor vehicle safety standards. The DOT code includes the Tire Identification Number (TIN), an alphanumeric designator which can also identify the tire manufacturer, production plant, brand and date of production.

GVWR: Gross Vehicle Weight Rating, see *Loading Your Vehicle on page 5-33*.

GAWR FRT: Gross Axle Weight Rating for the front axle, see *Loading Your Vehicle on page 5-33*.

GAWR RR: Gross Axle Weight Rating for the rear axle, see *Loading Your Vehicle on page 5-33*.

Intended Outboard Sidewall: The side of an asymmetrical tire, that must always face outward when mounted on a vehicle.

Kilopascal (kPa): The metric unit for air pressure.

Light Truck (LT-Metric) Tire: A tire used on light duty trucks and some multipurpose passenger vehicles.

Load Index: An assigned number ranging from 1 to 279 that corresponds to the load carrying capacity of a tire.

Maximum Inflation Pressure: The maximum air pressure to which a cold tire may be inflated. The maximum air pressure is molded onto the sidewall.

Maximum Load Rating: The load rating for a tire at the maximum permissible inflation pressure for that tire.

Maximum Loaded Vehicle Weight: The sum of curb weight; accessory weight; vehicle capacity weight; and production options weight.

Normal Occupant Weight: The number of occupants a vehicle is designed to seat multiplied by 150 lbs (68 kg). See *Loading Your Vehicle on page 5-33*.

Occupant Distribution: Designated seating positions.

Outward Facing Sidewall: The side of an asymmetrical tire that has a particular side that faces outward when mounted on a vehicle. The side of the tire that contains a whitewall, bears white lettering, or bears manufacturer, brand, and/or model name molding that is higher or deeper than the same moldings on the other sidewall of the tire.

Passenger (P-Metric) Tire: A tire used on passenger cars and some light duty trucks and multipurpose vehicles.

Recommended Inflation Pressure: Vehicle manufacturer's recommended tire inflation pressure and shown on the tire placard. See *Inflation - Tire Pressure on page 6-54* and *Loading Your Vehicle on page 5-33*.

Radial Ply Tire: A pneumatic tire in which the ply cords that extend to the beads are laid at 90 degrees to the centerline of the tread.

Rim: A metal support for a tire and upon which the tire beads are seated.

Sidewall: The portion of a tire between the tread and the bead.

Speed Rating: An alphanumeric code assigned to a tire indicating the maximum speed at which a tire can operate.

Traction: The friction between the tire and the road surface. The amount of grip provided.

Tread: The portion of a tire that comes into contact with the road.

Treadwear Indicators: Narrow bands, sometimes called wear bars, that show across the tread of a tire when only 1/16 inch (1.6 mm) of tread remains. See *When It Is Time for New Tires on page 6-58*.

UTQGS (Uniform Tire Quality Grading Standards):

A tire information system that provides consumers with ratings for a tire's traction, temperature, and treadwear. Ratings are determined by tire manufacturers using government testing procedures. The ratings are molded into the sidewall of the tire. See *Uniform Tire Quality Grading on page 6-60*.

Vehicle Capacity Weight: The number of designated seating positions multiplied by 150 lbs (68 kg) plus the rated cargo load. See *Loading Your Vehicle on page 5-33*.

Vehicle Maximum Load on the Tire: Load on an individual tire due to curb weight, accessory weight, occupant weight, and cargo weight.

Vehicle Placard: A label permanently attached to a vehicle showing the vehicle's capacity weight and the original equipment tire size and recommended inflation pressure. See "Tire and Loading Information Label" under *Loading Your Vehicle on page 5-33*.

Run-Flat Tires

Your vehicle, when new, had run-flat tires. There is no spare tire, no tire changing equipment, and no place to store a tire in the vehicle. Run-flat tires perform so well without any air that a Tire Pressure Monitor (TPM) is used to alert you if a tire has lost pressure.

If a tire goes flat, you will not need to stop on the side of the road to change the tire. You can just keep on driving. The shorter the distance you drive and the slower the speed, the greater the chance that the tire will not have to be replaced. If you drive on a deflated run-flat tire for 50 miles (80 km) or less and at speeds of 55 mph (90 km/h) or less, there is a good chance that the tire can be repaired. The tire can operate effectively with no air pressure for up to 100 miles (160 km) at speeds up to 55 mph (90 km/h), but the tire would then have to be replaced. When a tire is filled with air, it provides a cushion between the road and the wheel. Because you will not have this cushion when driving on a deflated tire, try to avoid potholes that could damage your wheel and require replacement of it.

Some road hazards can damage a tire beyond repair. This damage could occur even before you have driven on the tire in a deflated condition. When a tire has been damaged, or if you have driven any distance on a run-flat tire, check with an authorized run-flat tire service center to determine whether the tire can be repaired or should be replaced. To maintain your vehicle's run-flat feature, all replacement tires must be self-supporting tires. As soon as possible, contact the nearest authorized GM or run-flat servicing facility for inspection and repair or replacement. To locate the nearest GM or run-flat servicing facility, call Roadside Assistance. For phone numbers and Roadside Service details see *Roadside Service on page 8-6*.



CAUTION:

Run-flat tires are constructed differently than other tires and could explode during improper service. You or others could be injured or killed if you attempt to repair, replace, dismount, or mount a run-flat tire. Let only an authorized run-flat service center repair, replace, dismount, and mount run-flat tires.

The valve stems on your run-flat tires have sensors that are part of the Tire Pressure Monitor System (TPMS). See *Tire Pressure Monitor System on page 6-55*. These sensors contain batteries which are designed to last for 10 years under normal driving conditions. See your dealer if you ever need to have a wheel replaced, or if the sensors ever need replacement.

Notice: Using liquid sealants can damage the tire valves and tire pressure monitor sensors in your vehicle's run-flat tires. This damage would not be covered by warranty. Do not use liquid sealants in your vehicle's run-flat tires.

Inflation - Tire Pressure

Tires need the correct amount of air pressure to operate effectively.

Notice: Do not let anyone tell you that under-inflation or over-inflation is all right. It is not. If your tires do not have enough air (under-inflation), you can get the following:

- Too much flexing
- Too much heat
- Tire overloading
- Premature or irregular wear
- Poor handling
- Reduced fuel economy

If your tires have too much air (over-inflation), you can get the following:

- Unusual wear
- Poor handling
- Rough ride
- Needless damage from road hazards

A Tire and Loading Information label is attached to the center pillar, below the driver's door latch. This label shows your vehicle's original equipment tires and the correct inflation pressures for your tires when they are cold. The recommended cold tire inflation pressure, shown on the label, is the minimum amount of air pressure needed to support your vehicle's maximum load carrying capacity.

For additional information regarding how much weight your vehicle can carry, and an example of the tire and loading information label, see *Loading Your Vehicle on page 5-33*. How you load your vehicle affects vehicle handling and ride comfort, never load your vehicle with more weight than it was designed to carry.

When to Check

Check your tires once a month or more.

How to Check

Use a good quality pocket-type gage to check tire pressure. You cannot tell if your tires are properly inflated simply by looking at them. Radial tires may look properly inflated even when they are underinflated. Check the tire's inflation pressure when the tires are cold. Cold means your vehicle has been sitting for at least three hours or driven no more than 1 mile (1.6 km).

Remove the valve cap from the tire valve stem. Press the tire gage firmly onto the valve to get a pressure measurement. If the cold tire inflation pressure matches the recommended pressure on the Tire and Loading Information label, no further adjustment is necessary. If the inflation pressure is low, add air until you reach the recommended amount.

If you overfill the tire, release air by pushing on the metal stem in the center of the tire valve. Recheck the tire pressure with the tire gage.

Be sure to put the valve caps back on the valve stems. They help prevent leaks by keeping out dirt and moisture.

Tire Pressure Monitor (TPM)

Your vehicle has a Tire Pressure Monitor (TPM) that sends tire pressure information to the Driver Information Center (DIC). Using the DIC control buttons, the driver is able to check tire pressure levels in all four road tires. See *Tire Pressure Monitor System* on page 6-55 and *DIC Controls and Displays* on page 3-64 for additional information.

Tire Pressure Monitor System

The Tire Pressure Monitor (TPM) System on your vehicle, uses radio and sensor technology to check tire pressure levels. Sensors, mounted on each tire and wheel assembly transmit tire pressure readings to a receiver located in the vehicle. The TPM sensors transmit tire pressure readings once every 60 seconds while the vehicle is being driven and once every 60 minutes when the vehicle is stationary for more than 15 minutes. Using the Driver Information Center (DIC), tire pressure levels can be viewed by the driver. The TPM system also uses the DIC to warn the driver when air pressure, in one or more tires, falls below 25 psi (172 kPa) or is above 42 psi (290 kPa). For additional information and details about the DIC operation and displays see *DIC Controls and Displays* on page 3-64 and *DIC Warnings and Messages* on page 3-67.

A low tire warning light also appears on the instrument panel cluster when a low tire condition exists. The DIC message, CHECK TIRE PRESSURE and the low tire pressure warning light will be shown each time the engine is started and stay on until the low tire condition is corrected.



When the tire pressure monitoring system warning light is lit, one or more of your tires is significantly under-inflated.

You should stop and check your tires as soon as possible, and inflate them to the proper pressure as indicated on the vehicle's tire information placard.

Driving on a significantly under-inflated tire causes the tire to overheat and can lead to tire failure. Under-inflation also reduces fuel efficiency and tire tread life, and may affect the vehicle's handling and stopping ability. Each tire, including the spare, should be checked monthly when cold and set to the recommended inflation pressure as specified in the vehicle placard and owner's manual.

The Tire and Loading Information Label (tire information placard) is on the rear edge of the driver's door, below the door latch. This label shows the size of your vehicle's original tires and the correct inflation pressure for your vehicle's tires when they are cold. See *Loading Your Vehicle on page 5-33*.

Your vehicle's TPM system can alert you about a low or high tire pressure condition but it does not replace normal tire maintenance. See *Tire Inspection and Rotation on page 6-57*

Each TPM sensor has a unique identification code that is matched to one of the four tire positions on your vehicle. The tire and wheel assembly positions are, left front (LF); right front (RF); right rear (RR) and left rear (LR). Any time you rotate your vehicle's tires or replace one or more TPM sensors, the identification codes will need to be matched to the new tire and wheel position. The TPM matching process is performed in a specific sequence and time limit. A special tool is also required. See your dealer for service.

The SVC TIRE MONITOR message is displayed when the TPM system is malfunctioning. For example, one or more TPM sensors may be inoperable or missing. See your dealer for service.

The TPM system operates on a radio frequency subject to Federal Communications Commission (FCC) Rules and with Industry and Science Canada.

This device complies with Part 15 of the FCC Rules and with RSS-210 of Industry and Science Canada. Operation is subject to the following two conditions: (1) This device may not cause harmful interference, and (2) this device must accept any interference received including interference that may cause undesired operation of the device.

Changes or modifications to this system by other than an authorized service facility could void authorization to use this equipment.

Tire Inspection and Rotation

Your vehicle's tires should be inspected regularly for wear. Any time you notice unusual wear, rotate your tires as soon as possible and check wheel alignment. Also check for damaged tires or wheels. See *When It Is Time for New Tires* on page 6-58 and *Wheel Replacement* on page 6-62 for additional information.

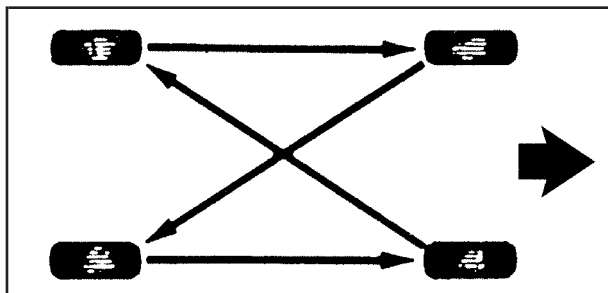

When rotating your vehicle's tires, always use the correct rotation pattern shown here.

After the tires have been rotated, adjust the front and rear inflation pressures as shown on the tire and loading information label, see *Inflation - Tire Pressure* on page 6-54 and *Loading Your Vehicle* on page 5-33.

Vehicles equipped with the Tire Pressure Monitor (TPM) system will need to have the sensors reset after a tire rotation is performed. A special tool is needed to reset the sensor identification codes. See your dealer for service. Make certain that all wheel nuts are properly tightened. See *Wheel Replacement* on page 6-62 and "Wheel Nut Torque" under *Capacities and Specifications* on page 6-86.

CAUTION:

Rust or dirt on a wheel, or on the parts to which it is fastened, can make wheel nuts become loose after a time. The wheel could come off and cause a crash. When you change a wheel, remove any rust or dirt from places where the wheel attaches to the vehicle. In an emergency, you can use a cloth or a paper towel to do this; but be sure to use a scraper or wire brush later, if you need to, to get all the rust or dirt off.

When It Is Time for New Tires

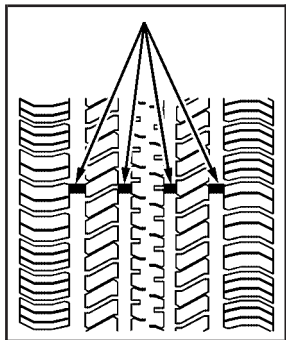

One way to tell when it is time for new tires is to check the treadwear indicators, which will appear when your tires have only 1/16 inch (1.6 mm) or less of tread remaining.

You need a new tire if any of the following statements are true:

- You can see the indicators at three or more places around the tire.
- You can see cord or fabric showing through the tire's rubber.
- The tread or sidewall is cracked, cut, or snagged deep enough to show cord or fabric.
- The tire has a bump, bulge, or split.
- The tire has a puncture, cut or other damage that cannot be repaired well because of the size or location of the damage.

Buying New Tires

GM has developed and matched specific tires for your vehicle. The original equipment tires installed on your vehicle, when it was new, were designed to meet General Motors Tire Performance Criteria Specification (TPC spec) system rating. If you need replacement tires, GM strongly recommends that you get tires with the same TPC Spec rating. This way, your vehicle will continue to have tires that are designed to give the same performance and vehicle safety, during normal use, as the original tires.

GM's exclusive TPC Spec system considers over a dozen critical specifications that impact the overall performance of your vehicle, including brake system performance, ride and handling, traction control, and tire pressure monitoring performance. GM's TPC Spec number is molded onto the tire's sidewall by the tire manufacturer. If the tires have an all-season tread design, the TPC spec number will be followed by an MS for mud and snow. See *Tire Sidewall Labeling on page 6-48* for additional information.

Winter tires with the same speed rating as your original equipment tires may not be available for H, V, W, Y, and ZR speed rated tires. If you choose snow tires with a lower speed rating, never exceed the tire's maximum speed capability.

 **CAUTION:**

Mixing tires could cause you to lose control while driving. If you mix tires of different sizes (other than those originally installed on your vehicle), brands, or types (radial and bias-belted tires), the vehicle may not handle properly, and you could have a crash. Using tires of different sizes (other than those originally installed on your vehicle), brands or types, may also cause damage to your vehicle. Be sure to use the correct size, brand, and type tires on all four wheels.

 **CAUTION:**

If you use bias-ply tires on your vehicle, the wheel rim flanges could develop cracks after many miles of driving. A tire and/or wheel could fail suddenly, causing a crash. Use only radial-ply tires with the wheels on your vehicle.

If you must replace your vehicle's tires with those that do not have a TPC Spec number, make sure they are the same size, load range, speed rating, and construction type (radial and bias-belted tires) as your vehicle's original tires.

Vehicles that have a tire pressure monitoring system may give an inaccurate low-pressure warning if non-TPC spec rated tires are installed on your vehicle. Non-TPC Spec rated tires may give a low-pressure warning that is higher or lower than the proper warning level you would get with TPC Spec rated tires. See *Tire Pressure Monitor System on page 6-55*.

Your vehicle's original equipment tires are listed on the Tire and Loading Information Label. This label is attached to the vehicle's center pillar (B-pillar). See *Loading Your Vehicle on page 5-33* for more information about the Tire and Loading Information Label and its location on your vehicle.

Different Size Tires and Wheels

If you add wheels or tires that are a different size than your original equipment wheels and tires, this may affect the way your vehicle performs, including its braking, ride and handling characteristics, stability and resistance to rollover. Additionally, if your vehicle has electronic systems such as, antilock brakes; traction control; and electronic stability control, the performance of these systems can be affected.

CAUTION:

If you add different sized wheels, your vehicle may not provide an acceptable level of performance and safety if tires not recommended for those wheels are selected. You may increase the chance that you will crash and suffer serious injury. Only use GM specific wheel and tire systems developed for your vehicle, and have them properly installed by a GM certified technician.

See *Buying New Tires on page 6-58* and *Accessories and Modifications on page 6-3* for additional information.

Uniform Tire Quality Grading

Quality grades can be found where applicable on the tire sidewall between tread shoulder and maximum section width. For example:

Treadwear 200 Traction AA Temperature A

The following information relates to the system developed by the United States National Highway Traffic Safety Administration, which grades tires by treadwear, traction and temperature performance. (This applies only to vehicles sold in the United States.) The grades are molded on the sidewalls of most passenger car tires. The Uniform Tire Quality Grading system does not apply to deep tread, winter-type snow tires, space-saver or temporary use spare tires, tires with nominal rim diameters of 10 to 12 inches (25 to 30 cm), or to some limited-production tires.

While the tires available on General Motors passenger cars and light trucks may vary with respect to these grades, they must also conform to federal safety requirements and additional General Motors Tire Performance Criteria (TPC) standards.

Treadwear

The treadwear grade is a comparative rating based on the wear rate of the tire when tested under controlled conditions on a specified government test course. For example, a tire graded 150 would wear one and a half (1.5) times as well on the government course as a tire graded 100. The relative performance of tires depends upon the actual conditions of their use, however, and may depart significantly from the norm due to variations in driving habits, service practices and differences in road characteristics and climate.

Traction – AA, A, B, C

The traction grades, from highest to lowest, are AA, A, B, and C. Those grades represent the tire's ability to stop on wet pavement as measured under controlled conditions on specified government test surfaces of asphalt and concrete. A tire marked C may have poor traction performance. Warning: The traction grade assigned to this tire is based on straight-ahead braking traction tests, and does not include acceleration, cornering, hydroplaning, or peak traction characteristics.

Temperature – A, B, C

The temperature grades are A (the highest), B, and C, representing the tire's resistance to the generation of heat and its ability to dissipate heat when tested under controlled conditions on a specified indoor laboratory test wheel. Sustained high temperature can cause the material of the tire to degenerate and reduce tire life, and excessive temperature can lead to sudden tire failure. The grade C corresponds to a level of performance which all passenger car tires must meet under the Federal Motor Vehicle Safety Standard No. 109. Grades B and A represent higher levels of performance on the laboratory test wheel than the minimum required by law.

Warning: The temperature grade for this tire is established for a tire that is properly inflated and not overloaded. Excessive speed, underinflation, or excessive loading, either separately or in combination, can cause heat buildup and possible tire failure.

Wheel Alignment and Tire Balance

The tires and wheels on your vehicle were aligned and balanced carefully at the factory to give you the longest tire life and best overall performance. Adjustments to wheel alignment and tire balancing will not be necessary on a regular basis. However, if you notice unusual tire wear or your vehicle pulling to one side or the other, the alignment may need to be checked. If you notice your vehicle vibrating when driving on a smooth road, your tires and wheels may need to be rebalanced. See your dealer for proper diagnosis.

Wheel Replacement

Replace any wheel that is bent, cracked, or badly rusted or corroded. If wheel nuts keep coming loose, the wheel, wheel bolts and wheel nuts should be replaced. If the wheel leaks air, replace it (except some aluminum wheels, which can sometimes be repaired). See your dealer if any of these conditions exist.

Your dealer will know the kind of wheel you need.

Each new wheel should have the same load-carrying capacity, diameter, width, offset and be mounted the same way as the one it replaces.

If you need to replace any of your wheels, wheel bolts or wheel nuts, replace them only with new GM original equipment parts. This way, you will be sure to have the right wheel, wheel bolts and wheel nuts for your vehicle.

CAUTION:

Using the wrong replacement wheels, wheel bolts, or wheel nuts on your vehicle can be dangerous. It could affect the braking and handling of your vehicle, make your tires lose air and make you lose control. You could have a collision in which you or others could be injured. Always use the correct wheel, wheel bolts and wheel nuts for replacement.

Notice: The wrong wheel can also cause problems with bearing life, brake cooling, speedometer or odometer calibration, headlamp aim, bumper height, vehicle ground clearance and tire clearance to the body and chassis.

 **CAUTION:**

Rust or dirt on a wheel, or on the parts to which it is fastened, can make wheel nuts become loose after a time. The wheel could come off and cause a crash. When you change a wheel, remove any rust or dirt from places where the wheel attaches to the vehicle. In an emergency, you can use a cloth or a paper towel to do this; but be sure to use a scraper or wire brush later, if you need to, to get all the rust or dirt off.

 **CAUTION:**

Never use oil or grease on studs or the threads of the wheel nuts. If you do, the wheel nuts might come loose and the wheel could fall off, causing a crash.

 **CAUTION:**

Incorrect wheel nuts or improperly tightened wheel nuts can cause the wheel to become loose and even come off. This could lead to a crash. Be sure to use the correct wheel nuts. If you have to replace them, be sure to get new GM original equipment wheel nuts.

Notice: Improperly tightened wheel nuts can lead to brake pulsation and rotor damage. To avoid expensive brake repairs, evenly tighten the wheel nuts in the proper sequence and to the proper torque specification.

Used Replacement Wheels

CAUTION:

Putting a used wheel on your vehicle is dangerous. You cannot know how it has been used or how far it has been driven. It could fail suddenly and cause a crash. If you have to replace a wheel, use a new GM original equipment wheel.

Tire Chains

CAUTION:

Do not use tire chains. There is not enough clearance. Tire chains used on a vehicle without the proper amount of clearance can cause damage to the brakes, suspension or other vehicle parts. The area damaged by the tire chains could cause you to lose control of your vehicle and you or others may be injured in a crash. Use another type of traction device only if its manufacturer recommends it for use on your vehicle and tire size combination and road conditions. Follow that manufacturer's instructions. To help avoid damage to your vehicle, drive slowly, re-adjust or remove the device if it is contacting your vehicle, and do not spin your wheels. If you do find traction devices that will fit, install them on the rear tires.

Lifting Your Vehicle

CAUTION:

Lifting a vehicle can cause an injury. The vehicle can slip off the jack and roll over you or other people. You and they could be badly injured. Find a level place to lift your vehicle.

To help prevent the vehicle from moving:

1. Set the parking brake firmly.
2. Put an automatic transmission shift lever in PARK (P).
3. Turn off the engine.

To be even more certain the vehicle won't move, you can put blocks in front of and behind the wheels.

CAUTION:

Getting under a vehicle when it is jacked up is dangerous. If the vehicle slips off the jack, you could be badly injured or killed. Never get under a vehicle when it is supported only by a jack.

CAUTION:

Raising your vehicle with the jack improperly positioned can damage the vehicle and even make the vehicle fall. To help avoid personal injury and vehicle damage, be sure to place the jack in the proper location before raising the vehicle.

If you ever use a jack to lift your vehicle, follow the instructions that came with the jack, and be sure to use the correct lifting points to avoid damaging your vehicle.

Notice: Lifting your vehicle improperly can damage your vehicle and result in costly repairs not covered by your warranty. To lift your vehicle properly, follow the advice in this part.

To help prevent vehicle damage:

- Be sure to place a block or pad between the jack and the vehicle.
- Make sure the jack you are using spans at least two crossmember ribs.
- Lift only in the areas shown in the following pictures.

For additional information, see your GM dealer and the Cadillac XLR service manual.

Lifting From the Front

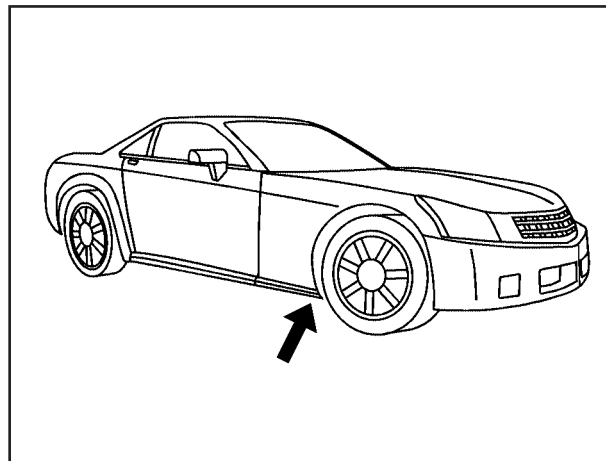

The front lifting points can be accessed from either side of your vehicle, behind the front tires.

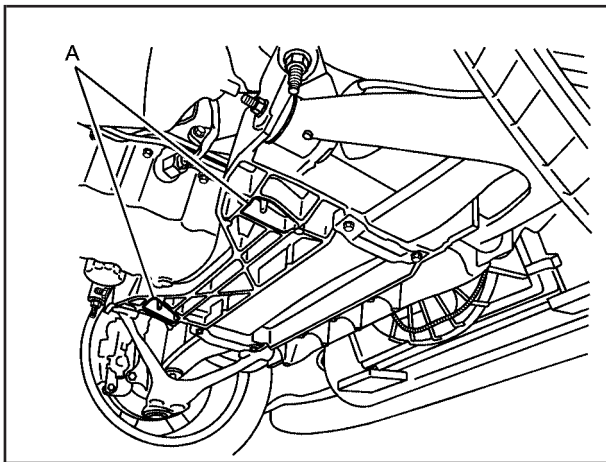

1. Locate the front lifting points (A), according to the illustration shown.
2. Be sure to place a block or pad between the jack and the vehicle.

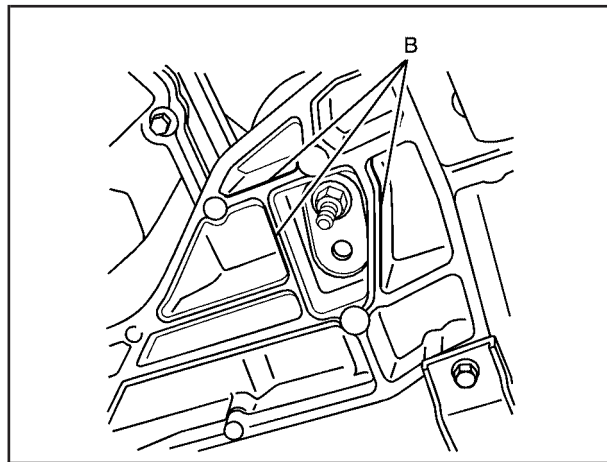

3. Lift the vehicle with the jack, making sure the jack spans at least two of the crossmember ribs (B).

Lifting From the Rear

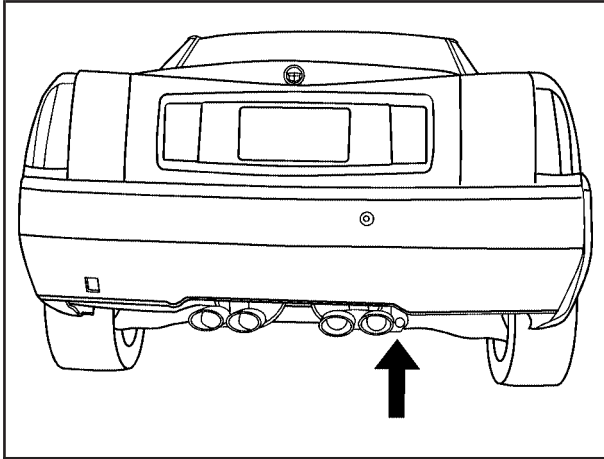

The rear lifting points can be accessed from the rear of the vehicle, on either the driver's or passenger's side.

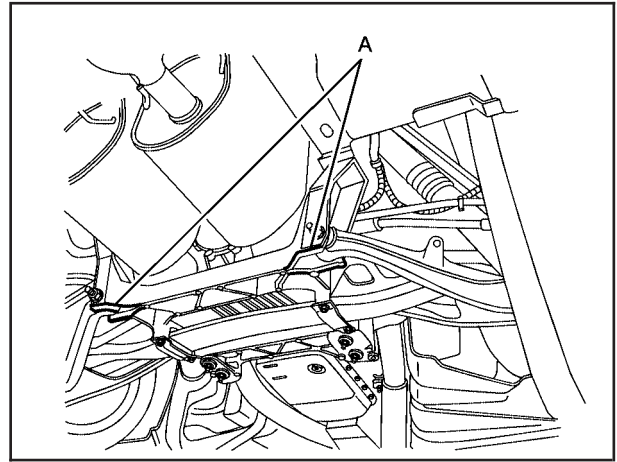

1. Locate the rear lifting points (A), according to the illustration shown.
2. Be sure to place a block or pad between the jack and the vehicle.

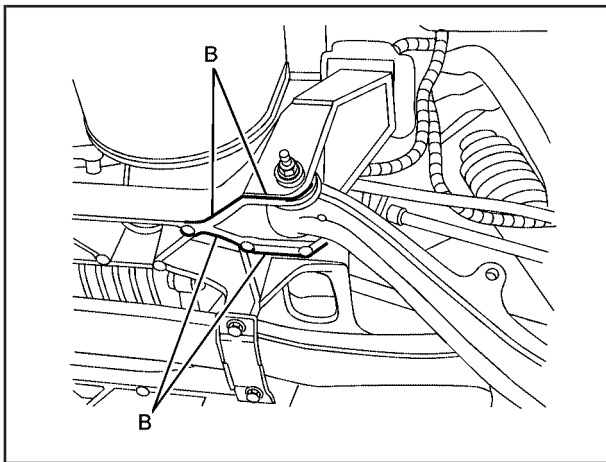

3. Lift the vehicle with the jack, making sure the jack spans at least two of the crossmember ribs (B).

For more information, see *Doing Your Own Service Work* on page 6-4.

If a Tire Goes Flat

It is unusual for a tire to “blow out” while you are driving, especially if you maintain your tires properly. If air goes out of a tire, it is much more likely to leak out slowly. See *Tires* on page 6-47 for additional information.

Your vehicle, when new, had run-flat tires. This type of tire can operate effectively with no air pressure, so you will not need to stop on the side of the road to change a flat tire. You can just keep on driving. The shorter the distance you drive and the slower the speed, the greater the chance that the run-flat tire will not have to be replaced. Run-flat tires perform so well without any air that a Tire Pressure Monitor (TPM) is used to alert you if a tire has lost pressure. See *Run-Flat Tires* on page 6-52 and *Tire Pressure Monitor System* on page 6-55.

 **CAUTION:**

When the TIRE FLAT MAX SPD 55, REDUCED HNDLG message is displayed on the Driver Information Center, your vehicle's handling capabilities will be reduced during severe maneuvers. If you drive too fast, you could lose control of your vehicle. You or others could be injured. Don't drive over 55 mph (90 km/h) when the TIRE FLAT MAX SPD 55, REDUCED HNDLG message is displayed. Drive cautiously and check your tire pressures as soon as you can.

If the TPM system detects a tire pressure below 5 psi (34 kPa), the TIRE FLAT MAX SPD 55, REDUCED HNDLG warning message is displayed on the Driver Information Center (DIC). See *DIC Controls and Displays on page 3-64* and *DIC Warnings and Messages on page 3-67* for information and details about the DIC operation and displays.

 **CAUTION:**

Special tools and procedures are required to service a run-flat tire. If these special tools and procedures are not used you or others could be injured and your vehicle could be damaged. Always be sure the proper tools and procedures, as described in the service manual, are used.

Notice: Using liquid sealants can damage the tire valves and tire pressure monitor sensors in your vehicle's run-flat tires. This damage would not be covered by warranty. Do not use liquid sealants in your vehicle's run-flat tires.

To order a service manual, see *Service Publications Ordering Information on page 8-14*.

If a tire goes flat, the stability control system will turn on automatically even if it was disabled by the driver. When a flat tire condition exists the StabiliTrak[®] system cannot be turned off. See *StabiliTrak[®] System on page 5-11*.

Appearance Care

Cleaning the Inside of Your Vehicle

Your vehicle's interior will continue to look its best if it is cleaned often. Although not always visible, dust and dirt can accumulate on your upholstery. Dirt can damage carpet, fabric, leather, and plastic surfaces. Regular vacuuming is recommended to remove particles from your upholstery. It is important to keep your upholstery from becoming and remaining heavily soiled. Soils should be removed as quickly as possible. Your vehicle's interior may experience extremes of heat that could cause stains to set rapidly.

Lighter colored interiors may require more frequent cleaning. Use care because newspapers and garments that transfer color to your home furnishings may also transfer color to your vehicle's interior.

When cleaning your vehicle's interior, only use cleaners specifically designed for the surfaces being cleaned. Permanent damage may result from using cleaners on surfaces for which they were not intended. Use glass cleaner only on glass. Remove any accidental over-spray from other surfaces immediately. To prevent over-spray, apply cleaner directly to the cleaning cloth.

Notice: If you use abrasive cleaners when cleaning glass surfaces on your vehicle, you could scratch the glass and/or cause damage to the integrated radio antenna and the rear window defogger. When cleaning the glass on your vehicle, use only a soft cloth and glass cleaner.

Many cleaners contain solvents that may become concentrated in your vehicle's breathing space. Before using cleaners, read and adhere to all safety instructions on the label. While cleaning your vehicle's interior, maintain adequate ventilation by opening your vehicle's doors and windows.

Dust may be removed from small buttons and knobs using a small brush with soft bristles.

Your GM dealer has a product for cleaning your vehicle's glass. Should it become necessary, you can also obtain a product from your GM dealer to remove odors from your vehicle's upholstery.

Do not clean your vehicle using the following cleaners or techniques:

- Never use a knife or any other sharp object to remove a soil from any interior surface.
- Never use a stiff brush. It can cause damage to your vehicle's interior surfaces.
- Never apply heavy pressure or rub aggressively with a cleaning cloth. Use of heavy pressure can damage your interior and does not improve the effectiveness of soil removal.
- Use only mild, neutral-pH soaps. Avoid laundry detergents or dishwashing soaps with degreasers. Using too much soap will leave a residue that leaves streaks and attracts dirt. For liquid cleaners, about 20 drops per gallon (3.78 L) of water is a good guide.
- Do not heavily saturate your upholstery while cleaning.
- Damage to your vehicle's interior may result from the use of many organic solvents such as naphtha, alcohol, etc.

Fabric/Carpet

Use a vacuum cleaner with a soft brush attachment frequently to remove dust and loose dirt. A canister vacuum with a beater bar in the nozzle may only be used on floor carpet and carpeted floor mats. For soils, always try to remove them first with plain water or club soda. Before cleaning, gently remove as much of the soil as possible using one of the following techniques:

- For liquids: gently blot the remaining soil with a paper towel. Allow the soil to absorb into the paper towel until no more can be removed.
- For solid dry soils: remove as much as possible and then vacuum.

To clean, use the following instructions:

1. Saturate a lint-free, clean white cloth with water or club soda.
2. Wring the cloth to remove excess moisture.
3. Start on the outside edge of the soil and gently rub toward the center. Continue cleaning, using a clean area of the cloth each time it becomes soiled.
4. Continue to gently rub the soiled area until the cleaning cloth remains clean.
5. If the soil is not completely removed, use a mild soap solution and repeat the cleaning process that was used with plain water.

If any of the soil remains, a commercial fabric cleaner or spot lifter may be necessary. When a commercial upholstery cleaner or spot lifter is to be used, test a small hidden area for colorfastness first. If the locally cleaned area gives any impression that a ring formation may result, clean the entire surface.

After the cleaning process has been completed, a paper towel can be used to blot excess moisture from the fabric or carpet.

Leather

A soft cloth dampened with water may be used to remove dust. If a more thorough cleaning is necessary, a soft cloth dampened with a mild soap solution can be used. Allow the leather to dry naturally. Do not use heat to dry. Never use steam to clean leather.

Never use spot lifters or spot removers on leather. Many commercial leather cleaners and coatings that are sold to preserve and protect leather may permanently change the appearance and feel of your leather and are not recommended. Do not use silicone or wax-based products, or those containing organic solvents to clean your vehicle's interior because they can alter the appearance by increasing the gloss in a non-uniform manner. Never use shoe polish on your leather.

Instrument Panel, Vinyl, and Other Plastic Surfaces

A soft cloth dampened with water may be used to remove dust. If a more thorough cleaning is necessary, a clean soft cloth dampened with a mild soap solution can be used to gently remove dust and dirt. Never use spot lifters or removers on plastic surfaces. Many commercial cleaners and coatings that are sold to preserve and protect soft plastic surfaces may permanently change the appearance and feel of your interior and are not recommended. Do not use silicone or wax-based products, or those containing organic solvents to clean your vehicle's interior because they can alter the appearance by increasing the gloss in a non-uniform manner.

Some commercial products may increase gloss on your instrument panel. The increase in gloss may cause annoying reflections in the windshield and even make it difficult to see through the windshield under certain conditions.

Wood Panels

Use a clean cloth moistened in warm, soapy water (use mild dish washing soap). Dry the wood immediately with a clean cloth.

Speaker Covers

Vacuum around a speaker cover gently, so that the speaker will not be damaged. Clean spots with just water and mild soap.

Care of Safety Belts

Keep belts clean and dry.

CAUTION:

Do not bleach or dye safety belts. If you do, it may severely weaken them. In a crash, they might not be able to provide adequate protection. Clean safety belts only with mild soap and lukewarm water.

Weatherstrips

Silicone grease on weatherstrips will make them last longer, seal better, and not stick or squeak. Apply silicone grease with a clean cloth. During very cold, damp weather frequent application may be required. See *Recommended Fluids and Lubricants on page 7-11*.

Washing Your Vehicle

The paint finish on the vehicle provides beauty, depth of color, gloss retention, and durability.

The best way to preserve the vehicle's finish is to keep it clean by washing it often with lukewarm or cold water.

Do not wash the vehicle in the direct rays of the sun. Use a car washing soap. Do not use strong soaps or chemical detergents. Be sure to rinse the vehicle well, removing all soap residue completely. GM-approved cleaning products can be obtained from your dealer. See *Vehicle Care/Appearance Materials on page 6-78*. Do not use cleaning agents that are petroleum based, or that contain acid or abrasives. All cleaning agents should be flushed promptly and not allowed to dry on the surface, or they could stain. Dry the finish with a soft, clean chamois or an all-cotton towel to avoid surface scratches and water spotting.

Notice: If you drive your vehicle through an automatic car wash that does not have enough clearance for the wide rear tires and wheels, you could damage your vehicle. Verify with the manager of the car wash that your vehicle will fit before entering the car wash or use a touchless car wash.

High pressure car washes may cause water to enter the vehicle.

Cleaning Exterior Lamps/Lenses

Use only lukewarm or cold water, a soft cloth and a car washing soap to clean exterior lamps and lenses. Follow instructions under *Washing Your Vehicle on page 6-74*.

Finish Care

Occasional waxing or mild polishing of the vehicle by hand may be necessary to remove residue from the paint finish. GM-approved cleaning products can be obtained from your dealer. See *Vehicle Care/Appearance Materials on page 6-78*.

Notice: Machine compounding or aggressive polishing on a basecoat/clearcoat paint finish may damage it. Use only non-abrasive waxes and polishes that are made for a basecoat/clearcoat paint finish on your vehicle.

The vehicle has a “basecoat/clearcoat” paint finish. The clearcoat gives more depth and gloss to the colored basecoat. Always use waxes and polishes that are non-abrasive and made for a basecoat/clearcoat paint finish.

Foreign materials such as calcium chloride and other salts, ice melting agents, road oil and tar, tree sap, bird droppings, chemicals from industrial chimneys, etc.,

can damage the vehicle’s finish if they remain on painted surfaces. Wash the vehicle as soon as possible. If necessary, use non-abrasive cleaners that are marked safe for painted surfaces to remove foreign matter.

Exterior painted surfaces are subject to aging, weather, and chemical fallout that can take their toll over a period of years. To help keep the paint finish looking new, keep the vehicle in a garage or covered whenever possible.

Windshield and Wiper Blades

If the windshield is not clear after using the windshield washer, or if the wiper blade chatters when running, wax, sap, or other material may be on the blade or windshield.

Clean the outside of the windshield with a glass cleaning liquid or powder and water solution. The windshield is clean if beads do not form when it is rinsed with water.

Grime from the windshield will stick to the wiper blades and affect their performance. Clean the blade by wiping vigorously with a cloth soaked in full-strength windshield washer solvent. Then rinse the blade with water.

Check the wiper blades and clean them as necessary; replace blades that look worn.

Aluminum or Chrome-Plated Wheels

The vehicle may be equipped with either aluminum or chrome-plated wheels.

Keep the wheels clean using a soft clean cloth with mild soap and water. Rinse with clean water. After rinsing thoroughly, dry with a soft clean towel. A wax may then be applied.

Notice: If you use strong soaps, chemicals, abrasive polishes, cleaners, brushes, or cleaners that contain acid on aluminum or chrome-plated wheels, you could damage the surface of the wheel(s). The repairs would not be covered by your warranty. Use only GM-approved cleaners on aluminum or chrome-plated wheels.

The surface of these wheels is similar to the painted surface of your vehicle. Do not use strong soaps, chemicals, abrasive polishes, abrasive cleaners, cleaners with acid, or abrasive cleaning brushes on them because you could damage the surface. Do not use chrome polish on aluminum wheels.

Notice: Using chrome polish on aluminum wheels could damage the wheels. The repairs would not be covered by your warranty. Use chrome polish on chrome wheels only.

Use chrome polish only on chrome-plated wheels, but avoid any painted surface of the wheel, and buff off immediately after application.

Notice: If you drive your vehicle through an automatic car wash that has silicone carbide tire cleaning brushes, you could damage the aluminum or chrome-plated wheels. The repairs would not be covered by your warranty. Never drive a vehicle equipped with aluminum or chrome-plated wheels through an automatic car wash that uses silicone carbide tire cleaning brushes.

Do not take your vehicle through an automatic car wash that has silicone carbide tire cleaning brushes. These brushes can also damage the surface of these wheels.

Tires

To clean the tires, use a stiff brush with tire cleaner.

Notice: Using petroleum-based tire dressing products on your vehicle may damage the paint finish and/or tires. When applying a tire dressing, always wipe off any overspray from all painted surfaces on your vehicle.

Sheet Metal Damage

If the vehicle is damaged and requires sheet metal repair or replacement, make sure the body repair shop applies anti-corrosion material to parts repaired or replaced to restore corrosion protection.

Original manufacturer replacement parts will provide the corrosion protection while maintaining the warranty.

Finish Damage

Any stone chips, fractures or deep scratches in the finish should be repaired right away.

Minor chips and scratches can be repaired with touch-up materials available from your dealer or other service outlets. Larger areas of finish damage can be corrected in your dealer's body and paint shop.

Underbody Maintenance

Chemicals used for ice and snow removal and dust control can collect on the underbody. If these are not removed, corrosion and rust can develop on the underbody parts such as fuel lines, frame, floor pan, and exhaust system even though they have corrosion protection.

At least every spring, flush these materials from the underbody with plain water. Clean any areas where mud and debris can collect. Dirt packed in close areas of the frame should be loosened before being flushed. Your dealer or an underbody car washing system can do this for you.

Chemical Paint Spotting

Some weather and atmospheric conditions can create a chemical fallout. Airborne pollutants can fall upon and attack painted surfaces on the vehicle. This damage can take two forms: blotchy, ring-shaped discolorations, and small, irregular dark spots etched into the paint surface.

Although no defect in the paint job causes this, GM will repair, at no charge to the owner, the surfaces of new vehicles damaged by this fallout condition within 12 months or 12,000 miles (20 000 km) of purchase, whichever occurs first.

Vehicle Care/Appearance Materials

Description	Usage
Polishing Cloth Wax-Treated	Interior and exterior polishing cloth.
Tar and Road Oil Remover	Removes tar, road oil, and asphalt.
Chrome Cleaner and Polish	Use on chrome or stainless steel.
White Sidewall Tire Cleaner	Removes soil and black marks from whitewalls.
Vinyl Cleaner	Cleans vinyl.
Glass Cleaner	Removes dirt, grime, smoke and fingerprints.
Chrome and Wire Wheel Cleaner	Removes dirt and grime from chrome wheels and wire wheel covers.
Finish Enhancer	Removes dust, fingerprints, and surface contaminants. Spray on and wipe off.

Description	Usage
Swirl Remover Polish	Removes swirl marks, fine scratches, and other light surface contamination.
Cleaner Wax	Removes light scratches and protects finish.
Foaming Tire Shine Low Gloss	Cleans, shines, and protects in one step. No wiping necessary.
Wash Wax Concentrate	Medium foaming shampoo. Cleans and lightly waxes. Biodegradable and phosphate free.
Spot Lifter	Quickly removes spots and stains from carpets, vinyl, and cloth upholstery.
Odor Eliminator	Odorless spray odor eliminator used on fabrics, vinyl, leather and carpet.

Vehicle Identification

Vehicle Identification Number (VIN)



This is the legal identifier for your vehicle. It appears on a plate in the front corner of the instrument panel, on the driver's side. You can see it if you look through the windshield from outside your vehicle. The VIN also appears on the Vehicle Certification and Service Parts labels and the certificates of title and registration.

Engine Identification

The eighth character in the VIN is the engine code. This code will help you identify your vehicle's engine, specifications, and replacement parts.

Service Parts Identification Label

You will find this label on your spare tire cover. It is very helpful if you ever need to order parts. On this label, you will find the following:

- VIN
- Model designation
- Paint information
- Production options and special equipment

Be sure that this label is not removed from the vehicle.

Electrical System

Add-On Electrical Equipment

Notice: Don't add anything electrical to your vehicle unless you check with your dealer first. Some electrical equipment can damage your vehicle and the damage wouldn't be covered by your warranty. Some add-on electrical equipment can keep other components from working as they should.

Your vehicle has an airbag system. Before attempting to add anything electrical to your vehicle, see *Servicing Your Airbag-Equipped Vehicle on page 1-44*.

Windshield Wiper Fuses

The windshield wiper motor is protected by an internal circuit breaker. If the wiper motor overheats due to heavy snow, the wipers will stop until the motor cools and will then restart.

A fuse powers the wiper motor. If the fuse blows, there is an electrical problem. Be sure to have it fixed.

Power Windows and Other Power Options

Circuit breakers protect the power windows and power seats. When the current load is too heavy, the circuit breaker opens and closes, protecting the circuit until the problem is fixed or goes away.

Fuses and Circuit Breakers

The wiring circuits in your vehicle are protected from short circuits by a combination of fuses and circuit breakers. This greatly reduces the chance of fires caused by electrical problems.

Look at the silver-colored band inside the fuse. If the band is broken or melted, replace the fuse. Be sure you replace a bad fuse with a new one of the identical size and rating. If a fuse should blow, see your dealer for service immediately.

If you ever have a problem on the road and do not have a spare fuse, you can "borrow" one that has the same amperage. Pick some feature of your vehicle that you can get along without – like the radio or cigarette lighter – and use its fuse, if it is the correct amperage. Replace it as soon as you can.

Instrument Panel Fuse Block

The panel fuse block is located on the passenger's side of the vehicle, under the instrument panel and under the toe-board.

Remove the carpet and toe-board covering to access the fuse block by pulling at the top of each corner of the panel. Then turn the fuse block door knob counterclockwise and pull the door to access the fuses.

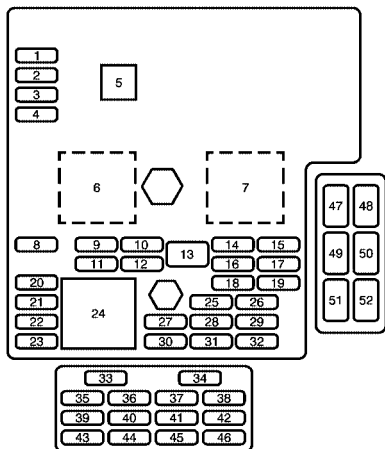

Fuses	Usage
1	Spare Fuse
2	Spare Fuse
3	Spare Fuse
4	Spare Fuse
5	Fuse Pull
6	Reverse Lamp
7	Starter/Crank
8	Parking Brake Solenoid A
9	Reverse Lamps
10	BTSl Solenoid, Column Lock
11	Not Used
12	Not Used
13	GMLAN Devices
14	Rear Park Aid, Heated/Cooled Seats, Windshield Wiper Relays
15	Door Locks
16	Engine Control Module
17	Interior Lights
18	Airbags
19	Not Used

Fuses	Usage
20	OnStar [®]
21	Adaptive Cruise Control (ACC), Driver Door Switch
22	Power Tilt Wheel, Telescopic Steering Column, Memory Seat, Driver Seat Switch, Retractable Hardtop Switch
23	Ignition Switch, Intrusion Sensor
24	Stop Lamp
25	Inside Rearview Mirror, Climate Control System, Column Lock, Power Sounder
26	Instrument Panel Cluster, Head-Up Display (HUD)
27	Radio, S-Band, CD Changer
28	Tap-Up/Tap-Down Switch
29	Climate Control System, Power Sounder
30	Rear Fog Lamps, Diagnostic Link Connector
31	Power Folding Mirror
32	Trunk Close Button, Parking Brake Solenoid B
33	Power Seats

Fuses	Usage
34	Door Controls
35	Run, Accessory Power
36	Not Used
37	Not Used
38	Rainsense [™]
39	Steering Wheel Control Button Lights
40	Power Lumbar
41	Passenger's Side Heated Seat
42	Driver's Side Heated Seat
43	Not Used
44	Retractable Hardtop, Trunk Latch
45	Auxiliary Power
46	Cigar Lighter
47	Park Brake Hold
48	Park Brake Release
49	Not Used
50	Not Used
51	Not Used
52	Fuel Door

Underhood Fuse Block

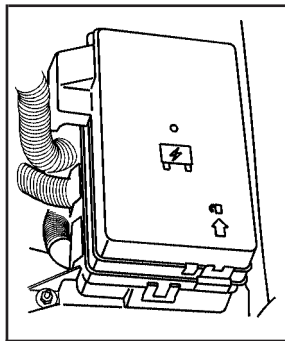

The underhood fuse block is located next to the engine on the passenger's side of the vehicle.

For more information on location, see *Engine Compartment Overview* on page 6-12.

To access the fuses, push in the tab located at the end of the fuse block cover. Then lift the cover open.

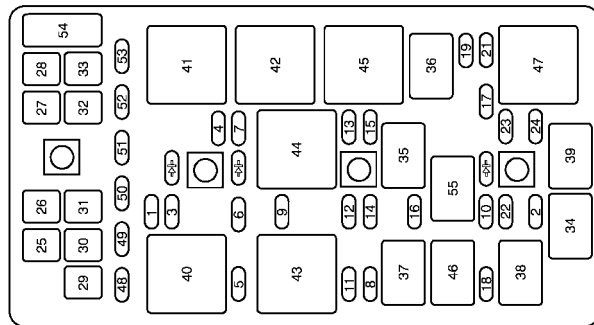



Fuses	Usage
1	Anti-lock Brake System, Electronic Suspension Control
2	Horn
3	Adaptive Cruise Control (ACC), Transmission Controls
4	Windshield Wipers
5	Stop/Back-Up Lamps
6	Oxygen Sensor
7	Battery 5

Fuses	Usage
8	Parking Lamps
9	Electronic Throttle Control
10	Fuel Pump
11	Engine Control Module, Transmission Control Module
12	Odd Injectors
13	Electronic Suspension Control
14	Emission Controls
15	Air Conditioning Compressor
16	Even Injectors
17	Windshield Washer, Intercooler Pump
18	Headlamp Washer
19	Right Low Beam Headlamp
20	Not Used
21	Left Low Beam Headlamp
22	Fog Lamp
23	Right High Beam Headlamp
24	Left High Beam Headlamp

Fuses	Usage
25	Cooling Fan
26	Battery 3
27	Anti-lock Brakes
28	Climate Controls
29	Battery 2
30	Starter
31	Audio Amplifier
32	Not Used
33	Battery 1
48	Spare
49	Spare
50	Spare
51	Spare
52	Spare
53	Not Used
54	Fuse Puller

Relays	Usage
34	Horn
35	Air Conditioning Compressor
36	Windshield Washer
37	Parking Lamps
38	Fog Lamps
39	High Beam Headlamps
40	Rear Window Defogger
41	Windshield Wiper High/Low
42	Wiper RUN/ACCESSORY Power
43	Starter/Crank
44	Ignition 1

Relays	Usage
45	Windshield Wiper On/Off
46	Headlamp Washer
47	Low Beam Headlamps
55	Fuel Pump

Diodes	Usage
	Diode 1
	Wiper Diode
	Diode 2

Capacities and Specifications

The following approximate capacities are given in English and metric conversions. Please refer to *Recommended Fluids and Lubricants on page 7-11* for more information.

Application	Capacities	
	English	Metric
Automatic Transmission		
5-Speed Automatic	9.5 qt	9.0 L
Cooling System	12.6 qt	12.0 L
Engine Oil with Filter	8.0 qt	7.6 L
Fuel Tank	18.0 gal	68.0 L
Intercooler System	2.1 qt	2.0 L
Wheel Nut Torque	100 ft lb	140 N•m
All capacities are approximate. When adding, be sure to fill to the approximate level as recommended in this manual. Recheck fluid level after filling.		

Engine Specifications

Engine	VIN Code	Transmission	Spark Plug Gap
4.6L V8	A	Automatic	0.040 inches (1.02 mm)

Section 7 Maintenance Schedule

Maintenance Schedule	7-2	Owner Checks and Services	7-8
Introduction	7-2	At Each Fuel Fill	7-8
Maintenance Requirements	7-2	At Least Once a Month	7-8
Your Vehicle and the Environment	7-2	At Least Once a Year	7-9
Using the Maintenance Schedule	7-2	Recommended Fluids and Lubricants	7-11
Scheduled Maintenance	7-4	Normal Maintenance Replacement Parts	7-13
Additional Required Services	7-6	Maintenance Record	7-14
Maintenance Footnotes	7-7		

Maintenance Schedule

Introduction

Important: Keep engine oil at the proper level and change as recommended.



Have you purchased the GM Protection Plan? The Plan supplements your new vehicle warranties. See your Warranty and Owner Assistance booklet or your dealer for details.

Maintenance Requirements

Notice: Maintenance intervals, checks, inspections, replacement parts, and recommended fluids and lubricants as prescribed in this manual are necessary to keep your vehicle in good working condition. Any damage caused by failure to follow scheduled maintenance may not be covered by warranty.

Your Vehicle and the Environment

Proper vehicle maintenance not only helps to keep your vehicle in good working condition, but also helps the environment. All recommended maintenance is important. Improper vehicle maintenance can even affect the quality of the air we breathe. Improper fluid levels or the wrong tire inflation can increase the level of emissions from your vehicle. To help protect our environment, and to keep your vehicle in good condition, be sure to maintain your vehicle properly.

Using the Maintenance Schedule

We at General Motors want to help you keep your vehicle in good working condition. But we do not know exactly how you will drive it. You may drive very short distances only a few times a week. Or you may drive long distances all the time in very hot, dusty weather. You may use your vehicle in making deliveries. Or you may drive it to work, to do errands, or in many other ways.

Because of all the different ways people use their vehicles, maintenance needs vary. You may need more frequent checks and replacements. So please read the following and note how you drive. If you have any questions on how to keep your vehicle in good condition, see your GM Goodwrench[®] dealer.

This schedule is for vehicles that:

- carry passengers and cargo within recommended limits. You will find these limits on the tire and loading information label. See *Loading Your Vehicle on page 5-33*.
- are driven on reasonable road surfaces within legal driving limits.
- use the recommended fuel. See *Gasoline Octane on page 6-5*.

The services in *Scheduled Maintenance on page 7-4* should be performed when indicated. See *Additional Required Services on page 7-6* and *Maintenance Footnotes on page 7-7* for further information.

 **CAUTION:**

Performing maintenance work on a vehicle can be dangerous. In trying to do some jobs, you can be seriously injured. Do your own maintenance work only if you have the required know-how and the proper tools and equipment for the job. If you have any doubt, see your GM Goodwrench® dealer to have a qualified technician do the work.

Some maintenance services can be complex. So, unless you are technically qualified and have the necessary equipment, you should have your GM Goodwrench® dealer do these jobs.

When you go to your GM Goodwrench® dealer for your service needs, you will know that GM-trained and supported service technicians will perform the work using genuine GM parts.

If you want to purchase service information, see *Service Publications Ordering Information on page 8-14*.

Owner Checks and Services on page 7-8 tells you what should be checked, when to check it, and what you can easily do to help keep your vehicle in good condition.

The proper replacement parts, fluids, and lubricants to use are listed in *Recommended Fluids and Lubricants on page 7-11* and *Normal Maintenance Replacement Parts on page 7-13*. When your vehicle is serviced, make sure these are used. All parts should be replaced and all necessary repairs done before you or anyone else drives the vehicle. We recommend the use of genuine GM parts.

Scheduled Maintenance

When the CHANGE OIL NOW message in the Driver Information Center (DIC) comes on, it means that service is required for your vehicle. Have your vehicle serviced as soon as possible within the next 600 miles (1 000 km). It is possible that, if you are driving under the best conditions, the engine oil life system may not indicate that vehicle service is necessary for over a year. However, your engine oil and filter must be changed at least once a year and at this time the system must be reset. Your GM Goodwrench® dealer has GM-trained service technicians who will perform this work using genuine GM parts and reset the system.

If the engine oil life system is ever reset accidentally, you must service your vehicle within 3,000 miles (5 000 km) since your last service. Remember to reset the oil life system whenever the oil is changed. See *Engine Oil Life System on page 6-16* for information on the Engine Oil Life System and resetting the system.

When the CHANGE OIL NOW message appears, certain services, checks, and inspections are required. Required services are described in the following for “Maintenance I” and “Maintenance II.” Generally, it is recommended that your first service be Maintenance I, your second service be Maintenance II, and that you alternate Maintenance I and Maintenance II thereafter. However, in some cases, Maintenance II may be required more often.

Maintenance I — Use Maintenance I if the CHANGE OIL NOW message comes on within 10 months since the vehicle was purchased or Maintenance II was performed.

Maintenance II — Use Maintenance II if the previous service performed was Maintenance I. Always use Maintenance II whenever the message comes on 10 months or more since the last service or if the message has not come on at all for one year.

Scheduled Maintenance

Service	Maintenance I	Maintenance II
Change engine oil and filter. See <i>Engine Oil</i> on page 6-13. Reset oil life system. See <i>Engine Oil Life System</i> on page 6-16. An <i>Emission Control Service</i> .	•	•
Visually check for any leaks or damage. See <i>footnote (a)</i> .	•	•
Inspect engine air cleaner filter. If necessary, replace filter. See <i>Engine Air Cleaner/Filter</i> on page 6-18. See <i>footnote (h)</i> .		•
Check engine coolant and windshield washer fluid levels.	•	•
Perform any needed additional services. See “Additional Required Services” in this section.	•	•
Inspect wiper blades. See <i>footnote (b)</i> .		•
Inspect restraint system components. See <i>footnote (c)</i> .		•
Lubricate body components. See <i>footnote (d)</i> .		•
Replace passenger compartment air filter. See <i>footnote (e)</i> .		•

Additional Required Services

The following services should be performed at the first maintenance service (I or II) after the indicated miles (kilometers) shown for each item.

Additional Required Services

Service and Miles (Kilometers)	25,000 (41 500)	50,000 (83 000)	75,000 (125 000)	100,000 (166 000)	125,000 (207 500)	150,000 (240 000)
Inspect fuel system for damage or leaks.		•		•		•
Inspect exhaust system for loose or damaged components.				•		
Replace engine air cleaner filter. See <i>Engine Air Cleaner/Filter on page 6-18.</i>		•		•		•
Change automatic transmission fluid and filter (severe service). See footnote (f).		•		•		•
Change automatic transmission fluid and filter (normal service).				•		
Replace spark plugs. An <i>Emission Control Service</i> .				•		
Engine cooling system service (or every five years, whichever occurs first). An <i>Emission Control Service</i> . See footnote (g).						•
Inspect engine accessory drive belt. An <i>Emission Control Service</i> . See footnote (j).						•

Maintenance Footnotes

(a) *A fluid loss in any vehicle system could indicate a problem. Have the system inspected and repaired and the fluid level checked. Add fluid if needed.*

(b) *Visually inspect wiper blades for wear or cracking. Replace wiper blades that appear worn or damaged or that streak or miss areas of the windshield.*

(c) *Make sure the safety belt reminder light and all your belts, buckles, latch plates, retractors, and anchorages are working properly. Look for any other loose or damaged safety belt system parts. If you see anything that might keep a safety belt system from doing its job, have it repaired. Have any torn or frayed safety belts replaced. Also look for any opened or broken airbag coverings, and have them repaired or replaced. The airbag system does not need regular maintenance.*

(d) *Lubricate the trunk key lock cylinder. Lubricate all body door hinges. Lubricate all hinges and latches, including those for the hood, trunk, console door, and any folding seat hardware. More frequent lubrication may be required when exposed to a corrosive environment. Applying silicone grease on weatherstrips with a clean cloth will make them last longer, seal better, and not stick or squeak.*

(e) *If you drive regularly under dusty conditions, the filter may require replacement more often.*

(f) *Change automatic transmission fluid and filter if the vehicle is mainly driven under one or more of these conditions:*

- In heavy city traffic where the outside temperature regularly reaches 90°F (32°C) or higher.*
- In hilly or mountainous terrain.*
- Uses such as high performance operation.*

(g) *Drain, flush, and refill cooling system. This service can be complex; you should have your dealer perform this service. See Engine Coolant on page 6-20 for what to use. Inspect hoses. Clean radiator, condenser, pressure cap, and filler neck. Pressure test the cooling system and pressure cap.*

(h) *If you drive regularly under dusty conditions, inspect the filter at each engine oil change.*

(i) *Visually inspect belt for fraying, excessive cracks, or obvious damage. Replace belt if necessary.*

Owner Checks and Services

These owner checks and services should be performed at the intervals specified to help ensure the safety, dependability, and emission control performance of your vehicle. Your GM Goodwrench® dealer can assist you with these checks and services.

Be sure any necessary repairs are completed at once. Whenever any fluids or lubricants are added to your vehicle, make sure they are the proper ones, as shown in *Recommended Fluids and Lubricants on page 7-11*.

At Each Fuel Fill

It is important to perform these underhood checks at each fuel fill.

Engine Oil Level Check

Check the engine oil level and add the proper oil if necessary. See *Engine Oil on page 6-13* for further details.

Notice: It is important to check your oil regularly and keep it at the proper level. Failure to keep your engine oil at the proper level can cause damage to your engine not covered by your warranty.

Engine Coolant Level Check

Check the engine coolant level and add DEX-COOL® coolant mixture if necessary. See *Engine Coolant on page 6-20* for further details.

Windshield Washer Fluid Level Check

Check the windshield washer fluid level in the windshield washer fluid reservoir and add the proper fluid if necessary.

At Least Once a Month

Tire Inspection and Inflation Check

Visually inspect your tires for wear and make sure tires are inflated to the correct pressures. See *Tires on page 6-47* for further details.

At Least Once a Year

Starter Switch Check

CAUTION:

When you are doing this inspection, the vehicle could move suddenly. If the vehicle moves, you or others could be injured.

1. Before you start, be sure you have enough room around the vehicle.
2. Firmly apply both the parking brake and the regular brake. See *Parking Brake* on page 2-29.
Do not use the accelerator pedal, and be ready to turn off the engine immediately if it starts.
3. Try to start the engine in each gear. The vehicle should start only in PARK (P) or NEUTRAL (N). If the vehicle starts in any other position, contact your GM Goodwrench[®] dealer for service.

Transmission Shift Lock Control System Check

CAUTION:

When you are doing this inspection, the vehicle could move suddenly. If the vehicle moves, you or others could be injured.

1. Before you start, be sure you have enough room around the vehicle. It should be parked on a level surface.
2. Firmly apply the parking brake. See *Parking Brake* on page 2-29.
Be ready to apply the regular brake immediately if the vehicle begins to move.
3. With the engine off and without applying the regular brake, try to move the shift lever out of PARK (P) with normal effort. If the shift lever moves out of PARK (P), contact your GM Goodwrench[®] dealer for service.

Parking Brake and Transmission Park (P) Mechanism Check

CAUTION:

When you are doing this check, your vehicle could begin to move. You or others could be injured and property could be damaged. Make sure there is room in front of your vehicle in case it begins to roll. Be ready to apply the regular brake at once should the vehicle begin to move.

Park on a fairly steep hill, with the vehicle facing downhill. Keeping your foot on the regular brake, set the parking brake.

- To check the parking brake's holding ability: With the engine running and transmission in NEUTRAL (N), slowly remove foot pressure from the regular brake pedal. Do this until the vehicle is held by the parking brake only.
- To check the PARK (P) mechanism's holding ability: With the engine running, shift to PARK (P). Then release the parking brake followed by the regular brake.

Contact your GM Goodwrench[®] dealer if service is required.

Underbody Flushing Service

At least every spring, use plain water to flush any corrosive materials from the underbody. Take care to clean thoroughly any areas where mud and other debris can collect.

Recommended Fluids and Lubricants

Fluids and lubricants identified below by name, part number, or specification may be obtained from your dealer.

Usage	Fluid/Lubricant
Engine Oil	The engine requires a special engine oil meeting GM Standard GM4718M. Oils meeting this standard may be identified as synthetic, and should also be identified with the American Petroleum Institute (API) Certified for Gasoline Engines starburst symbol. However, not all synthetic API oils with the starburst symbol will meet this GM standard. You should look for and use only an oil that meets GM Standard GM4718M. GM Goodwrench [®] oil meets all the requirements for your vehicle. For the proper viscosity, see <i>Engine Oil</i> on page 6-13.

Usage	Fluid/Lubricant
Engine Cooling System	50/50 mixture of clean, drinkable water and use only DEX-COOL [®] Coolant. See <i>Engine Coolant</i> on page 6-20.
Hydraulic Brake System	Delco [®] Supreme 11 Brake Fluid or equivalent DOT-3 brake fluid.
Windshield Washer	GM Optikleen [®] Washer Solvent.
Power Steering System	GM Power Steering Fluid (GM Part No. U.S. 89021184, in Canada 89021186).
Automatic Transmission	DEXRON [®] -III Automatic Transmission Fluid. Look for "Approved for the H-Specification" on the label.

Usage	Fluid/Lubricant
Trunk Key Lock Cylinder	Multi-Purpose Lubricant, Superlube (GM Part No. U.S. 12346241, in Canada 10953474).
Rear Axle (Limited-Slip Differential)	SAE 75W-90 Synthetic Axle Lubricant (GM Part No. U.S. 12378261, in Canada 10953455) meeting GM Specification 9986115. With a complete drain and refill add 4 ounces (118 ml) of Limited-Slip Axle Lubricant Additive (GM Part No. U.S. 1052358, in Canada 992694) where required. See <i>Rear Axle</i> on page 6-42.

Usage	Fluid/Lubricant
Hood Latch Assembly, Secondary Latch, Pivots, Spring Anchor, and Release Pawl	Lubriplate Lubricant Aerosol (GM Part No. U.S. 12346293, in Canada 992723) or lubricant meeting requirements of NLGI #2, Category LB or GC-LB.
Hood and Door Hinges	Multi-Purpose Lubricant, Superlube (GM Part No. U.S. 12346241, in Canada 10953474).
Weatherstrip Conditioning	Dielectric Silicone Grease (GM Part No. U.S. 12345579, in Canada 992887).

Normal Maintenance Replacement Parts

Replacement parts identified below by name, part number, or specification can be obtained from your dealer.

Part	GM Part Number	ACDelco® Part Number
Engine Air Cleaner/Filter Elements	25099149	A1208C
Engine Oil Filter		
4.6 L V8 Engine	89017342	PF61
Passenger Compartment Air Filter Element	10345066	CF131C
Spark Plugs		
4.6 L V8 Engine	12571533	41-986
Wiper Blade – 19.7 inches (50 cm)	12367281	—

Maintenance Record

After the scheduled services are performed, record the date, odometer reading, who performed the service, and the type of services performed in the boxes provided. See *Maintenance Requirements on page 7-2*. Any additional information from *Owner Checks and Services on page 7-8* can be added on the following record pages. You should retain all maintenance receipts.

Maintenance Record

Date	Odometer Reading	Serviced By	Maintenance I or Maintenance II	Services Performed

Maintenance Record (cont'd)

Date	Odometer Reading	Serviced By	Maintenance I or Maintenance II	Services Performed

Section 8 Customer Assistance and Information

Customer Assistance and Information	8-2	Reporting Safety Defects	8-13
Customer Satisfaction Procedure	8-2	Reporting Safety Defects to the United States Government	8-13
Online Owner Center	8-3	Reporting Safety Defects to the Canadian Government	8-14
Customer Assistance for Text Telephone (TTY) Users	8-4	Reporting Safety Defects to General Motors	8-14
Customer Assistance Offices	8-4	Service Publications Ordering Information	8-14
GM Mobility Reimbursement Program	8-5		
Roadside Service	8-6		
Courtesy Transportation	8-7		
Vehicle Data Collection and Event Data Recorders	8-9		
Collision Damage Repair	8-10		

Customer Assistance and Information

Customer Satisfaction Procedure

Your satisfaction and goodwill are important to your dealer and to Cadillac. Normally, any concerns with the sales transaction or the operation of your vehicle will be resolved by your dealer's sales or service departments. Sometimes, however, despite the best intentions of all concerned, misunderstandings can occur. If your concern has not been resolved to your satisfaction, the following steps should be taken:

STEP ONE: Discuss your concern with a member of dealership management. Normally, concerns can be quickly resolved at that level. If the matter has already been reviewed with the sales, service or parts manager, contact the owner of the dealership or the general manager.

STEP TWO: If after contacting a member of dealership management, it appears your concern cannot be resolved by the dealership without further help, contact the Cadillac Customer Assistance Center, 24 hours a day, by calling 1-800-458-8006. In Canada, contact the Canadian Cadillac Customer Communication Centre by calling 1-888-446-2000.

We encourage you to call the toll-free number in order to give your inquiry prompt attention. Please have the following information available to give the Customer Assistance Representative:

- Vehicle Identification Number (VIN). This is available from the vehicle registration or title, or the plate at the top left of the instrument panel and visible through the windshield.
- Dealership name and location.
- Vehicle delivery date and present mileage.

When contacting Cadillac, please remember that your concern will likely be resolved at a dealer's facility. That is why we suggest you follow Step One first if you have a concern.

STEP THREE: Both General Motors and your dealer are committed to making sure you are completely satisfied with your new vehicle. However, if you continue to remain unsatisfied after following the procedure outlined in Steps One and Two, you should file with the BBB Auto Line Program to enforce any additional rights you may have. Canadian owners refer to your Warranty and Owner Assistance Information booklet for information on the Canadian Motor Vehicle Arbitration Plan (CAMVAP).

The BBB Auto Line Program is an out of court program administered by the Council of Better Business Bureaus to settle automotive disputes regarding vehicle repairs or the interpretation of the New Vehicle Limited Warranty. Although you may be required to resort to this informal dispute resolution program prior to filing a court action, use of the program is free of charge and your case will generally be heard within 40 days. If you do not agree with the decision given in your case, you may reject it and proceed with any other venue for relief available to you.

You may contact the BBB Auto Line Program using the toll-free telephone number or write them at the following address:

BBB Auto Line Program
Council of Better Business Bureaus, Inc.
4200 Wilson Boulevard
Suite 800
Arlington, VA 22203-1838
Telephone: 1-800-955-5100

This program is available in all 50 states and the District of Columbia. Eligibility is limited by vehicle age, mileage and other factors. General Motors reserves the right to change eligibility limitations and/or discontinue its participation in this program.

Online Owner Center

The Owner Center is a resource for your GM ownership needs. Specific vehicle information can be found in one place.

The Online Owner Center allows you to:

- Get e-mail service reminders.
- Access information about your specific vehicle, including tips and videos and an electronic version of this owner's manual (United States only).
- Keep track of your vehicle's service history and maintenance schedule.
- Find GM dealers for service nationwide.
- Receive special promotions and privileges only available to members (United States only).

Refer to the web for updated information.

To register your vehicle, visit www.MyGMLink.com (United States) or My GM Canada within www.gmcanada.com (Canada).

Customer Assistance for Text Telephone (TTY) Users

To assist customers who are deaf, hard of hearing, or speech-impaired and who use Text Telephones (TTYs), Cadillac has TTY equipment available at its Customer Assistance Center. Any TTY user can communicate with Cadillac by dialing: 1-800-833-CMCC (2622). (TTY users in Canada can dial 1-800-263-3830.)

Customer Assistance Offices

Cadillac encourages customers to call the toll-free number for assistance. However, if a customer wishes to write or e-mail Cadillac, refer to the addresses below.

United States — Customer Assistance

Cadillac Customer Assistance Center
Cadillac Motor Car Division
P.O. Box 33169
Detroit, MI 48232-5169

www.Cadillac.com
1-800-458-8006
1-800-833-2622 (For Text Telephone devices (TTYs))
Roadside Assistance: 1-800-882-1112
Fax Number: 313-381-0022

From Puerto Rico:
1-800-496-9992 (English)
1-800-496-9993 (Spanish)
Fax Number: 313-381-0022

From U.S. Virgin Islands:
1-800-496-9994
Fax Number: 313-381-0022

Canada — Customer Assistance

General Motors of Canada Limited
Canadian Cadillac Customer Communication
Centre, 163-005
1908 Colonel Sam Drive
Oshawa, Ontario L1H 8P7
1-888-446-2000
1-800-263-3830 (For Text Telephone devices (TTYs))
Roadside Assistance: 1-800-882-1112

Overseas — Customer Assistance

Please contact the local General Motors Business Unit.

Mexico, Central America and Caribbean Islands/Countries (Except Puerto Rico and U.S. Virgin Islands) — Customer Assistance

General Motors de Mexico, S. de R.L. de C.V.
Customer Assistance Center
Paseo de la Reforma # 2740
Col. Lomas de Bezares
C.P. 11910, Mexico, D.F.
01-800-508-0000
Long Distance: 011-52-53 29 0 800

GM Mobility Reimbursement Program



This program, available to qualified applicants, can reimburse you up to \$1,000 of the cost of eligible aftermarket adaptive equipment required for your vehicle, such as hand controls or a wheelchair/scooter lift.

The offer is available for a very limited period of time from the date of vehicle purchase/lease. For more details, or to determine your vehicle's eligibility, visit gmmobility.com or call the GM Mobility Assistance Center at 1-800-323-9935. Text telephone (TTY) users, call 1-800-833-9935.

GM of Canada also has a Mobility Program. Call 1-800-GM-DRIVE (463-7483) for details. TTY users call 1-800-263-3830.

Roadside Service

Cadillac's exceptional Roadside Service is more than an auto club or towing service. It provides every Cadillac owner with the advantage of contacting a Cadillac advisor and, where available, a Cadillac trained dealer technician who can provide on-site service.

Each technician travels with a specially equipped service vehicle complete with the necessary Cadillac parts and tools required to handle most roadside repairs.

Cadillac Roadside Service® can be reached by dialing **1-800-882-1112**, 24 hours a day, 365 days a year. This service is provided at no charge for any situation covered by the base warranty coverage and at a nominal charge if the Cadillac is no longer covered by the base warranty. Roadside Service is available only in the United States and Canada.

Cadillac Owner Privileges™

Roadside Service provides several Cadillac Owner Privileges™ at "no charge," throughout your *Cadillac Warranty Period* — 48 months/50,000 miles (80 000 km).

Emergency Road Service is performed on site for the following situations:

- Towing Service
- Battery Jump Starting
- Lock Out Assistance
- Fuel Delivery
- Flat Tire Change (Covers change only)
- Trip Interruption — If your trip is interrupted due to a warranty failure, incidental expenses may be reimbursed during the 48 months/50,000 miles (80 000 km) warranty period. Items covered are hotel, meals, and rental car.

Roadside Service Availability

Wherever you drive in the United States or Canada, an advisor is available to assist you over the phone. A dealer technician, if available, can travel to your location within a 30 mile (50 km) radius of a participating Cadillac dealership. If beyond this radius, we will arrange to have your car towed to the nearest Cadillac dealership.

Reaching Roadside Service

Dial the toll-free Roadside Service number: **1-800-882-1112**. A Roadside Service Advisor will assist you and request the following information:

- A description of the problem
- Name, home address, home telephone number
- Location of your Cadillac and number you are calling from
- The model year, Vehicle Identification Number (VIN), mileage, and date of delivery

Roadside Service for the Hearing or Speech Impaired

Roadside Service is prepared to assist owners who have hearing difficulties or are speech impaired. Cadillac has installed special telecommunication devices called Text Telephone (TTY) in the Roadside Service Center.

Any customer who has access to a (TTY) or a conventional teletypewriter can communicate with Cadillac by dialing from the United States or Canada **1-888-889-2438** — daily, 24 hours.

Courtesy Transportation

To enhance your ownership experience, we and our participating dealers are proud to offer Courtesy Transportation, a customer support program for new vehicles.

The Courtesy Transportation program is offered to customers in conjunction with the Bumper-to-Bumper coverage provided by the New Vehicle Limited Warranty. Several transportation options are available when warranty repairs are required. This will reduce your inconvenience during warranty repairs.

Scheduling Service Appointments

When your vehicle requires warranty service, you should contact your dealer and request an appointment. By scheduling a service appointment and advising your service consultant of your transportation needs, your dealer can help minimize your inconvenience.

If your vehicle cannot be scheduled into the service department immediately, keep driving it until it can be scheduled for service, unless, of course, the problem is safety-related. If it is, please call your dealership, let them know this, and ask for instructions.

If the dealer requests that you simply drop the vehicle off for service, you are urged to do so as early in the work day as possible to allow for the same day repair.

Transportation Options

Warranty service can generally be completed while you wait. However, if you are unable to wait, GM helps to minimize your inconvenience by providing several transportation options. Depending on the circumstances, your dealer can offer you one of the following:

Shuttle Service

Participating dealers can provide you with shuttle service to get you to your destination with minimal interruption of your daily schedule. This includes one-way or round trip shuttle service to a destination up to 10 miles (16 km) from the dealership.

Public Transportation or Fuel Reimbursement

If your vehicle requires warranty repairs, reimbursement of public transportation expenses may be available, for up to a maximum of five days. In addition, should you arrange transportation through a friend or relative, reimbursement for reasonable fuel expenses may be available, up to a five-day maximum. Claim amounts should reflect actual costs and be supported by original receipts.

Courtesy Rental Vehicle

Your dealer may arrange to provide you with a courtesy rental vehicle or reimburse you for a rental vehicle that you obtain if your vehicle is kept for a warranty repair. Reimbursement will be limited to a maximum amount per day and must be supported by receipts. This requires that you sign and complete a rental agreement and meet state, local and rental vehicle provider requirements. Requirements vary and may include minimum age requirements, insurance coverage, credit card, etc. You are responsible for fuel usage charges and may also be responsible for taxes, levies, usage fees, excessive mileage or rental usage beyond the completion of the repair.

Generally it is not possible to provide a like-vehicle as a courtesy rental.

Additional Program Information

Courtesy Transportation is available during the Bumper-to-Bumper warranty coverage period, but it is not part of the New Vehicle Limited Warranty. A separate booklet entitled *Warranty and Owner Assistance Information* furnished with each new vehicle provides detailed warranty coverage information.

Courtesy Transportation is available only at participating dealers and all program options, such as shuttle service, may not be available at every dealer. Please contact your dealer for specific information about availability. All Courtesy Transportation arrangements will be administered by appropriate dealer personnel.

Canadian Vehicles: For warranty repairs during the Complete Vehicle Coverage period of the General Motors of Canada New Vehicle Limited Warranty, alternative transportation may be available under the Courtesy Transportation Program. Please consult your dealer for details.

General Motors reserves the right to unilaterally modify, change or discontinue Courtesy Transportation at any time and to resolve all questions of claim eligibility pursuant to the terms and conditions described herein at its sole discretion.

Vehicle Data Collection and Event Data Recorders

Your vehicle, like other modern motor vehicles, has a number of sophisticated computer systems that monitor and control several aspects of the vehicle's performance. Your vehicle uses on-board vehicle computers to monitor emission control components to optimize fuel economy, to monitor conditions for airbag deployment and, if so equipped, to provide anti-lock braking and to help the driver control the vehicle in difficult driving situations. Some information may be stored during regular operations to facilitate repair of detected malfunctions; other information is stored only in a crash event by computer systems, such as those commonly called event data recorders (EDR).

In a crash event, computer systems, such as the Airbag Sensing and Diagnostic Module (SDM) in your vehicle may record information about the condition of the vehicle and how it was operated, such as data related to engine speed, brake application, throttle position, vehicle speed, safety belt usage, airbag readiness, airbag performance, and the severity of a collision. If your vehicle is equipped with StabiliTrak[®], steering performance, including yaw rate, steering wheel angle, and lateral acceleration, is also recorded. This information has been used to improve vehicle crash performance and may be used to improve crash performance of future vehicles and driving safety.

Unlike the data recorders on many airplanes, these on-board systems do not record sounds, such as conversation of vehicle occupants.

To read this information, special equipment is needed and access to the vehicle or the device that stores the data is required. GM will not access information about a crash event or share it with others other than:

- with the consent of the vehicle owner or, if the vehicle is leased, with the consent of the lessee,
- in response to an official request of police or similar government office,
- as part of GM's defense of litigation through the discovery process, or
- as required by law.

In addition, once GM collects or receives data, GM may:

- use the data for GM research needs,
- make it available for research where appropriate confidentiality is to be maintained and need is shown, or
- share summary data which is not tied to a specific vehicle with non-GM organizations for research purposes.

Others, such as law enforcement, may have access to the special equipment that can read the information if they have access to the vehicle or the device that stores the data.

If your vehicle is equipped with OnStar[®], please check the OnStar[®] subscription service agreement or manual for information on its operations and data collection.

Collision Damage Repair

If your vehicle is involved in a collision and it is damaged, have the damage repaired by a qualified technician using the proper equipment and quality replacement parts. Poorly performed collision repairs will diminish your vehicle's resale value, and safety performance can be compromised in subsequent collisions.

Collision Parts

Genuine GM Collision parts are new parts made with the same materials and construction methods as the parts with which your vehicle was originally built. Genuine GM Collision parts are your best choice to assure that your vehicle's designed appearance, durability and safety are preserved. The use of Genuine GM parts can help maintain your GM New Vehicle Warranty.

Recycled original equipment parts may also be used for repair. These parts are typically removed from vehicles that were total losses in prior accidents. In most cases, the parts being recycled are from undamaged sections of the vehicle. A recycled original equipment GM part, may be an acceptable choice to maintain your vehicle's originally designed appearance and safety performance, however, the history of these parts is not known. Such parts are not covered by your GM New Vehicle Limited Warranty, and any related failures are not covered by that warranty.

Aftermarket collision parts are also available. These are made by companies other than GM and may not have been tested for your vehicle. As a result, these parts may fit poorly, exhibit premature durability/corrosion problems, and may not perform properly in subsequent collisions. Aftermarket parts are not covered by your GM New Vehicle Limited Warranty, and any vehicle failure related to such parts are not covered by that warranty.

Repair Facility

GM also recommends that you choose a collision repair facility that meets your needs before you ever need collision repairs. Your GM dealer may have a collision repair center with GM-trained technicians and state of the art equipment, or be able to recommend a collision repair center that has GM-trained technicians and comparable equipment.

Insuring Your Vehicle

Protect your investment in your GM vehicle with comprehensive and collision insurance coverage. There are significant differences in the quality of coverage afforded by various insurance policy terms. Many insurance policies provide reduced protection to your GM vehicle by limiting compensation for damage repairs by using aftermarket collision parts. Some insurance companies will not specify aftermarket collision parts. When purchasing insurance, we recommend that you assure your vehicle will be repaired with GM original equipment collision parts. If such insurance coverage is not available from your current insurance carrier, consider switching to another insurance carrier.

If your vehicle is leased, the leasing company may require you to have insurance that assures repairs with Genuine GM Original Equipment Manufacturer (OEM) parts or Genuine Manufacturer replacement parts. Read your lease carefully, as you may be charged at the end of your lease for poor quality repairs.

If an Accident Occurs

Here is what to do if you are involved in an accident.

- Try to relax and then check to make sure you are all right. If you are uninjured, make sure that no one else in your vehicle, or the other vehicle, is injured.
 - If there has been an injury, call 911 for help. Do not leave the scene of an accident until all matters have been taken care of. Move your vehicle only if its position puts you in danger or you are instructed to move it by a police officer.
 - Give only the necessary and requested information to police and other parties involved in the accident. Do not discuss your personal condition, mental frame of mind, or anything unrelated to the accident. This will help guard against post-accident legal action.
 - If you need roadside assistance, call GM Roadside Assistance. See *Roadside Service on page 8-6* for more information.
 - If your vehicle cannot be driven, know where the towing service will be taking it. Get a card from the tow truck operator or write down the driver's name, the service's name, and the phone number.
 - Remove any valuables from your vehicle before it is towed away. Make sure this includes your insurance information and registration if you keep these items in your vehicle.
- Gather the important information you will need from the other driver. Things like name, address, phone number, driver's license number, vehicle license plate, vehicle make, model and model year, Vehicle Identification Number (VIN), insurance company and policy number, and a general description of the damage to the other vehicle.
 - If possible, call your insurance company from the scene of the accident. They will walk you through the information they will need. If they ask for a police report, phone or go to the police department headquarters the next day and you can get a copy of the report for a nominal fee. In some states with "no fault" insurance laws, a report may not be necessary. This is especially true if there are no injuries and both vehicles are driveable.
 - Choose a reputable collision repair facility for your vehicle. Whether you select a GM dealer or a private collision repair facility to fix the damage, make sure you are comfortable with them. Remember, you will have to feel comfortable with their work for a long time.
 - Once you have an estimate, read it carefully and make sure you understand what work will be performed on your vehicle. If you have a question, ask for an explanation. Reputable shops welcome this opportunity.

Managing the Vehicle Damage Repair Process

In the event that your vehicle requires damage repairs, GM recommends that you take an active role in its repair. If you have a pre-determined repair facility of choice, take your vehicle there, or have it towed there. Specify to the facility that any required replacement collision parts be original equipment parts, either new Genuine GM parts or recycled original GM parts. Remember, recycled parts will not be covered by your GM vehicle warranty.

Insurance pays the bill for the repair, but you must live with the repair. Depending on your policy limits, your insurance company may initially value the repair using aftermarket parts. Discuss this with your repair professional, and insist on Genuine GM parts. Remember if your vehicle is leased you may be obligated to have the vehicle repaired with Genuine GM parts, even if your insurance coverage does not pay the full cost.

If another party's insurance company is paying for the repairs, you are not obligated to accept a repair valuation based on that insurance company's collision policy repair limits, as you have no contractual limits with that company. In such cases, you can have control of the repair and parts choices as long as cost stays within reasonable limits.

Reporting Safety Defects

Reporting Safety Defects to the United States Government

If you believe that your vehicle has a defect which could cause a crash or could cause injury or death, you should immediately inform the National Highway Traffic Safety Administration (NHTSA), in addition to notifying General Motors.

If NHTSA receives similar complaints, it may open an investigation, and if it finds that a safety defect exists in a group of vehicles, it may order a recall and remedy campaign. However, NHTSA cannot become involved in individual problems between you, your dealer, or General Motors.

To contact NHTSA, you may either call the Auto Safety Hotline toll-free at 1-800-424-9393 (or 366-0123 in the Washington, D.C. area) or write to:

NHTSA, U.S. Department of Transportation
Washington, D.C. 20590

You can also obtain other information about motor vehicle safety from the hotline.

Reporting Safety Defects to the Canadian Government

If you live in Canada, and you believe that your vehicle has a safety defect, you should immediately notify Transport Canada, in addition to notifying General Motors of Canada Limited. You may call them at 1-800-333-0510 or write to:

Transport Canada
Place de Ville Tower C
330 Sparks Street
Ottawa, Ontario K1A 0N5

Reporting Safety Defects to General Motors

In addition to notifying NHTSA (or Transport Canada) in a situation like this, we certainly hope you will notify us. Please call us at 1-800-458-8006, or write:

Cadillac Customer Assistance Center
Cadillac Motor Car Division
P.O. Box 33169
Detroit, MI 48232-5169

In Canada, please call us at 1-888-446-2000.
Or, write:

Canadian Cadillac Customer Communication
Centre, 163-005
General Motors of Canada Limited
1908 Colonel Sam Drive
Oshawa, Ontario L1H 8P7

Service Publications Ordering Information

Service Manuals

Service Manuals have the diagnosis and repair information on engines, transmission, axle suspension, brakes, electrical, steering, body, etc.

Transmission, Transaxle, Transfer Case Unit Repair Manual

This manual provides information on unit repair service procedures, adjustments, and specifications for GM transmissions, transaxles, and transfer cases.

Service Bulletins

Service Bulletins give technical service information needed to knowledgeably service General Motors cars and trucks. Each bulletin contains instructions to assist in the diagnosis and service of your vehicle.

In Canada, information pertaining to Product Service Bulletins can be obtained by contacting your General Motors dealer or by calling 1-800-GM-DRIVE (1-800-463-7483).

Owner's Information

Owner publications are written specifically for owners and intended to provide basic operational information about the vehicle. The owner's manual will include the Maintenance Schedule for all models.

In-Portfolio: Includes a Portfolio, Owner's Manual, and Warranty Booklet.

RETAIL SELL PRICE: \$35.00

Without Portfolio: Owner's Manual only.

RETAIL SELL PRICE: \$25.00

Current and Past Model Order Forms

Service Publications are available for current and past model GM vehicles. To request an order form, please specify year and model name of the vehicle.

ORDER TOLL FREE: 1-800-551-4123
Monday-Friday 8:00 AM - 6:00 PM
Eastern Time

For Credit Card Orders Only
(VISA-MasterCard-Discover), visit Helm, Inc. on the World Wide Web at: www.helminc.com

Or you can write to:

Helm, Incorporated
P.O. Box 07130
Detroit, MI 48207

Prices are subject to change without notice and without incurring obligation. Allow ample time for delivery.

Note to Canadian Customers: All listed prices are quoted in U.S. funds. Canadian residents are to make checks payable in U.S. funds.

A

Accessories and Modifications	6-3	Airbag System (cont.)	
Accessory Power Outlet(s)	3-40	Antenna, Diversity Antenna System	3-86
Adaptive Cruise Control	3-15	Antenna, XM™ Satellite Radio Antenna System	3-86
Adaptive Forward Lighting System	3-31	Anti-Lock Brake System (ABS)	5-7
Adding Equipment to Your Airbag-Equipped Vehicle	1-44	Anti-Lock Brake, System Warning Light	3-55
Additives, Fuel	6-6	Appearance Care	
Add-On Electrical Equipment	6-80	Aluminum or Chrome-Plated Wheels	6-76
Air Cleaner/Filter, Engine	6-18	Care of Safety Belts	6-74
Air Conditioning	3-41	Chemical Paint Spotting	6-77
Airbag		Cleaning Exterior Lamps/Lenses	6-75
Passenger Status Indicator	3-52	Cleaning the Inside of Your Vehicle	6-71
Readiness Light	3-51	Fabric/Carpet	6-72
Airbag Sensing and Diagnostic Module (SDM)	8-9	Finish Care	6-75
Airbag System	1-32	Finish Damage	6-77
Adding Equipment to Your Airbag-Equipped Vehicle	1-44	Instrument Panel, Vinyl, and Other Plastic Surfaces	6-73
How Does an Airbag Restrain?	1-38	Leather	6-73
Passenger Sensing System	1-40	Sheet Metal Damage	6-77
Servicing Your Airbag-Equipped Vehicle	1-44	Speaker Covers	6-74
What Makes an Airbag Inflate?	1-38	Tires	6-77
What Will You See After an Airbag Inflates?	1-39	Underbody Maintenance	6-77
When Should an Airbag Inflate?	1-37	Vehicle Care/Appearance Materials	6-78
Where Are the Airbags?	1-34	Washing Your Vehicle	6-74
		Weatherstrips	6-74
		Windshield and Wiper Blades	6-75
		Wood Panels	6-73

Ashtray(s)	3-41
Audio System	4-51
Audio System(s)	3-82
Audio Steering Wheel Controls	3-84
Care of Your CD Player	3-86
Care of Your CDs	3-86
Diversity Antenna System	3-86
Theft-Deterrent Feature	3-84
Understanding Radio Reception	3-85
XM™ Satellite Radio Antenna System	3-86
Automatic Door Lock	2-11
Automatic Transmission	
Fluid	6-19
Operation	2-25
Avoid Point/Area, Edit	4-25

B

Battery	6-36
Exterior Lighting Battery Saver	3-33
Run-Down Protection	3-34
Before Leaving on a Long Trip	5-24

Brake	
Anti-Lock Brake System (ABS)	5-7
Emergencies	5-9
Parking	2-29
System Warning Light	3-54
Brakes	6-33
Braking	5-6
Braking in Emergencies	5-9
Break-In, New Vehicle	2-20
Bulb Replacement	6-45
Headlamp Aiming	6-43
Buying New Tires	6-58

C

California Fuel	6-5
California Proposition 65 Warning	6-3
Canadian Owners	ii
Capacities and Specifications	6-86
Carbon Monoxide	2-12, 2-33, 5-27, 5-37
Care of	
Safety Belts	6-74
Your CD Player	3-86
Your CDs	3-86

CD		Cleaning (cont.)	
Player	4-69	Leather	6-73
Six-Disc Changer	4-66	Speaker Covers	6-74
CD/DVD Player	4-69	Tires	6-77
Center Console Storage Area	2-44	Underbody Maintenance	6-77
Chains, Tire	6-64	Washing Your Vehicle	6-74
Check		Weatherstrips	6-74
Engine Light	3-58	Windshield and Wiper Blades	6-75
Checking Things Under the Hood	6-10	Wood Panels	6-73
Chemical Paint Spotting	6-77	Climate Control System	
Child Restraints		Air Filter, Passenger Compartment	3-47
Child Restraint Systems	1-23	Dual	3-41
Infants and Young Children	1-20	Outlet Adjustment	3-47
Lower Anchors and Tethers for Children	1-27	Collision Damage Repair	8-10
Older Children	1-18	Control of a Vehicle	5-6
Securing a Child Restraint in the Passenger		Convenience Net	2-46
Seat Position	1-28	Coolant	
Cigarette Lighter	3-41	Engine Temperature Gage	3-57
Cleaning		Heater, Engine	2-24
Aluminum or Chrome-Plated Wheels	6-76	Surge Tank Pressure Cap	6-23
Exterior Lamps/Lenses	6-75	Cooled Seats	1-3
Fabric/Carpet	6-72	Cooling System	6-26
Finish Care	6-75	Courtesy Lamps	3-33
Inside of Your Vehicle	6-71	Cruise Control	3-12
Instrument Panel, Vinyl, and Other Plastic		Cruise Control, Adaptive	3-15
Surfaces	6-73		

Cupholder(s)	2-44
Customer Assistance Information	
Courtesy Transportation	8-7
Customer Assistance for Text Telephone (TTY) Users	8-4
Customer Assistance Offices	8-4
Customer Satisfaction Procedure	8-2
GM Mobility Reimbursement Program	8-5
Reporting Safety Defects to General Motors	8-14
Reporting Safety Defects to the Canadian Government	8-14
Reporting Safety Defects to the United States Government	8-13
Roadside Service	8-6
Service Publications Ordering Information	8-14

D

Database Coverage Explanations	4-50
Daytime Running Lamps	3-30
Defensive Driving	5-2
Diversity Antenna System	3-86
Doing Your Own Service Work	6-4

Door	
Automatic Door Lock	2-11
Locks	2-9
Power Door Locks	2-11
Programmable Automatic Door Unlock	2-12
Driver	
Position, Safety Belt	1-10
Driver Information Center (DIC)	3-64
DIC Controls and Displays	3-64
DIC Vehicle Personalization	3-78
DIC Warnings and Messages	3-67
Other Messages	3-77
Driving	
At Night	5-18
City	5-22
Defensive	5-2
Drunken	5-3
Freeway	5-23
Hill and Mountain Roads	5-26
In Rain and on Wet Roads	5-20
Rocking Your Vehicle to Get it Out	5-32
Winter	5-27
Dual Climate Control System	3-41
DVD	
Player	4-69

E

Edit	
Avoid Point/Area	4-25
Memory Point	4-19
Waypoint	4-23
Electrical System	
Add-On Equipment	6-80
Fuses and Circuit Breakers	6-80
Instrument Panel Fuse Block	6-81
Power Windows and Other Power Options	6-80
Underhood Fuse Block	6-83
Windshield Wiper Fuses	6-80
Engine	
Air Cleaner/Filter	6-18
Battery	6-36
Check and Service Engine Soon Light	3-58
Coolant	6-20
Coolant Heater	2-24
Coolant Temperature Gage	3-57
Engine Compartment Overview	6-12
Exhaust	2-33
Oil	6-13
Oil Life System	6-16
Oil Pressure Gage	3-61

Engine (cont.)	
Overheated Protection Operating Mode	6-25
Overheating	6-23
Starting	2-22
Enter Destination	4-27
Entry/Exit Lighting	3-33
Event Data Recorders (EDR)	8-9
Extender, Safety Belt	1-17
Exterior Lamps	3-28
Exterior Lighting Battery Saver	3-33

F

Filter	
Engine Air Cleaner	6-18
Finish Damage	6-77
Flash-to-Pass	3-8
Flat Tire	6-69
Floor Mats	2-45
Fluid	
Automatic Transmission	6-19
Power Steering	6-31
Windshield Washer	6-32
Fog Lamp Light	3-62
Fog Lamps	3-31

Fuel	6-5
Additives	6-6
California Fuel	6-5
Filling a Portable Fuel Container	6-10
Filling Your Tank	6-7
Fuels in Foreign Countries	6-6
Gage	3-63
Gasoline Octane	6-5
Gasoline Specifications	6-5
Fuses	
Fuses and Circuit Breakers	6-80
Instrument Panel Fuse Block	6-81
Underhood Fuse Block	6-83
Windshield Wiper	6-80

G

Gage	
Engine Coolant Temperature	3-57
Engine Oil Pressure	3-61
Fuel	3-63
Speedometer	3-50
Tachometer	3-50
Voltmeter Gage	3-54
Garage Door Opener	2-39

Gasoline	
Octane	6-5
Specifications	6-5
Getting Started	
Getting Started, Navigation	4-4
Global Positioning System (GPS)	4-48
Glove Box	2-44
GM Mobility Reimbursement Program	8-5

H

Hazard Warning Flashers	3-6
Headlamp	
Aiming	6-43
Vertical Aiming	6-44
Headlamps	
Adaptive Forward Lighting System	3-31
Bulb Replacement	6-45
Daytime Running Lamps	3-30
Flash-to-Pass	3-8
High/Low Beam Changer	3-8
On Reminder	3-29
Washer	3-11
Wiper Activated	3-29
Head-Up Display (HUD)	3-34
Heated Seats	1-3

Heater	3-41
Highbeam On Light	3-62
Highway Hypnosis	5-25
Hill and Mountain Roads	5-26
Hood	
Checking Things Under	6-10
Release	6-11
Horn	3-6
How to Use This Manual	ii
How to Wear Safety Belts Properly	1-10

I

Ignition Positions	2-21
Infants and Young Children, Restraints	1-20
Inflation -- Tire Pressure	6-54
Instrument Panel	
Overview	3-4
Instrument Panel (I/P)	
Brightness	3-33
Cluster	3-49

J

Jump Starting	6-37
---------------------	------

K

Keyless Access System	2-4, 4-47
Keyless Access System, Operation	2-5
Keys	2-2

L

Labeling, Tire Sidewall	6-48
Lamps	
Battery Run-Down Protection	3-34
Courtesy	3-33
Exterior	3-28
Exterior Lighting Battery Saver	3-33
Fog	3-31
Reading	3-33
Twilight Sentinel®	3-32
LATCH System	
Child Restraints	1-27
Lifting Your Vehicle, Tires	6-65
Light	
Airbag Readiness	3-51
Anti-Lock Brake System Warning	3-55
Brake System Warning	3-54
Fog Lamp	3-62
Highbeam On	3-62

Light (cont.)	
Lights On Reminder	3-62
Malfunction Indicator	3-58
Passenger Airbag Status Indicator	3-52
Safety Belt Reminder	3-50
Security	3-62
TCS Warning Light	3-56
Tire Pressure	3-57
Traction Control System (TCS) Warning	3-56
Lighting	
Entry/Exit	3-33
Limited-Slip Rear Axle	5-11
Loading Your Vehicle	5-33
Lockout Protection	2-12
Locks	
Automatic Door Lock	2-11
Door	2-9
Lockout Protection	2-12
Power Door	2-11
Programmable Automatic Door Unlock	2-12
Loss of Control	5-17
Lowering the Retractable Hardtop	2-47
Lumbar	
Power Controls	1-2

M

Magnetic Ride Control	5-11
Maintenance Schedule	
Additional Required Services	7-6
At Each Fuel Fill	7-8
At Least Once a Month	7-8
At Least Once a Year	7-9
Introduction	7-2
Maintenance Footnotes	7-7
Maintenance Record	7-14
Maintenance Requirements	7-2
Normal Maintenance Replacement Parts	7-13
Owner Checks and Services	7-8
Recommended Fluids and Lubricants	7-11
Scheduled Maintenance	7-4
Using	7-2
Your Vehicle and the Environment	7-2
Malfunction Indicator Light	3-58
Map Pocket	2-44
Maps	4-38
Memory Mirrors	2-56
Memory Point, Edit	4-19
Memory Seat	2-56
Memory Steering Wheel Controls	2-56
Menu	
Setup	4-13

Message	
DIC Warnings and Messages	3-67
Mirrors	
Automatic Dimming Rearview with OnStar®	2-34
Memory	2-56
Outside Automatic Dimming Mirror	2-35
Outside Convex Mirror	2-36
Outside Curb View Assist Mirror	2-36
Outside Power Heated Mirrors	2-35
MyGMLink.com	8-3

N

Navigation	4-2, 4-4
Using the System	4-10
New Vehicle Break-In	2-20
Normal Maintenance Replacement Parts	7-13

O

Odometer	3-50
Odometer, Trip	3-50
Off-Road Recovery	5-15
Oil	
Engine	6-13
Engine Oil Pressure Gage	3-61
Life Indicator	3-82

Oil, Engine Oil Life System	6-16
Older Children, Restraints	1-18
Online Owner Center	8-3
OnStar® System	4-47
OnStar® System, see OnStar® Manual	2-37
Ordering	
Map DVDs	4-50
Other Warning Devices	3-6
Outlet Adjustment	3-47
Outside	
Automatic Dimming Mirror	2-35
Convex Mirror	2-36
Curb View Assist Mirror	2-36
Power Heated Mirrors	2-35
Overheated Engine Protection	
Operating Mode	6-25
Owner Checks and Services	7-8
Owners, Canadian	ii

P

Park Aid	3-38
Park (P)	
Shifting Into	2-30
Shifting Out of	2-32

Parking	
Assist	3-38
Brake	2-29
Over Things That Burn	2-32
Passenger Airbag Status Indicator	3-52
Passenger Compartment Air Filter	3-47
Passenger Position, Safety Belts	1-17
Passenger Sensing System	1-40
Passing	5-16
Plan Route	4-18
Power	
Accessory Outlet(s)	3-40
Door Locks	2-11
Electrical System	6-80
Lumbar Controls	1-2
Reclining Seatback	1-4
Retained Accessory (RAP)	2-22
Seat	1-2
Steering Fluid	6-31
Tilt Wheel and Telescopic Steering Column	3-6
Windows	2-16
Pretensioners, Safety Belt	1-17
Problems with Route Guidance	4-50
Programmable Automatic Door Unlock	2-12

Q

Questions and Answers About Safety Belts	1-9
--	-----

R

Radio	4-51
Personalization with Home and Away Feature	4-74
Radios	3-82
Care of Your CD Player	3-86
Care of Your CDs	3-86
Theft-Deterrent	3-84
Understanding Reception	3-85
Rainsense™ Wipers	3-10
Raising the Retractable Hardtop	2-48
Reading Lamps	3-33
Rear Axle	6-42
Limited-Slip	5-11
Rear Storage Area	2-45
Rearview Mirror, Automatic Dimming with OnStar®	2-34
Reclining Seatback, Power	1-4
Recommended Fluids and Lubricants	7-11
Recreational Vehicle Towing	5-37
Replacement, Windshield	6-46

Reporting Safety Defects	
Canadian Government	8-14
General Motors	8-14
United States Government	8-13
Restraint System Check	
Checking the Restraint Systems	1-45
Replacing Restraint System Parts	
After a Crash	1-46
Retained Accessory Power (RAP)	2-22
Retractable Hardtop	2-46
Lowering	2-47
Raising	2-48
Roadside	
Service	8-6
Rocking Your Vehicle to Get it Out	5-32
Route Preference	4-36
Run-Flat Tires	6-52
Running the Engine While Parked	2-33

S

Safety Belt	
Pretensioners	1-17
Reminder Light	3-50
Safety Belts	
Care of	6-74
Driver Position	1-10

Safety Belts (cont.)	
How to Wear Safety Belts Properly	1-10
Passenger Position	1-17
Questions and Answers About Safety Belts	1-9
Safety Belt Extender	1-17
Safety Belt Use During Pregnancy	1-16
Safety Belts Are for Everyone	1-5
Safety Warnings and Symbols	iii
Scheduled Maintenance	7-4
Seats	
Heated and Cooled Seats	1-3
Memory	2-56
Power Lumbar	1-2
Power Reclining Seatback	1-4
Power Seats	1-2
Securing a Child Restraint	
Passenger Seat Position	1-28
Security Light	3-62
Service	6-3
Accessories and Modifications	6-3
Adding Equipment to the Outside of Your	
Vehicle	6-4
California Proposition 65 Warning	6-3
Doing Your Own Work	6-4
Engine Soon Light	3-58
Publications Ordering Information	8-14
Servicing Your Airbag-Equipped Vehicle	1-44

Setup Menu	4-13
Sheet Metal Damage	6-77
Shifting Into Park (P)	2-30
Shifting Out of Park (P)	2-32
Signals, Turn and Lane-Change	3-7
Six-Disc CD Changer	4-66
Specifications, Capacities	6-86
Speedometer	3-50
StabiliTrak® System	5-11
Starting Your Engine	2-22
Steering	5-13
Steering Wheel Controls, Audio	3-84
Steering Wheel Controls, Memory	2-56
Steering Wheel, Power Tilt Wheel and Telescopic Steering Column	3-6
Storage Areas	
Center Console Storage Area	2-44
Convenience Net	2-46
Cupholder(s)	2-44
Glove Box	2-44
Map Pocket	2-44
Rear Storage Area	2-45
Stuck in Sand, Mud, Ice or Snow	5-32
Sun Visors	2-18
Symbols	4-42
System Needs Service, If	4-50
System Overview	
Overview, Navigation System	4-2

T

Tachometer	3-50
TCS Warning Light	3-56
Telescopic Steering Column, Power Tilt Wheel	3-6
Theft-Deterrent, Radio	3-84
Theft-Deterrent System	2-18
Theft-Deterrent Systems	2-18
Tire	
Pressure Light	3-57
Tires	6-47
Aluminum or Chrome-Plated Wheels, Cleaning	6-76
Buying New Tires	6-58
Chains	6-64
Cleaning	6-77
Different Size	6-60
If a Tire Goes Flat	6-69
Inflation -- Tire Pressure	6-54
Inspection and Rotation	6-57
Lifting Your Vehicle	6-65
Pressure Monitor System	6-55
Run-Flat	6-52
Tire Sidewall Labeling	6-48
Tire Terminology and Definitions	6-50
Uniform Tire Quality Grading	6-60

Tires (cont.)	
Wheel Alignment and Tire Balance	6-62
Wheel Replacement	6-62
When It Is Time for New Tires	6-58
Towing	
Recreational Vehicle	5-37
Towing a Trailer	5-37
Your Vehicle	5-37
Traction	
Control System (TCS)	5-9
Control System Warning Light	3-56
Limited-Slip Rear Axle	5-11
Magnetic Ride Control	5-11
StabiliTrak® System	5-11
Transmission	
Fluid, Automatic	6-19
Transmission Operation, Automatic	2-25
Trip Computer	
Oil Life Indicator	3-82
Trip Odometer	3-50
Trunk	2-12
Turn and Lane-Change Signals	3-7
Turn Signal/Multifunction Lever	3-7
Twilight Sentinel®	3-32

U

Ultrasonic Rear Parking Assist (URPA)	3-38
Understanding Radio Reception	3-85
Uniform Tire Quality Grading	6-60
Universal Home Remote System	2-39
Operation	2-40

V

Valet Lockout Switch	2-20
Vehicle	
Control	5-6
Damage Warnings	iv
Loading	5-33
Symbols	iv
Vehicle Data Collection and Event Data	
Recorders	8-9
Vehicle Identification	
Number (VIN)	6-79
Service Parts Identification Label	6-79
Vehicle Personalization	2-56
DIC	3-78
Memory Seat, Mirrors and Steering Wheel	2-56

Vehicle Positioning	4-49
Ventilation Adjustment	3-47
Visors	2-18
Voice Recognition	4-75
Voltmeter Gage	3-54

W

Warning Lights, Gages and Indicators	3-48
Warnings	
DIC Warnings and Messages	3-67
Hazard Warning Flashers	3-6
Other Warning Devices	3-6
Safety and Symbols	iii
Vehicle Damage	iv
Waypoint, Edit	4-23
Wheels	
Alignment and Tire Balance	6-62
Different Size	6-60
Replacement	6-62
Windows	2-15
Power	2-16

Windshield	
Wiper Blades, Cleaning	6-75
Windshield Replacement	6-46
Windshield Washer	3-11
Fluid	6-32
Windshield Wiper	
Blade Replacement	6-46
Fuses	6-80
Rainsense™ Wipers	3-10
Windshield Wipers	3-9
Winter Driving	5-27
Wiper Activated Headlamps	3-29

X

XM™ Satellite Radio Antenna System	3-86
--	------

Y

Your Vehicle and the Environment	7-2
--	-----