

2008 Cadillac CTS Owner Manual

Seats and Restraint Systems	1-1	Driving Your Vehicle	4-1
Head Restraints	1-2	Your Driving, the Road, and Your Vehicle	4-2
Front Seats	1-4	Towing	4-27
Rear Seats	1-11	Service and Appearance Care	5-1
Safety Belts	1-12	Service	5-3
Child Restraints	1-32	Fuel	5-5
Airbag System	1-55	Checking Things Under the Hood	5-12
Restraint System Check	1-70	All-Wheel Drive	5-49
Features and Controls	2-1	Rear Axle	5-50
Keys	2-3	Headlamp Aiming	5-51
Doors and Locks	2-17	Bulb Replacement	5-55
Windows	2-23	Windshield Wiper Blade Replacement	5-57
Theft-Deterrent Systems	2-27	Tires	5-59
Starting and Operating Your Vehicle	2-31	Appearance Care	5-111
Mirrors	2-49	Vehicle Identification	5-120
Object Detection Systems	2-51	Electrical System	5-121
OnStar [®] System	2-53	Capacities and Specifications	5-128
Universal Home Remote System	2-56	Maintenance Schedule	6-1
Storage Areas	2-61	Maintenance Schedule	6-2
Sunroof	2-62	Customer Assistance Information	7-1
Instrument Panel	3-1	Customer Assistance and Information	7-2
Instrument Panel Overview	3-4	Reporting Safety Defects	7-14
Climate Controls	3-23	Vehicle Data Recording and Privacy	7-16
Warning Lights, Gages, and Indicators	3-29	Index	1
Driver Information Center (DIC)	3-47		
Audio System(s)	3-79		



GENERAL MOTORS, GM, the GM Emblem, CADILLAC, the CADILLAC Crest & Wreath, and the name CTS are registered trademarks of General Motors Corporation.



Music recognition technology and related data are provided by Gracenote[®]. Gracenote is the industry standard in music recognition technology and related content delivery. For more information, visit www.gracenote.com.



DTS AND DTS Digital Surround are registered trademarks of Digital Theater Systems, Inc.



Dolby[®] is manufactured under license from Dolby[®] Laboratories. Dolby[®] and the double-D symbol are trademarks of Dolby[®] Laboratories.

Litho in U.S.A.
Part No. 15864564 A First Printing

©2007 General Motors Corporation. All Rights Reserved.

This manual includes the latest information at the time it was printed. We reserve the right to make changes after that time without notice. For vehicles first sold in Canada, substitute the name “General Motors of Canada Limited” for Cadillac Motor Car Division whenever it appears in this manual.

This manual describes features that may be available in this model, but your vehicle may not have all of them. For example, more than one entertainment system may be offered or your vehicle may have been ordered without a front passenger or rear seats.

Keep this manual in the vehicle for quick reference.

Canadian Owners

A French language copy of this manual can be obtained from your dealer/retailer or from:

Helm, Incorporated
P.O. Box 07130
Detroit, MI 48207
1-800-551-4123
www.helminc.com

Propriétaires Canadiens

On peut obtenir un exemplaire de ce guide en français auprès de concessionnaire ou à l'adresse suivante:

Helm Incorporated
P.O. Box 07130
Detroit, MI 48207
1-800-551-4123
www.helminc.com

Using this Manual

Many people read the owner manual from beginning to end when they first receive their new vehicle to learn about the vehicle's features and controls. Pictures and words work together to explain things.

Index

A good place to quickly locate information about the vehicle is the Index in the back of the manual. It is an alphabetical list of what is in the manual and the page number where it can be found.

Safety Warnings and Symbols

There are a number of safety cautions in this book. A box with the word CAUTION is used to tell about things that could hurt you or others if you were to ignore the warning.

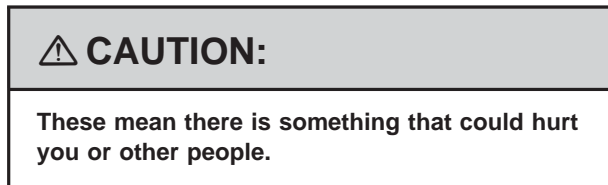

We tell you what the hazard is and what to do to help avoid or reduce the hazard. Please read these cautions. If you do not, you or others could be hurt.

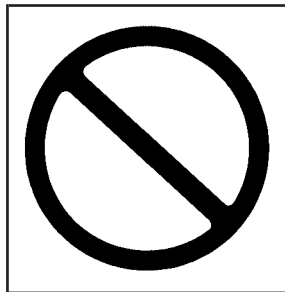

A circle with a slash through it is a safety symbol which means "Do Not," "Do Not do this" or "Do Not let this happen."

Vehicle Damage Warnings

You will also find notices in this manual.

Notice: These mean there is something that could damage your vehicle.

A notice tells about something that can damage the vehicle. Many times, this damage would not be covered by your vehicle's warranty, and it could be costly. The notice tells what to do to help avoid the damage.

When you read other manuals, you might see CAUTION and NOTICE warnings in different colors or in different words.

There are also warning labels on the vehicle which use the same words, CAUTION or NOTICE.

Vehicle Symbols

The vehicle has components and labels that use symbols instead of text. Symbols are shown along with the text describing the operation or information relating to a specific component, control, message, gage, or indicator.

Section 1 Seats and Restraint Systems

Head Restraints	1-2	Where to Put the Restraint	1-42
Front Seats	1-4	Lower Anchors and Tethers for Children (LATCH)	1-43
Manual Seats	1-4	Securing a Child Restraint in a Rear Seat Position	1-49
Power Seats	1-5	Securing a Child Restraint in the Right Front Seat Position	1-51
Power Lumbar	1-5	Airbag System	1-55
Heated and Ventilated Seats	1-6	Where Are the Airbags?	1-58
Memory Seat and Mirrors	1-6	When Should an Airbag Inflate?	1-60
Reclining Seatbacks	1-8	What Makes an Airbag Inflate?	1-62
Rear Seats	1-11	How Does an Airbag Restrain?	1-62
Split Folding Rear Seat	1-11	What Will You See After an Airbag Inflates?	1-62
Safety Belts	1-12	Passenger Sensing System	1-64
Safety Belts: They Are for Everyone	1-12	Servicing Your Airbag-Equipped Vehicle	1-68
How to Wear Safety Belts Properly	1-17	Adding Equipment to Your Airbag-Equipped Vehicle	1-69
Lap-Shoulder Belt	1-25	Restraint System Check	1-70
Safety Belt Use During Pregnancy	1-30	Checking the Restraint Systems	1-70
Safety Belt Extender	1-31	Replacing Restraint System Parts After a Crash	1-71
Child Restraints	1-32		
Older Children	1-32		
Infants and Young Children	1-35		
Child Restraint Systems	1-39		

Head Restraints

The vehicle's front seats have adjustable head restraints in the outboard seating positions.

The vehicle's rear seats have head restraints in the outboard seating positions, but they are not adjustable.

CAUTION:

With head restraints that are not installed and adjusted properly, there is a greater chance that occupants will suffer a neck/spinal injury in a crash. Do not drive until the head restraints for all occupants are installed and adjusted properly.

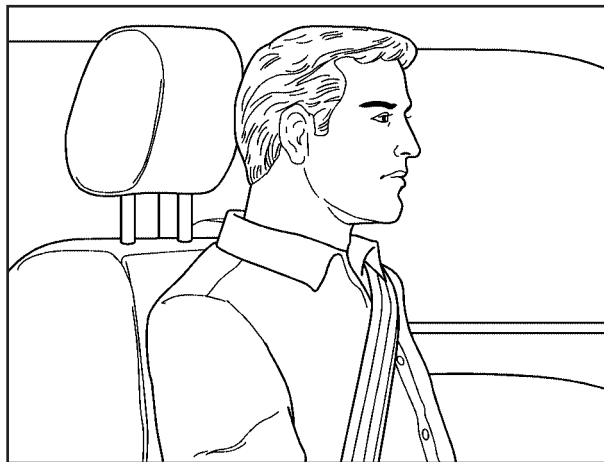

Adjust the head restraint so that the top of the restraint is at the same height as the top of the occupant's head. This position reduces the chance of a neck injury in a crash.

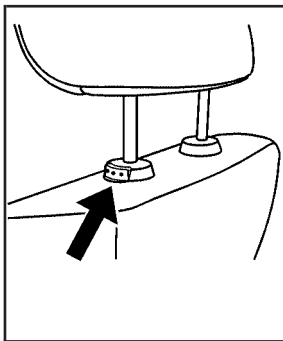

Pull the head restraint up to raise it. To lower the head restraint, press the button, located on the top of the seatback, and push the restraint down.

Active Head Restraint System

On vehicles with an active head restraint system in the front outboard seating positions. These automatically tilt forward to reduce the risk of neck injury if the vehicle is hit from behind.

Push down on the head restraint after the button is released to make sure that it is locked in place.

The vehicle's head restraints are not designed to be removed.

Front Seats

Manual Seats

CAUTION:

You can lose control of the vehicle if you try to adjust a manual driver's seat while the vehicle is moving. The sudden movement could startle and confuse you, or make you push a pedal when you do not want to. Adjust the driver's seat only when the vehicle is not moving.

To move a manual seat forward or rearward:

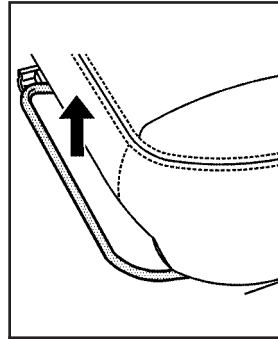

1. Lift the bar to unlock the seat.
2. Slide the seat to the desired position and release the bar.

Try to move the seat with your body to be sure the seat is locked in place.

Power Seats

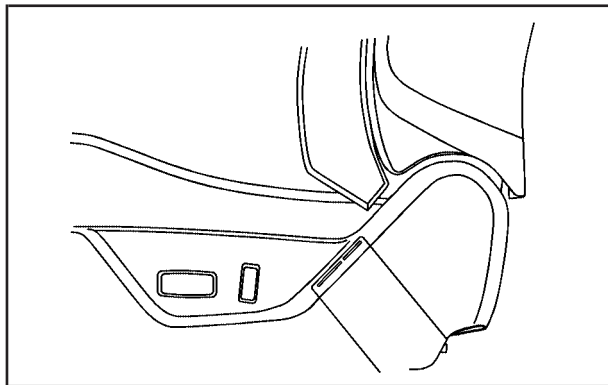

If the vehicle has power seats, the controls used to operate them are located on the outboard side of the seats.

- Move the seat forward or rearward by sliding the horizontal control forward or rearward.
- Raise or lower the front part of the seat cushion by moving the front of the horizontal control up or down.
- Raise or lower the rear part of the seat cushion by moving the rear of the horizontal control up or down.

- Raise or lower the entire seat by moving the entire horizontal control up or down.

The vertical control is used for reclining your seatback. See “Power Reclining Seatbacks” under *Reclining Seatbacks on page 1-8* for more information.

Power Lumbar

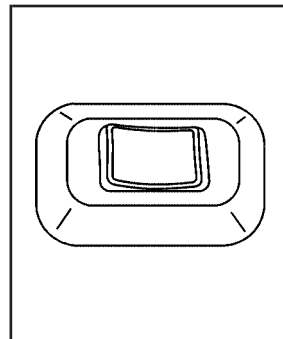

Your vehicle may have this feature. The driver's and passenger's seatback lumbar support can be adjusted by moving the control located on the outboard side of the seat cushions.

To increase or decrease support, hold the control forward or rearward. Keep in mind that as your seating position changes, as it may during long trips, so should the position of your lumbar support. Adjust the seat as needed.

Heated and Ventilated Seats

On vehicles with this feature, the buttons are located on the climate control panel.

 **(Heated Seat and Seatback):** Press for the heated seat and seatback.

 **(Ventilated Seat):** Press for the ventilated seat.

A light bar in the climate control display shows the setting; high, medium or low.

Press either button to start that feature at the highest setting. Each press of the button, decreases the setting.

To turn the feature off, press the button until the light turns off.

The heated or ventilated seats shut off when the vehicle is turned off.

Memory Seat and Mirrors

The buttons for this feature are located on the driver's door.

1: Saves the seating position for driver 1.

2: Saves the seating position for driver 2.

: Recalls the easy exit position.

To program the buttons:

1. Adjust the driver's seat including the seatback recliner and both outside mirrors.
2. Press and hold button 1 for at least three seconds. Two beeps sound to confirm that the seat and mirror positions have been saved.
3. Repeat the procedure for a second driver using button 2.

With an automatic transmission, the vehicle must be in PARK (P) to recall the stored driving positions.

With a manual transmission and the engine is running, the parking brake must be set to recall the memory seat driving positions. The stored driving positions can be recalled without setting the parking brake if the vehicle is off.

Press one of the numbered memory buttons to recall the stored setting. Each time a memory button is pressed, a single beep will sound.

Three chimes sound and the setting is not recalled if you press button 1 or 2 when the vehicle is not in PARK (P) on an automatic transmission or the parking brake is not set on a manual transmission.

To recall the stored driving positions when unlocking the vehicle with the transmitter or after the key is placed in the ignition, see *DIC Vehicle Customization on page 3-68*.

To stop recall movement of the memory feature at any time, press one of the power seat or mirror controls.

Two personalized exit positions can also be programmed. Use the following steps to program exit positions:

1. Press memory seat button 1, or the unlock button on the transmitter, to recall the driving position.
2. Adjust the driver's seat to the desired exit position.

3. Press and hold the exit button located above buttons 1 and 2 on the driver's door armrest for at least three seconds.

Two beeps sound to confirm that the exit position has been saved.

4. Repeat the procedure for a second driver using memory seat button 2 or the transmitter.

To recall the stored exit positions, press and release the exit button. One beep sounds, and the seat moves to the stored exit position for that driver. If an exit position has not been stored for this driver, the seat moves all the way back. The position of the outside mirrors does not change for the exit position.

If your vehicle has an automatic transmission, the vehicle must be in PARK (P) to recall the exit positions. If your vehicle has a manual transmission and the engine is running, the parking brake must be set to recall the stored exit positions.

Three chimes sound and the exit setting is not recalled if the exit button is pressed when the vehicle is not in PARK (P) on an automatic transmission or the parking brake is not set on a manual transmission.

To recall your stored exit positions when unlocking the vehicle with the transmitter, or when the ignition is turned off and the driver's door is opened, see *DIC Vehicle Customization on page 3-68*.

Reclining Seatbacks

Manual Reclining Seatbacks

CAUTION:

You can lose control of the vehicle if you try to adjust a manual driver's seat while the vehicle is moving. The sudden movement could startle and confuse you, or make you push a pedal when you do not want to. Adjust the driver's seat only when the vehicle is not moving.

CAUTION:

If the seatback is not locked, it could move forward in a sudden stop or crash. That could cause injury to the person sitting there. Always push and pull on the seatback to be sure it is locked.

If the front passenger's seat has a manual reclining seatback, the lever used to operate it is located on the outboard side of the seat.

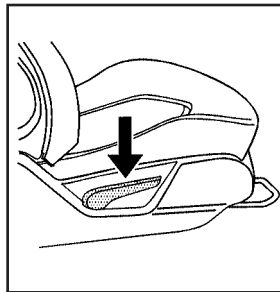

To recline the seatback, do the following:

1. Lift the recline lever.
2. Move the seatback to the desired position, then release the lever to lock the seatback in place.
3. Push and pull on the seatback to make sure it is locked.

To return the seatback to an upright position, do the following:

1. Lift the lever fully without applying pressure to the seatback and the seatback will return to the upright position.
2. Push and pull on the seatback to make sure it is locked.

Power Reclining Seatbacks

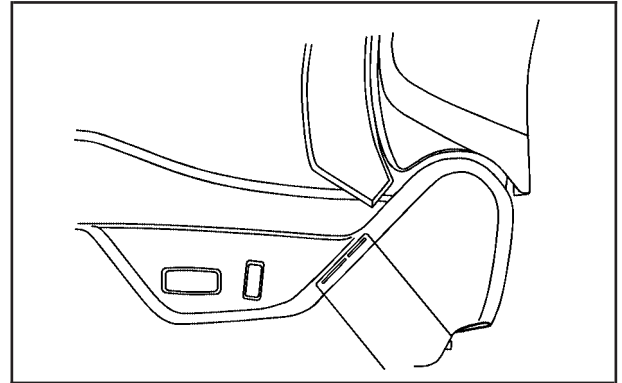

If your seats have power reclining seatbacks, use the vertical power seat control located on the outboard side of each seat.

- To recline the seatback, press the control toward the rear of the vehicle.
- To raise the seatback, press the control toward the front of the vehicle.

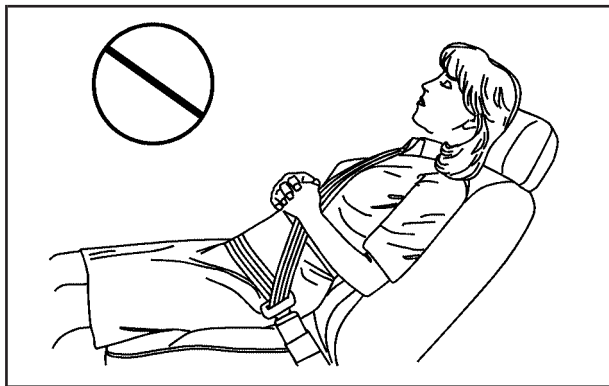

⚠ CAUTION:

Sitting in a reclined position when your vehicle is in motion can be dangerous. Even if you buckle up, your safety belts cannot do their job when you are reclined like this.

The shoulder belt cannot do its job. In a crash, you could go into it, receiving neck or other injuries.

The lap belt cannot do its job either. In a crash the belt could go up over your abdomen. The belt forces would be there, not at your pelvic bones. This could cause serious internal injuries.

For proper protection when the vehicle is in motion, have the seatback upright. Then sit well back in the seat and wear your safety belt properly.

Do not have a seatback reclined if your vehicle is moving.

Rear Seats

Split Folding Rear Seat

Your vehicle may have a split folding rear seat.

To lower one or both of the rear seatbacks:

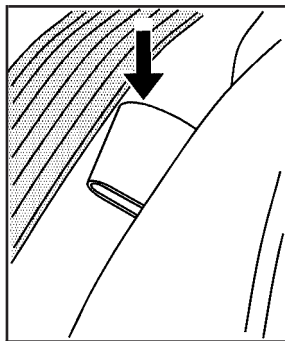

1. Pull forward on the tab, located on the outboard side of the seatback, to unlock the seatback.

Notice: Folding a rear seat with the safety belts still fastened may cause damage to the seat or the safety belts. Always unbuckle the safety belts and return them to their normal stowed position before folding a rear seat.

2. Fold the seatback down. This allows direct access to the trunk.

See *Trunk* on page 2-20 for more information.

To return the seatback to the upright position:

CAUTION:

If the seatback is not locked, it could move forward in a sudden stop or crash. That could cause injury to the person sitting there. Always push and pull on the seatback to be sure it is locked.

1. Lift the seatback up and push it back into place.
2. Make sure the seatback is locked into place by pushing and pulling on it.
3. Repeat Steps 1 and 3 for the other seatback.

When the seatback is not in use, it should be kept in the upright, locked position.

Safety Belts

Safety Belts: They Are for Everyone

This part of the manual tells you how to use safety belts properly. It also tells you some things you should not do with safety belts.

CAUTION:

Do not let anyone ride where he or she cannot wear a safety belt properly. If you are in a crash and you are not wearing a safety belt, your injuries can be much worse. You can hit things inside the vehicle harder or be ejected from it and be seriously injured or killed. In the same crash, you might not be, if you are buckled up. Always fasten your safety belt, and check that your passenger(s) are restrained properly too.

CAUTION:

It is extremely dangerous to ride in a cargo area, inside or outside of a vehicle. In a collision, people riding in these areas are more likely to be seriously injured or killed. Do not allow people to ride in any area of your vehicle that is not equipped with seats and safety belts. Be sure everyone in your vehicle is in a seat and using a safety belt properly.

Your vehicle has indicators as a reminder to buckle your safety belts. See *Safety Belt Reminders on page 3-32*.

In most states and in all Canadian provinces, the law requires wearing safety belts. Here is why:

You never know if you will be in a crash. If you do have a crash, you do not know if it will be a serious one.

A few crashes are mild, and some crashes can be so serious that even buckled up, a person would not survive. But most crashes are in between. In many of them, people who buckle up can survive and sometimes walk away. Without belts they could have been badly hurt or killed.

After more than 40 years of safety belts in vehicles, the facts are clear. In most crashes buckling up does matter... a lot!

Why Safety Belts Work

When you ride in or on anything, you go as fast as it goes.

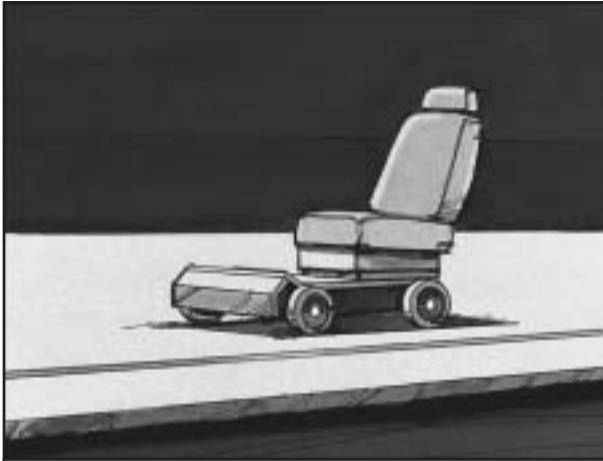

Take the simplest vehicle. Suppose it is just a seat on wheels.



Put someone on it.

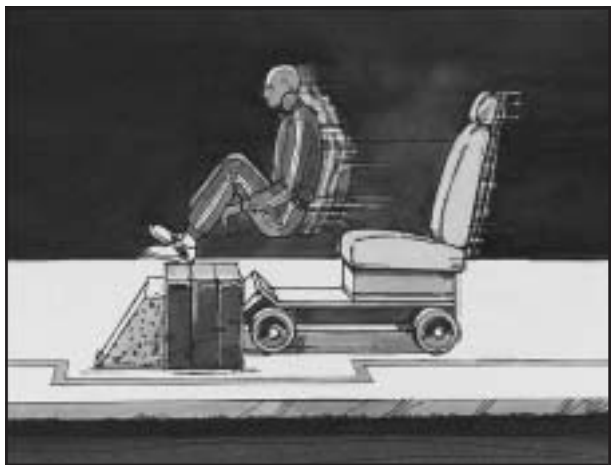

Get it up to speed. Then stop the vehicle. The rider does not stop.



The person keeps going until stopped by something. In a real vehicle, it could be the windshield...



or the instrument panel...



or the safety belts!

With safety belts, you slow down as the vehicle does. You get more time to stop. You stop over more distance, and your strongest bones take the forces. That is why safety belts make such good sense.

Questions and Answers About Safety Belts

Q: Will I be trapped in the vehicle after a crash if I am wearing a safety belt?

A: You *could* be — whether you are wearing a safety belt or not. But your chance of being conscious during and after an accident, so you *can* unbuckle and get out, is *much* greater if you are belted. And you can unbuckle a safety belt, even if you are upside down.

Q: If my vehicle has airbags, why should I have to wear safety belts?

A: Airbags are supplemental systems only; so they work *with* safety belts — not instead of them. Whether or not an airbag is provided, all occupants still have to buckle up to get the most protection. That is true not only in frontal collisions, but especially in side and other collisions.

Q: If I am a good driver, and I never drive far from home, why should I wear safety belts?

A: You may be an excellent driver, but if you are in a crash — even one that is not your fault — you and your passenger(s) can be hurt. Being a good driver does not protect you from things beyond your control, such as bad drivers.

Most accidents occur within 25 miles (40 km) of home. And the greatest number of serious injuries and deaths occur at speeds of less than 40 mph (65 km/h).

Safety belts are for everyone.

How to Wear Safety Belts Properly

This section is only for people of adult size.

Be aware that there are special things to know about safety belts and children. And there are different rules for smaller children and babies. If a child will be riding in your vehicle, see *Older Children on page 1-32* or *Infants and Young Children on page 1-35*. Follow those rules for everyone's protection.

It is very important for all occupants to buckle up. Statistics show that unbelted people are hurt more often in crashes than those who are wearing safety belts.

Occupants who are not buckled up can be thrown out of the vehicle in a crash. And they can strike others in the vehicle who are wearing safety belts.

First, before you or your passenger(s) wear a safety belt, there is important information you should know.

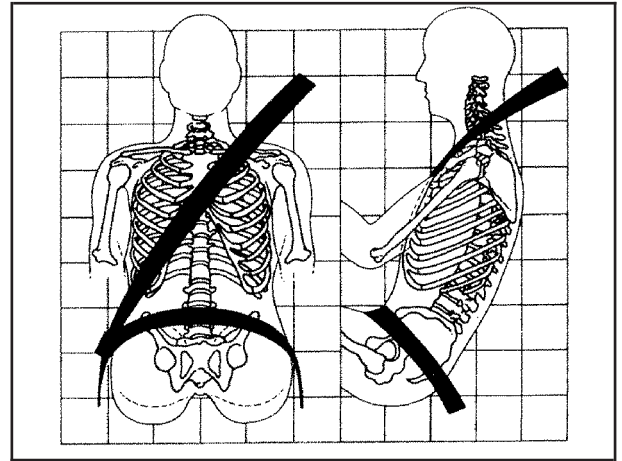

Sit up straight and always keep your feet on the floor in front of you. The lap part of the belt should be worn low and snug on the hips, just touching the thighs. In a crash, this applies force to the strong pelvic bones and you would be less likely to slide under the lap belt. If you slid under it, the belt would apply force on your abdomen. This could cause serious or even fatal injuries. The shoulder belt should go over the shoulder and across the chest. These parts of the body are best able to take belt restraining forces.

The shoulder belt locks if there is a sudden stop or crash.

Q: What is wrong with this?

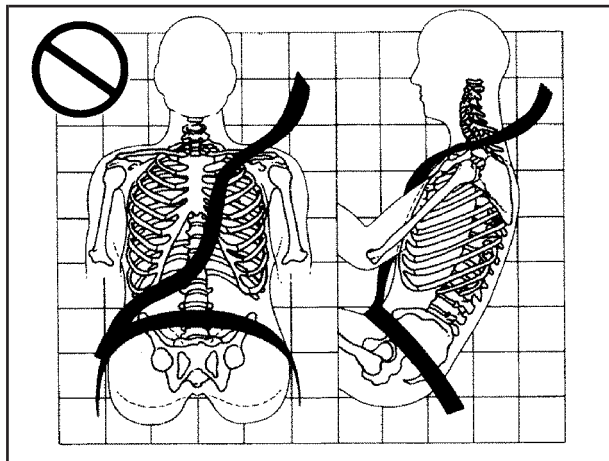

⚠ CAUTION:

You can be seriously hurt if your shoulder belt is too loose. In a crash, you would move forward too much, which could increase injury. The shoulder belt should fit snugly against your body.

A: The shoulder belt is too loose. It will not give as much protection this way.

Q: What is wrong with this?

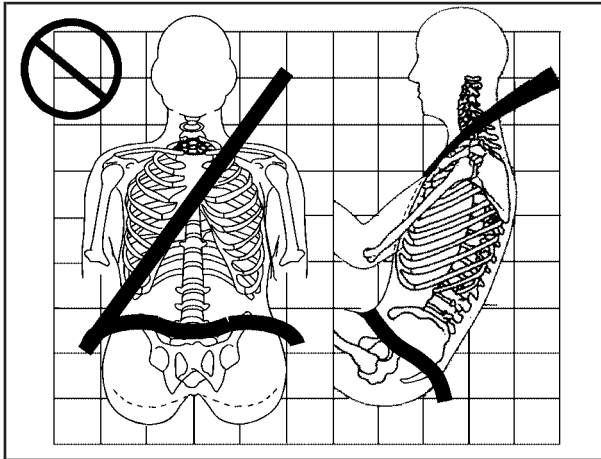

A: The lap belt is too loose. It will not give nearly as much protection this way.

⚠ CAUTION:

You can be seriously hurt if your lap belt is too loose. In a crash, you could slide under the lap belt and apply force on your abdomen. This could cause serious or even fatal injuries. The lap belt should be worn low and snug on the hips, just touching the thighs.

Q: What is wrong with this?



A: The belt is buckled in the wrong place.

⚠ CAUTION:

You can be seriously injured if your belt is buckled in the wrong place like this. In a crash, the belt would go up over your abdomen. The belt forces would be there, not on the pelvic bones. This could cause serious internal injuries. Always buckle your belt into the buckle nearest you.

Q: What is wrong with this?

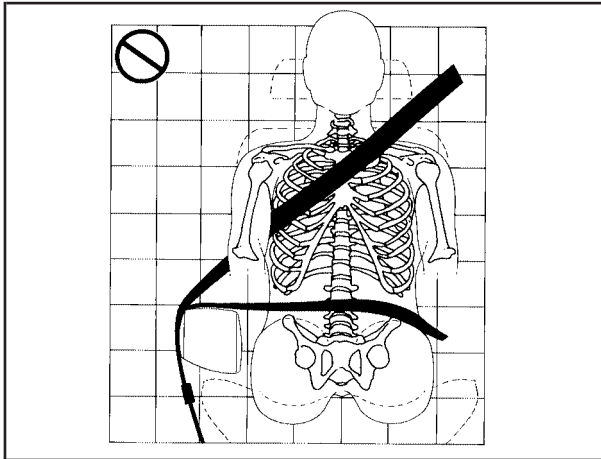

A: The belt is over an armrest.

⚠ CAUTION:

You can be seriously injured if your belt goes over an armrest like this. The belt would be much too high. In a crash, you can slide under the belt. The belt force would then be applied on the abdomen, not on the pelvic bones, and that could cause serious or fatal injuries. Be sure the belt goes under the armrests.

Q: What is wrong with this?

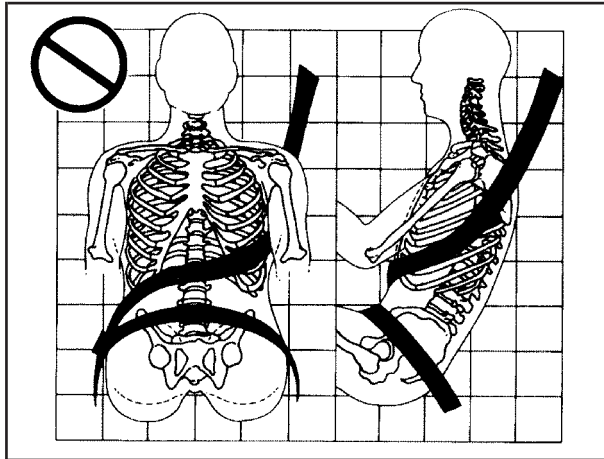

A: The shoulder belt is worn under the arm. It should be worn over the shoulder at all times.

⚠ CAUTION:

You can be seriously injured if you wear the shoulder belt under your arm. In a crash, your body would move too far forward, which would increase the chance of head and neck injury. Also, the belt would apply too much force to the ribs, which are not as strong as shoulder bones. You could also severely injure internal organs like your liver or spleen. The shoulder belt should go over the shoulder and across the chest.

Q: What is wrong with this?

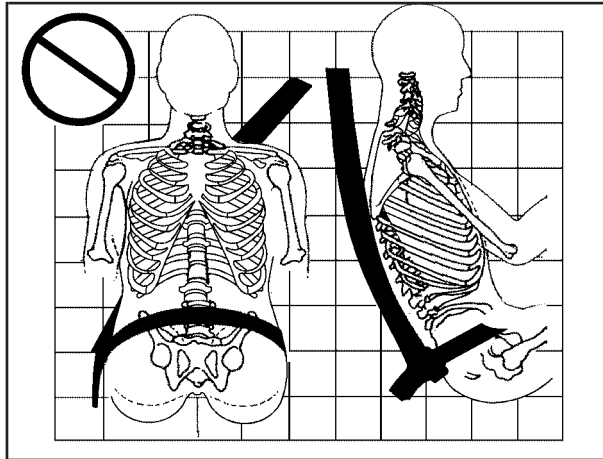

A: The belt is behind the body.

⚠ CAUTION:

You can be seriously injured by not wearing the lap-shoulder belt properly. In a crash, you would not be restrained by the shoulder belt. Your body could move too far forward increasing the chance of head and neck injury. You might also slide under the lap belt. The belt force would then be applied right on the abdomen. That could cause serious or fatal injuries. The shoulder belt should go over the shoulder and across the chest.

Q: What is wrong with this?

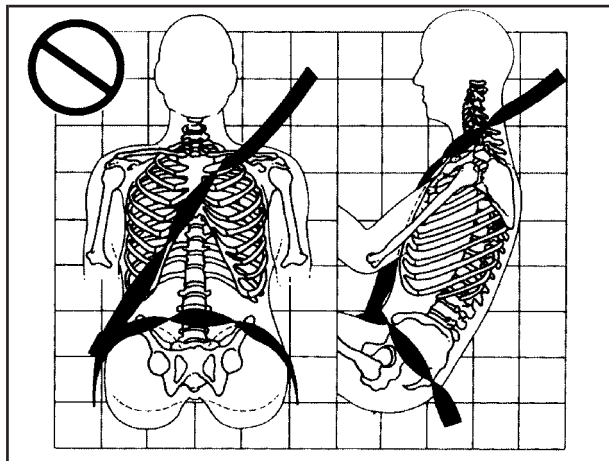

A: The belt is twisted across the body.

⚠ CAUTION:

You can be seriously injured by a twisted belt. In a crash, you would not have the full width of the belt to spread impact forces. If a belt is twisted, make it straight so it can work properly, or ask your dealer/retailer to fix it.

Lap-Shoulder Belt

All seating positions in your vehicle have a lap-shoulder belt.

Here is how to wear a lap-shoulder belt properly.

1. Adjust the seat, if the seat is adjustable, so you can sit up straight. To see how, see “Seats” in the Index.
2. Pick up the latch plate and pull the belt across you. Do not let it get twisted.

The lap-shoulder belt may lock if you pull the belt across you very quickly. If this happens, let the belt go back slightly to unlock it. Then pull the belt across you more slowly.

If you ever pull the shoulder portion of a passenger belt out all the way, you may engage the child restraint locking feature. If this happens, just let the belt go back all the way and start again.

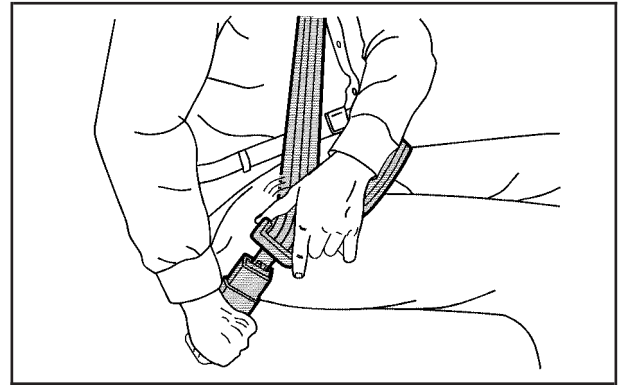

3. Push the latch plate into the buckle until it clicks. Pull up on the latch plate to make sure it is secure. If the belt is not long enough, see *Safety Belt Extender on page 1-31*. Make sure the release button on the buckle is positioned so you would be able to unbuckle the safety belt quickly if necessary.
4. If equipped with a shoulder belt height adjuster, move it to the height that is right for you. Improper shoulder belt height adjustment could reduce the effectiveness of the safety belt in a crash. See “Shoulder Belt Height Adjustment” later in this section.

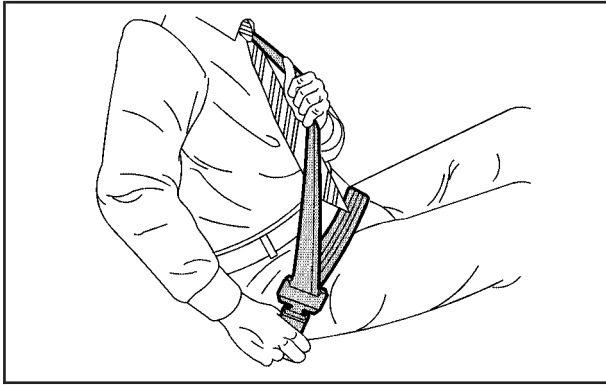

5. To make the lap part tight, pull up on the shoulder belt.

It may be necessary to pull stitching on the safety belt through the latch plate to fully tighten the lap belt on smaller occupants.

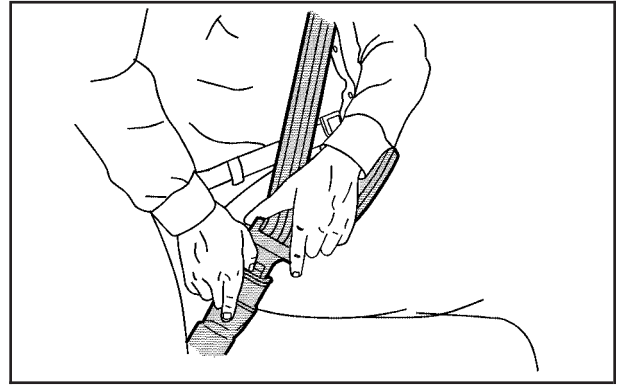

To unlatch the belt, just push the button on the buckle. The belt should go back out of the way.

Before you close a door, be sure the belt is out of the way. If you slam the door on it, you can damage both the belt and your vehicle.

Shoulder Belt Height Adjuster

Your vehicle has a shoulder belt height adjuster for the driver and right front passenger position.

Adjust the height so that the shoulder portion of the belt is centered on your shoulder. The belt should be away from your face and neck, but not falling off your shoulder. Improper shoulder belt height adjustment could reduce the effectiveness of the safety belt in a crash.

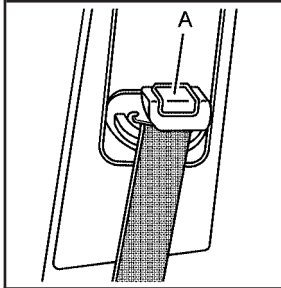

To move it down, press the release button (A) and move the height adjuster to the desired position. You can move the height adjuster up just by pushing up on the shoulder belt guide.

After you move the height adjuster to where you want it, try to move it down without pressing the release button to make sure it has locked into position.

Safety Belt Pretensioners

Your vehicle has safety belt pretensioners for front outboard occupants. Although you cannot see them, they are part of the safety belt assembly. They can help tighten the safety belts during the early stages of a moderate to severe frontal and near frontal crash if the threshold conditions for pretensioner activation are met. And, if your vehicle has side impact airbags, safety belt pretensioners can help tighten the safety belts in a side crash.

Pretensioners work only once. If they activate in a crash, you will need to get new ones, and probably other new parts for your safety belt system. See *Replacing Restraint System Parts After a Crash* on page 1-71.

Rear Safety Belt Comfort Guides

Rear shoulder belt comfort guides may provide added safety belt comfort for older children who have outgrown booster seats and for some adults. When installed on a shoulder belt, the comfort guide positions the belt away from the neck and head.

There is one guide for each outboard passenger position in the rear seat. Here is how to install a comfort guide to the safety belt:

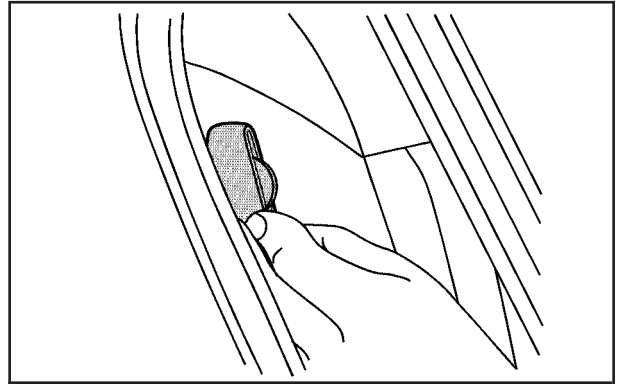

1. Pull the elastic cord out from between the edge of the seatback and the interior body to remove the guide from its storage clip.

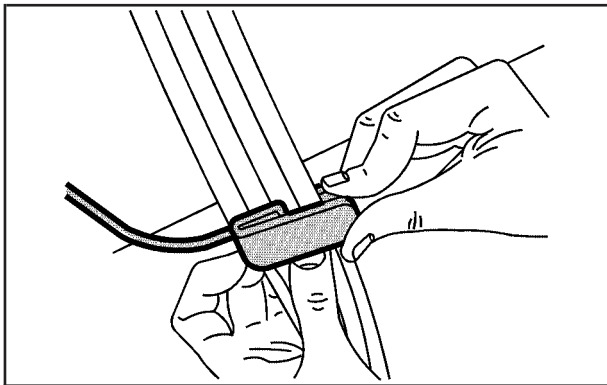

2. Place the guide over the belt and insert the two edges of the belt into the slots of the guide.

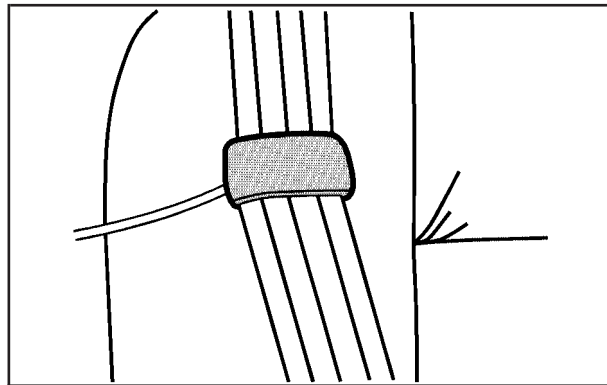

3. Be sure that the belt is not twisted and it lies flat. The elastic cord must be under the belt and the guide on top.

CAUTION:

A safety belt that is not properly worn may not provide the protection needed in a crash. The person wearing the belt could be seriously injured. The shoulder belt should go over the shoulder and across the chest. These parts of the body are best able to take belt restraining forces.

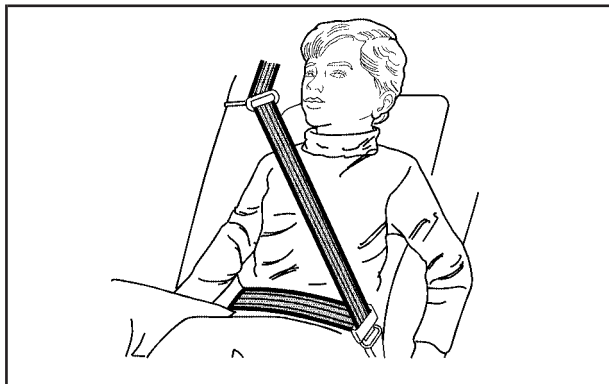

4. Buckle, position, and release the safety belt as described previously in this section. Make sure that the shoulder belt crosses the shoulder.

To remove and store the comfort guide, squeeze the belt edges together so that you can take them out of the guide. Pull the guide upward to expose its storage clip, and then slide the guide onto the clip. Turn the guide and clip inward and slide them in between the seatback and the interior body, leaving only the loop of the elastic cord exposed.

Safety Belt Use During Pregnancy

Safety belts work for everyone, including pregnant women. Like all occupants, they are more likely to be seriously injured if they do not wear safety belts.

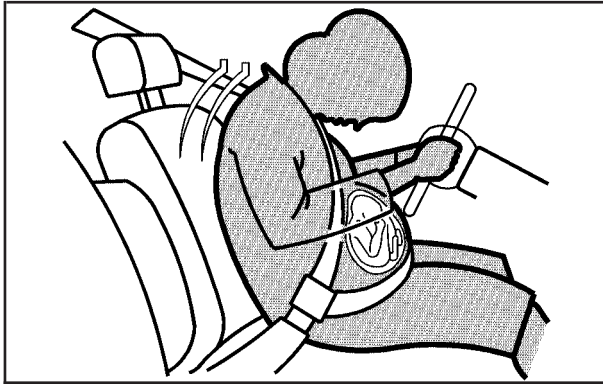

Safety Belt Extender

If the vehicle's safety belt will fasten around you, you should use it.

But if a safety belt is not long enough, your dealer/retailer will order you an extender. When you go in to order it, take the heaviest coat you will wear, so the extender will be long enough for you. To help avoid personal injury, do not let someone else use it, and use it only for the seat it is made to fit. The extender has been designed for adults. Never use it for securing child seats. To wear it, attach it to the regular safety belt. For more information, see the instruction sheet that comes with the extender.

A pregnant woman should wear a lap-shoulder belt, and the lap portion should be worn as low as possible, below the rounding, throughout the pregnancy.

The best way to protect the fetus is to protect the mother. When a safety belt is worn properly, it is more likely that the fetus will not be hurt in a crash. For pregnant women, as for anyone, the key to making safety belts effective is wearing them properly.

Child Restraints

Older Children

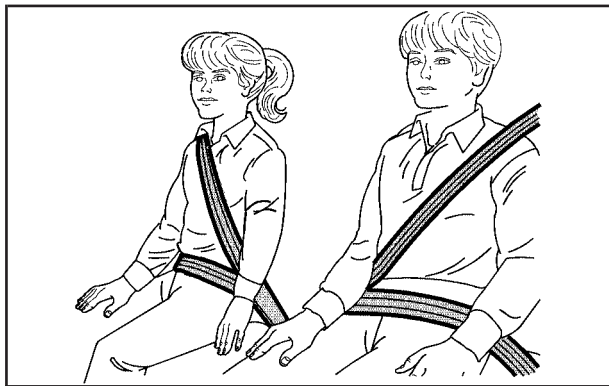

Older children who have outgrown booster seats should wear the vehicle's safety belts.

The manufacturer's instructions that come with the booster seat state the weight and height limitations for that booster. Use a booster seat with a lap-shoulder belt until the child passes the below fit test:

- Sit all the way back on the seat. Do the knees bend at the seat edge? If yes, continue. If no, return to the booster seat.
- Buckle the lap-shoulder belt. Does the shoulder belt rest on the shoulder? If yes, continue. If no, try using the rear safety belt comfort guide. See "Rear Safety Belt Comfort Guides" under *Lap-Shoulder Belt on page 1-25* for more information. If the shoulder belt still does not rest on the shoulder, then return to the booster seat.
- Does the lap belt fit low and snug on the hips, touching the thighs? If yes, continue. If no, return to the booster seat.
- Can proper safety belt fit be maintained for the length of the trip? If yes, continue. If no, return to the booster seat.

Q: What is the proper way to wear safety belts?

A: An older child should wear a lap-shoulder belt and get the additional restraint a shoulder belt can provide. The shoulder belt should not cross the face or neck. The lap belt should fit snugly below the hips, just touching the top of the thighs. This applies belt force to the child's pelvic bones in a crash. It should never be worn over the abdomen, which could cause severe or even fatal internal injuries in a crash.

Also see "Rear Safety Belt Comfort Guides" under *Lap-Shoulder Belt on page 1-25*.

According to accident statistics, children and infants are safer when properly restrained in the rear seating positions than in the front seating positions.

In a crash, children who are not buckled up can strike other people who are buckled up, or can be thrown out of the vehicle. Older children need to use safety belts properly.

⚠ CAUTION:

Never do this.

Here two children are wearing the same belt. The belt cannot properly spread the impact forces. In a crash, the two children can be crushed together and seriously injured. A belt must be used by only one person at a time.

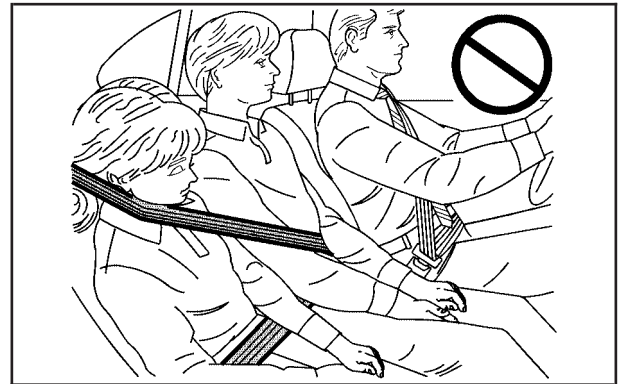

⚠ CAUTION:

Never do this.

Here a child is sitting in a seat that has a lap-shoulder belt, but the shoulder part is behind the child. In a crash, the child would not be restrained by the shoulder belt. The child might slide under the lap belt. The belt force would then be applied right on the abdomen. That could cause serious or fatal injuries. The child could also move too far forward increasing the chance of head and neck injury. The shoulder belt should go over the shoulder and across the chest.



Infants and Young Children

Everyone in a vehicle needs protection! This includes infants and all other children. Neither the distance traveled nor the age and size of the traveler changes the need, for everyone, to use safety restraints. In fact, the law in every state in the United States and in every Canadian province says children up to some age must be restrained while in a vehicle.

CAUTION:

Children can be seriously injured or strangled if a shoulder belt is wrapped around their neck and the safety belt continues to tighten. Never leave children unattended in a vehicle and never allow children to play with the safety belts.

Every time infants and young children ride in vehicles, they should have the protection provided by appropriate restraints. Children who are not restrained properly can strike other people, or can be thrown out of the vehicle. In addition, young children should not use the vehicle's adult safety belts alone; they need to use a child restraint.

⚠ CAUTION:

People should never hold an infant in their arms while riding in a vehicle. An infant does not weigh much — until a crash. During a crash an infant will become so heavy it is not possible to hold it. For example, in a crash at only 25 mph (40 km/h), a 12 lb (5.5 kg) infant will suddenly become a 240 lb (110 kg) force on a person's arms. An infant should be secured in an appropriate restraint.

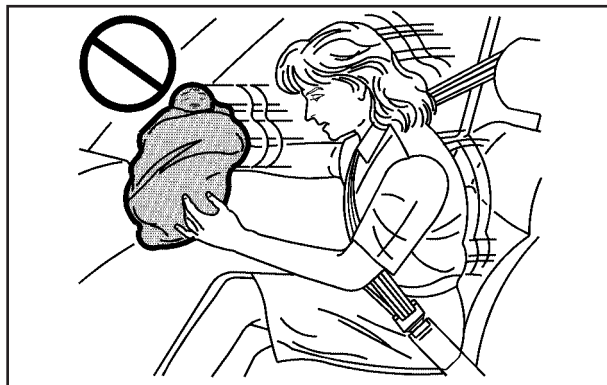

⚠ CAUTION:

Children who are up against, or very close to, any airbag when it inflates can be seriously injured or killed. Airbags plus lap-shoulder belts offer protection for adults and older children, but not for young children and infants. Neither the vehicle's safety belt system nor its airbag system is designed for them. Young children and infants need the protection that a child restraint system can provide.



Q: What are the different types of add-on child restraints?

A: Add-on child restraints, which are purchased by the vehicle's owner, are available in four basic types. Selection of a particular restraint should take into consideration not only the child's weight, height, and age but also whether or not the restraint will be compatible with the motor vehicle in which it will be used.

For most basic types of child restraints, there are many different models available. When purchasing a child restraint, be sure it is designed to be used in a motor vehicle. If it is, the restraint will have a label saying that it meets federal motor vehicle safety standards.

The restraint manufacturer's instructions that come with the restraint state the weight and height limitations for a particular child restraint. In addition, there are many kinds of restraints available for children with special needs.

 **CAUTION:**

Newborn infants need complete support, including support for the head and neck. This is necessary because a newborn infant's neck is weak and its head weighs so much compared with the rest of its body. In a crash, an infant in a rear-facing seat settles into the restraint, so the crash forces can be distributed across the strongest part of an infant's body, the back and shoulders. Infants should always be secured in appropriate infant restraints.

⚠ CAUTION:

The body structure of a young child is quite unlike that of an adult or older child, for whom the safety belts are designed. A young child's hip bones are still so small that the vehicle's regular safety belt may not remain low on the hip bones, as it should. Instead, it may settle up around the child's abdomen. In a crash, the belt would apply force on a body area that is unprotected by any bony structure. This alone could cause serious or fatal injuries. Young children should always be secured in appropriate child restraints.

Child Restraint Systems

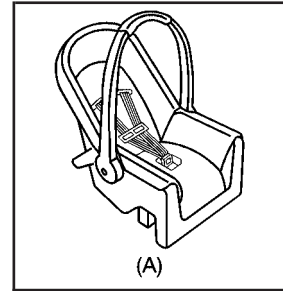

A rear-facing infant seat (A) provides restraint with the seating surface against the back of the infant.

The harness system holds the infant in place and, in a crash, acts to keep the infant positioned in the restraint.

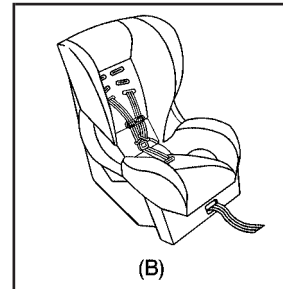

A forward-facing child seat (B) provides restraint for the child's body with the harness.

Securing an Add-On Child Restraint in the Vehicle

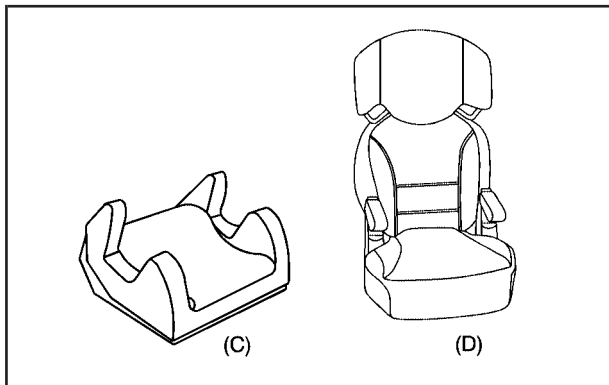

A booster seat (C-D) is a child restraint designed to improve the fit of the vehicle's safety belt system. A booster seat can also help a child to see out the window.

CAUTION:

A child can be seriously injured or killed in a crash if the child restraint is not properly secured in the vehicle. Make sure the child restraint is properly installed in the vehicle using the vehicle's safety belt or LATCH system, following the instructions that came with that restraint, and also the instructions in this manual.

To help reduce the chance of injury, the child restraint must be secured in the vehicle. Child restraint systems must be secured in vehicle seats by lap belts or the lap belt portion of a lap-shoulder belt, or by the LATCH system. See *Lower Anchors and Tethers for Children (LATCH)* on page 1-43 for more information. A child can be endangered in a crash if the child restraint is not properly secured in the vehicle.

When securing an add-on child restraint, refer to the instructions that come with the restraint which may be on the restraint itself or in a booklet, or both, and to this manual. The child restraint instructions are important, so if they are not available, obtain a replacement copy from the manufacturer.

Keep in mind that an unsecured child restraint can move around in a collision or sudden stop and injure people in the vehicle. Be sure to properly secure any child restraint in your vehicle — even when no child is in it.

Securing the Child Within the Child Restraint

CAUTION:

A child can be seriously injured or killed in a crash if the child is not properly secured in the child restraint. Because there are different systems, it is important to refer to the instructions that come with the restraint. Make sure the child is properly secured, following the instructions that came with that restraint.

Where to Put the Restraint

Accident statistics show that children are safer if they are restrained in the rear rather than the front seat.

We recommend that children and child restraints be secured in a rear seat, including: an infant or a child riding in a rear-facing child restraint; a child riding in a forward-facing child seat; an older child riding in a booster seat; and children, who are large enough, using safety belts.

A label on your sun visor says, "Never put a rear-facing child seat in the front." This is because the risk to the rear-facing child is so great, if the airbag deploys.

CAUTION:

A child in a rear-facing child restraint can be seriously injured or killed if the right front passenger's airbag inflates. This is because the back of the rear-facing child restraint would be very close to the inflating airbag.

Even though the passenger sensing system is designed to turn off the right front passenger's frontal airbag if the system detects a

CAUTION: (Continued)

CAUTION: (Continued)

rear-facing child restraint, no system is fail-safe, and no one can guarantee that an airbag will not deploy under some unusual circumstance, even though it is turned off. We recommend that rear-facing child restraints be secured in a rear seat, even if the airbag is off.

If you secure a forward-facing child restraint in the right front seat, always move the front passenger seat as far back as it will go. It is better to secure the child restraint in a rear seat.

See *Passenger Sensing System on page 1-64* for additional information.

When securing a child restraint in a rear seating position, study the instructions that came with your child restraint to make sure it is compatible with this vehicle.

Wherever you install a child restraint, be sure to secure the child restraint properly.

Keep in mind that an unsecured child restraint can move around in a collision or sudden stop and injure people in the vehicle. Be sure to properly secure any child restraint in your vehicle — even when no child is in it.

Lower Anchors and Tethers for Children (LATCH)

The LATCH system holds a child restraint during driving or in a crash. This system is designed to make installation of a child restraint easier. The LATCH system uses anchors in the vehicle and attachments on the child restraint that are made for use with the LATCH system.

Make sure that a LATCH-compatible child restraint is properly installed using the anchors, or use the vehicle's safety belts to secure the restraint, following the instructions that came with that restraint, and also the instructions in this manual. When installing a child restraint with a top tether, you must also use either the lower anchors or the safety belts to properly secure the child restraint. A child restraint must never be installed using only the top tether and anchor.

In order to use the LATCH system in your vehicle, you need a child restraint that has LATCH attachments. The child restraint manufacturer will provide you with instructions on how to use the child restraint and its attachments. The following explains how to attach a child restraint with these attachments in your vehicle.

Not all vehicle seating positions or child restraints have lower anchors and attachments or top tether anchors and attachments.

Lower Anchors

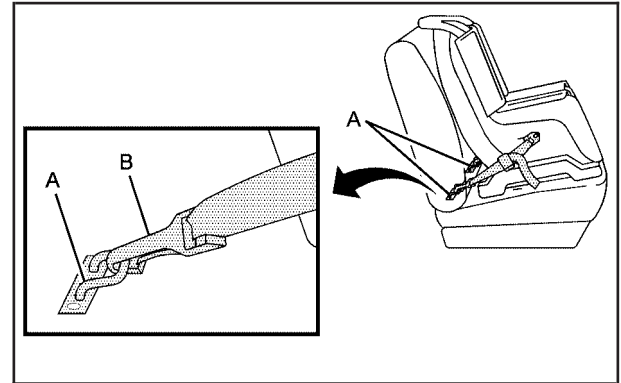

Lower anchors (A) are metal bars built into the vehicle. There are two lower anchors for each LATCH seating position that will accommodate a child restraint with lower attachments (B).

Top Tether Anchor

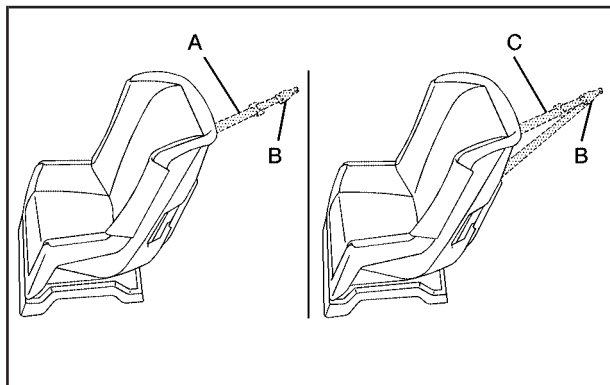

A top tether (A, C) anchors the top of the child restraint to the vehicle. A top tether anchor is built into the vehicle. The top tether attachment (B) on the child restraint connects to the top tether anchor in the vehicle in order to reduce the forward movement and rotation of the child restraint during driving or in a crash.

Your child restraint may have a single tether (A) or a dual tether (C). Either will have a single attachment (B) to secure the top tether to the anchor.

Some child restraints with top tethers are designed for use with or without the top tether being attached. Others require the top tether always to be attached. In Canada, the law requires that forward-facing child restraints have a top tether, and that the tether be attached. Be sure to read and follow the instructions for your child restraint.

If the child restraint does not have a top tether, one can be obtained, in kit form, for many child restraints. Ask the child restraint manufacturer whether or not a kit is available.

Lower Anchor and Top Tether Anchor Locations

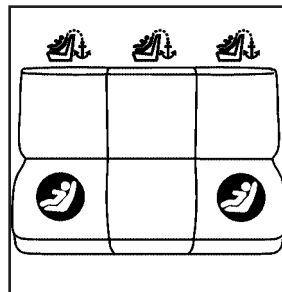

Rear Seat

 (Top Tether Anchor): Seating positions with top tether anchors.

 (Lower Anchor): Seating positions with two lower anchors.



To assist you in locating the lower anchors, each seating position with lower anchors has two labels, near the crease between the seatback and the seat cushion.

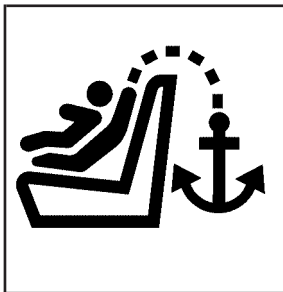

To assist you in locating the top tether anchors, the top tether anchor symbol is located on the cover.

The top tether anchors are located under the covers on the rear seatback filler panel. Be sure to use an anchor located on the same side of the vehicle as the seating position where the child restraint will be placed.

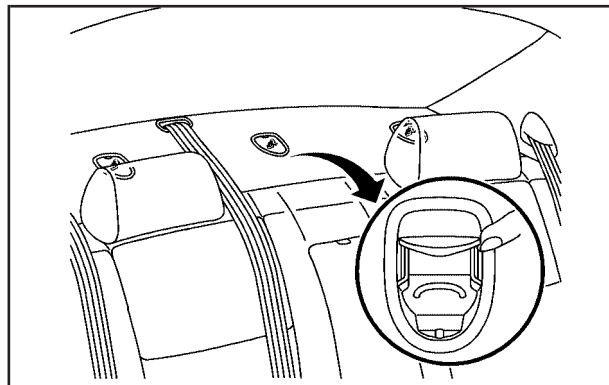

Do not secure a child restraint in a position without a top tether anchor if a national or local law requires that the top tether be attached, or if the instructions that come with the child restraint say that the top tether must be attached.

Accident statistics show that children are safer if they are restrained in the rear rather than the front seat. See *Where to Put the Restraint* on page 1-42 for additional information.

Securing a Child Restraint Designed for the LATCH System

CAUTION:

If a LATCH-type child restraint is not attached to anchors, the restraint will not be able to protect the child correctly. In a crash, the child could be seriously injured or killed. Make sure that a LATCH-type child restraint is properly installed using the anchors, or use the vehicle's safety belts to secure the restraint, following the instructions that came with that restraint, and also the instructions in this manual.

CAUTION:

Each top tether anchor and lower anchor in the vehicle is designed to hold only one child restraint. Attaching more than one child restraint to a single anchor could cause the anchor or attachment to come loose or even break during a crash. A child or others could be injured if this happens. To help prevent injury to people and damage to your vehicle, attach only one child restraint per anchor.

 **CAUTION:**

Children can be seriously injured or strangled if a shoulder belt is wrapped around their neck and the safety belt continues to tighten. Secure any unused safety belts behind the child restraint so children cannot reach them. Pull the shoulder belt all the way out of the retractor to set the lock, if your vehicle has one, after the child restraint has been installed. Be sure to follow the instructions of the child restraint manufacturer.

Notice: Contact between the child restraint LATCH attachment parts and the vehicle's safety belt assembly may cause damage to these parts. Make sure when securing unused safety belts behind the child restraint that there is no contact between the child restraint LATCH attachment parts and the vehicle's safety belt assembly.

Folding an empty rear seat with the safety belts secured may cause damage to the safety belt or the seat. When removing the child restraint, always remember to return the safety belts to their normal, stowed position before folding the rear seat.

1. Attach and tighten the lower attachments to the lower anchors. If the child restraint does not have lower attachments or the desired seating position does not have lower anchors, secure the child restraint with the top tether and the safety belts. Refer to your child restraint manufacturer instructions and the instructions in this manual.
 - 1.1. Find the lower anchors for the desired seating position.
 - 1.2. Put the child restraint on the seat.
 - 1.3. Attach and tighten the lower attachments on the child restraint to the lower anchors.
2. If the child restraint manufacturer recommends that the top tether be attached, attach and tighten the top tether to the top tether anchor, if equipped. Refer to the child restraint instructions and the following steps:
 - 2.1. Find the top tether anchor.
 - 2.2. Press the ribbed area of the cover to open the cover and expose the anchor.
 - 2.3. If you have an adjustable head restraint, raise the head restraint.

2.4. Route, attach and tighten the top tether according to your child restraint instructions and the following instructions:

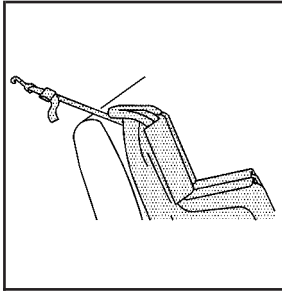

If the position you are using does not have a head restraint and you are using a single tether, route the tether over the seatback.

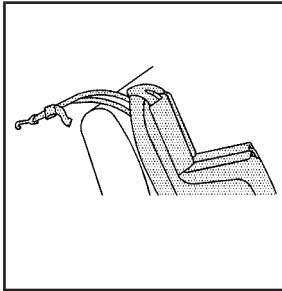

If the position you are using does not have a head restraint and you are using a dual tether, route the tether over the seatback.

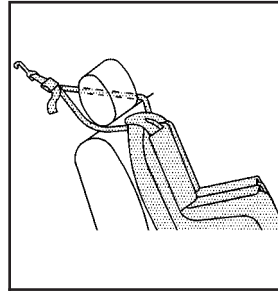

If the position you are using has a fixed head restraint and you are using a dual tether, route the tether around the head restraint.

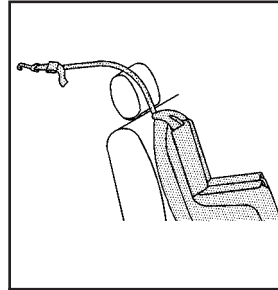

If the position you are using has a fixed head restraint and you are using a single tether, route the tether over the head restraint.

3. Push and pull the child restraint in different directions to be sure it is secure.

Securing a Child Restraint in a Rear Seat Position

When securing a child restraint in a rear seating position, study the instructions that came with your child restraint to make sure it is compatible with this vehicle.

If your child restraint has the LATCH system, see *Lower Anchors and Tethers for Children (LATCH)* on page 1-43 for how to install your child restraint using LATCH. If you secure a child restraint using a safety belt and it uses a top tether, see *Lower Anchors and Tethers for Children (LATCH)* on page 1-43 for top tether anchor locations.

Do not secure a child restraint in a position without a top tether anchor if a national or local law requires that the top tether be anchored, or if the instructions that come with the child restraint say that the top strap must be anchored.

In Canada, the law requires that forward-facing child restraints have a top tether, and that the tether be attached.

If your child restraint does not have the LATCH system, you will be using the safety belt to secure the child restraint in this position. Be sure to follow the instructions that came with the child restraint. Secure the child in the child restraint when and as the instructions say.

If you need to install more than one child restraint in the rear seat, be sure to read *Where to Put the Restraint* on page 1-42.

1. Put the child restraint on the seat.
2. Pick up the latch plate, and run the lap and shoulder portions of the vehicle's safety belt through or around the restraint. The child restraint instructions will show you how.



3. Push the latch plate into the buckle until it clicks.
Make sure the release button is positioned so you would be able to unbuckle the safety belt quickly if necessary.

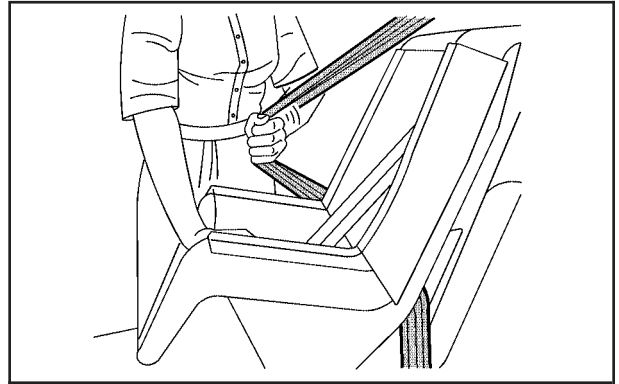

4. Pull the rest of the shoulder belt all the way out of the retractor to set the lock.

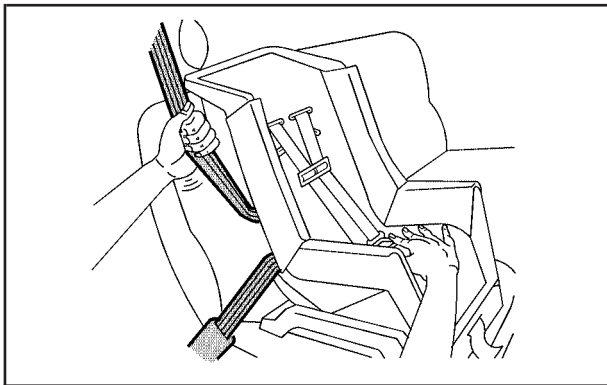

5. To tighten the belt, push down on the child restraint, pull the shoulder portion of the belt to tighten the lap portion of the belt, and feed the shoulder belt back into the retractor. If you are using a forward-facing child restraint, you may find it helpful to use your knee to push down on the child restraint as you tighten the belt.

6. If your child restraint has a top tether, follow the child restraint manufacturer's instructions regarding the use of the top tether. See *Lower Anchors and Tethers for Children (LATCH)* on page 1-43 for more information.
7. Push and pull the child restraint in different directions to be sure it is secure.

To remove the child restraint, unbuckle the vehicle's safety belt and let it go back all the way. If the top tether is attached to a top tether anchor, disconnect it.

Securing a Child Restraint in the Right Front Seat Position

Your vehicle has airbags. A rear seat is a safer place to secure a forward-facing child restraint. See *Where to Put the Restraint* on page 1-42.

In addition, your vehicle has a passenger sensing system which is designed to turn off the right front passenger's frontal airbag and seat-mounted side impact airbag under certain conditions. See *Passenger Sensing System* on page 1-64 and *Passenger Airbag Status Indicator* on page 3-34 for more information on this, including important safety information.

A label on your sun visor says, “Never put a rear-facing child seat in the front.” This is because the risk to the rear-facing child is so great, if the airbag deploys.

 **CAUTION:**

A child in a rear-facing child restraint can be seriously injured or killed if the right front passenger’s airbag inflates. This is because the back of the rear-facing child restraint would be very close to the inflating airbag.

Even though the passenger sensing system is designed to turn off the right front passenger’s frontal airbag if the system detects a rear-facing child restraint, no system is fail-safe, and no one can guarantee that an airbag will not deploy under some unusual circumstance, even though it is turned off. We recommend that rear-facing child restraints be secured in a rear seat, even if the airbag is off.

CAUTION: (Continued)

CAUTION: (Continued)

If you secure a forward-facing child restraint in the right front seat, always move the front passenger seat as far back as it will go. It is better to secure the child restraint in a rear seat.

See *Passenger Sensing System* on page 1-64 for additional information.

If your child restraint has the LATCH system, see *Lower Anchors and Tethers for Children (LATCH)* on page 1-43 for how to install your child restraint using LATCH. If you secure a child restraint using a safety belt and it uses a top tether, see *Lower Anchors and Tethers for Children (LATCH)* on page 1-43 for top tether anchor locations.

Do not secure a child seat in a position without a top tether anchor if a national or local law requires that the top tether be anchored, or if the instructions that come with the child restraint say that the top strap must be anchored.

In Canada, the law requires that forward-facing child restraints have a top tether, and that the tether be attached.

You will be using the lap-shoulder belt to secure the child restraint in this position. Follow the instructions that came with the child restraint.

1. Move the seat as far back as it will go before securing the forward-facing child restraint.

When the passenger sensing system has turned off the right front passenger's frontal airbag and seat-mounted side impact airbag, the off indicator on the passenger airbag status indicator should light and stay lit when you start the vehicle. See *Passenger Airbag Status Indicator on page 3-34*.

2. Put the child restraint on the seat.
3. Pick up the latch plate, and run the lap and shoulder portions of the vehicle's safety belt through or around the restraint. The child restraint instructions will show you how.

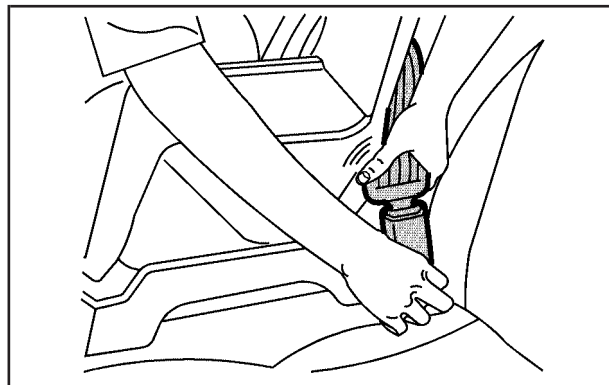

4. Push the latch plate into the buckle until it clicks. Make sure the release button is positioned so you would be able to unbuckle the safety belt quickly if necessary.

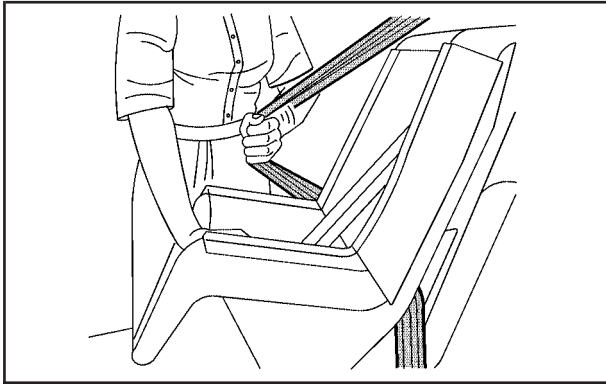

5. Pull the rest of the shoulder belt all the way out of the retractor to set the lock.

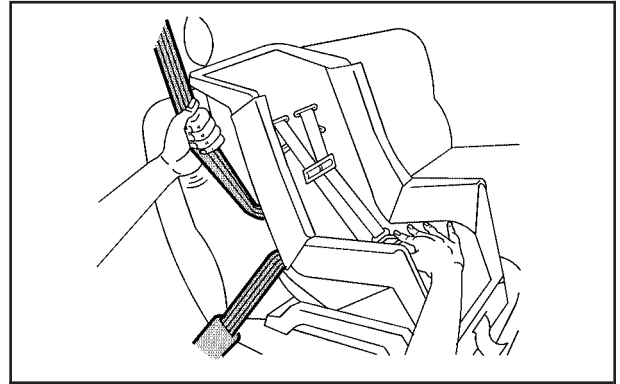

6. To tighten the belt, push down on the child restraint, pull the shoulder portion of the belt to tighten the lap portion of the belt and feed the shoulder belt back into the retractor. If you are using a forward-facing child restraint, you may find it helpful to use your knee to push down on the child restraint as you tighten the belt.
7. Push and pull the child restraint in different directions to be sure it is secure.

If the airbags are off, the off indicator in the passenger airbag status indicator will come on and stay on when the vehicle is started.

If a child restraint has been installed and the on indicator is lit, turn the vehicle off. Remove the child restraint from the vehicle and reinstall the child restraint.

If, after reinstalling the child restraint and restarting the vehicle, the on indicator is still lit, check to make sure that the vehicle's seatback is not pressing the child restraint into the seat cushion. If this happens, slightly recline the vehicle's seatback and adjust the seat cushion if possible. Also make sure the child restraint is not trapped under the vehicle head restraint. If this happens, adjust the head restraint.

Remove any additional material from the seat such as blankets, cushions, seat covers, seat heaters or seat massagers before reinstalling or securing the child restraint.

If the on indicator is still lit, secure the child in the child restraint in a rear seat position in the vehicle and check with your dealer/retailer.

To remove the child restraint, unbuckle the vehicle's safety belt and let it go back all the way.

Airbag System

Your vehicle has the following airbags:

- A frontal airbag for the driver.
- A frontal airbag for the right front passenger.
- A seat-mounted side impact airbag for the driver.
- A seat-mounted side impact airbag for the right front passenger.
- A roof-rail airbag for the driver and the passenger seated directly behind the driver.
- A roof-rail airbag for the right front passenger and the passenger seated directly behind the right front passenger.

All of the airbags in your vehicle will have the word AIRBAG embossed in the trim or on an attached label near the deployment opening.

For frontal airbags, the word AIRBAG will appear on the middle part of the steering wheel for the driver and on the instrument panel for the right front passenger.

With seat-mounted side impact airbags, the word AIRBAG will appear on the side of the seatback closest to the door.

With roof-rail airbags, the word AIRBAG will appear along the headliner or trim.

Airbags are designed to supplement the protection provided by safety belts. Even though today's airbags are also designed to help reduce the risk of injury from the force of an inflating bag, all airbags must inflate very quickly to do their job.

Here are the most important things to know about the airbag system:

 **CAUTION:**

You can be severely injured or killed in a crash if you are not wearing your safety belt — even if you have airbags. Wearing your safety belt during a crash helps reduce your chance of hitting things inside the vehicle or being ejected from it. Airbags are “supplemental restraints” to the safety belts. All airbags are designed to work with safety belts, but do not replace them.

 **CAUTION:**

Frontal airbags are designed to deploy in moderate to severe frontal and near frontal crashes. They are not designed to inflate in rollover, rear crashes, or in many side crashes.

Seat-mounted side impact airbags are designed to inflate in moderate to severe crashes where something hits the side of your vehicle. They are not designed to inflate in frontal, in rollover, or in rear crashes.

Roof-rail airbags are designed to inflate in moderate to severe crashes where something hits the side of your vehicle or in a severe frontal impact. They are not designed to inflate in rollover or rear crashes.

Everyone in your vehicle should wear a safety belt properly — whether or not there is an airbag for that person.

⚠ CAUTION:

Airbags inflate with great force, faster than the blink of an eye. Anyone who is up against, or very close to, any airbag when it inflates can be seriously injured or killed. Do not sit unnecessarily close to the airbag, as you would be if you were sitting on the edge of your seat or leaning forward. Safety belts help keep you in position before and during a crash. Always wear your safety belt, even with airbags. The driver should sit as far back as possible while still maintaining control of the vehicle.

Occupants should not lean on or sleep against the door or side windows in seating positions with seat-mounted side impact airbags and/or roof-rail airbags.

⚠ CAUTION:

Airbags plus lap-shoulder belts offer the best protection for adults, but not for young children and infants. Neither the vehicle's safety belt system nor its airbag system is designed for them. Young children and infants need the protection that a child restraint system can provide. Always secure children properly in your vehicle. To read how, see *Older Children on page 1-32* or *Infants and Young Children on page 1-35*.



There is an airbag readiness light on the instrument panel cluster, which shows the airbag symbol.

The system checks the airbag electrical system for malfunctions. The light tells you if there is an electrical problem. See *Airbag Readiness Light on page 3-33* for more information.

Where Are the Airbags?



The driver's frontal airbag is in the middle of the steering wheel.



The right front passenger's frontal airbag is in the instrument panel on the passenger's side.



Driver Side shown, Passenger Side similar

The seat-mounted side impact airbags for the driver and right front passenger are in the side of the seatbacks closest to the door.



Driver Side shown, Passenger Side similar

The roof-rail airbags for the driver, right front passenger, and second row outboard passengers are in the ceiling above the side windows.

CAUTION:

If something is between an occupant and an airbag, the airbag might not inflate properly or it might force the object into that person causing severe injury or even death. The path of an inflating airbag must be kept clear. Do not put anything between an occupant and an airbag, and do not attach or put anything on the steering wheel hub or on or near any other airbag covering.

Do not use seat accessories that block the inflation path of a seat-mounted side impact airbag.

If your vehicle has roof-rail airbags, never secure anything to the roof of your vehicle by routing the rope or tie down through any door or window opening. If you do, the path of an inflating roof-rail airbag will be blocked.

When Should an Airbag Inflate?

Frontal airbags are designed to inflate in moderate to severe frontal or near-frontal crashes to help reduce the potential for severe injuries mainly to the driver's or right front passenger's head and chest. However, they are only designed to inflate if the impact exceeds a predetermined deployment threshold. Deployment thresholds are used to predict how severe a crash is likely to be in time for the airbags to inflate and help restrain the occupants.

Whether your frontal airbags will or should deploy is not based on how fast your vehicle is traveling. It depends largely on what you hit, the direction of the impact, and how quickly your vehicle slows down.

Frontal airbags may inflate at different crash speeds. For example:

- If the vehicle hits a stationary object, the airbags could inflate at a different crash speed than if the vehicle hits a moving object.
- If the vehicle hits an object that deforms, the airbags could inflate at a different crash speed than if the vehicle hits an object that does not deform.
- If the vehicle hits a narrow object (like a pole), the airbags could inflate at a different crash speed than if the vehicle hits a wide object (like a wall).
- If the vehicle goes into an object at an angle, the airbags could inflate at a different crash speed than if the vehicle goes straight into the object.

Thresholds can also vary with specific vehicle design.

Frontal airbags are not intended to inflate during vehicle rollovers, rear impacts, or in many side impacts.

In addition, your vehicle has a dual-stage driver airbag. Dual-stage airbags adjust the restraint according to crash severity. Your vehicle has electronic frontal sensors, which help the sensing system distinguish between a moderate frontal impact and a more severe frontal impact. For moderate frontal impacts, dual-stage airbags inflate at a level less than full deployment. For more severe frontal impacts, full deployment occurs.

Your vehicle also has a dual-depth passenger airbag that adjusts the restraint according to crash severity, seat location, and safety belt status using electronic frontal sensors and other special sensors which enable the sensing system to monitor the position of the front passenger seat. The passenger airbag inflates to a reduced depth when the passenger seat is in a forward position. For more rearward front seating positions, the passenger airbag may inflate to an increased depth (a full deployment), based on the crash severity measured early in the event. (Always wear your safety belt, even with frontal airbags.)

Your vehicle has seat position sensors which enables the sensing system to monitor the position of the driver's and right front passenger's seat. Seat position sensors

provide information that is used to determine if the airbags should deploy at a reduced level or at full deployment.

Your vehicle has seat-mounted side impact and roof-rail airbags. See *Airbag System on page 1-55*. Seat-mounted side impact and roof-rail airbags are intended to inflate in moderate to severe side crashes. In addition, these roof-rail airbags are intended to inflate in a severe frontal impact. Seat-mounted side impact and roof-rail airbags will inflate if the crash severity is above the system's designed threshold level. The threshold level can vary with specific vehicle design.

Seat-mounted side impact airbags are not intended to inflate in frontal impacts, near-frontal impacts, rollovers, or rear impacts. Roof-rail airbags are not intended to inflate in rollovers or rear impacts. A seat-mounted side impact airbag is intended to deploy on the side of the vehicle that is struck. Both roof-rail airbags will deploy when either side of the vehicle is struck or in a severe frontal impact.

In any particular crash, no one can say whether an airbag should have inflated simply because of the damage to a vehicle or because of what the repair costs were. For frontal airbags, inflation is determined by what the vehicle hits, the angle of the impact, and how quickly the vehicle slows down. For seat-mounted side impact and roof-rail airbags, deployment is determined by the location and severity of the side impact.

What Makes an Airbag Inflate?

In a deployment event, the sensing system sends an electrical signal triggering a release of gas from the inflator. Gas from the inflator fills the airbag causing the bag to break out of the cover and deploy. The inflator, the airbag, and related hardware are all part of the airbag module.

Frontal airbag modules are located inside the steering wheel and instrument panel. For vehicles with seat-mounted side impact airbags, there are airbag modules in the side of the front seatbacks closest to the door. For vehicles with roof-rail airbags, there are airbag modules in the ceiling of the vehicle, near the side windows that have occupant seating positions.

How Does an Airbag Restrain?

In moderate to severe frontal or near frontal collisions, even belted occupants can contact the steering wheel or the instrument panel. In moderate to severe side collisions, even belted occupants can contact the inside of the vehicle.

Airbags supplement the protection provided by safety belts. Frontal airbags distribute the force of the impact more evenly over the occupant's upper body, stopping the occupant more gradually. Seat-mounted

side impact and roof-rail airbags distribute the force of the impact more evenly over the occupant's upper body.

But airbags would not help in many types of collisions, primarily because the occupant's motion is not toward those airbags. See *When Should an Airbag Inflate?* on page 1-60 for more information.

Airbags should never be regarded as anything more than a supplement to safety belts.

What Will You See After an Airbag Inflates?

After the frontal airbags and seat-mounted side impact airbags inflate, they quickly deflate, so quickly that some people may not even realize an airbag inflated. Roof-rail airbags may still be at least partially inflated for some time after they deploy. Some components of the airbag module may be hot for several minutes. For location of the airbag modules, see *What Makes an Airbag Inflate?* on page 1-62.

The parts of the airbag that come into contact with you may be warm, but not too hot to touch. There may be some smoke and dust coming from the vents in the deflated airbags. Airbag inflation does not prevent the driver from seeing out of the windshield or being able to steer the vehicle, nor does it prevent people from leaving the vehicle.

 **CAUTION:**

When an airbag inflates, there may be dust in the air. This dust could cause breathing problems for people with a history of asthma or other breathing trouble. To avoid this, everyone in the vehicle should get out as soon as it is safe to do so. If you have breathing problems but cannot get out of the vehicle after an airbag inflates, then get fresh air by opening a window or a door. If you experience breathing problems following an airbag deployment, you should seek medical attention.

Your vehicle has a feature that may automatically unlock the doors, turn the interior lamps on, and turn the hazard warning flashers on when the airbags inflate. You can lock the doors, turn the interior lamps off, and turn the hazard warning flashers off by using the controls for those features.

In many crashes severe enough to inflate the airbag, windshields are broken by vehicle deformation. Additional windshield breakage may also occur from the right front passenger airbag.

- Airbags are designed to inflate only once. After an airbag inflates, you will need some new parts for the airbag system. If you do not get them, the airbag system will not be there to help protect you in another crash. A new system will include airbag modules and possibly other parts. The service manual for your vehicle covers the need to replace other parts.
- Your vehicle has a crash sensing and diagnostic module which records information after a crash. See *Vehicle Data Recording and Privacy on page 7-16* and *Event Data Recorders on page 7-17*.
- Let only qualified technicians work on the airbag systems. Improper service can mean that an airbag system will not work properly. See your dealer/retailer for service.

Passenger Sensing System

Your vehicle has a passenger sensing system for the right front passenger's position. The passenger airbag status indicator will be visible on the instrument panel when you start your vehicle.



United States

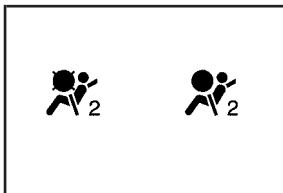

Canada

The words ON and OFF, or the symbol for on and off, will be visible during the system check. If you are using remote start to start your vehicle from a distance, if equipped, you may not see the system check. When the system check is complete, either the word ON or the word OFF, or the symbol for on or the symbol for off, will be visible. See *Passenger Airbag Status Indicator on page 3-34*.

The passenger sensing system will turn off the right front passenger's frontal airbag and seat-mounted side impact airbag under certain conditions. The driver's airbags are not part of the passenger sensing system.

The passenger sensing system works with sensors that are part of the right front passenger's seat. The sensors are designed to detect the presence of a properly-seated occupant and determine if the right front passenger's frontal airbag and seat-mounted side impact airbag should be enabled (may inflate) or not.

Accident statistics show that children are safer if they are restrained in the rear rather than the front seat.

We recommend that children be secured in a rear seat, including: an infant or a child riding in a rear-facing child restraint; a child riding in a forward-facing child seat; an older child riding in a booster seat; and children, who are large enough, using safety belts.

A label on your sun visor says, "Never put a rear-facing child seat in the front." This is because the risk to the rear-facing child is so great, if the airbag deploys.

CAUTION:

A child in a rear-facing child restraint can be seriously injured or killed if the right front passenger's airbag inflates. This is because the back of the rear-facing child restraint would be very close to the inflating airbag.

CAUTION: (Continued)

CAUTION: (Continued)

Even though the passenger sensing system is designed to turn off the right front passenger's frontal and seat-mounted side impact airbag (if equipped) if the system detects a rear-facing child restraint, no system is fail-safe, and no one can guarantee that an airbag will not deploy under some unusual circumstance, even though it is turned off. We recommend that rear-facing child restraints be secured in a rear seat, even if the airbag(s) are off.

If you secure a forward-facing child restraint in the right front seat, always move the front passenger seat as far back as it will go. It is better to secure the child restraint in a rear seat.

The passenger sensing system is designed to turn off the right front passenger's frontal airbag and seat-mounted side impact airbag if:

- The right front passenger seat is unoccupied.
- The system determines that an infant is present in a rear-facing infant seat.

- The system determines that a small child is present in a child restraint.
- The system determines that a small child is present in a booster seat.
- A right front passenger takes his/her weight off of the seat for a period of time.
- The right front passenger seat is occupied by a smaller person, such as a child who has outgrown child restraints.
- Or, if there is a critical problem with the airbag system or the passenger sensing system.

When the passenger sensing system has turned off the right front passenger's frontal airbag and seat-mounted side impact airbag, the off indicator will light and stay lit to remind you that the airbags are off. See *Passenger Airbag Status Indicator on page 3-34*.

If a child restraint has been installed and the on indicator is lit, turn the vehicle off. Remove the child restraint from the vehicle and reinstall the child restraint following the child restraint manufacturer's directions and refer to *Securing a Child Restraint in the Right Front Seat Position on page 1-51*.

If, after reinstalling the child restraint and restarting the vehicle, the on indicator is still lit, check to make sure that the vehicle's seatback is not pressing the child restraint into the seat cushion. If this happens, slightly recline the vehicle's seatback and adjust the seat cushion if possible. Also make sure the child restraint is not trapped under the vehicle head restraint. If this happens, adjust the head restraint. See *Head Restraints* on page 1-2.

Remove any additional material from the seat such as blankets, cushions, seat covers, seat heaters, or seat massagers before reinstalling or securing the child restraint.

If the on indicator is still lit, secure the child in the child restraint in a rear seat position in the vehicle, and check with your dealer/retailer.

The passenger sensing system is designed to enable (may inflate) the right front passenger's frontal airbag and seat-mounted side impact airbag anytime the system senses that a person of adult size is sitting properly in the right front passenger's seat. When the passenger sensing system has allowed the airbags to be enabled, the on indicator will light and stay lit to remind you that the airbags are active.

For some children who have outgrown child restraints and for very small adults, the passenger sensing system may or may not turn off the right front passenger's frontal airbag and seat-mounted side impact airbag, depending upon the person's seating posture and body build. Everyone in your vehicle who has outgrown child restraints should wear a safety belt properly — whether or not there is an airbag for that person.

If a person of adult-size is sitting in the right front passenger's seat, but the off indicator is lit, it could be because that person is not sitting properly in the seat. If this happens, turn the vehicle off, remove any additional material from the seat, such as blankets, cushions, seat covers, seat heaters or seat massagers and ask the person to place the seatback in the fully upright position, then sit upright in the seat, centered on the seat cushion, with the person's legs comfortably extended. Restart the vehicle and have the person remain in this position for two to three minutes. This will allow the system to detect that person and then enable the right front passenger's frontal airbag and seat-mounted side impact airbag.



Safety belts help keep the passenger in position on the seat during vehicle maneuvers and braking, which helps the passenger sensing system maintain the passenger airbag status. See “Safety Belts” and “Child Restraints” in the Index for additional information about the importance of proper restraint use.

⚠ CAUTION:

If the airbag readiness light in the instrument panel cluster ever comes on and stays on, it means that something may be wrong with the airbag system. If this ever happens, have the vehicle serviced promptly, because an adult-size person sitting in the right front passenger's seat may not have the protection of the airbag(s). See *Airbag Readiness Light on page 3-33* for more on this, including important safety information.

A thick layer of additional material, such as a blanket or cushion, or aftermarket equipment such as seat covers, seat heaters, and seat massagers can affect how well the passenger sensing system operates. We recommend that you not use seat covers or other aftermarket equipment other than any that GM has approved for your specific vehicle. See *Adding Equipment to Your Airbag-Equipped Vehicle* on page 1-69 for more information about modifications that can affect how the system operates.

 **CAUTION:**

Stowing of articles under the passenger's seat or between the passenger's seat cushion and seatback may interfere with the proper operation of the passenger sensing system.

Servicing Your Airbag-Equipped Vehicle

Airbags affect how your vehicle should be serviced. There are parts of the airbag system in several places around your vehicle. Your dealer/retailer and the service manual have information about servicing your vehicle and the airbag system. To purchase a service manual, see *Service Publications Ordering Information* on page 7-15.

 **CAUTION:**

For up to 10 seconds after the ignition is turned off and the battery is disconnected, an airbag can still inflate during improper service. You can be injured if you are close to an airbag when it inflates. Avoid yellow connectors. They are probably part of the airbag system. Be sure to follow proper service procedures, and make sure the person performing work for you is qualified to do so.

Adding Equipment to Your Airbag-Equipped Vehicle

Q: Is there anything I might add to or change about the vehicle that could keep the airbags from working properly?

A: Yes. If you add things that change your vehicle's frame, bumper system, height, front end or side sheet metal, they may keep the airbag system from working properly. Changing or moving any parts of the front seats, safety belts, the airbag sensing and diagnostic module, steering wheel, instrument panel, roof-rail airbag modules, ceiling headliner or pillar garnish trim, front sensors, or airbag wiring can affect the operation of the airbag system.

In addition, your vehicle has a passenger sensing system for the right front passenger's position, which includes sensors that are part of the passenger's seat. The passenger sensing system may not operate properly if the original seat trim is replaced with non-GM covers, upholstery or trim, or with GM covers, upholstery or trim designed for a different vehicle. Any object, such as an aftermarket seat heater or a comfort enhancing pad or device, installed under or on top of the

seat fabric, could also interfere with the operation of the passenger sensing system. This could either prevent proper deployment of the passenger airbag(s) or prevent the passenger sensing system from properly turning off the passenger airbag(s). See *Passenger Sensing System on page 1-64*.

If you have any questions about this, you should contact Customer Assistance before you modify your vehicle. The phone numbers and addresses for Customer Assistance are in Step Two of the Customer Satisfaction Procedure in this manual. See *Customer Satisfaction Procedure on page 7-2*.

Q: Because I have a disability, I have to get my vehicle modified. How can I find out whether this will affect my airbag system?

A: If you have questions, call Customer Assistance. The phone numbers and addresses for Customer Assistance are in Step Two of the Customer Satisfaction Procedure in this manual. See *Customer Satisfaction Procedure on page 7-2*.

In addition, your dealer/retailer and the service manual have information about the location of the airbag sensors, sensing and diagnostic module and airbag wiring.

Restraint System Check

Checking the Restraint Systems

Safety Belts

Now and then, make sure the safety belt reminder light and all your belts, buckles, latch plates, retractors and anchorages are working properly.

Look for any other loose or damaged safety belt system parts. If you see anything that might keep a safety belt system from doing its job, have it repaired. Torn or frayed safety belts may not protect you in a crash. They can rip apart under impact forces. If a belt is torn or frayed, get a new one right away.

Make sure the safety belt reminder light is working. See *Safety Belt Reminders on page 3-32* for more information.

Keep safety belts clean and dry. See *Care of Safety Belts on page 5-114*.

Airbags

The airbag system does not need regularly scheduled maintenance or replacement. Make sure the airbag readiness light is working. See *Airbag Readiness Light on page 3-33* for more information.

Notice: If an airbag covering is damaged, opened, or broken, the airbag may not work properly. Do not open or break the airbag coverings. If there are any opened or broken airbag covers, have the airbag covering and/or airbag module replaced. For the location of the airbag modules, see *What Makes an Airbag Inflate? on page 1-62*. See your dealer/retailer for service.

Replacing Restraint System Parts After a Crash

CAUTION:

A crash can damage the restraint systems in your vehicle. A damaged restraint system may not properly protect the person using it, resulting in serious injury or even death in a crash. To help make sure your restraint systems are working properly after a crash, have them inspected and any necessary replacements made as soon as possible.

If you have had a crash, do you need new belts or LATCH system (if equipped) parts?

After a very minor crash, nothing may be necessary. But the belt assemblies that were used during any crash may have been stressed or damaged. See your dealer/retailer to have your safety belt assemblies inspected or replaced.

If your vehicle has the LATCH system and it was being used during a crash, you may need new LATCH system parts.

New parts and repairs may be necessary even if the belt or LATCH system (if equipped), was not being used at the time of the crash.

If an airbag inflates, you will need to replace airbag system parts. See the part on the airbag system earlier in this section.

Have your safety belt pretensioners checked if your vehicle has been in a crash, if your airbag readiness light stays on after you start your vehicle, or while you are driving. See *Airbag Readiness Light* on page 3-33.

Section 2 Features and Controls

Keys	2-3	Starting and Operating Your Vehicle	2-31
Remote Keyless Entry (RKE) System	2-5	New Vehicle Break-In	2-31
Keyless Access System	2-6	Ignition Positions (Key Access)	2-31
Remote Keyless Entry (RKE) System		Ignition Positions (Keyless Access)	2-33
Operation	2-7	Retained Accessory Power (RAP)	2-34
Keyless Access System Operation	2-9	Starting the Engine	2-34
Remote Vehicle Start	2-14	Engine Coolant Heater	2-36
Doors and Locks	2-17	Automatic Transmission Operation	2-37
Door Locks	2-17	Manual Transmission Operation	2-41
Central Door Unlocking System	2-17	Parking Brake	2-43
Power Door Locks	2-18	Shifting Into PARK (P) (Automatic	
Delayed Locking	2-18	Transmission)	2-44
Programmable Automatic Door Locks	2-18	Shifting Out of PARK (P)	2-45
Rear Door Security Locks	2-19	Parking Your Vehicle (Manual Transmission)	2-46
Lockout Protection	2-20	Parking Over Things That Burn	2-47
Trunk	2-20	Engine Exhaust	2-47
Windows	2-23	Running the Vehicle While Parked	2-48
Power Windows	2-24	Mirrors	2-49
Sun Visors	2-26	Automatic Dimming Rearview Mirror with	
Theft-Deterrent Systems	2-27	OnStar®	2-49
Theft-Deterrent System	2-27	Outside Power Mirrors	2-49
Immobilizer	2-28	Park Tilt Mirrors	2-50
Immobilizer Operation (Key Access)	2-28	Outside Convex Mirror	2-50
Immobilizer Operation (Keyless Access)	2-30	Outside Heated Mirrors	2-50

Section 2 Features and Controls

Object Detection Systems	2-51	Storage Areas	2-61
Ultrasonic Rear Parking Assist (URPA)	2-51	Glove Box	2-61
OnStar® System	2-53	Cupholder(s)	2-61
Universal Home Remote System	2-56	Instrument Panel Storage	2-61
Universal Home Remote System	2-56	Center Console Storage	2-61
Universal Home Remote System Operation (With One Triangular LED)	2-57	Convenience Net	2-62
		Sunroof	2-62

Keys

CAUTION:

Leaving children in a vehicle with the ignition key is dangerous for many reasons, children or others could be badly injured or even killed. They could operate the power windows or other controls or even make the vehicle move. The windows will function with the keys in the ignition and they could be seriously injured or killed if caught in the path of a closing window. Do not leave the keys in a vehicle with children.

CAUTION:

Leaving children in a vehicle with the keyless access transmitter is dangerous for many reasons, children or others could be badly injured or even killed. They could operate the power windows or other controls or even make

CAUTION: (Continued)

CAUTION: (Continued)

the vehicle move. The windows will function with the keyless access transmitter in the vehicle and they could be seriously injured or killed if caught in the path of a closing window. Do not leave the keyless access transmitter in a vehicle with children.

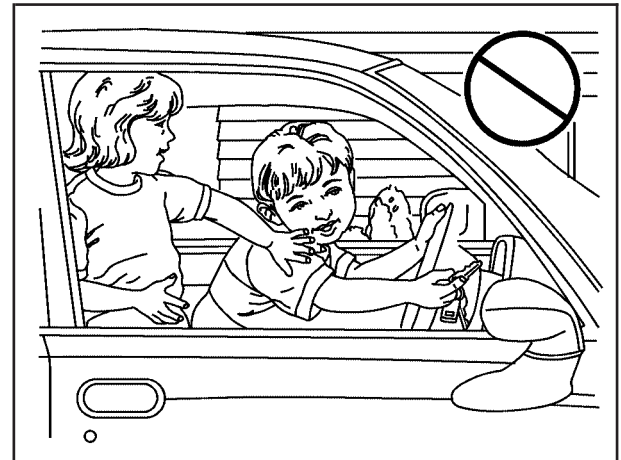

You will have either of the following keys.

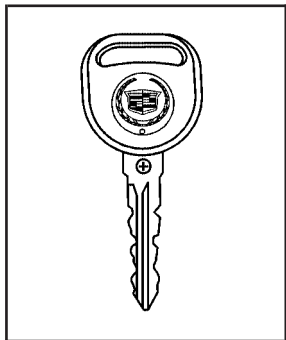

This key can be used for the driver's door, ignition, and glove box.

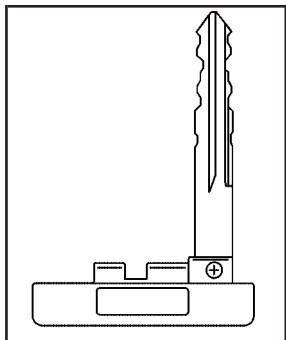

This key, located inside the keyless access transmitter, can be used for the driver's door, glove box, and rear seat pass-through door. See "Rear Seat Pass-Through Door" under *Trunk* on page 2-20 for more information.

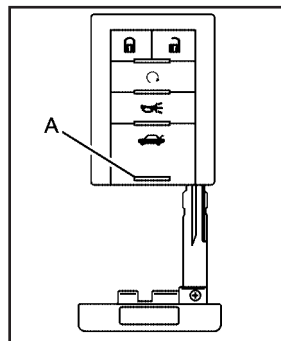

To remove the key, press the button (A) near the bottom of the keyless access transmitter, and pull the key out. Never pull the key out without pressing the button.

Your vehicle may have the Keyless Access System. See *Ignition Positions (Key Access)* on page 2-31 or *Ignition Positions (Keyless Access)* on page 2-33 for information on starting the vehicle.

Notice: If you ever lock your keys in your vehicle, you may have to damage the vehicle to get in. Be sure you have spare keys.

In an emergency, contact Roadside Assistance. See *Roadside Service* on page 7-6.

Remote Keyless Entry (RKE) System

If the vehicle has the Remote Keyless Entry (RKE) system, it operates on a radio frequency subject to Federal Communications Commission (FCC) Rules and with Industry Canada.

This device complies with Part 15 of the FCC Rules. Operation is subject to the following two conditions:

1. This device may not cause interference.
2. This device must accept any interference received, including interference that may cause undesired operation of the device.

This device complies with RSS-210 of Industry Canada. Operation is subject to the following two conditions:

1. This device may not cause interference.
2. This device must accept any interference received, including interference that may cause undesired operation of the device.

Changes or modifications to this system by other than an authorized service facility could void authorization to use this equipment.

At times you may notice a decrease in range. This is normal for any RKE system. If the transmitter does not work or if you have to stand closer to your vehicle for the transmitter to work, try this:

- Check the distance. You may be too far from your vehicle. You may need to stand closer during rainy or snowy weather.
- Check the location. Other vehicles or objects may be blocking the signal. Take a few steps to the left or right, hold the transmitter higher, and try again.
- Check to determine if battery replacement is necessary. See “Battery Replacement” later in this section.
- If you are still having trouble, see your dealer/retailer or a qualified technician for service.

Keyless Access System

Your vehicle may have a Keyless Access System that operates on a radio frequency subject to Federal Communications Commission (FCC) Rules and with Industry Canada.

This device complies with Part 15 of the FCC Rules. Operation is subject to the following two conditions:

1. This device may not cause harmful interference.
2. This device must accept any interference received, including interference that may cause undesired operation.

This device complies with RSS-210 of Industry Canada. Operation is subject to the following two conditions:

1. This device may not cause interference.
2. This device must accept any interference received, including interference that may cause undesired operation of the device.

Changes or modifications to this system by other than an authorized service facility could void authorization to use this equipment.

If you ever notice a decrease in the keyless access transmitter range, try doing one of the following:

- Check the distance. You may be too far from your vehicle. You may need to stand closer during rainy or snowy weather.
- Check the location. Other vehicles or objects may be blocking the signal. Take a few steps to the left or right, hold the transmitter higher, and try again.
- Check to determine if battery replacement is necessary. See “Battery Replacement” under *Keyless Access System Operation on page 2-9*.
- Check to make sure that an electronic device such as a cellular phone or lap top computer is not causing interference.
- If you are still having trouble, see your dealer/retailer or a qualified technician for service.

Remote Keyless Entry (RKE) System Operation

The Remote Keyless Entry (RKE) transmitter functions, including lock, unlock, remote trunk release and vehicle locator/panic alarm will work up to 65 feet (20 m) away.

There are other conditions which can affect the performance of the transmitter. See *Remote Keyless Entry (RKE) System* on page 2-5.

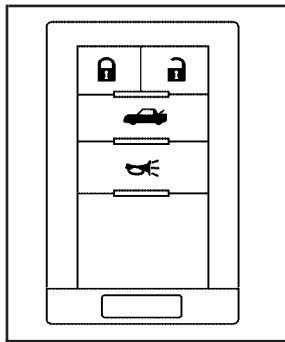

🔒 (Lock): Press 🔒 to lock all the doors. If enabled through the Driver Information Center (DIC), the parking lamps may flash once to indicate locking has occurred, or the horn may chirp when 🔒 is pressed again

within five seconds from the previous press of the lock button. See *DIC Vehicle Customization* on page 3-68 for additional information.

🔓 (Unlock): Press 🔓 to unlock the driver's door. If 🔓 is pressed again within five seconds, all remaining doors will unlock. The interior lamps will come on and stay on for 20 seconds or until the ignition is turned on. If enabled through the DIC, the parking lamps will flash twice to indicate unlocking has occurred. See *DIC Vehicle Customization* on page 3-68.

🚗 (Remote Trunk Release): Press and hold 🚗 for about one second to release the trunk lid. The transmission must be in PARK (P) for this feature to operate.

🚗 (Vehicle Locator/Panic Alarm): Press and release 🚗 to locate your vehicle. The turn signal lamps will flash and the horn will sound three times.

Press and hold 🚗 for more than two seconds to activate the panic alarm. The turn signal lamps will flash and the horn will sound repeatedly for 30 seconds. The alarm will turn off when the ignition is moved to START or 🚗 is pressed again. The ignition must be in LOCK/OFF for the panic alarm to work.

Matching Transmitter(s) to Your Vehicle

Each RKE transmitter is coded to prevent another transmitter from unlocking your vehicle. If a transmitter is lost or stolen, a replacement can be purchased through your dealer/retailer. All transmitters need to be re-coded to match the new transmitter.

The lost transmitter will no longer work after the new transmitters are re-coded. The vehicle can have a maximum of eight transmitters matched to it. See "Relearn Remote Key" under *DIC Operation and Displays* on page 3-48.

Battery Replacement

Replace the battery if the Replace Battery In Remote Key message displays in the DIC. See "Replace Battery In Remote Key" under *DIC Warnings and Messages* on page 3-54 for additional information.

Notice: When replacing the battery, use care not to touch any of the circuitry. Static from your body transferred to these surfaces may damage the transmitter.

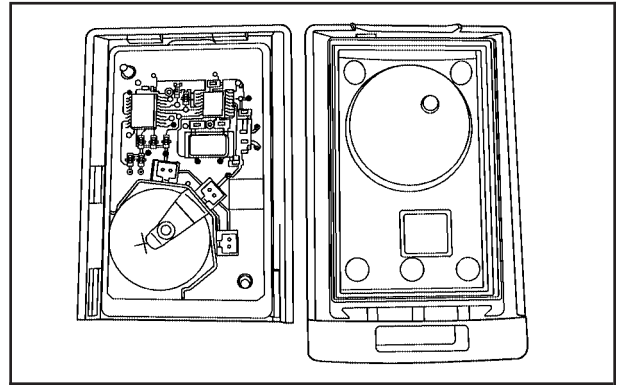

To replace the battery in the RKE transmitter:

1. Separate the halves of the transmitter with a flat, thin object inserted into the notch, located above the metal base.
2. Remove the old battery. Do not use a metal object.
3. Insert the new battery, positive side facing up. Replace with a CR2032 or equivalent battery.
4. Put the transmitter back together tightly.

Keyless Access System Operation

Your vehicle may have a Keyless Access System that lets you lock and unlock your vehicle's doors, open the trunk lid, remotely start the engine, and locate your vehicle or sound your vehicle's alarm from a distance as much as 195 feet (60 m) away.

The Keyless Access System also lets you lock and unlock the vehicle's doors and access the trunk without removing the remote transmitter from your pocket, purse, briefcase, etc. The system operates when a front door handle is pulled or the remote trunk release button is pressed. You must have the keyless access transmitter with you and within 3 feet (1 m) of the door or trunk you are opening. See "Keyless Locking" and "Keyless Unlock" under *DIC Vehicle Customization on page 3-68*.

There are other conditions which can affect the performance of the transmitter. See *Keyless Access System on page 2-6*.

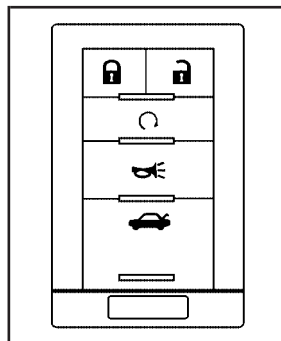



With Remote Start Shown, Without Similar

Your vehicle comes with two transmitters.

🔒 (Lock): Press 🔒 to lock the doors. The turn signal indicators will flash. If 🔒 is pressed twice, the doors will lock, the turn signal indicators will flash twice, and the horn will sound once.



You can program your vehicle so the turn signal indicators will not flash and the horn will not sound when pressing 🔒 on the keyless access transmitter. For more information see "Remote Door Lock" under *DIC Vehicle Customization on page 3-68*.



 **(Unlock):** Press  once to unlock the driver's door. The turn signal indicators will flash twice.



Press  twice within five seconds to unlock all the doors. If it is dark enough outside, your interior lamps will come on.



You can program your vehicle so the turn signal indicators will not flash and the fog lamps and reverse lamps remain on steady for about 20 seconds when the keyless access transmitter is used to unlock the vehicle. See "Remote Door Unlock" under *DIC Vehicle Customization on page 3-68*.

If your vehicle has the memory feature you can program and recall memory settings when you press  on the keyless access transmitter. See *Memory Seat and Mirrors on page 1-6* for more information.

 **(Remote Start):** If your vehicle has this feature, press  after pressing  to operate the remote start feature. See *Remote Vehicle Start on page 2-14* for additional information.

 **(Trunk):** Press and hold  for about one second to open the trunk while the engine is turned off or the shift lever is in PARK (P).

 **(Vehicle Locator/Panic Alarm):** Press and release  to locate your vehicle. The horn will chirp three times and the turn signal lamps will flash three times.

Press and hold  for three seconds to sound the panic alarm. The horn will chirp and the turn signal lamps will flash for 30 seconds. Press and release  again to cancel the panic alarm.

Matching Transmitter(s) to Your Vehicle

Each Keyless Access System is coded to allow only transmitters programmed to your vehicle to work. If a transmitter is lost or stolen, a replacement can be purchased and programmed through your dealer/retailer. Your dealer/retailer can reprogram your vehicle so lost or stolen transmitters no longer work with your vehicle. Each vehicle can have a maximum of four transmitters matched to it.

To match a new transmitter to your vehicle when you have a recognized transmitter, do the following. Two recognized transmitters are required for Canadian owners.

1. The vehicle must be off.
2. Have the recognized transmitter and the new, unrecognized transmitter(s) with you.
3. Insert the vehicle key into the key lock cylinder located on the outside of the driver's door.
4. Turn the key to the unlock position five times within five seconds.
5. The Driver Information Center (DIC) will display Ready To Learn Electronic Key #X, where X can be 2, 3 or 4.
6. Place the new, unrecognized transmitter into the transmitter pocket with the transmitter buttons facing the front of the vehicle. The transmitter pocket is inside the center console storage area located between the driver and front passenger seats.
7. Once the transmitter is programmed, a beep will sound. The DIC will display Ready To Learn Electronic Key #X, where X can be 3 or 4, or Maximum # Electronic Keys Learned.
8. Press the ignition control knob to exit programming mode.
9. Remove the transmitter from the transmitter pocket and press the unlock button on the keyless access transmitter two times.

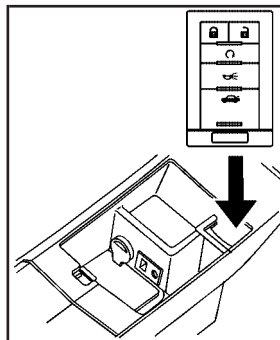

The Canadian immobilizer standard requires Canadian owners to see their dealer/retailer for matching new transmitters when two recognized transmitters are not available. United States owners are permitted to match a new transmitter to their vehicle when a recognized transmitter is not available.

The procedure will require three, ten minute cycles to complete the matching process.

1. The vehicle must be off.

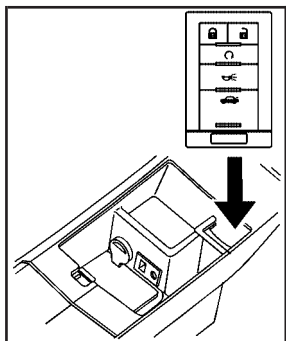

2. Place the new, unrecognized transmitter into the transmitter pocket with the transmitter buttons facing the front of the vehicle. The transmitter pocket is inside the center console storage area located between the driver and front passenger seats.

3. Insert the vehicle key into the key lock cylinder located on the driver's door.
4. Turn the key to the unlock position five times within five seconds.
5. The DIC will display Press Start Control To Learn Keys.
6. Press the ignition switch in.
7. The DIC will read Learn Delay Active Wait XX Min and will count down to zero, one minute at a time.
8. The DIC will display Press Start Control To Learn Keys again.
9. Press the ignition switch in again.
10. The DIC will again read Learn Delay Active Wait XX Min and will count down to zero, one minute at a time.
The DIC will display Press Start Control To Learn Keys again.
11. Press the ignition switch in again.
12. The DIC will again read Learn Delay Active Wait XX Min and will count down to zero, one minute at a time.

14. A beep will sound and the DIC will read Ready To Learn Electronic Key # X. At this time, all previously known transmitters have been erased.
15. Once the transmitter is recognized and programmed, a beep will sound and the DIC will display Ready To Learn Electronic Key # X.
16. To program additional transmitters, insert each transmitter in the pocket until you hear a beep and the DIC advances to the next electronic key number.
17. When complete, press the ignition control knob.
18. Press the unlock button on each transmitter programmed to complete programming.

Up to four transmitters can be programmed to the vehicle. The DIC will display Maximum # Electronic Keys Learned and will exit the programming mode.

After performing this process, transmitters previously programmed will no longer work with your vehicle and must be reprogrammed.

Battery Replacement

Replace the battery if the Replace Battery In Remote Key message displays in the DIC. See "REPLACE BATTERY IN REMOTE KEY" under *DIC Warnings and Messages on page 3-54* for additional information.

A weak battery may also cause the DIC to display Electronic Key Not Detected when you try to start the vehicle. If this happens, place the transmitter in the center console storage area transmitter pocket with the buttons facing to the front of the vehicle. Then, with the vehicle in PARK (P) or NEUTRAL (N), press the brake pedal and the ignition control knob. See *Starting the Engine on page 2-34*, for additional information about your vehicle's electronic keyless ignition with push start. Although this will start the vehicle, it is recommended that you replace the transmitter battery as soon as possible.

Notice: When replacing the battery, use care not to touch any of the circuitry. Static from your body transferred to these surfaces may damage the transmitter.

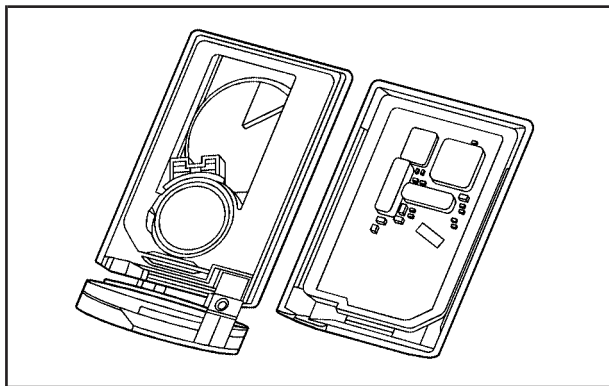

To replace the battery:

1. Separate the halves of the transmitter with a flat, thin object inserted into the slot on the side or back of the transmitter.
2. Remove the old battery. Do not use a metal object.
3. Insert the new battery, positive side facing down. Replace with a CR2032 or equivalent battery.
4. Put the transmitter back together tightly.

Remote Vehicle Start

If your vehicle has this feature, it allows you to start the engine from outside of the vehicle. It may also start the vehicle's automatic climate control system. When the remote start system is active, the climate control system will heat and cool the inside of the vehicle according to the previous settings of the system before turning the vehicle off. The windshield defroster or rear window defogger will be turned on by the climate control system when it is cold outside. If the vehicle has heated seats, they will also turn on. See *Heated and Ventilated Seats* on page 1-6 for additional information. Normal operation of the climate control system will return after the ignition is turned to ON/RUN. See *Dual Climate Control System* on page 3-23.

Laws in some communities may restrict the use of remote starters. For example, some laws may require a person using remote start to have the vehicle in view when doing so. Check local regulations for any requirements on remote starting of vehicles.

Do not use the remote start feature if your vehicle is low on fuel. Your vehicle may run out of fuel.

Your transmitter, with the remote start button, provides an increased range of operation. However, the range may be less while the vehicle is running. As a result, you may need to be closer to your vehicle to turn it off, than you were to turn it on.

There are other conditions which can affect the performance of the transmitter, see *Remote Keyless Entry (RKE) System on page 2-5* or *Keyless Access System on page 2-6* for additional information.

Q (Remote Start): Press and release the lock button and then press and hold this button to use the remote start feature.

To start the vehicle using the remote start feature:

1. Aim the transmitter at the vehicle.
2. Press and release the transmitter's lock button, then immediately press and hold the transmitter's remote start button until the turn signal lights flash or if the vehicle's lights are not visible, press and hold the remote start button for at least four seconds. The vehicle's doors will lock. Pressing the remote start button again after the vehicle has started will turn off the ignition.

When the vehicle starts, the parking lamps will turn on and remain on while the vehicle is running.

3. If it is the first remote start since the vehicle has been driven, repeat these steps, while the engine is still running, to extend the engine running time by 10 minutes. Remote start can be extended one time.

After entering the vehicle during a remote start, press the brake pedal and turn the ignition to ON/RUN to drive the vehicle.

If the vehicle is left running it will automatically shut off after 10 minutes unless a time extension has been done.

To manually shut off a remote start:

- Aim the transmitter at the vehicle and press the remote start button until the parking lamps turn off.
- Turn on the hazard warning flashers.
- Turn the ignition switch on and then off.

The remote vehicle start feature provides two separate starts, each with 10 minutes of engine running, or it provides one start with 10 minutes of engine running that may be extended 10 more minutes. If you press and release the transmitter lock button and then press and hold the remote start button on the transmitter again before the first 10 minutes of engine running time has expired, 10 minutes are added to the remaining minutes. For example, if the lock button and then the remote start buttons are pressed again after five minutes of the engine run time, 10 minutes are added and you now have 15 minutes of engine running. The added ten minutes are considered a second remote vehicle start.

Once two remote starts or a single start with a time extension have been used, the vehicle must be started with the keyless access ignition control knob before you can use the remote start feature again.

The remote start feature will not operate if any of the following occur:

- The ignition is in any position other than LOCK/OFF.
- A keyless access transmitter is inside the vehicle.
- The hood is open.
- There is an emission control system malfunction.
- The remote start feature is not enabled. See “Remote Start” under *DIC Vehicle Customization on page 3-68*.

The engine will turn off during a remote vehicle start if the coolant temperature gets too high, or the oil pressure is too low.

Your vehicle was shipped from the factory with the remote vehicle start system enabled. The system may be disabled through the Driver Information Center (DIC). See “Remote Start” under *DIC Vehicle Customization on page 3-68* for additional information.

See *Engine Exhaust on page 2-47* for important safety information when using remote start in a closed garage.

Remote Start Ready

If your vehicle does not have the remote vehicle start feature, it may have the remote start ready feature. This feature allows your dealer/retailer to add the manufacturer's remote vehicle start feature. See your dealer/retailer if you would like to add the manufacturer's remote vehicle start feature to your vehicle.

Doors and Locks

Door Locks

CAUTION:

Unlocked doors can be dangerous.

- **Passengers, especially children, can easily open the doors and fall out of a moving vehicle. When a door is locked, the handle will not open it. You increase the chance of being thrown out of the vehicle in a crash if the doors are not locked. So, wear safety belts properly and lock the doors whenever you drive.**
- **Young children who get into unlocked vehicles may be unable to get out. A child can be overcome by extreme heat and can suffer permanent injuries or even death from heat stroke. Always lock your vehicle whenever you leave it.**
- **Outsiders can easily enter through an unlocked door when you slow down or stop your vehicle. Locking your doors can help prevent this from happening.**

There are several ways to lock and unlock your vehicle.

From the inside, use the manual lock levers located on the door panels near the windows.

Push down on the manual lock lever to lock the door. To unlock the door, pull up on the lever.

If the windows are down and the doors are locked, do not reach in to manually unlock the vehicle because you will set off the alarm.

From the outside, use the key, or press the lock or unlock button on the Remote Keyless Entry (RKE) transmitter. See *Remote Keyless Entry (RKE) System Operation on page 2-7* for more information.

On vehicles with the Remote Keyless Access system, the door unlocks by pulling the door handle when you have the transmitter with you. See *Keyless Access System Operation on page 2-9* for more information.

Central Door Unlocking System

Your vehicle has a central door unlocking feature. When unlocking the driver's door, you can unlock the other doors by holding the key in the turned position for a few seconds or by quickly turning the key twice in the lock cylinder.

Power Door Locks

The power door lock switches are located on the front doors.

 **(Unlock):** Press to unlock the doors.

 **(Lock):** Remove the key from the ignition and press to lock the doors.

Delayed Locking

With this feature, you can delay the actual locking of the doors.

When the power door lock switch is pressed when the key is not in the ignition and the driver's door is opened, a chime will sound three times indicating that delayed locking is active.

When all the doors are closed, the doors will lock automatically after five seconds. If a door is reopened before five seconds have elapsed, the five second timer will reset itself once all the doors are closed again.

You can press the door lock switch again or the lock button on the RKE transmitter to override this feature and lock the doors immediately.

You can turn this feature off using the Driver Information Center (DIC). When delayed locking is off, the doors will lock immediately when you press the power

door lock switch or the lock button on the RKE transmitter. See *DIC Vehicle Customization on page 3-68* for more information.

Programmable Automatic Door Locks

If your vehicle has an automatic transmission, the vehicle is programmed so that the doors will lock automatically when all doors are closed, the ignition is on, and the shift lever is moved out of PARK (P). The doors will automatically unlock when you stop the vehicle and move the shift lever back into PARK (P).

If your vehicle has a manual transmission, the vehicle is programmed so that the doors will lock automatically after the vehicle speed reaches 5 mph (8 km). The doors will automatically unlock when the ignition is turned off and the key is removed from the ignition.

If someone needs to exit the vehicle once the doors are locked, have that person use the manual lever or power door lock switch. When the door is closed again, it will not lock automatically. Use the manual lever or the power door lock switch to lock the door.

The power door locks can be programmed through prompts displayed on the Driver Information Center (DIC). These prompts allow you to choose various lock and unlock settings. For more information on programming, see *DIC Vehicle Customization on page 3-68*.

Rear Door Security Locks

Your vehicle has rear door security locks. These prevent passengers from opening the rear doors from the inside.

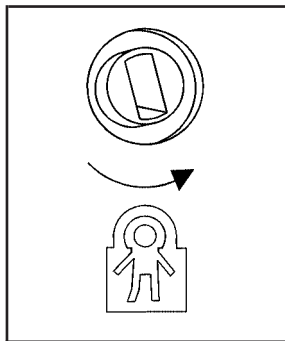

Lock Label shown

The rear door security locks are located on the inside edge of each rear door. The rear doors must be open to access them. The label showing lock and unlock positions is located near the lock.

To set the locks, do the following:

1. Insert the key into the security lock slot and turn it so the slot is in the horizontal position.
2. Close the door.

When you want to open a rear door when the security lock is on, do the following:

1. Unlock the door using the Remote Keyless Entry (RKE) or Keyless Access System transmitter, if the vehicle has one, the power door lock switch, or the rear door manual lock.
2. Open the door from the outside.

To cancel the rear door security lock, do the following:

1. Unlock the door and open it from the outside.
2. Insert the key into the security lock slot and turn it so the slot is in the vertical position.

Lockout Protection

If the power door lock switch is pressed when the key is in the ignition and a door is open, all the doors will lock and only the driver's door will unlock. If you close the doors, they can be locked by using the Remote Keyless Entry (RKE) transmitter. Be sure to remove the key from the ignition when locking your vehicle.

This feature can be overridden by pressing the lock button on the RKE transmitter or by pressing the power lock switch a second time.

On vehicles with a Keyless Access System, the system can be programmed to alert you when all the doors are closed and a transmitter has been left inside of the vehicle. See *DIC Vehicle Customization on page 3-68* for more information.

Trunk

CAUTION:

It can be dangerous to drive with the trunk lid open because carbon monoxide (CO) gas can come into your vehicle. You cannot see or smell CO. It can cause unconsciousness and even death. If you must drive with the trunk lid open or if electrical wiring or other cable connections must pass through the seal between the body and the trunk lid:

- **Make sure all other windows are shut.**
- **Turn the fan on your heating or cooling system to its highest speed and select the control setting that will force outside air into your vehicle. See Climate Control System.**
- **If you have air outlets on or under the instrument panel, open them all the way.**

See *Engine Exhaust on page 2-47.*

Trunk Lock Release

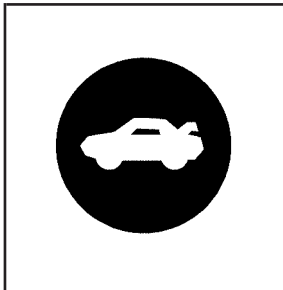

The remote trunk release button is located on the lower portion of the driver's door.

To use the remote trunk release, the shift lever must be in PARK (P) or NEUTRAL (N) for a vehicle with an automatic transmission. The shift lever must be in NEUTRAL, with the parking brake set for a vehicle with a manual transmission.

Press the button to open the trunk. You can also press the button with the trunk symbol on the Remote Keyless Entry (RKE) transmitter to open the trunk.

On vehicles with a Keyless Access System, squeeze the trunk release button located on the rear of the trunk lid above the license plate, as long as you have your transmitter with you. Entry occurs when the button

is being pressed and the vehicle recognizes the transmitter. The vehicle must be in PARK (P) and the valet mode turned off.

If your vehicle is ever without power, the trunk area can still be manually accessed by using one of the following procedures.

On vehicles with a rear seat pass-through door:

1. Fold the rear armrest down and open the pass-through door. See "Rear-Seat Pass Through" following for more information.
2. Reach upward through the opening to locate the emergency trunk release handle. See "Emergency Trunk Release Handle" for more information.
3. Pull forward on the trunk release handle to open the trunk lid.

On vehicles with a split folding rear seat:

1. Fold down the rear seatback. See *Split Folding Rear Seat* on page 1-11 for more information.
2. Reach upward through the opening to locate the trunk release handle.
3. Pull forward on the trunk release handle to open the trunk lid.

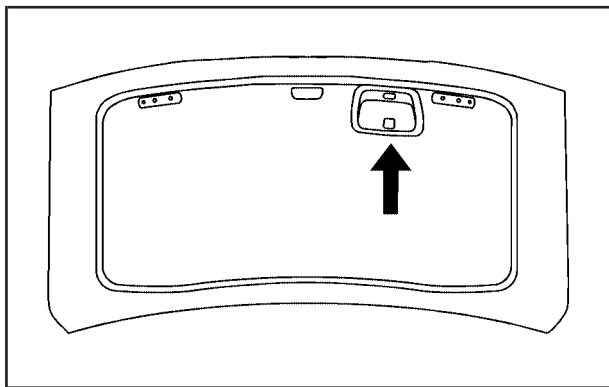

Close the trunk by pulling on the handle. Do not use the handle as a tie-down.

Rear-Seat Pass Through

If your vehicle has the rear seat-pass through door, you can access the trunk without opening the trunk lid. This is especially useful when transporting long items.

To open the door, pull down the rear seat armrest. Then pull the lever all the way down to release the door.

To close the door, push it up and back into place. Then try to open the door without pulling up on the lever to make sure it is locked into place.

Emergency Trunk Release Handle

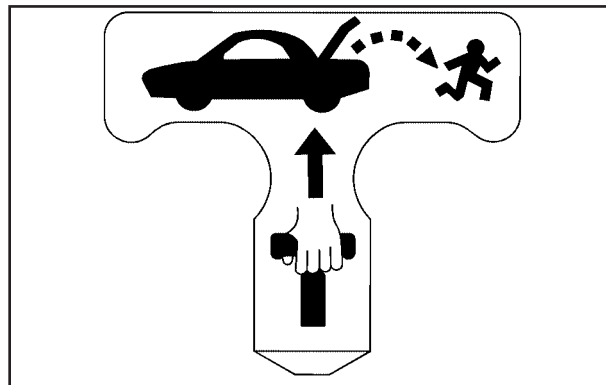

Notice: Do not use the emergency trunk release handle as a tie-down or anchor point when securing items in the trunk as it could damage the handle. The emergency trunk release handle is only intended to aid a person trapped in a latched trunk, enabling them to open the trunk from the inside.

There is a glow-in-the-dark emergency trunk release handle located on the back wall of the trunk. This handle will glow following exposure to light. Pull the release handle toward the front of the vehicle to open the trunk from the inside.

Windows

CAUTION:

Leaving children, helpless adults, or pets in a vehicle with the windows closed is dangerous. They can be overcome by the extreme heat and suffer permanent injuries or even death from heat stroke. Never leave a child, a helpless adult, or a pet alone in a vehicle, especially with the windows closed in warm or hot weather.

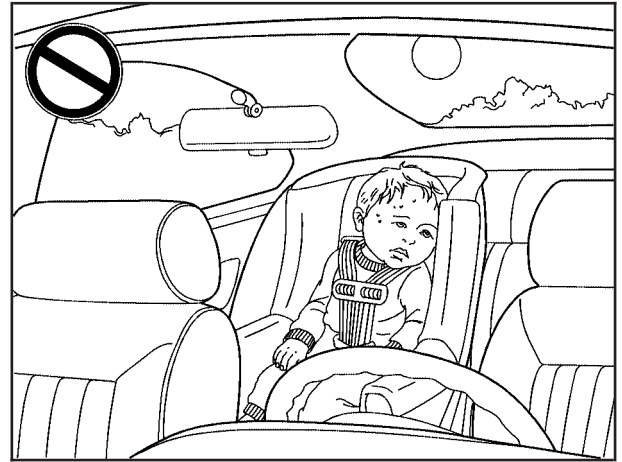

Power Windows

CAUTION:

Leaving children, helpless adults, or pets in a vehicle with the windows closed is dangerous. They can be overcome from extreme heat in warm or hot weather and suffer permanent injuries or even death from heat stroke.

Leaving children in a vehicle with the ignition key is dangerous for many reasons, children or others could be badly injured or even killed. They could operate the power windows or other controls or even make the vehicle move. The windows will function with the keys in the ignition and they could be seriously injured or killed if caught in the path of a closing window. Do not leave keys in a vehicle with children.

When there are children in the rear seat use the window lockout button to prevent unintentional operation of the windows.

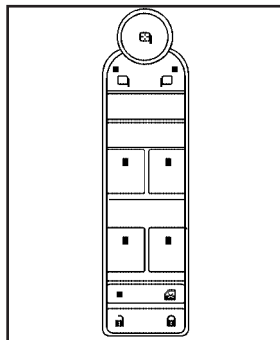

The power window switches are located on the driver's door.

In addition, each door has a switch for its own window. The front power window switch operates with two positions for both up and down movement and the rear power window switch operates with one position for up and two positions for down movement. Press the switch to the first position to lower the window to the desired level. Pull the switch up to raise the window. Your vehicle has Retained Accessory Power (RAP) that allows you to use the power windows once the ignition has been turned off. For more information, see *Retained Accessory Power (RAP)* on page 2-34.

Express-Down Window

This feature is on all windows. Press the switch to the second position and release the switch to activate the express-down feature. To stop the window as it is lowering, pull up briefly on the switch again.

Express-Up Window

This feature is on the front windows. Pull the switch up to the second position and release the switch to activate the express-up feature. To stop the window as it is raising, pull up or press down briefly on the switch again.

Programming the Power Windows

If the battery on your vehicle has been recharged, disconnected, or is not working, you will need to reprogram each front power window for the express-up feature to work. Before reprogramming, you will need to replace or recharge your vehicle's battery.

To program each front window, follow these steps:

1. With the ignition in ACC/ACCESSORY, ON/RUN, or when Retained Accessory Power (RAP) is active, close all doors.
2. Press and hold the power window switch until the window is fully open.
3. Pull the power window switch up until the window is fully closed.
4. Continue holding the switch up for approximately two seconds after the window is completely closed.

The window is now reprogrammed. Repeat the process for the other windows.

Express Window Anti-Pinch Feature

If any object is in the path of the window when the express-up is active, the window will stop at the obstruction and auto-reverse to a preset factory position. Weather conditions such as severe icing may also cause the window to auto-reverse. The window will return to normal operation once the obstruction or condition is removed.

Express Window Anti-Pinch Override

CAUTION:

If express override is activated, the window will not reverse automatically. You or others could be injured and the window could be damaged. Before you use express override, make sure that all people and obstructions are clear of the window path.

In an emergency, the anti-pinch feature can be overridden in a supervised mode. Hold the window switch all the way up to the second position. The window will rise for as long as the switch is held. Once the switch is released, the express mode is re-activated.

In this mode, the window can still close on an object in its path. Use care when using the override mode.

Window Lockout

 **(Window Lockout):** The rear window lockout button is located on the driver's door near the window switches.

Press the right side of the button to disable the rear window controls. The light on the button will illuminate, indicating the feature is in use. The rear windows still can be raised or lowered using the driver's window switches when the lockout feature is active.

To restore power to the rear windows, press the button again. The light on the button will go out.

Sun Visors

Swing down the primary visor to block out glare. It can also be detached from the center mount and moved to the side to block glare from that direction.

The driver's visor may also have buttons for a built-in garage door opener. See *Universal Home Remote System on page 2-56* for more information.

Lighted Visor Vanity Mirror

Pull the visor down and lift the cover to access the mirror. A light comes on when the cover is lifted and goes out when it is closed.

Theft-Deterrent Systems

Vehicle theft is big business, especially in some cities. Although your vehicle has a number of theft-deterrent features, we know that nothing we put on it can make it impossible to steal.

Theft-Deterrent System

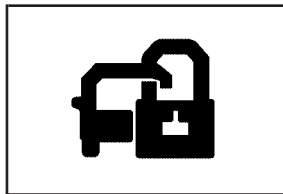

If your vehicle has this feature, the security light is located on the instrument panel cluster.

To activate the theft-deterrent system:

1. Open the door.
2. Lock the door with the transmitter. The security light should come on and stay on.
3. Close all doors. The security light should go off after about 30 seconds. The alarm is not armed until the security light goes off.

If a locked door or trunk is opened without using the key in the driver's door key cylinder or the transmitter, a ten second pre-alarm will occur. The horn will chirp and the lights will flash. If the ignition is turned to START or the door is not unlocked by pressing the unlock button on the transmitter during the ten second pre-alarm, the alarm will go off. Your vehicle's headlamps will flash and the horn will sound for about 30 seconds, then will turn off to save the battery power.

The theft-deterrent system will not activate if the doors are locked with the vehicle's key or the manual door lock. It activates only if the power door lock switch is used while the door is open or with the transmitter. You should also remember that you can start your vehicle with the correct ignition key if the alarm has been set off.

To avoid setting off the alarm by accident:

- Lock the vehicle with the door key after the doors are closed.
- Always unlock a door with the transmitter. Unlocking a door any other way will set off the alarm.

If you set off the alarm by accident, turn off the alarm by pressing the unlock button on the transmitter. The alarm will not stop if you try to unlock a door any other way.

Testing the Alarm

The alarm can be tested by following these steps:

1. From inside the vehicle, lower the driver's window and open the driver's door.
2. Activate the system by locking the doors with the transmitter.
3. Get out of the vehicle, close the door and wait for the security light to go out.
4. Then reach in through the window, unlock the door with the manual door lock and open the door. This should set off the alarm.

While the alarm is set, the power door unlock switch will not work.

If the alarm does not sound when it should but the headlamps flash, check to see if the horn works. The horn fuse may be blown. To replace the fuse, see *Fuses and Circuit Breakers on page 5-122 Fuses and Circuit Breakers*.

If the alarm does not sound or the headlamps do not flash, the vehicle should be serviced by your dealer/retailer.

Immobilizer

This device complies with Part 15 of the FCC Rules. Operation is subject to the following two conditions:

1. This device may not cause interference.
2. This device must accept any interference received, including interference that may cause undesired operation.

This device complies with RSS-210 of Industry Canada. Operation is subject to the following two conditions:

1. This device may not cause interference.
2. This device must accept any interference received, including interference that may cause undesired operation of the device.

Changes or modifications to this system by other than an authorized service facility could void authorization to use this equipment.

Immobilizer Operation (Key Access)

Your vehicle has a passive theft-deterrent system.

The system is automatically armed when the key is removed from the ignition.

The theft-deterrent system is disarmed when the key is turned to ON/RUN.

You do not have to manually arm or disarm the system.

The security light will come on if there is a problem with arming or disarming the theft-deterrent system.

The key uses a transponder that matches an immobilizer control unit in your vehicle and automatically disarms the system. Only the correct key will start the vehicle. If the key is ever damaged, you may not be able to start your vehicle.

When trying to start the vehicle, if the engine does not start and the security light comes on, there may be a problem with your theft-deterrent system. Turn the ignition off and try again.

If the engine still does not start, and the key appears to be undamaged, try another ignition key. At this time, you may also want to check the fuse. See *Fuses and Circuit Breakers on page 5-122*. If the engine still does not start with the other key, your vehicle needs service. If your vehicle does start, the first key may be faulty. See your dealer/retailer who can service the theft-deterrent system and have a new key made.

It is possible for the theft-deterrent system decoder to learn the transponder value of a new or replacement key. Up to 10 keys can be programmed for the vehicle. The following procedure is for programming additional keys only.

To program a new key do the following:

1. Verify that the new key has ⊕ stamped on it.
2. Insert the current driver's key in the ignition and start the engine. If the engine will not start see your dealer/retailer for service.
3. After the engine has started, turn the key to LOCK/OFF, and remove the key.
4. Insert the key to be programmed and turn it to ON/RUN within five seconds of the ignition being turned to LOCK/OFF in Step 3.
5. The security light will turn off once the key has been programmed. It may not be apparent that the security light went on due to how quickly the key is programmed.
6. Repeat the Steps 1 through 4 if additional keys are to be programmed.

In an emergency, contact Cadillac Roadside Service®. See *Roadside Service on page 7-6*.

Do not leave the key or device that disarms or deactivates the theft deterrent system in the vehicle.

Immobilizer Operation (Keyless Access)

Your vehicle has a passive theft-deterrent system.

The system is automatically armed when the ignition control knob is turned to LOCK/OFF.

The immobilization system is disarmed when the ignition control knob is pushed in and a valid transmitter is found in the vehicle.

You do not have to manually arm or disarm the system.

The security light will come on if there is a problem with arming or disarming the theft-deterrent system.

The system has one or more keyless access transmitters that are matched to an immobilizer control unit in your vehicle. Only a correctly matched keyless access transmitter will start the vehicle. If the keyless access transmitter is ever damaged, you may not be able to start your vehicle.

When trying to start the vehicle, if the engine does not start and the security light comes on, there may be a problem with your immobilizer system. Turn the ignition control knob off and try again.

If the ignition control knob does not rotate, and the keyless access transmitter appears to be undamaged, try another keyless access transmitter. Or, you may try placing the transmitter in the transmitter pocket located in the center console. See “Electronic Key Not Detected” under *DIC Warnings and Messages on page 3-54*. At this time, you may also want to check the fuse. See *Fuses and Circuit Breakers on page 5-122*. If the ignition control knob still does not rotate with the other transmitter, your vehicle needs service. If the ignition control knob does rotate, the first transmitter may be faulty. See your dealer/retailer who can service the theft-deterrent system and have a new keyless access transmitter programmed to the vehicle.

It is possible for the immobilizer system to learn new or replacement keyless access transmitters. Up to 4 keyless access transmitters can be programmed for the vehicle. To program additional transmitters, see “Matching transmitter(s) to Your Vehicle” under *Keyless Access System Operation on page 2-9*.

Do not leave the key or device that disarms or deactivates the theft deterrent system in the vehicle.

Starting and Operating Your Vehicle

New Vehicle Break-In

Notice: Your vehicle does not need an elaborate break-in. But it will perform better in the long run if you follow these guidelines for the first 500 miles (805 km):

- Do not drive at any one constant speed, fast or slow.
- Do not exceed 70 mph (113 km/h).
- Do not make full-throttle starts; also refrain from using the full throttle while driving. Avoid downshifting to brake or slow the vehicle.

If these procedures are not followed, the engine, axle, or other parts could be damaged.

Avoid making hard stops for the first 200 miles (322 km) or so. During this time the new brake linings are not yet broken in. Hard stops with new linings can mean premature wear and earlier replacement. Follow this break-in guideline every time you get new linings.

Do not tow a trailer during break-in. See *Towing a Trailer* on page 4-29 for the trailer towing capabilities of your vehicle and more information.

Following break-in, engine speed and load can be gradually increased.

Ignition Positions (Key Access)

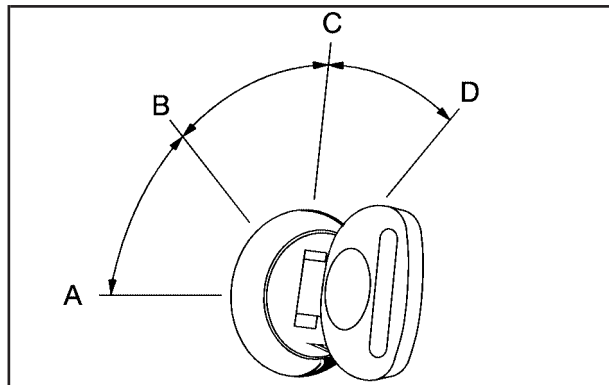

The key can be turned to four different positions.

To shift out of PARK (P), ignition must be in the ON/RUN or ACC/ACCESSORY and the regular brake pedal must be applied.

Notice: Using a tool to force the key from its cylinder could cause damage or break the key. Use the correct key and turn the key only with your hand. Make sure the key is all the way in. If it is and you have a manual transmission vehicle, turn the steering wheel left and right while you turn the key hard. If none of this works, then your vehicle needs service.

A (LOCK/OFF): This is the only position in which the key can be inserted or removed. This position locks the ignition and shifter on automatic transmission vehicles, and the ignition and steering wheel on manual transmission vehicles.

B (ACC/ACCESSORY): This position lets you use things like the radio and the windshield wipers when the engine is off. This position allows you to turn off the engine.

C (ON/RUN): This position is for driving. It is the position the ignition switch returns to after the engine starts, and the key is released.

To shift the transmission out of PARK (P), the ignition key has to be in ACC/ACCESSORY or ON/RUN.

The battery could be drained if the key is left in the ACC/ACCESSORY or ON/RUN position with the engine off. The vehicle might not start if the battery is allowed to drain for an extended period of time.

D (START): This position starts the engine.

Key In the Ignition

Never leave your vehicle with the keys inside, as it is an easy target for joy riders or thieves. A chime sounds when the driver's door is opened while the vehicle is parked and the key is left in the ignition. Always remember to remove the key from the ignition and take it with you. This will lock the ignition and transmission. Also, always remember to lock the doors.

The battery could be drained if the key is left in the ignition while your vehicle is parked. The vehicle might not start after it has been parked for an extended period of time.

Ignition Positions (Keyless Access)

You can turn the ignition control knob to four different positions.

To shift out of PARK (P), ignition must be in the ON/RUN or ACC/ACCESSORY and the regular brake pedal must be applied.

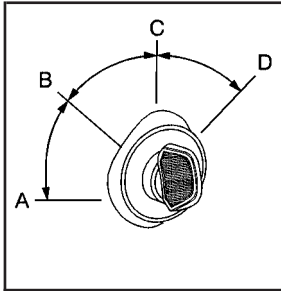

Using a tool to force the knob from its cylinder could cause damage or break the knob.

Make sure the keyless access transmitter is inside the vehicle when trying to turn the ignition control knob.

A (LOCK/OFF): The ignition control knob cannot be removed from the vehicle. The keyless access transmitter must be inside the vehicle to start the engine. This position locks the ignition and shifter on automatic transmission vehicles, and the ignition and steering wheel on manual transmission vehicles.

B (ACC/ACCESSORY): This position allows you to use things like the radio and the windshield wipers when the engine is off. This position will allow you to turn off the engine.

C (ON/RUN): This position is for driving. It is the position the ignition switch returns to after the engine starts, and the control knob is released.

If you need to shift the transmission out of PARK (P), the ignition control knob has to be in ACC/ACCESSORY or ON/RUN.

The battery could be drained if you leave the key in the ACC/ACCESSORY or ON/RUN position with the engine off. You may not be able to start your vehicle if the battery is allowed to drain for an extended period of time.

D (START): This position starts the engine.

Retained Accessory Power (RAP)

These vehicle accessories can be used for up to 10 minutes after the engine is turned off:

- Audio System
- Power Windows
- Sunroof

Power to the audio system will work up to 10 minutes or until the driver's door is opened. Power to the windows or sunroof will work up to 10 minutes or until any door is opened. For an additional 10 minutes of operation, close all the doors and turn the key to ON/RUN and then back to LOCK/OFF.

Starting the Engine

Place the transmission in the proper gear.

Automatic Transmission

Move the shift lever to PARK (P) or NEUTRAL (N). The engine will not start in any other position -- this is a safety feature. To restart when you are already moving, use NEUTRAL (N) only.

If your vehicle has the keyless access system, put your foot on the brake pedal and turn the ignition control knob to the START position. When the engine begins cranking, let go of the ignition control knob, it will return to the ON/RUN position.

If the transmitter is not in the vehicle or something is interfering with the transmitter, the Driver Information Center (DIC) will display Electronic Key Not Detected. See *DIC Warnings and Messages on page 3-54* for more information.

If the battery in the keyless access transmitter needs replacing, the DIC displays Replace Battery In Remote Key. The vehicle can still be driven. See "Battery Replacement" under *Keyless Access System Operation on page 2-9* for more information.

Notice: Do not try to shift to PARK (P) if your vehicle is moving. If you do, you could damage the transmission. Shift to PARK (P) only when your vehicle is stopped.

Manual Transmission

The shift lever should be in neutral position and the parking brake engaged. Hold the clutch pedal down to the floor and start the engine. Your vehicle will not start if the clutch pedal is not all the way down. That is a safety feature.

Starting Procedure

1. With your foot off the accelerator pedal, turn the ignition key to START. If your vehicle has the keyless access system, make sure there is a keyless access transmitter in the vehicle. When the engine starts, let go of the ignition. The idle speed will go down as your engine gets warm. Do not race the engine immediately after starting it. Operate the engine and transmission gently to allow the oil to warm up and lubricate all moving parts.

Your vehicle has a Computer-Controlled Cranking System. This feature assists in starting the engine and protects components. If the ignition key is turned to the START position, and then released when the engine begins cranking, the engine will continue cranking for a few seconds or until the vehicle starts. If the engine does not start and the key is held in START for many seconds, cranking will be stopped after 15 seconds to prevent cranking motor damage. To prevent gear damage, this system also prevents cranking if the engine is already running. Engine cranking can be stopped by turning the ignition switch to ACC/ACCESSORY or LOCK/OFF.

Notice: Cranking the engine for long periods of time, by returning the key to the START position immediately after cranking has ended, can overheat

and damage the cranking motor, and drain the battery. Wait at least 15 seconds between each try, to let the cranking motor cool down.

2. If the engine does not start after 5-10 seconds, especially in very cold weather (below 0°F or -18°C), it could be flooded with too much gasoline. Try pushing the accelerator pedal all the way to the floor and holding it there as you hold the key in START for up to a maximum of 15 seconds. Wait at least 15 seconds between each try, to allow the cranking motor to cool down. When the engine starts, let go of the key and accelerator. If the vehicle starts briefly but then stops again, do the same thing. This clears the extra gasoline from the engine. Do not race the engine immediately after starting it. Operate the engine and transmission gently until the oil warms up and lubricates all moving parts.

Notice: The engine is designed to work with the electronics in your vehicle. If you add electrical parts or accessories, you could change the way the engine operates. Before adding electrical equipment, check with your dealer/retailer. If you do not, your engine might not perform properly. Any resulting damage would not be covered by your vehicle's warranty.

Engine Coolant Heater

The engine coolant heater, if available, can help in cold weather conditions at or below 0°F (-18°C) for easier starting and better fuel economy during engine warm-up. Plug in the coolant heater at least four hours before starting your vehicle. An internal thermostat in the plug-end of the cord may exist which will prevent engine coolant heater operation at temperatures above 0°F (-18°C).

To Use the Engine Coolant Heater

1. Turn off the engine.
2. Open the hood and unwrap the electrical cord. The cord is located in the engine compartment on the passenger side of the vehicle in front of the fuse block.
Remove the plastic cap to access the plug.
3. Plug it into a normal, grounded 110-volt AC outlet.

CAUTION:

Plugging the cord into an ungrounded outlet could cause an electrical shock. Also, the wrong kind of extension cord could overheat and cause a fire. You could be seriously injured. Plug the cord into a properly grounded three-prong 110-volt AC outlet. If the cord will not reach, use a heavy-duty three-prong extension cord rated for at least 15 amps.

4. Before starting the engine, be sure to unplug and store the cord as it was before to keep it away from moving engine parts. If you do not, it could be damaged.

How long should you keep the coolant heater plugged in? The answer depends on the outside temperature, the kind of oil you have, and some other things. Instead of trying to list everything here, we ask that you contact your dealer/retailer in the area where you will be parking your vehicle. The dealer/retailer can give you the best advice for that particular area.

Automatic Transmission Operation

The shift lever is located on the center console between the front seats.

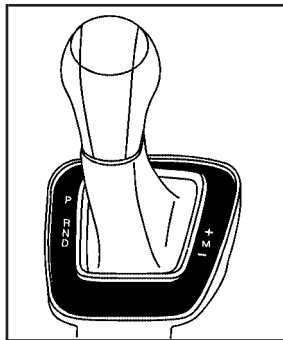

There are several different positions for the shift lever.

PARK (P): This position locks the rear wheels. It is the best position to use when you start the engine because your vehicle cannot move easily.

CAUTION:

It is dangerous to get out of your vehicle if the shift lever is not fully in PARK (P) with the

CAUTION: (Continued)

CAUTION: (Continued)

parking brake firmly set. Your vehicle can roll. Do not leave your vehicle when the engine is running unless you have to. If you have left the engine running, the vehicle can move suddenly. You or others could be injured. To be sure your vehicle will not move, even when you are on fairly level ground, always set your parking brake and move the shift lever to PARK (P). See *Shifting Into PARK (P) (Automatic Transmission)* on page 2-44. If you are pulling a trailer, see *Towing a Trailer* on page 4-29.

Make sure the shift lever is fully in PARK (P) before starting the engine. Your vehicle has an automatic transmission shift lock control system. You must fully apply your regular brakes first and then press the shift lever button before you can shift from PARK (P) when the ignition key is in ON. If you cannot shift out of PARK (P), ease pressure on the shift lever and push the shift lever all the way into PARK (P) as you maintain brake application. Then press the shift lever button and move the shift lever into another gear. See *Shifting Out of PARK (P)* on page 2-45.

Notice: Shifting to REVERSE (R) while your vehicle is moving forward could damage the transmission. The repairs would not be covered by your warranty. Shift to REVERSE (R) only after your vehicle is stopped.

REVERSE (R): Use this gear to back up.

At low vehicle speeds, you can also use REVERSE (R) to rock your vehicle back and forth to get out of snow, ice, or sand without damaging your transmission. See *If Your Vehicle is Stuck in Sand, Mud, Ice, or Snow* on page 4-21 for additional information.

NEUTRAL (N): In this position, the engine does not connect with the wheels. To restart when you are already moving, use NEUTRAL (N) only. You can also use NEUTRAL (N) when your vehicle is being towed.

 **CAUTION:**

Shifting into a drive gear while the engine is running at high speed is dangerous. Unless your foot is firmly on the brake pedal, your vehicle could move very rapidly. You could lose control and hit people or objects. Do not shift into a drive gear while your engine is running at high speed.

Notice: Shifting out of PARK (P) or NEUTRAL (N) with the engine running at high speed may damage the transmission. The repairs would not be covered by your warranty. Be sure the engine is not running at high speed when shifting your vehicle.

DRIVE (D): This position is for normal driving. It provides the best fuel economy for your vehicle. If you need more power for passing, and you are:

- Going less than 35 mph (55 km/h), push the accelerator pedal about halfway down.
- Going about 35 mph (55 km/h) or more, push the accelerator all the way down.

The transmission will shift down to a lower gear and have more power.

Downshifting the transmission in slippery road conditions could result in skidding, see Skidding under *Loss of Control on page 4-13*

MANUAL MODE (M): This position lets drivers select the range of gears appropriate for current driving conditions. If your vehicle has this feature, see Driver Shift Control (DSC) later in this section.

Notice: Spinning the tires or holding the vehicle in one place on a hill using only the accelerator pedal may damage the transmission. If you are stuck, do not spin the tires. When stopping on a hill, use the brakes to hold the vehicle in place.

Driver Shift Control (DSC)

Notice: If you drive your vehicle at high RPMs without upshifting while using Driver Shift Control (DSC), you could damage your vehicle. Always upshift when necessary while using DSC.

Your automatic transmission has a Driver Shift Control (DSC) feature that allows you to change gears similar to a manual transmission. To use the DSC feature:

1. Slide the shift lever over from DRIVE (D) to the right to MANUAL MODE (M).

If you do not move the shift lever forward or rearward, the vehicle will be in sport mode. When you are in the sport mode the vehicle will still shift automatically. While driving in sport mode, the transmission may remain in a gear longer than it would in the normal driving mode based on braking, throttle input, and vehicle lateral acceleration.

The SPORT MODE will be displayed in the DIC

2. To enter the DSC mode, press the shift lever forward to upshift or rearward to downshift.

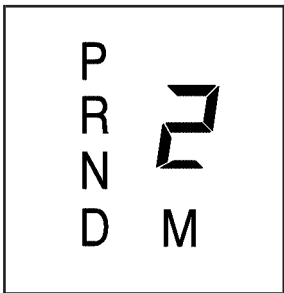

The tachometer display on the instrument panel cluster will show which gear the vehicle is in and a number indicating the requested gear range when moving the shift lever forward or rearward. See *Speedometer and Odometer on page 3-31* for more information on the odometer.

While using the DSC feature, the vehicle will have firmer shifting and increased performance. You can use this for sport driving or when climbing or descending hills, to stay in gear longer, or to down shift for more power or engine braking.

The transmission will only allow you to shift into gears appropriate for the vehicle speed and engine Revolutions Per Minute (RPM). The transmission will not automatically shift to the next lower gear if the engine RPM is too high.

If shifting is prevented for any reason, the currently selected gear will flash multiple times, indicating that the transmission has not shifted gears.

While in the DSC mode, the transmission will automatically downshift when the vehicle comes to a stop and while quickly applying the accelerator to increase speed. This will allow for more power during take-off.

When accelerating your vehicle from a stop in snowy and icy conditions, you may want to shift into second gear. A higher gear ratio allows you to gain more traction on slippery surfaces.

Manual Transmission Operation

If your vehicle has a manual transmission, the shift lever is located on the center console between the front seats. The following explains how to operate the manual transmission.

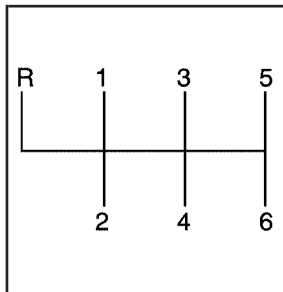

FIRST (1): Press the clutch pedal and shift into FIRST (1). Then slowly let up on the clutch pedal as you press the accelerator pedal.

Shift into FIRST (1) when you are going less than 25 mph (40 km/h). If you come to a complete stop and it is hard to shift into FIRST (1), put the shift lever in NEUTRAL and let up on the clutch. Press the clutch pedal back down. Then shift into FIRST (1).

SECOND (2): Press the clutch pedal as you let up on the accelerator pedal and shift into SECOND (2). Then, slowly let up on the clutch pedal as you press the accelerator pedal.

THIRD (3), FOURTH (4), FIFTH (5) and SIXTH (6): Shift into THIRD (3), FOURTH (4), FIFTH (5) and SIXTH (6) the same way you do for SECOND (2). Slowly let up on the clutch pedal as you press the accelerator pedal.

To stop, let up on the accelerator pedal and press the brake pedal. Just before the vehicle stops, press the clutch pedal and the brake pedal, and shift to NEUTRAL.

NEUTRAL: Use this position when you start or idle your engine. Your shift lever is in NEUTRAL when it is centered in the shift pattern, not in any gear.

REVERSE (R): To back up, press down the clutch pedal, completely stop the vehicle, and shift into REVERSE (R). Let up on the clutch pedal slowly while pressing the accelerator pedal.

Shift Speeds (Manual Transmission)

CAUTION:

If you skip a gear when you downshift, you could lose control of your vehicle. You could injure yourself or others. Do not shift down more than one gear at a time when you downshift.

Notice: If you skip more than one gear when you downshift, or if you race the engine when you release the clutch pedal while downshifting, you could damage the engine, clutch, driveshaft or the transmission. Do not skip gears or race the engine when downshifting.

If the vehicle speed drops below 20 mph (32 km/h), or if the engine is not running smoothly, you should downshift to the next lower gear. You may have to downshift two or more gears to keep the engine running smoothly or for good performance.

Up-Shift Light



Vehicles with a manual transmission may have an up-shift light on the instrument panel. This light will show you when to shift to the next higher gear for the best fuel economy.

When this light comes on, you can shift to the next higher gear if weather, road, and traffic conditions allow. For the best fuel economy, accelerate slowly and shift when the light comes on.

While you accelerate, it is normal for the light to go on and off if you quickly change the position of the accelerator. Ignore the light when you downshift.

Parking Brake

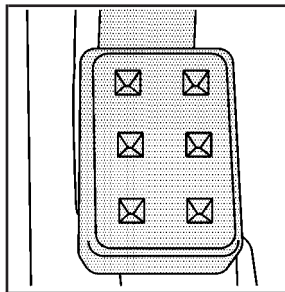

The parking brake pedal is located on the lower portion of the instrument panel to the left of the steering wheel.

To set the parking brake, hold the regular brake pedal down with your right foot and push the parking brake pedal down with your left foot.

If the ignition is on, the brake system warning light on the instrument panel cluster should come on. If it does not, you need to have your vehicle serviced. See *Brake System Warning Light* on page 3-37 for more information.

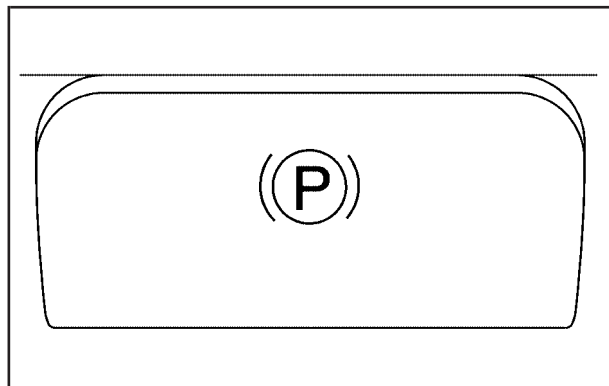

To release the parking brake, pull the release lever located to the left of the steering wheel on the instrument panel.

Notice: Driving with the parking brake on can overheat the brake system and cause premature wear or damage to brake system parts. Make sure that the parking brake is fully released and the brake warning light is off before driving.

A warning chime will sound if the parking brake is set, the ignition is on, and the vehicle begins to move. To stop the chime, fully release the parking brake.

If you are towing a trailer and parking on a hill, see *Towing a Trailer* on page 4-29 for more information.

Shifting Into PARK (P) (Automatic Transmission)

CAUTION:

It can be dangerous to get out of your vehicle if the shift lever is not fully in PARK (P) with the parking brake firmly set. Your vehicle can roll. If you have left the engine running, the vehicle can move suddenly. You or others could be injured. To be sure your vehicle will not move, even when you are on fairly level ground, use the steps that follow. If you are pulling a trailer, see *Towing a Trailer on page 4-29*.

Use this procedure to shift into PARK (P):

1. Hold the brake pedal down with your right foot and set the parking brake.
See *Parking Brake on page 2-43* for more information.
2. Move the shift lever into PARK (P) by holding in the button on the shift lever and pushing the lever all the way toward the front of the vehicle.

3. Turn the ignition to LOCK/OFF.
4. For vehicles with key access, remove the key and take it with you. If you can leave your vehicle with the ignition key in your hand, your vehicle is in PARK (P). Vehicles with the keyless access system, take the keyless access transmitter with you.

Leaving Your Vehicle With the Engine Running (Automatic Transmission)

CAUTION:

It can be dangerous to leave your vehicle with the engine running. Your vehicle could move suddenly if the shift lever is not fully in PARK (P) with the parking brake firmly set. And, if you leave the vehicle with the engine running, it could overheat and even catch fire. You or others could be injured. Do not leave your vehicle with the engine running.

If you have to leave your automatic transmission vehicle with the engine running, be sure your vehicle is in PARK (P) and your parking brake is firmly set before you leave it. After you have moved the shift lever

into PARK (P), hold the regular brake pedal down. Then, see if you can move the shift lever away from PARK (P) without first pushing the button.

If you can, it means that the shift lever was not fully locked into PARK (P).

Torque Lock (Automatic Transmission)

If you are parking on a hill and you do not shift the automatic transmission into PARK (P) properly, the weight of the vehicle may put too much force on the parking pawl in the transmission. You may find it difficult to pull the shift lever out of PARK (P). This is called torque lock. To prevent torque lock, set the parking brake and then shift into PARK (P) properly before you leave the driver's seat. To find out how, see "Shifting Into Park (P)" previously in the section.

When you are ready to drive, move the shift lever out of PARK (P) before releasing the parking brake.

If torque lock does occur, you may need to have another vehicle push yours a little uphill to take some of the pressure from the parking pawl in the transmission, so you can pull the shift lever out of PARK (P).

Shifting Out of PARK (P)

This vehicle is equipped with an electronic shift lock release system. The shift lock release is designed to:

- Prevent ignition key, Key Access, removal unless the shift lever is in PARK (P) with the shift lever button fully released, and
- Prevent movement of the shift lever out of PARK (P), unless the ignition is in ON/RUN or ACC/ACCESSORY and the regular brake pedal is applied.

The shift lock release is always functional except in the case of an uncharged or low voltage (less than 9 volt) battery.

If your vehicle has an uncharged battery or a battery with low voltage, try charging or jump starting the battery. See *Jump Starting on page 5-44* for more information.

To shift out of PARK (P) use the following:

1. Apply the brake pedal.
2. Then press the shift lever button.
3. Move the shift lever to the desired position.

If you still are unable to shift out of PARK (P):

1. Fully release the shift lever button.
2. While holding down the brake pedal, press the shift lever button again.
3. Move the shift lever to the desired position.

If you still cannot move the shift lever from PARK (P), consult your dealer/retailer or a professional towing service.

Parking Your Vehicle (Manual Transmission)

Before you get out of your vehicle, place the shift lever in REVERSE (R) and firmly apply the parking brake. For the base ignition, turn the ignition key to OFF/LOCK, press the release button and remove the key. See “Key Release Button” under *Ignition Positions (Key Access)* on page 2-31 or *Ignition Positions (Keyless Access)* on page 2-33 for more information.

For the keyless access ignition, turn the ignition to LOCK/OFF and remove the keyless access transmitter.

If you are towing a trailer, see *Towing a Trailer* on page 4-29.

Parking Over Things That Burn

CAUTION:

Things that can burn could touch hot exhaust parts under your vehicle and ignite. Do not park over papers, leaves, dry grass, or other things that can burn.

Engine Exhaust

CAUTION:

Engine exhaust can kill. It contains the gas carbon monoxide (CO), which you cannot see or smell. It can cause unconsciousness and death.

CAUTION: (Continued)

CAUTION: (Continued)

You might have exhaust coming in if:

- The exhaust system sounds strange or different.
- Your vehicle gets rusty underneath.
- Your vehicle was damaged in a collision.
- Your vehicle was damaged when driving over high points on the road or over road debris.
- Repairs were not done correctly.
- Your vehicle or the exhaust system has been modified improperly.

If you ever suspect exhaust is coming into your vehicle:

- Drive it only with all the windows down to blow out any CO; and
- Have your vehicle fixed immediately.

Running the Vehicle While Parked

It is better not to park with the engine running. But if you ever have to, here are some things to know.

CAUTION:

Idling the engine with the climate control system off could allow dangerous exhaust into your vehicle. See the earlier caution under *Engine Exhaust on page 2-47*.

Also, idling in a closed-in place can let deadly carbon monoxide (CO) into your vehicle even if the climate control fan is at the highest setting. One place this can happen is a garage. Exhaust — with CO — can come in easily. NEVER park in a garage with the engine running.

Another closed-in place can be a blizzard. See *Winter Driving on page 4-18*.

CAUTION:

It can be dangerous to get out of your vehicle if the automatic transmission shift lever is not fully in PARK (P) with the parking brake firmly set. Your vehicle can roll. Do not leave your vehicle when the engine is running unless you have to. If you have left the engine running, the vehicle can move suddenly. You or others could be injured. To be sure your vehicle will not move, even when it is on fairly level ground, always set the parking brake and move the automatic transmission shift lever to PARK (P), or the manual transmission shift lever to NEUTRAL.

Follow the proper steps to be sure your vehicle will not move. See *Shifting Into PARK (P) (Automatic Transmission) on page 2-44* and *Parking Your Vehicle (Manual Transmission) on page 2-46*.

If you are parking on a hill and if you are pulling a trailer, see *Towing a Trailer on page 4-29*.

Mirrors

Automatic Dimming Rearview Mirror with OnStar®

The vehicle may have an automatic dimming inside rearview mirror with OnStar® controls. For more information about OnStar®, see *OnStar® System on page 2-53*.

 **(On/Off):** The on/off button on the lower left side of the mirror, is used for the automatic dimming functions of the rearview mirror.

Mirror Operation

The automatic dimming feature comes on each time the vehicle is started. Automatic dimming reduces the glare of lights from behind the vehicle.

To turn the automatic dimming feature on or off, press and release the AUTO/○ (off) button. **The indicator light will come on when this feature is on.**

Cleaning the Mirror

When cleaning the mirror, use a paper towel or similar material dampened with glass cleaner. Do not spray glass cleaner directly on the mirror as that may cause the liquid cleaner to enter the mirror housing.

Outside Power Mirrors

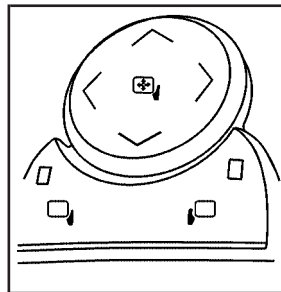

The control on the driver side door operates both outside rearview mirrors.

Press the left or right mirror symbol on the selector switch to choose the driver side or passenger side mirror.

Once a mirror is selected, use the arrows on the control pad to move the mirror to the correct direction. Adjust each mirror so you can see the side of your vehicle and the area behind your vehicle.

The mirrors can be manually folded inward to prevent damage when going through an automatic car wash. To fold, push the mirror toward the vehicle. To return the mirror to its original position, push outward. Be sure to return both mirrors to their original unfolded position before driving.

If the vehicle has the memory package, the mirrors can be programmed for personalization and curb view assist.

Park Tilt Mirrors

If the vehicle has the memory seat and mirrors, the mirrors can be tilted to a preselected position when the vehicle is shifted into REVERSE (R). Use this park tilt feature to view the curb when parallel parking.

When the vehicle is shifted out of REVERSE (R) and after a five-second delay, the mirrors will return to their original position.

The park tilt can be turned on or off through the Driver Information Center (DIC). See *DIC Vehicle Customization on page 3-68* for more information.

Outside Convex Mirror

CAUTION:

A convex mirror can make things (like other vehicles) look farther away than they really are. If you cut too sharply into the right lane, you could hit a vehicle on your right. Check your inside mirror or glance over your shoulder before changing lanes.

The passenger side mirror is convex. A convex mirror's surface is curved so more can be seen from the driver's seat. This mirror does not have a dimming feature.

Outside Heated Mirrors

When the rear window defogger is turned on, it also warms both outside rearview mirrors to help clear them of fog or ice. See "Rear Window Defogger" under *Dual Climate Control System on page 3-23* for more information.

Object Detection Systems

Ultrasonic Rear Parking Assist (URPA)

If your vehicle has the Ultrasonic Rear Parking Assist (URPA) system, it helps you park easier and avoid other vehicles while in REVERSE (R). It operates at speeds less than 5 mph (8 km/h). It can determine how close objects are to the rear bumper, up to 8 feet (2.5 m) behind your vehicle. The distance sensors are located on the rear bumper.

CAUTION:

The Ultrasonic Rear Parking Assist (URPA) system does not replace driver vision. It cannot detect:

- objects that are below the bumper, underneath the vehicle, or if they are too close or far from the vehicle
- children, pedestrians, bicyclists, or pets.

CAUTION: (Continued)

CAUTION: (Continued)

If you do not use proper care before and while backing; vehicle damage, injury, or death could occur. Even with URPA, always check behind your vehicle before backing up. While backing, be sure to look for objects and check your vehicle's mirrors.

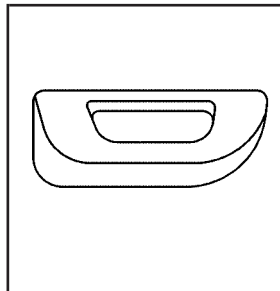

The display is located above the rear window and can be seen by looking over your right shoulder.

URPA uses three color-coded lights to provide distance and system information.

How the System Works

URPA comes on automatically when the shift lever is moved into REVERSE (R). The rear display will then briefly illuminate to let you know the system is working.

URPA operates only at speeds less than 5 mph (8 km/h). If you are above this speed, the red light on the rear display will flash.

To be detected, objects must be at least 10 inches (25.4 cm) off the ground and below trunk level. Objects must also be within 8 feet (2.5 m) from your rear bumper. This distance may be less during warmer or humid weather.

A single beep will sound the first time an object is detected between 20 inches (0.5 m) and 8 feet (2.5 m) away. Beeping will occur for three seconds when you are closer than 1 foot (0.3 m) from the object.

The following describes what will occur with the URPA display as you get closer to a detected object:

Description	English	Metric
amber light	8 ft	2.5 m
amber/amber lights	40 in	1.0 m
amber/amber/red lights	23 in	0.6 m
amber/amber/red lights flashing and beep for three seconds	1 ft	0.3 m

The system can be disabled through the Driver Information Center (DIC). See "Park Assist" under *DIC Operation and Displays on page 3-48* for more information.

When the System Does Not Seem to Work Properly

- The driver disables the system.
- The parking brake pedal is depressed.
- The ultrasonic sensors are not clean. Keep your vehicle's rear bumper free of mud, dirt, snow, ice and slush. For cleaning instructions, see *Washing Your Vehicle on page 5-115*.
- A trailer was attached to your vehicle, or a bicycle or an object was hanging out of your trunk during your last drive cycle, the red light may illuminate in the rear display. Once the attached object is removed, URPA will return to normal operation.
- A tow bar is attached to your vehicle.
- The vehicle's bumper is damaged. Take the vehicle to your dealer/retailer to repair the system.
- Other conditions may affect system performance, such as vibrations from a jackhammer or the compression of air brakes on a very large truck.

If the system is still disabled, after driving forward at least 15 mph (25 km/h), take your vehicle to your dealer/retailer.

OnStar[®] System

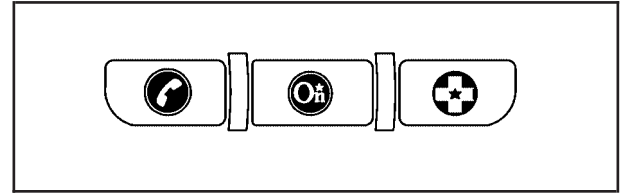

OnStar uses several innovative technologies and live advisors to provide you with a wide range of safety, security, information, and convenience services. If your airbags deploy, the system is designed to make an automatic call to OnStar Emergency advisors who can request emergency services be sent to your location. If you lock your keys in the vehicle, call OnStar at 1-888-4-ONSTAR and they can send a signal to unlock your doors. If you need roadside assistance, press the OnStar button and they can contact Roadside Service for you.

OnStar service is provided to you subject to the OnStar Terms and Conditions. You may cancel your OnStar service at any time by contacting OnStar. A complete OnStar Owner's Guide and the OnStar Terms and Conditions are included in the vehicle's OnStar Subscriber glove box literature. For more information, visit onstar.com or onstar.ca, contact OnStar at 1-888-4-ONSTAR (1-888-466-7827) or TTY 1-877-248-2080, or press the OnStar button to speak with an OnStar advisor 24 hours a day, 7 days a week.

Not all OnStar features are available on all vehicles. To check if your vehicle is equipped to provide the services described below, or for a full description of OnStar services and system limitations, see the OnStar Owner's Guide in your glove box or visit onstar.com.

OnStar Services

For new vehicles with OnStar, the Safe & Sound Plan, or the Directions & Connections Plan is included for one year from the date of purchase. You can extend this plan beyond the first year, or upgrade to the Directions & Connections Plan. For more information, press the OnStar button to speak with an advisor. Some OnStar services (such as Remote Door Unlock or Stolen Vehicle Location Assistance) may not be available until you register with OnStar.

Available Services with Safe & Sound Plan

- Automatic Notification of Airbag Deployment
- Advanced Automatic Crash Notification (AACN) (If equipped)
- Link to Emergency Services
- Roadside Assistance
- Stolen Vehicle Location Assistance
- AccidentAssist
- Remote Door Unlock/Vehicle Alert
- OnStar Vehicle Diagnostics
- GM Goodwrench® On Demand Diagnostics
- OnStar Hands-Free Calling with 30 complimentary minutes
- OnStar Virtual Advisor (U.S. Only)

Available Services included with Directions & Connections Plan

- All Safe and Sound Plan Services
- Driving Directions - Advisor delivered or OnStar Turn-by-Turn Navigation (If equipped)
- RideAssist
- Information and Convenience Services

OnStar Hands-Free Calling

OnStar Hands-Free Calling allows eligible OnStar subscribers to make and receive calls using voice commands. Hands-Free Calling is fully integrated into the vehicle, and can be used with OnStar Pre-Paid Minute Packages. Hands-Free Calling may also be linked to a Verizon Wireless service plan in the U.S. or a Bell Mobility service plan in Canada, depending on eligibility. To find out more, refer to the OnStar Owner's Guide in the vehicle's glove box, visit www.onstar.com or www.onstar.ca, or speak with an OnStar advisor by pressing the OnStar button or calling 1-888-4-ONSTAR (1-888-466-7827).

OnStar Virtual Advisor

OnStar Virtual Advisor is a feature of OnStar Hands-Free Calling that uses your minutes to access location-based weather, local traffic reports, and stock quotes. By pressing the phone button and giving a few simple voice commands, you can browse through the various topics. See the OnStar Owner's Guide for more information (Only available in the continental U.S.).

OnStar Steering Wheel Controls

Your vehicle may have a Talk/Mute button that can be used to interact with OnStar Hands-Free Calling. See *Audio Steering Wheel Controls on page 3-106* for more information.

On some vehicles, you may have to hold the button for a few seconds and give the command "ONSTAR" to activate the OnStar Hands-Free Calling.

On some vehicles, the mute button can be used to dial numbers into voicemail systems, or to dial phone extensions. See the OnStar Owner's Guide for more information.

How OnStar Service Works

Your vehicle's OnStar system has the capability of recording and transmitting vehicle information. This information is automatically sent to an OnStar Call Center at the time of an OnStar button press, Emergency button press or if your airbags or AACN system deploys. The vehicle information usually includes your GPS location and, in the event of a crash, additional information regarding the accident that your vehicle has been involved in (e.g. the direction from which your vehicle was hit). When you use the Virtual Advisor feature of OnStar Hands-Free Calling, your vehicle also sends OnStar your GPS location so that we can provide you with location-based services.

OnStar service cannot work unless your vehicle is in a place where OnStar has an agreement with a wireless service provider for service in that area. OnStar service also cannot work unless you are in a place where the wireless service provider OnStar has hired for that area has coverage, network capacity and reception when the service is needed, and technology that is compatible with the OnStar service. Not all services are available everywhere, particularly in remote or enclosed areas, or at all times.

Location information about your vehicle is only available if the GPS satellite signals are unobstructed and available.

Your vehicle must have a working electrical system (including adequate battery power) for the OnStar equipment to operate. There are other problems OnStar cannot control that may prevent OnStar from providing OnStar service to you at any particular time or place. Some examples are damage to important parts of your vehicle in an accident, hills, tall buildings, tunnels, weather or wireless phone network congestion.

Your Responsibility

Increase the radio volume if you cannot hear the OnStar advisor. If the light next to the OnStar buttons is red, this means that your system is not functioning properly and should be checked by your dealer/retailer. If the light appears clear (no light is appearing), your OnStar

subscription has expired. You can always press the OnStar button to confirm that your OnStar equipment is active.

Universal Home Remote System

Universal Home Remote System

The Universal Home Remote System provides a way to replace up to three hand-held Radio-Frequency (RF) transmitters used to activate devices such as garage door openers, security systems, and home lighting.

This device complies with Part 15 of the FCC Rules. Operation is subject to the following two conditions:

1. This device may not cause harmful interference.
2. This device must accept any interference received, including interference that may cause undesired operation.

This device complies with RSS-210 of Industry Canada. Operation is subject to the following two conditions:

1. This device may not cause interference.
2. This device must accept any interference received, including interference that may cause undesired operation of the device.

Changes or modifications to this system by other than an authorized service facility could void authorization to use this equipment.

Universal Home Remote System Operation (With One Triangular LED)

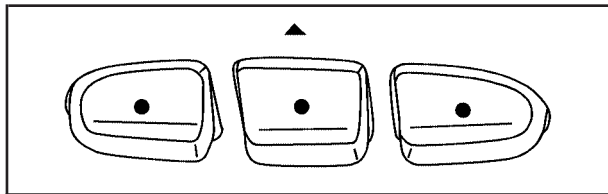

If there is one triangular Light Emitting Diode (LED) indicator light above the Universal Home Remote buttons, follow the instructions below.

This system provides a way to replace up to three remote control transmitters used to activate devices such as garage door openers, security systems, and home automation devices.

Do not use the Universal Home Remote with any garage door opener that does not have the stop and reverse feature. This includes any garage door opener model manufactured before April 1, 1982.

Read the instructions completely before attempting to program the Universal Home Remote. Because of the steps involved, it may be helpful to have another person available to assist you in the programming the Universal Home Remote.

Keep the original hand-held transmitter for use in other vehicles as well as for future Universal Home Remote programming. It is also recommended that upon the sale of the vehicle, the programmed Universal Home Remote buttons should be erased for security purposes. See "Erasing Universal Home Remote Buttons" later in this section.

When programming a garage door, park outside of the garage. Park directly in line with and facing the garage door opener motor-head or gate motor-head. Be sure that people and objects are clear of the garage door or gate you are programming.

It is recommended that a new battery be installed in your hand-held transmitter for quicker and more accurate transmission of the radio-frequency signal.

Programming the Universal Home Remote System

If you have questions or need help programming the Universal Home Remote System, call 1-800-355-3515 or go to www.homelink.com.

Programming a garage door opener involves time-sensitive actions, so read the entire procedure before you begin. If you do not follow these actions, the device will time out and you will have to repeat the procedure.

To program up to three devices:

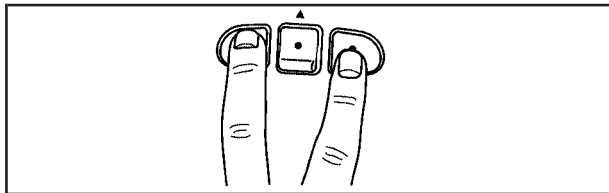

1. From inside the vehicle, press and hold down the two outside buttons at the same time, releasing only when the Universal Home Remote indicator light begins to flash, after 20 seconds. This step will erase the factory settings or all previously programmed buttons.

Do not hold down the buttons for longer than 30 seconds and do not repeat this step to program the remaining two Universal Home Remote buttons.

2. Hold the end of your hand-held transmitter about 1 to 3 inches (3 to 8 cm) away from the Universal Home Remote buttons while keeping the indicator light in view. The hand-held transmitter was supplied by the manufacturer of your garage door opener receiver (motor head unit).
3. At the same time, press and hold both the Universal Home Remote button that you would like to use to control the garage door and the hand-held transmitter button. Do not release the Universal Home Remote button or the hand-held transmitter button until Step 4 has been completed.

Some entry gates and garage door openers may require you to substitute Step 3 with the procedure noted in "Gate Operator and Canadian Programming" later in this section.

4. The indicator light on the Universal Home Remote will flash slowly at first and then rapidly after Universal Home Remote successfully receives the frequency signal from the hand-held transmitter. Release both buttons.

5. Press and hold the newly-trained Universal Home Remote button and observe the indicator light.

If the indicator light stays on continuously, the programming is complete and your garage door should move when the Universal Home Remote button is pressed and released. You do not need to continue the programming Steps 6 through 8 and can stop here.

If the Universal Home Remote indicator light blinks rapidly for two seconds and then turns to a constant light, continue with the programming Steps 6 through 8.

It may be helpful to have another person available to assist with the remaining steps.

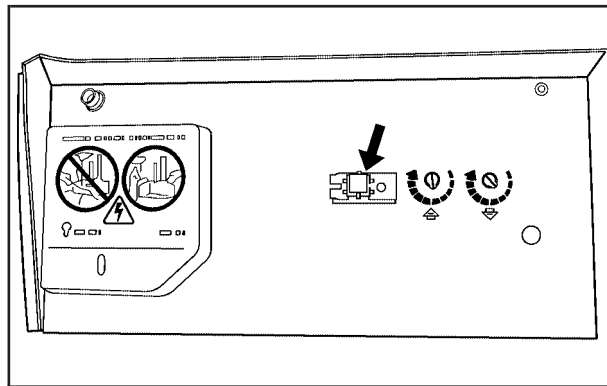

6. After Steps 1 through 5 have been completed, locate inside the garage the garage door opener receiver (motor-head unit). Locate the “Learn” or “Smart” button. The name and color of the button may vary by manufacturer.
7. Firmly press and release the “Learn” or “Smart” button. After you press this button, you will have 30 seconds to complete Step 8.

8. Immediately return to the vehicle. Firmly press and hold the Universal Home Remote button, chosen in Step 3 to control the garage door, for two seconds, and then release it. If the garage door does not move, press and hold the same button a second time for two seconds, and then release it. Again, if the door does not move, press and hold the same button a third time for two seconds, and then release.

The Universal Home Remote should now activate the garage door.

To program the remaining two Universal Home Remote buttons, begin with Step 2 of “Programming the Universal Home Remote System.” Do not repeat Step 1, as this will erase all previous programming from the Universal Home Remote buttons.

Gate Operator and Canadian Programming

If you have questions or need help programming the Universal Home Remote System, call 1-800-355-3515 or go to www.homelink.com.

Canadian radio-frequency laws require transmitter signals to time out or quit after several seconds of transmission. This may not be long enough for Universal Home Remote to pick up the signal during programming.

Similarly, some U.S. gate operators are manufactured to time out in the same manner.

If you live in Canada, or you are having difficulty programming a gate operator or garage door opener by using the “Programming Universal Home Remote” procedures, regardless of where you live, replace Step 3 under “Programming Universal Home Remote” with the following:

Continue to press and hold the Universal Home Remote button while you press and release every two seconds (cycle) the hand-held transmitter button until the frequency signal has been successfully accepted by the Universal Home Remote. The Universal Home Remote indicator light will flash slowly at first and then rapidly. Proceed with Step 4 under “Programming Universal Home Remote” to complete.

Using Universal Home Remote

Press and hold the appropriate Universal Home Remote button for at least half of a second. The indicator light will come on while the signal is being transmitted.

Erasing Universal Home Remote Buttons

Erase the programmed buttons when you sell or terminate your lease.

To erase all programmed buttons on the Universal Home Remote device:

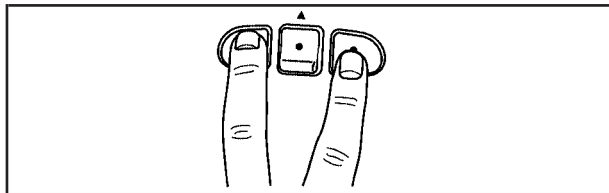

1. Press and hold down the two outside buttons until the indicator light begins to flash, after 20 seconds.
2. Release both buttons.

Reprogramming a Single Universal Home Remote Button

To reprogram any of the three Universal Home Remote buttons, repeat the programming instructions earlier in this section, beginning with Step 2.

For help or information on the Universal Home Remote System, call the customer assistance phone number under *Customer Assistance Offices on page 7-5*.

Storage Areas

Glove Box

To open, press the button. Use the key to lock and unlock.

Cupholder(s)

Your vehicle has cupholders located in front of the center console. Push down on the lid to open.

Instrument Panel Storage

Your vehicle has a storage area located below the climate control systems. To access, push on the lid.

Center Console Storage

Your vehicle has a center console with an upper and lower storage area. To access the upper storage area, push the button on the front of the console and lift the cover. To access the lower storage area, pull up on the center console. There is an additional storage area behind the center console. To access, push the cover in.

Convenience Net

Your vehicle may have a convenience net in the rear of the vehicle. Put small loads behind the net. It can also be positioned into an envelope style to hold smaller items. The net is not for heavier loads. Store them as far forward as you can.

Sunroof

If your vehicle has a power sunroof it will only operate when the ignition is turned on, or in ACC/ACCESSORY, or when Retained Accessory Power (RAP) is active. See *Retained Accessory Power (RAP)* on page 2-34.

The sunroof switches are located on the overhead console.

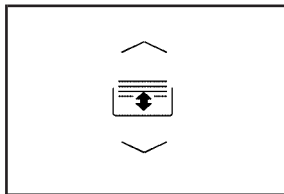

The driver side switch operates the sunshade.

Press and hold the rear of the switch to open the sunshade. Press and hold the front of the switch to close the sunshade.

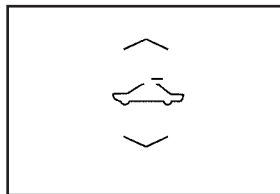

The passenger side switch operates the sunroof.

Vent Feature: Press and hold the front of the switch to vent the sunroof. Press and hold the rear of the switch to close the vent.

Sunroof Feature: Press the rear of the switch to open the sunroof, and the front of the switch to close it.

Anti-Pinch Feature

If an object is in the path of the sunroof when it is closing, the anti-pinch feature will detect the object and stop the sunroof from closing at the point of the obstruction. The sunroof will then return to the full-open or vent position. To close the sunroof once it has re-opened press and hold the front of the passenger's side switch.

Section 3 Instrument Panel

Instrument Panel Overview	3-4	Parade Dimming	3-19
Hazard Warning Flashers	3-6	Reading Lamps	3-20
Horn	3-6	Electric Power Management	3-20
Tilt and Telescopic Steering Wheel	3-6	Battery Run-Down Protection	3-21
Power Tilt Wheel and Telescopic Steering Column	3-7	Accessory Power Outlet(s)	3-21
Turn Signal/Multifunction Lever	3-7	Ashtray(s) and Cigarette Lighter	3-22
Turn and Lane-Change Signals	3-8	Analog Clock	3-22
Headlamp High/Low-Beam Changer	3-8	Climate Controls	3-23
Flash-to-Pass	3-9	Dual Climate Control System	3-23
Windshield Wipers	3-9	Outlet Adjustment	3-27
Rainsense™ Wipers	3-10	Passenger Compartment Air Filter	3-28
Windshield Washer	3-11	Warning Lights, Gages, and Indicators	3-29
Headlamp Washer	3-13	Instrument Panel Cluster	3-30
Cruise Control	3-13	Speedometer and Odometer	3-31
Headlamps	3-16	Trip Odometers	3-31
Wiper Activated Headlamps	3-17	Tachometer	3-31
Headlamps on Reminder	3-17	Engine Speed Limiter	3-32
Daytime Running Lamps (DRL)	3-17	Safety Belt Reminders	3-32
Adaptive Forward Lighting System	3-18	Airbag Readiness Light	3-33
Fog Lamps	3-18	Passenger Airbag Status Indicator	3-34
Exterior Lighting Battery Saver	3-19	Charging System Light	3-36
Instrument Panel Brightness	3-19	Up-Shift Light	3-36
Entry Lighting	3-19	Brake System Warning Light	3-37

Section 3 Instrument Panel

Antilock Brake System Warning Light	3-38	Driver Information Center (DIC)	3-47
Traction Control System (TCS)/ StabiliTrak® Warning Light	3-38	DIC Operation and Displays	3-48
Engine Coolant Temperature Warning Light	3-39	DIC Compass	3-52
Engine Coolant Temperature Gage	3-39	DIC Warnings and Messages	3-54
Tire Pressure Light	3-40	DIC Vehicle Customization	3-68
Malfunction Indicator Lamp	3-40	Audio System(s)	3-79
Oil Pressure Light	3-43	Radio(s)	3-80
Engine Oil Pressure Gage	3-44	Using an MP3	3-101
Security Light	3-45	XM Radio Messages	3-105
Fog Lamp Light	3-45	Navigation/Radio System	3-106
Lights On Reminder	3-46	Theft-Deterrent Feature	3-106
Cruise Control Light	3-46	Audio Steering Wheel Controls	3-106
Highbeam On Light	3-46	Radio Reception	3-107
Fuel Gage	3-46	Backglass Antenna	3-108
		XM™ Satellite Radio Antenna System	3-108

Instrument Panel Overview

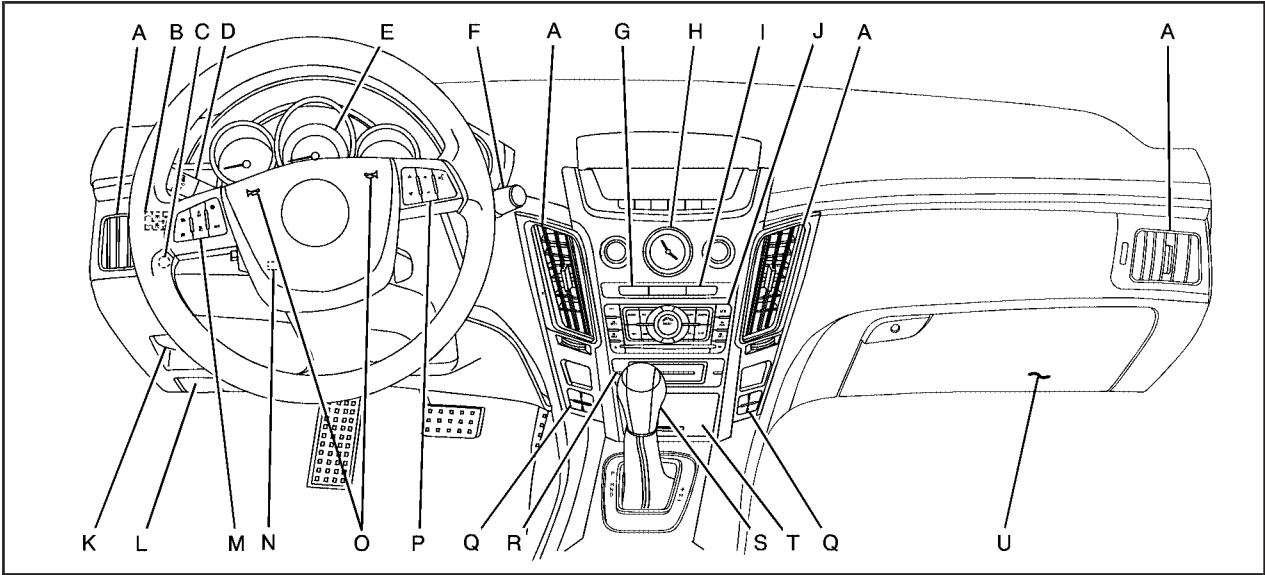

The main components of the instrument panel are the following:

- A. Air Outlets. See *Outlet Adjustment on page 3-27.*
- B. Driver Information Center (DIC) Buttons. See *Driver Information Center (DIC) on page 3-47.*
- C. Instrument Panel Brightness Control. See *Instrument Panel Brightness on page 3-19.*
- D. Turn Signal/Multifunction Lever. See *Turn Signal/ Multifunction Lever on page 3-7.*
- E. Instrument Panel Cluster. See *Instrument Panel Cluster on page 3-30.*
- F. Windshield Wiper Lever. See *Windshield Wipers on page 3-9.*
- G. Traction Control System (TCS) Disable Button. See *Traction Control System (TCS) on page 4-6.*
- H. Analog Clock. See *Analog Clock on page 3-22.*
- I. Hazard Warning Flasher Button. See *Hazard Warning Flashers on page 3-6.*
- J. Audio (Base Audio System) or Audio/Navigation System (If Equipped). See *Audio System(s) on page 3-79 or Navigation/Radio System on page 3-106.*
- K. Parking Brake Release. See *Parking Brake on page 2-43.*
- L. Hood Release. See *Hood Release on page 5-13.*
- M. Cruise Control Buttons. See *Cruise Control on page 3-13.*
- N. Tilt Wheel Lever. See *Tilt and Telescopic Steering Wheel on page 3-6 or Power Tilt Wheel and Telescopic Steering Column on page 3-7.*
- O. Horn. See *Horn on page 3-6.*
- P. Audio Steering Wheel Controls. See *Audio Steering Wheel Controls on page 3-106.*
- Q. Heated and Ventilated Seats. See *Heated and Ventilated Seats on page 1-6.*
- R. Dual Climate Control System. See *Dual Climate Control System on page 3-23.*
- S. Shift Lever. See *Automatic Transmission Operation on page 2-37 or Manual Transmission Operation on page 2-41.*
- T. Storage Compartment. See *Instrument Panel Storage on page 2-61.* Accessory Power Outlet. See *Accessory Power Outlet(s) on page 3-21.*
- U. Glove Box. See *Glove Box on page 2-61.*

Hazard Warning Flashers

The hazard warning flashers let you warn the police and others that you have a problem. The front and rear turn signal lamps will flash on and off.

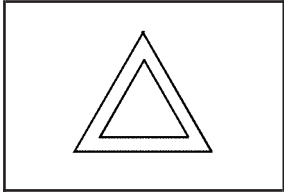

The hazard warning flasher button is on the instrument panel.

Press the button to make the front and rear turn signal lamps flash on and off. Press again to turn the flashers completely off.

The hazard warning flashers work even if the key is not in the ignition switch.

Horn

Press near or on the horn symbols on the steering wheel pad to sound the horn.

Tilt and Telescopic Steering Wheel

A tilt and telescope wheel lets you adjust the steering wheel before you drive. The steering wheel can be raised to the highest level to give your legs more room when entering and exiting the vehicle.

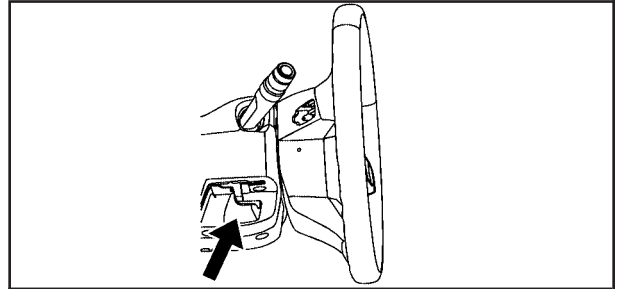

The tilt and telescope lever is located on the left side of the steering column.

To tilt and telescope the steering wheel, pull the lever down. Then move the steering wheel up or down or backward or forward into a comfortable position. Pull the lever up to lock the steering wheel in place.

Power Tilt Wheel and Telescopic Steering Column

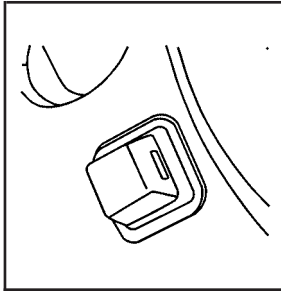

If your vehicle has this feature, the power tilt wheel control is located on the left side of the steering column.



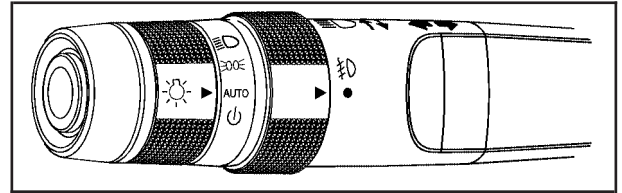

To operate the power tilt feature, push the control up and the steering wheel tilts up. Push the control down and the steering wheel goes down.

Push the control forward and the steering wheel moves toward the front of the vehicle. Push the control rearward and the steering wheel moves toward the rear of the vehicle.

Turn Signal/Multifunction Lever



The lever on the left side of the steering column includes the following:

-  Turn and Lane-Change Signals. See *Turn and Lane-Change Signals* on page 3-8.
-  Exterior Lamp Control. See *Headlamps* on page 3-16.
-  Headlamp High/Low-Beam Changer. See *Headlamp High/Low-Beam Changer* on page 3-8.
- Flash-To-Pass Feature. See *Flash-to-Pass* on page 3-9.
-  Fog Lamps. See *Fog Lamps* on page 3-18.

Turn and Lane-Change Signals

To signal a turn, move the lever all the way up or down. The lever returns automatically when the turn is complete.

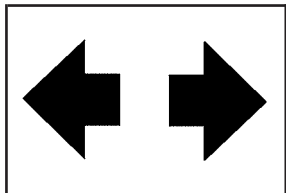

An arrow on the instrument panel cluster flashes in the direction of the turn or lane change.

Raise or lower the lever until the arrow starts to flash to signal a lane change. Hold it briefly until the lane change is complete. The arrow will automatically flash three times. The lever returns to its original position when it is released.

Rapid flashing of arrows when signaling for a turn or lane change can be caused by a burned-out signal bulb. Other drivers will not see the signal.

Replace burned-out bulbs to help avoid possible accidents. Check the fuse for burned-out bulbs if the arrow fails to work when signaling a turn. See *Fuses and Circuit Breakers on page 5-122* for more information.

Turn Signal On Chime

If the turn signal is left on for about 1 mile (1.6 km), a warning chime will sound and the TURN SIGNAL ON message will appear on the Driver Information Center (DIC) display. See “Turn Signal On” under *DIC Warnings and Messages on page 3-54* for more information.

Headlamp High/Low-Beam Changer

Push forward on the turn signal/multifunction lever to change the headlamps from low to high beam. Pull the lever back and then release it to change from high to low beam.

If the vehicle is turned off while the high beams are on, they will come on the next time the vehicle is started.

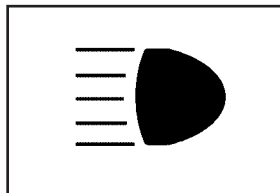

The highbeam light on the instrument panel cluster, comes on while the high-beam headlamps are on.

Flash-to-Pass

This feature allows you to use the high-beam headlamps to signal the driver in front of you that you want to pass.

Pull and hold the turn signal/multifunction lever toward you to use this feature. When this is done the following will occur:

- If the headlamps are off, in low-beam or in Daytime Running Lamps (DRL) mode, the high-beam headlamps will turn on. They will stay on as long as the lever is held there. Release the lever to turn them off.
- For vehicles with High Intensity Discharge (HID) headlamps, the low-beam headlamps must be on to activate the high-beam headlamps. See *High Intensity Discharge (HID) Lighting on page 5-55*.
- If the headlamps are already in high-beam mode, they will remain on high-beam.

Windshield Wipers

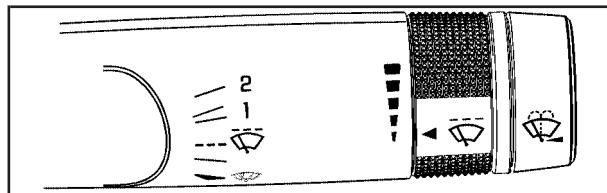

The lever on the right side of the steering column operates the windshield wipers.

▼  **(Mist):** Pull the lever down and release it for a single wiping cycle. The lever will return to its original position. For more cycles, hold the lever down before releasing it.

 **(Delay):** Move the lever to this position to set a delay between wipes. Turn the delay adjustment band to set the length of the delay.

▮ **(Delay Adjustment):** Use this band to set the length of the delay between wipes when using the delay feature. The closer the band is moved towards ▼ , the longer the delay. The windshield wiper lever must be in delay for this feature to work.

1 (Low Speed): Move the lever to this position for slow, steady wiping cycles.

2 (High Speed): Move the lever to this position for rapid wiping cycles.

If the windshield wipers are in use for about six seconds while you are driving, the exterior lamps come on automatically if the exterior lamp control is in AUTO. See *Wiper Activated Headlamps on page 3-17* for more information.

Be sure to clear ice and snow from the wiper blades before using them. If they are frozen to the windshield, gently loosen or thaw them. If the blades do become damaged, install new blades. For more information, see *Windshield Wiper Blade Replacement on page 5-57*.

Heavy snow or ice can overload the wiper motor. A circuit breaker will stop the motor until it cools down. Clear away snow or ice to prevent an overload.

Rainsense™ Wipers

Vehicles with Rainsense™ windshield wipers, have a moisture sensor for this feature mounted on the interior side of the windshield behind the rearview mirror. This sensor automatically operates the wipers by monitoring the amount of moisture build-up on the windshield. Wipes occur as needed to clear the windshield depending on driving conditions and the sensitivity setting. In light rain or snow, fewer wipes will occur. In heavy rain or snow, wipes occur more frequently. If the system is left on for long periods of time, occasional wipes may occur without any moisture on the windshield. This is normal and indicates that the Rainsense™ system is activated.

The wiper control should be left in the off position, unless the wiper is needed.

The Rainsense™ system is sensitive to vibration and can activate if something hits the windshield or if the vehicle hits a bump.

Rainsense™ windshield wipers operate in a delay mode, as well as a continuous low or high speed as needed. Move the wiper lever up to the delay position and turn the band to one of five settings.

The level one or lowest setting is at the bottom of the band. This setting lets more rain or snow collect on the windshield between wipes. Turn the delay band forward to a higher setting to let less rain or snow collect on the windshield between wipes.

The top position is the highest setting. A single wipe occurs each time the delay band is turned to a higher setting to indicate that the Rainsense™[®] level has been increased.

Notice: Going through an automatic car wash with the wipers on can damage them. Turn the wipers off when going through an automatic car wash.

The mist and wash cycles operate as normal and are not affected by the Rainsense™ function. The Rainsense™ system can be overridden at any time by manually changing the wiper control to low or high speed. The system will default to normal time delay operation if the Rainsensor detects something that would affect Rainsense™ operation.

When Rainsense™ is active, the headlamps turn on automatically. If it is dark, they remain on. See “Wiper-Activated Headlamps” under *Wiper Activated Headlamps on page 3-17* for more information.

Notice: Do not place stickers or other items on the exterior glass surface directly in front of the moisture sensor. Doing this could cause the moisture sensor to malfunction.

Windshield Washer

CAUTION:

In freezing weather, do not use your washer until the windshield is warmed. Otherwise the washer fluid can form ice on the windshield, blocking your vision.

 **(Washer Fluid):** Press the button with this symbol, located at the end of the windshield washer lever, to wash the windshield. The washer fluid sprays onto the windshield and the wipers run for a few cycles to clear the windshield. Press and hold the button for more wash cycles.

Washer Fluid Low Add Fluid displays on the Driver Information Center (DIC) when the washer fluid is low. See *DIC Warnings and Messages on page 3-54*.

If the headlamps are on while the windshield is being washed, the headlamp washers, if the vehicle has them, will also turn on. See “Headlamp Washer” following for more information.

Heated Windshield Washer

If your vehicle has the heated windshield washer fluid system it can be used to help clear ice, snow, tree sap, or bugs from the windshield.

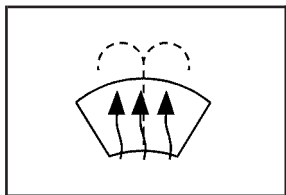

The button is located on the climate control system panel.

Push the heated washer fluid button to begin four heated wipe cycles. Heating Washer Fluid Wash Wipes Pending displays on the DIC. See *DIC Warnings and Messages on page 3-54*. The first heated wipe cycle can take up to 40 seconds to occur, depending on the outside temperature. After the first wipe cycle, it can take up to 20 seconds for each of the remaining cycles.

Press the button again to turn off the heated windshield washer fluid system. Heated Washer Fluid System Off displays on the DIC. See *DIC Warnings and Messages on page 3-54*. It automatically turns off after four wipe cycles have been completed.

When the heated windshield washer fluid system is activated under certain outside temperature conditions, steam might flow out of the washer nozzles for a short period of time before washer fluid is sprayed. This is a normal condition.

Washer Fluid Low Add Fluid displays on the DIC when the washer fluid is low. See *DIC Warnings and Messages on page 3-54*.

Headlamp Washer

Your vehicle may have headlamp washers. The headlamp washers clear debris from the headlamp lenses.

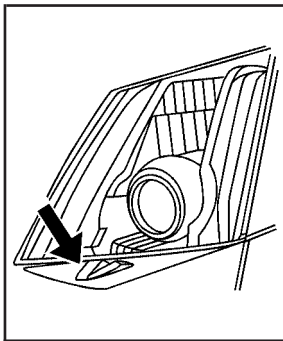

The headlamp washers are located beneath the headlamps.

Press the washer button located at the end of the windshield wiper lever, to wash the headlamps. Both the headlamps and the windshield will be washed. After the first wash, the headlamps will not be washed until the fifth press of the windshield washer button.

The headlamps must be on to be washed. If the headlamps are off, only the windshield will be washed when the washer button is pressed. If the washer fluid is low, the headlamp washers will not work.

See *Windshield Washer* on page 3-11 for more information.

Cruise Control

CAUTION:

Cruise control can be dangerous where you cannot drive safely at a steady speed. So, do not use your cruise control on winding roads or in heavy traffic.

Cruise control can be dangerous on slippery roads. On such roads, fast changes in tire traction can cause excessive wheel slip, and you could lose control. Do not use cruise control on slippery roads.

With cruise control, a speed of about 25 mph (40 km/h) or more can be maintained without keeping your foot on the accelerator. This can really help on long trips. Cruise control does not work at speeds below about 25 mph (40 km/h).

When the brakes are applied, the cruise control turns off.

If your vehicle has the StabiliTrak[®] system and begins to limit wheel spin while you are using cruise control, the cruise control will automatically disengage. See *StabiliTrak[®] System on page 4-8*. When road conditions allow you to safely use it again, the cruise control can be turned back on.

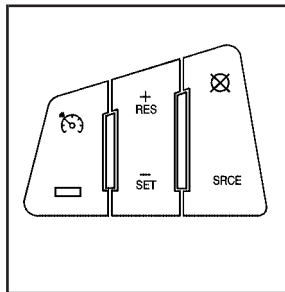

The cruise control buttons are located on the left side of the steering wheel.

⏻ (On/Off): Press button to activate and turn off the system. The indicator light on the button turns on when cruise control is on.

+ RES (Resume/Accelerate): Press this button to make the vehicle accelerate or resume to a previously set speed.

SET – (Set/Coast): Press this button to set the speed or make the vehicle decelerate.

⊗ (Cancel): Press this button to cancel cruise control without erasing the set speed from memory.

Setting Cruise Control

Cruise control will not work if the parking brake is set, or if the master cylinder brake fluid level is low.

The cruise control light on the instrument panel cluster comes on after the cruise control has been set to the desired speed.

CAUTION:

If you leave your cruise control on when you are not using cruise, you might hit a button and go into cruise when you do not want to. You could be startled and even lose control. Keep the cruise control switch off until you want to use cruise control.

1. Press the cruise control On/Off button.
2. Get up to the desired speed.
3. Press the SET– button located on the steering wheel and release it.
4. Take your foot off the accelerator.

Resuming a Set Speed

Suppose the cruise control is set at a desired speed and then the brake is applied. This shuts off the cruise control. But it does not need to be reset.

Once the vehicle is driving at about 25 mph (40 km/h) or more, press the +RES button on the steering wheel. The vehicle will go back to the previous set speed and stay there.

Increasing Speed While Using Cruise Control

To increase the cruise speed while using cruise control:

- Press and hold the +RES button on the steering wheel until the new desired speed is reached, then release it.
- To increase vehicle speed in small increments, press the +RES button. Each time this is done, the vehicle goes about 1 mph (1.6 km/h) faster.

Reducing Speed While Using Cruise Control

To reduce the vehicle's speed while using cruise control:

- Press and hold the SET- button on the steering wheel until the desired lower speed is reached, then release it.
- To slow down in very small amounts, press the SET- button on the steering wheel briefly. Each time this is done, the vehicle goes about 1 mph (1.6 km/h) slower.

Passing Another Vehicle While Using Cruise Control

Use the accelerator pedal to increase the vehicle's speed. When you take your foot off the pedal, the vehicle will slow down to the previous set cruise speed.

Using Cruise Control on Hills

How well the cruise control works on hills depends upon the vehicle's speed, load, and the steepness of the hills. When going up steep hills, you might have to step on the accelerator pedal to maintain the vehicle's speed. When going downhill, you might have to brake or shift to a lower gear to keep the vehicle's speed down. When the brakes are applied the cruise control turns off. Many drivers find this to be too much trouble and do not use cruise control on steep hills.

Ending Cruise Control

There are three ways to end cruise control:

- Step lightly on the brake pedal (manual and automatic transmissions).
- Press the clutch pedal to the floor (manual transmissions).
- Press the cancel button on the steering wheel.
- Press the On/Off button on the steering wheel.

Erasing Speed Memory

The cruise control set speed memory is erased when the cruise control or the ignition is turned off.

Headlamps

The exterior lamp control is located towards the end of the turn signal/multifunction lever.

 **(Exterior Lamp Control):** Turn the band with this symbol on it to operate the exterior lamps.

The exterior lamp control has four positions:

 **(Off):** This position turns off all lamps, except the Daytime Running Lamps (DRL).

AUTO (Automatic): This position puts the headlamps in automatic mode. AUTO mode turns the exterior lamps on and off depending upon how much light is available outside of the vehicle.

 **(Parking Lamps):** This position turns on the parking lamps together with the following:

- Sidemarkers Lamps
- Taillamps
- License Plate Lamps
- Instrument Panel Lights

 **(Headlamps):** This position turns on the headlamps, together with the previously listed lamps and lights.

Wiper Activated Headlamps

This feature activates the headlamps and parking lamps after the windshield wipers have been in use for about six seconds. For this feature to work, the exterior lamp control must be in AUTO.

The wiper-activated headlamps immediately turn off, when the ignition is turned to LOCK/OFF or the windshield wiper control is turned off.

Headlamps on Reminder

A warning chime will sound if the exterior lamp control is left on in either the headlamp or parking lamp position and the driver's door is opened with the ignition off. See *Lights On Reminder on page 3-46* for additional information.

Daytime Running Lamps (DRL)

Daytime Running Lamps (DRL) can make it easier for others to see the front of your vehicle during the day. DRL can be helpful in many different driving conditions, but they can be especially helpful in the short periods after dawn and before sunset. Fully functional daytime running lamps are required on all vehicles first sold in Canada.

The DRL system will make either the reduced intensity low-beam headlamps or dedicated DRL's come on when the following conditions are met:

- It is still daylight and the ignition is in ON/RUN or START.
- The exterior lamp control is in off or AUTO and the headlamps are off.
- The automatic transmission is not in PARK (P).

When DRL's are on, only the reduced intensity low-beam headlamps or dedicated DRL's will be on. No other exterior lamps will be on. The instrument panel cluster will not be lit up either.

When the exterior lamp control is in AUTO and it is dark enough outside, the DRL turns off and the low-beam headlamps will turn on. When it is bright enough outside, the low-beam headlamps will go off, and the DRL will turn back on. If the vehicle is started in a dark garage, the automatic headlamp system comes on immediately. Once the vehicle leaves the garage, it takes about one minute for the automatic headlamp system to change to DRL if it is light outside. During that delay, the instrument panel cluster may not be as bright as usual. Make sure the instrument panel brightness lever is in the full bright position. See *Instrument Panel Brightness on page 3-19*.

Turning the exterior lamp control to off or to the low-beam headlamp position will turn off the DRL. If the parking lamps or the fog lamps were turned on instead, the DRL will still turn off.

This will work regardless of gear position and whether or not the parking brake is set.

Light Sensor

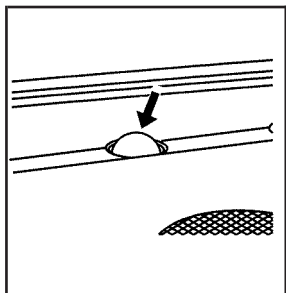

The light sensor for the DRL and AUTO headlamp feature is located on top of the instrument panel. If the sensor is covered, it will prevent it from sensing light, and the exterior lamps or the Headlamps Suggested message will appear on the DIC whenever the ignition is on.

Adaptive Forward Lighting System

The Adaptive Forward Lighting System (AFL) swivels the headlamps horizontally to provide greater road illumination while turning. AFL will operate when the vehicle speed is greater than 2 mph (3 km/h). AFL will not operate when the transmission is in REVERSE (R). AFL is not immediately operable after starting the vehicle; driving a short distance is required to calibrate the AFL. To enable AFL, set the exterior lamp switch on the multifunction lever to the AUTO position. Moving the switch out of the AUTO position will deactivate the system. See *Headlamps on page 3-16*.

Fog Lamps

Use the fog lamps for better vision in foggy or misty conditions.

The fog lamp control is located on the turn signal/multifunction lever.

⓪ (Fog Lamps): Turn the fog lamp band on the lever up to ⓪ and release it, to turn the fog lamps on or off. The band will return to its original position.

The parking lamps must be on for the fog lamps to work. If the high-beam headlamps are turned on, the fog lamps will also turn off. They will turn back on again when you switch back to low-beam headlamps.

Some localities have laws that require the headlamps to be on along with the fog lamps.

Exterior Lighting Battery Saver

The exterior lamps turn off about 10 minutes after the ignition is turned to LOCK/OFF, if the parking lamps or headlamps have been left on. This protects against draining the battery. The battery saver does not work if the headlamps are turned on after the ignition is turned to LOCK/OFF.

To keep the lamps on for more than 10 minutes, turn the lamps back on with the exterior lamp control.

Instrument Panel Brightness

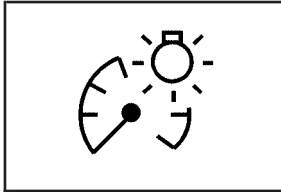

The knob with this symbol on it is located on the instrument panel to the left of the steering column.

Turn the knob clockwise to brighten the lights or counterclockwise to dim them.

Turn the knob completely clockwise to turn on the interior lamps.

Entry Lighting

The entry lighting system turns on the reading and dome lamps and the backlighting to the exterior lamp control, when a door is opened or if the transmitter unlock button is pressed. If activated by the transmitter, the lighting stays on for about 25 seconds. The entry lighting system uses the light sensor on the instrument panel; so it must be dark outside in order for the lamps to turn on. The lamps turn off about 25 seconds after the last door is closed. They dim then turn off if the ignition key is turned to ON/RUN. They immediately turn off if the power locks are used.

Parade Dimming

This feature does not let the instrument panel backlight dim during daylight hours while the key is in the ignition and the headlamps are on. Parade dimming automatically works with the light sensor, located on top of the dashboard. If it is dark enough outside and the parking lamps are on, the backlight on the instrument panel can be adjusted by turning the instrument panel brightness knob clockwise or counterclockwise to brighten or dim the lighting. See *Instrument Panel Brightness on page 3-19*.

Reading Lamps

The reading lamps are located on the overhead console. These lamps come on automatically when any door is opened.

For manual operation, press the button next to each lamp to turn it on or off.

If the reading lamps are left on, they automatically shut off 10 minutes after the ignition has been turned off.

Electric Power Management

The vehicle has Electric Power Management (EPM) that estimates the battery's temperature and state of charge. It then adjusts the voltage for best performance and extended life of the battery.

When the battery's state of charge is low, the voltage is raised slightly to quickly put the charge back in. When the state of charge is high, the voltage is lowered slightly to prevent overcharging. If the vehicle has a voltmeter gage or a voltage display on the Driver Information Center (DIC), you may see the voltage move up or down. This is normal. If there is a problem, an alert will be displayed.

The battery can be discharged at idle if the electrical loads are very high. This is true for all vehicles. This is because the generator (alternator) may not be spinning fast enough at idle to produce all the power that is needed for very high electrical loads.

A high electrical load occurs when several of the following loads are on: headlamps, high beams, fog lamps, rear window defogger, climate control fan at high speed, heated seats, engine cooling fans, trailer loads, and loads plugged into accessory power outlets.

EPM works to prevent excessive discharge of the battery. It does this by balancing the generator's output and the vehicle's electrical needs. It can increase engine idle speed to generate more power, whenever needed. It can temporarily reduce the power demands of some accessories.

Normally, these actions occur in steps or levels, without being noticeable. In rare cases at the highest levels of corrective action, this action may be noticeable to the driver. If so, a Driver Information Center (DIC) message might be displayed, such as Battery Saver Active or Service Battery Charging System. If this message is displayed, it is recommended that the driver reduce the electrical loads as much as possible. See *DIC Warnings and Messages on page 3-54*.

Battery Run-Down Protection

Your vehicle has a feature to help prevent battery drain if accessory lamps are left on or something is left plugged into the accessory power outlet or cigarette lighter, if the vehicle has one. If accessory lamps such as the vanity mirror, cargo, reading, console, or glove box are left on, they automatically time-out after about 20 minutes. To reset the battery protection, all of the above lamps must be turned off or the ignition must be in the ACC/ACCESSORY position.

Accessory Power Outlet(s)

Accessory power outlets can be used to connect auxiliary electrical equipment, such as a cellular telephone or CB radio.

There are three accessory power outlets. There is an outlet located in the front storage area below the climate control system, one inside the center console storage bin, and one on the rear of the center console.

To use an outlet, remove the protective cap. When not in use, always cover the outlet with the protective cap. The accessory power outlet is operational at all times.

Notice: If electrical devices are left plugged into a power outlet, the battery may drain causing your vehicle not to start or damage to the battery. This would not be covered by the warranty. Always unplug all electrical devices when turning off your vehicle.

Certain electrical accessories may not be compatible with the accessory power outlet and could result in blown vehicle or adapter fuses. If you experience a problem see your dealer/retailer for additional information on accessory power outlets.

Notice: Adding any electrical equipment to your vehicle may damage it or keep other components from working as they should. The repairs would not be covered by your warranty. Do not use equipment exceeding maximum amperage rating of 20 amperes. Check with your dealer/retailer before adding electrical equipment.

Notice: Improper use of the power outlet can cause damage not covered by your warranty. Do not hang any type of accessory or accessory bracket from the plug because the power outlets are designed for accessory power plugs only.

Ashtray(s) and Cigarette Lighter

Your vehicle may have two removable ashtrays and cigarette lighters. One ashtray can be placed into the instrument panel storage compartment and the other into the center console rear compartment. To use the lighter, push it in all the way and let go. When it is ready, it will pop back out by itself.

To empty the ashtrays, grip the edges of the bin and pull it straight out of the housing. To reinstall, push the tray back into place.

Notice: Holding a cigarette lighter in while it is heating does not let the lighter back away from the heating element when it is hot. Damage from overheating can occur to the lighter or heating element, or a fuse could be blown. Do not hold a cigarette lighter in while it is heating.

Notice: If you put papers, pins, or other flammable items in the ashtray, hot cigarettes or other smoking materials could ignite them and possibly damage your vehicle. Never put flammable items in the ashtray.

Analog Clock

The analog clock is located on the instrument panel above the radio. The clock is not connected with any other vehicle system and runs by itself. To adjust the clock:

1. Locate the adjustment buttons directly below the clock face.
2. Push and hold the right adjustment button to move the clock hands forward or the left adjustment button to make the clock hands go backward. Holding either button down will cause the clock to advance faster. Release the button before the desired time is reached.
3. Push and release either button to adjust the time by one minute increments until the desired time is reached.

Climate Controls

Dual Climate Control System

The heating, cooling, and ventilation for the vehicle can be controlled with this system.

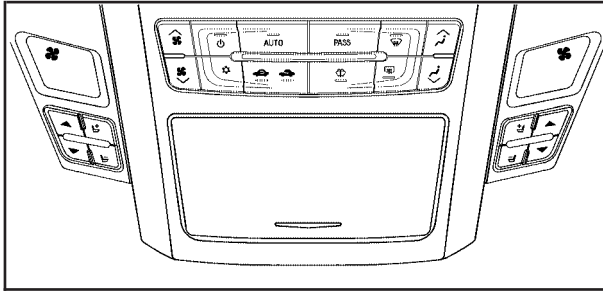

Power: Press this button to turn the climate control system on or off. When the climate control system is turned off the air inlet defaults to outside air.

Automatic Operation

AUTO (Automatic): When this button is pressed and the temperature is set, the system automatically controls the inside temperature, the air delivery mode, the air conditioning compressor, and the fan speed. When the indicator light is on, the system is in full automatic operation. If the air delivery mode or fan setting is manually adjusted, the auto indicator turns off and displays will show the selected settings.

1. Press the AUTO button.
2. Adjust the temperature to a comfortable setting between 60°F (15.5°C) and 90°F (32.2°C).

Choosing the coldest or warmest temperature setting will not cause the system to heat or cool any faster. If the system is set at the warmest temperature setting, it remains in manual mode at that temperature and it will not go into automatic mode.

In cold weather, the system starts at reduced fan speeds to avoid blowing cold air into the vehicle until warmer air is available. The system begins blowing air at the floor but may change modes automatically as the vehicle warms up to maintain the chosen temperature setting. The length of time the system needs to warm up depends on the outside temperature and the length of time that has elapsed since the vehicle was last driven.

3. Wait for the system to regulate. This may take from 10 to 30 minutes. Then adjust the temperature, if necessary.

You can switch from English to metric units through the Driver Information Center (DIC). See *DIC Vehicle Customization* on page 3-68.

The air-conditioning system removes moisture from the air, so a small amount of water might drip underneath the vehicle while it is idling or after the engine is turned off is normal.

Do not cover the solar sensor located in the center of the instrument panel, near the windshield. For more information on the solar sensor, see “Sensors” later in this section.



PASS (Passenger Climate Control): Press this button to set a different temperature for the passenger. Then press the passenger temperature adjustment buttons to select a comfortable setting.

Pressing the PASS button again automatically sets the passenger’s temperature to the driver’s setting.

Turning the passenger’s temperature display off does not shut the climate control system for the passenger off.

▲ / ▼ (Temperature Adjustment): The temperature can be adjusted separately for the driver and the passenger. Press the up or down arrow buttons to increase or decrease the automatic temperature settings.

Manual Operation

Mode: Press the  or  buttons to change the current airflow mode. The current mode selection appears in the display screen. Changing the mode cancels the automatic operation and the system goes into manual mode. Press AUTO to return to automatic operation.



The outboard air outlets always receive some airflow in every mode, except defrost. See *Outlet Adjustment* on page 3-27 to change this airflow from the outboard outlets.

Vent: This mode directs air to the instrument panel outlets.

Bi-Level: This mode splits the air between the instrument panel outlets and the floor outlets. In automatic operation, cooler air is directed to the upper outlets and warmer air to the floor outlets.

Floor: This mode directs most of the air to the floor outlets with some air directed to the outboard outlets and a little air directed to the windshield.

The mode buttons can also be used to select the defog and defrost modes. Information on defogging and defrosting can be found later in this section.

 **(Fan):** Press the  or  buttons to increase or decrease the fan speed. Pressing either button cancels automatic operation and the system goes into manual mode. Press AUTO to return to automatic operation. The blower may reduce during an Onstar[®] session to limit background noise.

If the airflow seems low when the fan speed is at the highest setting, the passenger compartment air filter might need to be replaced. For more information, see *Passenger Compartment Air Filter on page 3-28* and *Scheduled Maintenance on page 6-4*.

 **(Air Conditioning):** Press this button to override the automatic system and turn the air conditioning system on or off. When in AUTO, the air conditioning compressor will come on automatically, as necessary.

The air conditioning system removes moisture from the air, so a small amount of water might drip underneath the vehicle while idling or after turning off the engine. This is normal.

 **(Recirculation/Outside Air):** Press this button to switch between recirculation and outside air. Whenever the button is pressed, the indicator light comes on for the mode being used. The recirculation mode recirculates air inside the vehicle. It can be used to prevent outside air and odors from entering the vehicle or to help cool the air inside the vehicle more quickly. Press the auto button to have the system select the best air delivery mode for your temperature setting.

Recirculation is not available in the defrost mode and automatically turns off 10 minutes after defog is selected. This helps to limit window fogging in the vehicle.

Using recirculation for long periods of time could cause the air inside the vehicle to become too dry or stuffy. To prevent this from happening, after the air in the vehicle has cooled, select outside air or press the auto button.

The outside air mode pulls fresh air from outside the vehicle. Outside air is always selected in defrost mode to prevent fogging.

 **(Heated Windshield Washer, If Equipped):** For more information, see *Windshield Washer on page 3-11*.

Defogging and Defrosting

Fog on the inside of windows is a result of high humidity (moisture) condensing on the cool window glass. This can be minimized if the climate control system is used properly. There are two modes to clear fog from the windshield. Use the defog mode to clear the windows of fog or moisture and warm the passengers. Use the defrost mode to remove fog or frost from the windshield more quickly.

 **(Mode):** Press the mode buttons until defog appears on the display.

 **(Defog):** This mode directs the air between the windshield, floor outlets and side windows. When this mode is selected, the system turns off recirculation and runs the air-conditioning compressor unless the outside temperature is at or below freezing. If recirculation mode is selected while in defog mode, it will be cancelled after 10 minutes.

 **(Defrost):** Pressing defrost directs most of the air to the windshield, with some air directed to the side windows. In this mode, the system automatically turns off recirculation and runs the air-conditioning compressor, unless the outside temperature is at or below freezing.

This mode may also cause the fan speed and air temperature to increase.

Rear Window Defogger

The rear window defogger uses a warming grid to remove fog or frost from the rear window.

The rear window defogger will only work when the ignition is in ON/RUN.

 **(Rear Window Defogger):** Press this button to turn the rear window defogger on or off. Be sure to clear as much snow from the rear window as possible.

The rear window defogger turns off about 15 minutes after the button is first pressed if the vehicle is moving at slower speeds. At higher speeds, the rear window defogger may stay on continuously. With each additional press, the defogger runs for about 10 minutes. The defogger can also be turned off by pressing the button again or by turning off the engine.

The heated outside rearview mirrors will heat to help clear fog or frost from the surface of the mirror when the rear window defogger button is on. See *Outside Heated Mirrors* on page 2-50.

Notice: Do not try to clear frost or other material from the inside of the front windshield and rear window with a razor blade or anything else that is sharp. This may damage the rear window defogger grid and affect your radio's ability to pick up stations clearly. The repairs wouldn't be covered by your warranty.

Sensors

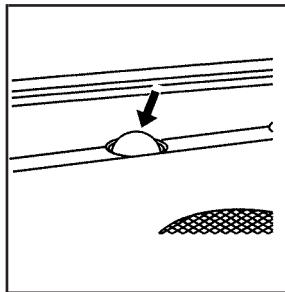

There is a solar sensor, located on the instrument panel, near the windshield.

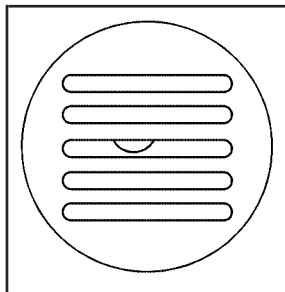

There is also an interior temperature sensor, located to the right of the steering wheel, on the instrument panel.

By monitoring the solar radiation and the air inside the vehicle, these sensors help maintain the selected temperature by adjusting the fan speed, and the air delivery system. In order to do this, the system can also supply cooler air to the side of the vehicle facing the sun. The recirculation mode will also be activated, as necessary. Do not cover the sensors or the automatic climate control system will not work properly.

Outlet Adjustment

Use the air outlets located in the center and on the side of the instrument panel to direct the airflow. Use the thumbwheels near the air outlets to open or close off the airflow.

Operation Tips

- Clear away any ice, snow, or leaves from air inlets at the base of the windshield that could block the flow of air into the vehicle.
- Keep the path under the front seats clear of objects to help circulate the air inside of the vehicle more effectively.
- Use of non-GM approved hood deflectors can adversely affect the performance of the system. Check with your dealer/retailer before adding equipment to the outside of your vehicle.

Passenger Compartment Air Filter

The passenger compartment air filter traps most of the dust and pollen from the air entering the vehicle. The filter will need to be changed periodically. See *Scheduled Maintenance on page 6-4*.

Using the climate control system without the passenger air filter installed could let water or other debris enter the system. This could cause a water leak or noises. Make sure to install a new air filter after removing the old one.

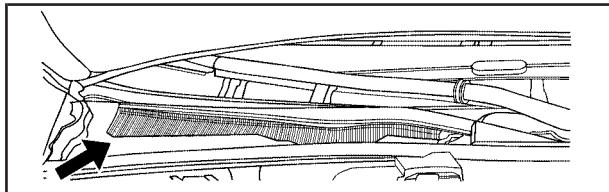

The passenger compartment air filter is located underneath the hood below the windshield wiper arm and the screen on the passenger side of the vehicle. See *Engine Compartment Overview on page 5-14* for more information on location.

To replace the passenger compartment air filter:

1. Turn the ignition to ON/RUN with the engine off.
2. Turn on the windshield wipers and turn them off again when the wipers are straight up on the windshield.

This allows access to the leaf screen. The passenger compartment air filter is located under the screen.

3. Open the hood to access the engine compartment. See *Hood Release on page 5-13* for more information.
4. Remove the three screws that hold the screen in place and lift off the screen by lifting and sliding it toward the center of the vehicle.
5. Pull out on the two tabs located on each end of the filter cover.
6. Lift the filter cover off by pulling it straight up.
7. Remove the old filter and insert a new one. See *Maintenance Replacement Parts on page 6-13* for the correct part number for the filter.
8. Reverse Steps 1 through 6 to reinstall the cover.

Warning Lights, Gages, and Indicators

This part describes the warning lights and gages that may be on your vehicle. The pictures will help you locate them.

Warning lights and gages can signal that something is wrong before it becomes serious enough to cause an expensive repair or replacement. Paying attention to the warning lights and gages could also save you or others from injury.

Warning lights come on when there may be or is a problem with one of your vehicle's functions. As you will see in the details on the next few pages, some warning lights come on briefly when you start the engine just to let you know they are working. If you are familiar with this section, you should not be alarmed when this happens.

Gages can indicate when there may be or is a problem with one of your vehicle's functions. Often gages and warning lights work together to let you know when there is a problem with your vehicle.

When one of the warning lights comes on and stays on while you are driving, or when one of the gages shows there may be a problem, check the section that tells you what to do about it. Waiting to do repairs can be costly – and even dangerous. So please get to know your warning lights and gages. They are a big help.

Your vehicle also has a Driver Information Center (DIC) that works along with the warning lights and gages. See *Driver Information Center (DIC) on page 3-47* for more information.

Instrument Panel Cluster

The instrument panel cluster is designed to let you know at a glance how your vehicle is running. You will know how fast you are going, how much fuel you are using and many of the other things you will need to know to drive safely and economically.

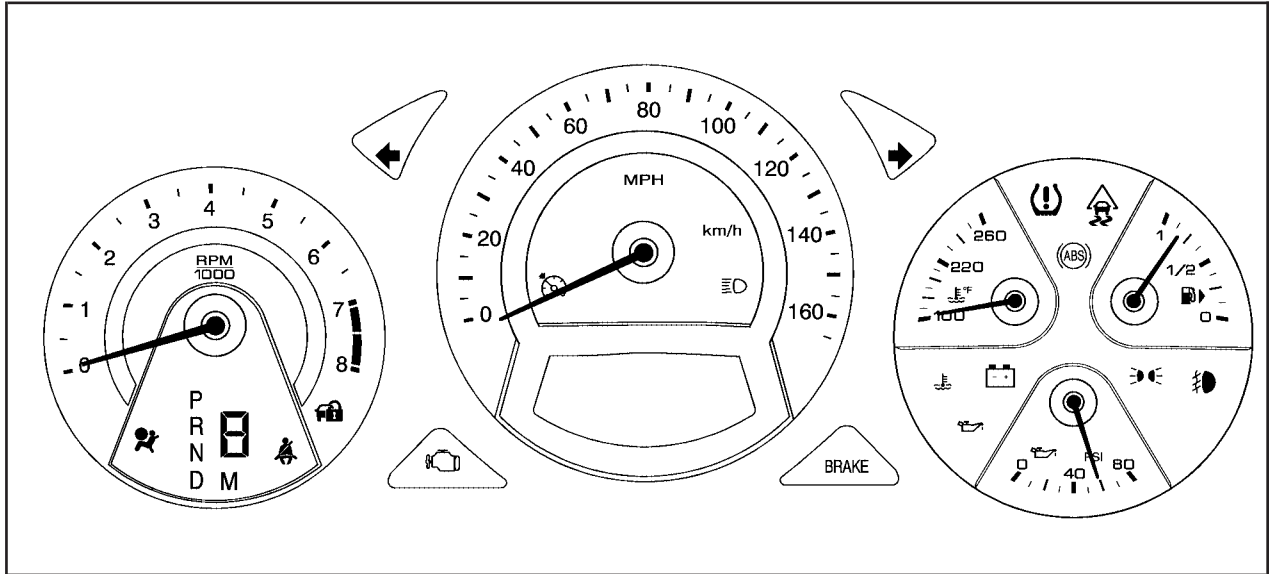

United States Automatic Cluster shown, Canada similar

Speedometer and Odometer

The speedometer lets you see your speed in either miles per hour (mph) or kilometers per hour (km/h). The odometer shows how far your vehicle has been driven, in either miles (used in the United States) or kilometers (used in Canada).

If your vehicle has to have a new odometer installed, the new one may read the correct mileage. This is because your vehicle's computer has stored the mileage in memory.

While the Driver Shift Control (DSC) feature is active, the odometer will change to show the gear range. See *Automatic Transmission Operation on page 2-37* for more information.

Trip Odometers

The trip odometer can record the number of miles or kilometers traveled for up to two trips.

The trip odometer is part of the Driver Information Center (DIC), for more information see *DIC Operation and Displays on page 3-48*.

For vehicles that have the navigation system, see your Navigation System manual for more information.

Tachometer

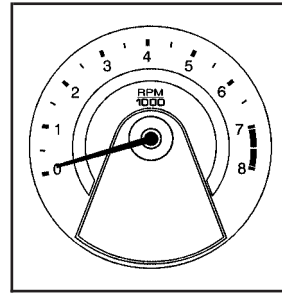

The tachometer displays the engine speed in revolutions per minute (rpm).

Notice: If you operate the engine with the tachometer in the shaded warning area, your vehicle could be damaged, and the damages would not be covered by your warranty. Do not operate the engine with the tachometer in the shaded warning area.

Engine Speed Limiter

This feature prevents the engine from operating at too many revolutions per minute (rpm). When the engine's rpms are too high, the throttle is closed to reduce speed. If this is not sufficient, then the fuel supply to the engine will be limited. When the rpms return to normal, the fuel supply will return to normal. This helps prevent damage to the engine.

Safety Belt Reminders

Safety Belt Reminder Light

When the engine is started, a chime will come on for several seconds to remind people to fasten their safety belts, unless the driver's safety belt is already buckled.



The safety belt light will also come on and stay on for several seconds, then it will flash for several more.

This chime and light is repeated if the driver remains unbuckled and the vehicle is in motion. If the driver's belt is already buckled, neither the chime nor the light will come on.

Passenger Safety Belt Reminder Light

Several seconds after the engine is started, a chime will sound for several seconds to remind the front passenger to buckle their safety belt. This would only occur if the passenger airbag is enabled. See *Passenger Sensing System on page 1-64* for more information. The passenger safety belt light, located on the instrument panel, will come on and stay on for several seconds and then flash for several more.



This chime and light are repeated if the passenger remains unbuckled and the vehicle is in motion.

If the passenger's safety belt is buckled, neither the chime nor the light will come on.

Airbag Readiness Light

There is an airbag readiness light on the instrument panel cluster, which shows the airbag symbol. The system checks the airbag's electrical system for malfunctions. The light tells you if there is an electrical problem. The system check includes the airbag sensor, the pretensioners, the airbag modules, the wiring and the crash sensing and diagnostic module. For more information on the airbag system, see *Airbag System* on page 1-55.

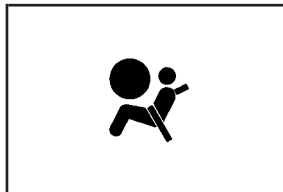

This light will come on when you start your vehicle, and it will flash for a few seconds. The light should go out and the system is ready.

If the airbag readiness light stays on after you start the vehicle or comes on when you are driving, your airbag system may not work properly. Have your vehicle serviced right away.

CAUTION:

If the airbag readiness light stays on after you start your vehicle, it means the airbag system may not be working properly. The airbags in your vehicle may not inflate in a crash, or they could even inflate without a crash. To help avoid injury to yourself or others, have your vehicle serviced right away if the airbag readiness light stays on after you start your vehicle.

The airbag readiness light should flash for a few seconds when you start the engine. If the light does not come on then, have it fixed immediately. If there is a problem with the airbag system, an airbag Driver Information Center (DIC) message may also come on. See *DIC Warnings and Messages* on page 3-54 for more information.

Passenger Airbag Status Indicator

Your vehicle has the passenger sensing system. Your instrument panel has a passenger airbag status indicator.



United States

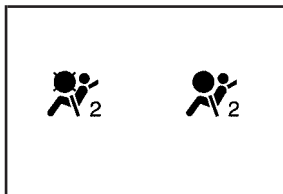

Canada

When you start the vehicle, the passenger airbag status indicator will light ON and OFF, or the symbol for on and off, for several seconds as a system check. If you use remote start to start your vehicle from a distance, if equipped, you may not see the system check. Then, after several more seconds, the status indicator will light either ON or OFF, or either the on or off symbol to let you know the status of the right front passenger's frontal and seat-mounted side impact airbags.

If the word ON or the on symbol is lit on the passenger airbag status indicator, it means that the right front passenger's frontal airbag and seat-mounted side impact airbag are enabled (may inflate).

CAUTION:

If the on indicator comes on when you have a rear-facing child restraint installed in the right front passenger's seat, it means that the passenger sensing system has not turned off the passenger's frontal airbag and seat-mounted side impact airbag (if equipped). A child in a rear-facing child restraint can be seriously injured or killed if the right front passenger's airbag inflates. This is because the back of the rear-facing child restraint would be very close to the inflating airbag. Do not use a rear-facing child restraint in the right front passenger's seat if the airbag is turned on.

 **CAUTION:**

Even though the passenger sensing system is designed to turn off the right front passenger's frontal airbag and seat-mounted side impact airbag (if equipped) if the system detects a rear-facing child restraint, no system is fail-safe, and no one can guarantee that an airbag will not deploy under some unusual circumstance, even though it is turned off. We recommend that rear-facing child restraints be secured in a rear seat, even if the airbag is or airbags are off.

If the word OFF or the off symbol is lit on the passenger airbag status indicator, it means that the passenger sensing system has turned off the right front passenger's frontal airbag and seat-mounted side impact airbag. See *Passenger Sensing System* on page 1-64 for more on this, including important safety information.

If, after several seconds, both status indicator lights remain on, or if there are no lights at all, there may be a problem with the lights or the passenger sensing system. See your dealer/retailer for service.

 **CAUTION:**

If the airbag readiness light in the instrument panel cluster ever comes on and stays on, it means that something may be wrong with the airbag system. If this ever happens, have the vehicle serviced promptly, because an adult-size person sitting in the right front passenger's seat may not have the protection of the airbag(s). See *Airbag Readiness Light* on page 3-33 for more on this, including important safety information.

Charging System Light

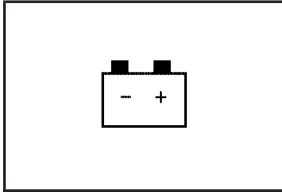

This light will come on briefly when you turn on the ignition key, but the engine is not running, as a check to show you it is working.

It should go out once the engine is running. If it stays on, or comes on while driving, there could be a problem with the charging system. A charging system Driver Information Center (DIC) message may also appear. See *DIC Warnings and Messages on page 3-54* for more information. This light could indicate that there are problems with a generator drive belt, or that there is an electrical problem. Have it checked right away. If you must drive a short distance with the light on, be certain to turn off all the accessories, such as the radio and air conditioner.

Up-Shift Light

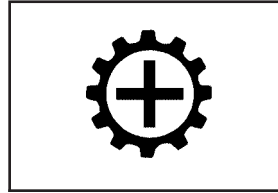

Your vehicle may have an up-shift light.

When this light comes on, you should shift to the next higher gear if weather, road, and traffic conditions allow you to.

See *Manual Transmission Operation on page 2-41* for more information.

Brake System Warning Light

Your vehicle's hydraulic brake system is divided into two parts. If one part is not working, the other part can still work and stop you. For good braking, though, you need both parts working well.

If the warning light comes on, there is a brake problem. Have your brake system inspected right away.



United States

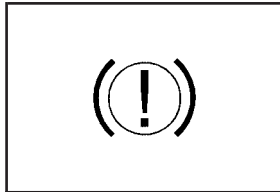

Canada

This light should come on briefly when you turn the ignition to ON/RUN. If it does not come on then, have it fixed so it will be ready to warn you if there is a problem.

When the ignition is on, the brake system warning light will also come on when you set your parking brake. The light will stay on if your parking brake does not release fully. If it stays on after your parking brake is fully released, it means you have a brake problem.

If the light comes on while you are driving, pull off the road and stop carefully. You may notice that the pedal is harder to push, or the pedal may go closer to the floor. It may take longer to stop. If the light is still on, have the vehicle towed for service. See *Towing Your Vehicle* on page 4-27.

CAUTION:

Your brake system may not be working properly if the brake system warning light is on. Driving with the brake system warning light on can lead to an accident. If the light is still on after you have pulled off the road and stopped carefully, have the vehicle towed for service.

Antilock Brake System Warning Light

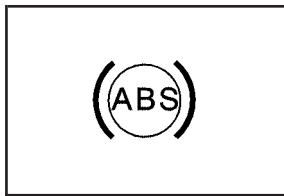

For vehicles with the Antilock Brake System (ABS), this light comes on briefly when the engine is started.

That is normal. If the light does not come on then, have it fixed so it will be ready to warn you if there is a problem.

If the ABS light stays on, turn the ignition off, if the light comes on when you are driving, stop as soon as it is safely possible and turn the ignition off. Then start the engine again to reset the system. If the ABS light still stays on, or comes on again while you are driving, your vehicle needs service. If the regular brake system warning light is not on, your vehicle still has brakes, but not antilock brakes. If the regular brake system warning light is also on, your vehicle does not have antilock brakes and there is a problem with the regular brakes. See *Brake System Warning Light* on page 3-37.

For vehicles with a Driver Information Center (DIC), see *DIC Warnings and Messages* on page 3-54 for all brake related DIC messages.

Traction Control System (TCS)/ StabiliTrak[®] Warning Light



The Traction Control System/StabiliTrak[®] warning light should come on briefly when the engine is started.

If the warning light does not come on then, have it fixed so it will be ready to warn you if there is a problem. If it stays on, or comes on when you are driving, there may be a problem with your Traction Control System (TCS)/StabiliTrak[®] and your vehicle may need service. When this warning light is on, the system will not limit wheel spin. Adjust your driving accordingly.

If the traction control system warning light comes on and stays on for an extended period of time when the system is turned on, your vehicle needs service. See *Traction Control System (TCS)* on page 4-6 and *StabiliTrak[®] System* on page 4-8 for more information.

Engine Coolant Temperature Warning Light

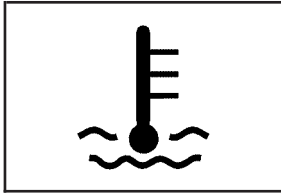

This light will come on when you first start the vehicle as a check to let you know that the light is working.

It will go out after a few seconds. If the light does not come on, see your dealer/retailer.

If the light does not go out or if the light comes on and stays on while you are driving, your vehicle may have a problem with the cooling system. You should stop the vehicle and turn off the engine as soon as possible to avoid damage to the engine. A warning chime will also sound when this light is on.

See *Engine Overheating* on page 5-30 for more information.

Engine Coolant Temperature Gage

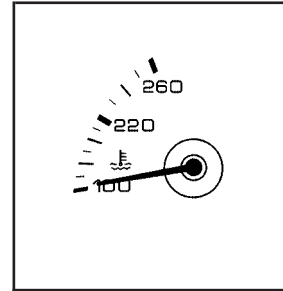

United States

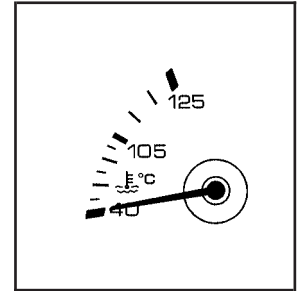

Canada

This gage shows the engine coolant temperature. If the engine coolant overheats the engine coolant temperature warning light will come on. See *Engine Overheating* on page 5-30 and *Engine Coolant Temperature Warning Light* on page 3-39 for more information.

Tire Pressure Light

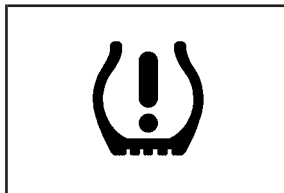

Your vehicle has a tire pressure light.

This light comes on briefly when the engine is started and provides information about tire pressures and the Tire Pressure Monitoring System.

When the Light is Solid

This indicates that one or more of your tires are significantly underinflated.

A tire pressure message in the Driver Information Center (DIC), may accompany the light. See *DIC Warnings and Messages on page 3-54* for more information. Stop and check your tires as soon as it is safe to do so. If underinflated, inflate to the proper pressure. See *Tires on page 5-59* for more information.

When the Light Flashes First and Then is Solid

This indicates that there may be a problem with the Tire Pressure Monitor System. The light flashes for about a minute and stays on solid for the remainder of the ignition cycle. This sequence will repeat with every ignition cycle. See *Tire Pressure Monitor System on page 5-70* for more information.

Malfunction Indicator Lamp

Check Engine Light

A computer system called OBD II (On-Board Diagnostics-Second Generation) monitors operation of the fuel, ignition, and emission control systems. It makes sure that emissions are at acceptable levels for the life of the vehicle, helping to produce a cleaner environment.

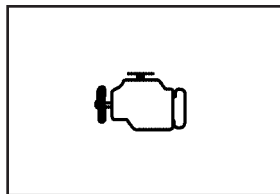

The check engine light comes on to indicate that there is an OBD II problem and service is required.

Malfunctions often are indicated by the system before any problem is apparent. This can prevent more serious damage to your vehicle. This system is also designed to assist your service technician in correctly diagnosing any malfunction.

Notice: If you keep driving your vehicle with this light on, after a while, the emission controls might not work as well, your vehicle's fuel economy might not be as good, and the engine might not run as smoothly. This could lead to costly repairs that might not be covered by your warranty.

Notice: Modifications made to the engine, transmission, exhaust, intake, or fuel system of your vehicle or the replacement of the original tires with other than those of the same Tire Performance Criteria (TPC) can affect your vehicle's emission controls and can cause this light to come on. Modifications to these systems could lead to costly repairs not covered by your warranty. This could also result in a failure to pass a required Emission Inspection/Maintenance test. See *Accessories and Modifications on page 5-3*.

This light comes on, as a check to show it is working, when the ignition is turned ON/RUN but the engine is not running. If the light does not come on, have it repaired. This light also comes on during a malfunction in one of two ways:

- **Light Flashing** — A misfire condition has been detected. A misfire increases vehicle emissions and could damage the emission control system on your vehicle. Diagnosis and service might be required.
- **Light On Steady** — An emission control system malfunction has been detected on your vehicle. Diagnosis and service might be required.

If the Light is Flashing

The following can prevent more serious damage to your vehicle:

- Reduce vehicle speed.
- Avoid hard accelerations.
- Avoid steep uphill grades.
- If you are towing a trailer, reduce the amount of cargo being hauled as soon as it is possible.

If the light stops flashing and remains on steady, see “If the Light Is On Steady” following.

If the light continues to flash, when it is safe to do so, stop the vehicle. Find a safe place to park the vehicle. Turn the ignition off, wait at least 10 seconds, and restart the engine. If the light remains on steady, see “If the Light Is On Steady” following. If the light is still flashing, follow the previous steps and see your dealer/retailer for service as soon as possible.

If the Light Is On Steady

You might be able to correct the emission system malfunction by considering the following:

Did you recently put fuel into your vehicle?

If so, reinstall the fuel cap, making sure to fully install the cap. See *Filling the Tank on page 5-8*. The diagnostic system can determine if the fuel cap has

been left off or improperly installed. A loose or missing fuel cap allows fuel to evaporate into the atmosphere. A few driving trips with the cap properly installed should turn the light off.

Did you just drive through a deep puddle of water?

If so, your vehicle’s electrical system might be wet. The condition is usually corrected when the electrical system dries out. A few driving trips should turn the light off.

Have you recently changed brands of fuel?

If so, be sure to fuel your vehicle with quality fuel. See *Gasoline Octane on page 5-5*. Poor fuel quality causes the engine not to run as efficiently as designed. You might notice this as stalling after start-up, stalling when you put the vehicle into gear, misfiring, hesitation on acceleration, or stumbling on acceleration — these conditions might go away once the engine is warmed up. This will be detected by the system and cause the light to turn on.

If you experience one or more of these conditions, change the fuel brand you use. It will require at least one full tank of the proper fuel to turn the light off.

If none of the above steps have made the light turn off, your dealer/retailer can check the vehicle. Your dealer/retailer has the proper test equipment and diagnostic tools to fix any mechanical or electrical problems that might have developed.

Emissions Inspection and Maintenance Programs

Some state/provincial and local governments have or might begin programs to inspect the emission control equipment on your vehicle. Failure to pass this inspection could prevent you from getting a vehicle registration.

Here are some things you need to know to help your vehicle pass an inspection:

Your vehicle will not pass this inspection if the check engine light is on or not working properly.

Your vehicle will not pass this inspection if the OBD (on-board diagnostic) system determines that critical emission control systems have not been completely diagnosed by the system. The vehicle would be considered not ready for inspection. This can happen if you have recently replaced the battery or if the battery has run down. The diagnostic system is designed to evaluate critical emission control systems during normal driving. This can take several days of routine driving. If you have done this and your vehicle still does not pass the inspection for lack of OBD system readiness, your dealer/retailer can prepare the vehicle for inspection.

Oil Pressure Light

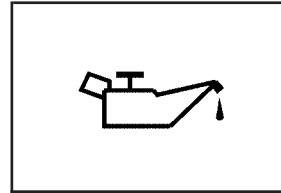

Your vehicle may have this feature.

If the vehicle has an oil problem, this light may stay on after the engine is started, or come on while you are driving.

This light indicates that oil is not going through the engine quickly enough to keep it lubricated. The engine could be low on oil or could have some other oil problem. Have it fixed right away.

The oil light could also come on in the following situations:

- The light will come on briefly when the ignition is turned on to show that it is working properly. If it does not come on with the ignition on, there may be a problem with the fuse or bulb. Have it fixed right away.
- Sometimes when the engine is idling at a stop, a chime will sound and the light may blink on and off. This is normal.

⚠ CAUTION:

Do not keep driving if the oil pressure is low. If you do, your engine can become so hot that it catches fire. You or others could be burned. Check your oil as soon as possible and have your vehicle serviced.

Notice: Lack of proper engine oil maintenance may damage the engine. The repairs would not be covered by your warranty. Always follow the maintenance schedule in this manual for changing engine oil.

Engine Oil Pressure Gage

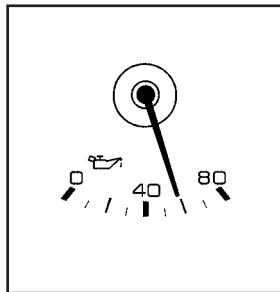

United States

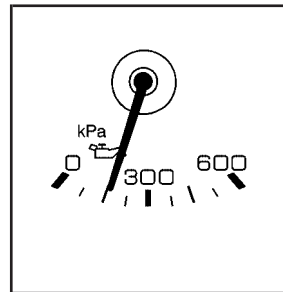

Canada

Your vehicle may have an engine oil pressure gage. It shows the engine oil pressure in psi (pounds per square inch) when the engine is running. Canadian vehicles indicate pressure in kPa (kilopascals).

Oil pressure may vary with engine speed, outside temperature and oil viscosity, but if readings are outside the normal operating range, the oil pressure light will come on. See *Oil Pressure Light* on page 3-43 for more information.

A reading outside the normal operating range may be caused by a dangerously low oil level or some other problem causing low oil pressure. Check your oil as soon as possible. See Oil pressure Low Stop Engine under *DIC Warnings and Messages on page 3-54* and *Engine Oil on page 5-16*.

⚠ CAUTION:

Do not keep driving if the oil pressure is low. If you do, your engine can become so hot that it catches fire. You or others could be burned. Check your oil as soon as possible and have your vehicle serviced.

Notice: Lack of proper engine oil maintenance may damage the engine. The repairs would not be covered by your warranty. Always follow the maintenance schedule in this manual for changing engine oil.

Security Light



For information regarding this light and the vehicle's security system, see *Theft-Deterrent System on page 2-27*.

Fog Lamp Light

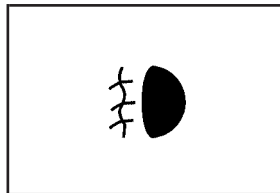

The fog lamp light will come on when the fog lamps are in use.

The light will go out when the fog lamps are turned off. See *Fog Lamps on page 3-18* for more information.

Lights On Reminder

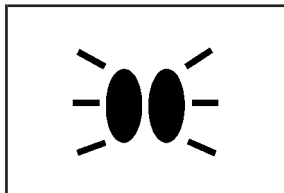

This light comes on whenever the parking lamps are on.

See *Headlamps on Reminder on page 3-17* for more information.

Cruise Control Light

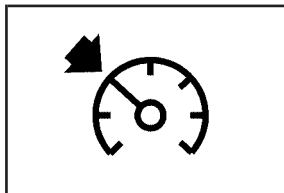

This light comes on whenever you set the cruise control.

The light goes out when the cruise control is turned off.
See *Cruise Control on page 3-13* for more information.

Highbeam On Light

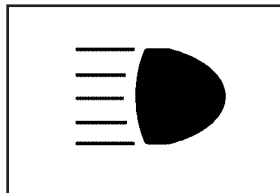

This light comes on when the high-beam headlamps are in use.

See *Headlamp High/Low-Beam Changer on page 3-8* for more information.

Fuel Gage

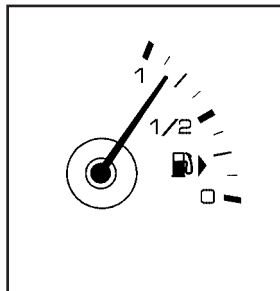

The fuel gage shows approximately how much fuel is in the fuel tank. It works only when the ignition is in the ON/RUN position.

If the fuel supply gets low, the Fuel Level Low message will appear on the Driver Information Center (DIC) and a single chime will sound. See *DIC Warnings and Messages on page 3-54* for more information.

Here are a few concerns some owners have had about the fuel gage. All of these situations are normal and do not indicate that anything is wrong with the fuel gage:

- At the gas station the gas pump shuts off before the gage reads full.
- The gage may change when you turn, stop quickly or accelerate quickly.
- It takes a little more or less fuel to fill the tank than the gage indicated. For example, the gage may have indicated that the tank was half full, but it actually took a little more or less than half the tank's capacity to fill the tank.

Driver Information Center (DIC)

The Driver Information Center (DIC) gives you the status of many of your vehicle's systems. The DIC is also used to display warning/status messages. All messages appear in the DIC display located at the bottom of the instrument panel cluster. The DIC buttons are located on the instrument panel, next to the steering wheel.

The DIC comes on when the ignition is on. After a short delay, the DIC displays the information that was last displayed before the engine was turned off.

The top line of the DIC display shows the DIC information. The bottom line of the DIC display shows the compass. The compass displays in the trip/fuel menus and in some vehicle information menus.

If a problem is detected, a warning message appears on the display. Take any message that appears on the display seriously and remember that clearing the message only makes the message disappear, and does not correct the problem.

DIC Operation and Displays

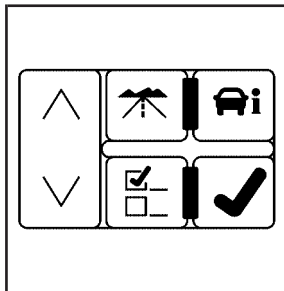

The Driver Information Center (DIC) has different displays which can be accessed by pressing the DIC buttons located on the instrument panel, next to the steering wheel.

 **Trip/Fuel:** Press this button to scroll through the trip and fuel displays. See “Trip/Fuel Display Menu Items” following for more information on these displays.

 **Vehicle Information:** Press this button to scroll through the vehicle information displays. See “Vehicle Information Display Menu Items” following for more information on these displays.

 **Customization:** Press this button to scroll through each of the customization features. See *DIC Vehicle Customization on page 3-68* for more information on the customization features.

✓ **Set/Reset:** Press this button to reset certain DIC features and to acknowledge DIC warning messages and clear them from the DIC display.

^ v **Menu Up/Down:** Press this button to scroll up and down the menu items.

Trip/Fuel Display Menu Items

 **(Trip/Fuel):** The following display menu items can be displayed by pressing the trip/fuel button:

Odometer

This display shows the distance the vehicle has been driven in either miles (mi) or kilometers (km).

Trip A or Trip B

These displays show the current distance traveled since the last reset for each trip odometer in either miles (mi) or kilometers (km). Both odometers can be used at the same time. Each trip odometer can be reset to zero separately by pressing and holding the set/reset button for a few seconds while the desired trip odometer is displayed.

Fuel Range

This display shows the approximate number of remaining miles (mi) or kilometers (km) you can drive without refilling the fuel tank. This estimate is based on the current driving conditions and changes if the driving conditions change. For example, if you are driving in traffic and making frequent stops, the display may read one number, but if you enter the freeway, the number may change even though you still have the same amount of fuel in the fuel tank. This is because different driving conditions produce different fuel economies. Generally, freeway driving produces better fuel economy than city driving.

Once the range drops below about 30 miles (48 km) remaining, the display shows Low Range.

If your vehicle is low on fuel, the Fuel Level Low message displays. See “Fuel Level Low” under *DIC Warnings and Messages on page 3-54* for more information.

AVG (Average) Economy

This display shows the approximate average miles per gallon (mpg) or liters per 100 kilometers (L/100 km). This number is calculated based on the number of mpg (L/100 km) recorded since the last time this display was reset. To reset this display to zero, press the set/reset button.

Timer

This display can be used like a stopwatch. You can record the time it takes to travel from one point to another. To access the timer, press the trip/fuel button until Timer 00:00:00 displays.

To turn on the timer, press the set/reset button until the timer starts.

To turn off the timer, press the set/reset button again. The timer stops and displays the end timing value.

To reset the timer to zero, press and hold the set/reset button after the timer has been stopped.

Inst (Instantaneous) Economy

This display shows the current fuel economy in either miles per gallon (mpg) or liters per 100 kilometers (L/100 km). This number reflects only the fuel economy that the vehicle has right now and changes frequently as driving conditions change. Unlike average economy, this display cannot be reset.

AVG (Average) Speed

This display shows the average speed of the vehicle in either miles per hour (mph) or kilometers per hour (km/h). This average is calculated based on the various vehicle speeds recorded since the last reset of this display. To reset this display to zero, press the set/reset button.

Speedometer

This display shows a digital speedometer in the DIC. The speed displays in either miles per hour (mph) or kilometers per hour (km/h). To change the units from English to metric, see “Units” later in this section.

Blank Display

This display shows no information.

Vehicle Information Display Menu Items

 **(Vehicle Information):** The following display menu items can be displayed by pressing the vehicle information button:

Oil Life Remaining

If the vehicle has this display, it shows the estimated oil life remaining. If you see 99% Oil Life Remaining on the display, that means that 99% of the current oil life remains.

When the oil life is depleted, the Change Engine Oil Soon message appears on the display. You should change the oil as soon as possible. In addition to the engine oil life system monitoring the oil life, additional maintenance is recommended in the Maintenance Schedule in this manual. See *Scheduled Maintenance on page 6-4* and *Engine Oil on page 5-16*.

Remember, you must reset the Oil Life yourself after each oil change. It does not reset itself. Also, be careful not to reset the Oil Life accidentally at any time other than when the oil has just been changed. It cannot be reset accurately until the next oil change. To reset the engine oil life system, See *Engine Oil Life System on page 5-19*. The display shows 100% when the system is reset.

Units

This display allows you to select between English or Metric units of measurement. Once in this display, press the set/reset button to select between English or Metric units.

Parking Assist

If your vehicle has the Ultrasonic Rear Parking Assist (URPA) system, this display allows the system to be turned on or off. Once in this display, press the set/reset button to select between On or Off. If you choose On, the system turns on. If you choose Off, the system turns off. The URPA system automatically turns back on after each vehicle start. When the URPA system is turned off and the vehicle is shifted out of PARK (P), the DIC displays the Parking Assist Off message as a reminder that the system has been turned off. See *DIC Warnings and Messages on page 3-54* and *Ultrasonic Rear Parking Assist (URPA) on page 2-51* for more information.

Tire Pressure

The pressure for each tire can be viewed in the DIC. The tire pressure is shown in either pounds per square inch (psi) or kilopascals (kPa). Press the vehicle information button until the DIC displays Front Tire PSI (kPa) Left ## Right ##. Press the vehicle information button again until the DIC displays Rear Tire PSI (kPa) Left ## Right ##

If a low or high tire pressure condition is detected by the system while driving, a message advising you to check the pressure in a specific tire appears in the display. See *Inflation - Tire Pressure on page 5-67* and *DIC Warnings and Messages on page 3-54* for more information.

Battery Voltage

This display shows the current battery voltage. Your vehicle's charging system regulates voltage based on the state of the battery. The battery voltage may fluctuate when viewing this information on the DIC. This is normal.

If there is a problem with the battery charging system, the charging system light illuminates and/or the DIC displays a message. See *Charging System Light on page 3-36*, *DIC Warnings and Messages on page 3-54* and *Electric Power Management on page 3-20* for more information.

Calibrate Compass

Your vehicle may have this feature. The compass can be manually calibrated. To calibrate the compass through the DIC, see *DIC Compass on page 3-52*.

Change Compass Zone

Your vehicle may have this feature. To change the compass zone through the DIC, see *DIC Compass on page 3-52*.

Relearn Remote Key

If your vehicle has the Remote Keyless Entry (RKE) system, this display allows you to match the transmitter to your vehicle. If your vehicle has the keyless access system, see *Keyless Access System Operation on page 2-9* for instructions on matching a keyless access transmitter to your vehicle. To match an RKE transmitter to your vehicle:

1. Press the vehicle information button until Press ✓ To Relearn Remote Key displays.
2. Press the set/reset button until Remote Key Learning Active is displayed.

3. Press and hold the lock and unlock buttons on the first transmitter at the same time for about 15 seconds.

On vehicles with memory recall seats, the first transmitter learned will match driver 1 and the second will match driver 2.

A chime sounds indicating that the transmitter is matched.

4. To match additional transmitters at this time, repeat Step 3.

Each vehicle can have a maximum of eight transmitters matched to it.

5. To exit the programming mode, you must cycle the key to LOCK/OFF.

Blank Display

This display shows no information.

DIC Compass

Your vehicle may have a compass in the Driver Information Center (DIC).

Compass Zone

The zone is set to zone eight upon leaving the factory. Your dealer/retailer will set the correct zone for your location.

Under certain circumstances, such as during a long distance cross-country trip or moving to a new state or province, it will be necessary to compensate for compass variance by resetting the zone through the DIC if the zone is not set correctly.

Compass variance is the difference between the earth's magnetic north and true geographic north. If the compass is not set to the zone where you live, the compass may give false readings. The compass must be set to the variance zone in which the vehicle is traveling.

To adjust for compass variance, use the following procedure:

Compass Variance (Zone) Procedure

1. Do not set the compass zone when the vehicle is moving. On an automatic transmission vehicle, only set it when the vehicle is in PARK (P). On a manual transmission vehicle, only set it when the vehicle is stopped.

Press the vehicle information button until Press 
To Change Compass Zone displays.

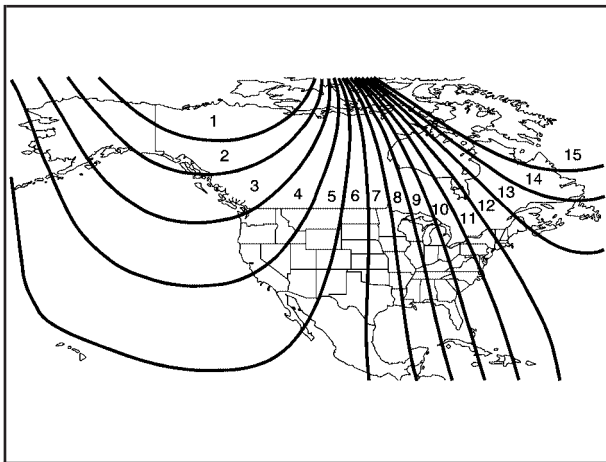

2. Find the vehicle's current location and variance zone number on the map.
Zones 1 through 15 are available.
3. Press the set/reset button to scroll through and select the appropriate variance zone.
4. Press the trip/fuel button until the vehicle heading, for example, N for North, is displayed in the DIC.
5. Calibrate the compass. See "Compass Calibration Procedure" following.

Compass Calibration

The compass can be manually calibrated. Only calibrate the compass in a magnetically clean and safe location, such as an open parking lot, where driving the vehicle in circles is not a danger. It is suggested to calibrate away from tall buildings, utility wires, manhole covers, or other industrial structures, if possible.

If CAL should ever appear in the DIC display, the compass should be calibrated.

If the DIC display does not show a heading, for example, N for North, or the heading does not change after making turns, there may be a strong magnetic field interfering with the compass. Such interference may be caused by a magnetic CB or cell phone antenna mount, a magnetic emergency light, magnetic note pad holder, or any other magnetic item. Turn off the vehicle, move the magnetic item, then turn on the vehicle and calibrate the compass.

To calibrate the compass, use the following procedure:

Compass Calibration Procedure

1. Before calibrating the compass, make sure the compass zone is set to the variance zone in which the vehicle is located. See “Compass Variance (Zone) Procedure” earlier in this section.

Do not operate any switches such as window, sunroof, climate controls, seats, etc. during the calibration procedure.

2. Press the vehicle information button until Press ✓ To Calibrate Compass displays.
3. Press the set/reset button to start the compass calibration.
4. The DIC will display Calibrating Drive In Circles. Drive the vehicle in tight circles at less than 5 mph (8 km/h) to complete the calibration. The DIC will display Calibration Complete for a few seconds when the calibration is complete. The DIC display will then return to Press ✓ To Calibrate Compass.

DIC Warnings and Messages

Messages are displayed on the DIC to notify the driver that the status of the vehicle has changed and that some action may be needed by the driver to correct the condition. Multiple messages may appear one after another.

Some messages may not require immediate action, but you can press any of the DIC buttons on the instrument panel to acknowledge that you received the messages and to clear them from the display.

Some messages cannot be cleared from the DIC display because they are more urgent. These messages require action before they can be cleared. You should take any messages that appear on the display seriously and remember that clearing the messages will only make the messages disappear, not correct the problem.

The following are the possible messages that can be displayed and some information about them.

Accessory Mode Active

If your vehicle has the keyless access system, this message displays when the accessory mode is active. See *Ignition Positions (Key Access)* on page 2-31 or *Ignition Positions (Keyless Access)* on page 2-33 for more information.

AFL (Adaptive Forward Lighting) Lamps Need Service

This message displays when the Adaptive Forward Lighting (AFL) system is disabled and needs service. See your dealer/retailer. See *Adaptive Forward Lighting System on page 3-18* for more information.

All Wheel Drive Off

If your vehicle has the All-Wheel Drive (AWD) system, this message displays when there is a temporary condition making the AWD system unavailable. Your vehicle will run in 2WD. This could be caused by:

- Loss of wheel or vehicle speed
- AWD system overheat
- Certain vehicle electrical conditions

This message turns off when the above conditions are no longer present and by resetting the warning message.

To reset the warning message, turn the ignition off and then back on again after 30 seconds. If the message stays on, see your dealer/retailer right away. See *All-Wheel Drive (AWD) System on page 4-9* for more information.

Automatic Light Control Off

This message displays when the automatic headlamps are turned off.

Automatic Light Control On

This message displays when the automatic headlamps are turned on.

Battery Saver Active

This message displays when the system detects that the battery voltage is dropping below expected levels. The battery saver system starts reducing certain features of the vehicle that you may be able to notice. At the point that the features are disabled, this message is displayed. It means that the vehicle is trying to save the charge in the battery.

Turn off all unnecessary accessories to allow the battery to recharge.

The normal battery voltage range is 11.5 to 15.5 volts. You can monitor battery voltage on the DIC by pressing the vehicle information button until Battery Voltage is displayed.

Battery Volts Low

This message displays when the electrical system is charging less than 10 volts or the battery has been drained.

If this message appears immediately after starting the engine, it is possible that the generator can still recharge the battery. The battery should recharge while driving, but may take a few hours to do so. Consider using an auxiliary charger to boost the battery after returning home or to a final destination. Make sure you follow the manufacturer's instructions.

If this message appears while driving or after starting your vehicle and stays on, have it checked immediately to determine the cause of this problem.

To help the generator recharge the battery quickly, you can reduce the load on the electrical system by turning off the accessories.

The normal battery voltage range is 11.5 to 15.5 volts. You can monitor battery voltage on the DIC by pressing the vehicle information button until Battery Voltage is displayed.

Calibrating Drive In Circles

This message displays when calibrating the compass. Drive the vehicle in circles at less than 5 mph (8 km/h) to complete the calibration. See *DIC Compass on page 3-52* for more information.

Calibration Complete

This message displays when the compass calibration is complete. See *DIC Compass on page 3-52* for more information.

Change Engine Oil Soon

When this message displays, it means that service is required for your vehicle. See your dealer/retailer. See *Engine Oil on page 5-16* and *Scheduled Maintenance on page 6-4* for more information.

When you reset the Change Engine Oil Soon message by clearing it from the display, you still must reset the engine oil life system separately. For more information on resetting the engine oil life system, see *Engine Oil Life System on page 5-19*.

Check Tire Pressure

This message displays when the pressure in one or more of the vehicle's tires needs to be checked. This message also displays Left Front, Right Front, Left Rear, or Right Rear to indicate which tire needs to be checked. You can receive more than one tire pressure message at a time. To read the other messages that may have been sent at the same time, press the set/reset button. If a tire pressure message appears on the DIC, stop as soon as you can. Have the tire pressures checked and set to those shown on the Tire Loading Information label. See *Tires on page 5-59, Loading Your Vehicle on page 4-22, and Inflation - Tire Pressure on page 5-67*. The DIC display also shows the tire pressure values. See *DIC Operation and Displays on page 3-48*. If the tire pressure is low, the low tire pressure warning light comes on. See *Tire Pressure Light on page 3-40*.

Cruise Set To XXX MPH (km/h)

This message displays whenever the cruise control is set. See *Cruise Control on page 3-13* for more information.

Driver Door Open

This message displays when the driver door is not closed completely. Make sure that the door is closed completely.

Electronic Key Already Known

If your vehicle has the keyless access system, this message displays if you try to match a transmitter that has already been learned. See *Keyless Access System Operation on page 2-9* for more information.

Electronic Key Not Detected

If your vehicle has the keyless access system, this message displays if the vehicle does not detect the presence of a transmitter when you have attempted to start the vehicle or a vehicle door has just closed.

The following conditions may cause this message to appear:

- Driver-added equipment plugged into the accessory power outlet on the center console is causing interference. Examples of these devices are cell phones and cell phone chargers, two-way radios, power inverters, or similar items. Try moving the keyless access transmitter away from these devices when starting the vehicle. In addition, PDA devices and remote garage and gate openers may also generate Electromagnetic Interference (EMI) that may interfere with the keyless access transmitter. Do not carry the keyless access transmitter in the same pocket or bag as these devices.

- The vehicle is experiencing Electromagnetic Interference (EMI). Some locations, such as airports, automatic toll booths, and some gas stations have EMI fields which may interfere with the keyless access transmitter.

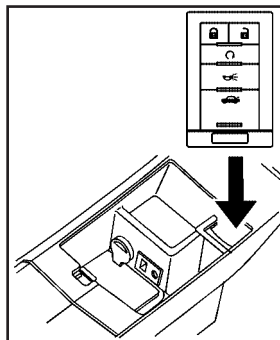

If moving the transmitter to different locations within the vehicle does not help, place the transmitter in the center console transmitter pocket with the buttons facing to the right and then press the START button.

- The vehicle's battery voltage is low. The battery voltage must be above 10 volts for the keyless access transmitter to be detected properly.

Electronic Key Not Detected Restart Allowed

If your vehicle has the keyless access system, this message displays when the keyless access transmitter is not detected inside the vehicle while you are trying to turn the ignition off. Your vehicle may be near a strong radio antenna signal causing the keyless access system to be jammed. The vehicle will remain in ACC/ACCESSORY until the vehicle is turned off or is started, or five minutes has expired. If you turn the ignition off and you cannot find the keyless access transmitter, you will not be able to restart the vehicle. The keyless access transmitter needs to be inside of the vehicle in order for the vehicle to start. See *Starting the Engine* on page 2-34 for more information.

Engine Hot A/C (Air Conditioning) Off

This message displays when the engine coolant becomes hotter than the normal operating temperature. See *Engine Coolant Temperature Gage* on page 3-39. To avoid added strain on a hot engine, the air conditioning compressor automatically turns off. When the coolant temperature returns to normal, the air conditioning compressor turns back on. You can continue to drive your vehicle.

If this message continues to appear, have the system repaired by your dealer/retailer as soon as possible to avoid damage to the engine.

Engine Oil Low Add Oil

If your vehicle has an oil level sensor, this message displays if the oil level in the vehicle is low. Check the oil level and correct it as necessary. You may need to let the vehicle cool or warm up and cycle the ignition to be sure this message clears.

This message clears itself after 10 seconds, until the next ignition cycle. See *Engine Oil* on page 5-16 for additional information.

Engine Overheated Idle Engine

Notice: If you drive your vehicle while the engine is overheating, severe engine damage may occur. If an overheat warning appears on the instrument panel cluster and/or DIC, stop the vehicle as soon as possible. Do not increase the engine speed above normal idling speed. See *Engine Overheating* on page 5-30 for more information.

This message displays when the engine coolant temperature is too hot. Stop and allow the vehicle to idle until it cools down. See *Engine Coolant Temperature Warning Light* on page 3-39.

See *Overheated Engine Protection Operating Mode* on page 5-32 for information on driving to a safe place in an emergency.

Engine Power Is Reduced

This message displays when the engine power is being reduced to protect the engine from damage. There could be several malfunctions that might cause this message. Reduced engine power can affect the vehicle's ability to accelerate. If this message is on, but there is no reduction in performance, proceed to your destination. The performance may be reduced the next time the vehicle is driven. The vehicle may be driven at a reduced speed while this message is on, but acceleration and speed may be reduced. Anytime this message stays on, the vehicle should be taken to your dealer/retailer for service as soon as possible.

Fuel Level Low

This message displays when your vehicle is low on fuel. Refill the fuel tank as soon as possible. A chime may sound when this message displays. See *Filling the Tank on page 5-8*.

Heated Washer Fluid Wash (Washer) Wipes Pending

If your vehicle has this feature, this message displays when you turn on the heated windshield washer fluid system. See "Heated Windshield Washer" under *Windshield Washer on page 3-11* for more information.

Heated Washer Fluid System Off

If your vehicle has this feature, this message displays when you manually turn off the heated windshield washer fluid system or when the system automatically turns off. See "Heated Windshield Washer" under *Windshield Washer on page 3-11* for more information. This message clears itself after 10 seconds.

Hood Open

This message displays when the hood is not closed completely. Make sure that the hood is closed completely.

Ice Possible Drive With Care

This message displays when the outside temperature is cold enough to create icy road conditions. Adjust your driving accordingly.

Learn Delay Active Wait XX Min (Minutes)

If your vehicle has the keyless access system, this message displays when matching new transmitters to the vehicle. See *Keyless Access System Operation on page 2-9* for more information.

Left Rear Door Open

This message displays when the driver side rear door is not closed completely. Make sure that the door is closed completely.

Maximum # Electronic Keys Learned

If your vehicle has the keyless access system, this message displays when the maximum number of transmitters have been learned. See *Keyless Access System Operation on page 2-9* for more information.

Oil Pressure Low Stop Engine

Notice: If you drive your vehicle while the engine oil pressure is low, severe engine damage may occur. If a low oil pressure warning appears on the instrument panel cluster and/or DIC, stop the vehicle as soon as possible. Do not drive the vehicle until the cause of the low oil pressure is corrected. See *Engine Oil on page 5-16* for more information.

This message displays when the vehicle's engine oil pressure is low. The oil pressure light may also appear on the instrument panel cluster. See *Oil Pressure Light on page 3-43*. See *Engine Oil on page 5-16* for more information.

Stop the vehicle immediately, as engine damage can result from driving a vehicle with low oil pressure. Have the vehicle serviced by your dealer/retailer as soon as possible when this message is displayed.

Parking Assist Off

If your vehicle has the Ultrasonic Rear Parking Assist (URPA) system, after the vehicle has been started, this message displays to remind the driver that the URPA system has been turned off. Press the set/reset button to acknowledge this message and clear it from the DIC display. To turn the URPA system back on, see "Parking Assist" under *DIC Operation and Displays on page 3-48*. See *Ultrasonic Rear Parking Assist (URPA) on page 2-51* for more information.

Passenger Door Open

This message displays when the passenger side front door is not closed completely. Make sure that the door is closed completely.

Press Brake To Start Engine (Automatic Transmission Only)

If your vehicle has the keyless access system, this message displays if you try to start the engine without having the brake pressed. The brake needs to be pressed when starting the engine. See *Ignition Positions (Key Access) on page 2-31* or *Ignition Positions (Keyless Access) on page 2-33* for more information.

Press Start Control To Learn Keys

If your vehicle has the keyless access system, this message displays when matching new transmitters to the vehicle. See *Keyless Access System Operation on page 2-9* for more information.

Rainsense™ Wipers Active

If your vehicle has this feature, this message displays while the Rainsense™ wipers are active. See *Rainsense™ Wipers on page 3-10* for more information.

Ready To Learn Electronic Key # X

If your vehicle has the keyless access system, this message displays while matching new transmitters to the vehicle. See *Keyless Access System Operation on page 2-9* for more information.

Remote Key Learning Active

If your vehicle has the Remote Keyless Entry (RKE) system, this message displays while matching new transmitters to the vehicle. See “Matching Transmitter(s) to Your Vehicle” under *Remote Keyless Entry (RKE) System Operation on page 2-7* and *DIC Operation and Displays on page 3-48* for more information.

Replace Battery In Remote Key

This message displays when the battery in the Remote Keyless Entry (RKE) or keyless access transmitter needs to be replaced. To replace the battery, see “Battery Replacement” under *Remote Keyless Entry (RKE) System Operation on page 2-7* or *Keyless Access System Operation on page 2-9*.

Right Rear Door Open

This message displays when the passenger side rear door is not closed completely. Make sure that the door is closed completely.

Rotate Control To Off Position

If your vehicle has the keyless access system, this message displays when the ignition is in ACC/ACCESSORY and the shift lever has just been moved to PARK (P). The message displays as a reminder to turn the ignition off. To avoid draining the battery, make sure the ignition is turned off before leaving the vehicle.

Service Air Bag

This message displays when there is a problem with the airbag system. Have your vehicle serviced by your dealer/retailer immediately. See *Airbag Readiness Light on page 3-33* for more information.

Service A/C System

This message displays when the electronic sensors that control the air conditioning and heating systems are no longer working. Have the climate control system serviced by your dealer/retailer if you notice a drop in heating and air conditioning efficiency.

Service All Wheel Drive

This message displays if a problem occurs with the All-Wheel Drive (AWD) system. Your vehicle will run in 2WD. This could be caused by:

- An electronics problem
- An AWD system oil overheat
- Worn out or overheated clutch plates
- Various electrical issues

If this message appears, stop as soon as possible and turn off the ignition for 30 seconds. Restart the vehicle and check for the message on the DIC display. If the message is still displayed or appears again when you begin driving, the system needs service. See your dealer/retailer right away.

Service Battery Charging System

This message displays when there is a problem with the generator and battery charging systems. Driving with this problem could drain the battery. Turn off all unnecessary accessories. Stop and turn off the vehicle as soon as it is safe to do so. Have the electrical system checked by your dealer/retailer. Under certain conditions, the charging system light may also turn on in the instrument panel cluster. See *Charging System Light on page 3-36* for more information.

Service Brake Assist

This message displays if there is a problem with the brake system. The brake system warning light and the antilock brake system (ABS) warning light may also display on the instrument panel cluster. See *Brake System Warning Light on page 3-37* and *Antilock Brake System Warning Light on page 3-38* for more information. If this happens, stop as soon as possible and turn off the vehicle. Restart the vehicle and check for the message on the DIC display. If the message displays or appears again when you begin driving, the brake system needs service. See your dealer/retailer as soon as possible. See *Brakes on page 5-40* for more information.

Service Brake System

This message displays, while the ignition is on, when the brake fluid level is low. The brake system warning light on the instrument panel cluster also comes on. See *Brake System Warning Light on page 3-37* for more information. Have the brake system serviced by your dealer/retailer as soon as possible.

Service Keyless Start System

If your vehicle has the keyless access system, this message displays when there is a problem with this feature. See your dealer/retailer.

Service Parking Assist

If your vehicle has the Ultrasonic Rear Parking Assist (URPA) system, this message displays if there is a problem with the URPA system. Do not use this system to help you park. See *Ultrasonic Rear Parking Assist (URPA) on page 2-51* for more information. See your dealer/retailer for service.

Service Power Steering

Your vehicle may have a speed variable assist steering system. See *Steering on page 4-9*.

This message displays if a problem is detected with the speed variable assist steering system. When this message is displayed, you may notice that the effort required to steer the vehicle increases or feels heavier, but you will still be able to steer the vehicle.

Service StabiliTrak[®]

This message displays if there has been a problem detected with the StabiliTrak[®] system.

If this message comes on while you are driving, pull off the road as soon as possible and stop carefully. Try resetting the system by turning the ignition off then back on. If this message still stays on or comes back on again while you are driving, your vehicle needs service. Have the StabiliTrak[®] system inspected by your dealer/retailer as soon as possible. See *StabiliTrak[®] System on page 4-8* for more information.

Service Theft Deterrent System

This message displays when there is a problem with the theft-deterrent system programmed in the key. A fault has been detected in the system which means that the system is disabled and it is not protecting the vehicle. The vehicle usually restarts; however, you may want to take the vehicle to your dealer/retailer before turning off the engine. See *Immobilizer Operation (Key Access) on page 2-28* or *Immobilizer Operation (Keyless Access) on page 2-30* for more information.

Service Tire Monitor System

This message displays if a part on the Tire Pressure Monitor System (TPMS) is not working properly. The tire pressure light also flashes and then remains on during the same ignition cycle. See *Tire Pressure Light on page 3-40*. Several conditions may cause this message to appear. See *Tire Pressure Monitor Operation on page 5-71* for more information. If the warning comes on and stays on, there may be a problem with the TPMS. See your dealer/retailer.

Service Traction Control

This message displays when there is a problem with the Traction Control System (TCS). When this message displays, the system will not limit wheel spin. Adjust your driving accordingly. See your dealer/retailer for service. See *Traction Control System (TCS) on page 4-6* for more information.

Service Transmission

This message displays when there is a problem with the vehicle's transmission. Have your vehicle serviced by your dealer/retailer.

Service Vehicle Soon

This message displays when a non-emissions related malfunction occurs. Have your vehicle serviced by your dealer/retailer as soon as possible.

Shift To Park (Automatic Transmission Only)

If your vehicle has the keyless access system, this message displays if the vehicle is not in PARK (P) while the engine is being turned off. The vehicle will be in ACC/ACCESSORY. Once the shift lever is moved to PARK (P), the ignition needs to be turned off. If the ignition is not turned off, the vehicle will remain in ACC/ACCESSORY. To avoid draining the battery, make sure the ignition is turned off before leaving the vehicle.

Speed Limited To XXX MPH (km/h)

This message displays when your vehicle speed is limited to 80 mph (128 km/h) because the vehicle detects a problem in the speed variable assist steering, magnetic ride control, or automatic leveling control systems. Have your vehicle serviced by your dealer/retailer.

Sport Mode

This message displays when the vehicle is in sport mode. See "Driver Shift Control (DSC)" under *Automatic Transmission Operation on page 2-37* for more information.

StabiliTrak[®] Competitive Mode

This message displays when the Competitive Driving mode is selected. When in this mode, the Traction Control System (TCS) will not be operating and the TCS warning light will turn on. Adjust your driving accordingly. See “Competitive Driving Mode” under *Traction Control System (TCS)* on page 4-6 for more information.

StabiliTrak[®] Not Ready

This message may display after first driving the vehicle and exceeding 19 mph (30 km/h) for 30 seconds. The StabiliTrak[®] system is not functional until the message has turned off. See *StabiliTrak[®] System* on page 4-8 for more information.

StabiliTrak[®] Off

This message displays when you turn off StabiliTrak[®], or when the stability control has been automatically disabled. To limit wheel spin and realize the full benefits of the stability enhancement system, you should normally leave StabiliTrak[®] on. However, you should turn StabiliTrak[®] off if your vehicle gets stuck in sand, mud, ice, or snow and you want to rock your vehicle to attempt to free it, or if you are driving in extreme off-road conditions and require more wheel spin. See *If Your Vehicle is Stuck in Sand, Mud, Ice, or Snow* on page 4-21. To turn the StabiliTrak[®] system on or off, see *StabiliTrak[®] System* on page 4-8.

There are several conditions that can cause this message to appear.

- One condition is overheating, which could occur if StabiliTrak[®] activates continuously for an extended period of time.
- The message also displays if the brake system warning light is on. See *Brake System Warning Light* on page 3-37.
- The message could display if the stability system takes longer than usual to complete its diagnostic checks due to driving conditions.
- The message displays if an engine or vehicle related problem has been detected and the vehicle needs service. See your dealer/retailer.

The message turns off as soon as the conditions that caused the message to be displayed are no longer present.

Start Aborted By Theft Deterrent

This message displays if there is a communication problem between the keyless access system and the vehicle. The vehicle cannot be started when this message displays. See your dealer/retailer for service.

Theft Attempted

This message displays if the theft-deterrent system has detected a break-in attempt while you were away from your vehicle. See *Theft-Deterrent System on page 2-27* for more information.

Tighten Gas Cap

This message displays when the fuel cap has not been fully tightened. Recheck the fuel cap to ensure that it is on and tightened properly.

Tire Learning Active

This message displays when the Tire Pressure Monitor System (TPMS) is re-learning the tire positions on your vehicle. The tire positions must be re-learned after rotating the tires or after replacing a tire or sensor. See *Tire Inspection and Rotation on page 5-75*, *Tire Pressure Monitor System on page 5-70*, and *Inflation - Tire Pressure on page 5-67* for more information.

Transmission Hot Idle Engine

This message displays when the transmission fluid in your vehicle is too hot. Stop the vehicle and allow it to idle until the transmission cools down or until this message is removed.

Trunk Open

This message displays when the trunk is not closed completely. Make sure that the trunk is closed completely.

Turn Signal On

This message displays as a reminder to turn off the turn signal if you drive your vehicle for more than about 1 mile (1.6 km) with a turn signal on. A multiple chime sounds when this message displays.

Washer Fluid Low Add Fluid

This message displays when your vehicle is low on windshield washer fluid. Refill the windshield washer fluid reservoir as soon as possible. See *Windshield Washer Fluid on page 5-39* for more information.

DIC Vehicle Customization

Your vehicle has customization capabilities that allow you to program certain features to one preferred setting. Customization features can only be programmed to one setting on the vehicle and cannot be programmed to a preferred setting for two different drivers.

All of the customization options may not be available on your vehicle. Only the options available will be displayed on the DIC.

The default settings for the customization features were set when your vehicle left the factory, but may have been changed from their default state since then.

The customization preferences are automatically recalled.

To change customization preferences, use the following procedure.

Entering the Feature Settings Menu

1. Turn the ignition on.
To avoid excessive drain on the battery, it is recommended that the headlamps are turned off.
2. Press the customization button to enter the feature settings menu.

Feature Settings Menu Items

The following are customization features that allow you to program settings to the vehicle:

Display In English

This feature will only display if a language other than English has been set. This feature allows you to change the language in which the DIC messages appear back to English.

Press the customization button until the Press ✓ To Display In English screen appears on the DIC display. Press the set/reset button once to select English as the language in which all DIC messages will appear.

Display Language

This feature allows you to select the language in which the DIC messages will appear.

Press the customization button until the Display Language screen appears on the DIC display. Press the set/reset button once to access the settings for this feature. Then press the menu up/down button to scroll through the following settings:

English (default): All messages will appear in English.

Deutsch: All messages will appear in German.

Italiano: All messages will appear in Italian.

Francais: All messages will appear in French.

Espanol: All messages will appear in Spanish.

Portugese: All messages will appear in Portugese.

Arabic: All messages will appear in Arabic.

Chinese: All messages will appear in Chinese.

Japanese: All messages will appear in Japanese.

No Change: No change will be made to this feature. The current setting will remain.

To select a setting, press the set/reset button while the desired setting is displayed on the DIC.

Auto Door Lock

This feature allows you to select when the vehicle's doors will automatically lock. See *Programmable Automatic Door Locks on page 2-18* for more information.

Press the customization button until Auto Door Lock appears on the DIC display. Press the set/reset button once to access the settings for this feature. Then press the menu up/down button to scroll through the following settings:

Shift Out Of Park (default on Automatic Transmission) (Automatic Transmission Only): The vehicle's doors automatically lock when the doors are closed and the vehicle is shifted out of PARK (P).

At Vehicle Speed (default on Manual Transmission): The vehicle's doors automatically lock when the vehicle speed is above 5 mph (8 km/h) for three seconds.

No Change: No change will be made to this feature. The current setting will remain.

To select a setting, press the set/reset button while the desired setting is displayed on the DIC.

Auto Door Unlock

This feature allows you to select whether or not the door(s) will automatically unlock. It also allows you to select which doors and when they will automatically unlock. See *Programmable Automatic Door Locks on page 2-18* for more information.

Press the customization button until Auto Door Unlock appears on the DIC display. Press the set/reset button once to access the settings for this feature. Then press the menu up/down button to scroll through the following settings:

Off: None of the doors will automatically unlock.

Driver At Off: Only the driver's door will unlock when the ignition is turned off.

Driver In Park (Automatic Transmission Only): Only the driver's door will unlock when the vehicle is shifted into PARK (P).

All At Off (default on Manual Transmission): All of the doors will unlock when the ignition is turned off.

All In Park (default on Automatic Transmission)

(Automatic Transmission Only): All of the doors will unlock when the vehicle is shifted into PARK (P).

No Change: No change will be made to this feature. The current setting will remain.

To select a setting, press the set/reset button while the desired setting is displayed on the DIC.

Remote Door Lock

This feature allows you to select the type of feedback you will receive when locking the vehicle with the Remote Keyless Entry (RKE) or keyless access transmitter, or when the vehicle is automatically locked using the Keyless Locking feature. You will not receive feedback when locking the vehicle with the transmitter if the doors are open. See *Remote Keyless Entry (RKE) System Operation on page 2-7, Keyless Access System Operation on page 2-9, or “Keyless Locking”* later in this section for more information.

Press the customization button until Remote Door Lock appears on the DIC display. Press the set/reset button once to access the settings for this feature. Then press the menu up/down button to scroll through the following settings:

Off: There will be no feedback when you press the lock button on the transmitter.

Lights Only: The exterior lamps will flash when you press the lock button on the transmitter.

Horn Only: The horn will sound on the second press of the lock button on the transmitter.

Horn & Lights (default): The exterior lamps will flash when you press the lock button on the transmitter, and the horn will sound when the lock button is pressed again within five seconds of the previous command.

No Change: No change will be made to this feature. The current setting will remain.

To select a setting, press the set/reset button while the desired setting is displayed on the DIC.

Remote Door Unlock

This feature allows you to select the type of feedback you will receive when unlocking the vehicle with the Remote Keyless Entry (RKE) or keyless access transmitter, or when the vehicle is automatically unlocked using the Keyless Unlock feature. You will not receive feedback when unlocking the vehicle with the transmitter if the doors are open. See *Remote Keyless Entry (RKE) System Operation on page 2-7, Keyless Access System Operation on page 2-9, or “Keyless Unlock”* later in this section for more information.

Press the customization button until Remote Door Unlock appears on the DIC display. Press the set/reset button once to access the settings for this feature. Then press the menu up/down button to scroll through the following settings:

Lights Off: The exterior lamps will not flash when you press the unlock button on the transmitter.

Lights On (default): The exterior lamps will flash when you press the unlock button on the transmitter.

No Change: No change will be made to this feature. The current setting will remain.

To select a setting, press the set/reset button while the desired setting is displayed on the DIC.

Delay Door Lock

This feature allows you to select whether or not the locking of the vehicle's doors will be delayed. When locking the doors with the power door lock switch and a door is open, this feature will delay locking the doors until five seconds after the last door is closed. You will hear three chimes to signal that the delayed locking feature is in use. On vehicles with the Remote Keyless Entry (RKE) system, the key must be out of the

ignition for this feature to work. On vehicles with the Keyless Access System, the vehicle must be off and the keyless access transmitter must be removed from the vehicle for this feature to work. You can temporarily override delayed locking by pressing the power door lock switch twice or the lock button on the transmitter twice. See *Delayed Locking on page 2-18* for more information.

Press the customization button until Delay Door Lock appears on the DIC display. Press the set/reset button once to access the settings for this feature. Then press the menu up/down button to scroll through the following settings:

Off: There will be no delayed locking of the vehicle's doors.

On (default): The doors will not lock until five seconds after the last door is closed.

No Change: No change will be made to this feature. The current setting will remain.

To select a setting, press the set/reset button while the desired setting is displayed on the DIC.

Exit Lighting

This feature allows you to select the amount of time you want the exterior lamps to remain on when it is dark enough outside. This happens after the key is turned from ON/RUN to LOCK/OFF.

Press the customization button until Exit Lighting appears on the DIC display. Press the set/reset button once to access the settings for this feature. Then press the menu up/down button to scroll through the following settings:

Off: The exterior lamps will not turn on.

30 Seconds (default): The exterior lamps will stay on for 30 seconds.

1 Minute: The exterior lamps will stay on for one minute.

2 Minutes: The exterior lamps will stay on for two minutes.

No Change: No change will be made to this feature. The current setting will remain.

To select a setting, press the set/reset button while the desired setting is displayed on the DIC.

Approach Lighting

This feature allows you to select whether or not to have the exterior lights turn on briefly during low light periods after unlocking the vehicle using the Remote Keyless Entry (RKE) or keyless access transmitter.

Press the customization button until Approach Lighting appears on the DIC display. Press the set/reset button once to access the settings for this feature. Then press the menu up/down button to scroll through the following settings:

Off: The exterior lights will not turn on when you unlock the vehicle with the transmitter.

On (default): If it is dark enough outside, the exterior lights will turn on briefly when you unlock the vehicle with the transmitter.

The lights will remain on for 20 seconds or until the lock button on the transmitter is pressed, or the vehicle is no longer off. See *Remote Keyless Entry (RKE) System Operation on page 2-7* and *Keyless Access System Operation on page 2-9* for more information.

No Change: No change will be made to this feature. The current setting will remain.

To select a setting, press the set/reset button while the desired setting is displayed on the DIC.

Factory Settings

This feature allows you to set all of the customization features back to their factory default settings.

Press the customization button until Factory Settings appears on the DIC display. Press the set/reset button once to access the settings for this feature. Then press the menu up/down button to scroll through the following settings:

Restore All (default): The customization features will be set to their factory default settings.

Do Not Restore: The customization features will not be set to their factory default settings.

To select a setting, press the set/reset button while the desired setting is displayed on the DIC.

Advanced Features

If your vehicle has this feature, it allows you to enter the advanced features menu.

Press the customization button until Advanced Features Press ✓ To Enter appears on the DIC display. Press the set/reset button once to access the advanced feature menu. See “Advanced Features Menu Items” later in this section for more information.

If you do not press the set/reset button, Feature Settings Press ✓ To Exit appears on the DIC display. See “Feature Settings Exit” below for more information.

Feature Settings Exit

This feature allows you to exit the feature settings menu.

Press the customization button until Feature Settings Press ✓ To Exit appears in the DIC display. Press the set/reset button once to exit the menu.

If you do not exit, pressing the customization button again will return you to the beginning of the feature settings menu.

Advanced Features Menu Items Keyless Locking

If your vehicle has the keyless access system, this feature allows you to select whether the doors automatically lock during normal vehicle exit. When the ignition is turned off and all doors become closed, the vehicle will determine how many keyless access transmitters remain in the vehicle interior. If at least one keyless access transmitter has been removed from the interior of the vehicle, the doors will lock after several seconds.

For example, if there are two keyless access transmitters in the vehicle and one is removed, the other will be locked in. The keyless access transmitter locked in the vehicle can still be used to start the vehicle or unlock the doors, if needed. A person approaching the outside of the locked vehicle without an authorized keyless access transmitter, however, will not be able to open the door, even with a transmitter in the vehicle. See *Keyless Access System Operation on page 2-9* for more information.

You may temporarily disable the keyless locking feature by pressing the door unlock switch for three seconds on an open door. Keyless locking will then remain disabled until a door lock switch is pressed or until the power mode transitions from the off power mode.

To select whether the horn sounds or the lights flash when the vehicle is locked, see “Remote Door Lock” earlier in this section.

Press the customization button until Keyless Locking appears on the DIC display. Press the set/reset button once to access the settings for this feature. Then press the menu up/down button to scroll through the following settings:

Off (default): The keyless locking feature will be disabled.

On: The keyless locking feature will be enabled.

The doors will automatically lock several seconds after you turn the ignition off, remove a keyless access transmitter from the interior of the vehicle, and close all of the doors.

No Change: No change will be made to this feature. The current setting will remain.

To select a setting, press the set/reset button while the desired setting is displayed on the DIC.

Keyless Unlock

If your vehicle has the keyless access system, this feature allows you to select which doors will automatically unlock when you approach the vehicle with the keyless access transmitter and open the driver’s door. See *Keyless Access System Operation on page 2-9* for more information.

To select whether the lights flash when the vehicle is unlocked, see “Remote Door Unlock” earlier in this section.

Press the customization button until Keyless Unlock appears on the DIC display. Press the set/reset button once to access the settings for this feature. Then press the menu up/down button to scroll through the following settings:

Off: None of the doors will automatically unlock.

Entry Door Only: Only the driver's door will automatically unlock when you approach the vehicle with the keyless access transmitter and open the driver's door.

All Doors (default): All doors will automatically unlock when you approach the vehicle with the keyless access transmitter and open the driver or front passenger door.

No Change: No change will be made to this feature. The current setting will remain.

To select a setting, press the set/reset button while the desired setting is displayed on the DIC.

Electronic Key Reminder

If your vehicle has the keyless access system, this feature allows you to select whether or not the horn chirps when the driver's door is closed and there is a keyless access transmitter inside the interior of the vehicle. This will only occur when the vehicle is off.

Press the customization button until Electronic Key Reminder appears on the DIC display. Press the set/reset button once to access the settings for this feature. Then press the menu up/down button to scroll through the following settings:

Electronic Key Reminder Off: The horn will not chirp when a keyless access transmitter is inside of the vehicle while the ignition is turned off and the driver's door is closed.

Electronic Key Reminder On (default): The horn will chirp three times when a keyless access transmitter is inside of the vehicle while the ignition is turned off and the driver's door is closed.

No Change: No change will be made to this feature. The current setting will remain.

To select a setting, press the set/reset button while the desired setting is displayed on the DIC.

Chime Volume

This feature allows you to select the volume level of the chime.

Press the customization button until Chime Volume appears on the DIC display. Press the set/reset button once to access the settings for this feature. Then press the menu up/down button to scroll through the following settings:

Normal: The chime volume will be set to a normal level.

Loud: The chime volume will be set to a loud level.

No Change: No change will be made to this feature. The current setting will remain.

There is no default for chime volume. The volume will stay at the last known setting.

To select a setting, press the set/reset button while the desired setting is displayed on the DIC.

Park Tilt Mirrors

If your vehicle has this feature, it allows you to select whether or not the outside mirror(s) will automatically tilt down when the vehicle is shifted into REVERSE (R). See *Park Tilt Mirrors on page 2-50* for more information.

Press the customization button until Park Tilt Mirrors appears on the DIC display. Press the set/reset button once to access the settings for this feature. Then press the menu up/down button to scroll through the following settings:

Off (default): Neither outside mirror will be tilted down when the vehicle is shifted into REVERSE (R).

Driver Mirror: The driver's outside mirror will be tilted down when the vehicle is shifted into REVERSE (R).

Passenger Mirror: The passenger's outside mirror will be tilted down when the vehicle is shifted into REVERSE (R).

Both Mirrors: The driver's and passenger's outside mirrors will be tilted down when the vehicle is shifted into REVERSE (R).

No Change: No change will be made to this feature. The current setting will remain.

To select a setting, press the set/reset button while the desired setting is displayed on the DIC.

Easy Exit Recall

If your vehicle has this feature, it allows you to select your preference for the automatic easy exit seat feature. See *Memory Seat and Mirrors on page 1-6* for more information.

Press the customization button until Easy Exit Recall appears on the DIC display. Press the set/reset button once to access the settings for this feature. Then press the menu up/down button to scroll through the following settings:

Door Button Only: No automatic seat exit recall will occur. The recall will only occur after pressing the easy exit seat button.

Button And Automatic (Keyless Access default): If the features are enabled though the Easy Exit Setup menu, the driver's seat will move back, and if the vehicle has the power tilt wheel and telescopic steering feature, the power steering column will move up and forward when the vehicle is parked and the driver door is opened, or after pressing the easy exit seat button.

The automatic easy exit seat movement will only occur one time after the driver door is opened. If the automatic movement has already occurred, and you close and then open the driver door, the seat and steering column will stay in the original exit position, unless a memory recall took place prior to opening the driver door again.

Button And Automatic (Key Access default): If the features are enabled through the Easy Exit Setup menu, the driver's seat will move back, and if the vehicle has the power tilt wheel and telescopic steering feature, the power steering column will move up and forward when the key is removed from the ignition or after pressing the easy exit seat button. The automatic easy exit seat movement will only occur one time after the key is removed from the ignition. If the automatic movement has already occurred, and you put the key back in the ignition and remove it again, the seat and steering column will stay in the original exit position, unless a memory recall took place prior to removing the key again.

No Change: No change will be made to this feature. The current setting will remain.

To select a setting, press the set/reset button while the desired setting is displayed on the DIC.

Easy Exit Setup

If your vehicle has this feature, it allows you to select which areas will recall with the automatic easy exit seat feature. It also allows you to turn off the automatic easy exit feature. See *Memory Seat and Mirrors on page 1-6* and "Easy Exit Recall" earlier for more information.

Press the customization button until Easy Exit Setup appears on the DIC display. Press the set/reset button once to access the settings for this feature. Then press the menu up/down button to scroll through the following settings:

Off: No automatic seat exit will recall.

Seat Only: The driver's seat will recall.

Tilt Only: The steering wheel tilt feature will recall.

Telescope Only: The steering column telescope feature will recall.

Seat/Tilt: The driver's seat and the steering wheel tilt feature will recall.

Seat/Telescope: The driver's seat and the steering column telescope feature will recall.

Tilt/Telescope: The steering wheel tilt and steering column telescope features will recall.

All (default): The driver's seat and the steering wheel tilt and steering column telescope features will recall, if your vehicle has this option.

No Change: No change will be made to this feature. The current setting will remain.

To select a setting, press the set/reset button while the desired setting is displayed on the DIC.

Memory Seat Recall

If your vehicle has this feature, it allows you to select your preference for the remote memory seat recall feature. See *Memory Seat and Mirrors on page 1-6* for more information.

Press the customization button until Memory Seat Recall appears on the DIC display. Press the set/reset button once to access the settings for this feature. Then press the menu up/down button to scroll through the following settings:

Off (default): No remote memory seat recall will occur.

On: The driver's seat and outside mirrors will automatically move to the stored driving position when the unlock button on the Remote Keyless Entry (RKE) or keyless access transmitter is pressed. The steering column will also move on vehicles with the power tilt and telescopic steering feature. See *Power Tilt Wheel and Telescopic Steering Column on page 3-7* for more information. See "Relearn Remote Key" under *DIC Operation and Displays on page 3-48* for more information on matching transmitters to driver ID numbers.

No Change: No change will be made to this feature. The current setting will remain.

To select a setting, press the set/reset button while the desired setting is displayed on the DIC.

Remote Start

If the vehicle has this feature, it allows you to turn the remote start feature off or on. The remote start feature allows you to start the engine from outside of the vehicle using the Remote Keyless Entry (RKE) or keyless access transmitter. See *Remote Vehicle Start on page 2-14* for more information.

Press the customization button until Remote Start appears in the DIC display. Press the set/reset button once to access the settings for this feature. Then press the menu up/down button to scroll through the following settings:

Off: The remote start feature will be disabled.

On (default): The remote start feature will be enabled.

No Change: No change will be made to this feature. The current setting will remain.

To select a setting, press the set/reset button while the desired setting is displayed on the DIC.

Advanced Features Exit

This feature allows you to exit the advanced features menu.

Press the customization button until Advanced Features Press ✓ To Exit appears in the DIC display. Press the set/reset button once to exit the menu. Feature Settings Press ✓ To Exit will appear. Press the set/reset button to exit the menu.

If you do not exit, pressing the customization button again will return you to the beginning of the menu.

Exiting the Feature Settings/Advanced Features Menu

The feature settings/advanced features menus will be exited when any of the following occurs:

- The vehicle is no longer in ON/RUN.
- The trip/fuel or vehicle information DIC buttons are pressed.
- The end of the feature settings menu is reached and exited.
- A 40 second time period has elapsed with no selection made.

Audio System(s)

Determine which radio your vehicle has and then read the pages following to familiarize yourself with its features.

CAUTION:

This system provides you with far greater access to audio stations and song listings. Giving extended attention to entertainment tasks while driving can cause a crash and you or others can be injured or killed. Always keep your eyes on the road and your mind on the drive — avoid engaging in extended searching while driving.

Keeping your mind on the drive is important for safe driving. See *Defensive Driving on page 4-2*. Here are some ways in which you can help avoid distraction while driving.

While your vehicle is parked:

- Familiarize yourself with all of its controls.
- Familiarize yourself with its operation.
- Set up your audio system by presetting your favorite radio stations, setting the tone, and adjusting the speakers. Then, when driving conditions permit, you can tune to your favorite radio stations using the presets and steering wheel controls if the vehicle has them.

Notice: Before adding any sound equipment to your vehicle, such as an audio system, CD player, CB radio, mobile telephone, or two-way radio, make sure that it can be added by checking with your dealer/retailer. Also, check federal rules covering mobile radio and telephone units. If sound equipment can be added, it is very important to do it properly. Added sound equipment may interfere with the operation of your vehicle's engine, radio, or other systems, and even damage them. Your vehicle's systems may interfere with the operation of sound equipment that has been added.

Your vehicle has a feature called Retained Accessory Power (RAP). With RAP, the audio system can be played even after the ignition is turned off. See *Retained Accessory Power (RAP)* on page 2-34 for more information.

Radio(s)

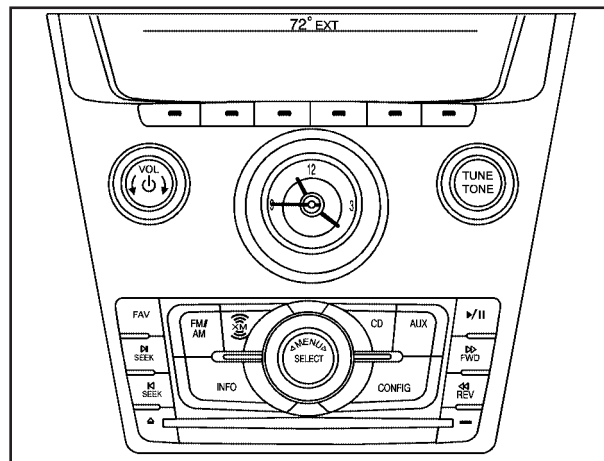

Full View of Radio with CD shown, Radio with Six-Disc CD similar

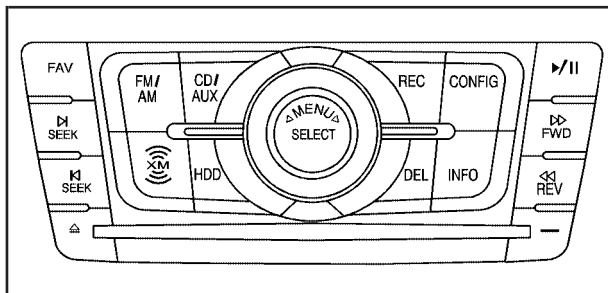

Partial View of Radio with DVD Audio, Hard Disc Drive (HDD), and USB

Your vehicle may have one of these radios as its audio system.

If your vehicle does not have one of these radio systems, it may have a navigation radio system. See the Navigation System manual for more information on the navigation audio system.

If your vehicle has one of these radios, it has either a Bose® sound system or a Bose® 5.1 Cabin Surround® sound system. See “Digital Signal Processing (DSP)” later in this section for more information on the Bose® 5.1 Cabin Surround® sound system.

The radio with DVD Audio, HDD, and USB utilizes Gracenote® technology to provide Song, Artist, Album, and Genre information for many CD audio discs and is capable of playing DVD-A and DTS encoded discs, (DTS and DTS Digital Surround are registered trademarks of Digital Theater Systems, Inc.).

Manufactured under license from Dolby® Laboratories. Dolby® and the double-D symbol are trademarks of Dolby® Laboratories.

Radio Data System (RDS)

The audio system has a Radio Data System (RDS) feature. RDS is available for use only on FM stations that broadcast RDS information. This system relies upon receiving specific information from these stations and only works when the information is available. While the radio is tuned to an FM-RDS station, the station name or call letters display. In rare cases, a radio station can broadcast incorrect information that causes the radio features to work improperly. If this happens, contact the radio station.

Playing the Radio

VOL  (**Volume/Power**): The power knob is part of the VOL (volume) knob and is located above the radio, at the left side of the clock. Press to turn the system on and off.

Turn the VOL knob clockwise or counterclockwise to increase or decrease the volume.

Speed Compensated Volume (SCV): A Radio with Speed Compensated Volume (SCV) automatically adjusts the sound to compensate for road and wind noise as the vehicle speeds up or slows down, so that the volume is consistent while driving. That way, the volume level should sound about the same as you drive. To activate SCV:

1. Set the radio volume to the desired level.
2. Press the CONFIG button to display the radio setup menu.
3. Press the pushbutton under the AUTO VOL (automatic volume) label on the radio display.
4. Press the pushbutton under the desired Speed Compensated Volume setting (OFF, Low, Med, or High) to select the level of radio volume compensation. The display times out after approximately 10 seconds. Each higher setting allows for more radio volume compensation at faster vehicle speeds.

Noise Compensation Technology: If your vehicle has the Radio with DVD Audio, HDD, and USB, it includes Bose AudioPilot® noise compensation technology.

When turned on, AudioPilot® continuously adjusts the audio system equalization, to compensate for background noise.

This feature is most effective at lower radio volume settings where background noise can affect how well you hear the music being played through your vehicle's audio system. At higher volume settings, where the music is much louder than the background noise, there might be little or no adjustments by AudioPilot®. For additional information on AudioPilot®, visit www.bose.com/audiopilot.

To activate AudioPilot®:

1. Press the CONFIG button to display the radio setup menu.
2. Press the pushbutton under the AUTO VOL label on the radio display.
3. Press either the On or Off label located under the AUTO VOL display to turn this feature on or off. The display times out after approximately 10 seconds.

Finding a Station

TUNE/TONE: Turn to select different radio stations within a selected band.

FM/AM: Press to switch between FM and AM radio bands.

◀ SEEK ▶ : Press the arrows to go to the previous or to the next radio station and stay there.

The radio only tunes into stations with a strong signal that are in the selected band.

INFO (Information) (FM-RDS, XM™ Satellite Radio Service, CD-Text, CD Gracenote Database, HDD, MP3/WMA, and iPod): Press to display additional text information related to the currently playing content.

When information is not available, No Information displays.

MENU/SELECT: For FM/AM stations, the MENU/SELECT displays a list of available radio stations. Under this menu, there is a refresh list selection that allows the user to update the list for all available stations that the radio is able to receive at the current location.

For XM™ stations, the music guide displays a Category list. This list displays all of the Categories available and the number of XM™ stations available under each.

Turn the MENU/SELECT knob clockwise or counterclockwise to scroll through the list. Press this knob to select the desired item. The selected item displays a speaker symbol to indicate it is the current active source.

Finding a XM™ Station

: Press to switch to XM™ mode. Turn the TUNE/TONE knob to select from a list of available XM stations. Turn the TUNE/TONE knob until the desired station is highlighted. Press the TUNE/TONE knob to select the highlighted station. The highlighted station will also automatically be selected if the TUNE/TONE is released and no longer turned.

Storing a Radio Station as a Favorite

Drivers are encouraged to set up their radio station favorites while the vehicle is stopped. Tune to your favorite stations using the presets, favorites button, and steering wheel controls, if the vehicle has this feature. See *Defensive Driving on page 4-2*.

FAV (Favorites): A maximum of 36 stations can be programmed as favorites using the six pushbuttons positioned below the radio station frequency labels on the display and by using the radio favorites page button (FAV button). Press the FAV button to go through up to six pages of favorites, each having six favorite stations available per page. Each page of favorites can contain any combination of AM, FM, or XM™ (if equipped) stations.

To store a station as a favorite, perform the following steps:



1. Tune to the desired radio station.
2. Press the FAV button to display the page where the station is to be stored.
3. Press and hold one of the six pushbuttons until a beep sounds. When that pushbutton is pressed and released, the radio recalls the station that was set.
4. Repeat the steps for each pushbutton radio station to be stored as a favorite.

The number of favorites pages can be setup using the CONFIG button. To setup the number of favorites pages, perform the following steps:

1. Press the CONFIG button to display the radio setup menu.
2. Press the pushbutton located below the FAV label.

3. Select the desired number of favorites pages by pressing the pushbutton located below the displayed page numbers.
4. Press the FAV button, or let the menu time out, to return to the original main radio screen showing the radio station frequency labels and to begin the process of programming your favorites for the chosen number of pages.

Setting the Tone (Bass/Midrange/Treble)

BASS/MID/TREB (Bass, Midrange, or Treble): To adjust bass, midrange, or treble, press the TUNE/TONE knob until the tone control labels display. Continue pressing to highlight the desired label, or press the pushbutton positioned under the desired label. Turn the TUNE/TONE knob clockwise or counterclockwise to adjust the highlighted setting. The highlighted setting can also be adjusted by pressing either SEEK arrow,  FWD, or  REV button until the desired levels are obtained. If a station's frequency is weak or has static, decrease the treble.

To quickly adjust bass, midrange, or treble to the middle position, press the pushbutton positioned under the BASS, MID, or TREB label for more than two seconds. A beep may sound and the level adjusts to the middle position.

To quickly adjust all tone and speaker controls to the middle position, press the TUNE/TONE knob for more than two seconds.

Adjusting the Speakers (Balance/Fade)

BAL/FADE (Balance/Fade): To adjust balance or fade, press the TUNE/TONE knob until the speaker control labels display. Continue pressing to highlight the desired label, or press the pushbutton positioned under the desired label. Turn the TUNE/TONE knob clockwise or counterclockwise to adjust the highlighted setting. The highlighted setting can be adjusted by pressing either SEEK arrow, **▶▶ FWD**, or **◀◀ REV** buttons until the desired levels are obtained.

To quickly adjust balance or fade to the middle position, press the pushbutton positioned under the BAL or FADE label for more than two seconds. A beep may sound and the level adjusts to the middle position.

To quickly adjust all speaker and tone controls to the middle position, press the TUNE/TONE knob for more than two seconds.

Digital Signal Processing (DSP)

If your radio has this feature, it is used to provide a choice of different listening experiences. To choose a DSP setting, perform the following steps:

1. Press the TUNE/TONE knob to display the tone/speaker, and DSP labels.
2. Press the pushbutton located under the DSP label.
3. Press the Back button to exit the display. To return to the original display, repeatedly press the Back button or wait for the display to time out.

The DSP settings available are:

- **Normal:** Select for normal mode, this provides the best sound quality for all seating positions.
- **Driver:** Select to adjust the audio for the driver to receive the best possible sound quality.
- **Rear:** Select to adjust the audio for the rear seat passengers to receive the best possible sound quality.
- **Centerpoint®:** Select to enable Bose® Centerpoint®. Centerpoint® produces a full vehicle surround sound listening experience from CD, non-5.1 surround sound DVD-A, MP3/WMA, AUX (auxiliary) input, or XM™ digital audio source and will deliver five independent audio channels from conventional two channel stereo recording.

This feature is not available in AM/FM radio mode.

If your vehicle is equipped with the Bose® 5.1 Cabin Surround® sound system, your radio can support the playback of 5.1 Surround Sound DVD-A discs or DTS 5.1 Surround Sound CD discs. When a 5.1 Surround Sound formatted disc is playing, DSP options available are:

- 5.1 Surround + Normal: Best for all seating positions.
- 5.1 Surround + Rear: Best for the rear seating position.

Configuring Radio Functions

CONFIG: Press to display FAV, AUTO VOL, XM (if equipped), or HDD (if available), and Back. See the information provided in this radio section to learn more options about the FAV, AUTO VOL, XM, and HDD (if available) label functions. See “Speed Compensated Volume (SCV)” or “Noise Compensation Technology” earlier for information on the AUTO VOL label. Press the pushbutton located under the Back label to go back to the previous display.

Radio Message

Locked: Displays when the THEFTLOCK® system has locked up the radio. Take the vehicle to your dealer/retailer for service.

If any error occurs repeatedly or if an error cannot be corrected, contact your dealer/retailer.

XM™ Satellite Radio Service

XM™ is a satellite radio service that is based in the 48 contiguous United States and 10 Canadian provinces. XM™ Satellite Radio has a wide variety of programming and commercial-free music, coast-to-coast, and in digital-quality sound. During your trial or when you subscribe, you will get unlimited access to XM™ Radio Online for when you are not in your vehicle. A service fee is required to receive the XM™ service. For more information, contact XM™ at www.xmradio.com or call 1-800-929-2100 in the U.S. and www.xmradio.ca or call 1-877-438-9677 in Canada.

Radio Messages for XM™ Only

See *XM Radio Messages on page 3-105* later in this section for further detail.

Playing a CD (Single Disc Player)

Insert a CD partway into the slot, label side up. The player pulls it in. The CD track number and a Shuffle label displays. The CD begins playback.

Shuffle: Press the pushbutton located below the Shuffle label to play the tracks of a CD in random order. Press again to turn Shuffle off. Shuffle Off displays.

Playing a CD(s) (Six-Disc CD Player)

 **(Load):** Press to load CDs into the CD player. This CD player holds up to six CDs.

To insert one CD:

1. Press and release the load button.
2. Wait for the message to insert the disc.
3. Load a CD. Insert the CD partway into the slot, label side up. The player pulls the CD in. A Shuffle label and the DISC icon displays.
4. Press the pushbutton located below the Shuffle label to play the tracks of a current disc in random order. Press the pushbutton again to turn Shuffle off. Shuffle Off displays.
5. The CD resumes normal playback.

To insert multiple CDs, do the following:

1. Press and hold this button for five seconds. A beep sounds and Load All Discs displays.
2. Follow the displayed instruction on when to insert the discs. The CD player takes up to six CDs.
3. Press the Load button again to cancel loading more CDs.



If the ignition or radio is turned off while a CD in the player, it stays in the player. When the ignition or radio is turned on, the CD starts playing where it stopped, if it was the last selected audio source.

When a CD is inserted, the disc number displays on the upper right side of the screen and the track number displays at the left and center of the screen. The Shuffle and Disc labels appear below. Press the pushbuttons located under the Disc label to change to another disc. The CD begins playback of the first track on the selected disc. As each new track starts to play the track number displays in the left and center of the screen.

Shuffle: Press the pushbutton located below the Shuffle label to play the tracks of a CD in random order. Press again to turn Shuffle off. Shuffle Off displays

 **(Eject):** To eject the disc that is currently playing, press and release. Ejecting Disc displays and a beep sounds. Once the disc is ejected, Remove Disc displays. The disc can be removed. If the disc is not removed, after several seconds, the disc automatically pulls back into the player and begins playing.

For the Six-Disc CD player, press and hold for two seconds to eject all discs.

 **SEEK**  : Press the left arrow to go to the start of the current track, if more than five seconds have played. Press the right arrow to go to the next track. If either arrow is held, or pressed multiple times, the player continues moving backward or forward through the tracks on the CD.

 **REV (Fast Reverse):** Press and hold to reverse playback quickly within a track. Sound is heard at a reduced volume and the elapsed time of the track displays. Release to resume playing the track.

 **FWD (Fast Forward):** Press and hold to advance playback quickly within a track. Sound is heard at a reduced volume and the elapsed time of the track displays. Release to resume playing the track.

FM/AM: Press to listen to the radio when a CD is playing. The CD remains inside the radio for future listening.

CD: Press to play a CD when listening to the radio. The disc and/or track number displays when a CD is in the player.

AUX (Auxiliary): Press to automatically search for an auxiliary input device, such as a portable audio player. If a portable audio player is not connected, "No Aux Input Device Found" displays.

Playing a DVD-A (Audio) Disc

The radio with DVD Audio, HDD, and USB is capable of playing DVD audio discs in the Bose® 5.1 Cabin surround sound system.

Insert the DVD audio disc into the CD/DVD-A player. DVD AUDIO displays and playback begins. The Group and track number displays during playback.

This type of radio does not support the playback of DVD video discs. If you attempt to play a DVD video disc, the radio displays "Read Error Please Check Disc" and ejects the disc.

CD/AUX (CD/Auxiliary): Press to switch between CD/DVD-A, auxiliary input, and USB devices.

◀◀ **REV (Fast Reverse):** Press to reverse playback quickly within a track. Sound is heard at a reduced volume. Press once to change playback to a speed of 2X. Each successive press changes playback to a speed of 4X, 10X, or 21X. Press ▶ / || (play/pause) to resume normal playback. The elapsed time of the track displays.

While recording a disc to HDD, the fast reverse does not function.

▶▶ **FWD (Fast Forward):** Press to advance playback quickly within a track. Sound is heard at a reduced volume. Press once to change playback to a speed of 2X. Each successive press changes playback to a speed of 4X, 10X, or 21X. Press ▶ / || to resume normal playback. The elapsed time of the track displays.

While recording a disc to HDD, the fast forward does not function.

Stopping DVD Audio Playback

Press the pushbutton located under the ■ (stop) label to stop playback of the DVD audio disc. “DVD PreStop” displays. Press ▶ / || to resume playback from where it was stopped.

Press the pushbutton located under the ■ label again while in DVDPreStop, “DVDStop” displays. Press ▶ / || while in DVDStop to begin playback from the beginning of the DVD audio disc.

Press ▶ / || during DVD audio playback to pause or resume playback.

Finding Songs on DVD Audio

TUNE/TONE: Turn this knob to display a list of all tracks in all groups on the DVD audio disc. Stop turning this knob or press the TUNE/TONE knob to start playback of a particular track.

◀ **SEEK** ▶ : Press the left arrow to go to the start of the current track, if more than five seconds have played. Press the right arrow to go to the next track. If either arrow is held, or pressed multiple times, the player continues moving backward or forward through the tracks within the current Group.

MENU/SELECT: To change Groups, press the pushbutton located under the Menu label to display a list of all Groups. Turn the MENU/SELECT knob to highlight the desired Group. Press the MENU/SELECT knob to select it. Playback begins from track 1 of the selected Group.

Shuffle on DVD Audio

Press the pushbutton located under the Shuffle label to begin random playback of all songs in the current Group. Press again to turn off random playback.

Selecting DVD Audio Streams

Each DVD audio Group may contain audio content that is encoded in one or two formats. For example, a particular Group may have both a 5.1 surround audio stream and a 2.0 stereo audio stream available.

Press the pushbutton located under the Audio label to display the current audio stream playing. “Audio Stream 1” or “Audio Stream 2” briefly displays. Press the pushbutton located under the Audio label again to toggle between Audio Stream 1 or Audio Stream 2 (if available).

Check the DSP settings to determine if a 5.1 surround sound Audio Stream is playing. See “Digital Signal Processing (DSP)” earlier in this section. Press the DSP label to see if the 5.1 + Normal or 5.1 + Rear settings are available for selection. If these settings are available, Audio Stream 1 is playing.

Care of Your CD and DVD-A Discs

If playing a CD or DVD-A disc, the sound quality can be reduced due to disc quality, the method of recording, the quality of the music that has been recorded, and the way the disc has been handled. Handle them carefully. Store disc(s) in their original cases or other protective cases and away from direct sunlight and dust. The CD/DVD-A player scans the bottom surface of the disc. If the surface of a disc is damaged, such as cracked, broken, or scratched, the disc may not play properly or not at all. Do not touch the bottom side of a disc while handling it; this could damage the surface. Pick up discs by grasping the outer edges or the edge of the hole and the outer edge.

If the surface of a disc is soiled, take a soft, lint free cloth or dampen a clean, soft cloth in a mild, neutral detergent solution mixed with water, and clean it. Make sure the wiping process starts from the center to the edge.

Care of Your CD or DVD-A Player

Do not add any label to a disc, it could get caught in the CD/DVD-A player. If a disc is recorded on a personal computer and a description label is needed, label the top of the recorded disc with a marking pen.

The use of disc lens cleaners for discs is not advised, due to the risk of contaminating the lens of the disc optics with lubricants internal to the CD/DVD-A player mechanism.

Notice: If a label is added to a CD, or more than one CD is inserted into the slot at a time, or an attempt is made to play scratched or damaged CDs, the CD player could be damaged. While using the CD player, use only CDs in good condition without any label, load one CD at a time, and keep the CD player and the loading slot free of foreign materials, liquids, and debris.

If an error displays, see “Disc Messages” later in this section.

Playing an MP3/WMA Disc

Radios with the MP3 feature are capable of playing an MP3/WMA CD-R or CD-RW disc. Radios with the DVD Audio feature, are capable of playing MP3/WMA on DVD+/-R discs. For more information, see *Using an MP3 on page 3-101* later in this section.

Disc Messages

DISC ERROR: If this message displays and/or the disc ejects, it could be for one of the following reasons:

- The radio system does not support the playlist format, the compressed audio format, or the data file format.
- It is very hot. When the temperature returns to normal, the disc should play.
- You are driving on a very rough road. When the road becomes smoother, the disc should play.
- The disc is dirty, scratched, wet, or upside down.
- The air is very humid. If so, wait about an hour and try again.
- There could have been a problem while burning the disc.
- The label could be caught in the CD/DVD-A player.

If the disc is not playing correctly, for any other reason, try a known good disc.

If any error occurs repeatedly or if an error cannot be corrected, contact your dealer/retailer. If the radio displays an error message, write it down and provide it to your dealer/retailer when reporting the problem.

Hard Disk Drive (HDD)

Radios with a hard disk drive are able to record songs from Audio CDs, MP3/WMA discs, and USB mass storage devices. This type of radio has a 40 GB (gigabyte) HDD. A portion of the HDD is used for the storage of radio system files. The remainder of the HDD capacity is available for the storage of media files.

Recording From Audio CDs

REC (Record): While listening to an audio CD, press to start recording songs from the disc. The radio has the option to record the current song playing or all songs from the CD. Press the pushbutton located under the desired record option.

A status bar appears on the top of the display when the recording process starts. The status bar disappears when the process has ended. The recorded songs are now available.

Copy Protected CD(s)

Make sure the disc is not copy-protected. The radio does not copy a copy-protected CD to the HDD.

Stopping the Recording

While recording from the audio CD, press the REC button to display the stop recording option. Press the pushbutton located under this option to confirm the selection.

Ejecting a CD or Turning Off Your Vehicle While Recording

If the CD is ejected or the vehicle is turned off before the recording process has completed, tracks that have been completely recorded are stored to the HDD. Incomplete tracks are discarded.

Re-recording Audio CDs

If a CD has already been recorded, the radio system will not record the contents again. If a partially recorded CD is selected for recording, only those songs which are not already on the HDD will be recorded.

Audio CD Song, Artist, Album and Genre Information

Radios with HDD, contain a Gracenote® Database that the radio uses to determine the song, artist, album and genre information. The Gracenote® Database allows the radio to record an audio CD to the HDD and store the content using song, artist, album and genre information.

Newly released audio CDs as well as some less common audio CDs may not be found in the Gracenote® Database stored on the HDD. If these audio CDs contain CD-text, the radio will use the CD-text information when recording the content to the HDD. If an audio CD is not found in the Gracenote® Database and it does not have CD-text information, the radio will record the audio CD with all song, artist, album and genre names as “NO INFO”.

Songs recorded with “NO INFO” to the HDD will be hard to sort, identify, and select. For better HDD navigation, CDs with “NO INFO” can first be converted to MP3 format with Tag information on a home computer and then recorded to the HDD from an MP3 disc or USB device.

Occasionally, the radio may find more than one match in Gracenote® Database for an audio CD that has been recorded. If this happens, the radio will display “MultiHit” for the name information when the songs are selected from the HDD. With a “MultiHit” song playing, press the button below the EDIT label to bring up the list of multiple names found in the Gracenote® Database. Use the Menu/Select knob to highlight and select the correct name for the “MultiHit” recorded CD.

The Gracenote® Database stored on your HDD can be updated so that it includes name information for more recently released audio CDs. See your dealer/retailer for more information on Gracenote® Database updates for your HDD radio.

Gracenote® Database

Gracenote Music Recognition Service, Music recognition technology, and related data are provided by Gracenote®. Gracenote is the industry standard in music recognition technology and related content delivery. For more information, visit www.gracenote.com.

CD and music-related data from Gracenote, Inc., copyright © 2000-2007 Gracenote. Gracenote Software, copyright © 2000-2007 Gracenote. This product and service may practice one or more of the following U.S. Patents: #5,987,525; #6,061,680; #6,154,773, #6,161,132, #6,230,192, #6,230,207, #6,240,459, #6,330,593, and other patents issued or pending. Some services supplied under license from Open Globe, Inc. for U.S. Patent: #6,304,523.

Gracenote and CDDB are registered trademarks of Gracenote. The Gracenote logo and logotype, and the “Powered by Gracenote” logo are trademarks of Gracenote.

If you require more information regarding the use of the Gracenote Service, visit: www.gracenote.com/corporate

For the data provided by Gracenote® Music Recognition Service, the content is not necessarily guaranteed 100%.

Regarding the use of Gracenote Music Recognition Service. When this product is used, it is necessary to agree to the following articles.

This application or device contains software from Gracenote, Inc. of Emeryville, California (“Gracenote”).

The software from Gracenote (the “Gracenote Software”) enables this application to perform disc and/or file identification and obtain music-related information, including name, artist, track, and title information (“Gracenote Data”) from online servers or embedded databases (collectively, “Gracenote Servers”) and to perform other functions.

You may use Gracenote Data only by means of the intended End-User functions of this application or device. You agree that you will use Gracenote Data, the Gracenote Software, and Gracenote Servers for your own personal non-commercial use only. You agree not to assign, copy, transfer or transmit the Gracenote Software or any Gracenote Data to any third party.

YOU AGREE NOT TO USE OR EXPLOIT GRACENOTE DATA, THE GRACENOTE SOFTWARE, OR GRACENOTE SERVERS, EXCEPT AS EXPRESSLY PERMITTED HEREIN. You agree that your non-exclusive license to use the Gracenote Data, the Gracenote Software, and Gracenote Servers will terminate if you violate these restrictions. If your license terminates, you agree to cease any and all use of the Gracenote Data, the Gracenote Software, and Gracenote Servers.

Gracenote reserves all rights in Gracenote Data, the Gracenote Software, and the Gracenote Servers, including all ownership rights.

Under no circumstances will Gracenote become liable for any payment to you for any information that you provide. You agree that Gracenote, Inc. may enforce its rights under this Agreement against you directly in its own name.

The Gracenote service uses a unique identifier to track queries for statistical purposes.

The purpose of a randomly assigned numeric identifier is to allow the Gracenote service to count queries without knowing anything about who you are. For more information, see the web page for the Gracenote Privacy Policy for the Gracenote service.

The Gracenote Software and each item of Gracenote Data are licensed to you “AS IS.” Gracenote makes no representations or warranties, express or implied, regarding the accuracy of any Gracenote Data from in the Gracenote Servers.

Gracenote reserves the right to delete data from the Gracenote Servers or to change data categories for any cause that Gracenote deems sufficient.

No warranty is made that the Gracenote Software or Gracenote Servers are error-free or that functioning of Gracenote Software or Gracenote Servers will be uninterrupted.

Gracenote is not obligated to provide you with new enhanced or additional data types or categories that Gracenote may provide in the future and is free to discontinue its services at any time.

GRACENOTE DISCLAIMS ALL WARRANTIES EXPRESS OR IMPLIED, INCLUDING, BUT NOT LIMITED TO, IMPLIED WARRANTIES OF MERCHANTABILITY, FITNESS FOR A PARTICULAR PURPOSE, TITLE, AND NON-INFRINGEMENT. GRACENOTE DOES NOT WARRANT THE RESULTS THAT WILL BE OBTAINED BY YOUR USE OF THE GRACENOTE SOFTWARE OR ANY GRACENOTE SERVER. IN NO CASE WILL GRACENOTE BE LIABLE FOR ANY CONSEQUENTIAL OR INCIDENTAL DAMAGES OR FOR ANY LOST PROFITS OR LOST REVENUES.

Recording From MP3/WMA Discs or USB

REC (Record): While listening to a MP3/WMA disc or a USB device (excluding iPod), press to start recording songs from the disc. The radio has the option to record the current song playing or all songs from the disc. Press the pushbutton located under the desired record option.

A status bar appears on the top of the display when the recording process starts. The status bar disappears when the process has ended. The recorded songs are now available.

AAC and OGG Vorbis file types are not fully supported. These file types may or may not play and may be shown without Tag information. Without Tag information available, these file types may be identified only by filename.

Audiobooks from www.audible.com can also be transferred to the HDD using the record function. See Audiobooks later in this section for more information.

USB Host Support

The USB connector uses the USB standards, 1.1 and 2.0. This type of connector supports rates for low speed (1.5 Mb/s), full speed (12 Mb/s), and high speed (480 Mb/s).

USB Supported Devices

- USB Flash Drives
- Portable USB Hard Drives

Playing From the Hard Disc Drive

HDD (Hard Disc Drive): Press the HDD button to start the HDD mode. HDD displays and playback resumes from where it was last stopped.

HDD Playback Mode

This radio system displays the current hard drive playback mode. See the following table showing the display mode options and what happens as the mode is displayed:

Mode	When Displayed
Shuffle	System is randomly playing back all HDD content.
Artist	System is playing back content by a selected Artist in alphabetical order.
Album	System is playing back content from a selected album in track order.
Genre	System is playing back content in a selected Genre in alphabetical order.
Song	System is playing back all songs in alphabetical order.
Playlist	System is playing back all songs from the selected playlist in the order they were added.
AudioBook	System is playing back audio book content.

HDD Menu

1. Press the MENU/SELECT knob to display the HDD Menu.
2. Turn this knob to highlight an option from the HDD Menu. The available options are:
 - Shuffle Songs
 - Playlist
 - Artists
 - Albums
 - Song Titles
 - Genres
 - Recently Saved
 - Audiobook
3. Press the MENU/SELECT knob to select the desired option.

Shuffle Songs

Select this option from the HDD Menu to randomly play back HDD content.

Playlist

Select this option from the HDD Menu to display all six favorite Playlists, then select one of the six playlist to display a list of songs that have been added to that favorite playlist. Select a song from the list to begin playback of that song and to put the HDD into the Playlist mode. See “Saving HDD Favorites” later in this section for more information.

HDD Categories

The HDD category mode can be used to select a song by a particular artist, album, or genre for playback. As an example, the HDD Menu displays a layout such as:

—	Artists (5)
—	Albums (6)
—	Song Titles (77)
—	Genres (3)

The radio system displays the number of available items in each individual category as shown on the sample display. For example, the sample display shows there is content on the hard drive from five individual artists.

Select the HDD Menu category to display the available items in each individual category, then select an item from one of these submenus to display a list of songs related to that menu item. Select a song to begin playback of that song and to put the HDD in the playback mode.

Recently Saved

Select this option from the HDD Menu to display the last 50 songs added since the vehicle was last turned on. The songs are categorized into songs recorded from CDs or USB devices.

Audiblebook

The radio is able to play back audio-book content downloaded from www.audible.com[®]. This content can be transferred into the HDD by either burning it to a CD or copying it to a USB storage device and then recording it to the HDD.

The [audible.com](http://www.audible.com)[®] playback requires activation of the vehicle as a player for downloaded content. The radio system activates the [audible.com](http://www.audible.com)[®] system when information is found on either a CD inserted into the CD/DVD-A player or if a USB storage device is connected. The Vehicle Identification Number (VIN) number is a required in order to activate your vehicle.

Saving HDD Favorites

During HDD playback, press the FAV button to change between favorite modes. The following favorite modes are supported:

- Playlists
- Artists
- Albums
- Genres

Favorites can be saved by pressing and holding the pushbutton located under the favorites selection. Store your favorites according to the following table:

Favorites Display Mode	Action on Press-and-Hold
Playlist	Adds currently playing track to the playlist selected.
Artist	Saves the artist associated with the currently playing track in the indicated favorites position.
Album	Saves the album associated with the currently playing track in the indicated favorites position.
Genre	Saves the genre associated with the currently playing track in the indicated favorites position.

Configuring HDD Favorites

Press the CONFIG button to display the radio configuration options. Press the pushbutton under the HDD label to display the available favorite modes. Press the pushbutton under the favorite label to set the available favorite modes. Available favorite modes are highlighted.

Time-shifting — Pause and Rewind Live FM/AM and XM™ (if equipped)

The Radio with DVD Audio, HDD, and USB has the ability to rewind 60 minutes of FM/AM and XM (if equipped) content. While listening to the radio, the content from the current station is always being buffered to the HDD.

Press  (play/pause) To pause the radio. The radio display will show the Time Shift buffer status bar. The status bar shows the amount of content that is stored in the buffer and the current pause point.

To resume playback from the current pause point, press  again. The radio will no longer be playing “live” radio. Instead, time shifted content is being played from the buffer. When the radio is playing time shifted content from the buffer, a buffer status bar shows below the station number on the left side of screen.

Press and hold the REV or FWD buttons to rewind or fast forward through the time shift buffer. Hold FWD until the end of the currently recorded buffer to resume “live” radio playback. With “live” radio playing, the radio display will no longer show the buffer bar below the station number.

On AM/FM, press the REV or FWD button multiple times to rewind or fast forward. Each press will rewind or fast forward 30 seconds of content. On XM, press the REV or FWD button multiple time to jump to the previous or next song or commercial.

When the radio station is changed, the buffer is cleared and automatically restarted for the current station. You cannot rewind to content from a previously tuned station.

Time shifting of AM/FM or XM is not available while recording or while other sources of playback are selected.

Pausing AM/FM or XM™ (if equipped) with the Vehicle Turned Off

If AM/FM or XM is paused when the vehicle is turned off, the radio will continue to buffer the current radio station for up to one hour. If the vehicle is turned back on within one hour, the radio will automatically resume playback from the pause point.

Using the Auxiliary Input Jack

The radio system has an auxiliary input jack. It is in the center console bin. This is not an audio output; do not plug the headphone set into the front auxiliary input jack. An external audio device such as an iPod, laptop computer, MP3 player, etc. can be connected to the auxiliary input jack for use as another source for audio listening.

Set up any auxiliary device while the vehicle is stopped. See *Defensive Driving on page 4-2* for more information on driver distraction.

To use a portable audio player, connect a 3.5 mm (1/8 inch) cable to the radio’s front auxiliary input jack. The radio automatically detects the device and “Aux Input Device” displays. The device begins playing over the vehicle speakers. If an auxiliary device has already been connected, press the radio’s AUX or CD/AUX button.

VOL/  (Volume/Power): Turn clockwise or counterclockwise to increase or decrease the volume of the portable player. Use the portable device to make additional volume adjustments.

FM/AM: Press to listen to the radio when a portable audio device is playing. The portable audio device continues playing, until you stop it.

CD or CD/AUX (CD/Auxiliary): Press to play a CD when a portable audio device is playing. Press again to start playing audio from the connected portable audio player. If a portable audio player is not connected, “No Aux Device” displays.

Using the Radio Controls to Connect and Control Your iPod

You can control your iPod using the radio buttons and knobs and display your iPod song information on the radio's display. To connect and control your iPod using the radio controls, your vehicle must have a USB port. If it does, it is located in the center console bin. You will also need a special iPod connection cable that can be purchased with your vehicle or may be available after, from your dealer/retailer. See your dealer/retailer for more information.

This feature supports the following iPod models:

- Fifth generation or later iPod
- First or Second generation or later iPod Nano*

* For proper operation, make sure your iPod has the latest firmware from Apple®. Your iPod firmware can be updated using the latest iTunes application. See www.apple.com/itunes.

To connect and control your iPod, connect one end of the specially purchased iPod connection cable to the iPod's dock connector. Connect the other end to both the USB

port and the auxiliary input jack. The USB port and the auxiliary input jack are located in the center console bin. If the vehicle is on and the USB connection works, you will see a GM logo appear on your iPod. Your iPod music will display on your radio's display and begin playing through your vehicle radio system.

A standard iPod USB cable, like the one that came with your iPod, cannot be used to connect an iPod to your vehicle. You must use the iPod connection cable that was purchased with your vehicle or that was made available from your dealer/retailer in order for this feature to work.

Use the radio Menu/Select knob to bring up the iPod Menu and select Songs, Artists, Albums, Playlists and Audio books to play from your iPod.

Your iPod will charge while it is connected to your vehicle and if your vehicle is turned to ACC/ACCESSORY or ON/RUN. It can also be left connected to your vehicle while the vehicle is turned off or removed. With the vehicle turned off, the iPod will automatically be powered off and will not charge or draw power from the vehicle's battery.

If you have an older iPod model that is not supported or do not have the special iPod connection cable, you can still listen to your iPod in your vehicle by connecting it to the Auxiliary Input Jack using a standard 3.5 mm (1/8 inch) stereo cable. See “Using the Auxiliary Input Jack” earlier for more information.

Press the AM/FM, XM or HDD buttons to listen to one of these sources while an iPod is connected. If a disc is inserted, press the CD/AUX button to listen to a CD or DVD-A disc. Press the CD/AUX button again to start playing and controlling the connected iPod.

To properly dismount the iPod USB device before disconnecting from the vehicle, press the button directly under the EJECT label found on the iPod playback screen.

Using an MP3

MP3/WMA Format

The Single CD and the Six-Disc CD Radio will play MP3/WMA files that were recorded on a CD-R or CD-RW disc. The HDD Radio is similar and can also play MP3/WMA files recorded on DVD +/- R discs or a USB storage device.

The files can be recorded with the following fixed bit rates: 32 kbps, 40 kbps, 56 kbps, 64 kbps, 80 kbps, 96 kbps, 112 kbps, 128 kbps, 160 kbps, 192 kbps, 224 kbps, 256 kbps, and 320 kbps or a variable bit rate. Song title, artist name, and album can display when files are recorded using ID3 tags version 1 and 2.

Creating an MP3/WMA Disc

If you burn your own MP3/WMA disc on a personal computer:

- Make sure the MP3/WMA files are recorded on a CD-R or CD-RW disc.
- Do not mix standard audio and MP3/WMA files on one disc.
- Make sure the CD does not have more than a maximum of 50 folders and playlists, and 255 files to read and play.
- Create a folder structure that makes it easy to find songs while driving. Organize songs by albums using one folder for each album. Each folder or album should contain 18 songs or less.
- Avoid subfolders. The system can support up to 8 subfolders deep, keep the total number of folders to a minimum to reduce the complexity and confusion during playback.
- Make sure playlists have a .mp3 or .wpl extension (other file extensions may not work).

- Minimize the length of the file, folder or playlist names. Long file, folder, or playlist names, or a combination of a large number of files and folders, or playlists can cause the player to be unable to play up to the maximum number of files, folders, playlists, or sessions.
- Finalize the audio disc before burning it. Adding music to an existing disc can cause the disc not to function.

Playlists can be selected by using the previous and next folder buttons, the SEEK arrows, **▷▷** FWD, or **◀◀** REV buttons. An MP3/WMA CD-R or CD-RW that was recorded using no file folders can also be played. If a CD-R or CD-RW contains more than the maximum of 50 folders and playlists, and 255 files, the player lets you access and navigate up to the maximum, but all items over the maximum are not accessible.

The HDD Radio can support more than 255 files on an MP3/WMA disc.

The HDD Radio does not support playlists on a disc or USB storage device.

Root Directory

The root directory of the CD-R or CD-RW is treated as a folder. If the root directory has compressed audio files, the directory displays as F1 DISC. All files

contained directly under the root directory are accessed prior to any root directory folders. Playlists (Px) are always accessed after root folders or files.

The HDD Radio displays the root directory of an MP3/WMA disc as F1 MP3 and the root directory of a USB storage device as F1 USB.

Empty Directory or Folder

If a root directory or a folder exists somewhere in the file structure that contains only folders/subfolders and no compressed files directly beneath them, the player advances to the next folder in the file structure that contains compressed audio files.

No Folder

When the CD contains only compressed files, the files are located under the root folder. The next and previous folder functions do not display on a CD that was recorded without folders or playlists. The radio displays F1 DISC for the root directory.

When the CD contains only playlists and compressed audio files, but no folders, all files are located under the root folder. The folder down and the folder up buttons search playlists (Px) first and then goes to the root folder. The radio displays F1 DISC for the root directory.

Order of Play

Tracks recorded to the CD-R or CD-RW play in the following order:

- Play begins from the first track in the first folder and continues sequentially through all tracks in each folder. When the last track of the last folder has played, play continues from the first track of the first playlist.
 - Playlists can be changed by pressing the next and previous folder button.
- Play begins from the first track in the first playlist and continues sequentially through all tracks in each playlist. When the last track of the last playlist has played, play continues from the first track of the first folder.

When play enters a new folder, the display does not automatically show the new folder name unless the folder mode has been chosen as the default display. The new track name displays.

File System and Naming

The song name displays the song name that is contained in the ID3 tag. If the song name is not in the ID3 tag, the radio displays the file name without the extension.

Track names longer than 32 characters are shortened. Parts of words on the last page of text and the extension of the filename is not displayed.

The HDD Radio will display file names with the extension.

Preprogrammed Playlists

Preprogrammed playlists that were created using WinAmp™, MusicMatch™, or Real Jukebox™ software can be accessed, however they cannot be edited using the radio. These playlists are special folders containing compressed audio song files. Playlists must have a file extension of PLS or M3U.

Playlists can be selected using the previous and next folder buttons. Tracks can be changed by pressing the seek buttons or turning the tune knob. Songs are played sequentially; press the ◀◀ REV or ▶▶ FWD to reverse or advance through the playing song.

The HDD Radio does not support preprogrammed playlists. To create a playlist on the HDD radio from songs recorded to the HDD, see “Saving HDD Favorites” earlier in this section.

Playing an MP3/WMA

Insert a CD partway into the slot (Single CD Player), or press the load button and wait for the message to insert disc (Six-Disc CD Player), label side up. The player pulls in the CD and should begin playing.

For the Single CD Player, the track number displays at the left and center of the screen. A Shuffle label appears below. Press the pushbutton located under the Shuffle label to play the MP3/WMA files of the CD in random order.



For the Six-Disc CD Player, the disc number displays at the upper right side of the screen. The track number displays at the left and center of the screen. The Shuffle, Disc, and Folder labels appear below. Press the pushbutton located under the Shuffle label to play the MP3/WMA files of the currently selected CD in random order. Press the pushbuttons located under the Disc or Folder labels to change to another disc or folder.

As each new track starts to play, the track number and song title displays.

 **(Eject):** Press to eject a CD. If the CD is not removed, after several seconds, the CD automatically pulls back into the player and begins playing.

For the Six-Disc CD player, press and hold this button for two seconds to eject all discs.

TUNE/TONE: Turn to select MP3/WMA files on the CD playing.

 **SEEK**  : Press the left arrow to go to the start of the current MP3/WMA file, if more than five seconds have played. Press the right arrow to go to the next MP3/WMA file. If either arrow is held or pressed multiple times, the player continues moving backward or forward through MP3/WMA files on the CD.

 **(Previous Folder):** Press the pushbutton under the Folder label to go to the first track in the previous folder.

 **(Next Folder):** Press the pushbutton under the Folder label to go to the first track in the next folder.

 **REV (Reverse):** Press and hold to reverse playback quickly within an MP3/WMA file. Sound is heard at a reduced volume. The elapsed time of the file displays. Release to resume playing the file.

 **FWD (Fast Forward):** Press and hold to advance playback quickly within an MP3/WMA file. Sound is heard at a reduced volume. The elapsed time of the file displays. Release to resume playing the file.

Shuffle: With the shuffle setting, MP3/WMA files on the CD can be played in random, rather than sequential order, on the CD currently playing. To use shuffle:

- To play MP3/WMA files from the CD in random order, press the pushbutton under the Shuffle label until Shuffle On displays. Press again to turn shuffle off.

XM Radio Messages

xL (Explicit Language Channels): These channels, or any others, can be blocked at a customer's request, by calling 1-800-852-XXMX (9696).

XM Updating: The encryption code in the receiver is being updated, and no action is required. This process should take no longer than 30 seconds.

No XM Signal: The system is functioning correctly, but the vehicle is in a location that is blocking the XM™ signal. When the vehicle is moved into an open area, the signal should return.

Loading XM: The audio system is acquiring and processing audio and text data. No action is needed. This message should disappear shortly.

Channel Off Air: This channel is not currently in service. Tune in to another channel.

Channel Unavail: This previously assigned channel is no longer assigned. Tune to another station. If this station was one of the presets, choose another station for that preset button.

No Info: No artist, song title, category, or text information is available at this time on this channel. The system is working properly.

NotFound: There are no channels available for the selected category. The system is working properly.

Radio ID: If tuned to channel 0, this message will alternate with the XM Radio 8 digit radio ID label. This label is needed to activate the service.

Unknown: If this message is received when tuned to channel 0, there may be a receiver fault. Consult with your dealer/retailer.

Check XM: If this message does not clear within a short period of time, the receiver may have a fault. Consult with your dealer/retailer.

Navigation/Radio System

Your vehicle may have a navigation radio system.

The navigation system has built-in features intended to minimize driver distraction. Technology alone, no matter how advanced, can never replace your own judgment. See the Navigation System manual for some tips to help you reduce distractions while driving.

Theft-Deterrent Feature

THEFTLOCK® is designed to discourage theft of your vehicle's radio. The feature works automatically by learning a portion of the Vehicle Identification Number (VIN). If the radio is moved to a different vehicle, it does not operate and LOC, LOCK, or LOCKED could display.

With THEFTLOCK® activated, the radio does not operate if stolen.

Audio Steering Wheel Controls

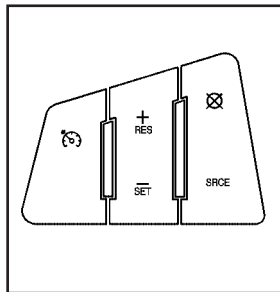

Left-Side Steering Wheel Controls

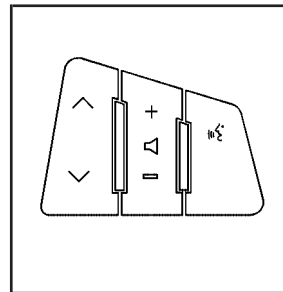



Right-Side Steering Wheel Controls

Some audio controls can be adjusted at the steering wheel. They include the following:

SRCE (Source): Press this button to switch between the radio AM, FM, XM™ (if equipped), CD, HDD (if available), auxiliary input jack (if connected), USB and iPod (if available and connected).

^ v (Previous/Next): Press the previous or the next arrow to go to the previous or to the next radio station stored as a favorite.

When a CD is playing, press either arrow to go to the previous or to the next track.

+  –  (**Volume**): Press the plus or minus volume button to increase or to decrease the volume.

 (**Mute/Speech Recognition**): Press and release this button to silence the vehicle speakers only. The audio of the wireless and wired headphones, if your vehicle has these features, does not mute. Press and release this button again, to turn the sound on.

If your vehicle has the navigation system, press and hold this button for longer than one second to initiate speech recognition. See “Speech Recognition” in the Navigation System manual for more information.

If your vehicle has OnStar[®], press and hold this button for longer than one second to interact with the OnStar[®] system. If your vehicle also has the navigation system, press and hold this button for longer than one second to initiate speech recognition and say “OnStar” to enter OnStar[®] mode. See the *OnStar[®] System on page 2-53* in this manual for more information.

Radio Reception

Frequency interference and static can occur during normal radio reception if items such as cell phone chargers, vehicle convenience accessories, and external electronic devices are plugged into the accessory power outlet. If there is interference or static, unplug the item from the accessory power outlet.

AM

The range for most AM stations is greater than for FM, especially at night. The longer range can cause station frequencies to interfere with each other. For better radio reception, most AM radio stations boost the power levels during the day, and then reduce these levels during the night. Static can also occur when things like storms and power lines interfere with radio reception. When this happens, try reducing the treble on your radio.

FM Stereo

FM stereo gives the best sound, but FM signals reach only about 10 to 40 miles (16 to 65 km). Tall buildings or hills can interfere with FM signals, causing the sound to fade in and out.

XM[™] Satellite Radio Service

XM[™] Satellite Radio Service gives digital radio reception from coast-to-coast in the 48 contiguous United States, and in Canada. Just as with FM, tall buildings or hills can interfere with satellite radio signals, causing the sound to fade in and out. In addition, traveling or standing under heavy foliage, bridges, garages, or tunnels may cause loss of XM signal for a period of time. The radio may display No XM Signal to indicate interference.

Cellular Phone Usage

Cellular phone usage may cause interference with your vehicle's radio. This interference may occur when making or receiving phone calls, charging the phone's battery, or simply having the phone on. This interference causes an increased level of static while listening to the radio. If static is received while listening to the radio, unplug the cellular phone and turn it off.

Backglass Antenna

The AM-FM antenna is integrated with the rear window defogger, located in the rear window. Make sure that the inside surface of the rear window is not scratched and that the grid lines on the glass are not damaged. If the inside surface is damaged, it could interfere with radio reception.

Notice: Using a razor blade or sharp object to clear the inside rear window may damage the rear window antenna and/or the rear window defogger. Repairs would not be covered by your warranty. Do not clear the inside rear window with sharp objects.

Notice: Do not apply aftermarket glass tinting with metallic film. The metallic film in some tinting materials will interfere with or distort the incoming radio reception. Any damage caused to your backglass antenna due to metallic tinting materials will not be covered by your warranty.

Because this antenna is built into the rear window, there is a reduced risk of damage caused by car washes and vandals.

XM™ Satellite Radio Antenna System

The XM™ Satellite Radio antenna is located on the roof of your vehicle. Keep this antenna clear of snow and ice build up for clear radio reception.

If your vehicle has a sunroof, the performance of the XM™ system may be affected if the sunroof is open.

Loading items onto the roof of your vehicle can interfere with the performance of the XM™ system. Make sure the XM™ Satellite Radio antenna is not obstructed.

Section 4 Driving Your Vehicle

Your Driving, the Road, and Your Vehicle	4-2	Competitive Driving	4-14
Defensive Driving	4-2	Driving at Night	4-14
Drunk Driving	4-2	Driving in Rain and on Wet Roads	4-15
Control of a Vehicle	4-3	Before Leaving on a Long Trip	4-16
Braking	4-3	Highway Hypnosis	4-16
Antilock Brake System (ABS)	4-4	Hill and Mountain Roads	4-17
Braking in Emergencies	4-5	Winter Driving	4-18
Traction Control System (TCS)	4-6	If Your Vehicle is Stuck in Sand, Mud, Ice, or Snow	4-21
Limited-Slip Rear Axle	4-8	Rocking Your Vehicle to Get It Out	4-22
StabiliTrak® System	4-8	Loading Your Vehicle	4-22
Panic Brake Assist	4-9	Towing	4-27
All-Wheel Drive (AWD) System	4-9	Towing Your Vehicle	4-27
Steering	4-9	Recreational Vehicle Towing	4-27
Off-Road Recovery	4-12	Towing a Trailer	4-29
Passing	4-12		
Loss of Control	4-13		

Your Driving, the Road, and Your Vehicle

Defensive Driving

Defensive driving means “always expect the unexpected.” The first step in driving defensively is to wear your safety belt — See *Safety Belts: They Are for Everyone* on page 1-12.

CAUTION:

Assume that other road users (pedestrians, bicyclists, and other drivers) are going to be careless and make mistakes. Anticipate what they might do and be ready. In addition:

- **Allow enough following distance between you and the driver in front of you.**
- **Focus on the task of driving.**

Driver distraction can cause collisions resulting in injury or possible death. These simple defensive driving techniques could save your life.

Drunk Driving

CAUTION:

Drinking and then driving is very dangerous. Your reflexes, perceptions, attentiveness, and judgment can be affected by even a small amount of alcohol. You can have a serious — or even fatal — collision if you drive after drinking. Do not drink and drive or ride with a driver who has been drinking. Ride home in a cab; or if you are with a group, designate a driver who will not drink.

Death and injury associated with drinking and driving is a global tragedy.

Alcohol affects four things that anyone needs to drive a vehicle: judgment, muscular coordination, vision, and attentiveness.

Police records show that almost 40 percent of all motor vehicle-related deaths involve alcohol. In most cases, these deaths are the result of someone who was drinking and driving. In recent years, more than 17,000 annual motor vehicle-related deaths have been associated with the use of alcohol, with about 250,000 people injured.

For persons under 21, it is against the law in every U.S. state to drink alcohol. There are good medical, psychological, and developmental reasons for these laws.

The obvious way to eliminate the leading highway safety problem is for people never to drink alcohol and then drive.

Medical research shows that alcohol in a person's system can make crash injuries worse, especially injuries to the brain, spinal cord, or heart. This means that when anyone who has been drinking — driver or passenger — is in a crash, that person's chance of being killed or permanently disabled is higher than if the person had not been drinking.

Control of a Vehicle

The following three systems help to control your vehicle while driving — brakes, steering, and accelerator. At times, as when driving on snow or ice, it is easy to ask more of those control systems than the tires and road can provide. Meaning, you can lose control of your vehicle. See *Traction Control System (TCS)* on page 4-6.

Adding non-dealer/non-retailer accessories can affect your vehicle's performance. See *Accessories and Modifications* on page 5-3.

Braking

See *Brake System Warning Light* on page 3-37.

Braking action involves perception time and reaction time. First, you have to decide to push on the brake pedal. That is perception time. Then you have to bring up your foot and do it. That is reaction time.

Average reaction time is about three-fourths of a second. But that is only an average. It might be less with one driver and as long as two or three seconds or more with another. Age, physical condition, alertness, coordination, and eyesight all play a part. So do alcohol, drugs, and frustration. But even in three-fourths of a second, a vehicle moving at 60 mph (100 km/h) travels 66 feet (20 m). That could be a lot of distance in an emergency, so keeping enough space between your vehicle and others is important.

And, of course, actual stopping distances vary greatly with the surface of the road, whether it is pavement or gravel; the condition of the road, whether it is wet, dry, or icy; tire tread; the condition of the brakes; the weight of the vehicle; and the amount of brake force applied.

Avoid needless heavy braking. Some people drive in spurts — heavy acceleration followed by heavy braking — rather than keeping pace with traffic. This is a mistake. The brakes might not have time to cool between hard stops. The brakes will wear out much faster if you do a lot of heavy braking. If you keep pace with the traffic and allow realistic following distances, you will eliminate a lot of unnecessary braking. That means better braking and longer brake life.

If your vehicle's engine ever stops while you are driving, brake normally but do not pump the brakes. If you do, the pedal could get harder to push down. If the engine stops, you will still have some power brake assist. But you will use it when you brake. Once the power assist is used up, it can take longer to stop and the brake pedal will be harder to push.

Adding non-dealer/non-retailer accessories can affect your vehicle's performance. See *Accessories and Modifications on page 5-3*.

Antilock Brake System (ABS)

Your vehicle has the Antilock Brake System (ABS), an advanced electronic braking system that will help prevent a braking skid.

When you start the engine and begin to drive away, ABS will check itself. You might hear a momentary motor or clicking noise while this test is going on, and you might even notice that the brake pedal moves a little. This is normal.

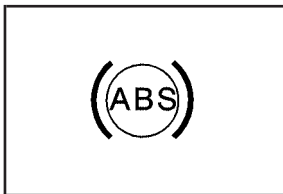

If there is a problem with ABS, this warning light will stay on. See *Antilock Brake System Warning Light* on page 3-38.

Let us say the road is wet and you are driving safely. Suddenly, an animal jumps out in front of you. You slam on the brakes and continue braking. Here is what happens with ABS:

A computer senses that wheels are slowing down. If one of the wheels is about to stop rolling, the computer will separately work the brakes at each wheel.

ABS can change the brake pressure faster than any driver could. The computer is programmed to make the most of available tire and road conditions. This can help you steer around the obstacle while braking hard.

As you brake, the computer keeps receiving updates on wheel speed and controls braking pressure accordingly.

Remember: ABS does not change the time you need to get your foot up to the brake pedal or always decrease stopping distance. If you get too close to the vehicle in front of you, you will not have time to apply the brakes if that vehicle suddenly slows or stops. Always leave enough room up ahead to stop, even though you have ABS.

Using ABS

Do not pump the brakes. Just hold the brake pedal down firmly and let antilock work for you. You might hear the antilock pump or motor operate, and feel the brake pedal pulsate, but this is normal.

Braking in Emergencies

With ABS, you can steer and brake at the same time. In many emergencies, steering can help you more than even the very best braking.

Traction Control System (TCS)

Your vehicle has a Traction Control System (TCS) that limits wheel spin. This is especially useful in slippery road conditions. It will activate and the TCS/StabiliTrak[®] light will flash if it senses that any of the wheels are spinning or beginning to lose traction while driving. When this happens, the system applies the brake to the spinning wheel(s) and/or reduces engine power to limit wheel spin. The TCS/StabiliTrak[®] warning light will flash when the traction control system is limiting wheel spin.

You may feel or hear the system working, but this is normal.

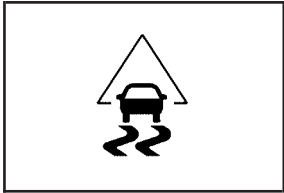

This warning light will flash if there is a problem with the traction control system.

See *Traction Control System (TCS)/StabiliTrak[®] Warning Light* on page 3-38 and *StabiliTrak[®] System* on page 4-8. When the TCS/StabiliTrak[®] warning light is on, the system will not limit wheel spin. Adjust your driving accordingly.

TCS automatically comes on whenever vehicle is started. To limit wheel spin, especially in slippery road conditions, you should always leave the system on. But the TCS should be turned off if your vehicle ever gets stuck in sand, mud or snow and rocking the vehicle is required. Also, turn the TCS off while in deep snow or on loose gravel, to assist vehicle motion at lower speeds. See *Rocking Your Vehicle to Get It Out* on page 4-22 for more information. See also *Winter Driving* on page 4-18 for information on using TCS when driving in snowy or icy conditions.

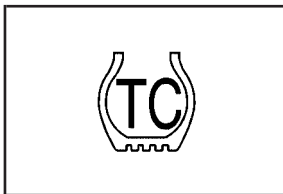

Press the TC (Traction Control) button, located on the instrument panel, to turn the system off.

If you press the TC button once, the traction control system will turn off and the Traction Control System (TCS) Warning Light will flash. Press the TC button again to turn the system back on. Press and hold the TC button for five seconds or longer, to turn the StabiliTrak[®] system off. The TCS/StabiliTrak[®] warning light will flash. Press the TC button again to turn StabiliTrak[®] back on. For more information, see *StabiliTrak[®] System on page 4-8*.

Adding non-dealer/non-retailer accessories can affect your vehicle's performance. See *Accessories and Modifications on page 5-3* for more information.

Competitive Driving Mode

Press the TC button quickly two times to select this optional handling mode. The StabiliTrak[®] Competitive Mode message displays in the Driver Information Center (DIC). While in the StabiliTrak[®] Competitive Mode, TCS does not operate, and the TCS warning light comes on. Adjust your driving accordingly.

Press the TC button again, or turn the ignition to ACC/ACCESSORY, to turn the TCS back on and the TCS warning light off.

Notice: When traction control is turned off, or Competitive Driving Mode is active, it is possible to lose traction. If you attempt to shift with the rear wheels spinning with a loss of traction, it is possible to cause damage to the transmission. Do not attempt to shift when the rear wheels do not have traction. Damage caused by misuse of the vehicle is not covered. See your warranty book for additional information.

Limited-Slip Rear Axle

Your vehicle may have this feature. A limited-slip rear axle can give you additional traction on snow, mud, ice, sand or gravel. It works like a standard axle most of the time, but when one of the rear wheels has no traction and the other does, this feature will allow the wheel with traction to move the vehicle.

StabiliTrak[®] System

Your vehicle has an electronic stability control system called StabiliTrak[®]. It is an advanced computer controlled system that assists with directional control of the vehicle in difficult driving conditions.

StabiliTrak[®] activates when the computer senses a discrepancy between your intended path and the direction the vehicle is actually traveling. StabiliTrak[®] selectively applies braking pressure at any one of the vehicle's brakes to help steer the vehicle in the direction which you are steering.

When the system activates, the Traction Control System (TCS)/StabiliTrak[®] warning light on the instrument panel cluster flashes. You may also hear a noise or feel vibration in the brake pedal. This is normal. Continue to steer the vehicle in the direction you want it to go.

If there is a problem detected with StabiliTrak[®], a Service Stability System message displays on the Driver Information Center (DIC) and the TCS/StabiliTrak[®] warning light flashes on the instrument panel cluster. When this message and warning light displays, the system is not operational. Driving should be adjusted accordingly. See *DIC Warnings and Messages on page 3-54* and *Warning Lights, Gages, and Indicators on page 3-29* for more information.

StabiliTrak[®] comes on automatically whenever the vehicle is started. The system should be left on to help assist with directional control of the vehicle. If StabiliTrak[®] needs to be turned off, press the TC (traction control) on/off button. See *Traction Control System (TCS) on page 4-6*.

If cruise control is being used when the StabiliTrak[®] activates, the cruise control will automatically disengage. When road conditions allow, reengage the cruise control. See *Cruise Control on page 3-13* for more information.

Panic Brake Assist

Your vehicle has a panic brake assist system that monitors the intention of the driver while braking. If the system senses that the driver has applied hard/fast pressure to the brake pedal, the system will generate additional pressure, making it easier for the driver to maintain brake application. When this happens the brake pedal will feel easier to push. Just hold the brake pedal down firmly and let the system work for you. You may feel the brakes vibrate, or you may notice some noise but this is normal. The brakes will return to normal operation after the brake pedal has been released.

All-Wheel Drive (AWD) System

If your vehicle has this feature, engine power is sent to all four wheels when needed. During normal driving conditions the vehicle will operate in 2WD mode. When the system senses a loss of traction the vehicle will automatically change to AWD mode.

If you have the spare tire on the vehicle, there may be a reduction in performance of the AWD system.

Steering

Power Steering

If you lose power steering assist because the engine stops or the system is not functioning, you can steer but it will take much more effort.

Speed Variable Assist Steering

Your vehicle has a steering system that varies the amount of effort required to steer the vehicle in relation to the speed of the vehicle.

The amount of steering effort required is less at slower speeds to make the vehicle more maneuverable and easier to park. At faster speeds, the steering effort increases to provide a sport-like feel to the steering. This provides maximum control and stability.

If your vehicle seems harder to steer than normal when parking or driving slowly, there may be a problem with the system. You will still have power steering, but steering will be stiffer than normal at slow speeds. See your dealer/retailer for service.

Steering Tips

It is important to take curves at a reasonable speed.

A lot of the “driver lost control” accidents mentioned on the news happen on curves. Here is why:

Experienced driver or beginner, each of us is subject to the same laws of physics when driving on curves.

The traction of the tires against the road surface makes it possible for the vehicle to change its path when you turn the front wheels. If there is no traction, inertia will keep the vehicle going in the same direction. If you have ever tried to steer a vehicle on wet ice, you will understand this.

The traction you can get in a curve depends on the condition of the tires and the road surface, the angle at which the curve is banked, and your speed. While you are in a curve, speed is the one factor you can control.

Suppose you are steering through a sharp curve. Then you suddenly accelerate. Both control systems — steering and acceleration — have to do their work where the tires meet the road. Adding the sudden acceleration can demand too much of those places. You can lose control. See *Traction Control System (TCS)* on page 4-6.

What should you do if this ever happens? Ease up on the accelerator pedal, steer the vehicle the way you want it to go, and slow down.

Speed limit signs near curves warn that you should adjust your speed. Of course, the posted speeds are based on good weather and road conditions. Under less favorable conditions you will want to go slower.

If you need to reduce your speed as you approach a curve, do it before you enter the curve, while the front wheels are straight ahead.

Try to adjust your speed so you can drive through the curve. Maintain a reasonable, steady speed. Wait to accelerate until you are out of the curve, and then accelerate gently into the straightaway.

Adding non-dealer/non-retailer accessories can affect your vehicle's performance. See *Accessories and Modifications* on page 5-3.

Steering in Emergencies

There are times when steering can be more effective than braking. For example, you come over a hill and find a truck stopped in your lane, or a car suddenly pulls out from nowhere, or a child darts out from between parked cars and stops right in front of you. You can avoid these problems by braking — if you can stop in time. But sometimes you cannot; there is not room. That is the time for evasive action — steering around the problem.

Your vehicle can perform very well in emergencies like these. First apply the brakes. See *Braking on page 4-3*. It is better to remove as much speed as you can from a possible collision. Then steer around the problem, to the left or right depending on the space available.

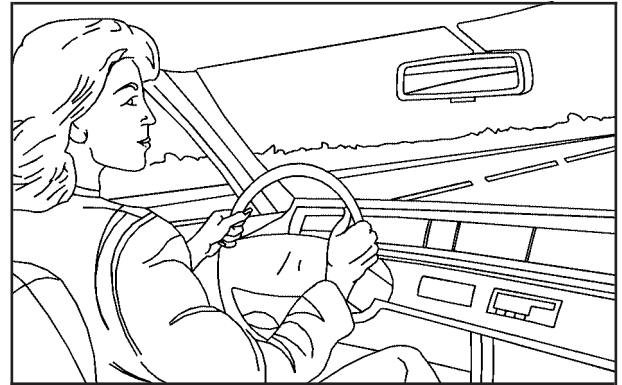

An emergency like this requires close attention and a quick decision. If you are holding the steering wheel at the recommended 9 and 3 o'clock positions, you can turn it a full 180 degrees very quickly without removing either hand. But you have to act fast, steer quickly, and just as quickly straighten the wheel once you have avoided the object.

The fact that such emergency situations are always possible is a good reason to practice defensive driving at all times and wear safety belts properly.

Off-Road Recovery

You may find that your vehicle's right wheels have dropped off the edge of a road onto the shoulder while you are driving.

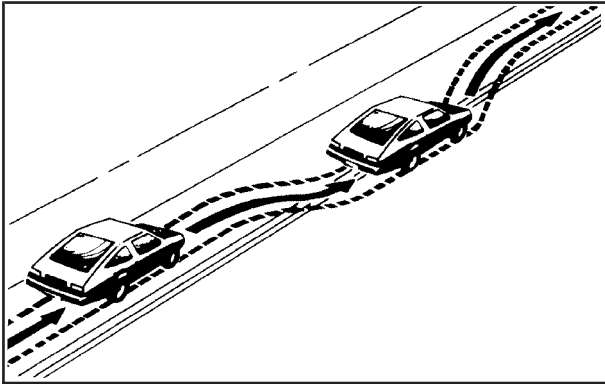

If the level of the shoulder is only slightly below the pavement, recovery should be fairly easy. Ease off the accelerator and then, if there is nothing in the way, steer so that your vehicle straddles the edge of the pavement. You can turn the steering wheel up to one-quarter turn until the right front tire contacts the pavement edge. Then turn the steering wheel to go straight down the roadway.

Passing

Passing another vehicle on a two-lane road can be dangerous. To reduce the risk of danger while passing, we suggest the following tips:

- Look down the road, to the sides, and to crossroads for situations that might affect a successful pass. If in doubt, wait.
- Watch for traffic signs, pavement markings, and lines that could indicate a turn or an intersection. Never cross a solid or double-solid line on your side of the lane.
- Do not get too close to the vehicle you want to pass. Doing so can reduce your visibility.
- Wait your turn to pass a slow vehicle.
- When you are being passed, ease to the right.

Loss of Control

Let us review what driving experts say about what happens when the three control systems — brakes, steering, and acceleration — do not have enough friction where the tires meet the road to do what the driver has asked.

In any emergency, do not give up. Keep trying to steer and constantly seek an escape route or area of less danger.

Skidding

In a skid, a driver can lose control of the vehicle. Defensive drivers avoid most skids by taking reasonable care suited to existing conditions, and by not overdriving those conditions. But skids are always possible.

The three types of skids correspond to your vehicle's three control systems. In the braking skid, the wheels are not rolling. In the steering or cornering skid, too much speed or steering in a curve causes tires to slip and lose cornering force. And in the acceleration skid, too much throttle causes the driving wheels to spin.

A cornering skid is best handled by easing your foot off the accelerator pedal.

Remember: Any traction control system helps avoid only the acceleration skid. If your traction control system is off, then an acceleration skid is also best handled by easing your foot off the accelerator pedal.

If your vehicle starts to slide, ease your foot off the accelerator pedal and quickly steer the way you want the vehicle to go. If you start steering quickly enough, your vehicle may straighten out. Always be ready for a second skid if it occurs.

Of course, traction is reduced when water, snow, ice, gravel, or other material is on the road. For safety, you will want to slow down and adjust your driving to these conditions. It is important to slow down on slippery surfaces because stopping distance will be longer and vehicle control more limited.

While driving on a surface with reduced traction, try your best to avoid sudden steering, acceleration, or braking, including reducing vehicle speed by shifting to a lower gear. Any sudden changes could cause the tires to slide. You may not realize the surface is slippery until your vehicle is skidding. Learn to recognize warning clues — such as enough water, ice, or packed snow on the road to make a mirrored surface — and slow down when you have any doubt.

Remember: Any Antilock Brake System (ABS) helps avoid only the braking skid.

Competitive Driving

See your warranty book before using your vehicle for competitive driving.

Notice: If you use your vehicle for competitive driving, the engine may use more oil than it would with normal use. Low oil levels can damage the engine. Be sure to check the oil level often during competitive driving and keep the level at or near the upper mark that shows the proper operating range on the engine oil dipstick. For information on how to add oil, see *Engine Oil on page 5-16*.

Driving at Night

Night driving is more dangerous than day driving because some drivers are likely to be impaired — by alcohol or drugs, with night vision problems, or by fatigue.

Night driving tips include:

- Drive defensively.
- Do not drink and drive.
- Reduce headlamp glare by adjusting the inside rearview mirror.
- Slow down and keep more space between you and other vehicles because your headlamps can only light up so much road ahead.
- Watch for animals.
- When tired, pull off the road.
- Do not wear sunglasses.
- Avoid staring directly into approaching headlamps.
- Keep the windshield and all glass on your vehicle clean — inside and out.
- Keep your eyes moving, especially during turns or curves.

No one can see as well at night as in the daytime. But, as we get older, these differences increase. A 50-year-old driver might need at least twice as much light to see the same thing at night as a 20-year-old.

Driving in Rain and on Wet Roads

Rain and wet roads can reduce vehicle traction and affect your ability to stop and accelerate. Always drive slower in these types of driving conditions and avoid driving through large puddles and deep-standing or flowing water.

CAUTION:

Wet brakes can cause crashes. They might not work as well in a quick stop and could cause pulling to one side. You could lose control of the vehicle.

After driving through a large puddle of water or a car/vehicle wash, lightly apply the brake pedal until the brakes work normally.

CAUTION: (Continued)

CAUTION: (Continued)

Flowing or rushing water creates strong forces. Driving through flowing water could cause your vehicle to be carried away. If this happens, you and other vehicle occupants could drown. Do not ignore police warnings and be very cautious about trying to drive through flowing water.

Hydroplaning

Hydroplaning is dangerous. Water can build up under your vehicle's tires so they actually ride on the water. This can happen if the road is wet enough and you are going fast enough. When your vehicle is hydroplaning, it has little or no contact with the road.

There is no hard and fast rule about hydroplaning. The best advice is to slow down when the road is wet.

Other Rainy Weather Tips

Besides slowing down, other wet weather driving tips include:

- Allow extra following distance.
- Pass with caution.
- Keep windshield wiping equipment in good shape.
- Keep the windshield washer fluid reservoir filled.
- Have good tires with proper tread depth. See *Tires* on page 5-59.

Before Leaving on a Long Trip

To prepare your vehicle for a long trip, consider having it serviced by your dealer/retailer before departing.

Things to check on your own include:

- *Windshield Washer Fluid*: Reservoir full? Windows clean — inside and outside?
- *Wiper Blades*: In good shape?
- *Fuel, Engine Oil, Other Fluids*: All levels checked?

- *Lamps*: Do they all work and are lenses clean?
- *Tires*: Are treads good? Are tires inflated to recommended pressure?
- *Weather and Maps*: Safe to travel? Have up-to-date maps?

Highway Hypnosis

Always be alert and pay attention to your surroundings while driving. If you become tired or sleepy, find a safe place to park your vehicle and rest.

Other driving tips include:

- Keep the vehicle well ventilated.
- Keep interior temperature cool.
- Keep your eyes moving — scan the road ahead and to the sides.
- Check the rearview mirror and vehicle instruments often.

Hill and Mountain Roads

Driving on steep hills or through mountains is different than driving on flat or rolling terrain. Tips for driving in these conditions include:

- Keep your vehicle serviced and in good shape.
- Check all fluid levels and brakes, tires, cooling system, and transmission.
- Going down steep or long hills, shift to a lower gear.

CAUTION:

If you do not shift down, the brakes could get so hot that they would not work well. You would then have poor braking or even none going down a hill. You could crash. Shift down to let the engine assist the brakes on a steep downhill slope.

CAUTION:

Coasting downhill in NEUTRAL (N) or with the ignition off is dangerous. The brakes will have to do all the work of slowing down and they could get so hot that they would not work well. You would then have poor braking or even none going down a hill. You could crash. Always have the engine running and your vehicle in gear when you go downhill.

- Stay in your own lane. Do not swing wide or cut across the center of the road. Drive at speeds that let you stay in your own lane.
- Top of hills: Be alert — something could be in your lane (stalled car, accident).
- Pay attention to special road signs (falling rocks area, winding roads, long grades, passing or no-passing zones) and take appropriate action.

Winter Driving

Here are some tips for winter driving:

- Have your vehicle in good shape for winter.
- You might want to put winter emergency supplies in your trunk.

Include an ice scraper, a small brush or broom, a supply of windshield washer fluid, a rag, some winter outer clothing, a small shovel, a flashlight, a red cloth, and a couple of reflective warning triangles. And, if you will be driving under severe conditions, include a small bag of sand, a piece of old carpet, or a couple of burlap bags to help provide traction. Be sure you properly secure these items in your vehicle.

Also see *Tires* on page 5-59.

Driving on Snow or Ice

Most of the time, those places where the tires meet the road probably have good traction.

However, if there is snow or ice between the tires and the road, you can have a very slippery situation. You have a lot less traction, or grip, and need to be very careful.



What is the worst time for this? Wet ice. Very cold snow or ice can be slick and hard to drive on. But wet ice can be even more trouble because it can offer the least traction of all. You can get wet ice when it is about freezing, 32°F (0°C), and freezing rain begins to fall. Try to avoid driving on wet ice until salt and sand crews can get there.

Whatever the condition — smooth ice, packed, blowing, or loose snow — drive with caution.

The Traction Control System (TCS) improves your ability to accelerate when driving on a slippery road. Even though you have TCS, slow down and adjust your driving to the road conditions. Under certain conditions, you might want to turn the TCS off, such as when driving through deep snow and loose gravel, to help maintain vehicle motion at lower speeds. See *Traction Control System (TCS) on page 4-6*. Also see *StabiliTrak® System on page 4-8*, *If Your Vehicle is Stuck in Sand, Mud, Ice, or Snow on page 4-21*, and “Winter Tires” under *Tires on page 5-59*.

The Antilock Brake System (ABS) improves your vehicle’s stability when you make a hard stop on a slippery road. Even though you have ABS, begin stopping sooner than you would on dry pavement. See *Antilock Brake System (ABS) on page 4-4*.

- Allow greater following distance on any slippery road.
- Watch for slippery spots. The road might be fine until you hit a spot that is covered with ice. On an otherwise clear road, ice patches can appear in shaded areas where the sun cannot reach, such as around clumps of trees, behind buildings, or under bridges. Sometimes the surface of a curve or an overpass can remain icy when the surrounding roads are clear. If you see a patch of ice ahead of you, brake before you are on it. Try not to brake while you are actually on the ice, and avoid sudden steering maneuvers.

If You Are Caught in a Blizzard

If you are stopped by heavy snow, you could be in a serious situation. You should probably stay with your vehicle unless you know for sure that you are near help and you can hike through the snow. Here are some things to do to summon help and keep yourself and your passengers safe:

- Turn on the hazard warning flashers.
- Tie a red cloth to your vehicle to alert police that you have been stopped by the snow.
- Put on extra clothing or wrap a blanket around you. If you do not have blankets or extra clothing, make body insulators from newspapers, burlap bags, rags, floor mats — anything you can wrap around yourself or tuck under your clothing to keep warm.

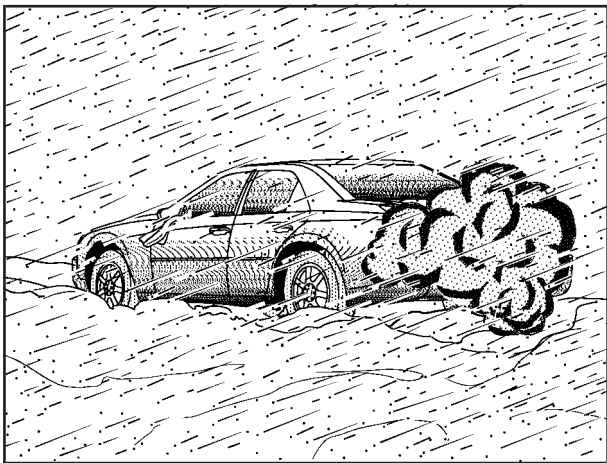

You can run the engine to keep warm, but be careful.

⚠ CAUTION:

Snow can trap exhaust gases under your vehicle. This can cause deadly CO (carbon monoxide) gas to get inside. CO could overcome you and kill you. You cannot see it or smell it, so you might not know it is in your vehicle. Clear away snow from around the base of your vehicle, especially any that is blocking the exhaust pipe. And check around again from time to time to be sure snow does not collect there.

Open a window just a little on the side of the vehicle that is away from the wind. This will help keep CO out.

Run your engine only as long as you must. This saves fuel. When you run the engine, make it go a little faster than just idle. That is, push the accelerator slightly. This uses less fuel for the heat that you get and it keeps the battery charged. You will need a well-charged battery to restart the vehicle, and possibly for signaling later on with the headlamps. Let the heater run for a while.

Then, shut the engine off and close the window almost all the way to preserve the heat. Start the engine again and repeat this only when you feel really uncomfortable from the cold. But do it as little as possible. Preserve the fuel as long as you can. To help keep warm, you can get out of the vehicle and do some fairly vigorous exercises every half hour or so until help comes.

If Your Vehicle is Stuck in Sand, Mud, Ice, or Snow

Slowly and cautiously spin the wheels to free your vehicle when stuck in sand, mud, ice, or snow. See *Rocking Your Vehicle to Get It Out on page 4-22*.

If your vehicle has a traction system, it can often help to free a stuck vehicle. Refer to your vehicle's traction system in the Index. If the stuck condition is too severe for the traction system to free the vehicle, turn the traction system off and use the rocking method.

CAUTION:

If you let your vehicle's tires spin at high speed, they can explode, and you or others could be injured. The vehicle can overheat, causing an engine compartment fire or other damage. Spin the wheels as little as possible and avoid going above 35 mph (55 km/h) as shown on the speedometer.

For information about using tire chains on your vehicle, see *Tire Chains on page 5-83*.

Rocking Your Vehicle to Get It Out

First, turn the steering wheel left and right to clear the area around the front wheels. Turn off any traction or stability system. See *Traction Control System (TCS) on page 4-6* and *StabiliTrak® System on page 4-8*. Then shift back and forth between REVERSE (R) and a forward gear, or with a manual transmission, between FIRST (1) or SECOND (2) and REVERSE (R), spinning the wheels as little as possible. To prevent transmission wear, wait until the wheels stop spinning before shifting gears. Release the accelerator pedal while you shift, and press lightly on the accelerator pedal when the transmission is in gear. By slowly spinning the wheels in the forward and reverse directions, you will cause a rocking motion that could free your vehicle. If that does not get your vehicle out after a few tries, it might need to be towed out. If your vehicle does need to be towed out, see *Towing Your Vehicle on page 4-27*.

Loading Your Vehicle

It is very important to know how much weight your vehicle can carry. This weight is called the vehicle capacity weight and includes the weight of all occupants, cargo, and all nonfactory-installed options. Two labels on your vehicle show how much weight it may properly carry, the Tire and Loading Information label, and the Certification label.

CAUTION:

Do not load your vehicle any heavier than the Gross Vehicle Weight Rating (GVWR), or either the maximum front or rear Gross Axle Weight Rating (GAWR). If you do, parts on your vehicle can break, and it can change the way your vehicle handles. These could cause you to lose control and crash. Also, overloading can shorten the life of your vehicle.

Tire and Loading Information Label

The diagram shows a rectangular label with a tire icon on the left. At the top, a horizontal bar contains the text 'TIRE AND LOADING INFORMATION'. Below this bar are four boxes labeled 'SEATING CAPACITY', 'TOTAL', 'FRONT', and 'REAR'. A line labeled 'A' points to the tire icon, and a line labeled 'B' points to the top bar. Below these boxes is the text 'The combined weight of occupants and cargo should never exceed XXX kg or XXX lbs.'. At the bottom, there is a table with columns for 'TIRE', 'ORIGINAL SIZE', 'COLD TIRE PRESSURE', and 'SEE OWNER'S MANUAL FOR ADDITIONAL INFORMATION'. The rows are 'FRONT', 'REAR', and 'SPARE'. Lines labeled 'C' and 'D' point to the 'ORIGINAL SIZE' and 'COLD TIRE PRESSURE' columns respectively.

TIRE	ORIGINAL SIZE	COLD TIRE PRESSURE	SEE OWNER'S MANUAL FOR ADDITIONAL INFORMATION
FRONT			
REAR			
SPARE			

Example Label

A vehicle specific Tire and Loading Information label is attached to the vehicle's center pillar (B-pillar). With the driver's door open, you will find the label attached below the door lock post (striker). The Tire and Loading Information label shows the number of occupant seating positions (A), and the maximum vehicle capacity weight (B) in kilograms and pounds.

The Tire and Loading Information label also shows the tire size of the original equipment tires (C) and the recommended cold tire inflation pressures (D). For more information on tires and inflation see *Tires on page 5-59* and *Inflation - Tire Pressure on page 5-67*.

There is also important loading information on the Certification label. It tells you the Gross Vehicle Weight Rating (GVWR) and the Gross Axle Weight Rating (GAWR) for the front and rear axle; see "Certification Label" later in this section.

Steps for Determining Correct Load Limit

1. Locate the statement "The combined weight of occupants and cargo should never exceed XXX kg or XXX lbs" on your vehicle's placard.
2. Determine the combined weight of the driver and passengers that will be riding in your vehicle.
3. Subtract the combined weight of the driver and passengers from XXX kg or XXX lbs.

4. The resulting figure equals the available amount of cargo and luggage load capacity. For example, if the “XXX” amount equals 1400 lbs and there will be five 150 lb passengers in your vehicle, the amount of available cargo and luggage load capacity is 650 lbs (1400 – 750 (5 x 150) = 650 lbs).
5. Determine the combined weight of luggage and cargo being loaded on the vehicle. That weight may not safely exceed the available cargo and luggage load capacity calculated in Step 4.
6. If your vehicle will be towing a trailer, the load from your trailer will be transferred to your vehicle. Consult this manual to determine how this reduces the available cargo and luggage load capacity of your vehicle.

See *Towing a Trailer on page 4-29* for important information on towing a trailer, towing safety rules, and trailering tips.

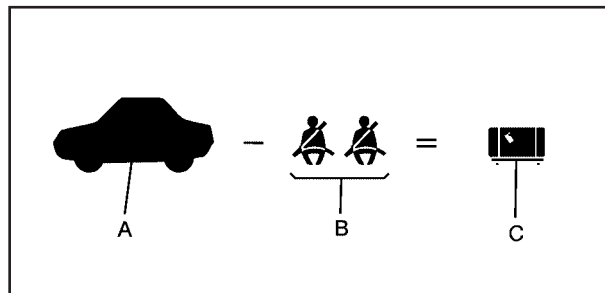

Example 1

Item	Description	Total
A	Vehicle Capacity Weight for Example 1 =	1,000 lbs (453 kg)
B	Subtract Occupant Weight 150 lbs (68 kg) × 2 =	300 lbs (136 kg)
C	Available Occupant and Cargo Weight =	700 lbs (317 kg)

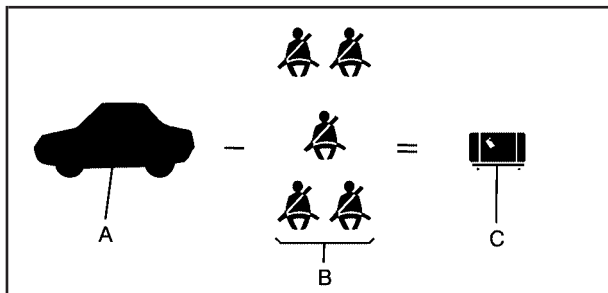

Example 2

Item	Description	Total
A	Vehicle Capacity Weight for Example 2 =	1,000 lbs (453 kg)
B	Subtract Occupant Weight 150 lbs (68 kg) × 5 =	750 lbs (340 kg)
C	Available Cargo Weight =	250 lbs (113 kg)

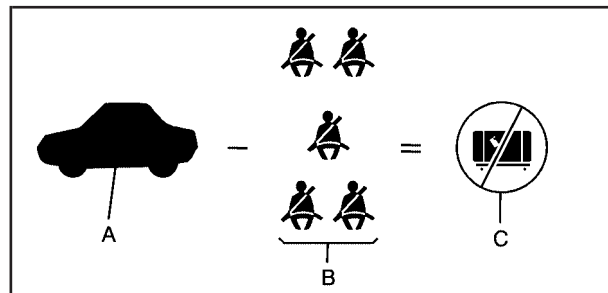

Example 3

Item	Description	Total
A	Vehicle Capacity Weight for Example 3 =	1,000 lbs (453 kg)
B	Subtract Occupant Weight 200 lbs (91 kg) × 5 =	1,000 lbs (453 kg)
C	Available Cargo Weight =	0 lbs (0 kg)

Refer to your vehicle's Tire and Loading Information label for specific information about your vehicle's capacity weight and seating positions. The combined weight of the driver, passengers, and cargo should never exceed your vehicle's capacity weight.

Certification Label

MFD BY GENERAL MOTORS CORP

DATE	GVWR	GAWR FRT	GAWR RR
<input type="text"/>	<input type="text"/>	<input type="text"/>	<input type="text"/>

THIS VEHICLE CONFORMS TO ALL APPLICABLE U.S. FEDERAL MOTOR VEHICLE SAFETY, BUMPER, AND TRAFFIC PREVENTION STANDARDS IN EFFECT ON THE DATE OF MANUFACTURE SHOWN ABOVE.

200 TYPE PASS CAR

EXAMPLE

A vehicle specific Certification label is attached to either the driver's door edge or the lower center pillar on the driver's side of the vehicle. This label shows the gross weight capacity of your vehicle, called the Gross Vehicle Weight Rating (GVWR). The GVWR includes the weight of the vehicle, all occupants, fuel, and cargo.

The Certification label also shows the maximum weights for the front and rear axles, called the Gross Axle Weight Rating (GAWR). Never exceed the GVWR or the GAWR for either the front or rear axle.

CAUTION:

Do not load your vehicle any heavier than the Gross Vehicle Weight Rating (GVWR), or either the maximum front or rear Gross Axle Weight Rating (GAWR). If you do, parts on your vehicle can break, and it can change the way your vehicle handles. These could cause you to lose control and crash. Also, overloading can shorten the life of your vehicle.

Notice: Overloading your vehicle may cause damage. Repairs would not be covered by your warranty. Do not overload your vehicle.

If you put things inside your vehicle, like suitcases, tools, packages, or anything else, they will go as fast as the vehicle goes. If you have to stop or turn quickly, or if there is a crash, they will keep going.

 **CAUTION:**

Things you put inside your vehicle can strike and injure people in a sudden stop or turn, or in a crash.

- **Put things in the trunk of your vehicle. In a trunk, put them as far forward as you can. Try to spread the weight evenly.**
- **Never stack heavier things, like suitcases, inside the vehicle so that some of them are above the tops of the seats.**
- **Do not leave an unsecured child restraint in your vehicle.**
- **When you carry something inside the vehicle, secure it whenever you can.**
- **Do not leave a seat folded down unless you need to.**

Towing

Towing Your Vehicle

Consult your dealer/retailer or a professional towing service if you need to have your disabled vehicle towed. See *Roadside Service on page 7-6*.

If you want to tow your vehicle behind another vehicle for recreational purposes (such as behind a motorhome), see Recreational Vehicle Towing following.

Recreational Vehicle Towing

Recreational vehicle towing means towing your vehicle behind another vehicle – such as behind a motorhome. The two most common types of recreational vehicle towing are known as “dinghy towing” (towing your vehicle with all four wheels on the ground) and “dolly towing” (towing your vehicle with two wheels on the ground and two wheels up on a device known as a “dolly”).

With the proper preparation and equipment, many vehicles can be towed in these ways. See “Dinghy Towing” and “Dolly Towing,” following.

Here are some important things to consider before you do recreational vehicle towing:

- What is the towing capacity of the towing vehicle? Be sure you read the tow vehicle manufacturer's recommendations.
- How far will you tow? Some vehicles have restrictions on how far and how long they can tow.
- Do you have the proper towing equipment? See your dealer/retailer or trailering professional for additional advice and equipment recommendations.
- Is your vehicle ready to be towed? Just as you would prepare your vehicle for a long trip, you'll want to make sure your vehicle is prepared to be towed. See *Before Leaving on a Long Trip on page 4-16*.

Dinghy Towing

Notice: If you tow your vehicle with all four wheels on the ground, the drivetrain components could be damaged. The repairs would not be covered by your warranty. Do not tow your vehicle with all four wheels on the ground.

Your vehicle was not designed to be towed with all four wheels on the ground. If your vehicle must be towed, you should use a dolly. See "Dolly Towing" following for more information.

Dolly Towing

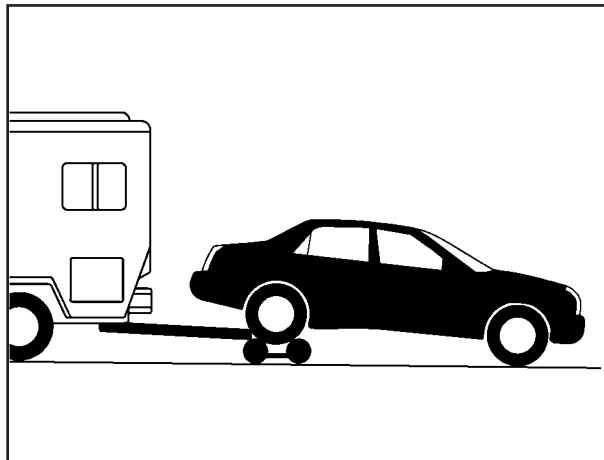

Your vehicle can be towed using a dolly. To tow your vehicle using a dolly:

1. Put the rear wheels on the dolly.
2. Securely attach the vehicle being towed to the tow vehicle.

3. Put the vehicle in PARK (P) for an automatic transmission or in NEUTRAL for a manual transmission.
4. Set the parking brake and then remove the key.
5. Clamp the steering wheel in a straight-ahead position with a clamping device designed for towing.
6. Release the parking brake.

Dolly Towing (All-Wheel-Drive Vehicles)

Notice: Towing an all-wheel-drive vehicle with all four wheels on the ground, or even with only two of its wheels on the ground, will damage drivetrain components. Do not tow an all-wheel-drive vehicle if any of its wheels will be on the ground.

If you have an All-Wheel-Drive vehicle, it can only be towed on a flat-bed trailer.

Towing a Trailer

CAUTION:

If you do not use the correct equipment and drive properly, you can lose control when you pull a trailer. For example, if the trailer is too heavy, the brakes may not work well — or even at all. You and your passengers could be seriously injured. You may also damage your vehicle; the resulting repairs would not be covered by your warranty. Pull a trailer only if you have followed all the steps in this section. Ask your dealer/retailer for advice and information about towing a trailer with your vehicle.

Your vehicle can tow a trailer if it is equipped with the proper trailer towing equipment. To identify the trailering capacity of your vehicle, you should read the information in “Weight of the Trailer” that appears later in this section. Trailering is different than just driving your vehicle by itself. Trailering means changes in handling, acceleration, braking, durability and fuel economy. Successful, safe trailering takes correct equipment, and it has to be used properly.

That is the reason for this part. In it are many time-tested, important trailering tips and safety rules. Many of these are important for your safety and that of your passengers. So please read this section carefully before you pull a trailer.

Load-pulling components such as the engine, transmission, wheel assemblies and tires are forced to work harder against the drag of the added weight. The engine is required to operate at relatively higher speeds and under greater loads, generating extra heat. Also, the trailer adds considerably to wind resistance, increasing the pulling requirements.

If You Do Decide To Pull A Trailer

If you do, here are some important points:

- There are many different laws, including speed limit restrictions, having to do with trailering. Make sure your rig will be legal, not only where you live but also where you will be driving. A good source for this information can be state or provincial police.
- Consider using a sway control. You can ask a hitch dealer/retailer about sway controls.
- Do not tow a trailer at all during the first 1,000 miles (1 600 km) your new vehicle is driven. Your engine, axle or other parts could be damaged.

- Then, during the first 500 miles (800 km) that you tow a trailer, do not drive over 50 mph (80 km/h) and do not make starts at full throttle. This helps your engine and other parts of your vehicle wear in at the heavier loads.
- Obey speed limit restrictions when towing a trailer. Do not drive faster than the maximum posted speed for trailers, or no more than 55 mph (90 km/h), to save wear on your vehicle's parts.

Three important considerations have to do with weight:

- The weight of the trailer.
- The weight of the trailer tongue.
- The total weight on your vehicle's tires.

Weight of the Trailer

How heavy can a trailer safely be?

It should never weigh more than 1,000 lbs (450 kg). But even that can be too heavy.

It depends on how you plan to use your rig. For example, speed, altitude, road grades, outside temperature and how much your vehicle is used to pull a trailer are all important. It can also depend on any special equipment that you have on your vehicle, and the amount of tongue weight the vehicle can carry. See "Weight of the Trailer Tongue" later in this section for more information.

Maximum trailer weight is calculated assuming only the driver is in the tow vehicle and it has all the required trailering equipment. The weight of additional optional equipment, passengers and cargo in the tow vehicle must be subtracted from the maximum trailer weight.

You can ask your dealer/retailer for our trailering information or advice, or you can write us at our Customer Assistance Offices. See *Customer Assistance Offices* on page 7-5 for more information.

Weight of the Trailer Tongue

The tongue load (A) of any trailer is an important weight to measure because it affects the total or gross weight of your vehicle. The Gross Vehicle Weight (GVW) includes the curb weight of the vehicle, any cargo you may carry in it, and the people who will be riding in the vehicle. If you have a lot of options, equipment, passengers, or cargo in your vehicle, it will reduce the tongue weight your vehicle can carry, which will also reduce the trailer weight your vehicle can tow. And if you tow a trailer, you must add the tongue load to the GVW because your vehicle will be carrying that weight, too. See *Loading Your Vehicle* on page 4-22 for more information about your vehicle's maximum load capacity.

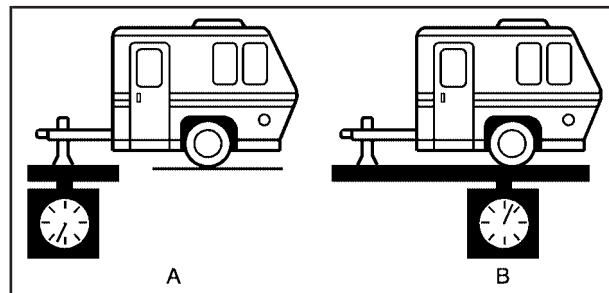

If you are using a weight-carrying hitch, the trailer tongue (A) should weigh 10 to 15 percent of the total loaded trailer weight (B).

After you have loaded your trailer, weigh the trailer and then the tongue, separately, to see if the weights are proper. If they are not, you may be able to get them right simply by moving some items around in the trailer.

Total Weight on Your Vehicle's Tires

Be sure your vehicle's tires are inflated to the upper limit for cold tires. You will find these numbers on the Tire-Loading Information label. See *Loading Your Vehicle* on page 4-22. Then be sure you do not go over the GVW limit for your vehicle, including the weight of the trailer tongue.

Hitches

It is important to have the correct hitch equipment. Crosswinds, large trucks going by and rough roads are a few reasons why you will need the right hitch. Here are some rules to follow:

- The rear bumper on your vehicle is not intended for hitches. Do not attach rental hitches or other bumper-type hitches to it. Use only a frame-mounted hitch that does not attach to the bumper.
- Will you have to make any holes in the body of your vehicle when you install a trailer hitch? If you do, then be sure to seal the holes later when you remove the hitch. If you do not seal them, deadly carbon monoxide (CO) from your exhaust can get into your vehicle. See *Engine Exhaust on page 2-47*. Dirt and water can also enter the vehicle.

Safety Chains

You should always attach chains between your vehicle and your trailer. Cross the safety chains under the tongue of the trailer so that the tongue will not drop to the road if it becomes separated from the hitch. Instructions about safety chains may be provided by the hitch manufacturer or by the trailer manufacturer. Follow the manufacturer's recommendation for attaching safety chains and do not attach them to the bumper. Always leave just enough slack so you can turn with your rig. And, never allow safety chains to drag on the ground.

Trailer Brakes

Does your trailer have its own brakes? Be sure to read and follow the instructions for the trailer brakes so you will be able to install, adjust and maintain them properly.

Because you have anti-lock brakes, do not try to tap into your vehicle's brake system. If you do, both brake systems will not work well, or at all.

Trailer Wiring Harness

All of the electrical circuits required for your trailer lighting system can be accessed at the driver's side rear lamp connector. This connector is located under the carpet on the rear corner of the trunk compartment.

Driving with a Trailer

Towing a trailer requires a certain amount of experience. Before setting out for the open road, you will want to get to know your rig. Acquaint yourself with the feel of handling and braking with the added weight of the trailer. And always keep in mind that the vehicle you are driving is now a good deal longer and not nearly as responsive as your vehicle is by itself.

Before you start, check all trailer hitch parts and attachments, safety chains, electrical connector, lamps, tires and mirror adjustment. If the trailer has electric brakes, start your vehicle and trailer moving and then apply the trailer brake controller by hand to be sure the brakes are working. This lets you check your electrical connection at the same time.

During your trip, check occasionally to be sure that the load is secure, and that the lamps and any trailer brakes are still working.

Following Distance

Stay at least twice as far behind the vehicle ahead as you would when driving your vehicle without a trailer. This can help you avoid situations that require heavy braking and sudden turns.

Passing

You will need more passing distance up ahead when you are towing a trailer. And, because the vehicle is a good deal longer, you will need to go much farther beyond the passed vehicle before you can return to your lane.

Backing Up

Hold the bottom of the steering wheel with one hand. Then, to move the trailer to the left, just move that hand to the left. To move the trailer to the right, move your hand to the right. Always back up slowly and, if possible, have someone guide you.

Making Turns

Notice: Making very sharp turns while trailering could cause the trailer to come in contact with the vehicle. Your vehicle could be damaged. Avoid making very sharp turns while trailering.

When you are turning with a trailer, make wider turns than normal. Do this so your trailer will not strike soft shoulders, curbs, road signs, trees or other objects. Avoid jerky or sudden maneuvers. Signal well in advance.

Turn Signals When Towing a Trailer

When you tow a trailer, your vehicle may need a different turn signal flasher and/or extra wiring. Check with your dealer/retailer. The arrows on your instrument panel will flash whenever you signal a turn or lane change. Properly hooked up, the trailer lamps will also flash, telling other drivers you are about to turn, change lanes or stop.

When towing a trailer, the arrows on your instrument panel will flash for turns even if the bulbs on the trailer are burned out. Thus, you may think drivers behind you are seeing your signal when they are not. It is important to check occasionally to be sure the trailer bulbs are still working.

Your vehicle has bulb warning lights. When you plug a trailer lighting system into your vehicle's lighting system, its bulb warning lights may not let you know if one of your lamps goes out. So, when you have a trailer lighting system plugged in, be sure to check your vehicle and trailer lamps from time to time to be sure they are all working. Once you disconnect the trailer lamps, the bulb warning lights again can tell you if one of your vehicle lamps is out.

Driving On Grades

Reduce speed and shift to a lower gear *before* you start down a long or steep downgrade. If you do not shift down, you might have to use your brakes so much that they would get hot and no longer work well.

On a long uphill grade, shift down to a lower gear and reduce your speed to around 45 mph (70 km/h) to reduce the possibility of engine and transmission overheating.

Parking on Hills

CAUTION:

You really should not park your vehicle, with a trailer attached, on a hill. If something goes wrong, your rig could start to move. People can be injured, and both your vehicle and the trailer can be damaged.

But if you ever have to park your rig on a hill, here is how to do it:

1. Apply your regular brakes, but do not shift into PARK (P) yet.
2. Have someone place chocks under the trailer wheels.

3. When the wheel chocks are in place, release the regular brakes until the chocks absorb the load.
4. Reapply the regular brakes. Then apply your parking brake, and then shift to PARK (P).
5. Release the regular brakes.

When You Are Ready to Leave After Parking on a Hill

1. Apply your regular brakes and hold the pedal down while you:
 - Start your engine.
 - Shift into a gear.
 - Release the parking brake.
2. Let up on the brake pedal.
3. Drive slowly until the trailer is clear of the chocks.
4. Stop and have someone pick up and store the chocks.

Maintenance When Trailer Towing

Your vehicle will need service more often when you're pulling a trailer. See the Maintenance Schedule for more on this. Things that are especially important in trailer operation are automatic transmission fluid (don't overfill), engine oil, drive belt, cooling system and brake system. Each of these is covered in this manual, and the Index will help you find them quickly. If you're trailering, it's a good idea to review this information before you start your trip.

Check periodically to see that all hitch nuts and bolts are tight.

Engine Cooling When Trailer Towing

Your cooling system may temporarily overheat during severe operating conditions. See *Engine Overheating on page 5-30*.

Section 5 Service and Appearance Care

Service	5-3	Overheated Engine Protection Operating Mode	5-32
Accessories and Modifications	5-3	Cooling System	5-33
California Proposition 65 Warning	5-4	Power Steering Fluid	5-38
California Perchlorate Materials Requirements	5-4	Windshield Washer Fluid	5-39
Doing Your Own Service Work	5-4	Brakes	5-40
Adding Equipment to the Outside		Battery	5-43
of Your Vehicle	5-5	Jump Starting	5-44
Fuel	5-5	All-Wheel Drive	5-49
Gasoline Octane	5-5	Rear Axle	5-50
Gasoline Specifications	5-6	Headlamp Aiming	5-51
California Fuel	5-6	Bulb Replacement	5-55
Additives	5-6	High Intensity Discharge (HID) Lighting	5-55
Fuels in Foreign Countries	5-7	Halogen Bulbs	5-55
Filling the Tank	5-8	Front Turn Signal and Fog Lamps	5-56
Filling a Portable Fuel Container	5-11	License Plate Lamp	5-56
Checking Things Under the Hood	5-12	Replacement Bulbs	5-57
Hood Release	5-13	Windshield Wiper Blade Replacement	5-57
Engine Compartment Overview	5-14	Tires	5-59
Engine Oil	5-16	Winter Tires	5-60
Engine Oil Life System	5-19	Tire Sidewall Labeling	5-61
Engine Air Cleaner/Filter	5-21	Tire Terminology and Definitions	5-64
Automatic Transmission Fluid	5-25	Inflation - Tire Pressure	5-67
Manual Transmission Fluid	5-25	High-Speed Operation	5-69
Hydraulic Clutch	5-26	Tire Pressure Monitor System	5-70
Engine Coolant	5-27	Tire Pressure Monitor Operation	5-71
Coolant Surge Tank Pressure Cap	5-30	Tire Inspection and Rotation	5-75
Engine Overheating	5-30		

Section 5 Service and Appearance Care

When It Is Time for New Tires	5-76	Care of Safety Belts	5-114
Buying New Tires	5-77	Weatherstrips	5-115
Different Size Tires and Wheels	5-79	Washing Your Vehicle	5-115
Uniform Tire Quality Grading	5-80	Cleaning Exterior Lamps/Lenses	5-116
Wheel Alignment and Tire Balance	5-81	Finish Care	5-116
Wheel Replacement	5-81	Windshield and Wiper Blades	5-117
Tire Chains	5-83	Aluminum or Chrome-Plated Wheels and Trim	5-117
If a Tire Goes Flat	5-83	Tires	5-118
Tire Sealant and Compressor Kit (With Sealant Selector Switch)	5-85	Sheet Metal Damage	5-118
Tire Sealant and Compressor Kit (Without Sealant Selector Switch)	5-93	Finish Damage	5-118
Changing a Flat Tire	5-102	Underbody Maintenance	5-119
Removing the Spare Tire and Tools	5-104	Chemical Paint Spotting	5-119
Removing the Flat Tire and Installing the Spare Tire	5-105	Vehicle Care/Appearance Materials	5-119
Storing a Flat or Spare Tire and Tools	5-110	Vehicle Identification	5-120
Compact Spare Tire	5-111	Vehicle Identification Number (VIN)	5-120
Appearance Care	5-111	Service Parts Identification Label	5-121
Interior Cleaning	5-111	Electrical System	5-121
Fabric/Carpet	5-113	Add-On Electrical Equipment	5-121
Leather	5-113	Windshield Wiper Fuses	5-121
Instrument Panel, Vinyl, and Other Plastic Surfaces	5-114	Power Windows and Other Power Options	5-122
Wood Panels	5-114	Fuses and Circuit Breakers	5-122
Speaker Covers	5-114	Underhood Fuse Block	5-122
		Rear Compartment Fuse Block	5-126
		Capacities and Specifications	5-128

Service

For service and parts needs, visit your dealer/retailer. You will receive genuine GM parts and GM-trained and supported service people.

Genuine GM parts have one of these marks:

ACDelco

GM Parts

**GM
Goodwrench**

GM Accessories

Accessories and Modifications

When non-dealer/non-retailer accessories are added to your vehicle they can affect your vehicle's performance and safety, including such things as, airbags, braking, stability, ride and handling, emissions systems, aerodynamics, durability, and electronic systems like antilock brakes, traction control and stability control. Some of these accessories could even cause malfunction or damage not covered by warranty.

GM Accessories are designed to complement and function with other systems on your vehicle. Your GM dealer/retailer can accessorize your vehicle using genuine GM Accessories. When you go to your GM dealer/retailer and ask for GM Accessories, you will know that GM-trained and supported service technicians will perform the work using genuine GM Accessories.

Also, see *Adding Equipment to Your Airbag-Equipped Vehicle* on page 1-69.

California Proposition 65 Warning

Most motor vehicles, including this one, contain and/or emit chemicals known to the State of California to cause cancer and birth defects or other reproductive harm. Engine exhaust, many parts and systems (including some inside the vehicle), many fluids, and some component wear by-products contain and/or emit these chemicals.

California Perchlorate Materials Requirements

Certain types of automotive applications, such as airbag initiators, seat belt pretensioners, and lithium batteries contained in remote keyless entry transmitters, may contain perchlorate materials. Special handling may be necessary. For additional information, see www.dtsc.ca.gov/hazardouswaste/perchlorate.

Doing Your Own Service Work

CAUTION:

You can be injured and your vehicle could be damaged if you try to do service work on a vehicle without knowing enough about it.

- **Be sure you have sufficient knowledge, experience, the proper replacement parts, and tools before you attempt any vehicle maintenance task.**
- **Be sure to use the proper nuts, bolts, and other fasteners. English and metric fasteners can be easily confused. If you use the wrong fasteners, parts can later break or fall off. You could be hurt.**

If you want to do some of your own service work, you should use the proper service manual. It tells you much more about how to service your vehicle than this manual can. To order the proper service manual, see *Service Publications Ordering Information on page 7-15*.

Your vehicle has an airbag system. Before attempting to do your own service work, see *Servicing Your Airbag-Equipped Vehicle on page 1-68*.

You should keep a record with all parts receipts and list the mileage and the date of any service work you perform. See *Maintenance Record on page 6-15*.

Adding Equipment to the Outside of Your Vehicle

Things you might add to the outside of your vehicle can affect the airflow around it. This can cause wind noise and can affect fuel economy and windshield washer performance. Check with your dealer/retailer before adding equipment to the outside of your vehicle.

Fuel

Use of the recommended fuel is an important part of the proper maintenance of your vehicle. To help keep the engine clean and maintain optimum vehicle performance, we recommend the use of gasoline advertised as TOP TIER Detergent Gasoline.

The 8th digit of the Vehicle Identification Number (VIN) shows the code letter or number that identifies your vehicle's engine. The VIN is at the top left of the instrument panel. See *Vehicle Identification Number (VIN) on page 5-120*.

Gasoline Octane

If your vehicle has the 3.6L V6 engine (VIN Code V), use regular unleaded gasoline with a posted octane rating of 87 or higher. If the octane rating is less than 87, you might notice an audible knocking noise when you drive, commonly referred to as spark knock. If this occurs, use a gasoline rated at 87 octane or higher as soon as possible. If you are using gasoline rated at 87 octane or higher and you hear heavy knocking, the engine needs service.

If your vehicle has the 3.6L V6 engine (VIN Code 7), use regular unleaded gasoline with a posted octane rating of 87 or higher. For best performance or trailer towing, you could choose to use middle grade 89 octane unleaded gasoline. If the octane rating is less than 87, you might notice an audible knocking noise when you drive, commonly referred to as spark knock. If this occurs, use a gasoline rated at 87 octane or higher as soon as possible. If you are using gasoline rated at 87 octane or higher and you hear heavy knocking, the engine needs service.

Gasoline Specifications

At a minimum, gasoline should meet ASTM specification D 4814 in the United States or CAN/CGSB-3.5 or 3.511 in Canada. Some gasolines contain an octane-enhancing additive called methylcyclopentadienyl manganese tricarbonyl (MMT). We recommend against the use of gasolines containing MMT. See *Additives on page 5-6* for additional information.

California Fuel

If your vehicle is certified to meet California Emissions Standards, it is designed to operate on fuels that meet California specifications. See the underhood emission control label. If this fuel is not available in states adopting California emissions standards, your vehicle will operate satisfactorily on fuels meeting federal specifications, but emission control system performance might be affected. The malfunction indicator lamp could turn on and your vehicle might fail a smog-check test. See *Malfunction Indicator Lamp on page 3-40*. If this occurs, return to your authorized dealer/retailer for diagnosis. If it is determined that the condition is caused by the type of fuel used, repairs might not be covered by your warranty.

Additives

To provide cleaner air, all gasolines in the United States are now required to contain additives that help prevent engine and fuel system deposits from forming, allowing the emission control system to work properly. In most cases, you should not have to add anything to the fuel. However, some gasolines contain only the minimum amount of additive required to meet U.S. Environmental Protection Agency regulations. To help keep fuel injectors and intake valves clean, or if your vehicle experiences problems due to dirty injectors or valves, look for gasoline that is advertised as TOP TIER Detergent Gasoline. Also, your dealer/retailer has additives that will help correct and prevent most deposit-related problems.

Gasolines containing oxygenates, such as ethers and ethanol, and reformulated gasolines might be available in your area. We recommend that you use these gasolines, if they comply with the specifications described earlier. However, E85 (85% ethanol) and other fuels containing more than 10% ethanol must not be used in vehicles that were not designed for those fuels.

Notice: Your vehicle was not designed for fuel that contains methanol. Do not use fuel containing methanol. It can corrode metal parts in the fuel system and also damage plastic and rubber parts. That damage would not be covered under your warranty.

Some gasolines that are not reformulated for low emissions can contain an octane-enhancing additive called methylcyclopentadienyl manganese tricarbonyl (MMT); ask the attendant where you buy gasoline whether the fuel contains MMT. We recommend against the use of such gasolines. Fuels containing MMT can reduce the life of spark plugs and the performance of the emission control system could be affected. The malfunction indicator lamp might turn on. If this occurs, return to your dealer/retailer for service.

Fuels in Foreign Countries

If you plan on driving in another country outside the United States or Canada, the proper fuel might be hard to find. Never use leaded gasoline or any other fuel not recommended in the previous text on fuel. Costly repairs caused by use of improper fuel would not be covered by your warranty.

To check the fuel availability, ask an auto club, or contact a major oil company that does business in the country where you will be driving.

Filling the Tank

CAUTION:

Fuel vapor burns violently and a fuel fire can cause bad injuries. To help avoid injuries to you and others, read and follow all the instructions on the pump island. Turn off your engine when you are refueling. Do not smoke if you are near fuel or refueling your vehicle. Do not use cellular phones. Keep sparks, flames, and smoking materials away from fuel. Do not leave the fuel pump unattended when refueling your vehicle. This is against the law in some places. Do not re-enter the vehicle while pumping fuel. Keep children away from the fuel pump; never let children pump fuel.

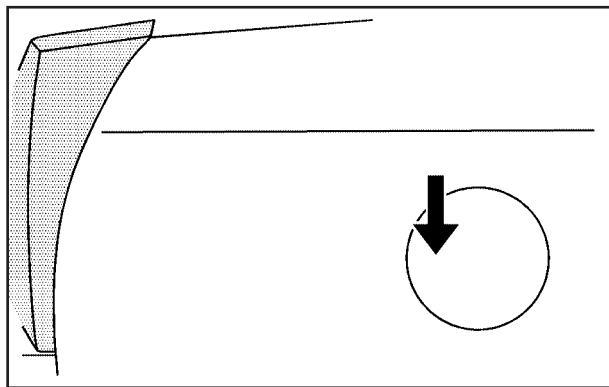

The fuel cap is behind a hinged fuel door on the passenger's side of the vehicle. The fuel door is opened by pushing in on the rear edge until the door pops out.

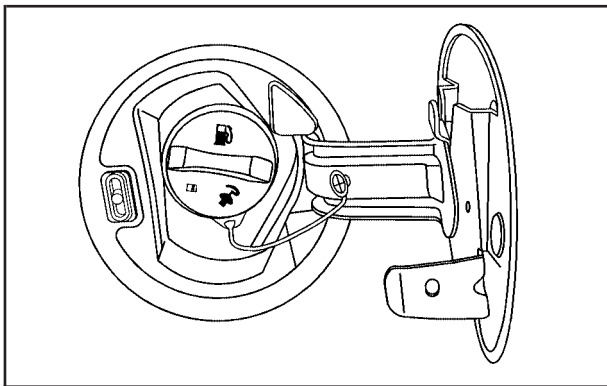

To remove the fuel cap, turn it slowly counterclockwise. The fuel cap has a spring in it; if the cap is released too soon, it will spring back to the right.

While refueling, hang the tethered fuel cap from the hook on the fuel door.

CAUTION:

Fuel can spray out on you if you open the fuel cap too quickly. If you spill fuel and then something ignites it, you could be badly burned. This spray can happen if your tank is nearly full, and is more likely in hot weather. Open the fuel cap slowly and wait for any hiss noise to stop. Then unscrew the cap all the way.

Be careful not to spill fuel. Do not top off or overfill the tank and wait a few seconds after you have finished pumping before removing the nozzle. Clean fuel from painted surfaces as soon as possible. See *Washing Your Vehicle* on page 5-115.

When replacing the fuel cap, turn it clockwise until it clicks. Make sure the cap is fully installed. The diagnostic system can determine if the fuel cap has been left off or improperly installed. This would allow fuel to evaporate into the atmosphere. See *Malfunction Indicator Lamp on page 3-40*.

The Tighten Gas Cap message in the Driver Information Center (DIC) will be displayed if the fuel cap is not properly installed. See *DIC Warnings and Messages on page 3-54* for more information.

 **CAUTION:**

If a fire starts while you are refueling, do not remove the nozzle. Shut off the flow of fuel by shutting off the pump or by notifying the station attendant. Leave the area immediately.

Notice: If you need a new fuel cap, be sure to get the right type. Your dealer/retailer can get one for you. If you get the wrong type, it may not fit properly. This may cause your malfunction indicator lamp to light and may damage your fuel tank and emissions system. See *Malfunction Indicator Lamp on page 3-40*.

Filling a Portable Fuel Container

CAUTION:

Never fill a portable fuel container while it is in your vehicle. Static electricity discharge from the container can ignite the fuel vapor. You can be badly burned and your vehicle damaged if this occurs. To help avoid injury to you and others:

- Dispense fuel only into approved containers.
- Do not fill a container while it is inside a vehicle, in a vehicle's trunk, pickup bed, or on any surface other than the ground.

CAUTION: (Continued)

CAUTION: (Continued)

- Bring the fill nozzle in contact with the inside of the fill opening before operating the nozzle. Contact should be maintained until the filling is complete.
- Do not smoke while pumping fuel.
- Do not use a cellular phone while pumping fuel.

Checking Things Under the Hood

CAUTION:

An electric fan under the hood can start up and injure you even when the engine is not running. Keep hands, clothing, and tools away from any underhood electric fan.

CAUTION:

Things that burn can get on hot engine parts and start a fire. These include liquids like fuel, oil, coolant, brake fluid, windshield washer and other fluids, and plastic or rubber. You or others could be burned. Be careful not to drop or spill things that will burn onto a hot engine.

Hood Release

To open the hood, do the following:

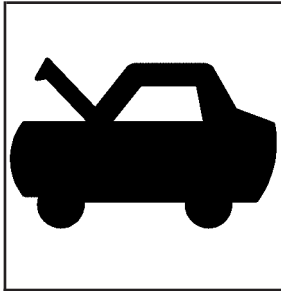

1. Pull the hood release lever with this symbol on it. It is located inside the vehicle on the lower left side of the instrument panel.

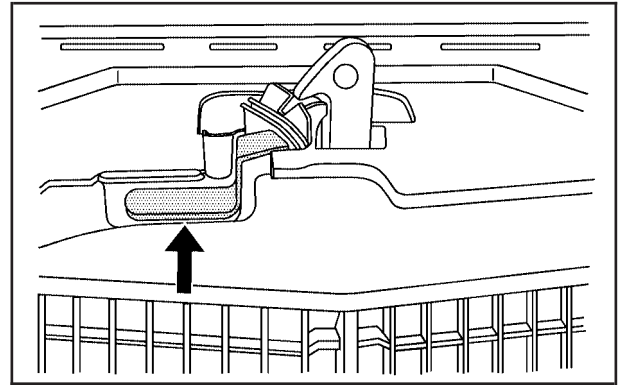

2. Then go to the front of the vehicle and find the secondary hood release lever. The lever is located under the front edge of the grille near the center. Push the release lever up and raise the hood.

Before closing the hood, be sure all the filler caps are on properly. Then pull the hood down and close it firmly.

Engine Compartment Overview

When you open the hood, here is what you will see:

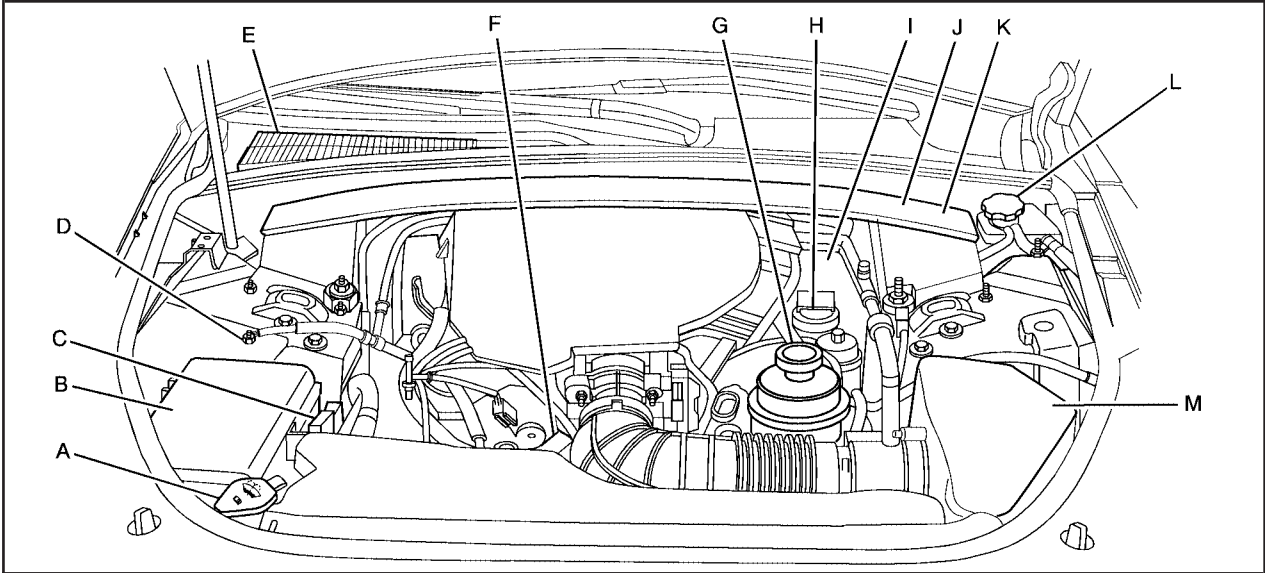

- A. Windshield Washer Fluid Reservoir. See “Adding Washer Fluid” under *Windshield Washer Fluid* on page 5-39.
- B. Underhood Fuse Block. See *Underhood Fuse Block* on page 5-122.
- C. Remote Positive (+) Terminal. See *Jump Starting* on page 5-44.
- D. Remote Negative (+) Terminal. See *Jump Starting* on page 5-44.
- E. Passenger Compartment Air Filter. See *Passenger Compartment Air Filter* on page 3-28.
- F. Engine Cooling Fan. See *Cooling System* on page 5-33.
- G. Power Steering Fluid Reservoir (Under Engine Cover). See *Power Steering Fluid* on page 5-38.
- H. Engine Oil Fill Cap. See “When to Add Engine Oil” under *Engine Oil* on page 5-16.
- I. Engine Oil Dipstick (Out of View). See “Checking Engine Oil” under *Engine Oil* on page 5-16.
- J. Hydraulic Clutch Reservoir (If Equipped) (Not Shown). See “When to Check and What to Use” under *Hydraulic Clutch* on page 5-26.
- K. Brake Master Cylinder Reservoir (Out of View). See “Brake Fluid” under *Brakes* on page 5-40.
- L. Engine Coolant Surge Tank and Pressure Cap. See *Coolant Surge Tank Pressure Cap* on page 5-30 and *Cooling System* on page 5-33.
- M. Engine Air Cleaner/Filter. See *Engine Air Cleaner/Filter* on page 5-21.

Engine Oil

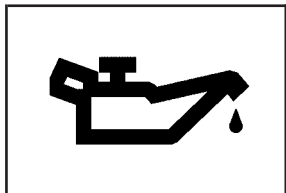

There is an oil pressure light in the instrument cluster and an Oil Pressure Low Stop Engine message on the Driver Information Center (DIC).

If the light and/or message appear, check the engine oil level right away. For more information, see “Oil Pressure Low Stop Engine” under *DIC Warnings and Messages on page 3-54* and *Oil Pressure Light on page 3-43*. You should check the engine oil level regularly; this is an added reminder.

Checking Engine Oil

It is a good idea to check the engine oil every time you get fuel. In order to get an accurate reading, the oil must be warm and the vehicle must be on level ground.

The engine oil dipstick handle is a yellow loop. See *Engine Compartment Overview on page 5-14* for the location of the engine oil dipstick.

1. Turn off the engine and give the oil several minutes to drain back into the oil pan. If you do not do this, the oil dipstick might not show the actual level.
2. Pull out the dipstick and clean it with a paper towel or cloth, then push it back in all the way. Remove it again, keeping the tip down, and check the level.

When to Add Engine Oil

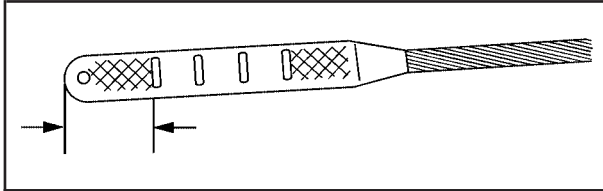

If the oil level is within the add cross-hatched area at the tip of the dipstick, add at least one quart/liter of the recommended oil. This section explains what kind of oil to use. For engine oil crankcase capacity, see *Capacities and Specifications on page 5-128*.

Notice: Do not add too much oil. If the engine has so much oil that the oil level gets above the proper operating range and into the upper cross-hatched area on the dipstick, the engine could be damaged.

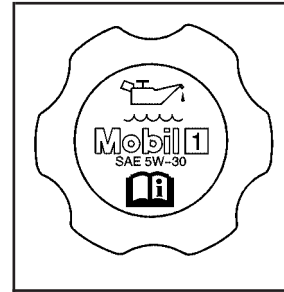

See *Engine Compartment Overview on page 5-14* for the location of the engine oil fill cap.

Be sure to add enough oil to put the level somewhere in the proper operating range. Push the dipstick all the way back in when you are through.

What Kind of Engine Oil to Use

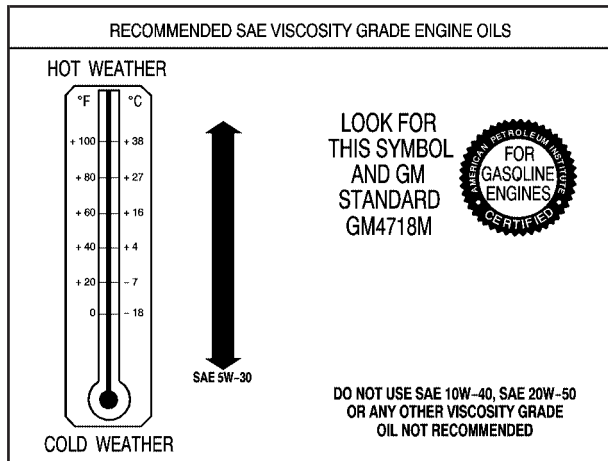

Look for three things:

- GM4718M

Your vehicle's engine requires a special oil meeting GM Standard GM4718M. Oils meeting this standard may be identified as synthetic. However, not all synthetic oils will meet this GM standard. Look for and use only an oil that meets GM Standard GM4718M.

Notice: If you use oils that do not have the GM4718M Standard designation, you can cause engine damage not covered by your warranty.

- SAE 5W-30

As shown in the viscosity chart, SAE 5W-30 is best for your vehicle.

These numbers on an oil container show its viscosity, or thickness. Do not use other viscosity oils such as SAE 20W-50.



- Oils meeting these requirements should have the starburst symbol on the container. This symbol indicates that the oil has been certified by the American Petroleum Institute (API).

Look for this on the oil container, and use only those oils that are identified as meeting GM Standard GM4718M and have the starburst symbol on the front of the oil container.

Your vehicle's engine is filled at the factory with a Mobil 1[®] synthetic oil, which meets all requirements for your vehicle.

Substitute Engine Oil: When adding oil to maintain engine oil level, oil meeting GM Standard GM4718M may not be available. You can add substitute oil designated SAE 5W-30 with the starburst symbol at all temperatures. Substitute oil not meeting GM Standard GM4718M should not be used for an oil change.

Engine Oil Additives

Do not add anything to the oil. The recommended oils with the starburst symbol that meet GM standards are all you need for good performance and engine protection.

Engine Oil Life System

When to Change Engine Oil

Your vehicle has a computer system that lets you know when to change the engine oil and filter. This is based on engine revolutions and engine temperature, and not on mileage. Based on driving conditions, the mileage at which an oil change will be indicated can vary considerably. For the oil life system to work properly, you must reset the system every time the oil is changed.

When the system has calculated that oil life has been diminished, it will indicate that an oil change is necessary. A Change Engine Oil Soon message will come on. See *DIC Warnings and Messages on page 3-54*. Change the oil as soon as possible within the next 600 miles (1 000 km). It is possible that, if you are driving under the best conditions, the oil life system might not indicate that an oil change is necessary for over a year. However, the engine oil and filter must be changed at least once a year and at this time the system must be reset. Your dealer/retailer has trained service people who will perform this work using genuine parts and reset the system. It is also important to check the oil regularly and keep it at the proper level.

If the system is ever reset accidentally, you must change the oil at 3,000 miles (5 000 km) since your last oil change. Remember to reset the oil life system whenever the oil is changed.

How to Reset the Engine Oil Life System

The Engine Oil Life System calculates when to change the engine oil and filter based on vehicle use. Whenever the oil is changed, reset the system so it can calculate when the next oil change is required. If a situation occurs where you change the oil prior to a Change Engine Oil Soon message being turned on, reset the system.

Always reset the engine oil life to 100% after every oil change. It will not reset itself. To reset the Engine Oil Life System:

1. Display the OIL LIFE REMAINING on the DIC.
2. Press and hold the SET/RESET button on the DIC for more than five seconds. The oil life will change to 100%.

If the Change Engine Oil Soon message comes back on when you start your vehicle, the Engine Oil Life System has not reset. Repeat the procedure.

What to Do with Used Oil

Used engine oil contains certain elements that can be unhealthy for your skin and could even cause cancer. Do not let used oil stay on your skin for very long. Clean your skin and nails with soap and water, or a good hand cleaner. Wash or properly dispose of clothing or rags containing used engine oil. See the manufacturer's warnings about the use and disposal of oil products.

Used oil can be a threat to the environment. If you change your own oil, be sure to drain all the oil from the filter before disposal. Never dispose of oil by putting it in the trash, pouring it on the ground, into sewers, or into streams or bodies of water. Instead, recycle it by taking it to a place that collects used oil. If you have a problem properly disposing of used oil, ask your dealer/retailer, a service station, or a local recycling center for help.

Engine Air Cleaner/Filter

The engine air cleaner/filter is in the engine compartment on the driver's side of the vehicle, near the front. See *Engine Compartment Overview* on page 5-14 for more information on location.

When to Inspect the Engine Air Cleaner/Filter

Inspect the air cleaner/filter at the Maintenance II intervals and replace it at the first oil change after each 50,000 mile (80 000 km) interval. See *Scheduled Maintenance* on page 6-4 for more information. If you are driving in dusty/dirty conditions, inspect the filter at each engine oil change.

How to Inspect the Engine Air Cleaner/Filter

To inspect the air cleaner/filter, remove the filter from the vehicle and lightly shake the filter to release loose dust and dirt. If the filter remains caked with dirt, a new filter is required.

To inspect or replace the engine air cleaner/filter, do the following:

1. Turn the ignition off.

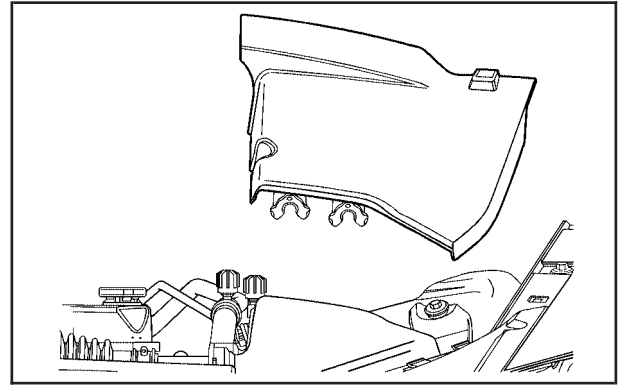

2. Remove side cover by pulling up on front of cover.

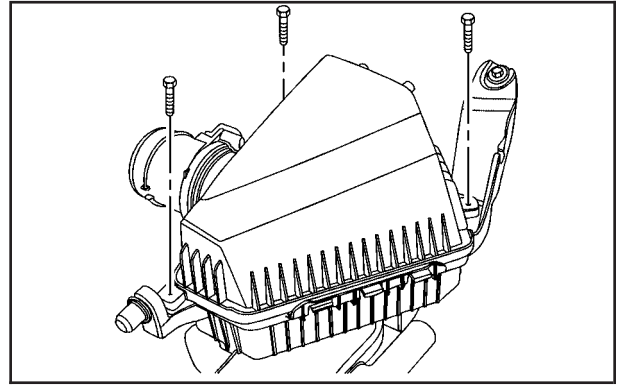
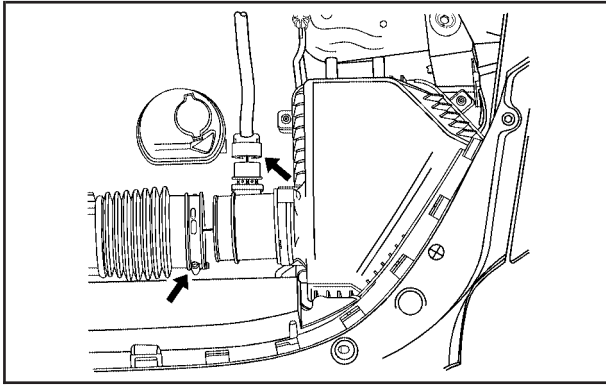

3. Disconnect electrical connector from air box.
4. Loosen the screw on the clamp holding the air outlet duct in place. Do not pry the clamp off. position the duct aside.
5. Remove the rubber hose from the air cleaner housing mounting arm. Position the rubber hose aside.

6. Remove the three air cleaner housing cover screws.

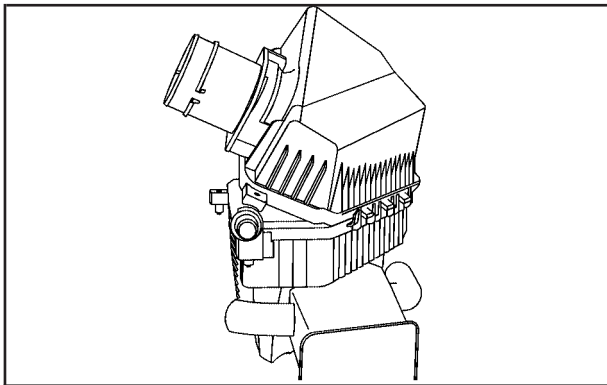

7. Pivot the air cleaner housing cover and remove the cover from the air cleaner housing.

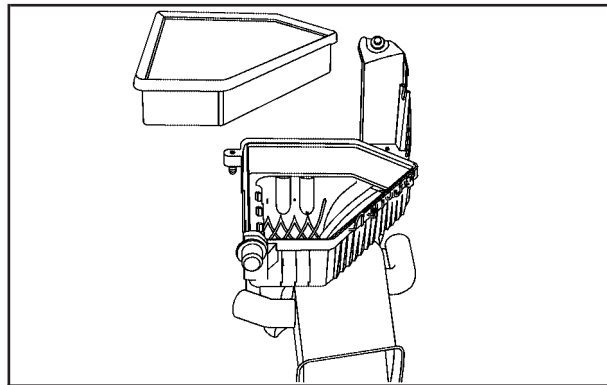

8. Remove the air cleaner element from the air cleaner housing.

How to Reinstall Engine Air Cleaner/Filter

1. Install the air cleaner element to the air cleaner housing. Ensure that the air cleaner element perimeter seal is installed correctly to the air cleaner housing.
2. Align the air cleaner housing cover tabs to the air cleaner housing.
3. Install the air cleaner housing cover.
4. Install the air cleaner housing cover screws.
5. Install the surge tank hose to the air cleaner housing mounting arm. Ensure that the hose is routed correctly.
6. Install the air cleaner outlet duct to the air cleaner housing.
7. Tighten the air cleaner outlet duct screw clamp.
8. Attach electrical connector to airbox.
9. Reinstall side cover.

CAUTION:

Operating the engine with the air cleaner/filter off can cause you or others to be burned. The air cleaner not only cleans the air; it helps to stop flames if the engine backfires. If it is not there and the engine backfires, you could be burned. Do not drive with it off, and be careful working on the engine with the air cleaner/filter off.

Notice: If the air cleaner/filter is off, a backfire can cause a damaging engine fire. And, dirt can easily get into your engine, which will damage it. Always have the air cleaner/filter in place when you are driving.

Automatic Transmission Fluid

How to Check Automatic Transmission Fluid

It is not necessary to check the transmission fluid level. A transmission fluid leak is the only reason for fluid loss. If a leak occurs, take the vehicle to the dealer/retailer service department and have it repaired as soon as possible.

There is a special procedure for checking and changing the transmission fluid. Because this procedure is difficult, you should have this done at the dealer/retailer service department. Contact your dealer/retailer for additional information or the procedure can be found in the service manual. To purchase a service manual, see *Service Publications Ordering Information* on page 7-15.

Notice: Use of the incorrect automatic transmission fluid may damage your vehicle, and the damages may not be covered by your warranty. Always use the automatic transmission fluid listed in *Recommended Fluids and Lubricants* on page 6-11.

Change the fluid and filter at the intervals listed in *Additional Required Services* on page 6-5, and be sure to use the fluid listed in *Recommended Fluids and Lubricants* on page 6-11.

Manual Transmission Fluid

When to Check Manual Transmission Fluid

It is not necessary to check the manual transmission fluid level. A transmission fluid leak is the only reason for fluid loss. If a leak occurs, take the vehicle to your dealer/retailer service department and have it repaired as soon as possible.

How to Check Manual Transmission Fluid

Because this operation can be difficult, you may choose to have this done at your dealer/retailer service department.

If you do it yourself, be sure to follow all the instructions here, or you could get a false reading.

Notice: Too much or too little fluid can damage your transmission. Too much can mean that some of the fluid could come out and fall on hot engine parts or exhaust system parts, starting a fire. Too little fluid could cause the transmission to overheat. Be sure to get an accurate reading if you check your transmission fluid.

Check the fluid level only when your engine is off, the vehicle is parked on a level place and the transmission is cool enough for you to rest your fingers on the transmission case.

To check the fluid level, do the following:

1. Remove the filler plug.
2. Check that the lubricant level is up to the bottom of the filler plug hole.
3. If the fluid level is good, replace the gasket and reinstall the filler plug.

With either vehicle, be sure the plug is fully seated. If the fluid level is low, add more fluid as described in the next steps.

How to Add Manual Transmission Fluid

Here is how to add fluid. See *Recommended Fluids and Lubricants on page 6-11* to determine which type of fluid to use.

1. Remove the filler plug.
2. Add fluid at the filler plug hole. Add only enough fluid to bring the fluid level up to the bottom of the filler plug hole.
3. Replace the gasket and reinstall the filler plug.
Be sure the plug is fully seated.

Hydraulic Clutch

It is not necessary to regularly check clutch fluid unless you suspect there is a leak in the system. Adding fluid will not correct a leak.

A fluid loss in this system could indicate a problem. Have the system inspected and repaired.

When to Check and What to Use

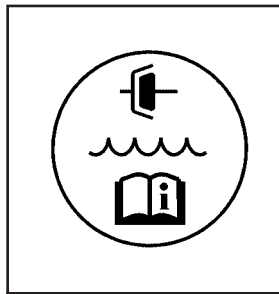

The hydraulic clutch fluid reservoir cap has this symbol on it. See *Engine Compartment Overview on page 5-14* for reservoir location.

Refer to the Maintenance Schedule to determine how often you should check the fluid level in your clutch master cylinder reservoir and for the proper fluid to use. See *Owner Checks and Services on page 6-8* and *Recommended Fluids and Lubricants on page 6-11*.

How to Check and Add Fluid

Make sure the fluid level is at the MIN (Minimum) line on the side of the reservoir. If it is not, remove the cap and add the proper fluid until the level reaches the MIN line.

Engine Coolant

The cooling system in your vehicle is filled with DEX-COOL[®] engine coolant. This coolant is designed to remain in your vehicle for five years or 150,000 miles (240 000 km), whichever occurs first, if you add only DEX-COOL[®] extended life coolant.

The following explains the cooling system and how to add coolant when it is low. If the engine overheats, see *Engine Overheating on page 5-30*.

A 50/50 mixture of clean, drinkable water and DEX-COOL[®] coolant will:

- Give freezing protection down to -34°F (-37°C).
- Give boiling protection up to 265°F (129°C).
- Protect against rust and corrosion.
- Help keep the proper engine temperature.
- Allow the warning lights and gages to work as they should.

Notice: Using coolant other than DEX-COOL[®] may cause premature engine, heater core, or radiator corrosion. In addition, the engine coolant may require changing sooner, at the first maintenance service after each 30,000 miles (50 000 km) or 24 months, whichever occurs first. Any repairs would not be covered by your warranty. Always use DEX-COOL[®] (silicate-free) coolant in your vehicle.

What to Use

Use a mixture of one-half clean, drinkable water and one-half DEX-COOL[®] coolant which will not damage aluminum parts. If you use this coolant mixture, you do not need to add anything else.

CAUTION:

Adding only plain water to your cooling system can be dangerous. Plain water, or some other liquid such as alcohol, can boil before the proper coolant mixture will. Your vehicle's coolant warning system is set for the proper coolant mixture. With plain water or the wrong mixture, your engine could get too hot but you would not get the overheat warning. Your engine could catch fire and you or others could be burned. Use a 50/50 mixture of clean, drinkable water and DEX-COOL[®] coolant.

Notice: If you use an improper coolant mixture, your engine could overheat and be badly damaged. The repair cost would not be covered by your warranty. Too much water in the mixture can freeze and crack the engine, radiator, heater core, and other parts.

If you have to add coolant more than once or twice a year, have your dealer/retailer check your cooling system.

Notice: If you use extra inhibitors and/or additives in your vehicle's cooling system, you could damage your vehicle. Use only the proper mixture of the engine coolant listed in this manual for the cooling system. See *Recommended Fluids and Lubricants* on page 6-11 for more information.

Checking Coolant

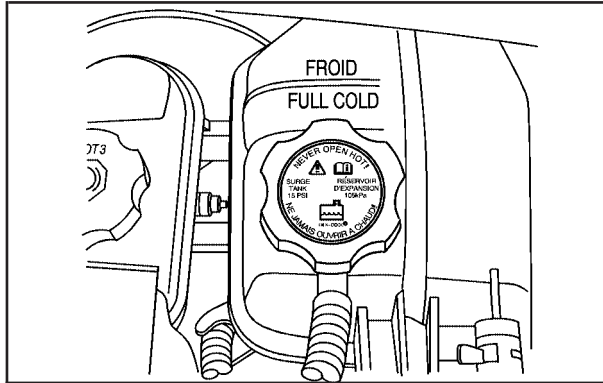

The coolant surge tank and pressure cap are located on the driver's side of the vehicle, toward the rear of the engine compartment. See *Engine Compartment Overview* on page 5-14 for more information on location.

CAUTION:

Turning the surge tank pressure cap when the engine and radiator are hot can allow steam and scalding liquids to blow out and burn you badly. Never turn the surge tank pressure cap — even a little — when the engine and radiator are hot.

The vehicle must be on a level surface. When your engine is cold, the coolant level should be at the FROID/FULL COLD line on the side of the surge tank. Follow the arrow from the top of the tank down the side to the horizontal mark.

Adding Coolant

If more coolant is needed, add the proper DEX-COOL[®] coolant mixture at the surge tank, but only when the engine is cool.

CAUTION:

You can be burned if you spill coolant on hot engine parts. Coolant contains ethylene glycol, and it will burn if the engine parts are hot enough. Do not spill coolant on a hot engine.

When replacing the pressure cap, make sure it is hand-tight and fully seated.

Coolant Surge Tank Pressure Cap

Notice: If the pressure cap is not tightly installed, coolant loss and possible engine damage may occur. Be sure the cap is properly and tightly secured.

The coolant surge tank pressure cap must be fully installed on the coolant surge tank. See *Engine Compartment Overview* on page 5-14 for more information on location.

Engine Overheating

There are two engine hot messages that may be displayed in the Driver Information Center (DIC). See *DIC Warnings and Messages* on page 3-54 for more information.

If Steam Is Coming From Your Engine

CAUTION:

Steam from an overheated engine can burn you badly, even if you just open the hood. Stay away from the engine if you see or hear steam coming from it. Turn it off and get everyone away from the vehicle until it cools down. Wait until there is no sign of steam or coolant before you open the hood.

If you keep driving when the vehicle's engine is overheated, the liquids in it can catch fire. You or others could be badly burned. Stop your engine if it overheats, and get out of the vehicle until the engine is cool.

See *Overheated Engine Protection Operating Mode on page 5-32* for information on driving to a safe place in an emergency.

Notice: If your engine catches fire because you keep driving with no coolant, your vehicle can be badly damaged. The costly repairs would not be covered by your warranty. See *Overheated Engine Protection Operating Mode on page 5-32* for information on driving to a safe place in an emergency.

If No Steam Is Coming From Your Engine

An Engine Overheated Idle Engine warning, along with low coolant, can indicate a serious problem.

If you get an Engine Overheated Idle Engine warning, but see or hear no steam, the problem may not be too serious. Sometimes the engine can get a little too hot when you:

- Climb a long hill on a hot day.
- Stop after high-speed driving.
- Idle for long periods in traffic.
- Tow a trailer.

If you get the Engine Overheated Idle Engine warning with no sign of steam, try this for a minute or so:

1. In heavy traffic, let the engine idle in NEUTRAL (N) while stopped. If it is safe to do so, pull off the road, shift to PARK (P) or NEUTRAL (N) and let the engine idle.
2. Set the climate controls to the highest heat setting and fan speed and open the windows, as necessary.

If you no longer have the Engine Overheated Idle Engine warning, you can drive. Just to be safe, drive slower for about 10 minutes. If the warning does not come back on, you can drive normally.

If the warning continues and you have not stopped, pull over, stop, and park your vehicle right away.

If there is still no sign of steam, you can idle the engine for three minutes while you are parked. If you still have the warning, *turn off the engine and get everyone out of the vehicle* until it cools down.

You may decide not to lift the hood but to get service help right away.

Overheated Engine Protection Operating Mode

This operating mode allows your vehicle to be driven to a safe place in an emergency. Should a hot engine condition exist, an overheat protection mode which alternates firing groups of cylinders helps prevent engine damage. In this mode, there is a loss in power and engine performance. Driving extended miles (km) and/or towing a trailer in the overheat protection mode should be avoided.

Notice: After driving in the overheated engine protection operating mode, to avoid engine damage, allow the engine to cool before attempting any repair. The engine oil will be severely degraded. Repair the cause of coolant loss and change the oil. See *Engine Oil on page 5-16*.

Cooling System

When you decide it is safe to lift the hood, here is what you will see:

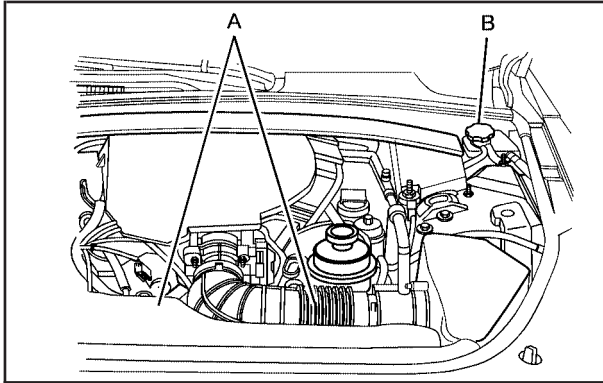

- A. Electric Engine Cooling Fans (Out of View)
- B. Coolant Surge Tank and Pressure Cap

CAUTION:

An electric engine cooling fan under the hood can start up even when the engine is not running and can injure you. Keep hands, clothing, and tools away from any underhood electric fan.

If the coolant inside the coolant surge tank is boiling, do not do anything else until it cools down. The vehicle should be parked on a level surface.

If the engine is warm or hot, the coolant level should be at or above the FROID/FULL COLD line on the side of the coolant surge tank. If the engine is cold, the coolant level should be near the FROID/FULL COLD line on the side of the coolant surge tank. If it is not, you could have a leak at the pressure cap or in the radiator hoses, heater hoses, radiator, water pump, or somewhere else in the cooling system.

 **CAUTION:**

Heater and radiator hoses, and other engine parts, can be very hot. Do not touch them. If you do, you can be burned.

Do not run the engine if there is a leak. If you run the engine, it could lose all coolant. That could cause an engine fire, and you could be burned. Get any leak fixed before you drive the vehicle.

If there seems to be no leak, with the engine on, check to see if the electric engine cooling fans are running. If the engine hot light is on, both fans should be running. If they are not, your vehicle needs service.

Notice: Engine damage from running your engine without coolant is not covered by your warranty. See *Overheated Engine Protection Operating Mode on page 5-32* for information on driving to a safe place in an emergency.

Notice: Using coolant other than DEX-COOL[®] may cause premature engine, heater core, or radiator corrosion. In addition, the engine coolant could require changing sooner, at 30,000 miles (50 000 km) or 24 months, whichever occurs first. Any repairs would not be covered by the warranty. Always use DEX-COOL[®] (silicate-free) coolant in the vehicle.

How to Add Coolant to the Coolant Surge Tank

If you have not found a problem yet, check to see if coolant is visible in the surge tank. If coolant is visible but the coolant level is not at the FROID/FULL COLD line on the side of the coolant surge tank, add a 50/50 mixture of clean, drinkable water and DEX-COOL[®] coolant at the coolant surge tank, but be sure the cooling system, including the coolant surge tank pressure cap, is cool before you do it. See *Engine Coolant* on page 5-27 for more information.

CAUTION:

Steam and scalding liquids from a hot cooling system can blow out and burn you badly. They are under pressure, and if you turn the coolant surge tank pressure cap — even a little — they can come out at high speed. Never turn the cap when the cooling system, including the coolant surge tank pressure cap, is hot. Wait for the cooling system and coolant surge tank pressure cap to cool if you ever have to turn the pressure cap.

CAUTION:

Adding only plain water to the cooling system can be dangerous. Plain water, or some other liquid such as alcohol, can boil before the proper coolant mixture will. The vehicle's coolant warning system is set for the proper coolant mixture. With plain water or the wrong mixture, the engine could get too hot but you would not get the overheat warning. The engine could catch fire and you or others could be burned. Use a 50/50 mixture of clean, drinkable water and DEX-COOL[®] coolant.

Notice: In cold weather, water can freeze and crack the engine, radiator, heater core and other parts. Use the recommended coolant and the proper coolant mixture.

⚠ CAUTION:

You can be burned if you spill coolant on hot engine parts. Coolant contains ethylene glycol and it will burn if the engine parts are hot enough. Do not spill coolant on a hot engine.

If no coolant is visible in the surge tank, add coolant as follows:

1. Remove the coolant surge tank pressure cap when the cooling system, including the coolant surge tank pressure cap and upper radiator hose, is no longer hot. Turn the pressure cap slowly counterclockwise about one-quarter turn and then stop.

If you hear a hiss, wait for that to stop. A hiss means there is still some pressure left.

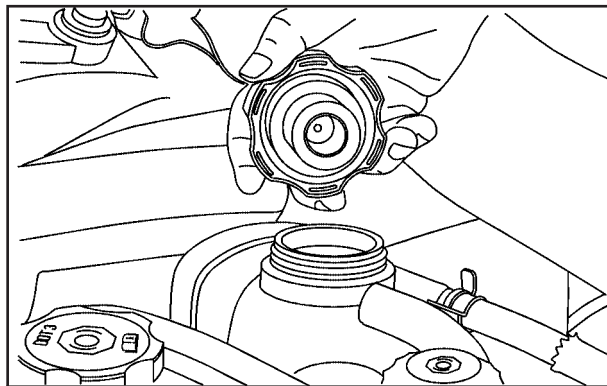

2. Then keep turning the pressure cap slowly, and remove it.

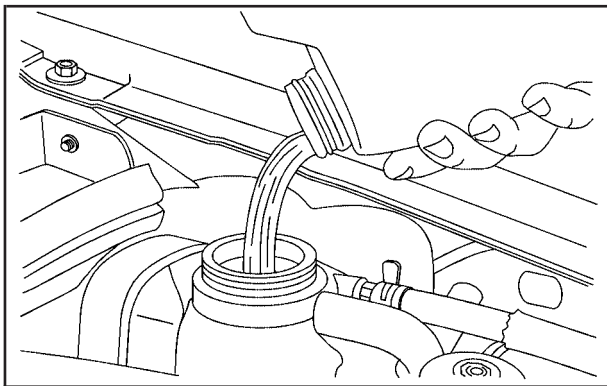

3. Fill the coolant surge tank with the proper mixture, to slightly above the FROID/FULL COLD line on the side of the coolant surge tank.

4. With the coolant surge tank pressure cap off, start the engine and let it run until you can feel the upper radiator hose getting hot. The upper radiator hose is the top hose coming out of the radiator, on the passenger's side of the vehicle. Watch out for the engine cooling fans.

By this time, the coolant level inside the coolant surge tank may be lower. If the level is lower, add more of the proper mixture to the coolant surge tank until the level reaches the FROID/FULL COLD line on the side of the coolant surge tank.

5. Then replace the pressure cap. Be sure the pressure cap is hand-tight and fully seated.

Recheck the coolant level in the bottle next time you use your vehicle to insure the system is full when cold. See *Engine Coolant* on page 5-27.

Power Steering Fluid

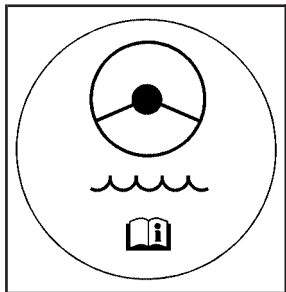

See *Engine Compartment Overview on page 5-14* for the location of the power steering fluid reservoir.

When to Check Power Steering Fluid

It is not necessary to regularly check power steering fluid unless you suspect there is a leak in the system or you hear an unusual noise. A fluid loss in this system could indicate a problem. Have the system inspected and repaired.

How to Check Power Steering Fluid

To check the power steering fluid, do the following:

1. Turn the key off and let the engine compartment cool down.
2. Wipe the cap and the top of the reservoir clean.
3. Unscrew the cap and wipe the dipstick with a clean rag.
4. Replace the cap and completely tighten it.
5. Remove the cap again and look at the fluid level on the dipstick.

The level should be at the FULL COLD mark. If necessary, add only enough fluid to bring the level up to the mark.

What to Use

To determine what kind of fluid to use, see *Recommended Fluids and Lubricants on page 6-11*. Always use the proper fluid.

Notice: Use of the incorrect fluid may damage your vehicle and the damages may not be covered by your warranty. Always use the correct fluid listed in *Recommended Fluids and Lubricants on page 6-11*.

Windshield Washer Fluid

What to Use

When you need windshield washer fluid, be sure to read the manufacturer's instructions before use. If you will be operating your vehicle in an area where the temperature may fall below freezing, use a fluid that has sufficient protection against freezing.

Adding Washer Fluid

The Washer Fluid Low Add Fluid message will appear on the Driver Information Center (DIC) when the fluid level is low. See *DIC Warnings and Messages* on page 3-54 for more information.

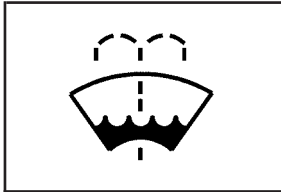

Open the cap with the washer symbol on it. Add washer fluid until the tank is full. See *Engine Compartment Overview* on page 5-14 for reservoir location.

Notice:

- When using concentrated washer fluid, follow the manufacturer's instructions for adding water.
- Do not mix water with ready-to-use washer fluid. Water can cause the solution to freeze and damage your washer fluid tank and other parts of the washer system. Also, water does not clean as well as washer fluid.
- Fill the washer fluid tank only three-quarters full when it is very cold. This allows for fluid expansion if freezing occurs, which could damage the tank if it is completely full.
- Do not use engine coolant (antifreeze) in your windshield washer. It can damage the vehicle's windshield washer system and paint.

Brakes

Brake Fluid

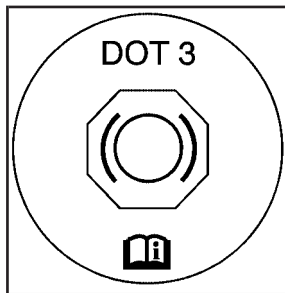

The brake master cylinder reservoir is filled with DOT-3 brake fluid. See *Engine Compartment Overview on page 5-14* for the location of the reservoir.

There are only two reasons why the brake fluid level in the reservoir might go down. The first is that the brake fluid goes down to an acceptable level during normal brake lining wear. When new linings are put in, the fluid level goes back up. The other reason is that fluid is leaking out of the brake hydraulic system. If it is, you should have the brake hydraulic system fixed, since a leak means that sooner or later the brakes will not work well.

It is not a good idea to top off the brake fluid. Adding brake fluid will not correct a leak. If fluid is added when the linings are worn, there will be too much fluid when new brake linings are installed. Add or remove brake fluid, as necessary, only when work is done on the brake hydraulic system.

CAUTION:

If your vehicle has too much brake fluid, it can spill on the engine. The fluid will burn if the engine is hot enough. You or others could be burned, and your vehicle could be damaged. Add brake fluid only when work is done on the brake hydraulic system.

If the ignition is in ON/RUN and the brake fluid is low, the Service Brake System message will be displayed in the DIC. See *DIC Warnings and Messages on page 3-54*.

When the brake fluid falls to a low level, the brake warning light will come on. See *Brake System Warning Light on page 3-37*.

What to Add

When you do need brake fluid, DOT-3 brake fluid is recommended for use. DOT-4 brake fluid is also compatible with your vehicle's brake system parts. However, if you choose to use DOT-4 fluid, it is recommended that you flush the brake hydraulic system and refill it with new DOT-4 fluid at a regular maintenance service every two years. See *Additional Required Services on page 6-5*. Use new brake fluid from a sealed container only. See *Recommended Fluids and Lubricants on page 6-11*.

Always clean the brake fluid reservoir cap and the area around the cap before removing it. This helps keep dirt from entering the reservoir.

CAUTION:

With the wrong kind of fluid in the brake hydraulic system, the brakes might not work well. This could cause a crash. Always use the proper brake fluid.

Notice:

- **Using the wrong fluid can badly damage brake hydraulic system parts. For example, just a few drops of mineral-based oil, such as engine oil, in the brake hydraulic system can damage brake hydraulic system parts so badly that they will have to be replaced. Do not let someone put in the wrong kind of fluid.**
- **If you spill brake fluid on your vehicle's painted surfaces, the paint finish can be damaged. Be careful not to spill brake fluid on your vehicle. If you do, wash it off immediately. See *Washing Your Vehicle on page 5-115*.**

Brake Wear

Your vehicle has disc brakes. Disc brake pads have built-in wear indicators that make a high-pitched warning sound when the brake pads are worn and new pads are needed. The sound can come and go or be heard all the time your vehicle is moving, except when you are pushing on the brake pedal firmly.

CAUTION:

The brake wear warning sound means that soon the brakes will not work well. That could lead to an accident. When you hear the brake wear warning sound, have your vehicle serviced.

Notice: Continuing to drive with worn-out brake pads could result in costly brake repair.

Some driving conditions or climates can cause a brake squeal when the brakes are first applied or lightly applied. This does not mean something is wrong with the brakes.

Properly torqued wheel nuts are necessary to help prevent brake pulsation. When tires are rotated, inspect brake pads for wear and evenly tighten wheel nuts in the proper sequence to torque specifications in *Capacities and Specifications on page 5-128*.

Brake linings should always be replaced as complete axle sets.

Brake Pedal Travel

See your dealer/retailer if the brake pedal does not return to normal height, or if there is a rapid increase in pedal travel. This could be a sign that brake service might be required.

Brake Adjustment

Every time you apply the brakes, with or without the vehicle moving, the brakes adjust for wear.

Replacing Brake System Parts

The braking system on a vehicle is complex. Its many parts have to be of top quality and work well together if the vehicle is to have really good braking. Your vehicle was designed and tested with top-quality brake parts. When you replace parts of the braking system — for example, when the brake linings wear down and you need new ones put in — be sure you get new approved replacement parts. If you do not, the brakes might not work properly. For example, if someone puts in brake linings that are wrong for your vehicle, the balance between the front and rear brakes can change — for the worse. The braking performance you have come to expect can change in many other ways if someone puts in the wrong replacement brake parts.

Battery

Your vehicle has a maintenance free battery. It is located in the trunk, behind the trim panel, on the passenger side of the vehicle. When it is time for a new battery, see your dealer/retailer for one that has the replacement number shown on the original battery's label.

Warning: Battery posts, terminals, and related accessories contain lead and lead compounds, chemicals known to the State of California to cause cancer and reproductive harm. Wash hands after handling.

After a power loss, such as disconnecting the battery or removing the maxi fuses in the power distribution fuse block, the following steps must be performed to calibrate the electronic throttle control. If this is not done, the engine will not run properly.

1. Turn the ignition to ON/RUN. Do not start the engine.
2. Leave the ignition in ON/RUN for at least three minutes so that the electronic throttle control will cycle and re-learn its home position.
3. Turn the ignition to LOCK/OFF.
4. Start and run the engine for at least 30 seconds.

Vehicle Storage

CAUTION:

Batteries have acid that can burn you and gas that can explode. You can be badly hurt if you are not careful. See *Jump Starting on page 5-44* for tips on working around a battery without getting hurt.

Infrequent Usage: If you drive your vehicle infrequently, remove the black, negative (–) cable from the battery. This will help keep the battery from running down.

Extended Storage: For extended storage of your vehicle, remove the black, negative (–) cable from the battery or use a battery trickle charger. This will help maintain the charge of the battery over an extended period of time.

Jump Starting

If your vehicle's battery has run down, you may want to use another vehicle and some jumper cables to start your vehicle. Be sure to use the following steps to do it safely.

CAUTION:

Batteries can hurt you. They can be dangerous because:

- They contain acid that can burn you.
- They contain gas that can explode or ignite.
- They contain enough electricity to burn you.

If you do not follow these steps exactly, some or all of these things can hurt you.

Notice: Ignoring these steps could result in costly damage to your vehicle that would not be covered by your warranty.

Trying to start your vehicle by pushing or pulling it will not work, and it could damage your vehicle.

1. Check the other vehicle. It must have a 12-volt battery with a negative ground system.

Notice: If the other vehicle's system is not a 12-volt system with a negative ground, both vehicles can be damaged. Only use vehicles with 12-volt systems with negative grounds to jump start your vehicle.

2. Get the vehicles close enough so the jumper cables can reach, but be sure the vehicles are not touching each other. If they are, it could cause a ground connection you do not want. You would not be able to start your vehicle and the bad grounding could damage the electrical systems.

To avoid the possibility of the vehicles rolling, set the parking brake firmly on both vehicles involved in the jump start procedure. Put an automatic transmission in PARK (P) or a manual transmission in NEUTRAL before setting the parking brake.

Notice: If you leave your radio or other accessories on during the jump starting procedure, they could be damaged. The repairs would not be covered by your warranty. Always turn off your radio and other accessories when jump starting your vehicle.

3. Turn off the ignition on both vehicles. Unplug unnecessary accessories plugged into the cigarette lighter or the accessory power outlets. Turn off the radio and all lamps that are not needed. This will avoid sparks and help save both batteries. And it could save the radio!
4. Open the hoods and locate the positive (+) and negative (-) terminal locations or the remote positive (+) and remote negative (-) terminals of the other vehicle. Then locate the remote positive (+) location on your vehicle. See *Engine Compartment Overview on page 5-14* for more information on locations the terminals.

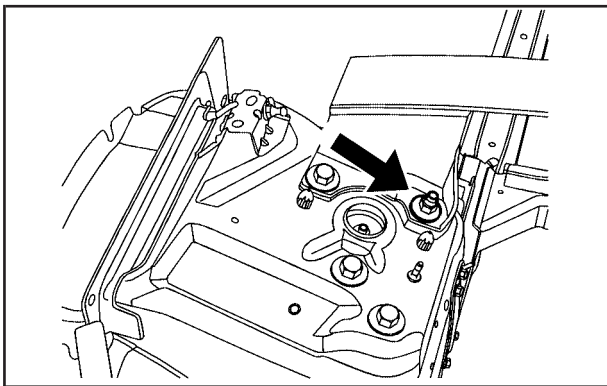

Your vehicle has a remote negative (–) ground location, as shown in the illustration. It is located on the rear passenger side of the vehicle. See *Engine Compartment Overview* on page 5-14. You should always use this remote ground location, instead of the terminal on the battery.

Notice: If you connect a negative cable to the Engine Control Module (ECM), ECM mounting bracket, or any cables that attach to the ECM bracket, you may damage the ECM. Always attach the negative cable to your vehicle's remote negative ground location, instead of the ECM, ECM bracket, or any cables attached to the ECM bracket.

⚠ CAUTION:

An electric fan can start up even when the engine is not running and can injure you. Keep hands, clothing and tools away from any underhood electric fan.

 **CAUTION:**

Using a match near a battery can cause battery gas to explode. People have been hurt doing this, and some have been blinded. Use a flashlight if you need more light.

Be sure the battery has enough water. You do not need to add water to the battery installed in your new vehicle. But if a battery has filler caps, be sure the right amount of fluid is there. If it is low, add water to take care of that first. If you do not, explosive gas could be present.

Battery fluid contains acid that can burn you. Do not get it on you. If you accidentally get it in your eyes or on your skin, flush the place with water and get medical help immediately.

 **CAUTION:**

Fans or other moving engine parts can injure you badly. Keep your hands away from moving parts once the engine is running.

5. Check that the jumper cables do not have loose or missing insulation. If they do, you could get a shock. The vehicles could be damaged too.
Before you connect the cables, here are some basic things you should know. Positive (+) will go to positive (+) or to a remote positive (+) terminal if the vehicle has one. Negative (-) will go to a heavy, unpainted metal engine part or to a remote negative (-) terminal if the vehicle has one.
Do not connect positive (+) to negative (-) or you will get a short that would damage the battery and maybe other parts too. And do not connect the negative (-) cable to the negative (-) terminal on the dead battery because this can cause sparks.

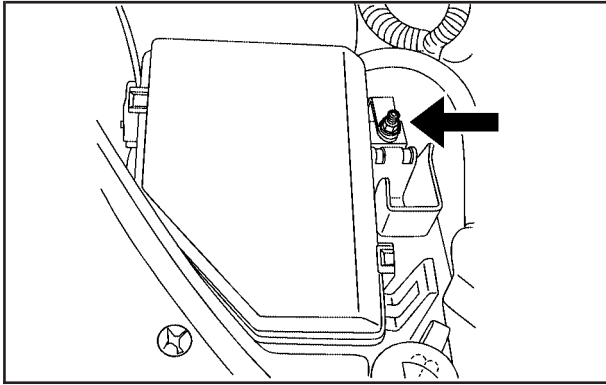

6. Connect the red positive (+) cable to the positive (+) terminal of the dead battery. Use a remote positive (+) terminal if the vehicle has one.
7. Do not let the other end touch metal. Connect it to the positive (+) terminal of the good battery. Use a remote positive (+) terminal if the vehicle has one.

8. Now connect the black negative (-) cable to the negative terminal of the good battery. Use a remote negative (-) terminal if the vehicle has one.
Do not let the other end touch anything until the next step. The other end of the negative (-) cable does not go to the dead battery. It goes to a heavy, unpainted metal engine part or to a remote negative (-) terminal on the vehicle with the dead battery.
9. Connect the other end of the negative (-) cable at least 18 inches (45 cm) away from the dead battery, but not near engine parts that move. The electrical connection is just as good there, and the chance of sparks getting back to the battery is much less.
Use a remote negative (-) terminal if the vehicle has one. Your vehicle's remote negative (-) ground location is for this purpose.
10. Now start the vehicle with the good battery and run the engine for a while.
11. Try to start the vehicle that had the dead battery. If it will not start after a few tries, it probably needs service.

Notice: If the jumper cables are connected or removed in the wrong order, electrical shorting may occur and damage the vehicle. The repairs would not be covered by your warranty. Always connect and remove the jumper cables in the correct order, making sure that the cables do not touch each other or other metal.

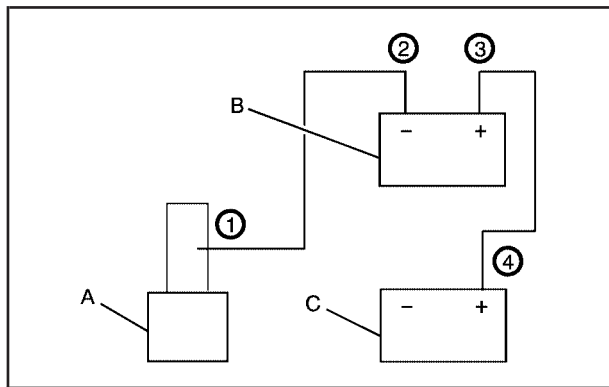

Jumper Cable Removal

- A. Heavy, Unpainted Metal Engine Part or Remote Negative (-) Terminal
- B. Good Battery or Remote Positive (+) and Remote Negative (-) Terminals
- C. Dead Battery or Remote Positive (+) Terminal

To disconnect the jumper cables from both vehicles, do the following:

1. Disconnect the black negative (-) cable from the vehicle that had the dead battery.
2. Disconnect the black negative (-) cable from the vehicle with the good battery.
3. Disconnect the red positive (+) cable from the vehicle with the good battery.
4. Disconnect the red positive (+) cable from the other vehicle.

All-Wheel Drive

If your vehicle is equipped with all-wheel-drive, this is an additional system that needs lubrication.

Transfer Case When to Check Lubricant

It is not necessary to regularly check the transfer case fluid unless you suspect there is a leak or you hear an unusual noise. A fluid loss could indicate a problem. Have it inspected and repaired.

How to Check Lubricant

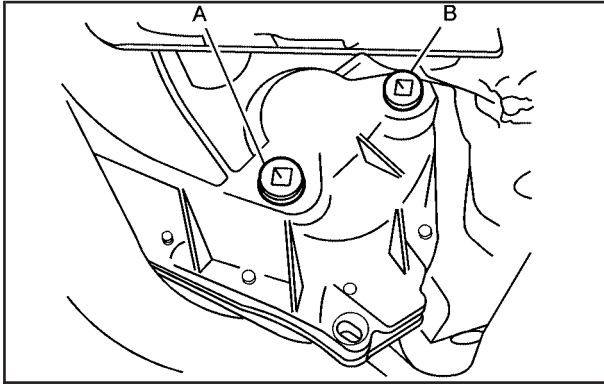

- A. Drain Plug
- B. Fill Plug

To get an accurate reading, the vehicle should be on a level surface.

If the level is below the bottom of the filler plug hole, located on the transfer case, you'll need to add some lubricant. Add enough lubricant to raise the level to the bottom of the filler plug hole. Use care not to overtighten the plug.

What to Use

Refer to the Maintenance Schedule to determine what kind of lubricant to use. See *Recommended Fluids and Lubricants* on page 6-11.

Rear Axle

When to Check Lubricant

It is not necessary to regularly check rear axle fluid unless you suspect there is a leak or you hear an unusual noise. A fluid loss could indicate a problem. Have it inspected and repaired.

How to Check Lubricant

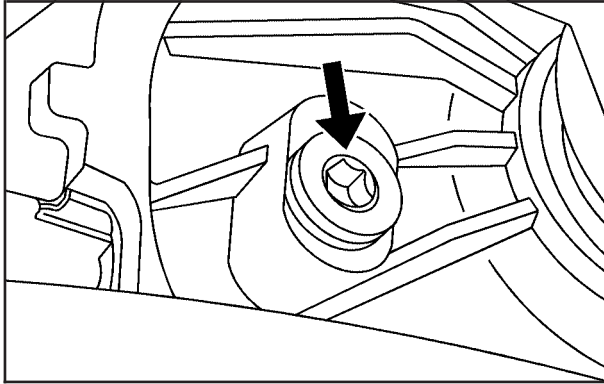

To get an accurate reading, the vehicle should be on a level surface.

If the level is below the bottom of the filler plug hole, located on the rear axle, you'll need to add some lubricant. Add enough lubricant to raise the level to the bottom of the filler plug hole.

What to Use

Refer to the Maintenance Schedule to determine what kind of lubricant to use. See *Recommended Fluids and Lubricants* on page 6-11.

Headlamp Aiming

The vehicle has a visual optical headlamp aiming system. The aim has been preset at the factory and should need no further adjustment.

However, if the vehicle is damaged in a crash, the headlamp aim may be affected and adjustment may be necessary.

If oncoming vehicles flash their high beams at you, this may also mean the vertical aim needs to be adjusted.

It is recommended that the vehicle is taken to your dealer/retailer for service if the headlamps need to be re-aimed. It is possible however, to re-aim the headlamps as described.

The vehicle should:

- Be placed so the headlamps are 25 ft. (7.6 m) from a light colored wall.
- Have all four tires on a level surface which is level all the way to the wall.
- Be placed so it is perpendicular to the wall.
- Not have any snow, ice, or mud on it.
- Be fully assembled and all other work stopped while headlamp aiming is being performed.
- Normally loaded with a full tank of fuel and one person or 160 lbs (75 kg) sitting on the driver seat.
- Have all tires properly inflated.
- Have the spare tire in its original location in the vehicle.

Headlamp aiming is done with the vehicle's low-beam headlamps. The high-beam headlamps will be correctly aimed if the low-beam headlamps are aimed properly.

To adjust the vertical aim:

1. Open the hood. See *Hood Release* on page 5-13 for more information.

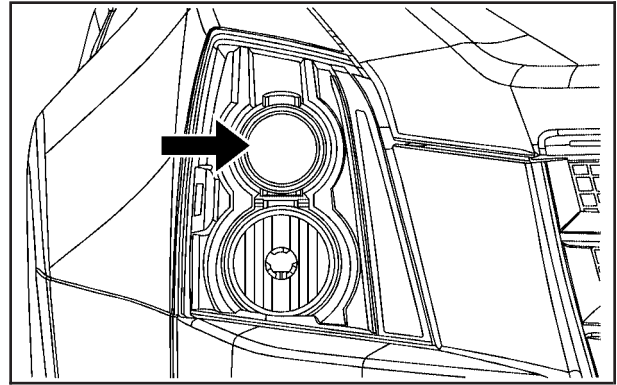

Base Level

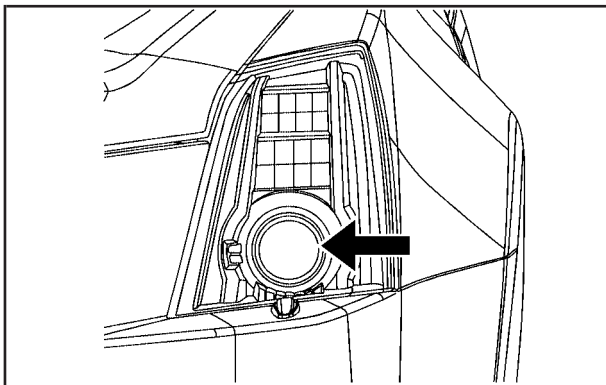

Uplevel

2. Locate the aim dot on the lens of the low-beam headlamp.
3. Record the distance from the ground to the aim dot on the low-beam headlamp.

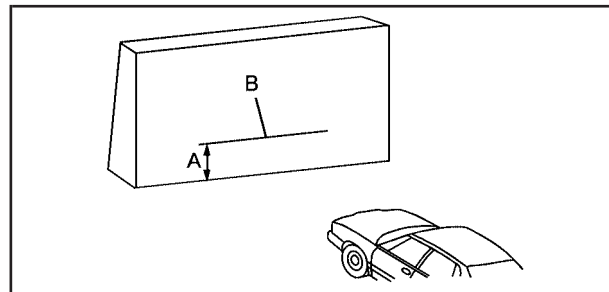

4. At a wall, measure from the ground upward (A) to the recorded distance from Step 3 and mark it.
5. Draw or tape a horizontal line (B) the width of the vehicle at the wall where it was marked in Step 4.

Notice: Do not cover a headlamp to improve beam cut-off when aiming. Covering a headlamp may cause excessive heat build-up which may cause damage to the headlamp.

6. Turn on the low-beam headlamps and place a piece of cardboard or equivalent in front of the headlamp not being aimed. This should allow only the beam of light from the headlamp being aimed to be seen on the flat surface.

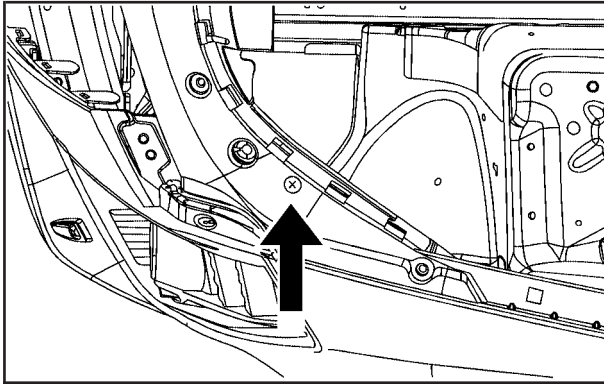

Passenger's Side Shown

7. Locate the vertical headlamp aiming screws, which are under the hood near each headlamp assembly. The adjustment screw can be turned with a 6 mm hex socket.
8. Turn the vertical aiming screw until the headlamp beam is aimed to the horizontal tape line. Turn it clockwise or counterclockwise to raise or lower the angle of the beam.
The top edge of the cut-off should be positioned at the bottom edge of the horizontal tape line.

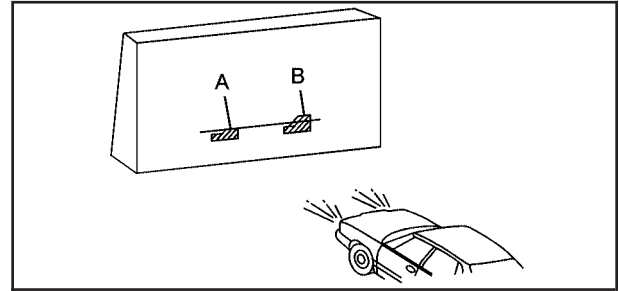

9. Make sure that the light from the headlamp is positioned at the bottom edge of the horizontal tape line. The lamp on the left (A) shows the correct headlamp aim. The lamp on the right (B) shows the incorrect headlamp aim.
10. Repeat Steps 7 through 9 for the opposite headlamp.

Bulb Replacement

For the proper type of replacement bulbs, see *Replacement Bulbs* on page 5-57.

For any bulb changing procedure not listed in this section, contact your dealer/retailer.

High Intensity Discharge (HID) Lighting

CAUTION:

The low beam high intensity discharge lighting system operates at a very high voltage. If you try to service any of the system components, you could be seriously injured. Have your dealer/retailer or a qualified technician service them.

Your vehicle has HID headlamps. After your vehicle's HID headlamp bulb has been replaced, you may notice that the beam is a slightly different shade than it was originally. This is normal.

Halogen Bulbs

CAUTION:

Halogen bulbs have pressurized gas inside and can burst if you drop or scratch the bulb. You or others could be injured. Be sure to read and follow the instructions on the bulb package.

Front Turn Signal and Fog Lamps

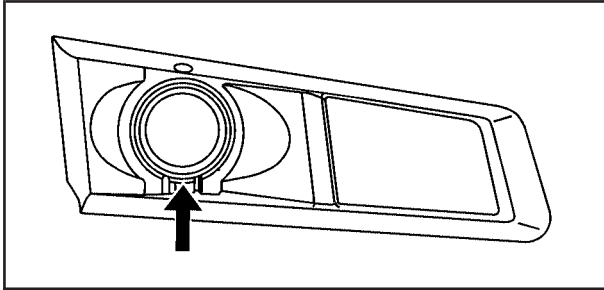

To replace fog lamp bulb:

1. Pull out the push-pins located on the underside of the protection shield to remove the shield.
2. Reach up behind the front bumper area from under the vehicle to access the lamp housing.
3. Remove the bulb socket from the housing by turning the bulb socket one-quarter turn counterclockwise.
4. Remove the electrical connector from the bulb by lifting the two plastic clips.
5. Pull the old bulb from the bulb socket keeping the bulb straight as you pull it out.
6. Install a new bulb.
7. Reverse the steps to reinstall the lamp assembly.

License Plate Lamp

To replace one of these bulbs, do the following:

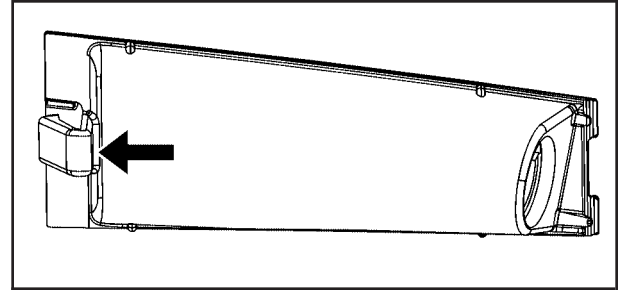

1. Push tabs to remove the license plate lamp.
2. Turn the license plate lamp assembly down to remove it.
3. Turn the socket counterclockwise and remove it.
4. Pull the bulb straight out to remove it.
5. Push the new bulb straight into the socket.
6. Reverse Steps 1 through 3 to reinstall the license plate lamp assembly.

Replacement Bulbs

Exterior Lamp	Bulb Number
Front Turn Signal	3157K
Fog Lamp (Uplevel Only)	H11LL
License Plate Lamp	W5WLL

For replacement bulbs not listed here, contact your dealer/retailer.

Windshield Wiper Blade Replacement

Windshield wiper blades should be inspected for wear or cracking. See *Owner Checks and Services on page 6-8*.

It is a good idea to clean or replace the wiper blade assembly on a regular basis or when worn. For proper windshield wiper blade length and type, see *Maintenance Replacement Parts on page 6-13*.

To replace the wiper blade assembly:

1. Turn the ignition to ON/RUN with the engine off.
2. Turn on the windshield wipers and turn them off again when the wipers are in the out-wipe position. The driver side blade will be straight up and down on the windshield.
3. Pull the windshield wiper assembly away from the windshield.

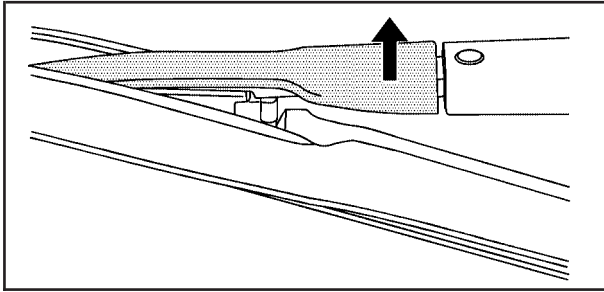

4. Lift up the wiper blade assembly cap.
5. Pull the wiper blade assembly down far enough to release it from the J-hooked end of the wiper arm. Slide the assembly away from the arm.
Allowing the wiper blade arm to touch the windshield when no wiper blade is installed could damage the windshield. Any damage that occurs would not be covered by your warranty. Do not allow the wiper blade arm to touch the windshield.
6. Replace the blade with a new one.

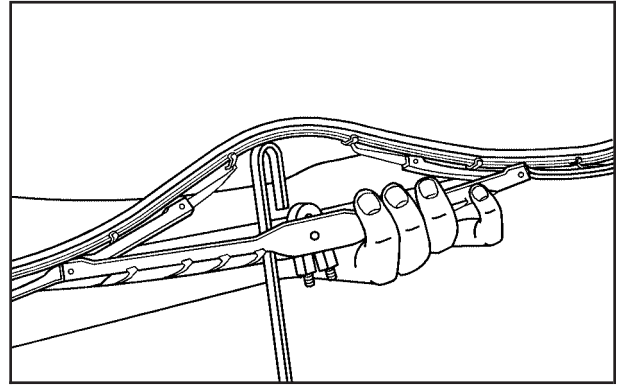

7. Reinstall the wiper blade assembly by sliding it over the wiper arm to engage the J-hooked end. Pull up on the assembly to lock it into place.
8. Repeat the steps for the other wiper.

Tires

Your new vehicle comes with high-quality tires made by a leading tire manufacturer. If you ever have questions about your tire warranty and where to obtain service, see your vehicle Warranty booklet for details.

CAUTION:

- Poorly maintained and improperly used tires are dangerous.
- Overloading your tires can cause overheating as a result of too much flexing. You could have an air-out and a serious accident. See *Loading Your Vehicle on page 4-22*.

CAUTION: (Continued)

CAUTION: (Continued)

- Underinflated tires pose the same danger as overloaded tires. The resulting accident could cause serious injury. Check all tires frequently to maintain the recommended pressure. Tire pressure should be checked when your tires are cold. See *Inflation - Tire Pressure on page 5-67*.
- Overinflated tires are more likely to be cut, punctured, or broken by a sudden impact — such as when you hit a pothole. Keep tires at the recommended pressure.
- Worn, old tires can cause accidents. If your tread is badly worn, or if your tires have been damaged, replace them.

See *High-Speed Operation on page 5-69* for inflation pressure adjustment for high speed driving.

Low-Profile Tires

If your vehicle has 235/50ZR18 or P235/50R18 size tires, they are classified as low-profile tires. These tires are designed for very responsive driving on wet or dry pavement. You may also notice more road noise with low-profile performance tires and that they tend to wear faster.

Notice: If your vehicle has low-profile tires, they are more susceptible to damage from road hazards or curb impact than standard profile tires. Tire and/or wheel assembly damage can occur when coming into contact with road hazards like, potholes, or sharp edged objects, or when sliding into a curb. Your vehicle warranty does not cover this type of damage. Keep tires set to the correct inflation pressure and, when possible avoid contact with curbs, potholes, and other road hazards.

Winter Tires

If you expect to drive on snow or ice covered roads often, you may want to get winter tires for your vehicle. All season tires provide good overall performance on most surfaces but they may not offer the traction you would like or the same level of performance as winter tires on snow or ice covered roads.

Winter tires, in general, are designed for increased traction on snow and ice covered roads. With winter tires, there may be decreased dry road traction, increased road noise, and shorter tread life. After switching to winter tires, be alert for changes in vehicle handling and braking.

See your dealer/retailer for details regarding winter tire availability and proper tire selection. Also, see *Buying New Tires on page 5-77*.

If you choose to use winter tires:

- Use tires of the same brand and tread type on all four wheel positions.
- Use only radial ply tires of the same size, load range, and speed rating as the original equipment tires.

Winter tires with the same speed rating as your original equipment tires may not be available for H, V, W, Y, and ZR speed rated tires. If you choose winter tires with a lower speed rating, never exceed the tire's maximum speed capability.

Tire Sidewall Labeling

Useful information about a tire is molded into its sidewall. The examples below show a typical passenger vehicle tire and a compact spare tire sidewall.

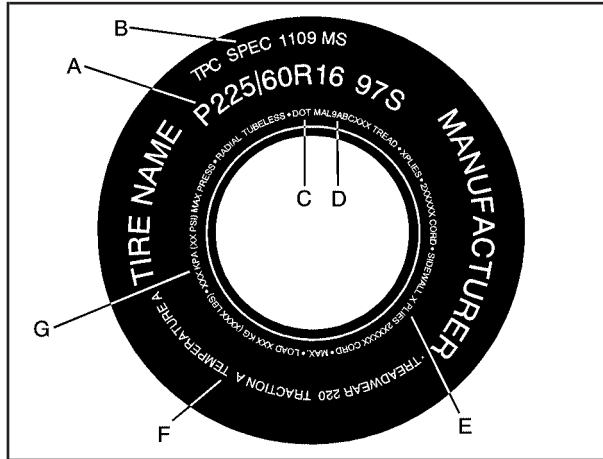

Passenger (P-Metric) Tire Example

(A) Tire Size: The tire size is a combination of letters and numbers used to define a particular tire's width, height, aspect ratio, construction type, and service description. See the "Tire Size" illustration later in this section for more detail.

(B) TPC Spec (Tire Performance Criteria Specification): Original equipment tires designed to GM's specific tire performance criteria have a TPC specification code molded onto the sidewall. GM's TPC specifications meet or exceed all federal safety guidelines.

(C) DOT (Department of Transportation): The Department of Transportation (DOT) code indicates that the tire is in compliance with the U.S. Department of Transportation Motor Vehicle Safety Standards.

(D) Tire Identification Number (TIN): The letters and numbers following DOT (Department of Transportation) code is the Tire Identification Number (TIN). The TIN shows the manufacturer and plant code, tire size, and date the tire was manufactured. The TIN is molded onto both sides of the tire, although only one side may have the date of manufacture.

(E) Tire Ply Material: The type of cord and number of plies in the sidewall and under the tread.

(F) Uniform Tire Quality Grading (UTQG): Tire manufacturers are required to grade tires based on three performance factors: treadwear, traction, and temperature resistance. For more information see *Uniform Tire Quality Grading* on page 5-80.

(G) Maximum Cold Inflation Load Limit: Maximum load that can be carried and the maximum pressure needed to support that load.

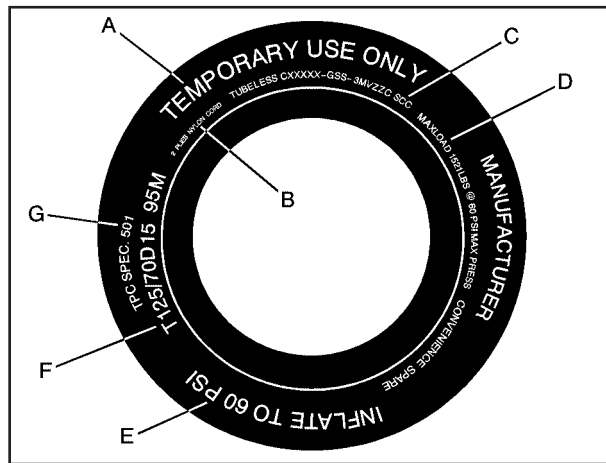

Compact Spare Tire Example

(A) Temporary Use Only: The compact spare tire or temporary use tire has a tread life of approximately 3,000 miles (5 000 km) and should not be driven at speeds over 65 mph (105 km/h). The compact spare tire is for emergency use when a regular road tire has lost air and gone flat. If your vehicle has a compact spare tire, see *Compact Spare Tire* on page 5-111 and *If a Tire Goes Flat* on page 5-83.

(B) Tire Ply Material: The type of cord and number of plies in the sidewall and under the tread.

(C) Tire Identification Number (TIN): The letters and numbers following the DOT (Department of Transportation) code is the Tire Identification Number (TIN). The TIN shows the manufacturer and plant code, tire size, and date the tire was manufactured. The TIN is molded onto both sides of the tire, although only one side may have the date of manufacture.

(D) Maximum Cold Inflation Load Limit: Maximum load that can be carried and the maximum pressure needed to support that load.

(E) Tire Inflation: The temporary use tire or compact spare tire should be inflated to 60 psi (420 kPa). For more information on tire pressure and inflation see *Inflation - Tire Pressure on page 5-67*.

(F) Tire Size : A combination of letters and numbers define a tire's width, height, aspect ratio, construction type, and service description. The letter T as the first character in the tire size means the tire is for temporary use only.

(G) TPC Spec (Tire Performance Criteria Specification): Original equipment tires designed to GM's specific tire performance criteria have a TPC specification code molded onto the sidewall. GM's TPC specifications meet or exceed all federal safety guidelines.

Tire Size

The following illustration shows an example of a typical passenger vehicle tire size.

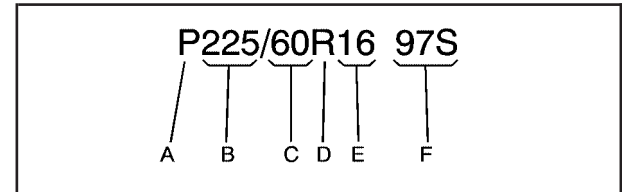

(A) Passenger (P-Metric) Tire: The United States version of a metric tire sizing system. The letter P as the first character in the tire size means a passenger vehicle tire engineered to standards set by the U.S. Tire and Rim Association.

(B) Tire Width: The three-digit number indicates the tire section width in millimeters from sidewall to sidewall.

(C) Aspect Ratio: A two-digit number that indicates the tire height-to-width measurements. For example, if the tire size aspect ratio is 60, as shown in item C of the illustration, it would mean that the tire's sidewall is 60 percent as high as it is wide.

(D) Construction Code: A letter code is used to indicate the type of ply construction in the tire. The letter R means radial ply construction; the letter D means diagonal or bias ply construction; and the letter B means belted-bias ply construction.

(E) Rim Diameter: Diameter of the wheel in inches.

(F) Service Description: These characters represent the load range and speed rating of the tire. The load index represents the load carry capacity a tire is certified to carry. The load index can range from 1 to 279. The speed rating is the maximum speed a tire is certified to carry a load. Speed ratings range from A to Z.

Tire Terminology and Definitions

Air Pressure: The amount of air inside the tire pressing outward on each square inch of the tire. Air pressure is expressed in pounds per square inch (psi) or kilopascal (kPa).

Accessory Weight: This means the combined weight of optional accessories. Some examples of optional accessories are, automatic transmission, power steering, power brakes, power windows, power seats, and air conditioning.

Aspect Ratio: The relationship of a tire's height to its width.

Belt: A rubber coated layer of cords that is located between the plies and the tread. Cords may be made from steel or other reinforcing materials.

Bead: The tire bead contains steel wires wrapped by steel cords that hold the tire onto the rim.

Bias Ply Tire: A pneumatic tire in which the plies are laid at alternate angles less than 90 degrees to the centerline of the tread.

Cold Tire Pressure: The amount of air pressure in a tire, measured in pounds per square inch (psi) or kilopascals (kPa) before a tire has built up heat from driving. See *Inflation - Tire Pressure on page 5-67*.

Curb Weight: The weight of a motor vehicle with standard and optional equipment including the maximum capacity of fuel, oil, and coolant, but without passengers and cargo.

DOT Markings: A code molded into the sidewall of a tire signifying that the tire is in compliance with the U.S. Department of Transportation (DOT) motor vehicle safety standards. The DOT code includes the Tire Identification Number (TIN), an alphanumeric designator which can also identify the tire manufacturer, production plant, brand, and date of production.

GVWR: Gross Vehicle Weight Rating. See *Loading Your Vehicle on page 4-22*.

GAWR FRT: Gross Axle Weight Rating for the front axle. See *Loading Your Vehicle on page 4-22*.

GAWR RR: Gross Axle Weight Rating for the rear axle. See *Loading Your Vehicle on page 4-22*.

Intended Outboard Sidewall: The side of an asymmetrical tire, that must always face outward when mounted on a vehicle.

Kilopascal (kPa): The metric unit for air pressure.

Light Truck (LT-Metric) Tire: A tire used on light duty trucks and some multipurpose passenger vehicles.

Load Index: An assigned number ranging from 1 to 279 that corresponds to the load carrying capacity of a tire.

Maximum Inflation Pressure: The maximum air pressure to which a cold tire can be inflated. The maximum air pressure is molded onto the sidewall.

Maximum Load Rating: The load rating for a tire at the maximum permissible inflation pressure for that tire.

Maximum Loaded Vehicle Weight: The sum of curb weight, accessory weight, vehicle capacity weight, and production options weight.

Normal Occupant Weight: The number of occupants a vehicle is designed to seat multiplied by 150 lbs (68 kg). See *Loading Your Vehicle on page 4-22*.

Occupant Distribution: Designated seating positions.

Outward Facing Sidewall: The side of an asymmetrical tire that has a particular side that faces outward when mounted on a vehicle. The side of the tire that contains a whitewall, bears white lettering, or bears manufacturer, brand, and/or model name molding that is higher or deeper than the same moldings on the other sidewall of the tire.

Passenger (P-Metric) Tire: A tire used on passenger cars and some light duty trucks and multipurpose vehicles.

Recommended Inflation Pressure: Vehicle manufacturer's recommended tire inflation pressure as shown on the tire placard. See *Inflation - Tire Pressure on page 5-67* and *Loading Your Vehicle on page 4-22*.

Radial Ply Tire: A pneumatic tire in which the ply cords that extend to the beads are laid at 90 degrees to the centerline of the tread.

Rim: A metal support for a tire and upon which the tire beads are seated.

Sidewall: The portion of a tire between the tread and the bead.

Speed Rating: An alphanumeric code assigned to a tire indicating the maximum speed at which a tire can operate.

Traction: The friction between the tire and the road surface. The amount of grip provided.

Tread: The portion of a tire that comes into contact with the road.

Treadwear Indicators: Narrow bands, sometimes called wear bars, that show across the tread of a tire when only 1/16 inch (1.6 mm) of tread remains. See *When It Is Time for New Tires on page 5-76*.

UTQGS (Uniform Tire Quality Grading Standards): A tire information system that provides consumers with ratings for a tire's traction, temperature, and treadwear. Ratings are determined by tire manufacturers using government testing procedures. The ratings are molded into the sidewall of the tire. See *Uniform Tire Quality Grading on page 5-80*.

Vehicle Capacity Weight: The number of designated seating positions multiplied by 150 lbs (68 kg) plus the rated cargo load. See *Loading Your Vehicle on page 4-22*.

Vehicle Maximum Load on the Tire: Load on an individual tire due to curb weight, accessory weight, occupant weight, and cargo weight.

Vehicle Placard: A label permanently attached to a vehicle showing the vehicle's capacity weight and the original equipment tire size and recommended inflation pressure. See "Tire and Loading Information Label" under *Loading Your Vehicle on page 4-22*.

Inflation - Tire Pressure

Tires need the correct amount of air pressure to operate effectively.

Notice: Do not let anyone tell you that under-inflation or over-inflation is all right. It is not. If your tires do not have enough air (under-inflation), you can get the following:

- Too much flexing
- Too much heat
- Tire overloading
- Premature or irregular wear
- Poor handling
- Reduced fuel economy

If your tires have too much air (over-inflation), you can get the following:

- Unusual wear
- Poor handling
- Rough ride
- Needless damage from road hazards

A vehicle specific Tire and Loading Information label is attached to your vehicle. This label lists your vehicle's original equipment tires and shows the correct inflation pressures for your tires when they are cold. The recommended cold tire inflation pressure, shown on the label, is the minimum amount of air pressure needed to support your vehicle's maximum load carrying capacity.

For additional information regarding how much weight your vehicle can carry, and an example of the tire and loading information label, see *Loading Your Vehicle on page 4-22*. How you load your vehicle affects vehicle handling and ride comfort. Never load your vehicle with more weight than it was designed to carry.

When to Check

Check your tires once a month or more. Do not forget to check the compact spare tire, if your vehicle has one. The compact spare should be at 60 psi (420 kPa). For additional information regarding the compact spare tire, see *Compact Spare Tire on page 5-111*.

How to Check

Use a good quality pocket-type gage to check tire pressure. You cannot tell if your tires are properly inflated simply by looking at them. Radial tires may look properly inflated even when they are underinflated. Check the tire's inflation pressure when the tires are cold. Cold means your vehicle has been sitting for at least three hours or driven no more than 1 mile (1.6 km).

Remove the valve cap from the tire valve stem. Press the tire gage firmly onto the valve to get a pressure measurement. If the cold tire inflation pressure matches the recommended pressure on the Tire and Loading Information label, no further adjustment is necessary. If the inflation pressure is low, add air until you reach the recommended amount.

If you overfill the tire, release air by pushing on the metal stem in the center of the tire valve. Re-check the tire pressure with the tire gage.

Be sure to put the valve caps back on the valve stems. They help prevent leaks by keeping out dirt and moisture.

High-Speed Operation

CAUTION:

Driving at high speeds, 100 mph (160 km/h) or higher, puts an additional strain on tires. Sustained high-speed driving causes excessive heat build up and can cause sudden tire failure. You could have a crash and you or others could be killed. Some high-speed rated tires require inflation pressure adjustment for high speed operation. When speed limits and road conditions are such that a vehicle can be driven at high speeds, make sure the tires are rated for high speed operation, in excellent condition, and set to the correct cold tire inflation pressure for the vehicle load.

If your vehicle has 235/50ZR18 size tires, they will require inflation pressure adjustment when driving your vehicle at speeds of 100 mph (160 km/h) or higher. Set the cold inflation pressure to the maximum inflation pressure shown on the tire sidewall, or 44 psi (300 kPa), whichever is lower. See the example following. When you end this high-speed driving, return the tires to the cold tire inflation pressure shown on the Tire and Loading Information label. See *Loading Your Vehicle on page 4-22 and Inflation - Tire Pressure on page 5-67*.

Example:

You will find the maximum load and inflation pressure molded on the tire's sidewall, in small letters, near the rim flange. It will read something like this: Maximum load 690 kg (1521 lbs) 300 kPa (44 psi) Max. Press.

For this example, you would set the inflation pressure for high-speed driving at 44 psi (300 kPa).

Tire Pressure Monitor System

The Tire Pressure Monitor System (TPMS) uses radio and sensor technology to check tire pressure levels. The TPMS sensors monitor the air pressure in your vehicle's tires and transmit tire pressure readings to a receiver located in the vehicle.

Each tire, including the spare (if provided), should be checked monthly when cold and inflated to the inflation pressure recommended by the vehicle manufacturer on the vehicle placard or tire inflation pressure label. (If your vehicle has tires of a different size than the size indicated on the vehicle placard or tire inflation pressure label, you should determine the proper tire inflation pressure for those tires.)

As an added safety feature, your vehicle has been equipped with a tire pressure monitoring system (TPMS) that illuminates a low tire pressure telltale when one or more of your tires is significantly under-inflated.

Accordingly, when the low tire pressure telltale illuminates, you should stop and check your tires as soon as possible, and inflate them to the proper pressure. Driving on a significantly under-inflated tire causes the tire to overheat and can lead to tire failure. Under-inflation also reduces fuel efficiency and tire tread life, and may affect the vehicle's handling and stopping ability.

Please note that the TPMS is not a substitute for proper tire maintenance, and it is the driver's responsibility to maintain correct tire pressure, even if under-inflation has not reached the level to trigger illumination of the TPMS low tire pressure telltale.

Your vehicle has also been equipped with a TPMS malfunction indicator to indicate when the system is not operating properly. The TPMS malfunction indicator is combined with the low tire pressure telltale. When the system detects a malfunction, the telltale will flash for approximately one minute and then remain continuously illuminated. This sequence will continue upon subsequent vehicle start-ups as long as the malfunction exists.

When the malfunction indicator is illuminated, the system may not be able to detect or signal low tire pressure as intended. TPMS malfunctions may occur for a variety of reasons, including the installation of replacement or alternate tires or wheels on the vehicle that prevent the TPMS from functioning properly. Always check the TPMS malfunction telltale after replacing one or more tires or wheels on your vehicle to ensure that the replacement or alternate tires and wheels allow the TPMS to continue to function properly.

See *Tire Pressure Monitor Operation* on page 5-71 for additional information.

Federal Communications Commission (FCC) and Industry and Science Canada

The Tire Pressure Monitor System (TPMS) operates on a radio frequency and complies with Part 15 of the FCC Rules. Operation is subject to the following two conditions:

1. This device may not cause harmful interference.
2. This device must accept any interference received, including interference that may cause undesired operation.

The Tire Pressure Monitor System (TPMS) operates on a radio frequency and complies with RSS-210 of Industry and Science Canada. Operation is subject to the following two conditions:

1. This device may not cause interference.
2. This device must accept any interference received, including interference that may cause undesired operation of the device.

Changes or modifications to this system by other than an authorized service facility could void authorization to use this equipment.

Tire Pressure Monitor Operation

The Tire Pressure Monitor System (TPMS) is designed to warn the driver when a low tire pressure condition exists. TPMS sensors are mounted onto each tire and wheel assembly, excluding the spare tire and wheel assembly. The TPMS sensors monitor the air pressure in the vehicle's tires and transmits the tire pressure readings to a receiver located in the vehicle.

Using the Driver Information Center (DIC), the driver can also check tire pressure levels using the DIC. For additional information and details about the DIC operation and displays see *DIC Operation and Displays on page 3-48* and *DIC Warnings and Messages on page 3-54*.

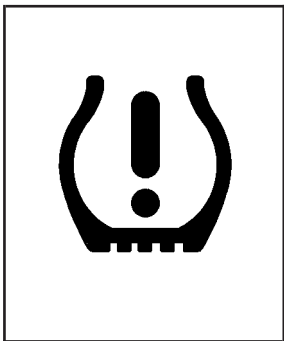

When a low tire pressure condition is detected, the TPMS illuminates the low tire pressure warning light located on the instrument panel cluster.

A DIC warning message to check the pressure in a specific tire is also shown on the DIC display screen. The low tire pressure warning light and the DIC warning message come at each ignition cycle until the tires are inflated to the correct inflation pressure.

The low tire pressure warning light may come on in cool weather when the vehicle is first started, and then turn off as you start to drive. This could be an early indicator that the air pressure in the tire(s) are getting low and need to be inflated to the proper pressure.

The Tire and Loading Information label, attached to your vehicle, shows the size of your vehicle's original equipment tires and the correct inflation pressure for the tires when they are cold. See *Loading Your Vehicle on page 4-22*, for an example of the Tire and Loading Information label and its location on your vehicle. Also see *Inflation - Tire Pressure on page 5-67*.

Your vehicle's TPMS can warn you about a low tire pressure condition but it does not replace normal tire maintenance. See *Tire Inspection and Rotation on page 5-75* and *Tires on page 5-59*.

Notice: Using non-approved tire sealants could damage the Tire Pressure Monitor System (TPMS) sensors. TPMS sensor damage caused by using an incorrect tire sealant is not covered by the vehicle warranty. Always use the GM approved tire sealant available through your dealer/retailer.

Your vehicle, when new, may have included a factory-installed Tire Sealant and Compressor Kit. This kit uses a GM approved liquid tire sealant. See *Tire Sealant and Compressor Kit (With Sealant Selector Switch) on page 5-85* or *Tire Sealant and Compressor Kit (Without Sealant Selector Switch) on page 5-93*.

TPMS Malfunction Light and Message

The TPMS will not function properly if one or more of the TPMS sensors are missing or inoperable. When the system detects a malfunction, the low tire warning light flashes for about one minute and then stays on for the remainder of the ignition cycle. A DIC warning message is also displayed. The low tire warning light and DIC warning message come on at each ignition cycle until the problem is corrected. Some of the conditions that can cause the malfunction light and DIC message to come on are:

- One of the road tires has been replaced with the spare tire. The spare tire does not have a TPMS sensor. The DIC message should go off once you re-install the road tire containing the TPMS sensor.
- The TPMS sensor matching process was not done or not completed successfully after rotating the vehicle's tires. The DIC message should go off after successfully completing the sensor matching process. See "TPMS Sensor Matching Process" later in this section.
- One or more TPMS sensors are missing or damaged. The DIC message and the TPMS malfunction light should go off when the TPMS sensors are installed and the sensor matching process is performed successfully. See your dealer/retailer for service.

- Replacement tires or wheels do not match your vehicle's original equipment tires or wheels. Tires and wheels other than those recommended for your vehicle could prevent the TPMS from functioning properly. See *Buying New Tires* on page 5-77.
- Operating electronic devices or being near facilities using radio wave frequencies similar to the TPMS could cause the TPMS sensors to malfunction.

If the TPMS is not functioning it cannot detect or signal a low tire condition. See your dealer/retailer for service if the TPMS malfunction light and DIC message comes on and stays on.

TPMS Sensor Matching Process

Each TPMS sensor has a unique identification code. Any time you replace one or more of the TPMS sensors or rotate your vehicle's tires, the identification codes need to be matched to the new tire/wheel position. The sensors are matched to the tire/wheel positions in the following order: driver side front tire, passenger side front tire, passenger side rear tire, and driver side rear tire using a TPMS diagnostic tool. See your dealer/retailer for service.

The TPMS sensors can also be matched to each tire/wheel position by increasing or decreasing the tire's air pressure. If increasing the tire's air pressure, do not exceed the maximum inflation pressure indicated on the tire's sidewall. To decrease the tire's air-pressure use the pointed end of the valve cap, a pencil-style air pressure gage, or a key.

You have two minutes to match the first tire/wheel position, and five minutes overall, to match all four tire/wheel positions. If it takes longer than two minutes, to match the first tire and wheel, or more than five minutes to match all four tire and wheel positions, the matching process stops and you need to start over.

The TPMS matching process is outlined below:

1. Set the parking brake.
2. Turn the ignition switch to ON/RUN with the engine off.
3. Press the Remote Keyless Entry (RKE) transmitter's lock and unlock buttons at the same time for approximately five seconds. The horn sounds twice to signal the receiver is in relearn mode and Tire Learning Active message displays on the DIC screen.

4. Start with the driver side front tire.
5. Remove the valve cap from the valve stem. Activate the TPMS sensor by increasing or decreasing the tire's air pressure for 10 seconds, or until a horn chirp sounds. The horn chirp, which can take up to 30 seconds to sound, confirms that the TPMS sensor identification code has been matched to this tire position.
6. Proceed to the passenger side front tire, and repeat the procedure in Step 5.
7. Proceed to the passenger side rear tire, and repeat the procedure in Step 5.
8. Proceed to the driver side rear tire, and repeat the procedure in Step 5.
9. After hearing the confirming horn chirp, for the driver side rear tire, the horn sounds two more times to signal the tire learning mode is no longer active. Turn the ignition switch to LOCK/OFF.
10. Set all four tires to the recommended air pressure level as indicated on the tire and loading information label.
11. Put the valve caps back on the valve stems.

Tire Inspection and Rotation

We recommend that you regularly inspect your vehicle's tires, including the spare tire, for signs of wear or damage. See *When It Is Time for New Tires* on page 5-76 for more information.

Tires should be rotated every 5,000 to 8,000 miles (8 000 to 13 000 km). See *Scheduled Maintenance* on page 6-4.

The purpose of a regular tire rotation is to achieve a uniform wear for all tires on the vehicle. This will ensure that your vehicle continues to perform most like it did when the tires were new.

If your vehicle has 235/50ZR18 size tires, GM recommends rotating these tires at 3,000 mile (4 800 km) intervals. These tires are optimized for dry traction and handling performance. Tread life may be 15,000 miles (24 140 km) or less for these tires, depending on how and where you drive.

Any time you notice unusual wear, rotate your vehicle's tires as soon as possible and check wheel alignment. Also check for damaged tires or wheels. See *When It Is Time for New Tires* on page 5-76 and *Wheel Replacement* on page 5-81 for more information.

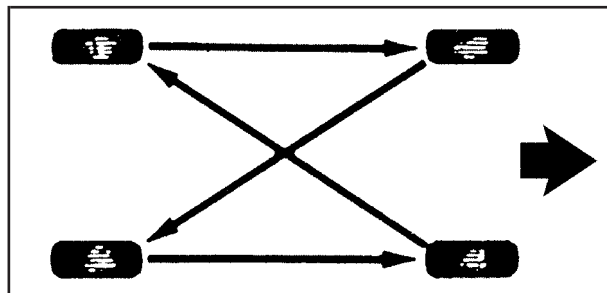

When rotating your vehicle's tires, always use the correct rotation pattern shown here.

If your vehicle has a compact spare tire, do not include it in the tire rotation.

After the tires have been rotated, adjust the front and rear inflation pressures as shown on the Tire and Loading Information label. See *Inflation - Tire Pressure* on page 5-67 and *Loading Your Vehicle* on page 4-22.

Reset the Tire Pressure Monitor System. See *Tire Pressure Monitor Operation* on page 5-71.

Make certain that all wheel nuts are properly tightened. See “Wheel Nut Torque” under *Capacities and Specifications* on page 5-128.

⚠ CAUTION:

Rust or dirt on a wheel, or on the parts to which it is fastened, can make wheel nuts become loose after time. The wheel could come off and cause an accident. When you change a wheel, remove any rust or dirt from places where the wheel attaches to the vehicle. In an emergency, you can use a cloth or a paper towel to do this; but be sure to use a scraper or wire brush later, if needed, to get all the rust or dirt off. See *Changing a Flat Tire* on page 5-102.

When It Is Time for New Tires

Various factors, such as maintenance, temperatures, driving speeds, vehicle loading, and road conditions influence when you need new tires.

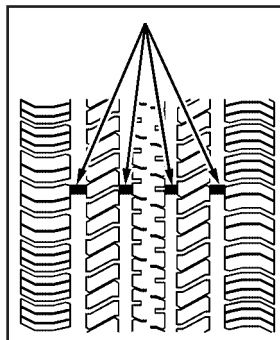

One way to tell when it is time for new tires is to check the treadwear indicators, which will appear when your tires have only 1/16 inch (1.6 mm) or less of tread remaining.

You need new tires if any of the following statements are true:

- You can see the indicators at three or more places around the tire.
- You can see cord or fabric showing through the tire's rubber.
- The tread or sidewall is cracked, cut, or snagged deep enough to show cord or fabric.
- The tire has a bump, bulge, or split.
- The tire has a puncture, cut, or other damage that cannot be repaired well because of the size or location of the damage.

The rubber in tires degrades over time, even if they are not being used. This is also true for the spare tire, if your vehicle has one. Multiple conditions affect how fast this aging takes place, including temperatures, loading conditions, and inflation pressure maintenance. With proper care and maintenance tires will typically wear out before they degrade due to age. If you are unsure about the need to replace your tires as they get older, consult the tire manufacturer for more information.

Buying New Tires

GM has developed and matched specific tires for your vehicle. The original equipment tires installed on your vehicle, when it was new, were designed to meet General Motors Tire Performance Criteria Specification (TPC Spec) system rating. If you need replacement tires, GM strongly recommends that you get tires with the same TPC Spec rating. This way, your vehicle will continue to have tires that are designed to give the same performance and vehicle safety, during normal use, as the original tires.

GM's exclusive TPC Spec system considers over a dozen critical specifications that impact the overall performance of your vehicle, including brake system performance, ride and handling, traction control, and tire pressure monitoring performance. GM's TPC Spec number is molded onto the tire's sidewall near the tire size. If the tires have an all-season tread design, the TPC Spec number will be followed by an MS for mud and snow. See *Tire Sidewall Labeling on page 5-61* for additional information.

GM recommends replacing tires in sets of four. This is because uniform tread depth on all tires will help keep your vehicle performing most like it did when the tires were new. Replacing less than a full set of tires can affect the braking and handling performance of your vehicle. See *Tire Inspection and Rotation on page 5-75* for information on proper tire rotation.

Winter tires with the same speed rating as your vehicle's original equipment tires may not be available for H, V, W, Y, and ZR speed rated tires. If you choose snow tires with a lower speed rating, never exceed the tire's maximum speed capability.

 **CAUTION:**

Mixing tires could cause you to lose control while driving. If you mix tires of different sizes, brands, or types (radial and bias-belted tires), the vehicle may not handle properly, and you could have a crash. Using tires of different sizes, brands, or types may also cause damage to your vehicle. Be sure to use the correct size, brand, and type of tires on all wheels. It is all right to drive with your compact spare temporarily, as it was developed for use on your vehicle. See *Compact Spare Tire on page 5-111*.

 **CAUTION:**

If you use bias-ply tires on your vehicle, the wheel rim flanges could develop cracks after many miles of driving. A tire and/or wheel could fail suddenly, causing a crash. Use only radial-ply tires with the wheels on your vehicle.

If you must replace your vehicle's tires with those that do not have a TPC Spec number, make sure they are the same size, load range, speed rating, and construction type (radial and bias-belted tires) as your vehicle's original tires.

Vehicles that have a tire pressure monitoring system could give an inaccurate low-pressure warning if non-TPC Spec rated tires are installed on your vehicle. Non-TPC Spec rated tires may give a low-pressure warning that is higher or lower than the proper warning level you would get with TPC Spec rated tires. See *Tire Pressure Monitor System on page 5-70*.

Your vehicle's original equipment tires are listed on the Tire and Loading Information Label. See *Loading Your Vehicle on page 4-22*, for more information about the Tire and Loading Information Label and its location on your vehicle.

Different Size Tires and Wheels

If you add wheels or tires that are a different size than your original equipment wheels and tires, this may affect the way your vehicle performs, including its braking, ride and handling characteristics, stability, and resistance to rollover. Additionally, if your vehicle has electronic systems such as, anti-lock brakes, traction control, and electronic stability control, the performance of these systems can be affected.

 **CAUTION:**

If you add different sized wheels, your vehicle may not provide an acceptable level of performance and safety if tires not recommended for those wheels are selected. You may increase the chance that you will crash and suffer serious injury. Only use GM specific wheel and tire systems developed for your vehicle, and have them properly installed by a GM certified technician.

See *Buying New Tires on page 5-77* and *Accessories and Modifications on page 5-3* for additional information.

Uniform Tire Quality Grading

Quality grades can be found where applicable on the tire sidewall between tread shoulder and maximum section width. For example:

Treadwear 200 Traction AA Temperature A

The following information relates to the system developed by the United States National Highway Traffic Safety Administration (NHTSA), which grades tires by treadwear, traction, and temperature performance. This applies only to vehicles sold in the United States. The grades are molded on the sidewalls of most passenger car tires. The Uniform Tire Quality Grading (UTQG) system does not apply to deep tread, winter-type snow tires, space-saver, or temporary use spare tires, tires with nominal rim diameters of 10 to 12 inches (25 to 30 cm), or to some limited-production tires.

While the tires available on General Motors passenger cars and light trucks may vary with respect to these grades, they must also conform to federal safety requirements and additional General Motors Tire Performance Criteria (TPC) standards.

Treadwear

The treadwear grade is a comparative rating based on the wear rate of the tire when tested under controlled conditions on a specified government test course. For example, a tire graded 150 would wear one and a half (1.5) times as well on the government course as a tire graded 100. The relative performance of tires depends upon the actual conditions of their use, however, and may depart significantly from the norm due to variations in driving habits, service practices, and differences in road characteristics and climate.

Traction – AA, A, B, C

The traction grades, from highest to lowest, are AA, A, B, and C. Those grades represent the tire's ability to stop on wet pavement as measured under controlled conditions on specified government test surfaces of asphalt and concrete. A tire marked C may have poor traction performance.

Warning: The traction grade assigned to this tire is based on straight-ahead braking traction tests, and does not include acceleration, cornering, hydroplaning, or peak traction characteristics.

Temperature – A, B, C

The temperature grades are A (the highest), B, and C, representing the tire's resistance to the generation of heat and its ability to dissipate heat when tested under controlled conditions on a specified indoor laboratory test wheel. Sustained high temperature can cause the material of the tire to degenerate and reduce tire life, and excessive temperature can lead to sudden tire failure. The grade C corresponds to a level of performance which all passenger car tires must meet under the Federal Motor Vehicle Safety Standard No. 109. Grades B and A represent higher levels of performance on the laboratory test wheel than the minimum required by law.

Warning: The temperature grade for this tire is established for a tire that is properly inflated and not overloaded. Excessive speed, underinflation, or excessive loading, either separately or in combination, can cause heat buildup and possible tire failure.

Wheel Alignment and Tire Balance

The tires and wheels on your vehicle were aligned and balanced carefully at the factory to give you the longest tire life and best overall performance. Adjustments to wheel alignment and tire balancing will not be necessary on a regular basis. However, if you notice unusual tire wear or your vehicle pulling to one side or the other, the alignment might need to be checked. If you notice your vehicle vibrating when driving on a smooth road, the tires and wheels might need to be rebalanced. See your dealer/retailer for proper diagnosis.

Wheel Replacement

Replace any wheel that is bent, cracked, or badly rusted or corroded. If wheel nuts keep coming loose, the wheel, wheel bolts, and wheel nuts should be replaced. If the wheel leaks air, replace it (except some aluminum wheels, which can sometimes be repaired). See your dealer/retailer if any of these conditions exist. Your dealer/retailer will know the kind of wheel you need.

Each new wheel should have the same load-carrying capacity, diameter, width, offset, and be mounted the same way as the one it replaces.

If you need to replace any of your wheels, wheel bolts, wheel nuts, or Tire Pressure Monitor System (TPMS) sensors, replace them only with new GM original equipment parts. This way, you will be sure to have the right wheel, wheel bolts, wheel nuts, and TPMS sensors for your vehicle.

 **CAUTION:**

Using the wrong replacement wheels, wheel bolts, or wheel nuts on your vehicle can be dangerous. It could affect the braking and handling of your vehicle, make your tires lose air and make you lose control. You could have a collision in which you or others could be injured. Always use the correct wheel, wheel bolts, and wheel nuts for replacement.

Notice: The wrong wheel can also cause problems with bearing life, brake cooling, speedometer or odometer calibration, headlamp aim, bumper height, vehicle ground clearance, and tire or tire chain clearance to the body and chassis.

See *Changing a Flat Tire* on page 5-102 for more information.

Used Replacement Wheels

 **CAUTION:**

Putting a used wheel on your vehicle is dangerous. You cannot know how it has been used or how far it has been driven. It could fail suddenly and cause a crash. If you have to replace a wheel, use a new GM original equipment wheel.

Tire Chains

CAUTION:

Do not use tire chains. There is not enough clearance. Tire chains used on a vehicle without the proper amount of clearance can cause damage to the brakes, suspension, or other vehicle parts. The area damaged by the tire chains could cause you to lose control of your vehicle and you or others may be injured in a crash. Use another type of traction device only if its manufacturer recommends it for use on your vehicle and tire size combination and road conditions. Follow that manufacturer's instructions. To help avoid damage to your vehicle, drive slowly, re-adjust or remove the device if it is contacting your vehicle, and do not spin your wheels. If you do find traction devices that will fit, install them on the rear tires.

If a Tire Goes Flat

It is unusual for a tire to blowout while you are driving, especially if you maintain your tires properly. See *Tires on page 5-59*. If air goes out of a tire, it is much more likely to leak out slowly. But if you should ever have a blowout, here are a few tips about what to expect and what to do:

If a front tire fails, the flat tire will create a drag that pulls the vehicle toward that side. Take your foot off the accelerator pedal and grip the steering wheel firmly. Steer to maintain lane position, and then gently brake to a stop well out of the traffic lane.

A rear blowout, particularly on a curve, acts much like a skid and may require the same correction you would use in a skid. In any rear blowout, remove your foot from the accelerator pedal. Get the vehicle under control by steering the way you want the vehicle to go. It may be very bumpy and noisy, but you can still steer. Gently brake to a stop, well off the road if possible.

If a tire goes flat, and your vehicle has a compact spare tire, see *Changing a Flat Tire on page 5-102*. This information shows you how to use your vehicle's tire changing equipment and how to change a flat tire safely.

CAUTION:

Lifting a vehicle and getting under it to do maintenance or repairs is dangerous without the appropriate safety equipment and training. The jack provided with your vehicle is designed only for changing a flat tire. If it is used for anything else, you or others could be badly injured or killed if the vehicle slips off the jack. Use the jack provided with your vehicle only for changing a flat tire.

Tire Sealant and Compressor Kit

If your vehicle has a factory installed tire sealant and compressor kit, there is no spare tire, no tire changing equipment and no place to store a tire.

If a tire goes flat, avoid further tire and wheel damage by driving slowly to a level place and stopping.

1. Turn on the hazard warning flashers. See *Hazard Warning Flashers on page 3-6*.
2. Park your vehicle. If your vehicle has an automatic transmission, set the parking brake firmly and put the shift lever in PARK (P). See *Shifting Into PARK (P) (Automatic Transmission) on page 2-44*. If your vehicle has a manual transmission, move the shift lever to REVERSE (R) and set the parking brake firmly. See *Parking Your Vehicle (Manual Transmission) on page 2-46* for additional information.
3. Turn off the engine.
4. Inspect the flat tire.

If the tire has been separated from the wheel, has damaged sidewalls, or has a puncture larger than a 1/4 inch (6 mm), the tire is too severely damaged for the tire sealant and compressor kit to be effective. See *Roadside Service on page 7-6*.

If the tire has a puncture less than a 1/4 inch (6 mm) in the tread area of the tire, see *Tire Sealant and Compressor Kit (With Sealant Selector Switch) on page 5-85* or *Tire Sealant and Compressor Kit (Without Sealant Selector Switch) on page 5-93*.

Tire Sealant and Compressor Kit (With Sealant Selector Switch)

Your vehicle has a tire sealant and compressor kit that is capable of temporarily sealing a puncture up to ¼ inch (6mm) in the tread area of the tire. There is no jack or spare tire. The kit inflates the tire with liquid sealant and air. The tire sealant and compressor kit can also be used to inflate an underinflated tire. After the tire is inflated to the recommended inflation pressure, see *Inflation - Tire Pressure on page 5-67* for more information, the vehicle must be driven for five miles to distribute the sealant in the tire and seal the puncture. After driving five miles the tire pressure must be rechecked and adjusted as needed. See "Using the Tire Sealant and Compressor Kit to Temporarily Seal a Punctured Tire" later in this section. Be sure to read and follow all of the tire sealant and compressor kit instructions. The kit includes:

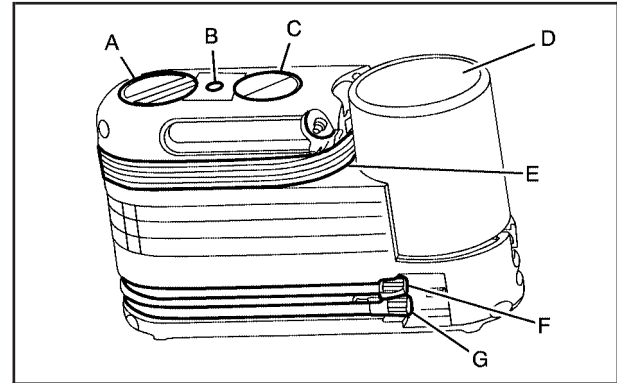

- | | |
|----------------------|---------------------|
| A. Selector Switch | E. Air Compressor |
| B. On/Off Button | Accessory Plug |
| C. Air Pressure Gage | F. Sealant/Air Hose |
| D. Tire Sealant | (Clear) |
| Canister | G. Air Only Hose |

After temporarily sealing the tire sealant and compressor kit, it is recommended to take your vehicle to an authorized dealer/retailer as soon as possible. If the sealant is removed within 100 miles (161 kilometers) of driving, then it is easier to clean from the tire and you are less likely to require a replacement tire.

Accessing the Tire Sealant and Compressor Kit

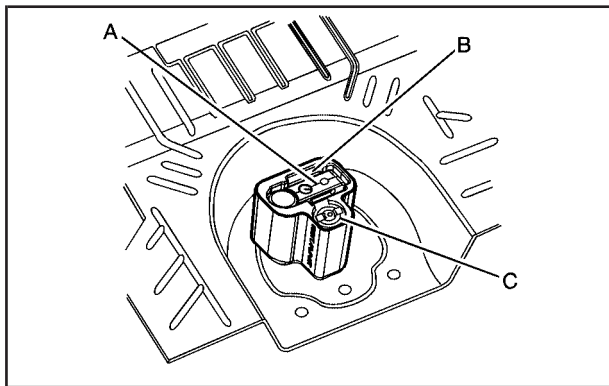

- A. Tire Sealant and Compressor Kit
- B. Foam Container
- C. Wing Nut

To access the tire sealant and compressor kit:

1. Open the trunk. See *Trunk* on page 2-20 for more information.
2. Locate the tire sealant and compressor kit (A) in the center of the cargo area.

3. Remove the tire sealant and compressor kit by turning the wing nut (C counterclockwise).
4. Remove the sealant and compressor kit from its foam container (B).

Tire Sealant

Read and follow the safe handling instructions on the sealant canister.

The sealant can temporarily seal small punctures in the tread area of the tire. The sealant cannot seal sidewall damage, large punctures, or a tire that has unseated from the wheel. See *Roadside Service* on page 7-6 if you need assistance.

The sealant can only be used to seal one tire. After usage, the sealant canister and sealant filling hose assembly must be replaced at a dealer/retailer. See “Removal and Installation of Sealant Canister” later in this section.

Check the tire sealant expiration date on the sealant canister. The sealant might not be effective beyond the expiration date. If needed, see your dealer/retailer for a replacement canister.

Using the Tire Sealant and Compressor Kit to Temporarily Seal a Punctured Tire

Follow these directions closely for correct sealant usage.

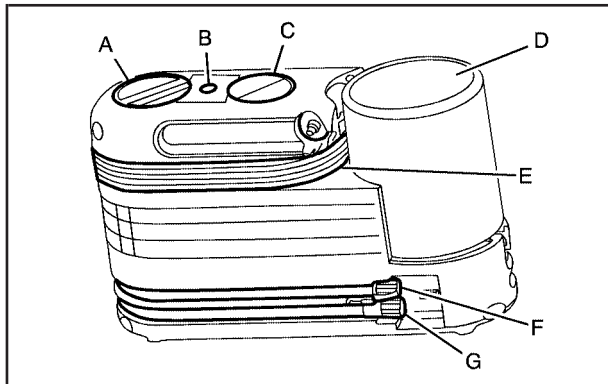

1. Do a safety check before proceeding. See *If a Tire Goes Flat* on page 5-83.
2. Inspect the damaged tire.
The sealant cannot seal sidewall damage, large punctures, or a tire that has unseated from the wheel. See *Roadside Service* on page 7-6.
Do not remove any objects that have penetrated the tire.

3. Place the sealant and compressor kit on the ground and unwrap the sealant/air hose (F) hose from the compressor.

The sealant/air hose (F) is the top, clear hose.

4. Remove the valve stem cap from the flat tire by turning it counterclockwise.
5. Attach the sealant filling hose (F) onto the tire valve stem. Turn it clockwise until it is tight.
6. Unwrap and plug the air compressor accessory plug (E) into an accessory power outlet in the vehicle. See *Accessory Power Outlet(s)* on page 3-21 for more information.

Do not slam the door or close the window on the compressor accessory plug cord.

CAUTION:

Idling the engine in a closed-in place or with the climate control system off can cause deadly carbon monoxide (CO). See *Engine Exhaust* on page 2-47.

7. Start the vehicle. See *Starting the Engine* on page 2-34 for more information. The vehicle must be running while using the air compressor.

 **CAUTION:**

Inflating something too much can make it explode, and you or others could be injured. Be sure to read the inflator instructions, and inflate the tire to its recommended pressure. Do not exceed 36 psi (248 kPa).

8. Turn the selector switch (A) counterclockwise to the sealant and air position.
9. Push the On/Off button (B).

The sealant and compressor kit will inject sealant and air into the tire. Sealant may leak from the puncture until the vehicle is driven and the hole has sealed.

The pressure gage (C) will initially show a high pressure while the compressor pushes the sealant into the tire. Once the sealant is completely dispersed into the tire, the pressure will quickly drop and start to rise again as the tire inflates with air.

10. Inflate the tire to the recommended inflation pressure, found on the Tire and Loading Information label. See *Inflation - Tire Pressure on page 5-67*.

The pressure gage reads high while the compressor is running. Turn the compressor off to get an accurate pressure reading.

Notice: If the recommended pressure cannot be reached after 15 minutes, the vehicle should not be driven farther. Damage to the tire is severe and the sealant will not be effective. Remove the air compressor plug from the accessory power outlet and unscrew the inflating hose from the tire valve. See *Roadside Service on page 7-6*.

11. Turn the compressor off by pushing the On/Off button (B).
12. The tire is not sealed and will continue to leak air until the vehicle is driven and the sealant is distributed in the tire.

Steps 11 through 18 must be done right after Step 10.

13. Unplug the air compressor accessory plug (F) from the accessory power outlet in the vehicle.
14. Disconnect the sealant/air hose from the tire valve stem or tire pressure monitoring sensor cap, by turning it counterclockwise, and replace the tire valve stem cap.

Be careful when handling the tire inflator components as they may be hot after usage.

15. Wrap the sealant/air hose around the air compressor channel to stow it in its original location.
16. Wrap the air compressor accessory plug (E) back into place.

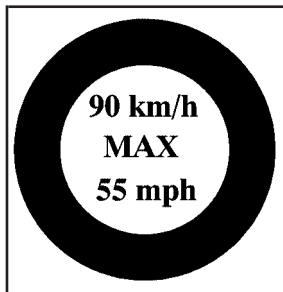

17. If the flat tire was able to inflate to the recommended inflation pressure, remove the maximum speed label from the sealant canister.

Place it in a highly visible location such as the inside of the upper left corner of the windshield or to the face of the radio/clock.

The maximum speed label reminds you to drive cautiously and not to exceed 55 mph (90 km/h) until you have the damaged tire inspected and repaired.

CAUTION:

Storing the tire sealant and compressor kit or other equipment in the passenger compartment of the vehicle could cause injury. In a sudden stop or collision, loose equipment could strike someone. Store the tire sealant and compressor kit in the proper place.

18. Return the equipment to the proper storage location in the trunk of your vehicle.

19. Immediately drive the vehicle 5 miles (8 km) to distribute the sealant evenly in the tire. Stop at a safe location and check the tire pressure, refer to Steps 1 through 8 under “Using the Air Compressor without Sealant” next in this section.
20. If the tire pressure has fallen more than 10 psi (68 kPa), below the recommended inflation pressure, stop driving the vehicle. The tire is too severely damaged and the tire sealant and compressor kit cannot seal the tire. See *Roadside Service on page 7-6* for more information.

If the tire pressure has not dropped more than 10 psi (68 kPa) from the recommended inflation pressure, you can inflate the tire back up to the recommended inflation pressure.

21. Wipe off any sealant from the wheel, tire, and vehicle with a rag.
22. Dispose of the sealant canister at a local dealer/retailer or in accordance with your local state codes and practices.

After using the sealant canister, replace it with a new canister from your dealer/retailer.

23. After temporarily sealing a tire with the tire sealant and compressor kit, take your vehicle to your dealer/retailer to have the tire inspected and repaired.

Using the Air Compressor without Sealant to Inflate an Underinflated Tire (Not Punctured)

To use the air compressor to inflate a tire with air only and not sealant:

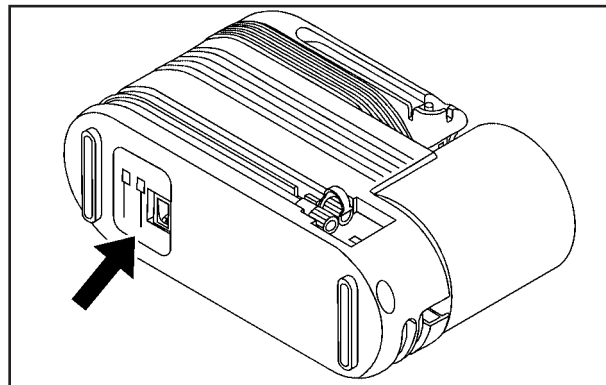

Your tire sealant and compressor kit has an accessory adapter located in a compartment on the bottom of its housing that may be used to inflate air mattresses, balls, etc.

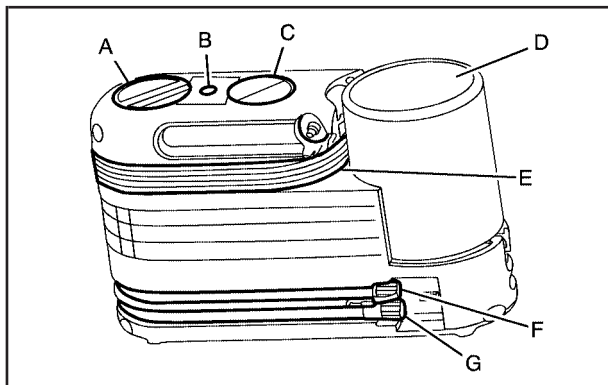

1. Do a safety check before proceeding. See *If a Tire Goes Flat* on page 5-83.
2. Unwrap the air only hose (G) from the bottom of the air compressor.
3. Attach the air only hose (G) onto the valve stem to secure into place.
4. Plug the air compressor accessory plug (E) into an accessory power outlet in the vehicle. See *Accessory Power Outlet(s)* on page 3-21 for more information.

⚠ CAUTION:

Idling the engine in a closed-in place or with the climate control system off can cause deadly carbon monoxide (CO). See *Engine Exhaust* on page 2-47.

5. Start the vehicle. See *Starting the Engine* on page 2-34 for more information. The vehicle must be running while using the air compressor.

⚠ CAUTION:

Inflating something too much can make it explode, and you or others could be injured. Be sure to read the inflator instructions, and inflate the tire to its recommended pressure. Do not exceed 36 psi (248 kPa).

6. Turn the selector switch (A) clockwise to the air only position.
7. Push the On/Off button (B).

- Inflate the tire up to the recommended inflation pressure using the air pressure gage (C) on the top of the unit.
The pressure gage read high while the compressor is running. Turn the compressor off to get an accurate reading.
- Turn off the air compressor by pushing the On/Off button (B).
- Unplug the air compressor accessory plug (E) and wrap it back into place.

 **CAUTION:**

Storing the tire sealant and compressor kit or other equipment in the passenger compartment of the vehicle could cause injury. In a sudden stop or collision, loose equipment could strike someone. Store the tire sealant and compressor kit in the proper place.

- Disconnect the air only hose (G) and wrap the hose in the bottom of the sealant and compressor kit.
- Place the equipment in the original location in the trunk of your vehicle.

Removal and Installation of the Sealant Canister

To remove the sealant canister:

- Unwrap the sealant and air hose.
- Push the canister release button.
- Pull up and remove the canister.
- Replace with a new canister. See your dealer/retailer for the new canister.
- Push the new canister into place.

Tire Sealant and Compressor Kit (Without Sealant Selector Switch)

Your vehicle has a tire sealant and compressor kit that is capable of temporarily sealing a small puncture up to ¼ inch (6 mm) in the tread. There is no jack or spare tire. The kit inflates the tire with liquid sealant and air. The tire sealant and compressor kit can also be used to inflate an underinflated tire. After the tire is inflated to the recommended inflation pressure, see *Inflation - Tire Pressure on page 5-67* for more information, the vehicle must be driven for five miles to distribute the sealant in the tire and seal the puncture. After driving five miles the tire pressure must be rechecked and adjusted as needed. See "Using the Tire Sealant and Compressor Kit" later in this section. Be sure to read and follow all of the tire sealant and compressor kit instructions. The kit includes:

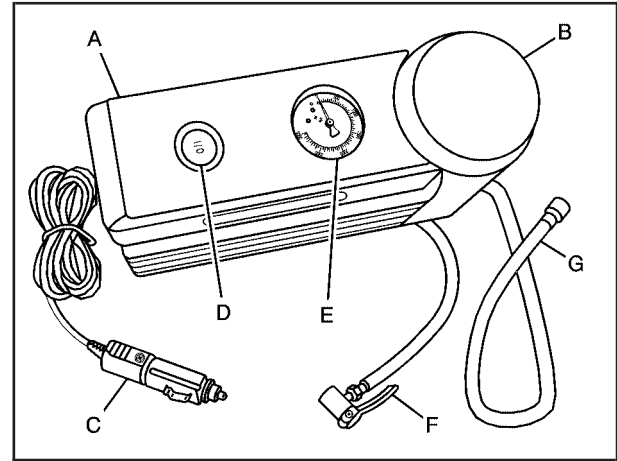

- | | |
|-------------------------------------|----------------------|
| A. Air Compressor | D. On/Off Switch |
| B. Tire Sealant Canister | E. Air Pressure Gage |
| C. Air Compressor
Accessory Plug | F. Air Only Hose |
| | G. Sealant/Air Hose |

After temporarily sealing and inflating the with the tire sealant and compressor kit, it is recommended to take your vehicle to an authorized dealer/retailer as soon as possible for tire repair or replacement. If the sealant is removed within 100 miles (161 kilometers) of driving, then it is easier to clean from the tire and you are less likely to require a replacement tire.

Accessing the Tire Sealant and Compressor Kit

To access the tire sealant and compressor kit:

1. Open the trunk. See *Trunk* on page 2-20 for more information.

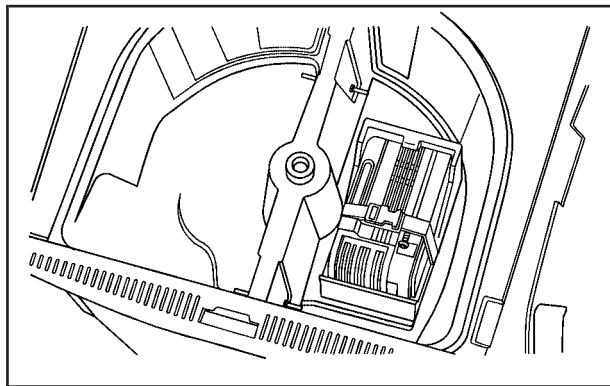

2. Locate the tire sealant and compressor kit on the driver side of the vehicle, near the back corner of the trunk.

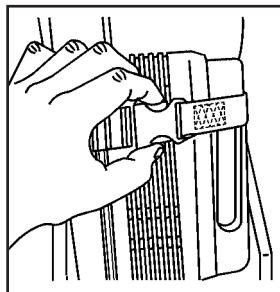

3. Remove the tire sealant and compressor kit strap by squeezing the two tabs of the quick release buckle.
4. Remove the sealant and compressor kit from its foam container.

Tire Sealant

Read and follow the safe handling instructions on the sealant canister.

The sealant can temporarily seal a puncture up to ¼ inch (6 mm) in the tread area of the tire. The sealant cannot seal sidewall damage, large punctures, or a tire that has unseated from the wheel. See *Roadside Service* on page 7-6 if you need assistance.

The sealant can only be used to seal one tire. After usage, the sealant canister and sealant/air hose assembly must be replaced at a dealer/retailer. See "Removal and Installation of Sealant Canister" later in this section.

Check the tire sealant expiration date on the sealant canister, if it has expired, see your dealer/retailer for a replacement.

Using the Tire Sealant and Compressor Kit to Temporarily Seal a Punctured Tire

Follow these directions closely for correct sealant usage.

1. Do a safety check before proceeding. See *If a Tire Goes Flat on page 5-83*.
2. Inspect the damaged tire. The sealant cannot seal sidewall damage, large punctures, or a tire that has unseated from the wheel. See *Roadside Service on page 7-6*.
3. If an object, such as a nail, has penetrated the tire, do not remove it.

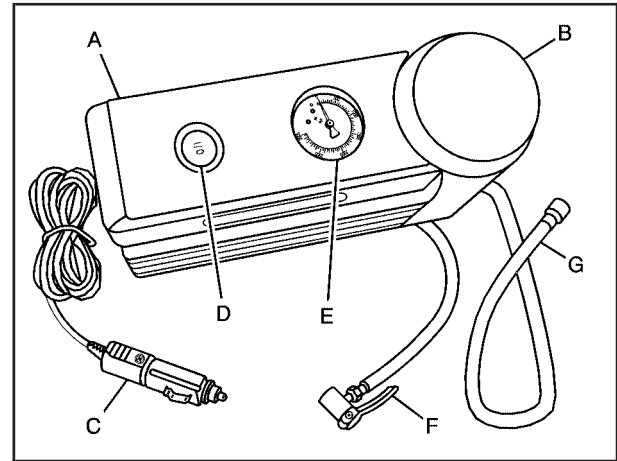

4. Place the sealant and compressor kit on the ground and unwrap the sealant/air hose (G) from the compressor.
5. Remove the valve stem cap from the flat tire by turning it counterclockwise.

6. Attach the sealant filling hose (G) onto the tire valve stem. Turn it clockwise until it is tight.

Make sure the sealant and compressor kit on/off switch (D) is in the O (off) position.

7. Remove the air compressor accessory plug (C) from the unit.
8. Plug the air compressor accessory plug (C) into an accessory power outlet in the vehicle. See *Accessory Power Outlet(s) on page 3-21* for more information.

Do not slam the door or close the window on the air compressor accessory plug.

 **CAUTION:**

Idling the engine in a closed-in place or with the climate control system off can cause deadly carbon monoxide (CO). See *Engine Exhaust on page 2-47*.

9. Start the vehicle. See *Starting the Engine on page 2-34* for more information. The vehicle must be running while using the air compressor.

 **CAUTION:**

Inflating something too much can make it explode, and you or others could be injured. Be sure to read the inflator instructions, and inflate the tire to its recommended pressure. Do not exceed 36 psi (248 kPa).

10. Push the On/Off switch to the I (on) position.

The sealant and compressor kit will inject sealant and air into the tire. Sealant may leak from the puncture until the vehicle is driven and the hole has sealed.

The pressure gage will initially show a high pressure while the compressor pushes the sealant into the tire. Once the sealant is completely dispersed into the tire, the pressure will quickly drop and start to rise again as the tire inflates with air.

11. Inflate the tire to the recommended inflation pressure, found on the Tire and Loading Information label using the air pressure gage on the top of the unit. See *Inflation - Tire Pressure on page 5-67*.

The pressure gage reads high while the compressor is running. Turn the compressor off to get an accurate pressure reading.

Notice: If the recommended pressure cannot be reached after 15 minutes, the vehicle should not be driven farther. Damage to the tire is severe and the sealant will not be effective. Remove the air compressor plug from the accessory power outlet and unscrew the inflating hose from the tire valve. See *Roadside Service on page 7-6*.

12. Push the on/off switch (D) to the O (off) position.
13. The tire is not sealed and will continue to leak air until the vehicle is driven and the sealant is distributed in the tire.

Steps 13 through 20 must be done right after Step 11.

14. Unplug the air compressor accessory plug (C) from the accessory power outlet in the vehicle.
15. Disconnect the sealant/air hose from the tire valve stem, by turning it counterclockwise, and replace the tire valve stem cap.
Be careful when handling the tire inflator components as they may be hot after usage.
16. Wrap the sealant/air hose around the air compressor channel to stow it in its original location.
17. Stow the air compressor accessory plug back in the air compressor. To do this, wrap the air compressor accessory plug, snap in the plug, and then push in the bottom and then the top of the wrapped air compressor accessory plug.

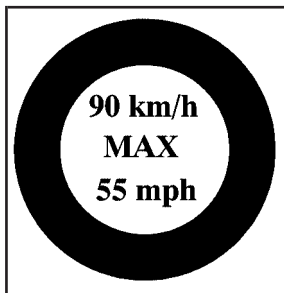

18. If the flat tire was able to inflate to the recommended inflation pressure, remove the maximum speed label from the sealant canister.

Place it in a highly visible location such as the inside of the upper left corner of the windshield or to the face of the radio/clock.

The maximum speed label reminds you to drive cautiously and not to exceed 55 mph (90 km/h) until you have the damaged tire inspected and repaired.

CAUTION:

Storing the tire sealant and compressor kit or other equipment in the passenger compartment of the vehicle could cause injury. In a sudden stop or collision, loose equipment could strike someone. Store the tire sealant and compressor kit in the proper place.

19. Return the equipment to its original storage location in the trunk of your vehicle.
20. Immediately drive the vehicle 5 miles (8 km) to distribute the sealant evenly in the tire. Stop at a safe location and check the tire pressure, refer to Steps 1 through 8 under “Using the Air Compressor without Sealant to Inflate an Underinflated Tire (Not Punctured)” next in this section.

21. If the tire pressure has fallen more than 10 psi (68 kPa), below the recommended inflation pressure, stop driving the vehicle. The tire is too severely damaged and the tire sealant and compressor kit cannot seal the tire. See *Roadside Service on page 7-6* for more information.

If the tire pressure has not dropped more than 10 psi (68 kPa) from the recommended inflation pressure, you can inflate the tire back up to the recommended inflation pressure.

22. Wipe off any sealant from the wheel, tire, and vehicle.
23. Dispose of the sealant canister (B) and sealant/air hose (G) at a local dealer/retailer or in accordance with your local state codes and practices.

After using the sealant canister, replace it with a new canister from your dealer/retailer.

24. After temporarily sealing a tire with the tire sealant and compressor kit, take your vehicle to your dealer/retailer to have the tire inspected and repaired or replaced.

Using the Air Compressor without Sealant to Inflate an Underinflated Tire (Not Punctured)

To use the air compressor to inflate a tire with air only and not sealant:

1. Do a safety check before proceeding. See *If a Tire Goes Flat on page 5-83*.
2. Inspect the damaged tire. The sealant cannot seal sidewall damage, large punctures, or a tire that has unseated from the wheel. See *Roadside Service on page 7-6*.
3. If an object, such as a nail, has penetrated the tire, do not remove it.

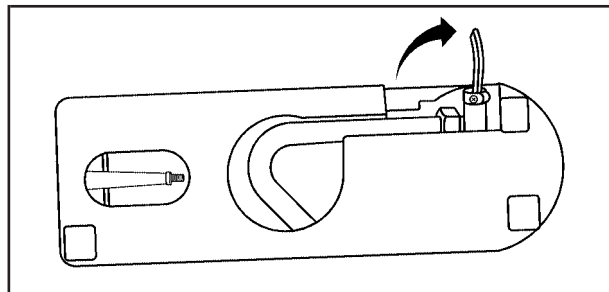

4. Unlock the air compressor hose from the sealant canister by pulling up on the lever.

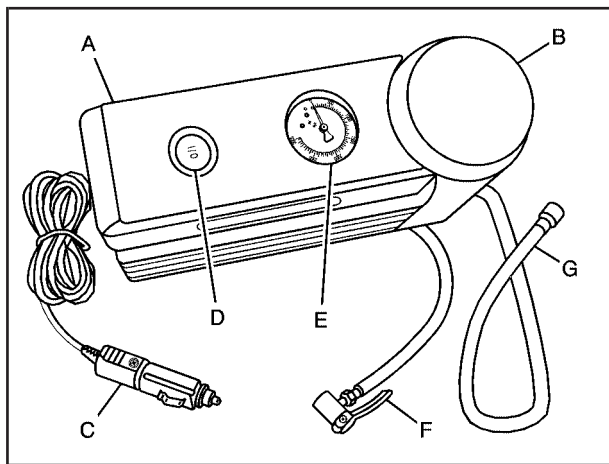

5. Pull the air only hose (F) from the sealant canister (B).
6. Push the air only hose (F) onto the tire valve stem and push the lever down to secure in place.
7. Plug the air compressor accessory plug (C) into an accessory power outlet in the vehicle. See *Accessory Power Outlet(s)* on page 3-21 for more information.

⚠ CAUTION:

Idling the engine in a closed-in place or with the climate control system off can cause deadly carbon monoxide (CO). See *Engine Exhaust* on page 2-47.

8. Start the vehicle. See *Starting the Engine* on page 2-34 for more information. The vehicle must be running while using the air compressor.

⚠ CAUTION:

Inflating something too much can make it explode, and you or others could be injured. Be sure to read the inflator instructions, and inflate the tire to its recommended pressure. Do not exceed 36 psi (248 kPa).

9. Push the sealant and compressor kit switch to the I (on) position.

- Inflate the tire up to the recommended inflation pressure using the air pressure gage on the top of the unit.

The pressure gage read high while the compressor is running. Turn the compressor off to get an accurate reading.

- Turn off the air compressor by pushing the switch to the O (off) position.

⚠ CAUTION:

Storing the tire sealant and compressor kit or other equipment in the passenger compartment of the vehicle could cause injury. In a sudden stop or collision, loose equipment could strike someone. Store the tire sealant and compressor kit in the proper place.

- Disconnect the compressor inflator hose and wrap the hose in the bottom of the sealant and compressor kit.
- Place the equipment in the original location of your vehicle.

Removal and Installation of the Sealant Canister

To remove the sealant canister:

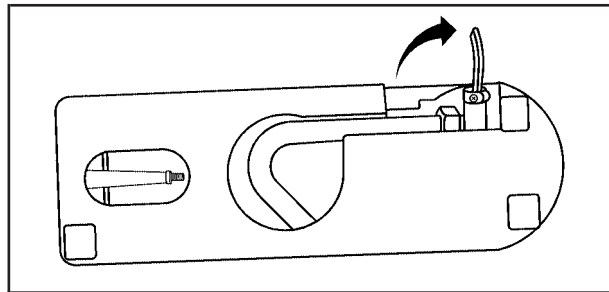

- Unlock the air compressor hose from the sealant canister by pulling up on the lever.
- Pull the air only hose (F) from the sealant canister (B).
- Unwrap the sealant/air hose from the compressor.

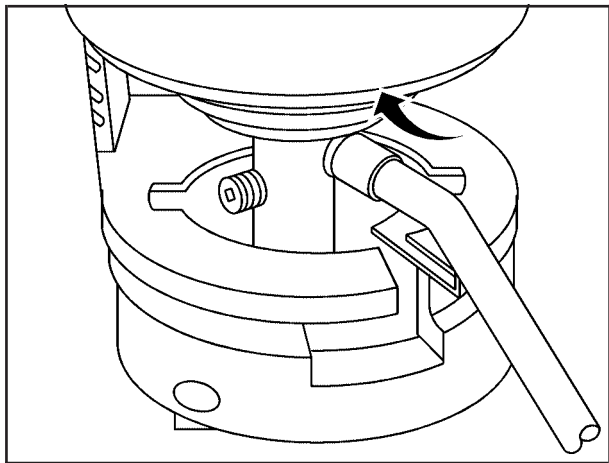

To install a new sealant canister:

1. Align the sealant/air hose with the slot in the air compressor.
2. Push the sealant canister down and turn it clockwise.
3. Wrap the sealant/air hose around the air compressor channel to stow it in its original location.
4. Push the air only hose onto the sealant canister inlet and push the lever down to secure.

Changing a Flat Tire

If a tire goes flat, avoid further tire and wheel damage by driving slowly to a level place. Turn on your vehicle's hazard warning flashers. See *Hazard Warning Flashers on page 3-6* for more information.

4. Turn the sealant canister so the inflator filling hose is aligned with the slot in the compressor.
5. Lift the sealant canister from the compressor and replace with a new sealant canister. See your dealer/retailer for more information.

⚠ CAUTION:

Changing a tire can be dangerous. The vehicle can slip off the jack and roll over or fall on you or other people. You and they could be badly injured or even killed. Find a level place to change your tire. To help prevent the vehicle from moving:

1. Set the parking brake firmly.
2. Put the shift lever in PARK (P).
3. Turn off the engine and do not restart while the vehicle is raised.
4. Do not allow passengers to remain in the vehicle.

To be even more certain the vehicle will not move, you should put blocks at the front and rear of the tire farthest away from the one being changed. That would be the tire, on the other side, at the opposite end of the vehicle.

When your vehicle has a flat tire, use the following example as a guide to assist you in the placement of wheel blocks.

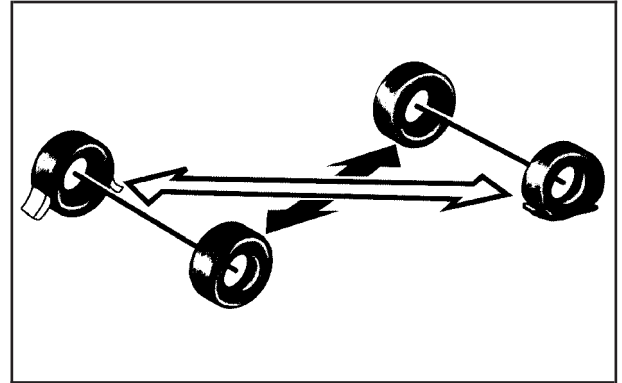

The following information tells you how to use the jack and change a tire.

Removing the Spare Tire and Tools

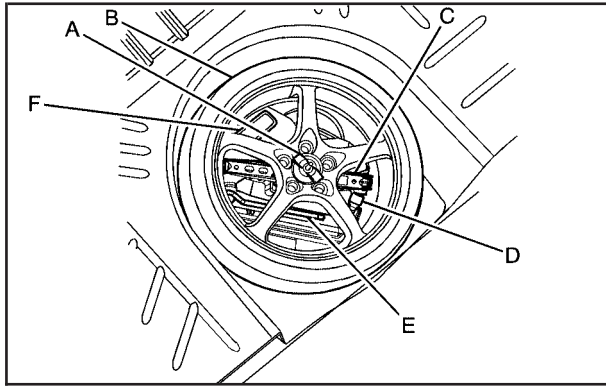

- A. Wing Nut
- B. Spare Tire
- C. Jack

- D. Wheel Wrench
- E. Extension
- F. Strap

The equipment you will need is in the trunk.

To gain access to the spare tire and jacking equipment, do the following:

1. Remove the spare tire cover.
2. Remove the stow rod cap by pulling it straight up off of the rod.
3. Turn the wing nut (A) on the compact spare tire (B) counterclockwise to remove it.
4. Remove the spare tire and place it next to the flat tire.
5. The tools you will be using next include the jack (C), wheel wrench (D), and extension (E).

Removing the Flat Tire and Installing the Spare Tire

1. Do a safety check before proceeding. See *Changing a Flat Tire* on page 5-102 for more information.

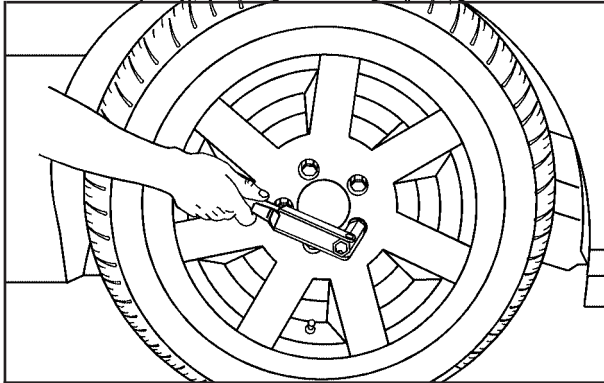

2. Loosen the wheel nuts, but do not remove them yet, using the wheel wrench. Turn the handle about 180 degrees, then return the handle back to the starting position. This avoids taking the wrench off the lug nut for each turn.

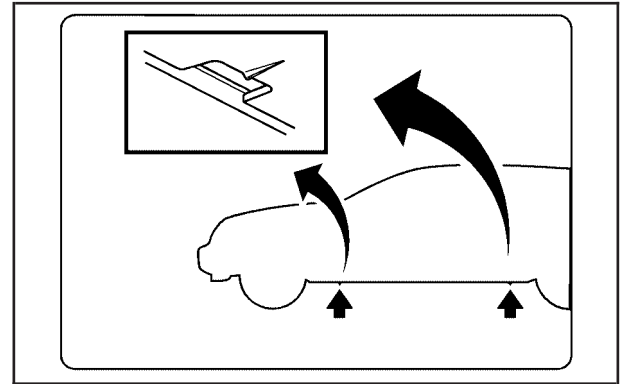

3. Find the jacking location using the diagram above and corresponding V-shaped locating notches located in the plastic molding.

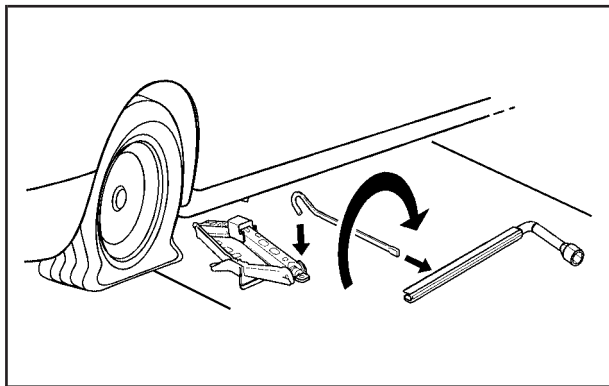

4. Insert the hooked end of the extension handle through the jack and the flat end through the wheel wrench.

⚠ CAUTION:

Getting under a vehicle when it is jacked up is dangerous. If the vehicle slips off the jack, you could be badly injured or killed. Never get under a vehicle when it is supported only by a jack.

⚠ CAUTION:

Lifting a vehicle and getting under it to do maintenance or repairs is dangerous without the appropriate safety equipment and training. The jack provided with your vehicle is designed only for changing a flat tire. If it is used for anything else, you or others could be badly injured or killed if the vehicle slips off the jack. Use the jack provided with your vehicle only for changing a flat tire.

⚠ CAUTION:

Raising your vehicle with the jack improperly positioned can damage the vehicle and even make the vehicle fall. To help avoid personal injury and vehicle damage, be sure to fit the jack lift head into the proper location before raising the vehicle.

Notice: If you position the jack under the rocker molding and attempt to raise the vehicle, you could break the molding and/or cause other damage to your vehicle. Always position the jack so that when the jack head is raised, it will fit firmly in the notch located inboard from the rocker molding.

5. Turn the wheel wrench counterclockwise to lower the jack lift head until the jack fits under the vehicle.

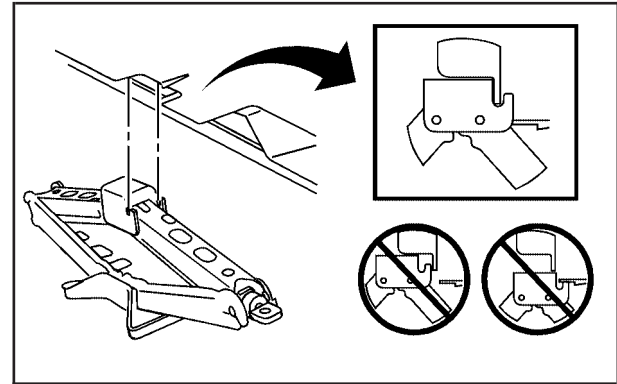

6. Raise the jack by turning the wheel wrench clockwise until the slots in the jack head fit into the metal flange located behind the V-shaped locating notches on the plastic molding as shown.
7. Put the compact spare tire near you.
8. Raise the vehicle by turning the wheel wrench clockwise. Raise the vehicle far enough off the ground for the compact spare tire to fit under the vehicle.

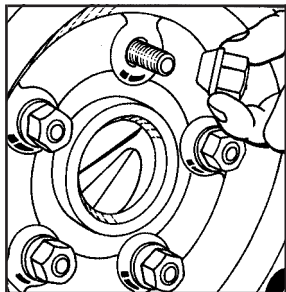

9. Remove all the wheel nuts and the flat tire.

⚠ CAUTION:

Rust or dirt on a wheel, or on the parts to which it is fastened, can make wheel nuts become loose after time. The wheel could come off and cause an accident. When you change a wheel, remove any rust or dirt from places where the wheel attaches to the vehicle. In an emergency, you can use a cloth or a paper towel to do this; but be sure to use a scraper or wire brush later, if needed, to get all the rust or dirt off. See *Changing a Flat Tire on page 5-102*.

⚠ CAUTION:

Never use oil or grease on studs or nuts. Because the nuts might come loose. The vehicle's wheel could fall off, causing a crash.

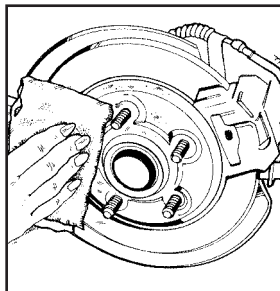

10. Remove any rust or dirt from the wheel bolts, mounting surfaces, and spare wheel.

11. Install the spare tire.
12. Put the wheel nuts back on with the rounded end of the nuts toward the wheel.

13. Tighten each wheel nut by turning it clockwise with your hand until the wheel is held against the hub.
14. Lower the vehicle by turning the wheel wrench counterclockwise. Lower the jack completely.

⚠ CAUTION:

Incorrect or improperly tightened wheel nuts can cause the wheel to come loose and even come off. This could lead to a crash. If you have to replace them, be sure to get new original equipment wheel nuts. Stop somewhere as soon as you can and have the nuts tightened with a torque wrench to the proper torque specification. See *Capacities and Specifications on page 5-128* for wheel nut torque specification.

Notice: Improperly tightened wheel nuts can lead to brake pulsation and rotor damage. To avoid expensive brake repairs, evenly tighten the wheel nuts in the proper sequence and to the proper torque specification. See *Capacities and Specifications on page 5-128* for the wheel nut torque specification.

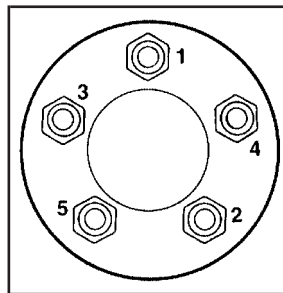

15. Tighten the wheel nuts firmly in a crisscross sequence as shown.

Storing a Flat or Spare Tire and Tools

CAUTION:

Storing a jack, a tire, or other equipment in the passenger compartment of the vehicle could cause injury. In a sudden stop or collision, loose equipment could strike someone. Store all these in the proper place.

After you have put the compact spare tire on your vehicle, you will need to store the flat tire in your trunk.

The compact spare is for temporary use only. Replace the compact spare tire with a full-size tire as soon as you can.

Use the following diagram as a guide for storing the compact spare tire in the trunk:

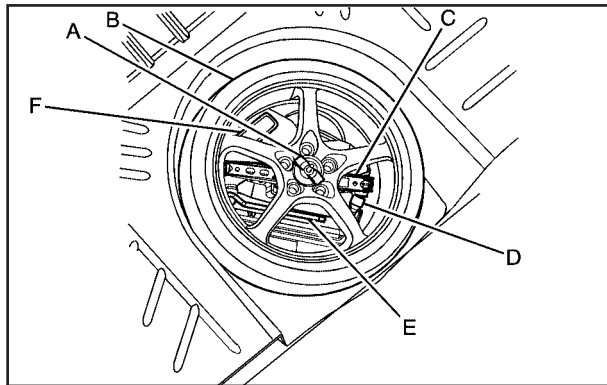

- | | |
|--|-----------------|
| A. Wing Nut | C. Jack |
| B. Compact Spare
Tire or Flat Tire
(valve stem down) | D. Wheel Wrench |
| | E. Extension |
| | F. Strap |

Compact Spare Tire

If your vehicle is equipped with a compact spare tire it was fully inflated when the vehicle was new, it can lose air after a time. Check the inflation pressure regularly. It should be 60 psi (420 kPa).

After installing the compact spare on the vehicle, stop as soon as possible and make sure the spare tire is correctly inflated. The compact spare is made to perform well at speeds up to 65 mph (105 km/h) for distances up to 3,000 miles (5 000 km), so you can finish your trip and have the full-size tire repaired or replaced at your convenience. Of course, it is best to replace the spare with a full-size tire as soon as possible. The spare tire will last longer and be in good shape in case it is needed again.

Notice: When the compact spare is installed, do not take your vehicle through an automatic car wash with guide rails. The compact spare can get caught on the rails. That can damage the tire and wheel, and maybe other parts of your vehicle.

Do not use the compact spare on other vehicles.

And do not mix the compact spare tire or wheel with other wheels or tires. They will not fit. Keep the spare tire and its wheel together.

Notice: Tire chains will not fit your compact spare. Using them can damage your vehicle and can damage the chains too. Do not use tire chains on your compact spare.

Appearance Care

Interior Cleaning

Your vehicle's interior will continue to look its best if it is cleaned often. Although not always visible, dust and dirt can accumulate on your upholstery. Dirt can damage carpet, fabric, leather, and plastic surfaces. Regular vacuuming is recommended to remove particles from your upholstery. It is important to keep your upholstery from becoming and remaining heavily soiled. Soils should be removed as quickly as possible. Your vehicle's interior may experience extremes of heat that could cause stains to set rapidly.

Lighter colored interiors may require more frequent cleaning. Use care because newspapers and garments that transfer color to your home furnishings may also transfer color to your vehicle's interior.

When cleaning your vehicle's interior, only use cleaners specifically designed for the surfaces being cleaned. Permanent damage may result from using cleaners on surfaces for which they were not intended. Use glass cleaner only on glass. Remove any accidental over-spray from other surfaces immediately. To prevent over-spray, apply cleaner directly to the cleaning cloth.

Notice: If you use abrasive cleaners when cleaning glass surfaces on your vehicle, you could scratch the glass and/or cause damage to the rear window defogger. When cleaning the glass on your vehicle, use only a soft cloth and glass cleaner.

Many cleaners contain solvents that may become concentrated in your vehicle's breathing space. Before using cleaners, read and adhere to all safety instructions on the label. While cleaning your vehicle's interior, maintain adequate ventilation by opening your vehicle's doors and windows.

Dust may be removed from small buttons and knobs using a small brush with soft bristles.

Your dealer/retailer has a product for cleaning your vehicle's glass. Should it become necessary, you can also obtain a product from your dealer/retailer to remove odors from your vehicle's upholstery.

Do not clean your vehicle using:

- A knife or any other sharp object to remove a soil from any interior surface.
- A stiff brush. It can cause damage to your vehicle's interior surfaces.
- Heavy pressure or aggressive rubbing with a cleaning cloth. Use of heavy pressure can damage your interior and does not improve the effectiveness of soil removal.
- Laundry detergents or dishwashing soaps with degreasers can leave residue that streaks and attracts dirt. For liquid cleaners, about 20 drops per gallon (3.78 L) of water is a good guide. Use only mild, neutral-pH soaps.
- Too much cleaner that saturates the upholstery.
- Organic solvents such as naphtha, alcohol, etc. that can damage your vehicle's interior.

Fabric/Carpet

Use a vacuum cleaner with a soft brush attachment frequently to remove dust and loose dirt. A canister vacuum with a beater bar in the nozzle may only be used on floor carpet and carpeted floor mats. For any soil, always try to remove it first with plain water or club soda. Before cleaning, gently remove as much of the soil as possible using one of the following techniques:

- For liquids: gently blot the remaining soil with a paper towel. Allow the soil to absorb into the paper towel until no more can be removed.
- For solid dry soils: remove as much as possible and then vacuum.

To clean:

1. Saturate a lint-free, clean white cloth with water or club soda.
2. Wring the cloth to remove excess moisture.
3. Start on the outside edge of the soil and gently rub toward the center. Continue cleaning, using a clean area of the cloth each time it becomes soiled.
4. Continue to gently rub the soiled area until the cleaning cloth remains clean.
5. If the soil is not completely removed, use a mild soap solution and repeat the cleaning process that was used with plain water.

If any of the soil remains, a commercial fabric cleaner or spot lifter may be necessary. When a commercial upholstery cleaner or spot lifter is to be used, test a small hidden area for colorfastness first. If the locally cleaned area gives any impression that a ring formation may result, clean the entire surface.

After the cleaning process has been completed, a paper towel can be used to blot excess moisture from the fabric or carpet.

Leather

A soft cloth dampened with water can be used to remove dust. If a more thorough cleaning is necessary, a soft cloth dampened with a mild soap solution can be used. Allow the leather to dry naturally. Do not use heat to dry. Never use steam to clean leather. Never use spot lifters or spot removers on leather. Many commercial leather cleaners and coatings that are sold to preserve and protect leather may permanently change the appearance and feel of your leather and are not recommended. Do not use silicone or wax-based products, or those containing organic solvents to clean your vehicle's interior because they can alter the appearance by increasing the gloss in a non-uniform manner. Never use shoe polish on leather.

Instrument Panel, Vinyl, and Other Plastic Surfaces

A soft cloth dampened with water may be used to remove dust. If a more thorough cleaning is necessary, a clean soft cloth dampened with a mild soap solution can be used to gently remove dust and dirt. Never use spot lifters or removers on plastic surfaces. Many commercial cleaners and coatings that are sold to preserve and protect soft plastic surfaces may permanently change the appearance and feel of your interior and are not recommended. Do not use silicone or wax-based products, or those containing organic solvents to clean your vehicle's interior because they can alter the appearance by increasing the gloss in a non-uniform manner.

Some commercial products may increase gloss on your instrument panel. The increase in gloss may cause annoying reflections in the windshield and even make it difficult to see through the windshield under certain conditions.

Wood Panels

Use a clean cloth moistened in warm, soapy water (use mild dish washing soap). Dry the wood immediately with a clean cloth.

Speaker Covers

Vacuum around a speaker cover gently, so that the speaker will not be damaged. Clean spots with just water and mild soap.

Care of Safety Belts

Keep belts clean and dry.

CAUTION:

Do not bleach or dye safety belts. If you do, it may severely weaken them. In a crash, they might not be able to provide adequate protection. Clean safety belts only with mild soap and lukewarm water.

Weatherstrips

Silicone grease on weatherstrips will make them last longer, seal better, and not stick or squeak. Apply silicone grease with a clean cloth. During very cold, damp weather frequent application may be required. See *Recommended Fluids and Lubricants on page 6-11*.

Washing Your Vehicle

The best way to preserve your vehicle's finish is to keep it clean by washing it often.

Notice: Certain cleaners contain chemicals that can damage the emblems or nameplates on your vehicle. Check the cleaning product label. If it states that it should not be used on plastic parts, do not use it on your vehicle or damage may occur and it would not be covered by the warranty.

Do not wash the vehicle in direct sunlight. Use a car washing soap. Do not use cleaning agents that are petroleum based or that contain acid or abrasives, as they can damage the paint, metal or plastic on your vehicle. Approved cleaning products can be obtained from your dealer/retailer. See *Vehicle Care/Appearance Materials on page 5-119*. Follow all manufacturers' directions regarding correct product usage, necessary safety precautions and appropriate disposal of any vehicle care product.

Rinse the vehicle well, before washing and after to remove all cleaning agents completely. If they are allowed to dry on the surface, they could stain.

Dry the finish with a soft, clean chamois or an all-cotton towel to avoid surface scratches and water spotting

High pressure car washes may cause water to enter the vehicle. Avoid using high pressure washes closer than 12 inches (30 cm) to the surface of the vehicle. Use of power washers exceeding 1,200 psi (8 274 kPa) can result in damage or removal of paint and decals.

Cleaning Exterior Lamps/Lenses

Use only lukewarm or cold water, a soft cloth and a car washing soap to clean exterior lamps and lenses. Follow instructions under *Washing Your Vehicle* on page 5-115.

Finish Care

Occasional waxing or mild polishing of your vehicle by hand may be necessary to remove residue from the paint finish. You can get approved cleaning products from your dealer/retailer. See *Vehicle Care/Appearance Materials* on page 5-119.

If your vehicle has a basecoat/clearcoat paint finish, the clearcoat gives more depth and gloss to the colored basecoat. Always use waxes and polishes that are non-abrasive and made for a basecoat/clearcoat paint finish.

Notice: Machine compounding or aggressive polishing on a basecoat/clearcoat paint finish may damage it. Use only non-abrasive waxes and polishes that are made for a basecoat/clearcoat paint finish on your vehicle.

Foreign materials such as calcium chloride and other salts, ice melting agents, road oil and tar, tree sap, bird droppings, chemicals from industrial chimneys, etc., can damage your vehicle's finish if they remain on painted surfaces. Wash the vehicle as soon as possible. If necessary, use non-abrasive cleaners that are marked safe for painted surfaces to remove foreign matter.

Exterior painted surfaces are subject to aging, weather and chemical fallout that can take their toll over a period of years. You can help to keep the paint finish looking new by keeping your vehicle garaged or covered whenever possible.

Protecting Exterior Bright Metal Parts

Bright metal parts should be cleaned regularly to keep their luster. Washing with water is all that is usually needed. However, you may use chrome polish on chrome or stainless steel trim, if necessary.

Use special care with aluminum trim. To avoid damaging protective trim, never use auto or chrome polish, steam or caustic soap to clean aluminum. A coating of wax, rubbed to high polish, is recommended for all bright metal parts.

Windshield and Wiper Blades

Clean the outside of the windshield with glass cleaner.

Clean the rubber blades using a lint free cloth or paper towel soaked with windshield washer fluid or a mild detergent. Wash the windshield thoroughly when cleaning the blades. Bugs, road grime, sap, and a buildup of vehicle wash/wax treatments may cause wiper streaking. Replace the wiper blades if they are worn or damaged.

Wipers can be damaged by:

- Extreme dusty conditions
- Sand and salt
- Heat and sun
- Snow and ice, without proper removal

Aluminum or Chrome-Plated Wheels and Trim

Your vehicle may have either aluminum or chrome-plated wheels.

Keep the wheels clean using a soft clean cloth with mild soap and water. Rinse with clean water. After rinsing thoroughly, dry with a soft clean towel. A wax may then be applied.

Notice: Chrome wheels and other chrome trim may be damaged if you do not wash your vehicle after driving on roads that have been sprayed with magnesium, calcium or sodium chloride. These chlorides are used on roads for conditions such as ice and dust. Always wash your vehicle's chrome with soap and water after exposure.

Notice: If you use strong soaps, chemicals, abrasive polishes, cleaners, brushes, or cleaners that contain acid on aluminum or chrome-plated wheels, you could damage the surface of the wheel(s). The repairs would not be covered by your warranty. Use only approved cleaners on aluminum or chrome-plated wheels.

The surface of these wheels is similar to the painted surface of your vehicle. Do not use strong soaps, chemicals, abrasive polishes, abrasive cleaners, cleaners with acid, or abrasive cleaning brushes on them because you could damage the surface. Do not use chrome polish on aluminum wheels.

Notice: Using chrome polish on aluminum wheels could damage the wheels. The repairs would not be covered by your warranty. Use chrome polish on chrome wheels only.

Use chrome polish only on chrome-plated wheels, but avoid any painted surface of the wheel, and buff off immediately after application.

Notice: If you drive your vehicle through an automatic car wash that has silicone carbide tire cleaning brushes, you could damage the aluminum or chrome-plated wheels. The repairs would not be covered by your warranty. Never drive a vehicle equipped with aluminum or chrome-plated wheels through an automatic car wash that uses silicone carbide tire cleaning brushes.

Tires

To clean the tires, use a stiff brush with tire cleaner.

Notice: Using petroleum-based tire dressing products on your vehicle may damage the paint finish and/or tires. When applying a tire dressing, always wipe off any overspray from all painted surfaces on your vehicle.

Sheet Metal Damage

If the vehicle is damaged and requires sheet metal repair or replacement, make sure the body repair shop applies anti-corrosion material to parts repaired or replaced to restore corrosion protection.

Original manufacturer replacement parts will provide the corrosion protection while maintaining the warranty.

Finish Damage

Any stone chips, fractures or deep scratches in the finish should be repaired right away. Bare metal will corrode quickly and may develop into major repair expense.

Minor chips and scratches can be repaired with touch-up materials available from your dealer/retailer. Larger areas of finish damage can be corrected in your dealer's/retailer's body and paint shop.

Underbody Maintenance

Chemicals used for ice and snow removal and dust control can collect on the underbody. If these are not removed, corrosion and rust can develop on the underbody parts such as fuel lines, frame, floor pan, and exhaust system even though they have corrosion protection.

At least every spring, flush these materials from the underbody with plain water. Clean any areas where mud and debris can collect. Dirt packed in close areas of the frame should be loosened before being flushed. Your dealer/retailer or an underbody car washing system can do this for you.

Chemical Paint Spotting

Some weather and atmospheric conditions can create a chemical fallout. Airborne pollutants can fall upon and attack painted surfaces on the vehicle. This damage can take two forms: blotchy, ring-shaped discolorations, and small, irregular dark spots etched into the paint surface.

Although no defect in the paint job causes this, we will repair, at no charge to the owner, the surfaces of new vehicles damaged by this fallout condition within 12 months or 12,000 miles (20 000 km) of purchase, whichever occurs first.

Vehicle Care/Appearance Materials

Description	Usage
Polishing Cloth	Interior and exterior polishing cloth.
Tar and Road Oil Remover	Removes tar, road oil, and asphalt.
Chrome Cleaner and Polish	Use on chrome or stainless steel.
White Sidewall Tire Cleaner	Removes soil and black marks from whitewalls and raised white lettering.
Vinyl Cleaner	Cleans vinyl.
Glass Cleaner	Removes dirt, grime, smoke and fingerprints.
Chrome Wheel Cleaner	Removes dirt and grime from chrome wheels.
Finish Enhancer	Removes dust, fingerprints, and surface contaminants. Spray on and wipe off.
Swirl Remover Polish	Removes swirl marks, fine scratches, and other light surface contamination.

Description	Usage
Cleaner Wax	Removes light scratches and protects finish.
Foaming Tire Shine Low Gloss	Cleans, shines, and protects tires. No wiping necessary.
Wash Wax Concentrate	Medium foaming shampoo. Cleans and lightly waxes. Biodegradable and phosphate free.
Spot Lifter	Quickly removes spots and stains from carpets, vinyl, and cloth upholstery.
Odor Eliminator	Odorless spray odor eliminator used on fabrics, vinyl, leather and carpet.

Vehicle Identification

Vehicle Identification Number (VIN)



This is the legal identifier for your vehicle. It appears on a plate in the front corner of the instrument panel, on the driver side. You can see it if you look through the windshield from outside your vehicle. The VIN also appears on the Vehicle Certification and Service Parts labels and the certificates of title and registration.

Engine Identification

The eighth character in the VIN is the engine code. This code helps you identify your vehicle's engine, specifications, and replacement parts. See *Capacities and Specifications on page 5-128* for your vehicle's engine code.

Service Parts Identification Label

This label is on the spare tire cover. It is very helpful if you ever need to order parts. The label has the following information:

- Vehicle Identification Number (VIN)
- Model designation
- Paint information
- Production options and special equipment

Do not remove this label from the vehicle.

Electrical System

Add-On Electrical Equipment

Notice: Do not add anything electrical to your vehicle unless you check with your dealer/retailer first. Some electrical equipment can damage your vehicle and the damage would not be covered by your warranty. Some add-on electrical equipment can keep other components from working as they should.

Add-on equipment can drain your vehicle's battery, even if your vehicle is not operating.

Your vehicle has an airbag system. Before attempting to add anything electrical to your vehicle, see *Servicing Your Airbag-Equipped Vehicle on page 1-68*.

Windshield Wiper Fuses

The windshield wiper motor is protected by an internal circuit breaker. If the wiper motor overheats due to heavy snow, the wipers will stop until the motor cools and will then restart.

Power Windows and Other Power Options

Circuit breakers in the fuse block protect the power windows and other power accessories. When the current load is too heavy, the circuit breaker opens and closes, protecting the circuit until the problem is fixed or goes away.

Fuses and Circuit Breakers

The wiring circuits in your vehicle are protected from short circuits by a combination of fuses and circuit breakers. This greatly reduces the chance of fires caused by electrical problems.

Look at the silver-colored band inside the fuse. If the band is broken or melted, replace the fuse. Be sure you replace a bad fuse with a new one of the identical size and rating.

If you ever have a problem on the road and don't have a spare fuse, you can borrow one that has the same amperage. Just pick some feature of your vehicle that you can get along without — like the radio or cigarette lighter — and use its fuse, if it is the correct amperage. Replace it as soon as you can.

Underhood Fuse Block

The underhood fuse block is located on the passenger side of the engine compartment.

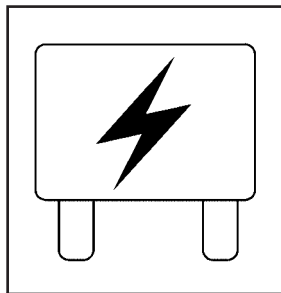

Lift the fuse block cover to access the fuses.

Notice: Spilling liquid on any electrical components on your vehicle may damage it. Always keep the covers on any electrical component.

NOTE: -RELAYS TO BE INSERTED AS PER LABEL AND WITH THE CORRECT ORIENTATION AS INDICATED BY THE NOTCH. AN ORIENTATION DIFFERENCE OF 180° IS ACCEPTABLE FOR 4 TERMINAL RELAYS.



NOTE: -INSERER LES RELAIS D'APRES LES INDICATIONS SUR L'ETIQUETTE. L'INDENTATION INDIQUE L'ORIENTATION CORRECTE. UNE DIFFERENCE D'ORIENTATION DE 180° EST ACCEPTABLE POUR LES RELAIS A 4 BORNES.

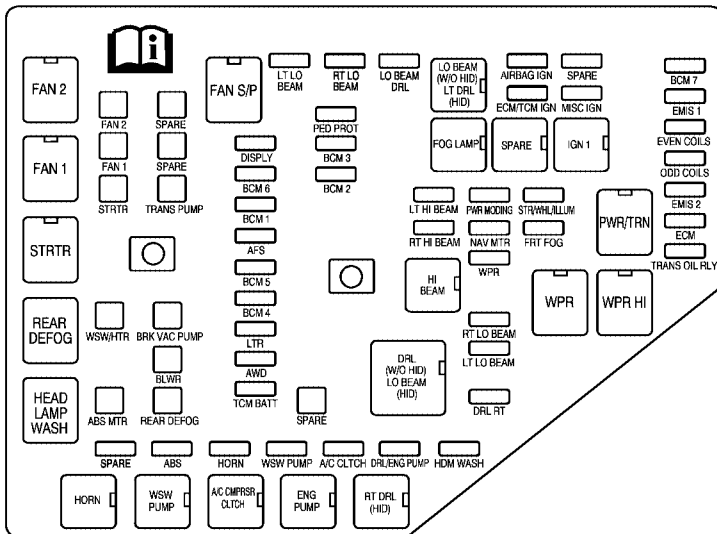

Fuses	Usage
LT LO BEAM	Left Low-Beam Headlamp
RT LO BEAM	Right Low-Beam Headlamp
LO BEAM DRL	Low-Beam Daytime Running Lamp (DRL)

Fuses	Usage
AIRBAG IGN	Airbag Switch
SPARE	Spare
BCM 7	Body Control Module 7
PED PROT	Not Used

Fuses	Usage
ECM/TCM IGN	Engine Control Module (ECM), Transmission Control Module (TCM), IPC (Instrument Panel Cluster), PASS-Key® III+ Module
MISC IGN	Ignition
EMIS 1	Emission 1
DISPLY	Display
BCM 3	Body Control Module 3
EVEN COILS	Even Coils
BCM 6	Body Control Module 6
BCM 2	Body Control Module 2
ODD COILS	Odd Coils
BCM 1	Body Control Module 1
LT HI BEAM	Left High-Beam Headlamp
PWR MODING	PassKey Module, Body Control Module
STR/WHL/ILLUM	Steering Wheel Illumination
EMIS 2	Emission 2
AFS	Adaptive Forward Lighting System
RT HI BEAM	Right High-Beam Headlamp
NAV MTR	Navigation Motor
FRT FOG	Front Fog Lamps
ECM	Engine Control Module
BCM 5	Body Control Module 5

Fuses	Usage
WPR	Windshield Wiper
TRANS OIL RLY	Transmission Oil Relay
BCM 4	Body Control Module 4
RT LO BEAM	Right Low-Beam Headlamp
AWD	All-Wheel Drive
LT LO BEAM	Left Low-Beam Headlamp
TCM BATT	Transmission Control Module Battery
DRL RT	Right Daytime Running Lamp (DRL)
SPARE	Spare
ABS	Antilock Brake System
HORN	Horn
WSW PUMP	Windshield Washer Pump
A/C CLTCH	Air Conditioning Compressor Clutch
DRL/ENG PUMP	Daytime Running Lamps (DRL)
HDM WASH	Headlamp Driver Module Washer

J-Case Fuses	Usage
FAN 2	Cooling Fan 2
SPARE	Spare
FAN 1	Cooling Fan 2
SPARE	Spare

J-Case Fuses	Usage
STRTR	Starter
TRANS PUMP	Transmission Pump
WSW/HTR	Windshield Washer Heater
BRK VAC PUMP	Brake Vacuum Pump
BLWR	Blower
ABS MTR	Antilock Brake System Motor
REAR DEFOG	Rear Defogger
SPARE	Spare

Relays	Usage
FAN 2	Cooling Fan 2
FAN S/P	Cooling Fan Series/Parallel
LO BEAM (W/O HID) LT DRL (HID)	Low-Beam (without High Intensity Discharge), Left Daytime Running Lamp (High Intensity Discharge)
FAN 1	Cooling Fan 1
FOG LAMP	Fog Lamps
SPARE	Spare

Relays	Usage
IGN 1	Ignition 1
STRTR	Starter
PWR/TRN	Powertrain
REAR DEFOG	Rear Defogger
HI BEAM	High-Beam Headlamp
DRL (W/O HID) LO BEAM (HID)	Daytime Running Lamps (without High Intensity Discharge), Low Beam Headlamps (High Intensity Discharge)
WPR	Windshield Wiper
WPR HI	Windshield Wiper High Speed
HEAD LAMP WASH	Headlamp Washer
HORN	Horn
WSW PUMP	Windshield Washer Pump
A/C CMPRSR	Air Conditioning Compressor
ENG PUMP	Engine Pump
RT DRL (HID)	Right Daytime Running Lamp (High Intensity Discharge)

Rear Compartment Fuse Block

The rear compartment fuse block is located on top of the battery, on the right side of the trunk. The battery access door must be removed to access the fuse block.

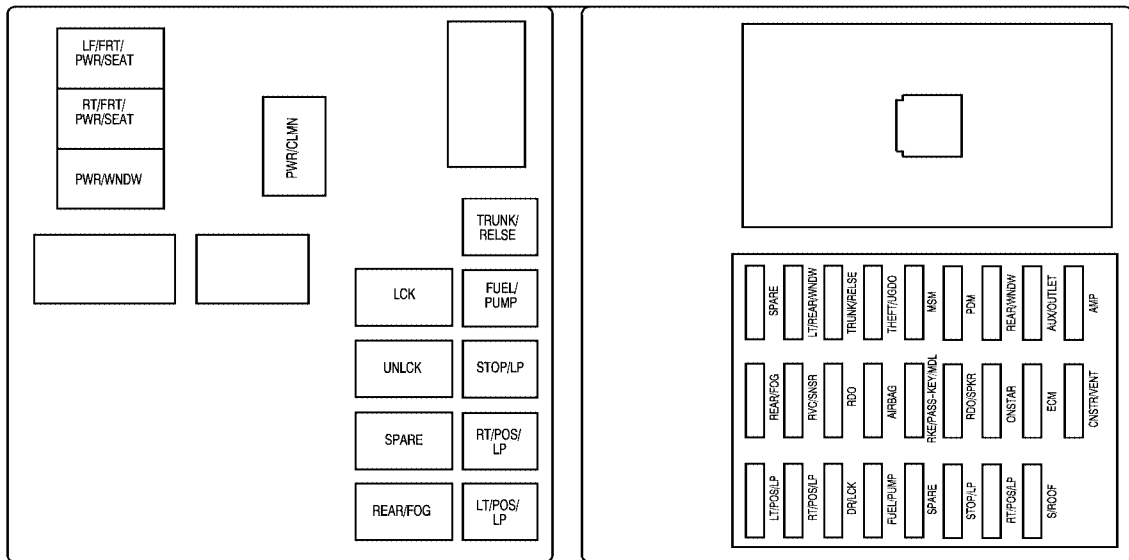

Relays	Usage
LF FRT/ PWR/SEAT	Left Front Power Seat
RT FRT/ PWR/SEAT	Right Front Power Seat
PWR/WNDW	Power
PWR/CLMN	Power Steering Column
TRUNK/RELSE	Trunk Release
LCK	Lock
FUEL/PUMP	Fuel Pump
UNLCK	Unlock
STOP/LP	Stoplamp
SPARE	Spare
RT/POS/LP	Right Position Lamp
REAR/FOG	Not Used
LT/POS/LP	Left Position Lamp

Fuses	Usage
LT/POS/LP	Left Position Lamp
REAR/FOG	Not Used
SPARE	Spare
RT/POS/LP	Right Position Lamp
RVC/SNSR	Regulated Voltage Control Sensor
LT/REAR/ WNDW	Left Rear Window

Fuses	Usage
DR/LCK	Door Lock
RDO	Audio System
TRUNK/RELSE	Trunk Release
FUEL/PUMP	Fuel Pump
AIRBAG	Airbag System
THEFT/UGDO	Theft Deterrent System, Universal Home Remote System
SPARE	Spare
RKE/ PASS-Key®/ MDL	Remote Keyless Entry System, PASS-Key® Theft Deterrent Feature Module
MSM	Memory Seat Module
STOP/LP	Stoplamp
RDO/SPKR	Audio Speakers
PDM	Passenger Door Module
RT/POS/LP	Right Position Lamp
ONSTAR	OnStar® System
REAR/WNDW	Rear Window
S/ROOF	Sunroof
ECM	Engine Control Module (ECM)
AUX/OUTLET	Auxiliary Power Outlet
CNSTR/VENT	Canister Vent
AMP	Amplifier

Capacities and Specifications

The following approximate capacities are given in English and metric conversions. See *Recommended Fluids and Lubricants* on page 6-11 for more information.

Application	Capacities	
	English	Metric
Air Conditioning Refrigerant R134a	For the air conditioning system refrigerant charge amount, see the refrigerant caution label located under the hood. See your dealer/retailer for more information.	
Cooling System		
3.6L HFV6 Engine (LY7)	10.3 qt	9.7 L
3.6L HFV6 Engine (LLT)	10.6 qt	10.0 L
Engine Oil with Filter		
3.6L HFV6 Engine	6.0 qt	5.7 L
Fuel Tank	18.0 gal	68.1 L
Transmission (Pan Removal and Replacement)		
6-Speed Automatic	6.7 qt	6.3 L
6-Speed Manual	1.9 qt	1.8 L
Wheel Nut Torque	100 lb ft	(140 N•m)
All capacities are approximate. When adding, be sure to fill to the approximate level, as recommended in this manual. Recheck fluid level after filling.		

Engine Specifications

Engine	VIN Code	Transmission	Spark Plug Gap
3.6L HFV6	7	Automatic Manual	0.043 inches (1.1 mm)
3.6L HFV6	V	Automatic Manual	0.043 inches (1.1 mm)

Section 6 Maintenance Schedule

Maintenance Schedule	6-2	Owner Checks and Services	6-8
Introduction	6-2	At Each Fuel Fill	6-8
Maintenance Requirements	6-2	At Least Once a Month	6-8
Your Vehicle and the Environment	6-2	At Least Once a Year	6-9
Using the Maintenance Schedule	6-2	Recommended Fluids and Lubricants	6-11
Scheduled Maintenance	6-4	Maintenance Replacement Parts	6-13
Additional Required Services	6-5	Engine Drive Belt Routing	6-14
Maintenance Footnotes	6-6	Maintenance Record	6-15

Maintenance Schedule

Introduction

Important: Keep engine oil at the proper level and change as recommended.



Have you purchased the GM Protection Plan? The Plan supplements your new vehicle warranties. See your Warranty and Owner Assistance booklet or your dealer/retailer for details.

Maintenance Requirements

Notice: Maintenance intervals, checks, inspections, replacement parts, and recommended fluids and lubricants as prescribed in this manual are necessary to keep your vehicle in good working condition. Any damage caused by failure to follow scheduled maintenance might not be covered by warranty.

Your Vehicle and the Environment

Proper vehicle maintenance not only helps to keep your vehicle in good working condition, but also helps the environment. All recommended maintenance is important. Improper vehicle maintenance can even affect the quality of the air we breathe. Improper fluid levels or the wrong tire inflation can increase the level of emissions from your vehicle. To help protect our environment, and to keep your vehicle in good condition, be sure to maintain your vehicle properly.

Using the Maintenance Schedule

We want to help you keep your vehicle in good working condition. But we do not know exactly how you will drive it. You might drive very short distances only a few times a week. Or you might drive long distances all the time in very hot, dusty weather. You might use your vehicle in making deliveries. Or you might drive it to work, to do errands, or in many other ways.

Because of all the different ways people use their vehicles, maintenance needs vary. You might need more frequent checks and replacements. So please read the following and note how you drive. If you have any questions on how to keep your vehicle in good condition, see your dealer/retailer.

This schedule is for vehicles that:

- carry passengers and cargo within recommended limits. You will find these limits on the Tire and Loading Information label. See *Loading Your Vehicle* on page 4-22.
- are driven on reasonable road surfaces within legal driving limits.
- use the recommended fuel. See *Gasoline Octane* on page 5-5.

The services in *Scheduled Maintenance* on page 6-4 should be performed when indicated. See *Additional Required Services* on page 6-5 and *Maintenance Footnotes* on page 6-6 for further information.

 **CAUTION:**

Performing maintenance work on a vehicle can be dangerous. In trying to do some jobs, you can be seriously injured. Do your own maintenance work only if you have the required know-how and the proper tools and equipment for the job. If you have any doubt, see your dealer/retailer to have a qualified technician do the work. See *Doing Your Own Service Work* on page 5-4.

Some maintenance services can be complex. So, unless you are technically qualified and have the necessary equipment, you should have your dealer/retailer do these jobs.

When you go to your dealer/retailer for your service needs, you will know that trained and supported service technicians will perform the work using genuine parts.

If you want to purchase service information, see *Service Publications Ordering Information* on page 7-15.

Owner Checks and Services on page 6-8 tells you what should be checked, when to check it, and what you can easily do to help keep your vehicle in good condition.

The proper replacement parts, fluids, and lubricants to use are listed in *Recommended Fluids and Lubricants* on page 6-11 and *Maintenance Replacement Parts* on page 6-13. When your vehicle is serviced, make sure these are used. All parts should be replaced and all necessary repairs done before you or anyone else drives the vehicle. We recommend the use of genuine parts from your dealer/retailer.

Scheduled Maintenance

To maintain the ride, handling, and performance of your vehicle, it is important that the first tire rotation service be performed when the vehicle has 5,000 to 8,000 miles (8 000 to 13 000 km). Check tires for inflation pressures and wear. See *Tires on page 5-59*. Rotate tires. See *Tire Inspection and Rotation on page 5-75* and “Tire Wear Inspection” in *At Least Once a Month on page 6-8*.

When the Change Engine Oil Soon message in the Driver Information Center (DIC) comes on, it means that service is required for your vehicle. Have your vehicle serviced as soon as possible within the next 600 miles (1 000 km). It is possible that, if you are driving under the best conditions, the engine oil life system may not indicate that vehicle service is necessary for over a year. However, your engine oil and filter must be changed at least once a year and at this time the system must be reset. Your dealer/retailer has trained service technicians who will perform this work using genuine parts and reset the system.

If the engine oil life system is ever reset accidentally, you must service your vehicle within 3,000 miles (5 000 km) since your last service. Remember to reset the oil life system whenever the oil is changed. See *Engine Oil Life System on page 5-19* for information on the Engine Oil Life System and resetting the system.

When the Change Engine Oil Soon message appears, the following services, checks, and inspections are required:

- Change engine oil and filter. See *Engine Oil on page 5-16*. Reset oil life system. See *Engine Oil Life System on page 5-19*. An Emission Control Service.
- Visually check for any leaks or damage. See footnote (k).
- Inspect engine air cleaner filter. If necessary, replace filter. See *Engine Air Cleaner/Filter on page 5-21*. See footnote (l).
- Rotate tires and check inflation pressures and wear. See *Tire Inspection and Rotation on page 5-75* and “Tire Wear Inspection” in *At Least Once a Month on page 6-8*.
- Inspect brake system. See footnote (a).
- Check engine coolant and windshield washer fluid levels and add fluid as needed.
- Perform any needed additional services. See “Additional Required Services” in this section.
- Inspect suspension and steering components. See footnote (b).
- Inspect engine cooling system. See footnote (c).
- Inspect wiper blades. See footnote (d).
- Inspect restraint system components. See footnote (e).
- Lubricate body components. See footnote (f).

Additional Required Services

The following services should be performed at the first maintenance service after the indicated miles (kilometers) shown for each item.

Additional Required Services

Service and Miles (Kilometers)	25,000 (40 000)	50,000 (80 000)	75,000 (120 000)	100,000 (160 000)	125,000 (200 000)	150,000 (240 000)
Inspect fuel system for damage or leaks.	•	•	•	•	•	•
Inspect exhaust system for loose or damaged components.	•	•	•	•	•	•
Replace engine air cleaner filter. See <i>Engine Air Cleaner/Filter on page 5-21.</i>		•		•		•
Replace passenger compartment air filter. See <i>footnote (g).</i>	•	•	•	•	•	•
Change automatic transmission fluid and filter (severe service). See <i>footnote (h).</i>		•		•		•
Change automatic transmission fluid and filter (normal service).				•		
Replace spark plugs. An <i>Emission Control Service.</i>				•		

Additional Required Services (cont'd)

Service and Miles (Kilometers)	25,000 (40 000)	50,000 (80 000)	75,000 (120 000)	100,000 (160 000)	125,000 (200 000)	150,000 (240 000)
Engine cooling system service (or every five years, whichever occurs first). <i>An Emission Control Service.</i> <i>See footnote (i).</i>						•
Inspect engine accessory drive belt. <i>An Emission Control Service.</i> <i>See footnote (m).</i>						•
If using DOT-4 brake fluid, change brake fluid at a regular maintenance service every two years. <i>See footnote (j).</i>						

Maintenance Footnotes

(a) *Visually inspect brake lines and hoses for proper hook-up, binding, leaks, cracks, chafing, etc. Inspect disc brake pads for wear and rotors for surface condition. Inspect other brake parts, including calipers, parking brake, etc.*

(b) *Visually inspect front and rear suspension and steering system for damaged, loose, or missing parts or signs of wear. Inspect power steering lines and hoses for proper hook-up, binding, leaks, cracks, chafing, etc.*

(c) *Visually inspect hoses and have them replaced if they are cracked, swollen, or deteriorated. Inspect all pipes, fittings and clamps; replace with genuine parts as needed. To help ensure proper operation, a pressure test of the cooling system and pressure cap and cleaning the outside of the radiator and air conditioning condenser is recommended at least once a year.*

(d) *Inspect wiper blades for wear, cracking, or contamination. Clean the windshield and wiper blades, if contaminated. Replace wiper blades that are worn or damaged. See Windshield Wiper Blade Replacement on page 5-57 and Windshield and Wiper Blades on page 5-117 for more information.*

(e) *Make sure the safety belt reminder light and safety belt assemblies are working properly. Look for any other loose or damaged safety belt system parts. If you see anything that might keep a safety belt system from doing its job, have it repaired. Have any torn or frayed safety belts replaced. Also see Checking the Restraint Systems on page 1-70.*

(f) *Lubricate all key lock cylinders. Lubricate all body door hinges. Lubricate all hinges and latches, including those for the hood, rear compartment, console door, and any folding seat hardware. More frequent lubrication may be required when exposed to a corrosive environment. Applying silicone grease on weatherstrips with a clean cloth will make them last longer, seal better, and not stick or squeak.*

(g) *If you drive regularly under dusty conditions, the filter may require replacement more often.*

(h) *Change automatic transmission fluid and filter if the vehicle is mainly driven under one or more of these conditions:*

- In heavy city traffic where the outside temperature regularly reaches 90°F (32°C) or higher.*
- In hilly or mountainous terrain.*
- When doing frequent trailer towing.*
- Uses such as high performance operation.*

(i) *Drain, flush, and refill cooling system. This service can be complex; you should have your dealer/retailer perform this service. See Engine Coolant on page 5-27 for what to use. Inspect hoses. Clean radiator, condenser, pressure cap, and filler neck. Pressure test the cooling system and pressure cap.*

(j) *If using DOT-4 brake fluid only: Drain, flush, and refill brake hydraulic system at a regular maintenance service every two years. This service can be complex; you should have your dealer/retailer perform this service. See Brakes on page 5-40.*

(k) *A fluid loss in any vehicle system could indicate a problem. Have the system inspected and repaired and the fluid level checked. Add fluid if needed.*

(l) *If you drive regularly under dusty conditions, inspect the filter at each engine oil change.*

(m) *Visually inspect belt for fraying, excessive cracks, or obvious damage. Replace belt if necessary.*

Owner Checks and Services

These owner checks and services should be performed at the intervals specified to help ensure the safety, dependability, and emission control performance of your vehicle. Your dealer/retailer can assist you with these checks and services.

Be sure any necessary repairs are completed at once. Whenever any fluids or lubricants are added to your vehicle, make sure they are the proper ones, as shown in *Recommended Fluids and Lubricants* on page 6-11.

At Each Fuel Fill

It is important to perform these underhood checks at each fuel fill.

Engine Oil Level Check

Notice: It is important to check the engine oil regularly and keep it at the proper level. Failure to keep the engine oil at the proper level can cause damage to the engine not covered by your warranty.

Check the engine oil level and add the proper oil if necessary. See *Engine Oil* on page 5-16.

Engine Coolant Level Check

Check the engine coolant level and add DEX-COOL[®] coolant mixture if necessary. See *Engine Coolant* on page 5-27.

Windshield Washer Fluid Level Check

Check the windshield washer fluid level in the windshield washer fluid reservoir and add the proper fluid if necessary.

At Least Once a Month

Tire Inflation Check

Inspect your vehicle's tires and make sure they are inflated to the correct pressures. Do not forget to check the spare tire. See *Inflation - Tire Pressure* on page 5-67. Check to make sure the spare tire is stored securely. See *Changing a Flat Tire* on page 5-102.

Tire Wear Inspection

Tire rotation may be required for high mileage highway drivers prior to the Engine Oil Life System service notification. Check the tires for wear and, if necessary, rotate the tires. See *Tire Inspection and Rotation* on page 5-75.

At Least Once a Year Starter Switch Check

CAUTION:

When you are doing this inspection, the vehicle could move suddenly. If the vehicle moves, you or others could be injured.

1. Before you start, be sure you have enough room around the vehicle.
2. Firmly apply both the parking brake and the regular brake. See *Parking Brake on page 2-43*. Do not use the accelerator pedal, and be ready to turn off the engine immediately if it starts.
3. On automatic transmission vehicles, try to start the engine in each gear. The vehicle should start only in PARK (P) or NEUTRAL (N). If the vehicle starts in any other position, contact your dealer/retailer for service.

On manual transmission vehicles, put the shift lever in NEUTRAL, push the clutch pedal down halfway, and try to start the engine. The vehicle should start only when the clutch pedal is pushed down all the way to the floor. If the vehicle starts when the clutch pedal is not pushed all the way down, contact your dealer/retailer for service.

Automatic Transmission Shift Lock Control System Check

CAUTION:

When you are doing this inspection, the vehicle could move suddenly. If the vehicle moves, you or others could be injured.

1. Before you start, be sure you have enough room around the vehicle. It should be parked on a level surface.
2. Firmly apply the parking brake. See *Parking Brake on page 2-43*.
Be ready to apply the regular brake immediately if the vehicle begins to move.
3. With the engine off, turn the ignition to ON/RUN, but do not start the engine. Without applying the regular brake, try to move the shift lever out of PARK (P) with normal effort. If the shift lever moves out of PARK (P), contact your dealer/retailer for service.

Ignition Transmission Lock Check

While parked, and with the parking brake set, try to turn the ignition to LOCK/OFF in each shift lever position.

- With an automatic transmission, the ignition should turn to LOCK/OFF only when the shift lever is in PARK (P).
- With the key access ignition system, the ignition key should come out only in LOCK/OFF. With keyless access ignition, the ignition key does not come out. See *Ignition Positions (Key Access)* on page 2-31 or *Ignition Positions (Keyless Access)* on page 2-33.

Contact your dealer/retailer if service is required.

Parking Brake and Automatic Transmission Park (P) Mechanism Check

CAUTION:

When you are doing this check, your vehicle could begin to move. You or others could be injured and property could be damaged.

CAUTION: (Continued)

CAUTION: (Continued)

Make sure there is room in front of your vehicle in case it begins to roll. Be ready to apply the regular brake at once should the vehicle begin to move.

Park on a fairly steep hill, with the vehicle facing downhill. Keeping your foot on the regular brake, set the parking brake.

- To check the parking brake's holding ability: With the engine running and transmission in NEUTRAL (N), slowly remove foot pressure from the regular brake pedal. Do this until the vehicle is held by the parking brake only.
- To check the PARK (P) mechanism's holding ability: With the engine running, shift to PARK (P). Then release the parking brake followed by the regular brake.

Contact your dealer/retailer if service is required.

Underbody Flushing Service

At least every spring, use plain water to flush any corrosive materials from the underbody. Take care to clean thoroughly any areas where mud and other debris can collect.

Tire Sealant and Compressor Kit

Check the sealant expiration date printed on the instruction label of the Tire Sealant and Compressor Kit (if equipped) at least once a year. See your dealer/retailer for a replacement canister.

Recommended Fluids and Lubricants

Fluids and lubricants identified below by name, part number, or specification can be obtained from your dealer/retailer.

Usage	Fluid/Lubricant
Engine Oil	The engine requires a special engine oil meeting GM Standard GM4718M. Oils meeting this standard can be identified as synthetic, and should also be identified with the American Petroleum Institute (API) Certified for Gasoline Engines starburst symbol. However, not all synthetic API oils with the starburst symbol will meet this GM standard. Look for and use only an oil that meets GM Standard GM4718M. For the proper viscosity, see <i>Engine Oil on page 5-16</i> .

Usage	Fluid/Lubricant
Engine Coolant	50/50 mixture of clean, drinkable water and use only DEX-COOL [®] Coolant. See <i>Engine Coolant on page 5-27</i> .
Hydraulic Brake System	Delco [®] Supreme 11 Brake Fluid or equivalent DOT-3 brake fluid.
Windshield Washer	Optikleen [®] Washer Solvent.
Hydraulic Clutch System	Hydraulic Clutch Fluid. Use only GM Part No. U.S. 88958860, in Canada 88901244, Super DOT-4 brake fluid.
Parking Brake Cable Guides	Chassis Lubricant (GM Part No. U.S. 12377985, in Canada 88901242) or lubricant meeting requirements of NLGI #2, Category LB or GC-LB.
Power Steering System	GM Power Steering Fluid (GM Part No. U.S. 89021184, in Canada 89021186).
Manual Transmission	SAE 75W-90 GL5 Gear Oil (GM Part No. U.S. 88862475, in Canada 88862476).
Automatic Transmission	DEXRON [®] -VI Automatic Transmission Fluid.

Usage	Fluid/Lubricant
Transfer Case (All-Wheel Drive)	Transfer Case Fluid (GM Part No. U.S. 88861950, in Canada 88861951).
Key Lock Cylinders	Multi-Purpose Lubricant, Superlube (GM Part No. U.S. 12346241, in Canada 10953474).
Floor Shift Linkage	Lubriplate Lubricant Aerosol (GM Part No. U.S. 12346293, in Canada 992723) or lubricant meeting requirements of NLGI #2, Category LB or GC-LB.
Rear Axle	SAE 75W-90 Synthetic Axle Lubricant (GM Part No. U.S. 89021677, in Canada 89021678) meeting GM Specification 9986115.
Rear Axle (Limited-Slip Differential)	SAE 75W-90 Synthetic Axle Lubricant (GM Part No. U.S. 89021677, in Canada 89021678) meeting GM Specification 9986115. With a complete drain and refill add 4 ounces (118 ml) of Limited-Slip Axle Lubricant Additive (GM Part No. U.S. 1052358, in Canada 992694) where required. See <i>Rear Axle on page 5-50</i>

Usage	Fluid/Lubricant
Hood Latch Assembly, Secondary Latch, Pivots, Spring Anchor, and Release Pawl	Lubriplate Lubricant Aerosol (GM Part No. U.S. 12346293, in Canada 992723) or lubricant meeting requirements of NLGI #2, Category LB or GC-LB.
Hood and Door Hinges	Multi-Purpose Lubricant, Superlube (GM Part No. U.S. 12346241, in Canada 10953474).
Weatherstrip Conditioning	Weatherstrip Lubricant (GM Part No. U.S. 3634770, in Canada 10953518) or Dielectric Silicone Grease (GM Part No. U.S. 12345579, in Canada 992887).

Maintenance Replacement Parts

Replacement parts identified below by name, part number or specification can be obtained from your dealer/retailer.

Part	GM Part Numbers	ACDelco® Part Numbers
Engine Air Cleaner/Filter	15875795	—
Engine Oil Filter	25177917	PF2129
Passenger Compartment Air Filter Element	19130403	—
Spark Plugs	12597464	41-990
Wiper Blades (Hook Type)		
Driver's Side – 22 inches (56.5 cm)	12487636	—
Passenger's Side – 21 inches (53.3 cm)	12487638	—

Engine Drive Belt Routing

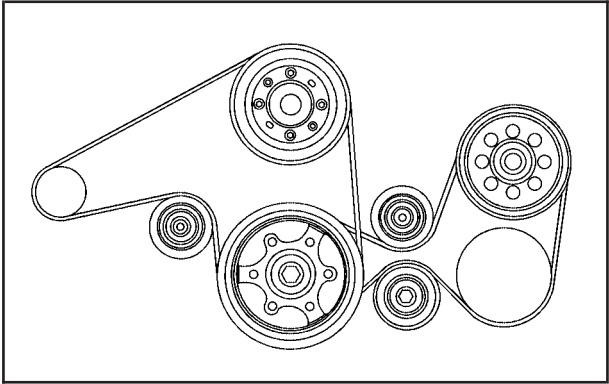

Maintenance Record

After the scheduled services are performed, record the date, odometer reading, who performed the service, and the type of services performed in the boxes provided. See *Maintenance Requirements on page 6-2*. Any additional information from *Owner Checks and Services on page 6-8* can be added on the following record pages. You should retain all maintenance receipts.

Maintenance Record

Date	Odometer Reading	Serviced By	Maintenance Stamp	Services Performed

Maintenance Record (cont'd)

Date	Odometer Reading	Serviced By	Maintenance Stamp	Services Performed

Maintenance Record (cont'd)

Date	Odometer Reading	Serviced By	Maintenance Stamp	Services Performed

Maintenance Record (cont'd)

Date	Odometer Reading	Serviced By	Maintenance Stamp	Services Performed

Section 7 Customer Assistance Information

Customer Assistance and Information	7-2	Reporting Safety Defects	7-14
Customer Satisfaction Procedure	7-2	Reporting Safety Defects to the United States	
Online Owner Center	7-4	Government	7-14
Customer Assistance for Text		Reporting Safety Defects to the Canadian	
Telephone (TTY) Users	7-5	Government	7-14
Customer Assistance Offices	7-5	Reporting Safety Defects to General Motors	7-15
GM Mobility Reimbursement Program	7-6	Service Publications Ordering Information	7-15
Roadside Service	7-6	Vehicle Data Recording and Privacy	7-16
Scheduling Service Appointments	7-9	Event Data Recorders	7-17
Courtesy Transportation	7-9	OnStar®	7-18
Collision Damage Repair	7-11	Navigation System	7-18
		Radio Frequency Identification (RFID)	7-18

Customer Assistance and Information

Customer Satisfaction Procedure

Your satisfaction and goodwill are important to your dealer and to Cadillac. Normally, any concerns with the sales transaction or the operation of your vehicle will be resolved by your dealer's sales or service departments. Sometimes, however, despite the best intentions of all concerned, misunderstandings can occur. If your concern has not been resolved to your satisfaction, the following steps should be taken:

STEP ONE: Discuss your concern with a member of dealership management. Normally, concerns can be quickly resolved at that level. If the matter has already been reviewed with the sales, service or parts manager, contact the owner of the dealership or the general manager.

STEP TWO: If after contacting a member of dealership management, it appears your concern cannot be resolved by the dealership without further help, in the United States, contact the Cadillac Customer Assistance Center, 24 hours a day, by calling 1-800-458-8006. In Canada, contact the Canadian Cadillac Customer Communication Centre by calling 1-888-446-2000.

We encourage you to call the toll-free number in order to give your inquiry prompt attention. Please have the following information available to give the Customer Assistance Representative:

- Vehicle Identification Number (VIN). This is available from the vehicle registration or title, or the plate at the top left of the instrument panel and visible through the windshield.
- Dealership name and location.
- Vehicle delivery date and present mileage.

When contacting Cadillac, please remember that your concern will likely be resolved at a dealer's facility. That is why we suggest you follow Step One first if you have a concern.

STEP THREE (United States Owners): Both General Motors and your dealer are committed to making sure you are completely satisfied with your new vehicle. However, if you continue to remain unsatisfied after following the procedure outlined in Steps One and Two, you should file with the Better Business Bureau (BBB) Auto Line Program to enforce your rights.

The BBB Auto Line Program is an out of court program administered by the Council of Better Business Bureaus to settle automotive disputes regarding vehicle repairs or the interpretation of the New Vehicle Limited Warranty. Although you may be required to resort to this informal dispute resolution program prior to filing a court action, use of the program is free of charge and your case will generally be heard within 40 days. If you do not agree with the decision given in your case, you may reject it and proceed with any other venue for relief available to you.

You may contact the BBB Auto Line Program using the toll-free telephone number or write them at the following address:

BBB Auto Line Program
Council of Better Business Bureaus, Inc.
4200 Wilson Boulevard
Suite 800
Arlington, VA 22203-1838
Telephone: 1-800-955-5100

This program is available in all 50 states and the District of Columbia. Eligibility is limited by vehicle age, mileage and other factors. General Motors reserves the right to change eligibility limitations and/or discontinue its participation in this program.

STEP THREE (Canadian Owners):

General Motors Participation in the Mediation/Arbitration Program

In the event that you do not feel your concerns have been addressed after the following the procedure outlined in Steps One and Two. General Motors of Canada Limited wants you to be aware of its participation in a no-charge mediation/Arbitration program. General Motors of Canada Limited has committed to binding arbitration of owner disputes involving factory-related vehicle service claims. The program provides for the review of the facts involved by an impartial third party arbiter, and may include an informal hearing before the arbiter. The program is designed so that the entire dispute settlement process, from the time you file your complaint to the final decision, should be completed in approximately 70 days. We believe our impartial program offers advantages over courts in most jurisdictions because it is informal, quick, and free of charge.

For further information concerning eligibility in the Canadian Motor Vehicle Arbitration Plan (CAMVAP), call toll-free 1-800-207-0685. Alternatively you may call the General Motors Customer Communication Centre, 1-800-263-3777 (English), 1-800-263-7854 (French), or you may write to the Mediation/Arbitration Program at the following address. Your inquiry should be accompanied by your Vehicle Identification Number (VIN).

Mediation/Arbitration Program
c/o Customer Communication Centre
General Motors of Canada Limited
Mail Code: CA1-163-005
1908 Colonel Sam Drive
Oshawa, Ontario L1H 8P7

Online Owner Center (United States only)

The Owner Center is a resource for your GM ownership needs. Specific vehicle information can be found in one place.

The Online Owner Center allows you to:

- Get e-mail service reminders.
- Access information about your specific vehicle, including tips and videos and an electronic version of this owner manual.

- Keep track of your vehicle's service history and maintenance schedule.
- Find GM dealers/retailers for service nationwide.
- Receive special promotions and privileges only available to members.

Refer to www.MyGMLink.com on the web for updated information and to register your vehicle.

My GM Canada (Canada only)

My GM Canada is a password-protected section of gmcanada.com where you can save information on GM vehicles, get personalized offers, and use handy tools and forms with greater ease.

Here are a few of the valuable tools and services you will have access to:

- My Showroom: Find and save information on vehicles and current offers in your area.
- My Dealers/Retailers: Save details such as address and phone number for each of your preferred GM Dealers or Retailers.
- My Driveway: Receive service reminders and helpful advice on owning and maintaining your vehicle.
- My Preferences: Manage your profile, subscribe to E-News and use tools and forms with greater ease.

To sign up to My GM Canada, visit the My GM Canada section within www.gmcanada.com.

Customer Assistance for Text Telephone (TTY) Users

To assist customers who are deaf, hard of hearing, or speech-impaired and who use Text Telephones (TTYs), Cadillac has TTY equipment available at its Customer Assistance Center. Any TTY user can communicate with Cadillac by dialing: 1-800-833-CMCC (2622). (TTY users in Canada can dial 1-800-263-3830.)

Customer Assistance Offices

Cadillac encourages customers to call the toll-free number for assistance. However, if a customer wishes to write or e-mail Cadillac, the letter should be addressed to:

United States — Customer Assistance

Cadillac Customer Assistance Center
Cadillac Motor Car Division
P.O. Box 33169
Detroit, MI 48232-5169

www.Cadillac.com
1-800-458-8006
1-800-833-2622 (For Text Telephone devices (TTYs))
Roadside Assistance: 1-800-882-1112
Fax Number: 313-381-0022

From Puerto Rico:
1-800-496-9992 (English)
1-800-496-9993 (Spanish)
Fax Number: 313-381-0022

From U.S. Virgin Islands:
1-800-496-9994
Fax Number: 313-381-0022

Canada — Customer Assistance

General Motors of Canada Limited
Canadian Cadillac Customer Communication Centre,
CA1-163-005
1908 Colonel Sam Drive
Oshawa, Ontario L1H 8P7

www.gmcanada.com
1-888-446-2000
1-800-263-3830 (For Text Telephone devices (TTYs))
Roadside Assistance: 1-800-882-1112

Overseas — Customer Assistance

Please contact the local General Motors Business Unit.

Mexico, Central America and Caribbean Islands/Countries (Except Puerto Rico and U.S. Virgin Islands) — Customer Assistance

General Motors de Mexico, S. de R.L. de C.V.
Customer Assistance Center
Paseo de la Reforma # 2740
Col. Lomas de Bezares
C.P. 11910, Mexico, D.F.
01-800-508-0000
Long Distance: 011-52-53 29 0 800

GM Mobility Reimbursement Program

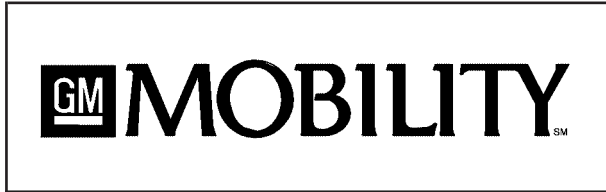

This program, available to qualified applicants, can reimburse you up to \$1,000 of the cost of eligible aftermarket adaptive equipment required for your vehicle, such as hand controls or a wheelchair/scooter lift.

The offer is available for a very limited period of time from the date of vehicle purchase/lease. For more details, or to determine your vehicle's eligibility, visit gmmobility.com or call the GM Mobility Assistance Center at 1-800-323-9935. Text telephone (TTY) users, call 1-800-833-9935.

General Motors of Canada also has a Mobility Program. Call 1-800-GM-DRIVE (463-7483) for details. TTY users call 1-800-263-3830.

Roadside Service

In the United States or Canada, call **1-800-882-1112**. Text Telephone (TTY), U.S. only, call 1-888-889-2438. Service is available 24 hours a day, 365 days a year.

As the owner of a new Cadillac vehicle, you are automatically enrolled in the Cadillac Roadside Service[®] program.

Who Is Covered?

Roadside Service coverage is for the vehicle operator, regardless of ownership. In Canada, a person driving this vehicle without the consent of the owner is not eligible for coverage.

Cadillac Owner Privileges™

The following services are provided in the U.S. and Canada up to 5 years/100,000 miles (160 000 km), whichever occurs first, and, in Canada only, up to a maximum coverage of \$100. These services are provided at a nominal charge if the vehicle is no longer within the Powertrain warranty.

Roadside Service provides several Cadillac Owner Privileges™ at “no charge,” throughout your *Cadillac Powertrain Warranty — 5 years/100,000 miles (160 000 km)*.

Emergency Road Service is performed on site for the following situations:

- **Fuel Delivery:** Delivery of enough fuel for the vehicle to get to the nearest service station (approximately \$5 in Canada). In Canada, for safety reasons, propane and other alternative fuels will not be provided through this service.
- **Lock-out Service:** Lock-out service will be covered at no charge if you are unable to gain entry into your vehicle. A remote unlock may be available if you have an active OnStar® subscription. To ensure security, the driver must present personal identification before lock-out service is provided. In Canada, the vehicle registration is also required.

- **Emergency Tow From a Public Roadway or Highway:** Tow to the nearest dealership for warranty service or in the event of a vehicle-disabling crash. Winch-out assistance is provided when the vehicle is mired in sand, mud, or snow.
- **Flat Tire Change:** Installation of a spare tire in good condition, when equipped and properly inflated, is covered at no charge. The customer is responsible for the repair or replacement of the tire if not covered by a warrantable failure.
- **Jump Start:** A battery jump start is covered at no charge if the vehicle does not start.
- **Trip Routing Service:** Upon request, Cadillac Roadside Service will send you detailed, computer personalized maps, highlighting your choice of either the most direct route or the most scenic route to your destination, anywhere in North America, along with helpful travel information pertaining to your trip.

Please allow three weeks before your planned departure date. In Canada, trip routing requests will be limited to six per calendar year.

- **Trip Interruption Benefits and Assistance:** If your trip is interrupted due to a warranty failure, incidental expenses may be reimbursed during the 60 months/100,000 miles (160 000 km) warranty period. Items covered are hotel, meals, and rental car.
- **Alternative Service (Canada only):** There may be times when Roadside Service cannot provide timely assistance. Your advisor may authorize you to secure local emergency road service, and you will be reimbursed up to \$100 upon submission of the original receipt to Cadillac Roadside Service®.

Cadillac and General Motors of Canada Limited reserve the right to limit services or reimbursement to an owner or driver when, in their sole discretion, the claims become excessive in frequency or type of occurrence.

Cadillac Technician Roadside Service (U.S. only)

Cadillac's exceptional Roadside Service is more than an auto club or towing service. It provides every Cadillac owner in the United States with the advantage of contacting a Cadillac advisor and, where available, a Cadillac trained dealer technician who can provide on-site service.

A dealer technician will travel to your location within a 30 mile radius of a participating Cadillac dealership. If beyond this radius, we will arrange to have your car towed to the nearest Cadillac dealership. Each technician travels with a specially equipped service vehicle complete with the necessary Cadillac parts and tools required to handle most roadside repairs.

Calling for Assistance

For prompt and efficient assistance when calling, please provide the following to the Roadside Service Representative:

- Your name, home address, and home telephone number
- Telephone number of your location
- Location of the vehicle
- Model, year, color, and license plate number of the vehicle
- Odometer reading, Vehicle Identification Number (VIN), and delivery date of the vehicle
- Description of the problem

Towing and Road Service Exclusions

Specifically excluded from Roadside Service coverage are towing or services for vehicles operated on a non-public roadway or highway, fines, impound towing caused by a violation of local, Municipal, State, Provincial or Federal law, and mounting, dismounting or changing of snow tires, chains, or other traction devices.

Roadside Service is not part of or included in the coverage provided by the New Vehicle Limited Warranty. Cadillac and General Motors of Canada Limited reserve the right to make any changes or discontinue the Roadside Service program at any time without notification.

Scheduling Service Appointments

When your vehicle requires warranty service, contact your dealer/retailer and request an appointment. By scheduling a service appointment and advising your service consultant of your transportation needs, your dealer/retailer can help minimize your inconvenience.

If your vehicle cannot be scheduled into the service department immediately, keep driving it until it can be scheduled for service, unless, of course, the problem is safety-related. If it is, please call your dealership/retailer, let them know this, and ask for instructions.

If the dealer/retailer requests that you simply drop the vehicle off for service, you are urged to do so as early in the work day as possible to allow for the same day repair.

Courtesy Transportation

To enhance your ownership experience, we and our participating dealers are proud to offer Courtesy Transportation, a customer support program for vehicles with the Bumper to Bumper (Base Warranty Coverage period in Canada) and extended powertrain warranty in both the U.S. and Canada.

Several courtesy transportation options are available to assist in reducing your inconvenience when warranty repairs are required.

Courtesy Transportation is not a part of the New Vehicle Limited Warranty. A separate booklet entitled "Warranty and Owner Assistance Information" furnished with each new vehicle provides detailed warranty coverage information.

Transportation Options

Warranty service can generally be completed while you wait. However, if you are unable to wait, GM helps to minimize your inconvenience by providing several transportation options. Depending on the circumstances, your dealer can offer you one of the following:

Shuttle Service

Participating dealers can provide shuttle service to get you to your destination with minimal interruption of your daily schedule. This includes one-way or round trip shuttle service to a destination up to 10 miles (16 km) from the dealership.

Public Transportation or Fuel Reimbursement

If your vehicle requires warranty repairs, and public transportation is used instead of the dealer's shuttle service, the expense must be supported by original receipts and can only be up to the maximum amount allowed by GM for shuttle service. In addition, for U.S. customers, should you arrange transportation through a friend or relative, limited reimbursement for reasonable fuel expenses may be available. Claim amounts should reflect actual costs and be supported by original receipts. See your dealer for information regarding the allowance amounts for reimbursement of fuel or other transportation costs.

Courtesy Rental Vehicle

Your dealer may arrange to provide you with a courtesy rental vehicle or reimburse you for a rental vehicle that you obtain if your vehicle is kept for a warranty repair. If you obtain a rental vehicle on your own, please see your dealer for the maximum number of days allowed and the allowance per rental day. Rental reimbursement must be supported by original receipts. This requires that you sign and complete a rental agreement and meet state, local, and rental vehicle provider requirements. Requirements vary and may include minimum age requirements, insurance coverage, credit card, etc. You are responsible for fuel usage charges and may also be responsible for taxes, levies, usage fees, excessive mileage, or rental usage beyond the completion of the repair.

It may not be possible to provide a like-vehicle as a courtesy rental.

Additional Program Information

All program options, such as shuttle service, may not be available at every dealer. Please contact your dealer for specific information about availability. All Courtesy Transportation arrangements will be administered by appropriate dealer personnel.

General Motors reserves the right to unilaterally modify, change, or discontinue Courtesy Transportation at any time and to resolve all questions of claim eligibility pursuant to the terms and conditions described herein at its sole discretion.

Collision Damage Repair

If your vehicle is involved in a collision and it is damaged, have the damage repaired by a qualified technician using the proper equipment and quality replacement parts. Poorly performed collision repairs will diminish your vehicle's resale value, and safety performance can be compromised in subsequent collisions.

Collision Parts

Genuine GM Collision parts are new parts made with the same materials and construction methods as the parts with which your vehicle was originally built. Genuine GM Collision parts are your best choice to ensure that your vehicle's designed appearance, durability and safety are preserved. The use of Genuine GM parts can help maintain your GM New Vehicle Warranty.

Recycled original equipment parts may also be used for repair. These parts are typically removed from vehicles that were total losses in prior crashes. In most cases, the parts being recycled are from undamaged sections of the vehicle. A recycled original equipment GM

part, may be an acceptable choice to maintain your vehicle's originally designed appearance and safety performance, however, the history of these parts is not known. Such parts are not covered by your GM New Vehicle Limited Warranty, and any related failures are not covered by that warranty.

Aftermarket collision parts are also available. These are made by companies other than GM and may not have been tested for your vehicle. As a result, these parts may fit poorly, exhibit premature durability/corrosion problems, and may not perform properly in subsequent collisions. Aftermarket parts are not covered by your GM New Vehicle Limited Warranty, and any vehicle failure related to such parts are not covered by that warranty.

Repair Facility

GM also recommends that you choose a collision repair facility that meets your needs before you ever need collision repairs. Your GM dealer/retailer may have a collision repair center with GM-trained technicians and state of the art equipment, or be able to recommend a collision repair center that has GM-trained technicians and comparable equipment.

Insuring Your Vehicle

Protect your investment in your GM vehicle with comprehensive and collision insurance coverage. There are significant differences in the quality of coverage afforded by various insurance policy terms. Many insurance policies provide reduced protection to your GM vehicle by limiting compensation for damage repairs by using aftermarket collision parts. Some insurance companies will not specify aftermarket collision parts. When purchasing insurance, we recommend that you assure your vehicle will be repaired with GM original equipment collision parts. If such insurance coverage is not available from your current insurance carrier, consider switching to another insurance carrier.

If your vehicle is leased, the leasing company may require you to have insurance that assures repairs with Genuine GM Original Equipment Manufacturer (OEM) parts or Genuine Manufacturer replacement parts. Read your lease carefully, as you may be charged at the end of your lease for poor quality repairs.

If a Crash Occurs

Here is what to do if you are involved in a crash.

- Try to relax and then check to make sure you are all right. If you are uninjured, make sure that no one else in your vehicle, or the other vehicle, is injured.
- If there has been an injury, call emergency services for help. Do not leave the scene of a crash until all matters have been taken care of. Move your vehicle only if its position puts you in danger or you are instructed to move it by a police officer.
- Give only the necessary and requested information to police and other parties involved in the crash. Do not discuss your personal condition, mental frame of mind, or anything unrelated to the crash. This will help guard against post-crash legal action.
- If you need roadside assistance, call GM Roadside Assistance. See *Roadside Service on page 7-6* for more information.
- If your vehicle cannot be driven, know where the towing service will be taking it. Get a card from the tow truck operator or write down the driver's name, the service's name, and the phone number.

- Remove any valuables from your vehicle before it is towed away. Make sure this includes your insurance information and registration if you keep these items in your vehicle.
- Gather the important information you will need from the other driver. Things like name, address, phone number, driver's license number, vehicle license plate, vehicle make, model and model year, Vehicle Identification Number (VIN), insurance company and policy number, and a general description of the damage to the other vehicle.
- If possible, call your insurance company from the scene of the crash. They will walk you through the information they will need. If they ask for a police report, phone or go to the police department headquarters the next day and you can get a copy of the report for a nominal fee. In some states/provinces with "no fault" insurance laws, a report may not be necessary. This is especially true if there are no injuries and both vehicles are driveable.
- Choose a reputable collision repair facility for your vehicle. Whether you select a GM dealer/retailer or a private collision repair facility to fix the damage, make sure you are comfortable with them. Remember, you will have to feel comfortable with their work for a long time.
- Once you have an estimate, read it carefully and make sure you understand what work will be performed on your vehicle. If you have a question, ask for an explanation. Reputable shops welcome this opportunity.

Managing the Vehicle Damage Repair Process

In the event that your vehicle requires damage repairs, GM recommends that you take an active role in its repair. If you have a pre-determined repair facility of choice, take your vehicle there, or have it towed there. Specify to the facility that any required replacement collision parts be original equipment parts, either new Genuine GM parts or recycled original GM parts. Remember, recycled parts will not be covered by your GM vehicle warranty.

Insurance pays the bill for the repair, but you must live with the repair. Depending on your policy limits, your insurance company may initially value the repair using aftermarket parts. Discuss this with your repair professional, and insist on Genuine GM parts. Remember if your vehicle is leased you may be obligated to have the vehicle repaired with Genuine GM parts, even if your insurance coverage does not pay the full cost.

If another party's insurance company is paying for the repairs, you are not obligated to accept a repair valuation based on that insurance company's collision policy repair limits, as you have no contractual limits with that company. In such cases, you can have control of the repair and parts choices as long as cost stays within reasonable limits.

Reporting Safety Defects

Reporting Safety Defects to the United States Government

If you believe that your vehicle has a defect which could cause a crash or could cause injury or death, you should immediately inform the National Highway Traffic Safety Administration (NHTSA) in addition to notifying General Motors.

If NHTSA receives similar complaints, it may open an investigation, and if it finds that a safety defect exists in a group of vehicles, it may order a recall and remedy campaign. However, NHTSA cannot become involved in individual problems between you, your dealer/retailer, or General Motors.

To contact NHTSA, you may call the Vehicle Safety Hotline toll-free at 1-888-327-4236 (TTY: 1-800-424-9153); go to <http://www.safercar.gov>; or write to:

Administrator, NHTSA
400 Seventh Street, SW.
Washington D.C., 20590

You can also obtain other information about motor vehicle safety from <http://www.safercar.gov>.

Reporting Safety Defects to the Canadian Government

If you live in Canada, and you believe that your vehicle has a safety defect, notify Transport Canada immediately, in addition to notifying General Motors of Canada Limited. Call them at 1-800-333-0510 or write to:

Transport Canada
Road Safety Branch
2780 Sheffield Road
Ottawa, Ontario K1B 3V9

Reporting Safety Defects to General Motors

In addition to notifying NHTSA (or Transport Canada) in a situation like this, please notify General Motors.

Call 1-800-458-8006, or write:

Cadillac Customer Assistance Center
Cadillac Motor Car Division
P.O. Box 33169
Detroit, MI 48232-5169

In Canada, call 1-888-446-2000, or write:

Canadian Cadillac Customer Communication Centre,
CA1-163-005
General Motors of Canada Limited
1908 Colonel Sam Drive
Oshawa, Ontario L1H 8P7

Service Publications Ordering Information

Service Manuals

Service Manuals have the diagnosis and repair information on engines, transmission, axle suspension, brakes, electrical, steering, body, etc.

Service Bulletins

Service Bulletins' give additional technical service information needed to knowledgeably service General Motors cars and trucks. Each bulletin contains instructions to assist in the diagnosis and service of your vehicle.

Owner Information

Owner publications are written specifically for owners and intended to provide basic operational information about the vehicle. The owner manual includes the Maintenance Schedule for all models.

In-Portfolio: Includes a Portfolio, Owner Manual, and Warranty Booklet.

RETAIL SELL PRICE: \$35.00 (U.S.) plus processing fee

Without Portfolio: Owner Manual only.

RETAIL SELL PRICE: \$25.00 (U.S.) plus processing fee

Current and Past Model Order Forms

Technical Service Bulletins and Manuals are available for current and past model GM vehicles. To request an order form, specify year and model name of the vehicle.

ORDER TOLL FREE: 1-800-551-4123
Monday-Friday 8:00 AM - 6:00 PM
Eastern Time

For Credit Card Orders Only
(VISA-MasterCard-Discover), visit Helm, Inc. on the World Wide Web at: www.helminc.com

Or you can write to:

Helm, Incorporated
P.O. Box 07130
Detroit, MI 48207

Prices are subject to change without notice and without incurring obligation. Allow ample time for delivery.

Note to Canadian Customers: All listed prices are quoted in U.S. funds. Canadian residents are to make checks payable in U.S. funds.

Vehicle Data Recording and Privacy

Your GM vehicle has a number of sophisticated computers that record information about the vehicle's performance and how it is driven. For example, your vehicle uses computer modules to monitor and control engine and transmission performance, to monitor the conditions for airbag deployment and deploy airbags in a crash and, if so equipped, to provide antilock braking to help the driver control the vehicle. These modules may store data to help your dealer/retailer technician service your vehicle. Some modules may also store data about how you operate the vehicle, such as rate of fuel consumption or average speed. These modules may also retain the owner's personal preferences, such as radio pre-sets, seat positions, and temperature settings.

Event Data Recorders

This vehicle has an Event Data Recorder (EDR). The main purpose of an EDR is to record, in certain crash or near crash-like situations, such as an airbag deployment or hitting a road obstacle, data that will assist in understanding how a vehicle's systems performed. The EDR is designed to record data related to vehicle dynamics and safety systems for a short period of time, typically 30 seconds or less. The EDR in this vehicle is designed to record such data as:

- How various systems in your vehicle were operating
- Whether or not the driver and passenger safety belts were buckled/fastened
- How far, if at all, the driver was pressing the accelerator and/or brake pedal
- How fast the vehicle was traveling

This data can help provide a better understanding of the circumstances in which crashes and injuries occur.

Important: EDR data is recorded by your vehicle only if a non-trivial crash situation occurs; no data is recorded by the EDR under normal driving conditions and no personal data (e.g., name, gender, age, and crash location) is recorded. However, other parties, such as law enforcement, could combine the EDR data with the type of personally identifying data routinely acquired during a crash investigation.

To read data recorded by an EDR, special equipment is required, and access to the vehicle or the EDR is needed. In addition to the vehicle manufacturer, other parties, such as law enforcement, that have the special equipment, can read the information if they have access to the vehicle or the EDR.

GM will not access this data or share it with others except: with the consent of the vehicle owner or, if the vehicle is leased, with the consent of the lessee; in response to an official request of police or similar government office; as part of GM's defense of litigation through the discovery process; or, as required by law. Data that GM collects or receives may also be used for GM research needs or may be made available to others for research purposes, where a need is shown and the data is not tied to a specific vehicle or vehicle owner.

OnStar®

If your vehicle has OnStar and you subscribe to the OnStar services, please refer to the OnStar Terms and Conditions for information on data collection and use. See also *OnStar® System on page 2-53* in this manual for more information.

Navigation System

If your vehicle has a navigation system, use of the system may result in the storage of destinations, addresses, telephone numbers, and other trip information. Refer to the navigation system operating manual for information on stored data and for deletion instructions.

Radio Frequency Identification (RFID)

RFID technology is used in some vehicles for functions such as tire pressure monitoring and ignition system security, as well as in connection with conveniences such as key fobs for remote door locking/unlocking and starting, and in-vehicle transmitters for garage door openers. RFID technology in GM vehicles does not use or record personal information or link with any other GM system containing personal information.

A

Accessories and Modifications	5-3	Antenna, XM™ Satellite Radio Antenna System	3-108
Adaptive Forward Lighting System	3-18	Antilock Brake System (ABS)	4-4
Adding Equipment to Your Airbag-Equipped Vehicle	1-69	Antilock Brake, System Warning Light	3-38
Additives, Fuel	5-6	Appearance Care	
Add-On Electrical Equipment	5-121	Aluminum or Chrome-Plated Wheels	5-117
Air Cleaner/Filter, Engine	5-21	Care of Safety Belts	5-114
Air Conditioning	3-23	Chemical Paint Spotting	5-119
Airbag		Cleaning Exterior Lamps/Lenses	5-116
Passenger Status Indicator	3-34	Fabric/Carpet	5-113
Readiness Light	3-33	Finish Care	5-116
Airbag System	1-55	Finish Damage	5-118
What Will You See After an Airbag Inflates?	1-62	Instrument Panel, Vinyl, and Other	
When Should an Airbag Inflate?	1-60	Plastic Surfaces	5-114
Where Are the Airbags?	1-58	Interior Cleaning	5-111
Airbag Systems		Leather	5-113
Adding Equipment to Your Airbag-Equipped Vehicle	1-69	Sheet Metal Damage	5-118
How Does an Airbag Restrain?	1-62	Speaker Covers	5-114
Passenger Sensing System	1-64	Tires	5-118
Servicing Your Airbag-Equipped Vehicle	1-68	Underbody Maintenance	5-119
What Makes an Airbag Inflate?	1-62	Vehicle Care/Appearance Materials	5-119
All-Wheel Drive	5-49	Washing Your Vehicle	5-115
All-Wheel-Drive (AWD) System	4-9	Weatherstrips	5-115
Analog Clock	3-22	Windshield and Wiper Blades	5-117
Antenna, Backglass	3-108	Wood Panels	5-114
		Appointments, Scheduling Service	7-9
		Ashtray	3-22

Audio System	3-79
Audio Steering Wheel Controls	3-106
Backglass Antenna	3-108
Navigation/Radio System, see Navigation	
Manual	3-106
Radio Reception	3-107
Theft-Deterrent Feature	3-106
XM™ Satellite Radio Antenna System	3-108
Audio System(s)	3-80
Automatic Transmission	
Fluid	5-25
Operation	2-37

B

Backglass Antenna	3-108
Battery	5-43
Electric Power Management	3-20
Exterior Lighting Battery Saver	3-19
Run-Down Protection	3-21
Brake	
Emergencies	4-5
Brakes	5-40
Panic Assist	4-9
System Warning Light	3-37
Braking	4-3
Braking in Emergencies	4-5
Break-In, New Vehicle	2-31

Bulb Replacement	5-55
Front Turn Signal and Fog Lamps	5-56
Halogen Bulbs	5-55
Headlamp Aiming	5-51
High Intensity Discharge (HID) Lighting	5-55
License Plate Lamps	5-56
Replacement Bulbs	5-57
Buying New Tires	5-77

C

Calibration	3-52
California Fuel	5-6
California Perchlorate Materials Requirements	5-4
California Proposition 65 Warning	5-4
Canadian Owners	iii
Capacities and Specifications	5-128
Carbon Monoxide	2-20, 2-47, 4-18, 4-29
Care of	
Safety Belts	5-114
CD, MP3	3-101
Center Console Storage Area	2-61
Chains, Tire	5-83
Charging System Light	3-36
Check	
Engine Light	3-40
Checking Things Under the Hood	5-12
Chemical Paint Spotting	5-119

Child Restraints		Climate Control System	
Child Restraint Systems	1-39	Air Filter, Passenger Compartment	3-28
Infants and Young Children	1-35	Dual	3-23
Lower Anchors and Tethers for Children	1-43	Outlet Adjustment	3-27
Older Children	1-32	Clock	3-22
Securing a Child Restraint in a Rear		Clutch, Hydraulic	5-26
Seat Position	1-49	Collision Damage Repair	7-11
Securing a Child Restraint in the		Compact Spare Tire	5-111
Right Front Seat Position	1-51	Compass	3-52
Where to Put the Restraint	1-42	Competitive Driving	4-14
Cigarette Lighter	3-22	Compressor Kit, Tire Sealant	5-85, 5-93
Cleaning		Control of a Vehicle	4-3
Aluminum or Chrome-Plated Wheels	5-117	Convenience Net	2-62
Exterior Lamps/Lenses	5-116	Coolant	
Fabric/Carpet	5-113	Engine Temperature Gage	3-39
Finish Care	5-116	Engine Temperature Warning Light	3-39
Instrument Panel, Vinyl, and Other		Heater, Engine	2-36
Plastic Surfaces	5-114	Surge Tank Pressure Cap	5-30
Interior	5-111	Cooling System	5-33
Leather	5-113	Cruise Control	3-13
Speaker Covers	5-114	Cruise Control Light	3-46
Tires	5-118	Cupholder(s)	2-61
Underbody Maintenance	5-119	Customer Assistance Information	
Washing Your Vehicle	5-115	Courtesy Transportation	7-9
Weatherstrips	5-115	Customer Assistance for Text	
Windshield and Wiper Blades	5-117	Telephone (TTY) Users	7-5
Wood Panels	5-114	Customer Assistance Offices	7-5

Customer Assistance Information (cont.)	
Customer Satisfaction Procedure	7-2
GM Mobility Reimbursement Program	7-6
Reporting Safety Defects to General Motors	7-15
Reporting Safety Defects to the Canadian Government	7-14
Reporting Safety Defects to the United States Government	7-14
Roadside Service	7-6
Service Publications Ordering Information	7-15

D

Daytime Running Lamps	3-17
Defensive Driving	4-2
Delayed Locking	2-18
DIC Compass	3-52
Diesel	
Running Out of Fuel	2-48
Disc, MP3	3-101
Doing Your Own Service Work	5-4
Door	
Central Door Unlocking System	2-17
Delayed Locking	2-18
Locks	2-17
Power Door Locks	2-18
Programmable Automatic Door Locks	2-18
Rear Door Security Locks	2-19

Driver Information Center (DIC)	3-47
DIC Operation and Displays	3-48
DIC Vehicle Customization	3-68
DIC Warnings and Messages	3-54
Driving	
At Night	4-14
Before a Long Trip	4-16
Defensive	4-2
Drunken	4-2
Highway Hypnosis	4-16
Hill and Mountain Roads	4-17
In Rain and on Wet Roads	4-15
Rocking Your Vehicle to Get it Out	4-22
Winter	4-18
Dual Climate Control System	3-23

E

EDR	7-16
Electrical System	
Add-On Equipment	5-121
Fuses and Circuit Breakers	5-122
Power Windows and Other Power Options	5-122
Rear Compartment Fuse Block	5-126
Underhood Fuse Block	5-122
Windshield Wiper Fuses	5-121

Engine	
Air Cleaner/Filter	5-21
Check and Service Engine Soon Light	3-40
Coolant	5-27
Coolant Heater	2-36
Coolant Temperature Gage	3-39
Coolant Temperature Warning Light	3-39
Drive Belt Routing	6-14
Engine Compartment Overview	5-14
Exhaust	2-47
Oil	5-16
Oil Life System	5-19
Oil Pressure Gage	3-44
Overheated Protection Operating Mode	5-32
Overheating	5-30
Speed Limiter	3-32
Starting	2-34
Entry Lighting	3-19
Event Data Recorders	7-17
Extender, Safety Belt	1-31
Exterior Lighting Battery Saver	3-19

F

Filter	
Engine Air Cleaner	5-21
Finish Damage	5-118
Flashers, Hazard Warning	3-6

Flash-to-Pass	3-9
Flat Tire	5-83
Flat Tire, Changing	5-102
Flat Tire, Storing	5-110
Fluid	5-25
Automatic Transmission	5-25
Power Steering	5-38
Windshield Washer	5-39
Fog Lamp	
Fog	3-18
Fog Lamp Light	3-45
Folding Rear Seat	1-11
Fuel	5-5
Additives	5-6
California Fuel	5-6
Filling a Portable Fuel Container	5-11
Filling the Tank	5-8
Fuels in Foreign Countries	5-7
Gage	3-46
Gasoline Octane	5-5
Gasoline Specifications	5-6
Running Out of	2-48
Fuses	
Fuses and Circuit Breakers	5-122
Rear Compartment Fuse Block	5-126
Underhood Fuse Block	5-122
Windshield Wiper	5-121

G

Gage	
Engine Coolant Temperature	3-39
Engine Oil Pressure	3-44
Fuel	3-46
Speedometer	3-31
Tachometer	3-31
Garage Door Opener	2-56
Gasoline	
Octane	5-5
Specifications	5-6
Glove Box	2-61
GM Mobility Reimbursement Program	7-6

H

Hazard Warning Flashers	3-6
Head Restraints	1-2
Headlamp	
Aiming	5-51
Headlamps	3-16
Adaptive Forward Lighting System	3-18
Bulb Replacement	5-55
Daytime Running Lamps	3-17
Flash-to-Pass	3-9
Front Turn Signal and Fog Lamps	5-56

Headlamps (cont.)	
Halogen Bulbs	5-55
High Intensity Discharge (HID) Lighting	5-55
High/Low Beam Changer	3-8
On Reminder	3-17
Washer	3-13
Wiper Activated	3-17
Heated Seats	1-6
Heater	3-23
Highbeam On Light	3-46
High-Speed Operation, Tires	5-69
Highway Hypnosis	4-16
Hill and Mountain Roads	4-17
Hood	
Checking Things Under	5-12
Release	5-13
Horn	3-6
How to Wear Safety Belts Properly	1-17
Hydraulic Clutch	5-26

I

Ignition Positions	2-31, 2-33
Immobilizer	2-28
Immobilizer Operation	2-28, 2-30
Infants and Young Children, Restraints	1-35
Inflation - Tire Pressure	5-67
Inflator Kit, Tire	5-85, 5-93

Instrument Panel	
Overview	3-4
Storage Area	2-61
Instrument Panel (I/P)	
Brightness	3-19
Cluster	3-30

J

Jump Starting	5-44
---------------------	------

K

Keyless Access System	2-6
Keyless Access System, Operation	2-9
Keyless Entry System	2-5
Keys	2-3

L

Labeling, Tire Sidewall	5-61
Lamps	
Exterior Lighting Battery Saver	3-19
Reading	3-20
Lap-Shoulder Belt	1-25
LATCH System	
Child Restraints	1-43
License Plate Lamps	5-56

Light	
Airbag Readiness	3-33
Antilock Brake System Warning	3-38
Brake System Warning	3-37
Charging System	3-36
Cruise Control	3-46
Engine Coolant Temperature Warning	3-39
Fog Lamp	3-45
Highbeam On	3-46
Lights On Reminder	3-46
Malfunction Indicator	3-40
Oil Pressure	3-43
Passenger Airbag Status Indicator	3-34
Safety Belt Reminders	3-32
Security	3-45
Tire Pressure	3-40
Traction Control System (TCS)/StabiliTrak®	3-38
Up-Shift	3-36
Lighting	
Entry	3-19
Parade Dimming	3-19
Lights	3-16
Flash-to-Pass	3-9
High/Low Beam Changer	3-8
On Reminder	3-17
Limited-Slip Rear Axle	4-8
Loading Your Vehicle	4-22
Lockout Protection	2-20

Locks	
Central Door Unlocking System	2-17
Delayed Locking	2-18
Door	2-17
Lockout Protection	2-20
Power Door	2-18
Programmable Automatic Door Locks	2-18
Rear Door Security Locks	2-19
Loss of Control	4-13
Lumbar	
Power Controls	1-5

M

Maintenance Schedule	
Additional Required Services	6-5
At Each Fuel Fill	6-8
At Least Once a Month	6-8
At Least Once a Year	6-9
Introduction	6-2
Maintenance Footnotes	6-6
Maintenance Record	6-15
Maintenance Replacement Parts	6-13
Maintenance Requirements	6-2
Owner Checks and Services	6-8
Recommended Fluids and Lubricants	6-11
Scheduled Maintenance	6-4
Using	6-2
Your Vehicle and the Environment	6-2
Malfunction Indicator Light	3-40

Manual Seats	1-4
Manual Transmission	
Fluid	5-25
Operation	2-41
Manual, Using	iii
Memory Seat and Mirrors	1-6
Message	
DIC Warnings and Messages	3-54
Mirrors	
Automatic Dimming Rearview with OnStar®	2-49
Outside Convex Mirror	2-50
Outside Heated Mirrors	2-50
Outside Power Mirrors	2-49
Park Tilt	2-50
MP3	3-101
MyGMLink.com	7-4

N

Navigation System, Privacy	7-18
Navigation/Radio System, see Navigation	
Manual	3-106
New Vehicle Break-In	2-31

O

Odometer	3-31
Odometers, Trip	3-31
Off-Road Recovery	4-12

Oil	
Engine	5-16
Engine Oil Pressure Gage	3-44
Pressure Light	3-43
Oil, Engine Oil Life System	5-19
Older Children, Restraints	1-32
Online Owner Center	7-4
OnStar, Privacy	7-18
OnStar® System, see OnStar® Manual	2-53
Operation, Universal Home Remote System	2-57
Outlet Adjustment	3-27
Outlets	
Accessory Power	3-21
Outside	
Convex Mirror	2-50
Heated Mirrors	2-50
Power Mirrors	2-49
Overheated Engine Protection Operating Mode	5-32
Owner Checks and Services	6-8
Owners, Canadian	iii

P

Paint, Damage	5-118
Panic Brake Assist	4-9
Parade Dimming	3-19
Park Aid	2-51
Park Brake	2-43

Park (P)	
Shifting Into	2-44
Shifting Out of	2-45
Park Tilt Mirrors	2-50
Parking	
Assist	2-51
Over Things That Burn	2-47
Parking Your Vehicle	2-46
Passenger Airbag Status Indicator	3-34
Passenger Compartment Air Filter	3-28
Passenger Sensing System	1-64
Passing	4-12
Perchlorate Materials Requirements, California	5-4
Power	
Door Locks	2-18
Electrical System	5-122
Lumbar Controls	1-5
Retained Accessory (RAP)	2-34
Seat	1-5
Steering Fluid	5-38
Tilt Wheel and Telescopic Steering Column	3-7
Windows	2-24
Privacy	7-16
Event Data Recorders	7-17
Navigation System	7-18
OnStar	7-18
Radio Frequency Identification	7-18
Programmable Automatic Door Locks	2-18

R

Radio Frequency Identification (RFID), Privacy	7-18
Radios	3-79
Radio(s)	3-80
Radios	
Navigation/Radio System, see Navigation	
Manual	3-106
Reception	3-107
Theft-Deterrent	3-106
Rainsense™ Wipers	3-10
Reading Lamps	3-20
Rear Axle	5-50
Limited-Slip	4-8
Rear Door Security Locks	2-19
Rearview Mirror, Automatic Dimming	
with OnStar®	2-49
Reclining Seatbacks	1-8
Recommended Fluids and Lubricants	6-11
Recreational Vehicle Towing	4-27
Remote, Keyless Access System	2-6
Remote Keyless Entry (RKE) System	2-5
Remote Keyless Entry (RKE) System,	
Operation	2-7
Remote Vehicle Start	2-14
Removing the Flat Tire and Installing	
the Spare Tire	5-105
Removing the Spare Tire and Tools	5-104
Replacement Bulbs	5-57
Replacement Parts, Maintenance	6-13

Reporting Safety Defects	
Canadian Government	7-14
General Motors	7-15
United States Government	7-14
Restraint System Check	
Checking the Restraint Systems	1-70
Replacing Restraint System Parts	
After a Crash	1-71
Retained Accessory Power (RAP)	2-34
Roadside	
Service	7-6
Rocking Your Vehicle to Get it Out	4-22
Routing, Engine Drive Belt	6-14
Running Out of Fuel	2-48

S

Safety Belt	
Reminder Light	3-32
Safety Belts	
Care of	5-114
How to Wear Safety Belts Properly	1-17
Lap-Shoulder Belt	1-25
Safety Belt Extender	1-31
Safety Belt Use During Pregnancy	1-30
Safety Belts Are for Everyone	1-12
Safety Warnings and Symbols	iv
Scheduled Maintenance	6-4

Seats		Spare Tire	
Heated and Ventilated Seats	1-6	Compact	5-111
Memory, Mirrors	1-6	Installing	5-105
Power Lumbar	1-5	Removing	5-104
Power Seats	1-5	Storing	5-110
Reclining Seatbacks	1-8	Specifications, Capacities	5-128
Split Folding Rear Seat	1-11	Speedometer	3-31
Securing a Child Restraint		Split Folding Rear Seat	1-11
Rear Seat Position	1-49	StabiliTrak [®] System	4-8
Right Front Seat Position	1-51	StabiliTrak [®] /TCS Warning Light	3-38
Security Light	3-45	Start Vehicle, Remote	2-14
Service	5-3	Starting the Engine	2-34
Accessories and Modifications	5-3	Steering	4-9
Adding Equipment to the Outside		Steering Wheel Controls, Audio	3-106
of Your Vehicle	5-5	Steering Wheel, Power Tilt Wheel and	
California Perchlorate Materials Requirements ...	5-4	Telescopic Steering Column	3-7
California Proposition 65 Warning	5-4	Steering Wheel, Tilt and Telescopic	3-6
Doing Your Own Work	5-4	Storage Areas	
Engine Soon Light	3-40	Center Console Storage Area	2-61
Publications Ordering Information	7-15	Convenience Net	2-62
Service, Scheduling Appointments	7-9	Cupholder(s)	2-61
Servicing Your Airbag-Equipped Vehicle	1-68	Glove Box	2-61
Sheet Metal Damage	5-118	Instrument Panel Storage Area	2-61
Shifting Into Park (P)	2-44	Stuck in Sand, Mud, Ice, or Snow	4-21
Shifting Out of Park (P)	2-45	Sun Visors	2-26
Signals, Turn and Lane-Change	3-8	Sunroof	2-62

T

Tachometer	3-31
Telescopic Steering Column, Power Tilt Wheel	3-7
Telescopic Wheel	3-6
Theft-Deterrent, Radio	3-106
Theft-Deterrent System	2-27
Theft-Deterrent Systems	2-27
Immobilizer	2-28
Immobilizer Operation	2-28, 2-30
Tilt Wheel	3-6
Tire	
Pressure Light	3-40
Tires	5-59
Aluminum or Chrome-Plated Wheels, Cleaning	5-117
Buying New Tires	5-77
Chains	5-83
Changing a Flat Tire	5-102
Cleaning	5-118
Compact Spare Tire	5-111
Different Size	5-79
High-Speed Operation	5-69
If a Tire Goes Flat	5-83
Inflation - Tire Pressure	5-67
Inspection and Rotation	5-75
Installing the Spare Tire	5-105
Pressure Monitor Operation	5-71

Tires (cont.)	
Pressure Monitor System	5-70
Removing the Flat Tire	5-105
Removing the Spare Tire and Tools	5-104
Storing a Flat or Spare Tire and Tools	5-110
Tire Sealant and Compressor Kit	5-85, 5-93
Tire Sidewall Labeling	5-61
Tire Terminology and Definitions	5-64
Uniform Tire Quality Grading	5-80
Wheel Alignment and Tire Balance	5-81
Wheel Replacement	5-81
When It Is Time for New Tires	5-76
Winter Tires	5-60
Towing	
Recreational Vehicle	4-27
Towing a Trailer	4-29
Your Vehicle	4-27
Traction	
Control System (TCS)	4-6
Control System (TCS)/StabiliTrak [®] Warning Light	3-38
Limited-Slip Rear Axle	4-8
StabiliTrak [®] System	4-8
Transmission	
Fluid, Automatic	5-25
Fluid, Manual	5-25
Up-Shift Light	3-36
Transmission Operation, Automatic	2-37

Transmission Operation, Manual	2-41
Trip Odometers	3-31
Trunk	2-20
Turn and Lane-Change Signals	3-8
Turn Signal/Multifunction Lever	3-7

U

Ultrasonic Rear Parking Assist (URPA)	2-51
Uniform Tire Quality Grading	5-80
Universal Home Remote System	2-56
Operation	2-57
Up-Shift Light	3-36
Using this Manual	iii

V

Vehicle	
Control	4-3
Damage Warnings	iv
Loading	4-22
Parking Your	2-46
Symbols	iv
Vehicle Customization, DIC	3-68
Vehicle Data Recording and Privacy	7-16

Vehicle Identification	
Number (VIN)	5-120
Service Parts Identification Label	5-121
Vehicle, Remote Start	2-14
Ventilated Seats	1-6
Ventilation Adjustment	3-27
Visors	2-26

W

Warning Lights, Gages and Indicators	3-29
Warnings	
DIC Warnings and Messages	3-54
Hazard Warning Flashers	3-6
Safety and Symbols	iv
Vehicle Damage	iv
Washer, Headlamps	3-13
Wheels	
Alignment and Tire Balance	5-81
Different Size	5-79
Replacement	5-81
Where to Put the Restraint	1-42
Windows	
Power	2-24

Windshield	
Rainsense™ Wipers	3-10
Washer	3-11
Washer Fluid	5-39
Wiper Blade Replacement	5-57
Wiper Blades, Cleaning	5-117
Wiper Fuses	5-121
Wipers	3-9
Winter Driving	4-18
Winter Tires	5-60
Wiper Activated Headlamps	3-17

X

XM Radio Messages	3-105
XM™ Satellite Radio Antenna System	3-108

Y

Your Vehicle and the Environment	6-2
--	-----