

2014 Cadillac CTS/CTS-V Owner Manual

In Brief	1-1	Storage	4-1	Climate Controls	8-1
Instrument Panel	1-2	Storage Compartments	4-1	Climate Control Systems	8-1
Initial Drive Information	1-4	Additional Storage Features	4-2	Air Vents	8-6
Vehicle Features	1-15	Roof Rack System	4-6	Maintenance	8-6
Performance and Maintenance	1-21	Instruments and Controls	5-1	Driving and Operating	9-1
Keys, Doors, and Windows	2-1	Controls	5-2	Driving Information	9-2
Keys and Locks	2-2	Warning Lights, Gauges, and Indicators	5-10	Starting and Operating	9-15
Doors	2-17	Information Displays	5-27	Engine Exhaust	9-25
Vehicle Security	2-23	Vehicle Messages	5-31	Automatic Transmission	9-26
Exterior Mirrors	2-26	Vehicle Personalization	5-46	Manual Transmission	9-31
Interior Mirrors	2-27	Universal Remote System	5-54	Drive Systems	9-33
Windows	2-28	Lighting	6-1	Brakes	9-33
Roof	2-30	Exterior Lighting	6-1	Ride Control Systems	9-38
Seats and Restraints	3-1	Interior Lighting	6-6	Cruise Control	9-41
Head Restraints	3-2	Lighting Features	6-7	Driver Assistance Systems	9-43
Front Seats	3-3	Infotainment System	7-1	Fuel	9-49
Rear Seats	3-11	Introduction	7-1	Trailer Towing	9-53
Safety Belts	3-12	Radio	7-8	Conversions and Add-Ons	9-59
Airbag System	3-20	Audio Players	7-16		
Child Restraints	3-33	Phone	7-35		
		Trademarks and License Agreements	7-43		

2014 Cadillac CTS/CTS-V Owner Manual

Vehicle Care	10-1	Technical Data	12-1
General Information	10-3	Vehicle Identification	12-1
Vehicle Checks	10-4	Vehicle Data	12-2
Headlamp Aiming	10-34	Customer Information	13-1
Bulb Replacement	10-35	Customer Information	13-1
Electrical System	10-37	Reporting Safety Defects	13-12
Wheels and Tires	10-61	Vehicle Data Recording and	
Jump Starting	10-105	Privacy	13-14
Towing the Vehicle	10-109	OnStar	14-1
Appearance Care	10-112	OnStar Overview	14-1
Service and Maintenance ...	11-1	OnStar Services	14-2
General Information	11-1	OnStar Additional	
Cadillac Premium Care		Information	14-5
Maintenance	11-3	Index	i-1
Maintenance Schedule	11-4		
Special Application			
Services	11-10		
Additional Maintenance			
and Care	11-10		
Recommended Fluids,			
Lubricants, and Parts	11-13		
Maintenance Records	11-17		



The names, logos, emblems, slogans, vehicle model names, and vehicle body designs appearing in this manual including, but not limited to, GM, the GM logo, CADILLAC, the CADILLAC Crest and Wreath, CTS, and CTS-V are trademarks and/or service marks of General Motors LLC, its subsidiaries, affiliates, or licensors.

This manual describes features that may or may not be on your specific vehicle either because they are options that you did not purchase or due to changes subsequent to the printing of this owner manual. Please refer to the purchase documentation relating to your specific vehicle to confirm each of the features found on your vehicle. For vehicles first sold in Canada, substitute the name "General Motors of Canada Limited" for Cadillac Motor Car Division wherever it appears in this manual.

Keep this manual in the vehicle for quick reference.

Canadian Vehicle Owners

Propriétaires Canadiens

A French language manual can be obtained from your dealer, at www.helminc.com, or from:

On peut obtenir un exemplaire de ce guide en français auprès du concessionnaire ou à l'adresse suivante:

Helm, Incorporated
Attention: Customer Service
47911 Halyard Drive
Plymouth, MI 48170

Using this Manual

To quickly locate information about the vehicle, use the Index in the back of the manual. It is an alphabetical list of what is in the manual and the page number where it can be found.

Danger, Warnings, and Cautions

Danger

Text marked  **Danger** provides information on risk of fatal injury. Disregarding this information may endanger life.

Warning

Text marked  **Warning** provides information on risk of accident or injury. Disregarding this information may lead to injury.

Caution

Text marked  **Caution** provides information that may indicate a hazard that could result in injury or death. It could also result in possible damage to the vehicle.



A circle with a slash through it is a safety symbol which means “Do Not,” “Do not do this,” or “Do not let this happen.”

Symbols

The vehicle has components and labels that use symbols instead of text. Symbols are shown along with the text describing the operation or information relating to a specific component, control, message, gauge, or indicator.

: This symbol is shown when you need to see your owner manual for additional instructions or information.

 : This symbol is shown when you need to see a service manual for additional instructions or information.

Vehicle Symbol Chart

Here are some additional symbols that may be found on the vehicle and what they mean. For more information on the symbol, refer to the Index.

 : Airbag Readiness Light

 : Air Conditioning

 : Antilock Brake System (ABS)

 : Audio Steering Wheel Controls or OnStar®

 : Brake System Warning Light

 : Charging System

 : Cruise Control

 : Engine Coolant Temperature

 : Exterior Lamps

 : Fog Lamps

 : Fuel Gauge

 : Fuses

 : Headlamp High/Low-Beam Changer

 : Heated Steering Wheel

 : LATCH System Child Restraints

 : Malfunction Indicator Lamp

 : Oil Pressure

 : Power

 : Remote Vehicle Start

 : Safety Belt Reminders

 : Tire Pressure Monitor

 : Traction Control/StabiliTrak®

 : Windshield Washer Fluid

In Brief

Instrument Panel

Instrument Panel 1-2

Initial Drive Information

Initial Drive Information 1-4

Starting the Engine 1-4

Remote Keyless Entry (RKE)
System 1-4

Remote Vehicle Start 1-5

Door Locks 1-5

Liftgate 1-6

Trunk Release 1-7

Windows 1-8

Seat Adjustment 1-8

Memory Features 1-9

Heated and Ventilated
Seats 1-10

Head Restraint

Adjustment 1-10

Safety Belts 1-10

Passenger Sensing
System 1-11

Steering Wheel
Adjustment 1-11

Interior Lighting 1-12

Exterior Lighting 1-12

Windshield Wiper/Washer 1-13

Climate Controls 1-14

Transmission 1-14

Vehicle Features

Radio(s) 1-15

Satellite Radio 1-15

Portable Audio Devices 1-16

Bluetooth® 1-16

Steering Wheel Controls 1-16

Cruise Control 1-17

Navigation System 1-17

Driver Information
Center (DIC) 1-18

Rear Vision
Camera (RVC) 1-19

Ultrasonic Parking Assist 1-19

Power Outlets 1-19

Universal Remote System ... 1-19

Sunroof 1-20

Performance and Maintenance

Traction Control/Electronic
Stability Control 1-21

Tire Pressure Monitor 1-21

Engine Oil Life System 1-22

Driving for Better Fuel
Economy 1-23

Roadside Service 1-23

OnStar® 1-23

Instrument Panel

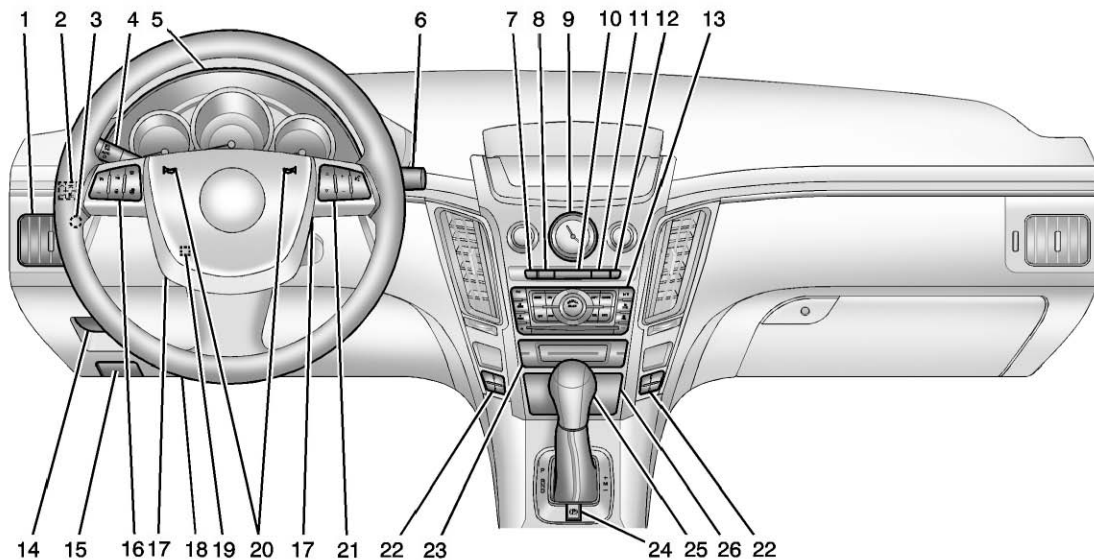

CTS Shown, CTS-V Similar

1. *Air Vents on page 8-6.*
2. *Driver Information Center (DIC) on page 5-27.*
3. *Instrument Panel Illumination Control on page 6-6.*
4. *Turn Signal Lever. See Turn and Lane-Change Signals on page 6-5.*
5. *Instrument Cluster on page 5-11.*
6. *Windshield Wiper/Washer on page 5-4.*
Rear Window Wiper/Washer on page 5-6 (If Equipped).
7. *Navigation Button (If Equipped). See Infotainment on page 7-1.*
8. *Traction Control/Electronic Stability Control on page 9-38.*
Magnetic Ride Control on page 9-40 (CTS-V Model Only).
9. *Clock on page 5-9.*
10. *Passenger Sensing System on page 3-26.*
11. *Hazard Warning Flashers on page 6-4.*
12. *Navigation Display Brightness Control (If Equipped). See Infotainment on page 7-1.*
13. *Infotainment on page 7-1.*
14. *Parking Brake Release Lever. See Parking Brake (Manual) on page 9-34 or Parking Brake (Electric) on page 9-35.*
15. *Hood Release. See Hood on page 10-5.*
16. *Cruise Control on page 9-41.*
Heated Steering Wheel on page 5-4 (If Equipped).
Traction Control System (TCS) Disable Button (CTS-V Model Only). See Traction Control/Electronic Stability Control on page 9-38.
17. *Tap Shift Controls (If Equipped). Located on the rear of the steering wheel. See Manual Mode on page 9-28.*
18. *Data Link Connector (DLC) (Out of View). See Malfunction Indicator Lamp on page 5-19.*
19. *Steering Wheel Adjustment on page 5-2.*
20. *Horn on page 5-4.*
21. *Steering Wheel Controls on page 5-3.*
22. *Heated and Ventilated Front Seats on page 3-9.*
23. *Dual Automatic Climate Control System on page 8-1.*
24. *Parking Brake Button. See Parking Brake (Manual) on page 9-34 or Parking Brake (Electric) on page 9-35.*
25. *Shift Lever. See Automatic Transmission on page 9-26 or Manual Transmission on page 9-31.*
26. *Instrument Panel Storage on page 4-1.*
Power Outlets on page 5-9.

Initial Drive Information

This section provides a brief overview about some of the important features that may or may not be on your specific vehicle.

For more detailed information, refer to each of the features which can be found later in this owner manual.

Starting the Engine

When first starting the vehicle, the engine idle speed will be elevated to allow the catalytic converter, an emissions control device, to quickly reach operating temperature. After approximately 20 seconds, the engine will begin to transition to its normal, quieter idle speed, which can vary depending on the temperature. This is normal operation.

Remote Keyless Entry (RKE) System

On some models, the RKE transmitter is used to lock and unlock the doors from up to 20 m (65 ft) away from the vehicle. On other models, it can be used up to 60 m (195 ft) away.

Sedan and Coupe Shown

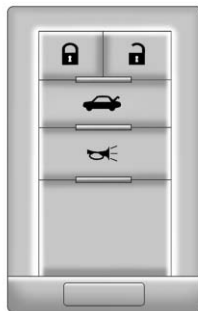

Key Access



Keyless Access

Press to unlock the driver door. Press again within five seconds to unlock all remaining doors.

Press to lock all doors.

Lock and unlock feedback can be personalized. See *Vehicle Personalization* on page 5-46.

Press and hold for about one second / to unlock the trunk/liftgate.

Press and release to locate the vehicle.

Press and hold  for three seconds to sound the panic alarm.

Press  again to cancel the panic alarm.

For Keyless Access vehicles, press the button to remove the key. The key can be used for all locks.

See *Keys* on page 2-2 and *Remote Keyless Entry (RKE) System Operation (Keyless Access)* on page 2-4 or *Remote Keyless Entry (RKE) System Operation (Key Access)* on page 2-9.

Remote Vehicle Start

If equipped with this feature, the engine can be started from outside of the vehicle.

Starting the Vehicle

1. Aim the transmitter at the vehicle and press and release  on the transmitter.

2. Immediately after completing Step 1, press and hold  for at least four seconds or until the turn signal lamps flash.
3. After entering the vehicle during a remote start, press the brake pedal and turn the ignition to ON/RUN to drive the vehicle.

When the vehicle starts, the parking lamps will turn on and remain on as long as the engine is running. The doors will be locked and the climate control system may come on.

The engine will continue to run for 10 minutes. Repeat the steps for a 10-minute time extension. Remote start can be extended only once.

Canceling a Remote Start

To cancel a remote start do any of the following:

- Aim the RKE transmitter at the vehicle and press and hold  until the parking lamps turn off.

- Turn on the hazard warning flashers.
- Turn the vehicle on and then off.



See *Remote Vehicle Start* on page 2-11.

Door Locks

To lock or unlock a door manually use the door lock knob on top of the doors.

Wagon/Sedan Model

From inside, pull a front door handle to unlock. Pulling the door handle again unlatches the door. For a rear door use the door lock knob on the top of the door.

From the outside, turn the key toward the front or rear of the vehicle, or press  or  on the Remote Keyless Entry (RKE) transmitter.



1-6 In Brief

See *Remote Keyless Entry (RKE) System Operation (Keyless Access)* on page 2-4 or *Remote Keyless Entry (RKE) System Operation (Key Access)* on page 2-9.

Coupe Model

To open a door from the inside, press the door latch button, or pull the manual door release handle on the driver side floor.

See *Door Locks* on page 2-13.

From the outside, use the key to unlock the trunk then pull the manual door release handle, or press  or  on the RKE transmitter.

See *Door Locks* on page 2-13 and *Remote Keyless Entry (RKE) System Operation (Keyless Access)* on page 2-4 or *Remote Keyless Entry (RKE) System Operation (Key Access)* on page 2-9.

Power Door Locks

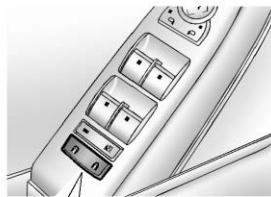

Sedan/Wagon Shown, Coupe Similar

 : Press to lock the doors.

 : Press to unlock the doors.

See *Power Door Locks* on page 2-15.

Liftgate

Power Liftgate

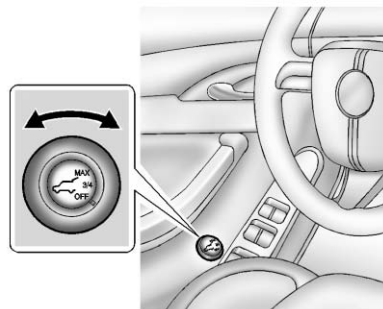

Vehicles with an automatic transmission must be in P (Park) and a manual transmission must be in Neutral to operate the power liftgate.

To open the liftgate from inside, select the mode then press the center of the button. See *Liftgate* on page 2-19 for more information on programming the height opening settings.

To open the liftgate with the Remote Keyless Entry (RKE) transmitter, press and hold  on the RKE transmitter.

To open the liftgate from outside the vehicle, press the touch pad on the outside liftgate handle.

Manual Operation of the Power Liftgate

With the vehicle in P (Park) for an automatic transmission or Neutral for a manual transmission, turn the liftgate mode switch to OFF and unlock the doors. Press the touch pad under the liftgate handle and pull up on the handle. To close the liftgate, pull down on the pull cup. See *Liftgate* on page 2-19.

Trunk Release

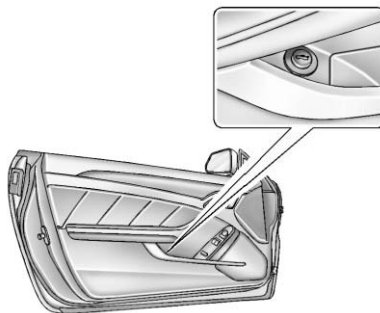

To open the trunk:

- Press the trunk release button on the driver door. The shift lever must be in P (Park) or N (Neutral) for automatic transmissions. For manual transmissions the shift lever must be in Neutral and the parking brake set.

- Press  on the Remote Keyless Entry (RKE) transmitter.
- Use the key in the trunk lock cylinder.

If equipped with the Keyless Access system, the RKE transmitter must be within 1 m (3 ft) of the trunk for it to be recognized. The trunk can then be opened by the trunk release button above the license plate. See Remote Keyless Entry (RKE) Operation (Keyless Access) See *Trunk* on page 2-17.

Windows

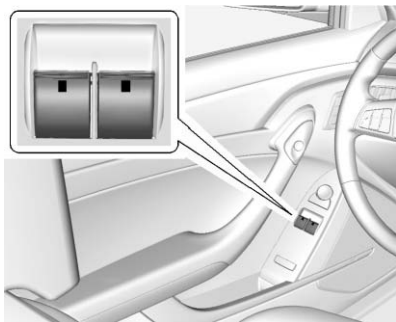

Coupe Shown, Sedan/Wagon Similar

The driver power window switches control all the windows. The passenger switch only controls that window.

Press the switch down to lower the window. Pull the switch up to raise it. See *Power Windows* on page 2-28.

Seat Adjustment

Power Seats

Seat Position

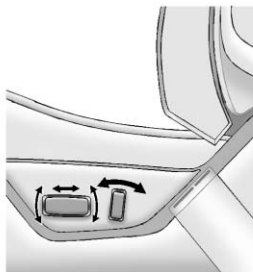

To adjust the seat:

- Move the seat forward or rearward by moving the horizontal control forward or rearward.
- Raise or lower the front or rear part of the seat cushion by moving the front or rear of the horizontal control up or down.

- Raise or lower the entire seat by moving the entire horizontal control up or down.

See *Power Seat Adjustment* on page 3-4.

Use the vertical control to adjust the seatback. See *Reclining Seatbacks* on page 3-6.

Power Lumbar

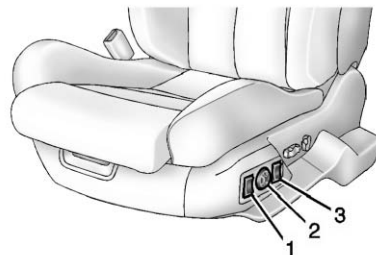

1. Seat Cushion Bolster Adjustment
2. Lumbar Support Control
3. Seatback Bolster Control

To adjust the lumbar support, if equipped:

- Press and hold the top of the control (2) to increase support to the top of the seatback and decrease support to the bottom of the seatback.
- Press and hold the bottom of the control (2) to decrease support to the top of the seatback and increase support to the bottom of the seatback.
- Press and hold the front or rear of the control (2) to increase or decrease support to the entire seatback.

See *Lumbar Adjustment* on page 3-5.

Seat Cushion and Seatback Bolsters

To adjust the seat cushion and seatback bolster support, if equipped:

- Press the top or bottom of the control (1) to increase or decrease support in the seat cushion bolsters.
- Press the top or bottom of the control (3) to increase or decrease support in the seatback bolsters.

See *Lumbar Adjustment* on page 3-5.

Memory Features

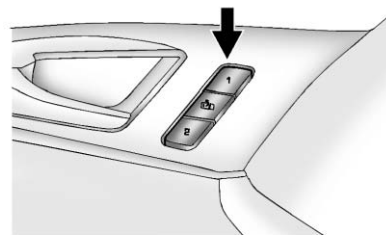

If available, memory buttons 1 and 2 on the driver door are used to save and recall memory settings for the driver seat cushion and seatback, outside mirrors, and the power tilt steering column position (if equipped).

See *Memory Seats* on page 3-7 and *Vehicle Personalization* on page 5-46.

Heated and Ventilated Seats

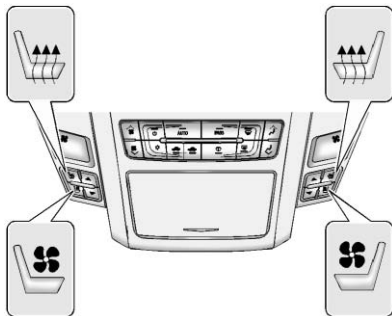

Heated and Ventilated Seat Buttons Shown, Heated Seat Buttons Similar

If available, the buttons are on the climate control panel. To operate, the ignition must be on.

 : Press to heat the seat.

 : If available, press to ventilate the seat. A ventilated seat has a fan that pulls or pushes air through the seat. The air is not cooled.

Press the button once for the highest setting. With each press of the button, the seat will change to the next lower setting, and then to the off setting. The lights on the climate control display indicate three for the highest setting and one for the lowest.

See *Heated and Ventilated Front Seats* on page 3-9.

Head Restraint Adjustment

Do not drive until the head restraints for all occupants are installed and adjusted properly.

To achieve a comfortable seating position, change the seatback recline angle as little as necessary while keeping the seat and the head restraint height in the proper position.

See *Head Restraints* on page 3-2 and *Seat Adjustment* on page 3-3.

Safety Belts

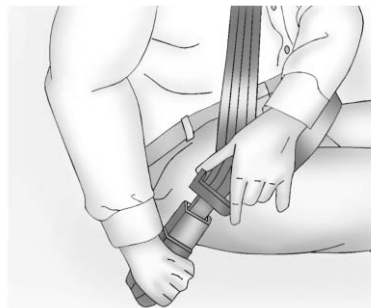

Refer to the following sections for important information on how to use safety belts properly:

- *Safety Belts* on page 3-12.
- *How to Wear Safety Belts Properly* on page 3-13.
- *Lap-Shoulder Belt* on page 3-14.
- *Lower Anchors and Tethers for Children (LATCH System)* on page 3-41.

Passenger Sensing System



United States



Canada and Mexico

The passenger sensing system turns off the front outboard passenger frontal airbag under certain conditions. No other airbag is affected by the passenger sensing system. See *Passenger Sensing System* on page 3-26.

The passenger airbag status indicator will be visible on the instrument panel when the vehicle is started. See *Passenger Airbag Status Indicator* on page 5-18.

Steering Wheel Adjustment

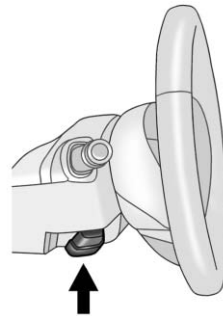

To adjust the steering wheel:

1. Pull the lever down.
2. Move the steering wheel up or down.

3. Pull or push the steering wheel closer or away from you.
4. Pull the lever up to lock the steering wheel in place.

Power Tilt Wheel

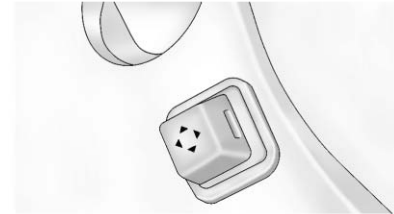

If equipped with the power tilt and telescoping wheel, the control is on the left side of the steering column.

- Push the control up or down to tilt the steering wheel up or down.
- Push the control forward or rearward to move the steering wheel toward the front or rear of the vehicle.

Do not adjust the steering wheel while driving.

Interior Lighting

Reading Lamps

The reading lamps are on the overhead console. These lamps come on automatically when any door is opened.

For manual operation, press the button next to each lamp to turn it on or off.

If the reading lamps are left on, they automatically shut off 10 minutes after the ignition has been turned off.

For more information, see:

- *Reading Lamps on page 6-6.*
- *Instrument Panel Illumination Control on page 6-6.*

Exterior Lighting

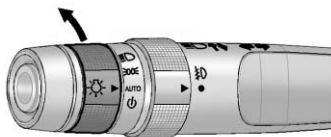

The exterior lamp control is toward the end of the turn signal lever.

 : Turn the band with this symbol on it to operate the exterior lamps.

The exterior lamp control has four positions:

 : Turns off all lamps, except the Daytime Running Lamps (DRL).

AUTO: Automatically turns the exterior lamps on and off, depending on outside lighting.

 : Turns on the parking lamps including all lamps, except the headlamps.

 : Turns on the headlamps together with the parking lamps and instrument panel lights.

See:

- *Exterior Lamp Controls on page 6-1.*
- *Daytime Running Lamps (DRL) on page 6-2.*
- *Fog Lamps on page 6-5.*

Windshield Wiper/Washer

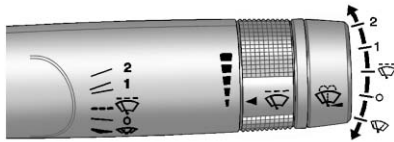

Sedan and Coupe Model

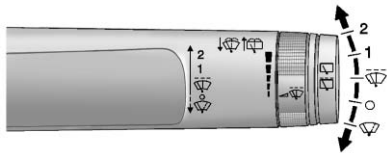

Wagon Model

The windshield wiper lever is on the right side of the steering column.

Move the windshield wiper lever to select the wiper speed.

 : Use for a single wipe. Briefly move the lever down and release. For several wipes, hold the lever down.

○ : Use to turn the wipers off.

 : For a delayed wiping cycle. Turn the band up for more frequent wipes or down for less frequent wipes.



- 1: Use for slow wipes.
- 2: Use for fast wipes.

Windshield Washer

Warning

In freezing weather, do not use the washer until the windshield is warmed. Otherwise the washer fluid can form ice on the windshield, blocking your vision.

Sedan and Coupe Model

 : Press the button with this symbol, on the end of the windshield washer lever, to wash the windshield. The washer fluid sprays onto the windshield and the wipers run for a few cycles to clear the windshield. Press and hold  for more wash cycles.

Wagon Model

Pull the lever toward you to spray washer fluid on the windshield. The spray continues until the lever is released. The wipers will run a few times.

See *Windshield Wiper/Washer* on page 5-4 and *Rear Window Wiper/Washer* on page 5-6 (if equipped).

Climate Controls

The heating, cooling, and ventilation for the vehicle can be controlled with this system.

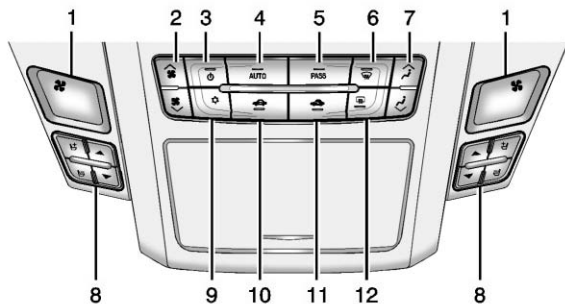

1. Driver and Passenger Displays
2. Fan
3. Power
4. AUTO (Automatic Operation)
5. PASS (Passenger Climate Control)
6. Defrost
7. Air Delivery Mode

8. Temperature and Heated/
Ventilated Seat
9. Air Conditioning
10. Recirculation
11. Outside Air
12. Rear Window Defogger

See *Dual Automatic Climate Control System* on page 8-1.

Transmission

Automatic Transmission

Driver Shift Control (DSC) or Tap Shift

DSC allows shifting an automatic transmission similar to a manual transmission. DSC can be enabled through the shift lever, or the Tap Shift controls on the back of the steering wheel (if equipped). See *Manual Mode* on page 9-28.

Manual Transmission

Skip Shift (CTS-V)

Under light acceleration, the transmission will only allow shifting from 1 (First) to 4 (Fourth). This helps improve fuel mileage. Under harder acceleration, Skip Shift is disabled, and all gears are available. See *Manual Transmission* on page 9-31.

Vehicle Features

Radio(s)

VOL/  : Press to turn the system on and off. Turn to increase or decrease the volume.

FM/AM: Press to select between FM or AM.

 : Press to select SiriusXM[®], if equipped.

TUNE/TONE: Turn to select radio stations.

SEEK or  **SEEK:** Press to seek the next or previous station.

INFO: Press to display additional information that may be available for the current song. When information is not available, No Information displays.

For more information about these and other radio features, see *Operation on page 7-3*.

Storing a Favorite Station

A maximum of 36 stations can be programmed as favorites using the six softkeys below the radio station frequency tabs on the display and by using the radio favorites page button (FAV button). Press the FAV button to go through up to six pages of favorites, each having six favorite stations available per page. Each page of favorites can contain any combination of AM, FM, or SiriusXM stations.

For more information, see *AM-FM Radio on page 7-8*.

Setting the Clock

The analog clock is on the instrument panel above the radio. The clock is not connected with any other vehicle system and runs by itself. To adjust the clock:

1. Locate the adjustment buttons directly below the clock face.

2. Press and hold the right adjustment button to move the clock hands forward, or the left adjustment button to make the clock hands go backward. Holding either button down will cause the clock to advance faster. Release the button before the desired time is reached.
3. Press and release either button to adjust the time by one minute increments.

For more information on setting the clock, see *Clock on page 5-9*.

Satellite Radio

Vehicles with a SiriusXM[®] satellite radio tuner and a valid SiriusXM satellite radio subscription can receive SiriusXM programming.

SiriusXM Satellite Radio Service

SiriusXM is a satellite radio service based in the 48 contiguous United States and 10 Canadian provinces. SiriusXM satellite radio has a wide variety of programming and commercial-free music, coast to coast, and in digital-quality sound. A fee is required to receive the SiriusXM service.

Refer to:

- www.siriusxm.com or call 1-866-635-2349 (U.S.).
- www.xmradio.ca or call 1-877-209-0079 (Canada).

See *Satellite Radio* on page 7-10.

Portable Audio Devices

Some vehicles have a 3.5 mm (1/8 in) auxiliary input and a USB port in the center console. External devices such as iPods®, laptop computers, MP3 players, CD changers, and USB drives may be connected, depending on the audio system.

See *Auxiliary Devices* on page 7-33.

Bluetooth®

The Bluetooth® system allows users with a Bluetooth-enabled mobile phone to make and receive hands-free calls using the vehicle audio system and controls.

The Bluetooth-enabled mobile phone must be paired with the in-vehicle Bluetooth system before it can be used in the vehicle. Not all phones will support all functions.

See *Bluetooth* on page 7-35.

Steering Wheel Controls

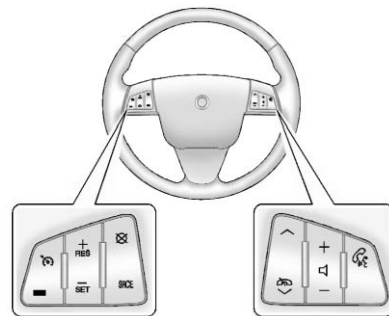

Some audio steering wheel controls could differ depending on the vehicle's options. Controls that can be adjusted at the steering wheel may include:

SRCE: Press to switch between AM, FM, or SiriusXM (if equipped) radio, CD, HDD (if equipped), auxiliary input jack, DVD (if equipped), and USB (if equipped).

∧ or ↶ / ∨ : Press to go to the next or previous radio station stored as a favorite, or the previous or next track of a CD.

Press to interact with the Bluetooth® system. See *Bluetooth* on page 7-35 for more information.

+ ◀ -: Press to increase or to decrease the volume.

🔇 / 🔊 : Press and release to silence the vehicle speakers only. The audio of the wireless and wired headphones, if the vehicle has these features, does not mute.

Press and release 🔇 / 🔊 again, to turn the sound on.

- For vehicles with a navigation system, press and hold 🔇 / 🔊 for two seconds to initiate speech recognition.
- For vehicles without a navigation system, press and hold 🔇 / 🔊 for two seconds to interact with OnStar® or Bluetooth.

- For vehicles with a navigation system, OnStar, or Bluetooth, press and hold 🔇 / 🔊 for two seconds and say "hands free" to interact with OnStar or Bluetooth.

For more information, see *Steering Wheel Controls* on page 5-3.

Cruise Control

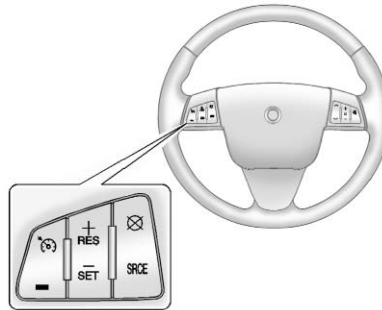

CTS Shown, CTS-V Similar

🔌 : Press to turn the system on or off. The indicator light on the button turns on when cruise control is on.

+RES: Press briefly to make the vehicle resume to a previously set speed, or press and hold to accelerate. If cruise control is already active, use to increase vehicle speed.

-SET: Press briefly to set the speed and activate cruise control. If cruise control is already active, use to decrease vehicle speed.

🔌 : Press to cancel cruise control without erasing the set speed from memory.

See *Cruise Control* on page 9-41.

Navigation System

If the vehicle has a navigation system, there is a separate infotainment manual that includes information on the radio, audio players, and navigation system.

The navigation system provides detailed maps of most major freeways and roads. After a destination has been set, the system provides turn-by-turn instructions for reaching the destination. In addition, the system can help locate a variety of points of interest (POIs), such as banks, airports, restaurants, and more.

Driver Information Center (DIC)

The DIC display is at the bottom of the instrument cluster. It shows the status of many vehicle systems and enables access to the personalization menu.

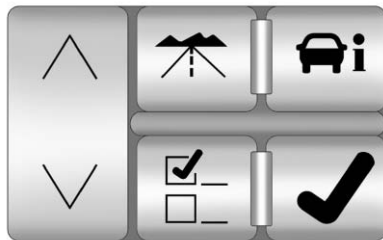



The DIC buttons are on the instrument panel next to the steering wheel.

 : Press to scroll through the trip and fuel displays.

 : Press to scroll through the vehicle information displays.

 : Press to customize the feature settings on your vehicle. See *Vehicle Personalization* on page 5-46.

 : Press to reset certain DIC features and to acknowledge DIC warning messages and clear them from the DIC display.

 or  : Press to scroll up and down the menu items.

See *Driver Information Center (DIC)* on page 5-27.

Vehicle Customization

Some vehicle features can be programmed by using the DIC buttons on the instrument panel next to the steering wheel. These features include:

- Language
- Door Lock and Unlock Settings
- Lighting
- Chime Volume
- Memory Settings

See *Vehicle Personalization* on page 5-46.

Rear Vision Camera (RVC)

The rear vision camera displays a view of the area behind the vehicle on either the navigation screen or the inside rearview mirror when the vehicle is shifted into R (Reverse). Once shifted out of R (Reverse), the navigation screen will go back to the last screen that had been displayed, after a delay or the video image automatically disappears from the inside rearview mirror.

To clean the camera lens above the license plate, rinse it with water and wipe it with a soft cloth.

See *Rear Vision Camera (RVC)* on page 9-46.

Ultrasonic Parking Assist

If equipped, this system uses sensors on the rear bumper to assist with parking and avoiding objects while in R (Reverse). It operates at speeds less than 8 km/h (5 mph). Ultrasonic Rear

Parking Assist (URPA) uses audible beeps to provide distance and system information.

Keep the sensors on the vehicle's rear bumper clean to ensure proper operation.

See *Ultrasonic Parking Assist* on page 9-43.

Power Outlets

Accessory power outlets can be used to plug in electrical equipment, such as a cell phone or MP3 player.

There are three accessory power outlets. The power outlets below the climate control system, inside the center console, and on the rear of the center console are powered while the vehicle is in ON/RUN, START or ACC/ACCESSORY mode, or until the driver door is opened within 10 minutes of turning off the vehicle.

On the CTS Wagon there is an additional accessory power outlet near the rear cargo net that is powered at all times.

Remove the cover to access and replace when not in use.

See *Power Outlets* on page 5-9.

Universal Remote System

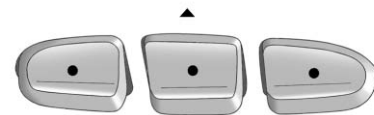

The Universal Home Remote System allows for garage door openers, security systems, and home automation devices to be programmed to work with these buttons in the vehicle.

See *Universal Remote System* on page 5-54.

Sunroof

If the vehicle has a power sunroof, it will only operate when the ignition is in ON/RUN or ACC/ACCESSORY, or when Retained Accessory Power (RAP) is active. See *Ignition Positions (Keyless Access)* on page 9-15 or *Ignition Positions (Key Access)* on page 9-17 and *Retained Accessory Power (RAP)* on page 9-22.

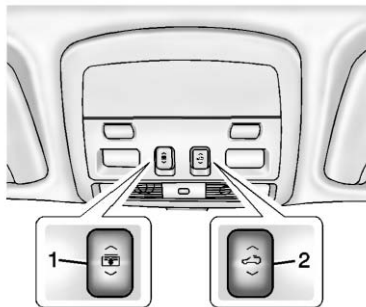

The driver side switch (1) operates the sunshade.

Open/Close: Press and hold the front or rear of the switch (1) to open or close the sunshade.

Express Open/Express Close: Press and release the rear or front of the switch (1) to express open or express close the sunshade. To stop the sunshade partway, press the switch (1) a second time.

The passenger side switch (2) operates the sunroof.

Vent: Coupe only, press and hold the front of the switch (2) to vent the sunroof. The sunshade will automatically open approximately 38 cm (15 in). Press and hold the rear of the switch (2) to close the sunroof vent.

Express Open/Express Close: Press and release the rear or front of the switch (2) to express open or express close the sunroof. To stop the sunroof partway, press the switch (2) a second time.

Comfort Stop: The sunroof has a comfort stop feature that stops the sunroof from opening to the full-open position. Press the rear of the sunroof switch (2) to the first detent to open the sunroof to the comfort open position. Press the rear of the switch (2) again to fully open the sunroof.

See *Sunroof* on page 2-30.





Performance and Maintenance

Traction Control/ Electronic Stability Control

The Traction Control System (TCS) limits wheel spin. The system turns on automatically every time the vehicle is started.

StabiliTrak assists with directional control of the vehicle in difficult driving conditions. The system turns on automatically every time the vehicle is started.

- To turn off TCS, press and release the TCS/StabiliTrak button  on the instrument panel (CTS) or the steering wheel (CTS-V). The appropriate DIC message is displayed. See *Ride Control System Messages on page 5-41*.

- Press the TCS/StabiliTrak button  again to turn traction control back on.
- To turn off both traction control and electronic stability control, press and hold the TCS/StabiliTrak button  on the instrument panel (CTS) or steering wheel (CTS-V) until  illuminates and the appropriate DIC message displays. See *Ride Control System Messages on page 5-41*.
- Press the TCS/StabiliTrak button  again to turn on both systems.

See *Traction Control/Electronic Stability Control on page 9-38*.

Tire Pressure Monitor

This vehicle may have a Tire Pressure Monitor System (TPMS).



The low tire pressure warning light alerts to a significant loss in pressure of one of the vehicle's tires. If the warning light comes on, stop as soon as possible and inflate the tires to the recommended pressure shown on the Tire and Loading Information label. See *Vehicle Load Limits on page 9-11*. The warning light will remain on until the tire pressure is corrected.

The low tire pressure warning light may come on in cool weather when the vehicle is first started, and then turn off as the vehicle is driven. This may be an early indicator that the tire pressures are getting low and the tires need to be inflated to the proper pressure.

The TPMS does not replace normal monthly tire maintenance. Maintain the correct tire pressures.

See *Tire Pressure Monitor System* on page 10-72.

Engine Oil Life System

The engine oil life system calculates engine oil life based on vehicle use and displays the CHANGE ENGINE OIL SOON message when it is time to change the engine oil and filter. The oil life system should be reset to 100% only following an oil change.

Resetting the Oil Life System

1. Using the DIC, display OIL LIFE REMAINING. See *Driver Information Center (DIC) on page 5-27* and *Engine Oil Messages on page 5-36*.
2. Press ✓ and hold for two seconds to clear the CHANGE ENGINE OIL SOON message and reset the oil life at 100%.

Be careful not to reset the oil life display accidentally at any time other than after the oil is changed. It cannot be reset accurately until the next oil change.

The oil life system can also be reset as follows:

1. Turn the ignition on with the engine off.
2. Fully press and release the accelerator pedal three times within five seconds.

If the CHANGE ENGINE OIL SOON message is not on, the system is reset.

See *Engine Oil Life System* on page 10-13.

Driving for Better Fuel Economy

Driving habits can affect fuel mileage. Here are some driving tips to get the best fuel economy possible.

- Avoid fast starts and accelerate smoothly.
- Brake gradually and avoid abrupt stops.
- Avoid idling the engine for long periods of time.
- When road and weather conditions are appropriate, use cruise control.
- Always follow posted speed limits or drive more slowly when conditions require.
- Keep vehicle tires properly inflated.

- Combine several trips into a single trip.
- Replace the vehicle's tires with the same TPC Spec number molded into the tire's sidewall near the size.
- Follow recommended scheduled maintenance.

Roadside Service

U.S.: 1-800-224-1400

Canada: 1-800-882-1112

TTY Users (U.S. Only):
1-888-889-2438

New Cadillac owners are automatically enrolled in the Roadside Service Program.

See *Roadside Service on page 13-5.*

OnStar®

If equipped, this vehicle has a comprehensive, in-vehicle system that can connect to a live Advisor for Emergency, Security, Navigation, Connection, and Diagnostic Services. See *OnStar Overview on page 14-1.*

Keys, Doors, and Windows

Keys and Locks

Keys	2-2
Remote Keyless Entry (RKE) System	2-4
Remote Keyless Entry (RKE) System Operation (Keyless Access)	2-4
Remote Keyless Entry (RKE) System Operation (Key Access)	2-9
Remote Vehicle Start	2-11
Door Locks	2-13
Central Door Unlocking System	2-15
Power Door Locks	2-15

Delayed Locking	2-15
Automatic Door Locks	2-16
Lockout Protection	2-16
Safety Locks (Sedan and Wagon)	2-16

Doors

Trunk	2-17
Liftgate	2-19

Vehicle Security

Vehicle Security	2-23
Vehicle Alarm System	2-23
Immobilizer	2-24
Immobilizer Operation (Key Access)	2-24
Immobilizer Operation (Keyless Access)	2-25

Exterior Mirrors

Convex Mirrors	2-26
Power Mirrors	2-27
Folding Mirrors	2-27
Heated Mirrors	2-27

Interior Mirrors

Automatic Dimming Rearview Mirror	2-27
---	------

Windows

Windows	2-28
Power Windows	2-28
Sun Visors	2-30

Roof

Sunroof	2-30
---------------	------

Keys and Locks

Keys

 **Warning**

Leaving children in a vehicle with an ignition key or Remote Keyless Entry (RKE) transmitter is dangerous and children or others could be seriously injured or killed. They could operate the power window or other controls or make the vehicle move. The windows will function with the key in the ignition or with the RKE transmitter in the vehicle, and children or others could be caught in the path of a closing window. Do not leave children in a vehicle with the ignition key or an RKE transmitter.



One of the following keys comes with the vehicle.



Key Access

This key is used for the driver door, ignition, and glove box.

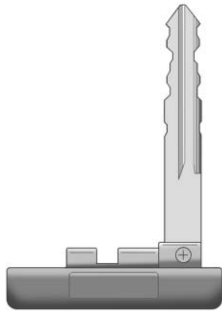

Keyless Access

This key, inside the transmitter, is used for the driver door, glove box, and rear seat pass-through door. See “Rear Seat Pass-Through” under *Trunk* on page 2-17.



Keyless Access

If the vehicle has the Keyless Access System, the transmitter has a thin button near the bottom of the transmitter used to remove the key. Press the button and pull the key out. Do not pull the key out without pressing the button.

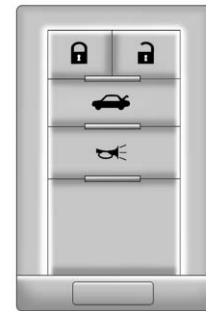

Key Access

If the vehicle has the Key Access System, there is no key in the transmitter.

⚠ Caution

If the transmitter does not have a button near the base, do not pull on the chrome base of the transmitter. Pulling on the base of this transmitter could damage it.

2-4 Keys, Doors, and Windows

This vehicle may have the Key Access System or a Keyless Access System. See *Remote Keyless Entry (RKE) System Operation (Keyless Access)* on page 2-4 or *Remote Keyless Entry (RKE) System Operation (Key Access)* on page 2-9. See *Ignition Positions (Keyless Access)* on page 9-15 or *Ignition Positions (Key Access)* on page 9-17 for information on starting the vehicle.

If the vehicle has an ignition and it becomes difficult to turn the key, inspect the key blade for debris. Periodically clean with a brush or pick.

See your dealer if a new key is needed.

Contact Roadside Service if locked out of the vehicle. See *Roadside Service* on page 13-5.

With an active OnStar subscription, an OnStar Advisor may remotely unlock the vehicle. If equipped, see “OnStar”.

Remote Keyless Entry (RKE) System

See *Radio Frequency Statement* on page 13-15.

If there is a decrease in the RKE operating range:

- Check the distance. The transmitter may be too far from the vehicle.
- Check the location. Other vehicles or objects may be blocking the signal.
- Check the transmitter's battery. See “Battery Replacement” later in this section.
- If the transmitter is still not working correctly, see your dealer or a qualified technician for service.

Remote Keyless Entry (RKE) System Operation (Keyless Access)

The Remote Keyless Entry (RKE) transmitter will work up to 60 m (195 ft) away.

The Keyless Access system locks and unlocks the doors and trunk without pressing the buttons on the RKE transmitter. The RKE transmitter must be within 1 m (3 ft) of the door or trunk being opened.

Keyless Unlocking

With the RKE transmitter within 1 m (3 ft), approach the front door and pull the handle to unlock and open the door. On some models there is a touch sensor on the door handle. If the transmitter is recognized, the door will unlock and open.

To access the rear doors first, pull the rear door handle once to unlock all doors and a second time to open the door.

Entering any door other than the driver door will cause all of the doors to unlock. This is not customizable.

To customize which doors unlock when the driver door is opened, see “Keyless Unlock” under *Vehicle Personalization* on page 5-46.

Keyless Locking

The doors lock after several seconds if all doors are closed and at least one RKE transmitter has been removed from the interior of the vehicle. To customize if the doors automatically lock upon exiting the vehicle, see “Keyless Locking” under *Vehicle Personalization* on page 5-46.

Keyless Trunk/Liftgate Opening

Press the trunk/liftgate release button above the license plate to open the trunk/liftgate if the RKE transmitter is within range. See *Trunk* on page 2-17 for additional information.

There are other conditions that affect the performance of the transmitter. See *Remote Keyless Entry (RKE) System* on page 2-4.

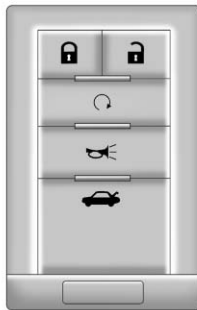

With Remote Start Shown, without and Wagon Similar

Ⓛ (Lock): Press once to lock the doors. The turn signal indicators flash. When **Ⓛ** is pressed twice, the turn signal indicators flash twice, and the horn sounds once to confirm locking.

To program the vehicle so the turn signal indicators do not flash and the horn does not sound when

pressing **Ⓛ** on the RKE transmitter, see “Remote Door Lock Feedback” under *Vehicle Personalization* on page 5-46.

Ⓛ (Unlock): Press once to unlock only the driver door. The turn signal indicators flash twice.

Press **Ⓛ** twice within five seconds to unlock all the doors. The interior lamps may come on.

To program the vehicle so the turn signal indicators do not flash and the fog lamps and back-up lamps remain on steady for about 20 seconds when the RKE transmitter is used to unlock the vehicle, see “Remote Door Unlock Feedback” under *Vehicle Personalization* on page 5-46.



For vehicles with the memory feature, press **Ⓛ** on the RKE transmitter to program and recall the memory settings. See *Memory Seats* on page 3-7.

2-6 Keys, Doors, and Windows

 **(Remote Start):** Press to operate the remote start feature. See *Remote Vehicle Start on page 2-11*.

 **(Remote Trunk/Liftgate Release):** Press and hold for about one second to unlock the trunk/liftgate. The automatic transmission must be in P (Park) or the manual transmission must be in Neutral with the parking brake set.

 **(Vehicle Locator/Panic Alarm):** Press and release to locate the vehicle. The horn sounds three times and the turn signal lamps flash three times.

Press and hold  for three seconds to sound the panic alarm. The horn sounds and the turn signal lamps flash for 30 seconds. Press and release  again to stop the alarm.

The vehicle comes with two transmitters. Each transmitter will have a number on top of it, "1" or "2." These numbers correspond to the driver of the vehicle. For example, the memory seat position for driver 1 will be recalled when using the transmitter labeled "1," if enabled through the DIC. See *Memory Seats on page 3-7* and *Vehicle Personalization on page 5-46*.

Programming Transmitters to the Vehicle

Only RKE transmitters programmed to the vehicle will work. If a transmitter is lost or stolen, a replacement can be purchased and programmed through your dealer. The vehicle can be reprogrammed so that lost or stolen transmitters no longer work. Each vehicle can have up to four transmitters matched to it.

Programming with a Recognized Transmitter

A new transmitter can be programmed to the vehicle when there is one recognized transmitter. For vehicles sold in Canada, two recognized transmitters are required to program a new transmitter.

1. Make sure the vehicle is off.
2. Place the recognized transmitter(s) in the cupholder. Have the new transmitter available with you.
3. Insert the vehicle key into the key lock cylinder on the outside of the driver door.
4. Turn the key to the unlock position five times within five seconds.
5. The Driver Information Center (DIC) displays READY TO LEARN ELECTRONIC KEY #2, 3 or 4.

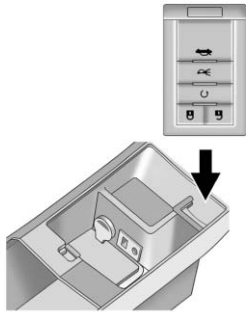

6. Place the new transmitter into the transmitter pocket with the buttons facing the front of the vehicle. The transmitter pocket is inside the center console storage area between the driver and front passenger seats.
7. A beep sounds once the transmitter is programmed. The DIC displays READY TO LEARN ELECTRONIC KEY #3 or 4, or MAXIMUM # ELECTRONIC KEYS LEARNED.
8. Press the ignition control knob to exit programming mode.

9. Remove the transmitter from the transmitter pocket and press  on the RKE transmitter two times.
10. To program additional transmitters, repeat Steps 6–9.

Programming without a Recognized Transmitter

United States owners are permitted to program a new transmitter to their vehicle when a recognized transmitter is not available. The Canadian immobilizer standard requires that Canadian owners see their dealer for programming new transmitters when two recognized transmitters are not available.

The procedure requires three 10-minute cycles to complete the matching process.

1. Make sure the vehicle is off.

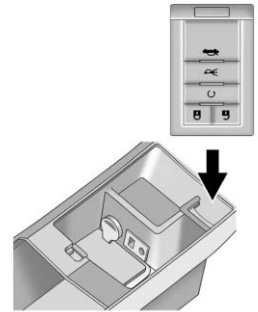

2. Place the new transmitter into the transmitter pocket with the buttons facing the front of the vehicle. The transmitter pocket is inside the center console storage area between the driver and front passenger seats.
3. Insert the vehicle key into the key lock cylinder on the driver door.
4. Turn the key to the unlock position five times within five seconds.

2-8 Keys, Doors, and Windows

5. The DIC displays PRESS START CONTROL TO LEARN KEYS.
 6. Press the ignition switch in.
 7. The DIC reads LEARN DELAY ACTIVE WAIT XX MIN and counts down to zero.
 8. The DIC displays PRESS START CONTROL TO LEARN KEYS again.
 9. Press the ignition switch in again.
 10. Repeat Steps 7, 8, and 9.
 11. The DIC reads LEARN DELAY ACTIVE WAIT XX MIN and counts down to zero.
 12. A beep sounds and the DIC reads READY TO LEARN ELECTRONIC KEY # X. All previously known transmitter programming has been erased.
13. A beep sounds once programming is complete. The DIC displays READY TO LEARN ELECTRONIC KEY # 2.

To program additional transmitters, insert each transmitter in the pocket until a beep is heard and the DIC advances to the next electronic key number. Up to eight transmitters can be programmed. The DIC displays MAXIMUM # ELECTRONIC KEYS LEARNED and exits the programming mode.
 14. Press the ignition control knob if programming is complete.
 15. Press  on each newly programmed transmitter to complete the process.

Starting the Vehicle with a Low Transmitter Battery

Replace the battery if the REPLACE BATTERY IN REMOTE KEY message displays in the DIC. See “Replace Battery In Remote Key” under *Key and Lock Messages* on page 5-37 for additional information.

If the transmitter battery is weak, the DIC may display ELECTRONIC KEY NOT DETECTED when you try to start the vehicle. To start the vehicle, place the transmitter in the center console storage area transmitter pocket with the buttons facing to the front of the vehicle. Then, with the vehicle in P (Park) or N (Neutral), press the brake pedal and the ignition control knob. See *Starting the Engine* on page 9-20, for additional information about the vehicle's electronic keyless ignition. Replace the transmitter battery as soon as possible.

Battery Replacement

Caution

When replacing the battery, do not touch any of the circuitry on the transmitter. Static from your body could damage the transmitter.

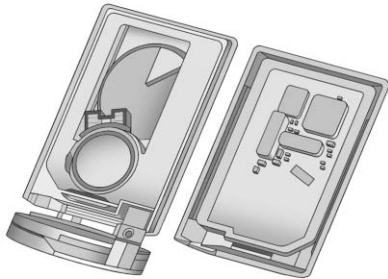

1. Remove the key from the transmitter by pressing the thin button near the bottom of the

transmitter and pulling the key out. Do not pull the key out without pressing the button.

2. Separate the transmitter with a flat, thin object inserted into the slot on the side of the transmitter.

Do not try to separate the transmitter by inserting a flat, thin object into the key slot. This will permanently damage the transmitter.

3. Remove the old battery. Do not use a metal object.
4. Insert the new battery, positive side facing down. Replace with a CR2032 or equivalent battery.
5. Snap the transmitter back together.
6. Reinstall the key into the transmitter.

Remote Keyless Entry (RKE) System Operation (Key Access)

The RKE transmitter works up to 20 m (65 ft) away.

Other conditions can affect the performance of the transmitter. See *Remote Keyless Entry (RKE) System* on page 2-4.

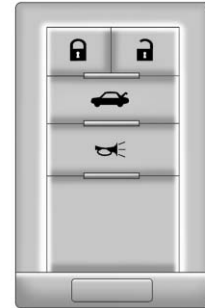



Coupe Shown, Wagon and Sedan Similar

Do not pull on the chrome base of the transmitter.

2-10 Keys, Doors, and Windows

 **(Lock):** Press to lock all of the doors.



If enabled through the Driver Information Center (DIC), the parking lamps may flash once to indicate locking has occurred. The horn may chirp when  is pressed again within five seconds. See *Vehicle Personalization on page 5-46*.

 **(Unlock):** Press to unlock the driver door. If  is pressed again within five seconds, all remaining doors unlock. The interior lamps come on and stay on for 20 seconds or until the ignition is turned on.

If enabled through the DIC, the parking lamps flash twice to indicate unlocking has occurred. See *Vehicle Personalization on page 5-46*.

 **(Remote Trunk/Liftgate Release):** Press and hold for about one second to unlock the trunk/liftgate. The automatic transmission must be in P (Park) or the manual transmission must be in Neutral with the parking brake set.

 **(Vehicle Locator/Panic Alarm):** Press and release to locate the vehicle. The turn signal lamps flash and the horn sounds three times.

Press and hold  for three seconds to activate the panic alarm. The turn signal lamps flash and the horn sounds for 30 seconds. The alarm turns off when the ignition is moved to START or  is pressed again. The ignition must be in LOCK/OFF for the panic alarm to work.

The vehicle comes with two transmitters. Each transmitter will have a number on top of it, “1” or “2.” These numbers correspond to the driver of the vehicle. For example, the memory seat position for driver 1 will be recalled when using the transmitter labeled “1,” if enabled through the DIC. See *Memory Seats on page 3-7* and *Vehicle Personalization on page 5-46*.

Programming Transmitters to the Vehicle

Only RKE transmitters programmed to the vehicle will work. If a transmitter is lost or stolen, a replacement can be purchased and programmed through your dealer. When the replacement transmitter is programmed to the vehicle, all remaining transmitters must also be programmed. Any lost or stolen transmitters no longer work once the new transmitter is programmed. Each vehicle can have up to eight transmitters programmed to it.

Battery Replacement

Replace the battery if the REPLACE BATTERY IN REMOTE KEY message displays in the DIC. See “Replace Battery In Remote Key” under *Key and Lock Messages* on page 5-37.

Caution

When replacing the battery, do not touch any of the circuitry on the transmitter. Static from your body could damage the transmitter.

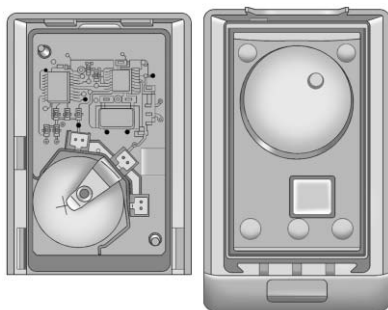

To replace the battery:

1. Separate the transmitter with a flat, thin object inserted into the notch, above the metal base.
2. Remove the old battery. Do not use a metal object.
3. Insert the new battery, positive side facing up. Replace with a CR2032 or equivalent battery.
4. Snap the transmitter back together.

Remote Vehicle Start

This vehicle may have a remote starting feature that allows you to start the engine from outside the vehicle.

 **(Remote Vehicle Start):** This button will be on the RKE transmitter if you have remote start.

The automatic climate control may begin to heat or cool your vehicle during remote start depending on the temperature inside and outside of the vehicle. The windshield defroster and/or rear window defogger turn on if it is cold outside. If the vehicle has heated seats, they may also be turned on during remote start to warm up the seats in cold weather. Normal operation of the climate control system returns after the ignition is turned to ON/RUN. See *Dual Automatic Climate Control System* on page 8-1.

2-12 Keys, Doors, and Windows

Laws in some local communities may restrict the use of remote starters. For example, some laws may require a person using remote start to have the vehicle in view when doing so. Check local regulations for any requirements on remote starting of vehicles.

If your vehicle is low on fuel, do not use the remote start feature. The vehicle may run out of fuel.

The RKE transmitter range may be less while the vehicle is running.

Other conditions can affect the performance of the transmitter; see *Remote Keyless Entry (RKE) System on page 2-4* for additional information.

Starting the Vehicle Using Remote Start

To start the engine using the remote start feature:

1. Aim the transmitter at the vehicle and press and release  on the transmitter.



2. Press and hold  for at least four seconds or until the vehicle's turn signal lamps flash. The parking lamps will turn on and remain on as long as the engine is running. The vehicle's doors will be locked.
3. After entering the vehicle during a remote start, press the brake pedal and turn the ignition to ON/RUN to drive the vehicle.

After a remote start, the engine will automatically shut off after 10 minutes unless a time extension has been done or the ignition has been turned to ON/RUN.

Extending Engine Run Time

To extend the engine run time by 10 minutes, repeat Steps 1 and 2 while the engine is still running. The engine run time can only be extended if it is the first remote start since the vehicle has been driven. Remote start can be extended one time.

If the remote start procedure is used again before the first 10-minute time frame has ended, the first 10 minutes will immediately expire and the second 10-minute time frame will start.

For example, if  and then  are pressed again after the vehicle has been running for five minutes, 10 minutes are added, allowing the engine to run for a total of 15 minutes.

A maximum of two remote starts are allowed between ignition cycles.

After the vehicle's engine has been started two times using the remote start button, the ignition must be turned on and then back off before the remote start procedure can be used again.

Canceling a Remote Start

To manually shut off the engine after a remote start, do any of the following:

- Aim the RKE transmitter at the vehicle and press and hold  until the parking lamps turn off.
- Turn on the hazard warning flashers.
- Turn the ignition switch on and then off.

Conditions in Which Remote Start Will Not Work

The remote vehicle start feature will not operate if any of the following occur:

- The key is in the ignition.
- A RKE transmitter is inside the vehicle.
- The vehicle's hood is not closed.
- The hazard warning flashers are on.

- There is an emission control system malfunction.
- The engine coolant temperature is too high.
- The oil pressure is low.
- Two remote vehicle starts have already been used. The maximum number of remote starts between ignition cycles with the key is two.

Door Locks

Warning

Unlocked doors can be dangerous.

- Passengers — especially children — can easily open the doors and fall out of a moving vehicle. When a door is locked it will not open. You increase the chance of being thrown out of the vehicle in a crash if the doors are not

(Continued)

Warning (Continued)

locked. So, wear safety belts properly and lock the doors whenever you drive.

- Young children who get into unlocked vehicles may be unable to get out. A child can be overcome by extreme heat and can suffer permanent injuries or even death from heat stroke. Always lock your vehicle whenever you leave it.
- Outsiders can easily enter through an unlocked door when you slow down or stop your vehicle. Locking your doors can help prevent this from happening.

2-14 Keys, Doors, and Windows



Wagon/Sedan

From inside, pull a front door handle to unlock. Pulling the door handle again unlatches the door. For a rear door use the door lock knob on the top of the door.

From the outside, turn the key toward the front or rear of the vehicle, or press  or  on the Remote Keyless Entry (RKE) transmitter.

See *Remote Keyless Entry (RKE) System Operation (Keyless Access)* on page 2-4 or *Remote Keyless Entry (RKE) System Operation (Key Access)* on page 2-9.

Coupe

From the outside, press  or  on the RKE transmitter.

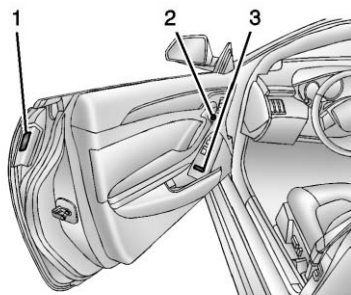

1. Door Handle Sensor
2. Door Latch Button
3. Power Door Lock Switch

With the RKE transmitter within range, grip the door handle sensor (1). See *Remote Keyless Entry (RKE) System Operation (Keyless Access)* on page 2-4 or *Remote Keyless Entry (RKE) System Operation (Key Access)* on page 2-9. When the passenger door is opened first, the driver door will also unlock.

From the inside, use the power door lock switch (3). See *Power Door Locks* on page 2-15.

To open a door from the inside, press the door latch button (2). A tone will sound when the button is pressed.

If the vehicle has lost battery power, the driver door can be opened manually.

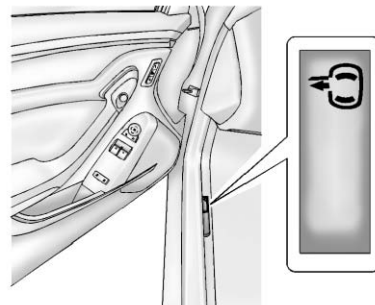

- From inside the vehicle, pull the manual door release handle.

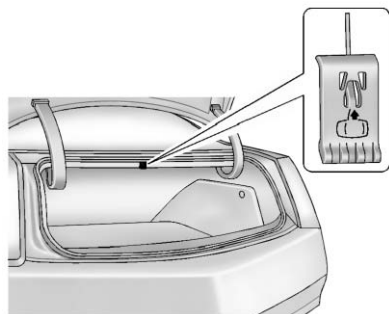

- From outside the vehicle, use the key to unlock the trunk. Then, pull the door release tab, under the package shelf at the top of the trunk, to unlock and unlatch the driver door.

Central Door Unlocking System

The vehicle has a central door unlocking feature. When unlocking the driver door, the other doors can be unlocked by holding the key in

the turned position for a few seconds or by quickly turning the key twice in the lock cylinder.

Power Door Locks

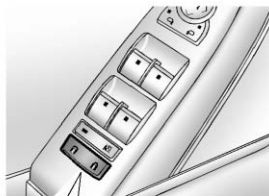

Sedan/Wagon Shown, Coupe Similar

The switches are on the front doors.

🔓 (Unlock): Press to unlock the doors.

🔒 (Lock): Press to lock the doors.

Delayed Locking

With this feature, you can delay the actual locking of the doors.

When the power door lock switch is pressed when the key is not in the ignition and the driver door is opened, a chime will sound three times indicating that delayed locking is active.

When all the doors are closed, the doors will lock automatically after five seconds. If a door is reopened before five seconds have elapsed, the five second timer will reset itself once all the doors are closed again.

You can press the door lock switch again or the lock button on the RKE transmitter to override this feature and lock the doors immediately.

Automatic Door Locks

For vehicles with an automatic transmission, the doors will lock automatically when all doors are closed, the ignition is on, and the shift lever is moved out of P (Park). The doors will automatically unlock when the vehicle is stopped and the shift lever is moved into P (Park).

For vehicles with a manual transmission, the doors will lock automatically after the vehicle speed reaches 8 km/h (5 mph). The doors will automatically unlock when the key is turned off and removed from the ignition.

Use the manual or power door locks to unlock the doors if someone needs to exit, and to lock the doors again.

The power door locks can be programmed through the Driver Information Center (DIC). See *Vehicle Personalization on page 5-46*.

Lockout Protection

If the power door lock switch is pressed when the key is in the ignition and a door is open, all the doors will lock and only the driver door will unlock. If the doors are closed, they can be locked by using the Remote Keyless Entry (RKE) transmitter. Be sure to remove the key from the ignition when locking the vehicle.

This feature can be overridden by pressing the lock button on the RKE transmitter or by pressing the power lock switch a second time.

Safety Locks (Sedan and Wagon)

The rear door safety locks prevent passengers from opening the rear doors from inside the vehicle.

Manual Safety Locks

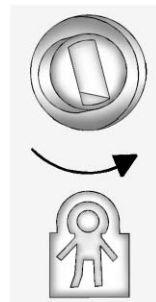

If equipped, the safety lock is located on the inside edge of the rear doors. To use the safety lock:

1. Insert the key into the safety lock slot and turn it so the slot is in the horizontal position.
2. Close the door.
3. Do the same for the other rear door.

To open a rear door when the safety lock is on:

1. Unlock the door by lifting the rear door lock, using the power door lock switch, or with the Remote Keyless Entry (RKE) transmitter.
2. Open the door from the outside.

To cancel the safety lock:

1. Unlock the door and open it from the outside.
2. Insert the key into the safety lock slot and turn it so the slot is in the vertical position.
3. Do the same for the other rear door.

Doors

Trunk

 **Warning**

Exhaust gases can enter the vehicle if it is driven with the liftgate or trunk/hatch open, or with any objects that pass through the seal between the body and the trunk/hatch or liftgate. Engine exhaust contains carbon monoxide (CO) which cannot be seen or smelled. It can cause unconsciousness and even death.

If the vehicle must be driven with the liftgate or trunk/hatch open:

- Close all of the windows.
- Fully open the air outlets on or under the instrument panel.

(Continued)

Warning (Continued)

- Adjust the climate control system to a setting that brings in only outside air and set the fan speed to the highest setting. See “Climate Control Systems” in the Index.
- If the vehicle is equipped with a power liftgate, disable the power liftgate function.

See *Engine Exhaust* on page 9-25.

2-18 Keys, Doors, and Windows

Trunk Lock Release

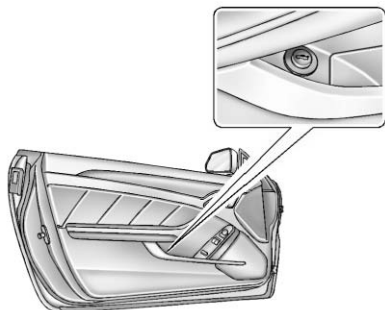

The remote trunk release button is on the driver door, inside the storage compartment under the armrest.

On vehicles with an automatic transmission, the shift lever must be in P (Park) or N (Neutral). On vehicles with a manual transmission, the shift lever must be in Neutral, and the parking brake set.

The trunk may be opened by pressing the remote trunk release button on the driver door,  on the Remote Keyless Entry (RKE) transmitter, or the trunk release button on the rear of the trunk above the license plate.

On vehicles with the Keyless Access System, if the vehicle is locked, the keyless access transmitter must be within 1 m (3 ft) of the trunk for it to be recognized; the trunk can then be opened by the trunk release button above the license plate.

Use the key in the trunk lock cylinder.

Close the trunk by pulling on the handle. Do not use the handle as a tie-down.

Rear-Seat Pass Through

If equipped with the rear-seat pass through door, this is useful when transporting long items.

To open the door, pull down the rear seat armrest. Then pull the lever all the way down to release the door.

To close the door, push it up and back into place. Then try to open the door without pulling up on the lever to make sure it is locked into place.

Emergency Trunk Release Handle



Caution

Do not use the emergency trunk release handle as a tie-down or anchor point when securing items in the trunk as it could damage the handle.

There is a glow-in-the-dark emergency trunk release handle on the back wall of the trunk. This handle will glow following exposure to light. Pull the release handle toward the front of the vehicle to open the trunk from the inside.

Liftgate

Power Liftgate Operation

Warning

Exhaust gases can enter the vehicle if it is driven with the liftgate or trunk/hatch open, or with any objects that pass through the seal between the body and the trunk/hatch or liftgate. Engine exhaust contains carbon monoxide (CO) which cannot be seen or smelled. It can cause unconsciousness and even death.

(Continued)

Warning (Continued)

If the vehicle must be driven with the liftgate or trunk/hatch open:

- Close all of the windows.
- Fully open the air outlets on or under the instrument panel.
- Adjust the climate control system to a setting that brings in only outside air and set the fan speed to the highest setting. See “Climate Control Systems” in the Index.
- If the vehicle is equipped with a power liftgate, disable the power liftgate function.

See *Engine Exhaust* on page 9-25.

2-20 Keys, Doors, and Windows

Warning

You, or others, could be injured if caught in the path of the power liftgate. Make sure there is no one in the way of the liftgate as it is opening and closing.

Caution

To avoid damage to the liftgate or liftgate glass, make sure the area above and behind the liftgate is clear before opening it.

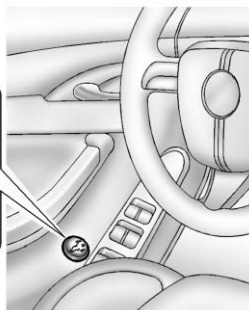
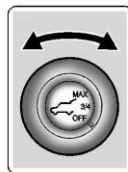

Vehicles with an automatic transmission must be in P (Park) and a manual transmission must be in Neutral to operate the power liftgate. The taillamps flash when the power liftgate moves.

Turn the selector switch to choose one of three modes:

MAX: The liftgate opens to the full open height.

3/4: The liftgate opens to a reduced open height that can be set in a range of approximately $\frac{3}{4}$ open to full open. Use this setting to prevent the liftgate from opening

into overhead obstructions such as a garage door or roof mounted cargo during power operation. The liftgate can still be opened fully manually.

OFF: The liftgate only operates manually in this position.

In either the MAX or $\frac{3}{4}$ mode, to power open or close the liftgate:

- Press and hold  on the Remote Keyless Entry (RKE) transmitter until the liftgate starts moving. See *Remote Keyless Entry (RKE) System Operation (Keyless Access)* on page 2-4 or *Remote Keyless Entry (RKE) System Operation (Key Access)* on page 2-9.
- Press the center of the power liftgate button on the driver door, with the driver door unlocked.
- Press the touch pad on the outside liftgate handle, with all doors unlocked, to open the liftgate.

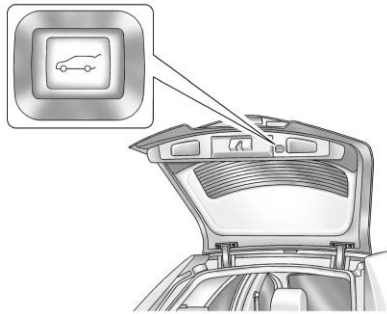

- Press and release  on the liftgate next to the latch to close the liftgate.

Pressing any button that operates the power liftgate, or the touch pad while the liftgate is moving, stops it. Pressing the button or RKE again reverses the direction. There is a minimum distance that the power liftgate must already be open for the system to hold it open. If movement is stopped below that minimum, the liftgate closes.

Do not force the liftgate open or closed during a power cycle.

If the transmission is shifted out of P (Park) while the power function is in progress, the liftgate power function will continue to completion. If the transmission is shifted out of P (Park) and the vehicle accelerates before the power liftgate latch is closed, the liftgate may reverse to the open position. Cargo could fall out of the vehicle. Close and latch the power liftgate before driving.

The power liftgate may be temporarily disabled under extreme temperatures or low battery conditions. If this occurs, the liftgate can still be operated manually.

If the liftgate is powered open and the liftgate support struts have lost pressure, the turn signals will flash and a chime will sound. The liftgate will stay open, and then slowly close. See your dealer for service before using the liftgate.

Obstacle Detection Features

If the liftgate encounters an obstacle during a power open or close cycle, a warning chime will sound and the

liftgate will automatically reverse direction to the full closed or open position. After removing the obstacle, the power liftgate can be used again. If the liftgate encounters multiple obstacles on the same power cycle, the power function will deactivate. After removing the obstacles, the liftgate will resume normal power operation.

The vehicle has pinch sensors on the side edges of the liftgate. If an object is caught between the liftgate and the body and presses against this sensor, the liftgate will reverse direction and open fully. The liftgate will remain open until it is activated again or closed manually.

Setting the Power Liftgate Intermediate Mode

To change the liftgate stop position:

1. Turn the liftgate switch to either the MAX, or the $\frac{3}{4}$ mode position and power open the liftgate.

2-22 Keys, Doors, and Windows

2. Stop the liftgate movement at the desired height by pressing any button that operates the power liftgate, or the touch pad. Manually adjust the liftgate position if required.
3. Press and hold the button on the liftgate adjacent to the latch until the turn signals flash and a beep sounds to indicate that the new setting is recorded.

When power opened with the $\frac{3}{4}$ mode selected, the liftgate stops at the new set position.

If an audible and visual response is not received when setting the intermediate stop position then the liftgate height is below the $\frac{3}{4}$ open height minimum, approximately 1.52 m (5 ft). The liftgate cannot be set below that minimum.

Manual Operation of Power Liftgate

To change the liftgate to manual operation, with the vehicle in P (Park) for an automatic transmission or Neutral for a manual transmission, turn the mode selector switch to OFF.

With the power liftgate disabled and all of the doors unlocked, the liftgate can be manually opened and closed. Manual operation of a vehicle with a power liftgate requires more effort than a standard non-power liftgate.

To open the liftgate, press the touch pad under the liftgate handle and lift. To close the liftgate, use the pull cup. With the power liftgate disabled, the liftgate electric latch will still power latch once contact is made with the striker. Always close the liftgate before driving.

If  is pressed on the RKE transmitter while power operation is disabled, the turn signals will flash and the liftgate will not move.

The liftgate has an electric latch. If the battery is disconnected or has low voltage, the liftgate will not open. The liftgate will resume operation when the battery is reconnected and charged.

Vehicle Security

This vehicle has theft-deterrent features; however, they do not make the vehicle impossible to steal.

Vehicle Alarm System

This vehicle may have an anti-theft alarm system.



The security light, located in the instrument panel cluster, comes on when the system is arming.

Arming the System

To arm the system, do one of the following:

1. Close all of the windows and doors, then lock the doors with the RKE transmitter.

2. Lock the vehicle using the front power door lock switches on the doors when the door is open.

The alarm will arm after 30 seconds. Pressing  on the RKE transmitter a second time will bypass the 30-second delay and immediately arm the system.

If a locked door or trunk is opened without using the key in the driver door key cylinder or the RKE transmitter, a 10-second pre-alarm will occur. The horn will chirp and the lights will flash. If the key is not placed in the ignition and turned to START or the door is not unlocked by pressing  on the RKE transmitter during the 10-second pre-alarm, the alarm will go off. The headlamps will flash and the horn will sound for about 30 seconds, then will turn off to save the battery power.

The theft-deterrent system will not activate if the doors are locked with the key or the manual door lock. It activates only if the power door lock switch is used while the door is open, or with the RKE transmitter.

To avoid setting off the alarm by accident:

- Lock the vehicle with the door key after the doors are closed.
- Always unlock a door with the RKE transmitter or by using the key in the driver door cylinder. Unlocking a door any other way will set off the alarm.

Turn off the alarm by pressing  on the RKE transmitter.

Disarming the System

To disarm the system, either unlock the doors using the transmitter, or start the vehicle with a recognized transmitter in the vehicle.

2-24 Keys, Doors, and Windows

To avoid setting off the alarm by accident, lock the vehicle with the door key after the doors are closed, and always unlock a door with the transmitter or by using the key in the driver door cylinder. Unlocking a door any other way will set off the alarm.

If you set off the alarm by accident, turn off the alarm by pressing the unlock button on the transmitter.

How to Detect a Tamper Condition

If  is pressed and the horn sounds, an attempted break-in occurred while the system was armed.

If the alarm has been activated, the THEFT ATTEMPTED message will appear on the DIC. See *Security Messages* on page 5-43.

Immobilizer

See *Radio Frequency Statement* on page 13-15.

Immobilizer Operation (Key Access)

This vehicle has a passive theft-deterrent system.

The system does not have to be manually armed or disarmed.

The vehicle is automatically immobilized when the key is removed from the ignition.

The system is automatically disarmed when the vehicle is started with the correct key. The key uses a transponder that matches an immobilizer control unit in the vehicle and automatically disarms the system. The vehicle may not start if the key is damaged.



The security light in the instrument cluster, comes on if there is a problem with arming or disarming the theft-deterrent system.

When trying to start the vehicle, the security light comes on briefly when the ignition is turned on.

If the engine does not start and the security light stays on, there is a problem with the system. Turn the ignition off and try again.

If the engine still does not start and the key appears to be undamaged or the light continues to stay on, try another key.

If the engine still does not start with the other key, the vehicle needs service. If the vehicle does start, the first key may be damaged.

See your dealer who can service the theft-deterrent system and have a new key made.

It is possible for the theft-deterrent system decoder to learn the transponder value of a new or replacement key. Up to eight keys can be programmed for the vehicle. The following procedure is for programming additional keys only.

To program a new key:

1. Verify that the new key has ⊕ stamped on it.
2. Insert the current key in the ignition and start the engine. If the engine will not start, see your dealer for service.
3. After the engine has started, turn the key to LOCK/OFF, and remove the key.
4. Insert the key to be programmed and turn it to ON/RUN within 10 seconds of the ignition being turned to LOCK/OFF in Step 3.

5. The security light will turn off once the key has been programmed. It may not be apparent that the security light went on due to how quickly the key is programmed.

6. Repeat Steps 1–4 if additional keys are to be programmed.

Do not leave the key or device that disarms or deactivates the theft deterrent system in the vehicle.

Immobilizer Operation (Keyless Access)

This vehicle has a passive theft-deterrent system.

The system does not have to be manually armed or disarmed.

The vehicle is automatically immobilized when the ignition control knob is turned to LOCK/OFF.

The immobilization system is disarmed when the ignition control knob is turned and a valid transmitter is found in the vehicle.



The security light in the instrument cluster, comes on if there is a problem with arming or disarming the theft-deterrent system.

One or more RKE transmitters can be matched to the vehicle's immobilizer control unit. Only a correctly matched RKE transmitter will start the vehicle. If the RKE transmitter is ever damaged, you may not be able to start your vehicle.

When trying to start the vehicle, the security light comes on briefly when the ignition is turned on.

If the engine does not start and the security light stays on, there is a problem with the system. Turn the ignition control knob off and try again.

If the ignition control knob does not turn, and the RKE transmitter appears to be undamaged, try another RKE transmitter. Or, you may try placing the transmitter in the transmitter pocket located in the center console. See “Electronic Key Not Detected” under *Key and Lock Messages on page 5-37*.

If the ignition control knob still does not rotate with the other transmitter, the vehicle needs service. If the ignition control knob does rotate, the first transmitter may be faulty. See your dealer who can service the theft-deterrent system and have a new RKE transmitter programmed to the vehicle.

It is possible for the immobilizer system to learn new or replacement RKE transmitters. Up to eight RKE transmitters can be programmed for the vehicle. To program additional transmitters, see “Programming Transmitters to the Vehicle” for Keyless Access under *Remote Keyless Entry (RKE) System Operation (Keyless Access) on page 2-4* or *Remote Keyless Entry (RKE) System Operation (Key Access) on page 2-9*.

Do not leave the key or device that disarms or deactivates the theft-deterrent system in the vehicle.

Exterior Mirrors

Convex Mirrors



Caution

A convex mirror can make things, like other vehicles, look farther away than they really are. If you cut too sharply into the right lane, you could hit a vehicle on the right. Check the inside mirror or glance over your shoulder before changing lanes.

The passenger side mirror is convex shaped. A convex mirror's surface is curved so more can be seen from the driver seat.

Power Mirrors



Controls for the outside power mirrors are on the driver door.

To adjust each mirror:

1. Press (1) or (2) to select the driver or passenger side mirror.
2. Press the arrows on the control pad to move the mirror up, down, right, or left.

3. Adjust each mirror so that a little of the vehicle and the area behind it can be seen.
4. Press (1) or (2) again to deselect the mirror.

Folding Mirrors

Manual

Vehicles with manual folding mirrors are folded inward toward the vehicle to prevent damage when going through an automatic car wash. Push the mirror outward to return it to the original position.

Heated Mirrors

(Rear Window Defogger):

Press to heat the mirrors.

See *Dual Automatic Climate Control System on page 8-1*.

Interior Mirrors

Automatic Dimming Rearview Mirror

The vehicle has an automatic dimming inside rearview mirror. Automatic dimming reduces the glare of headlamps from behind you.

If the vehicle has a rear vision camera (RVC), see *Rear Vision Camera (RVC) on page 9-46*.

Vehicles with OnStar have three control buttons at the bottom of the mirror. See your dealer about OnStar and how to subscribe to it. See *OnStar Overview on page 14-1*.

Cleaning the Mirror

Do not spray glass cleaner directly on the mirror. Use a soft towel dampened with water.

Windows

Warning

Never leave a child, a helpless adult, or a pet alone in a vehicle, especially with the windows closed in warm or hot weather. They can be overcome by the extreme heat and suffer permanent injuries or even death from heat stroke.



The vehicle aerodynamics are designed to improve fuel economy performance. This may result in a pulsing sound when either rear window is down and the front windows are up. To reduce the sound, open either a front window or the sunroof, if equipped.

Power Windows

Warning

Children could be seriously injured or killed if caught in the path of a closing window. Never leave keys in a vehicle with children. When there are children in the rear seat, use the window lockout button to prevent operation of the windows. See *Keys on page 2-2*.

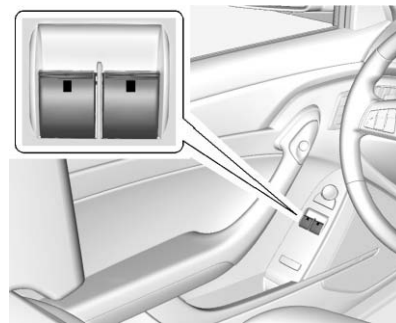

Coupe Shown, Sedan/Wagon Similar

The driver power window switches control all the windows. The passenger switch only controls that window.

Press the switch down to lower the window. Pull the switch up to raise it.

Retained Accessory Power (RAP) allows the use of the power windows after the ignition has been turned off. See *Retained Accessory Power (RAP) on page 9-22*.

Express-Down/Up Windows

Windows with the express feature allow the windows to be raised and lowered all the way without holding the switch.

Press or pull the switch fully and release it to activate the express feature.

The express mode can be canceled by briefly pressing or pulling the switch.

Express Window Anti-Pinch Feature

If any object is in the path of the window when the express-up is active, the window will stop at the obstruction and auto-reverse to a preset factory position. Weather conditions such as severe icing may also cause the window to auto-reverse. The window will return to normal operation after the obstruction or condition is removed.

Express Window Anti-Pinch Override



If express override is activated, the window will not reverse automatically. You or others could be injured and the window could be damaged. Before you use express override, make sure that all people and obstructions are clear of the window path.

The anti-pinch feature can be overridden. Hold the window switch all the way up to the second position. The window will rise for as long as the switch is held. Once the switch is released, the express mode is re-activated.

In this mode, the window can close on an object in its path. Use care when using the override mode.

Programming the Power Windows

If the vehicle battery has been recharged or disconnected, or is not working, the front power windows will need to be reprogrammed for the express-up feature to work. Before reprogramming, replace or recharge the vehicle's battery.

To program:

1. With the ignition in ON/RUN or ACC/ACCESSORY, or when Retained Accessory Power (RAP) is active, close all doors.
2. Press and hold the power window switch until the window is fully open.
3. Pull the power window switch up until the window is fully closed.
4. Continue holding the switch up for approximately two seconds after the window is completely closed.

2-30 Keys, Doors, and Windows

The window is now reprogrammed. Repeat the process for the other windows.

Window Lockout

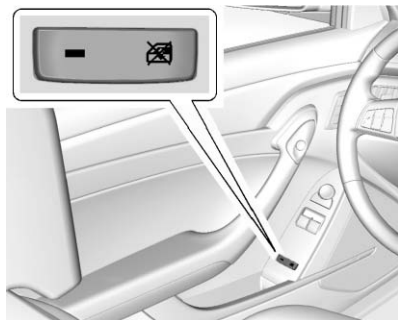

Coupe Shown, Sedan/Wagon Similar

 **(Window Lockout):** This feature prevents the rear passenger windows from operating, except from the driver position.

Press  to activate the rear window lockout switch. The indicator light comes on when activated.

Press  again to deactivate the lockout switch.

Sun Visors

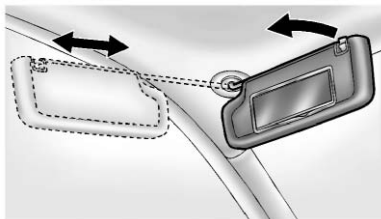

Pull the sun visor down to block glare. If equipped, detach the sun visor from the center mount to pivot to the side window or to extend along the rod.

Roof

Sunroof

If the vehicle has a power sunroof it will only operate when the ignition is in ON/RUN or ACC/ACCESSORY, or when Retained Accessory Power (RAP) is active. See *Retained Accessory Power (RAP)* on page 9-22.

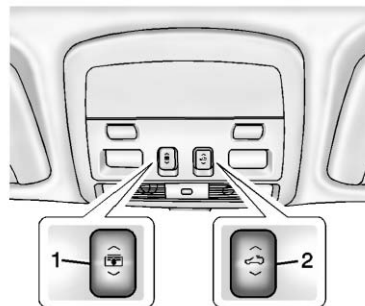

The driver side switch (1) operates the sunshade.

Open/Close: Press and hold the front or rear of the switch (1) to open or close the sunshade.

Express Open/Express Close: Press and release the rear or front of the switch (1) to express open or express close the sunshade. To stop the sunshade partway, press the switch (1) a second time.

The sunshade will open automatically with the sunroof, but can also be opened manually.

The passenger side switch (2) operates the sunroof.

Vent: Coupe only, press and hold the front of the switch (2) to vent the sunroof. The sunshade will automatically open approximately 38 cm (15 in). Press and hold the rear of the switch (2) to close the sunroof vent.

Express Open/Express Close: Press and release the rear or front of the switch (2) to express open or express close the sunroof. To stop the sunroof partway, press the switch (2) a second time.

Comfort Stop: The sunroof has a comfort stop feature that stops the sunroof from opening to the full-open position. Press the rear of the sunroof switch (2) to the first detent to open the sunroof to the comfort open position. Press the rear of the switch (2) again to fully open the sunroof.

Anti-Pinch Feature

If an object is in the path of the sunroof/sunshade when it is closing, the anti-pinch feature will detect the object and stop the sunroof/sunshade from closing at the point of the obstruction. The sunroof/sunshade will then return to the full-open position. To close the sunroof/sunshade, see "Express-Close" earlier in this section.

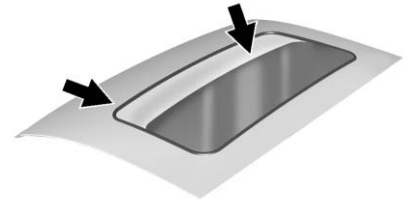

Dirt and debris may collect on the sunroof seal or in the track. This could cause an issue with sunroof operation or noise. It could also plug the water drainage system. Periodically open the sunroof and remove any obstacles or loose debris. Wipe the sunroof seal and roof sealing area using a clean cloth, mild soap, and water. Do not remove grease from the sunroof.

Seats and Restraints

Head Restraints

Head Restraints	3-2
Active Head Restraints	3-3

Front Seats

Seat Adjustment	3-3
Easy Entry Seat (Coupe Models Only)	3-3
Power Seat Adjustment	3-4
Lumbar Adjustment	3-5
Thigh Support Adjustment	3-6
Reclining Seatbacks	3-6
Memory Seats	3-7
Heated and Ventilated Front Seats	3-9

Rear Seats

Rear Seats	3-11
------------------	------

Safety Belts

Safety Belts	3-12
How to Wear Safety Belts Properly	3-13
Lap-Shoulder Belt	3-14
Safety Belt Use During Pregnancy	3-18
Safety Belt Extender	3-19
Safety System Check	3-19
Safety Belt Care	3-19
Replacing Safety Belt System Parts after a Crash	3-19

Airbag System

Airbag System	3-20
Where Are the Airbags?	3-22
When Should an Airbag Inflate?	3-23
What Makes an Airbag Inflate?	3-24
How Does an Airbag Restrain?	3-24
What Will You See after an Airbag Inflates?	3-25

Passenger Sensing System	3-26
Servicing the Airbag-Equipped Vehicle	3-31
Adding Equipment to the Airbag-Equipped Vehicle ...	3-31
Airbag System Check	3-32
Replacing Airbag System Parts after a Crash	3-32

Child Restraints

Older Children	3-33
Infants and Young Children	3-35
Child Restraint Systems	3-38
Where to Put the Restraint ...	3-39
Lower Anchors and Tethers for Children (LATCH System)	3-41
Replacing LATCH System Parts After a Crash	3-47
Securing Child Restraints (Rear Seat)	3-47
Securing Child Restraints (Front Passenger Seat)	3-49

3-2 Seats and Restraints

Head Restraints

Front Seats

The vehicle's front seats have adjustable head restraints in the outboard seating positions.

Warning

With head restraints that are not installed and adjusted properly, there is a greater chance that occupants will suffer a neck/spinal injury in a crash. Do not drive until the head restraints for all occupants are installed and adjusted properly.



Adjust the head restraint so that the top of the restraint is at the same height as the top of the occupant's head. This position reduces the chance of a neck injury in a crash.

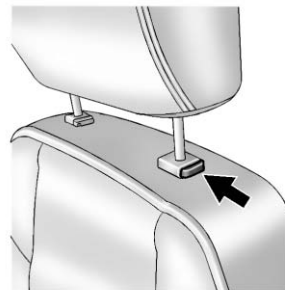

The height of the head restraint can be adjusted. Pull the head restraint up to raise it. Try to move the head restraint to make sure that it is locked in place.

To lower the head restraint, press the button, located on the top of the seatback, and push the head restraint down. Try to move the head restraint after the button is released to make sure that it is locked in place.

The front seat outboard head restraints are not designed to be removed.

Rear Seats

The vehicle's rear seats have head restraints in the outboard seating positions, but they are not adjustable.

Rear outboard head restraints are not designed to be removed.

Active Head Restraints

The vehicle has an active head restraint system in the front seating positions. These automatically tilt forward to reduce the risk of neck injury if the vehicle is hit from behind.

Front Seats

Seat Adjustment



Warning

You can lose control of the vehicle if you try to adjust a driver seat while the vehicle is moving. Adjust the driver seat only when the vehicle is not moving.

To adjust a manual seat:

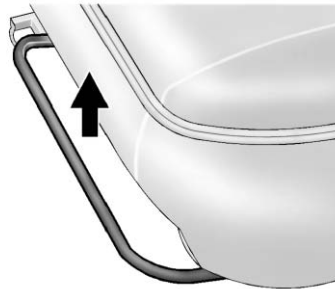

1. Lift the bar to unlock the seat.

2. Slide the seat to the desired position and release the bar.
3. Try to move the seat back and forth to be sure the seat is locked in place.

Easy Entry Seat (Coupe Models Only)

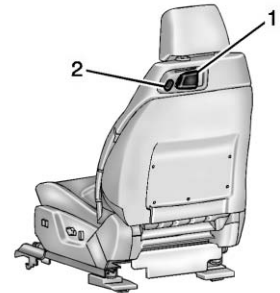

1. Folding Seatback Handle
2. Seat Adjustment Switch

3-4 Seats and Restraints

On coupe models, the front seats can be moved out of the way to make it easier to get in and out of the rear seat.

To fold the seatback, pull the handle (1) on the upper seatback. The seatback will fold forward.

To move the seat forward, press and hold the top of the switch (2) on the upper seatback. To move the seat rearward, press and hold the bottom of the switch (2). Release the switch (2) when the seat reaches the desired position.

After entering or exiting the rear seat, return the seatback to the upright position. Push and pull on the seatback to make sure it is locked.

Warning

If either seatback is not locked, it could move forward in a sudden stop or crash. That could cause injury to the person sitting there. Always push and pull on the seatbacks to be sure they are locked.

A driver seat entry/exit position can be recalled automatically using the vehicle personalization menu. See *Memory Seats* on page 3-7 and *Vehicle Personalization* on page 5-46.

Power Seat Adjustment

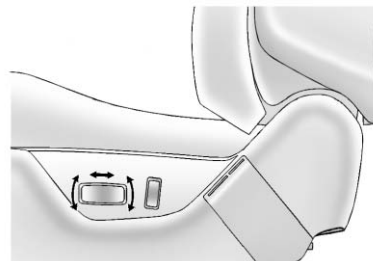

To adjust a power seat, if equipped:

- Move the seat forward or rearward by sliding the horizontal control forward or rearward.
- Raise or lower the front or rear part of the seat cushion by moving the front or rear of the horizontal control up or down.
- Raise or lower the entire seat by moving the entire horizontal control up or down.

To adjust the seatback, see “Power Reclining Seatbacks” under *Reclining Seatbacks* on page 3-6.

Lumbar Adjustment

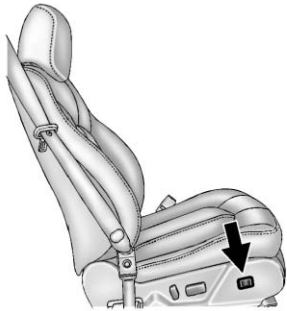

If available, hold the control on the outboard side of the seat forward or rearward to increase or decrease the lumbar support on the driver or front passenger seat.

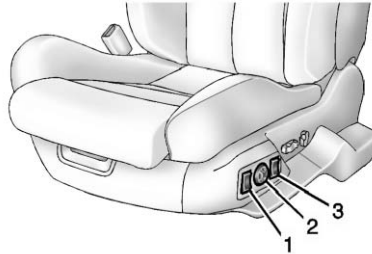

1. Seat Cushion Bolster Adjustment
2. Lumbar Support Control
3. Seatback Bolster Control

Power Lumbar

To adjust the lumbar support, if equipped:

- Press and hold the top of the control (2) to increase support to the top of the seatback and decrease support to the bottom of the seatback.

- Press and hold the bottom of the control (2) to decrease support to the top of the seatback and increase support to the bottom of the seatback.
- Press and hold the front or rear of the control (2) to increase or decrease support to the entire seatback.

Seat Cushion and Seatback Bolsters

To adjust the seat cushion and seatback bolster support, if equipped:

- Press the top or bottom of the control (1) to increase or decrease support in the seat cushion bolsters.
- Press the top or bottom of the control (3) to increase or decrease support in the seatback bolsters.

Thigh Support Adjustment

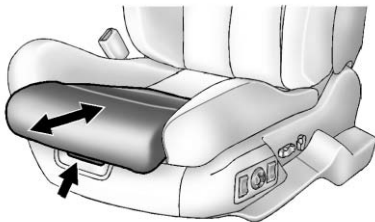

If available, adjust the manual leg extension by reaching under it, in the pocketed area. Press the button and pull or push to lengthen or shorten it. Release the button to lock it in place.

Reclining Seatbacks

Warning

Sitting in a reclined position when the vehicle is in motion can be dangerous. Even when buckled up, the safety belts cannot do their job.

The shoulder belt will not be against your body. Instead, it will be in front of you. In a crash, you could go into it, receiving neck or other injuries.

The lap belt could go up over your abdomen. The belt forces would be there, not at your pelvic bones. This could cause serious internal injuries.

For proper protection when the vehicle is in motion, have the seatback upright. Then sit well back in the seat and wear the safety belt properly.



Do not have a seatback reclined if the vehicle is moving.

Manual Reclining Seatbacks

Warning

If either seatback is not locked, it could move forward in a sudden stop or crash. That could cause injury to the person sitting there. Always push and pull on the seatbacks to be sure they are locked.

To recline a manual seatback:

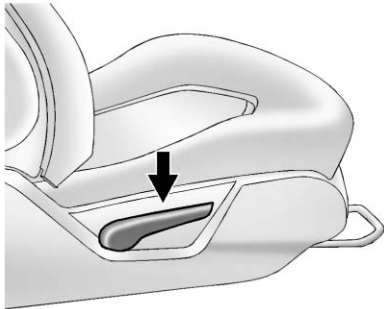

1. Lift the lever.
2. Move the seatback to the desired position, and then release the lever to lock the seatback in place.
3. Push and pull on the seatback to make sure it is locked.

To return the seatback to the upright position:

1. Lift the lever fully without applying pressure to the seatback, and the seatback will return to the upright position.

2. Push and pull on the seatback to make sure it is locked.

Power Reclining Seatbacks

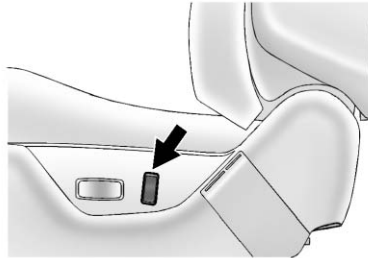

To adjust a power seatback, if equipped:

- Tilt the top of the vertical control rearward to recline.
- Tilt the top of the vertical control forward to raise.

Memory Seats

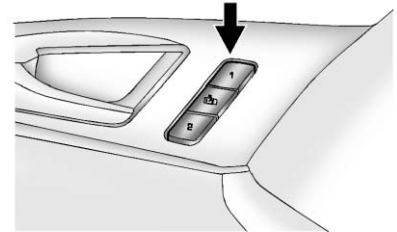

If available, memory buttons 1 and 2 on the driver door are used to save and recall memory settings for the driver seat cushion and seatback, outside mirrors, and the power tilt steering column position (if equipped).

- 1: Saves and recalls for driver 1.
- 2: Saves and recalls for driver 2.

3-8 Seats and Restraints

 **(Exit Button):** Moves the driver seat and/or power steering column to the exit position. See “Exit Recall” later in this section.

Storing Memory Positions

To save into memory:

1. Adjust the driver seat, outside mirrors, and the power steering column (if equipped) to the desired driving positions.
2. Press and hold “1” until two beeps sound.
3. Repeat for a second driver using “2.”

The vehicle comes with two Remote Keyless Entry (RKE) transmitters. Each transmitter has a number “1” or “2” on it. These numbers correspond to “1” and “2” on the driver door. The current driver is identified when  on the RKE transmitter is pressed, or when “1” or “2” on the driver door is pressed.

To recall, press and release “1” or “2.” The vehicle must be in P (Park) for an automatic transmission, or the parking brake must be applied for a manual transmission. A single beep sounds when the button is pressed. The seat, outside mirrors, and/or power steering column move to the position previously stored for the identified driver.

Automatic Entry Recall

If entry/exit recall is programmed on in the vehicle personalization menu, automatic entry recall occurs when the ignition is turned on. See *Vehicle Personalization on page 5-46*.

To stop recall movement, press one of the power seat, memory, or outside mirror buttons, or the power steering column switch (if equipped).

If something has blocked the driver seat or the steering column while recalling a memory position, the recall may stop. Remove the

obstruction; then press the appropriate control for the area that is not recalling for two seconds. Try recalling the memory position again by pressing the appropriate memory button. If the memory position is still not recalling, see your dealer for service.

Exit Recall

 **(Exit Button):** Press to move the driver seat back a preset distance and/or the power steering column (if equipped) up and forward. A single beep sounds when the exit feature activates. The vehicle must be in P (Park) for an automatic transmission, or the parking brake must be applied for a manual transmission.

If entry/exit recall is programmed on in the vehicle personalization menu, automatic seat and/or steering column movement occurs upon leaving the vehicle, if the following conditions are met. See *Vehicle Personalization on page 5-46*.

On vehicles with Remote Keyless Entry (RKE), automatic exit recall movements occur when the ignition key is removed.

On vehicles with Remote Keyless Access, automatic exit recall movements occur when the following steps are completed:

1. The ignition is turned on for vehicles with an automatic transmission, or the engine is started on vehicles with a manual transmission.
2. The automatic transmission is shifted out of P (Park), or the parking brake is released on vehicles with a manual transmission.
3. The automatic transmission is shifted back into P (Park), or the parking brake is re-engaged on vehicles with a manual transmission.

4. The ignition is turned off.
5. The driver door is opened.

Steps 2 and 3 are intended to reflect that the vehicle has been moved. If the vehicle is not moved or the steps above are not performed, automatic exit recall movement will not occur. In this case, press  to activate exit recall movements.

If something has blocked the driver seat while recalling the exit position, the recall may stop. Remove the obstruction; then press and hold the power seat control rearward for two seconds. Try recalling the exit position again. If the exit position is still not recalling, see your dealer for service.

Heated and Ventilated Front Seats

Warning

If you cannot feel temperature change or pain to the skin, the seat heater may cause burns. To reduce the risk of burns, people with such a condition should use care when using the seat heater, especially for long periods of time. Do not place anything on the seat that insulates against heat, such as a blanket, cushion, cover, or similar item. This may cause the seat heater to overheat. An overheated seat heater may cause a burn or may damage the seat.

3-10 Seats and Restraints

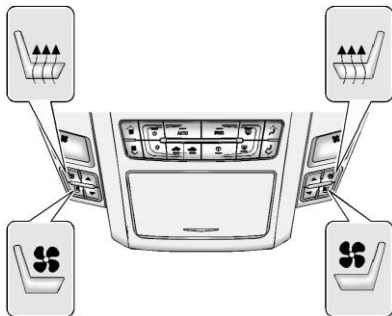

Heated and Ventilated Seat Buttons Shown, Heated Seat Buttons Similar

If available, the buttons are on the climate control panel. To operate, the ignition must be on.

 **(Heated Seat):** Press to heat the seat.

 **(Ventilated Seat):** If available, press to ventilate the seat. A ventilated seat has a fan that pulls or pushes air through the seat. The air is not cooled.

Press the button once for the highest setting. With each press of the button, the seat will change to the next lower setting, and then to the off setting. The lights on the climate control display indicate three for the highest setting and one for the lowest.

The passenger seat may take longer to heat up.

The heated and/or ventilated seats are canceled after the ignition is turned off.

Remote Start Heated Seats

During a remote start, the heated seats may turn on, depending upon the outside temperature. They are canceled when the ignition is turned on. Press the button to use the heated seats after the vehicle is started.

The indicator lights on the climate control display do not turn on during a remote start.

The temperature performance of an unoccupied seat may be reduced.

See *Remote Vehicle Start* on page 2-11.

Rear Seats

⚠ Caution

Folding a rear seat with the safety belts still fastened may cause damage to the seat or the safety belts. Always unbuckle the safety belts and return them to their normal stowed position before folding a rear seat.

The vehicle may have a split folding rear seat.

Sedan or Coupe

To lower one or both of the rear seatbacks:

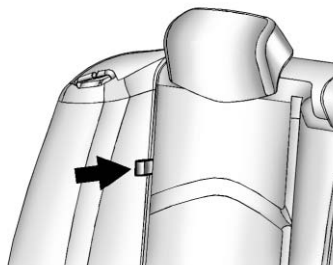

1. Pull forward on the tab, on the outboard side of the seatback, to unlock the seatback.
2. Fold the seatback down. This allows access to the trunk.

See *Trunk* on page 2-17.

Wagon

To lower one or both of the rear seatbacks:

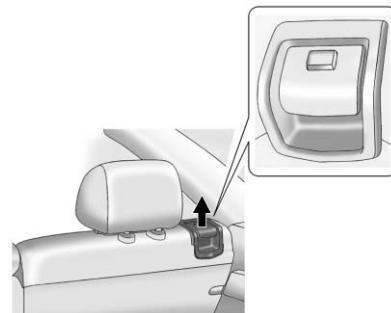

1. Pull on the lever, on the top outboard side of the seatback, to unlock the seatback.
2. Fold the seatback down.

3-12 Seats and Restraints

To return a seatback to the upright position:

Warning

If either seatback is not locked, it could move forward in a sudden stop or crash. That could cause injury to the person sitting there. Always push and pull on the seatbacks to be sure they are locked.

1. Lift the seatback up and push it back into place.
2. Make sure the seatback is locked into place by pushing and pulling on it.
3. Repeat Steps 1 and 2 for the other seatback.

When the seatback is not in use, it should be kept in the upright, locked position.

Safety Belts

This section of the manual describes how to use safety belts properly. It also describes some things not to do with safety belts.

Warning

Do not let anyone ride where a safety belt cannot be worn properly. In a crash, if you or your passenger(s) are not wearing safety belts, injuries can be much worse than if you are wearing safety belts. You can be seriously injured or killed by hitting things inside the vehicle harder or by being ejected from the vehicle. In addition, anyone who is not buckled up can strike other passengers in the vehicle.

(Continued)

Warning (Continued)

It is extremely dangerous to ride in a cargo area, inside or outside of a vehicle. In a collision, passengers riding in these areas are more likely to be seriously injured or killed. Do not allow passengers to ride in any area of the vehicle that is not equipped with seats and safety belts.

Always wear a safety belt, and check that all passenger(s) are restrained properly too.

This vehicle has indicators as a reminder to buckle the safety belts. See *Safety Belt Reminders on page 5-16*.

Why Safety Belts Work

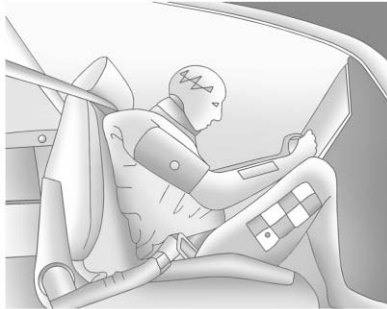

When riding in a vehicle, you travel as fast as the vehicle does. If the vehicle stops suddenly, you keep going until something stops you. It could be the windshield, the instrument panel, or the safety belts!

When you wear a safety belt, you and the vehicle slow down together. There is more time to stop because you stop over a longer distance and, when worn properly, your strongest bones take the forces from the

safety belts. That is why wearing safety belts makes such good sense.

Questions and Answers About Safety Belts

Q: Will I be trapped in the vehicle after a crash if I am wearing a safety belt?

A: You *could* be — whether you are wearing a safety belt or not. Your chance of being conscious during and after a crash, so you *can* unbuckle and get out, is *much* greater if you are belted.

Q: If my vehicle has airbags, why should I have to wear safety belts?

A: Airbags are supplemental systems only; so they work *with* safety belts — not instead of them. Whether or not an airbag is provided, all occupants still have to buckle up to get the most protection.

Also, in nearly all states and in all Canadian provinces, the law requires wearing safety belts.

How to Wear Safety Belts Properly

This section is only for people of adult size.

There are special things to know about safety belts and children. And there are different rules for smaller children and infants. If a child will be riding in the vehicle, see *Older Children on page 3-33* or *Infants and Young Children on page 3-35*. Follow those rules for everyone's protection.

It is very important for all occupants to buckle up. Statistics show that unbelted people are hurt more often in crashes than those who are wearing safety belts.

3-14 Seats and Restraints

There are important things to know about wearing a safety belt properly.

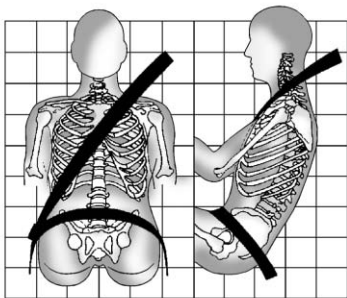

- Sit up straight and always keep your feet on the floor in front of you.
- Always use the correct buckle for your seating position.
- Wear the lap part of the belt low and snug on the hips, just touching the thighs. In a crash, this applies force to the strong pelvic bones and you would be less likely to slide under the lap belt. If you slid under it, the belt

would apply force on your abdomen. This could cause serious or even fatal injuries.

- Wear the shoulder belt over the shoulder and across the chest. These parts of the body are best able to take belt restraining forces. The shoulder belt locks if there is a sudden stop or crash.

Warning

You can be seriously injured, or even killed, by not wearing your safety belt properly.

- Never allow the lap or shoulder belt to become loose or twisted.
- Never wear the shoulder belt under both arms or behind your back.
- Never route the lap or shoulder belt over an armrest.

Lap-Shoulder Belt

All seating positions in the vehicle have a lap-shoulder belt.

The following instructions explain how to wear a lap-shoulder belt properly.

1. Adjust the seat, if the seat is adjustable, so you can sit up straight. To see how, see “Seats” in the Index.
2. Pick up the latch plate and pull the belt across you. Do not let it get twisted.

The lap-shoulder belt may lock if you pull the belt across you very quickly. If this happens, let the belt go back slightly to unlock it. Then pull the belt across you more slowly.

If the shoulder portion of a passenger belt is pulled out all the way, the child restraint locking feature may be engaged. If this happens, let the belt go back all the way and start again.



3. Push the latch plate into the buckle until it clicks.

Pull up on the latch plate to make sure it is secure. If the belt is not long enough, see *Safety Belt Extender on page 3-19*.

Position the release button on the buckle so that the safety belt could be quickly unbuckled if necessary.

4. If equipped with a shoulder belt height adjuster, move it to the height that is right for you. See

“Shoulder Belt Height Adjuster” later in this section for use and important safety information.

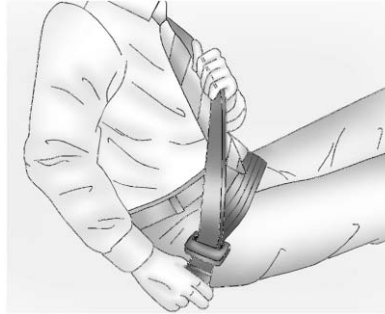

5. To make the lap part tight, pull up on the shoulder belt.

It may be necessary to pull stitching on the safety belt through the latch plate to fully tighten the lap belt on smaller occupants.

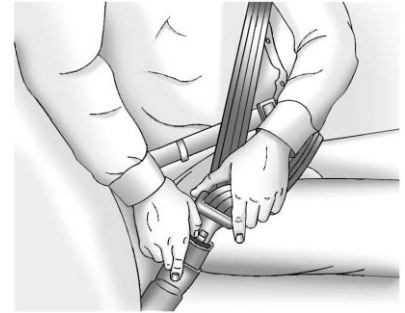

To unlatch the belt, push the button on the buckle. The belt should return to its stowed position.

Before a door is closed, be sure the safety belt is out of the way. If a door is slammed against a safety belt, damage can occur to both the safety belt and the vehicle.

Shoulder Belt Height Adjuster (Sedan and Wagon)

The vehicle has a shoulder belt height adjuster for the driver and right front passenger seating positions.

3-16 Seats and Restraints

Adjust the guide so the shoulder portion of the belt is on the shoulder and not falling off of it. The belt should be close to, but not contacting, the neck. Improper shoulder belt height adjustment could reduce the effectiveness of the safety belt in a crash. See *How to Wear Safety Belts Properly* on page 3-13.

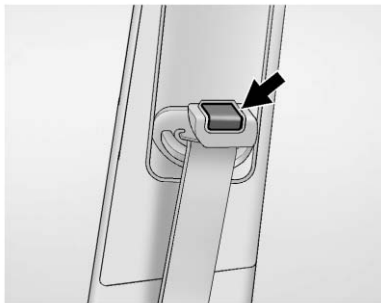

Push down on the release button and move the height adjuster to the desired position. The adjuster can be moved up by pushing up on the shoulder belt guide.

After the height adjuster is set to the desired position, try to move it down without pressing the release button to make sure it has locked into position.

Safety Belt Pretensioners

This vehicle has safety belt pretensioners for front outboard occupants. Although the safety belt pretensioners cannot be seen, they are part of the safety belt assembly. They can help tighten the safety belts during the early stages of a moderate to severe frontal or near frontal crash if the threshold conditions for pretensioner activation are met. And, if the vehicle has side impact airbags, safety belt pretensioners can help tighten the safety belts in a side or rear crash or rollover event.

Pretensioners work only once. If the pretensioners activate in a crash, the pretensioners and possibly other parts of the safety belt system will need to be replaced. See *Replacing Safety Belt System Parts after a Crash* on page 3-19.

Rear Safety Belt Comfort Guides

This vehicle may have rear shoulder belt comfort guides. If not, they are available through your dealer. The guides may provide added safety belt comfort for older children who have outgrown booster seats and for some adults. When installed and properly adjusted, the comfort guide positions the shoulder belt away from the neck and head.

Here is how to install a comfort guide to the safety belt:

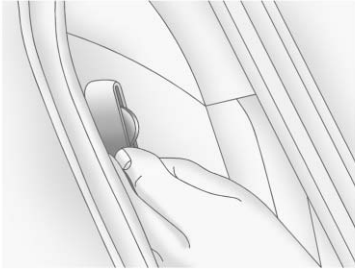

1. Pull the elastic cord out from between the edge of the seatback and the interior body to remove the guide from its storage clip.

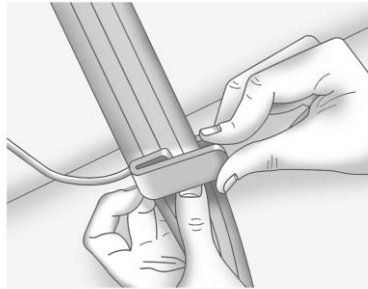

2. Place the guide over the belt and insert the two edges of the belt into the slots of the guide.

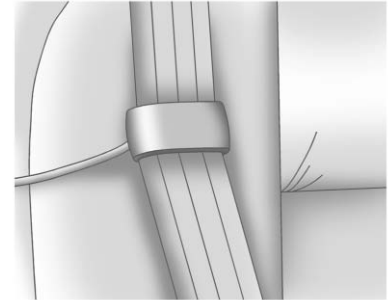

3. Be sure that the belt is not twisted and it lies flat. The elastic cord must be under the belt and the guide on top.

Warning

A safety belt that is not properly worn may not provide the protection needed in a crash. The person wearing the belt could be seriously injured. The shoulder belt should go over the shoulder and across the chest. These parts of the body are best able to take belt restraining forces.



4. Buckle, position, and release the safety belt as described previously in this section. Make sure the shoulder portion of the belt is on the shoulder and not falling off of it. The belt should be close to, but not contacting, the neck.

To remove and store the comfort guide, squeeze the belt edges together so that the safety belt can be removed from the guide. Pull the guide upward to expose its storage clip, and then slide the guide onto the clip. Turn the guide and clip inward and slide them in between the seatback and the interior body, leaving only the loop of the elastic cord exposed.

Safety Belt Use During Pregnancy

Safety belts work for everyone, including pregnant women. Like all occupants, they are more likely to be seriously injured if they do not wear safety belts.



A pregnant woman should wear a lap-shoulder belt, and the lap portion should be worn as low as possible, below the rounding, throughout the pregnancy.

The best way to protect the fetus is to protect the mother. When a safety belt is worn properly, it is more likely that the fetus will not be hurt in a crash. For pregnant women, as for anyone, the key to making safety belts effective is wearing them properly.

Safety Belt Extender

If the vehicle's safety belt will fasten around you, you should use it.

But if a safety belt is not long enough, your dealer will order you an extender. When you go in to order it, take the heaviest coat you will wear, so the extender will be long enough for you. To help avoid personal injury, do not let someone else use it, and use it only for the seat it is made to fit. The extender has been designed for adults. Never use it for securing child seats. To wear it, attach it to the regular safety belt. See the instruction sheet that comes with the extender.

Safety System Check

Now and then, check that the safety belt reminder light, safety belts, buckles, latch plates, retractors, and anchorages are all working properly. Look for any other loose or damaged safety belt system parts that might keep a safety belt system from doing its job. See your dealer

to have it repaired. Torn or frayed safety belts may not protect you in a crash. They can rip apart under impact forces. If a belt is torn or frayed, get a new one right away.

Make sure the safety belt reminder light is working. See *Safety Belt Reminders on page 5-16*.

Keep safety belts clean and dry. See *Safety Belt Care on page 3-19*.

Safety Belt Care

Keep belts clean and dry.

Warning

Do not bleach or dye safety belts. It may severely weaken them. In a crash, they might not be able to provide adequate protection. Clean safety belts only with mild soap and lukewarm water.

Replacing Safety Belt System Parts after a Crash

Warning

A crash can damage the safety belt system in the vehicle. A damaged safety belt system may not properly protect the person using it, resulting in serious injury or even death in a crash. To help make sure the safety belt systems are working properly after a crash, have them inspected and any necessary replacements made as soon as possible.

After a minor crash, replacement of safety belts may not be necessary. But the safety belt assemblies that were used during any crash may have been stressed or damaged.

See your dealer to have the safety belt assemblies inspected or replaced.

New parts and repairs may be necessary even if the safety belt system was not being used at the time of the crash.

Have the safety belt pretensioners checked if the vehicle has been in a crash, or if the airbag readiness light stays on after you start the vehicle or while you are driving. See *Airbag Readiness Light on page 5-17*.

Airbag System

The vehicle has the following airbags:

- A frontal airbag for the driver.
- A frontal airbag for the outboard front passenger.
- A seat-mounted side impact airbag for the driver.
- A seat-mounted side impact airbag for the outboard front passenger.
- A roof-rail airbag for the driver and the passenger seated directly behind the driver.
- A roof-rail airbag for the outboard front passenger and the passenger seated directly behind the outboard front passenger.

All vehicle airbags have the word AIRBAG on the trim or on a label near the deployment opening.

For frontal airbags, the word AIRBAG is on the center of the steering wheel for the driver and on the instrument panel for the front outboard passenger.

For seat-mounted side impact airbags, the word AIRBAG is on the side of the seatback closest to the door.

For roof-rail airbags, the word AIRBAG is on the ceiling or trim.

Airbags are designed to supplement the protection provided by safety belts. Even though today's airbags are also designed to help reduce the risk of injury from the force of an inflating bag, all airbags must inflate very quickly to do their job.

Here are the most important things to know about the airbag system:

⚠ Warning

You can be severely injured or killed in a crash if you are not wearing your safety belt, even with airbags. Airbags are designed to work with safety belts, not replace them. Also, airbags are not designed to inflate in every crash. In some crashes safety belts are the only restraint. See *When Should an Airbag Inflate?* on page 3-23.

Wearing your safety belt during a crash helps reduce the chance of hitting things inside the vehicle or being ejected from it. Airbags are “supplemental restraints” to the safety belts. Everyone in the vehicle should wear a safety belt properly, whether or not there is an airbag for that person.

⚠ Warning

Because airbags inflate with great force and faster than the blink of an eye, anyone who is up against, or very close to any airbag when it inflates can be seriously injured or killed. Do not sit unnecessarily close to any airbag, as you would be if sitting on the edge of the seat or leaning forward. Safety belts help keep you in position before and during a crash. Always wear a safety belt, even with airbags. The driver should sit as far back as possible while still maintaining control of the vehicle.

Occupants should not lean on or sleep against the door or side windows in seating positions with seat-mounted side impact airbags and/or roof-rail airbags.

⚠ Warning

Children who are up against, or very close to, any airbag when it inflates can be seriously injured or killed. Always secure children properly in the vehicle. To read how, see *Older Children on page 3-33* or *Infants and Young Children on page 3-35*.



There is an airbag readiness light on the instrument cluster, which shows the airbag symbol. The system checks the airbag electrical system for malfunctions. The light tells you if there is an electrical problem. See *Airbag Readiness Light on page 5-17* for more information.

Where Are the Airbags?



The driver's frontal airbag is in the center of the steering wheel.



The front outboard passenger frontal airbag is in the passenger side instrument panel.



Driver Side Shown, Passenger Side Similar

The driver and front outboard passenger seat-mounted side impact airbags are in the side of the seatbacks closest to the door.



Driver Side Shown, Passenger Side Similar

The roof-rail airbags for the driver, front outboard passenger, and second row outboard passengers are in the ceiling above the side windows.

Warning

If something is between an occupant and an airbag, the airbag might not inflate properly or it might force the object into

(Continued)

Warning (Continued)

that person causing severe injury or even death. The path of an inflating airbag must be kept clear. Do not put anything between an occupant and an airbag, and do not attach or put anything on the steering wheel hub or on or near any other airbag covering.

Do not use seat accessories that block the inflation path of a seat-mounted side impact airbag.

Never secure anything to the roof of a vehicle with roof-rail airbags by routing a rope or tie-down through any door or window opening. If you do, the path of an inflating roof-rail airbag will be blocked.

When Should an Airbag Inflate?

This vehicle is equipped with airbags. See *Airbag System on page 3-20*. Airbags are designed to inflate if the impact exceeds the specific airbag system's deployment threshold. Deployment thresholds are used to predict how severe a crash is likely to be in time for the airbags to inflate and help restrain the occupants. The vehicle has electronic sensors that help the airbag system determine the severity of the impact. Deployment thresholds can vary with specific vehicle design.

Frontal airbags are designed to inflate in moderate to severe frontal or near frontal crashes to help reduce the potential for severe injuries, mainly to the driver's or front outboard passenger's head and chest.

Whether the frontal airbags will or should inflate is not based primarily on how fast the vehicle is traveling.

3-24 Seats and Restraints

It depends on what is hit, the direction of the impact, and how quickly the vehicle slows down.

Frontal airbags may inflate at different crash speeds depending on whether the vehicle hits an object straight on or at an angle, and whether the object is fixed or moving, rigid or deformable, narrow or wide.

Frontal airbags are not intended to inflate during vehicle rollovers, rear impacts, or in many side impacts.

In addition, the vehicle has advanced technology frontal airbags. Advanced technology frontal airbags adjust the restraint according to crash severity.

Seat-mounted side impact airbags are designed to inflate in moderate to severe side crashes depending on the location of the impact.

Seat-mounted side impact airbags are not designed to inflate in frontal impacts, near frontal impacts, rollovers, or rear impacts.

A seat-mounted side impact airbag is designed to inflate on the side of the vehicle that is struck.

Roof-rail airbags are designed to inflate in moderate to severe side crashes depending on the location of the impact. In addition, these roof-rail airbags are designed to inflate during a rollover or in a severe frontal impact. Roof-rail airbags are not designed to inflate in rear impacts. Both roof-rail airbags will inflate when either side of the vehicle is struck, if the sensing system predicts that the vehicle is about to roll over on its side, or in a severe frontal impact.

In any particular crash, no one can say whether an airbag should have inflated simply because of the vehicle damage or repair costs.

What Makes an Airbag Inflate?

In a deployment event, the sensing system sends an electrical signal triggering a release of gas from the inflator. Gas from the inflator fills the airbag causing the bag to break out of the cover. The inflator, the airbag, and related hardware are all part of the airbag module.

For airbag locations, see *Where Are the Airbags?* on page 3-22.

How Does an Airbag Restrain?

In moderate to severe frontal or near frontal collisions, even belted occupants can contact the steering wheel or the instrument panel. In moderate to severe side collisions, even belted occupants can contact the inside of the vehicle.

Airbags supplement the protection provided by safety belts by distributing the force of the impact more evenly over the occupant's body.

Rollover capable roof-rail airbags are designed to help contain the head and chest of occupants in the outboard seating positions in the first and second rows. The rollover capable roof-rail airbags are designed to help reduce the risk of full or partial ejection in rollover events, although no system can prevent all such ejections.

But airbags would not help in many types of collisions, primarily because the occupant's motion is not toward those airbags. See *When Should an Airbag Inflate?* on page 3-23.

Airbags should never be regarded as anything more than a supplement to safety belts.

What Will You See after an Airbag Inflates?

After the frontal airbags and seat-mounted side impact airbags inflate, they quickly deflate, so quickly that some people may not even realize an airbag inflated. Roof-rail airbags may still be at least partially inflated for some time after they inflate. Some components of the airbag module may be hot for several minutes. For location of the airbags, see *Where Are the Airbags?* on page 3-22.

The parts of the airbag that come into contact with you may be warm, but not too hot to touch. There may be some smoke and dust coming from the vents in the deflated airbags. Airbag inflation does not prevent the driver from seeing out of the windshield or being able to steer the vehicle, nor does it prevent people from leaving the vehicle.

Warning

When an airbag inflates, there may be dust in the air. This dust could cause breathing problems for people with a history of asthma or other breathing trouble. To avoid this, everyone in the vehicle should get out as soon as it is safe to do so. If you have breathing problems but cannot get out of the vehicle after an airbag inflates, then get fresh air by opening a window or a door. If you experience breathing problems following an airbag deployment, you should seek medical attention.

The vehicle has a feature that may automatically unlock the doors, turn on the interior lamps, turn on the hazard warning flashers, and shut off the fuel system after the airbags inflate.

3-26 Seats and Restraints

You can lock the doors, turn off the interior lamps, and turn off the hazard warning flashers by using the controls for those features.

Warning

A crash severe enough to inflate the airbags may have also damaged important functions in the vehicle, such as the fuel system, brake and steering systems, etc. Even if the vehicle appears to be drivable after a moderate crash, there may be concealed damage that could make it difficult to safely operate the vehicle.

Use caution if you should attempt to restart the engine after a crash has occurred.

In many crashes severe enough to inflate the airbag, windshields are broken by vehicle deformation. Additional windshield breakage may also occur from the front outboard passenger airbag.

- Airbags are designed to inflate only once. After an airbag inflates, you will need some new parts for the airbag system. If you do not get them, the airbag system will not be there to help protect you in another crash. A new system will include airbag modules and possibly other parts. The service manual for the vehicle covers the need to replace other parts.
- The vehicle has a crash sensing and diagnostic module which records information after a crash. See *Vehicle Data Recording and Privacy* on page 13-14 and *Event Data Recorders* on page 13-14.

- Let only qualified technicians work on the airbag systems. Improper service can mean that an airbag system will not work properly. See your dealer for service.

Passenger Sensing System

The vehicle has a passenger sensing system for the front outboard passenger position. The passenger airbag status indicator will be visible on the instrument panel when the vehicle is started.



United States



Canada and Mexico

The words ON and OFF, or the symbol for on and off, are visible during the system check. When the system check is complete, either the word ON or OFF, or the symbol for on or off, will be visible. See *Passenger Airbag Status Indicator* on page 5-18.

The passenger sensing system turns off the front outboard passenger frontal airbag under certain conditions. No other airbag is affected by the passenger sensing system.

The passenger sensing system works with sensors that are part of the front outboard passenger seat. The sensors are designed to detect the presence of a properly-seated

occupant and determine if the front outboard passenger frontal airbag should be allowed to inflate or not.

According to accident statistics, children are safer when properly secured in a rear seat in the correct child restraint for their weight and size.

Whenever possible, children age 12 and under should be secured in a rear seating position.

Never put a rear-facing child seat in the front. This is because the risk to the rear-facing child is so great, if the airbag inflates.

Warning

A child in a rear-facing child restraint can be seriously injured or killed if the passenger frontal airbag inflates. This is because the back of the rear-facing child restraint would be very close to the inflating airbag. A child in a

(Continued)

Warning (Continued)

forward-facing child restraint can be seriously injured or killed if the passenger frontal airbag inflates and the passenger seat is in a forward position.

Even if the passenger sensing system has turned off the passenger frontal airbag, no system is fail-safe. No one can guarantee that an airbag will not inflate under some unusual circumstance, even though the airbag is off.

Secure rear-facing child restraints in a rear seat, even if the airbag is off. If you secure a forward-facing child restraint in the front outboard passenger seat, always move the seat as far back as it will go. It is better to secure the child restraint in a rear seat.

3-28 Seats and Restraints

The passenger sensing system is designed to turn off the front outboard passenger frontal airbag if:

- The front outboard passenger seat is unoccupied.
- The system determines that an infant is present in a child restraint.
- A front outboard passenger takes his/her weight off of the seat for a period of time.
- There is a critical problem with the airbag system or the passenger sensing system.

When the passenger sensing system has turned off the front outboard passenger frontal airbag, the off indicator will light and stay lit to remind you that the airbag is off. See *Passenger Airbag Status Indicator* on page 5-18.

The passenger sensing system is designed to turn on the front outboard passenger frontal airbag anytime the system senses that a person of adult size is sitting properly in the front outboard passenger seat.

When the passenger sensing system has allowed the airbag to be enabled, the on indicator will light and stay lit to remind you that the airbag is active.

For some children, including children in child restraints, and for very small adults, the passenger sensing system may or may not turn off the front outboard passenger frontal airbag, depending upon the person's seating posture and body build. Everyone in the vehicle who has outgrown child restraints should wear a safety belt properly — whether or not there is an airbag for that person.

Warning

If the airbag readiness light ever comes on and stays on, it means that something may be wrong with the airbag system. To help avoid injury to yourself or others, have the vehicle serviced right away. See *Airbag Readiness Light* on page 5-17 for more information, including important safety information.

If the On Indicator is Lit for a Child Restraint

The passenger sensing system is designed to turn off the front outboard passenger frontal airbag if the system determines that an infant is present in a child restraint. If a child restraint has been installed and the on indicator is lit:

1. Turn the vehicle off.
2. Remove the child restraint from the vehicle.

3. Remove any additional items from the seat such as blankets, cushions, seat covers, seat heaters, or seat massagers.
4. Reinstall the child restraint following the directions provided by the child restraint manufacturer and refer to *Securing Child Restraints (Front Passenger Seat)* on page 3-49 or *Securing Child Restraints (Rear Seat)* on page 3-47.
5. If, after reinstalling the child restraint and restarting the vehicle, the on indicator is still lit, turn the vehicle off. Then slightly recline the vehicle seatback and adjust the seat cushion, if adjustable, to make sure that the vehicle seatback is not pushing the child restraint into the seat cushion.

Also make sure the child restraint is not trapped under the vehicle head restraint. If this happens, adjust the head restraint. See *Head Restraints* on page 3-2.

6. Restart the vehicle.

The passenger sensing system may or may not turn off the airbag for a child in a child restraint depending upon the child's size. It is better to secure the child restraint in a rear seat.

If the Off Indicator is Lit for an Adult-Sized Occupant



If a person of adult size is sitting in the front outboard passenger seat, but the off indicator is lit, it could be because that person is not sitting properly in the seat. If this happens, use the following steps to allow the system to detect that person and enable the front outboard passenger frontal airbag:

1. Turn the vehicle off.

3-30 Seats and Restraints

2. Remove any additional items from the seat such as blankets, cushions, seat covers, seat heaters, or seat massagers.
3. Place the seatback in the fully upright position.
4. Have the person sit upright in the seat, centered on the seat cushion, with legs comfortably extended.
5. Restart the vehicle and have the person remain in this position for two to three minutes after the on indicator is lit.

Warning

If the front outboard passenger airbag is turned off for an adult-sized occupant, the airbag will not be able to inflate and help protect that person in a crash, resulting in an increased risk of serious injury or even death. An adult-sized occupant should not

(Continued)

Warning (Continued)

ride in the front outboard passenger seat, if the passenger airbag off indicator is lit.

Additional Factors Affecting System Operation

Safety belts help keep the passenger in position on the seat during vehicle maneuvers and braking, which helps the passenger sensing system maintain the passenger airbag status. See “Safety Belts” and “Child Restraints” in the Index for additional information about the importance of proper restraint use.

A thick layer of additional material, such as a blanket or cushion, or aftermarket equipment such as seat covers, seat heaters, and seat massagers can affect how well the passenger sensing system operates. We recommend that you not use seat covers or other

aftermarket equipment except when approved by GM for your specific vehicle. See *Adding Equipment to the Airbag-Equipped Vehicle on page 3-31* for more information about modifications that can affect how the system operates.

A wet seat can affect the performance of the passenger sensing system. Here is how:

- The passenger sensing system may turn off the passenger airbag when liquid is soaked into the seat. If this happens, the off indicator will be lit, and the airbag readiness light on the instrument panel will also be lit.
- Liquid pooled on the seat that has not soaked in may make it more likely that the passenger sensing system will turn on the passenger airbag while a child restraint or child occupant is on the seat. If the passenger airbag is turned on, the on indicator will be lit.

If the passenger seat gets wet, dry the seat immediately. If the airbag readiness light is lit, do not install a child restraint or allow anyone to occupy the seat. See *Airbag Readiness Light* on page 5-17 for important safety information.

The on indicator may be lit if an object, such as a briefcase, handbag, grocery bag, laptop or other electronic device, is put on an unoccupied seat. If this is not desired remove the object from the seat.

 **Warning**

Stowing of articles under the passenger seat or between the passenger seat cushion and seatback may interfere with the proper operation of the passenger sensing system.

Servicing the Airbag-Equipped Vehicle

Airbags affect how the vehicle should be serviced. There are parts of the airbag system in several places around the vehicle. Your dealer and the service manual have information about servicing the vehicle and the airbag system. To purchase a service manual, see *Service Publications Ordering Information* on page 13-11.

 **Warning**

For up to 10 seconds after the vehicle is turned off and the battery is disconnected, an airbag can still inflate during improper service. You can be injured if you are close to an airbag when it inflates. Avoid yellow connectors. They are probably part of the airbag system. Be sure to follow

(Continued)

Warning (Continued)

proper service procedures, and make sure the person performing work for you is qualified to do so.

Adding Equipment to the Airbag-Equipped Vehicle

Adding accessories that change the vehicle's frame, bumper system, height, front end, or side sheet metal, may keep the airbag system from working properly. The operation of the airbag system can also be affected by changing or moving any parts of the front seats, safety belts, the airbag sensing and diagnostic module, steering wheel, instrument panel, roof-rail airbag modules, ceiling headliner or pillar garnish trim, front sensors, side impact sensors, or airbag wiring.

3-32 Seats and Restraints

Your dealer and the service manual have information about the location of the airbag sensors, sensing and diagnostic module, and airbag wiring.

In addition, the vehicle has a passenger sensing system for the front outboard passenger position, which includes sensors that are part of the passenger seat. The passenger sensing system may not operate properly if the original seat trim is replaced with non-GM covers, upholstery, or trim; or with GM covers, upholstery, or trim designed for a different vehicle. Any object, such as an aftermarket seat heater or a comfort-enhancing pad or device, installed under or on top of the seat fabric, could also interfere with the operation of the passenger sensing system. This could either prevent proper deployment of the passenger airbag(s) or prevent the passenger sensing system from properly

turning off the passenger airbag(s). See *Passenger Sensing System* on page 3-26.

If the vehicle has rollover roof-rail airbags, see *Different Size Tires and Wheels* on page 10-81 for additional important information.

If you have to modify your vehicle because you have a disability and you have questions about whether the modifications will affect the vehicle's airbag system, or if you have questions about whether the airbag system will be affected if the vehicle is modified for any other reason, call Customer Assistance. See *Customer Assistance Offices* on page 13-3.

Airbag System Check

The airbag system does not need regularly scheduled maintenance or replacement. Make sure the airbag readiness light is working. See *Airbag Readiness Light* on page 5-17.

Caution

If an airbag covering is damaged, opened, or broken, the airbag may not work properly. Do not open or break the airbag coverings. If there are any opened or broken airbag coverings, have the airbag covering and/or airbag module replaced. For the location of the airbags, see *Where Are the Airbags?* on page 3-22. See your dealer for service.

Replacing Airbag System Parts after a Crash

Warning

A crash can damage the airbag systems in the vehicle. A damaged airbag system may not work properly and may not

(Continued)

Warning (Continued)

protect you and your passenger(s) in a crash, resulting in serious injury or even death. To help make sure the airbag systems are working properly after a crash, have them inspected and any necessary replacements made as soon as possible.

If an airbag inflates, you will need to replace airbag system parts. See your dealer for service.

If the airbag readiness light stays on after the vehicle is started or comes on when you are driving, the airbag system may not work properly. Have the vehicle serviced right away. See *Airbag Readiness Light on page 5-17*.

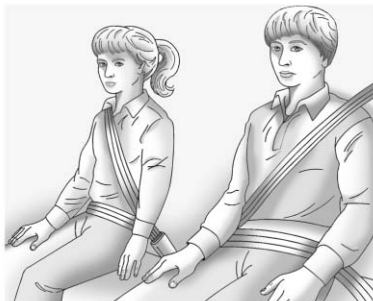
Child Restraints**Older Children**

Older children who have outgrown booster seats should wear the vehicle safety belts.

The manufacturer instructions that come with the booster seat state the weight and height limitations for that booster. Use a booster seat with a lap-shoulder belt until the child passes the fit test below:

- Sit all the way back on the seat. Do the knees bend at the seat edge? If yes, continue. If no, return to the booster seat.
- Buckle the lap-shoulder belt. Does the shoulder belt rest on the shoulder? If yes, continue. If no, try using the rear safety belt comfort guide. See “Rear Safety Belt Comfort Guides” under *Lap-Shoulder Belt on page 3-14*. If the shoulder belt still does not rest on the shoulder, then return to the booster seat.
- Does the lap belt fit low and snug on the hips, touching the thighs? If yes, continue. If no, return to the booster seat.

3-34 Seats and Restraints

- Can proper safety belt fit be maintained for the length of the trip? If yes, continue. If no, return to the booster seat.

Q: What is the proper way to wear safety belts?

A: An older child should wear a lap-shoulder belt and get the additional restraint a shoulder belt can provide. The shoulder belt should not cross the face or neck. The lap belt should fit snugly below the hips, just touching the top of the thighs. This applies belt force to the child's pelvic bones in a crash. It should never be worn over the abdomen, which could cause severe or even fatal internal injuries in a crash.

Also see "Rear Safety Belt Comfort Guides" under *Lap-Shoulder Belt* on page 3-14.

According to accident statistics, children are safer when properly restrained in a rear seating position.

In a crash, children who are not buckled up can strike other people who are buckled up, or can be thrown out of the vehicle. Older children need to use safety belts properly.

 **Warning**

Never allow more than one child to wear the same safety belt. The safety belt cannot properly spread the impact forces. In a crash, they can be crushed together and seriously injured. A safety belt must be used by only one person at a time.



 **Warning**

Never allow a child to wear the safety belt with the shoulder belt behind their back. A child can be seriously injured by not wearing the lap-shoulder belt properly. In a crash, the child would not be restrained by the shoulder belt. The child could move too far forward increasing the chance of head and neck injury. The child might also slide under the lap

(Continued)

Warning (Continued)

belt. The belt force would then be applied right on the abdomen. That could cause serious or fatal injuries. The shoulder belt should go over the shoulder and across the chest.



Infants and Young Children

Everyone in a vehicle needs protection! This includes infants and all other children. Neither the distance traveled nor the age and size of the traveler changes the need, for everyone, to use safety restraints. In fact, the law in every state in the United States and in every Canadian province says children up to some age must be restrained while in a vehicle.

Warning

Children can be seriously injured or strangled if a shoulder belt is wrapped around their neck and the safety belt continues to tighten. Never leave children unattended in a vehicle and never allow children to play with the safety belts.

Every time infants and young children ride in vehicles, they should have the protection provided by appropriate child restraints. Neither the vehicle's safety belt system nor its airbag system is designed for them.

Children who are not restrained properly can strike other people, or can be thrown out of the vehicle.

3-36 Seats and Restraints

Warning

Never hold an infant or a child while riding in a vehicle. Due to crash forces, an infant or a child will become so heavy it is not possible to hold it during a crash. For example, in a crash at only 40 km/h (25 mph), a 5.5 kg (12 lb) infant will suddenly become a 110 kg (240 lb) force on a person's arms. An infant should be secured in an appropriate restraint.



Warning

Children who are up against, or very close to, any airbag when it inflates can be seriously injured or killed. Never put a rear-facing child restraint in the right front seat. Secure a rear-facing child restraint in a rear seat. It is also better to secure a forward-facing child restraint in a rear seat. If you must secure a forward-facing child restraint in the right front

(Continued)

Warning (Continued)

seat, always move the front passenger seat as far back as it will go.



Q: What are the different types of add-on child restraints?

A: Add-on child restraints, which are purchased by the vehicle owner, are available in four basic types. Selection of a particular restraint should take into consideration not only the child's

weight, height, and age but also whether or not the restraint will be compatible with the motor vehicle in which it will be used.

For most basic types of child restraints, there are many different models available. When purchasing a child restraint, be sure it is designed to be used in a motor vehicle. If it is, the restraint will have a label saying that it meets federal motor vehicle safety standards.

The restraint manufacturer instructions that come with the restraint state the weight and height limitations for a particular child restraint. In addition, there are many kinds of restraints available for children with special needs.

 **Warning**

To reduce the risk of neck and head injury during a crash, infants need complete support. In a crash, if an infant is in a rear-facing child restraint, the crash forces can be distributed across the strongest part of an infant's body, the back and shoulders. Infants should always be secured in rear-facing child restraints.

 **Warning**

A young child's hip bones are still so small that the vehicle's regular safety belt may not remain low on the hip bones, as it should. Instead, it may settle up around the child's abdomen. In a crash, the belt would apply force on a body area that is unprotected by any bony structure. This alone could cause serious or fatal injuries. To reduce the risk of serious or fatal injuries during a crash, young children should always be secured in appropriate child restraints.

Child Restraint Systems

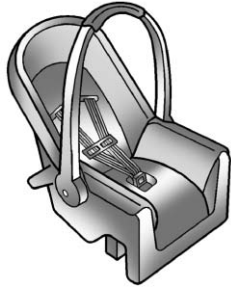

Rear-Facing Infant Seat

A rear-facing infant seat provides restraint with the seating surface against the back of the infant.

The harness system holds the infant in place and, in a crash, acts to keep the infant positioned in the restraint.



Forward-Facing Child Seat

A forward-facing child seat provides restraint for the child's body with the harness.

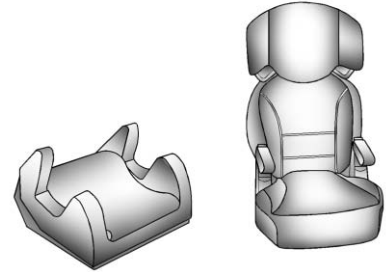

Booster Seats

A booster seat is a child restraint designed to improve the fit of the vehicle's safety belt system. A booster seat can also help a child to see out the window.

Securing an Add-On Child Restraint in the Vehicle

Warning

A child can be seriously injured or killed in a crash if the child restraint is not properly secured in the vehicle. Secure the child restraint properly in the vehicle using the vehicle safety belt or LATCH system, following the instructions that came with that child restraint and the instructions in this manual.

To help reduce the chance of injury, the child restraint must be secured in the vehicle. Child restraint systems must be secured in vehicle seats by lap belts or the lap belt portion of a lap-shoulder belt, or by the LATCH system. See *Lower Anchors and Tethers for Children (LATCH System)* on page 3-41.

Children can be endangered in a crash if the child restraint is not properly secured in the vehicle.

When securing an add-on child restraint, refer to the instructions that come with the restraint which may be on the restraint itself or in a booklet, or both, and to this manual. The child restraint instructions are important, so if they are not available, obtain a replacement copy from the manufacturer.

Keep in mind that an unsecured child restraint can move around in a collision or sudden stop and injure people in the vehicle. Be sure to properly secure any child restraint in the vehicle — even when no child is in it.

In some areas of the United States and Canada, Certified Child Passenger Safety Technicians (CPSTs) are available to inspect and demonstrate how to correctly use and install child restraints. In the U.S., refer to the National Highway Traffic Safety

Administration (NHTSA) website to locate the nearest child safety seat inspection station. For CPST availability in Canada, check with Transport Canada or the Provincial Ministry of Transportation office.

Securing the Child Within the Child Restraint

Warning

A child can be seriously injured or killed in a crash if the child is not properly secured in the child restraint. Secure the child properly following the instructions that came with that child restraint.

Where to Put the Restraint

According to accident statistics, children and infants are safer when properly restrained in a child restraint system or infant restraint system secured in a rear seating position.

3-40 Seats and Restraints

Whenever possible, children aged 12 and under should be secured in a rear seating position.

Never put a rear-facing child seat in the front. This is because the risk to the rear-facing child is so great if the airbag deploys.

Warning

A child in a rear-facing child restraint can be seriously injured or killed if the front passenger airbag inflates. This is because the back of the rear-facing child restraint would be very close to the inflating airbag. A child in a forward-facing child restraint can be seriously injured or killed if the front passenger airbag inflates and the passenger seat is in a forward position.

Even if the passenger sensing system has turned off the front passenger frontal airbag, no

(Continued)

Warning (Continued)

system is fail-safe. No one can guarantee that an airbag will not deploy under some unusual circumstance, even though it is turned off.

Secure rear-facing child restraints in a rear seat, even if the airbag is off. If you secure a forward-facing child restraint in the front seat, always move the front passenger seat as far back as it will go. It is better to secure the child restraint in a rear seat.

See *Passenger Sensing System* on page 3-26 for additional information.

When securing a child restraint in a rear seating position, study the instructions that came with the child restraint to make sure it is compatible with this vehicle.

Child restraints and booster seats vary considerably in size, and some may fit in certain seating positions better than others. Always make sure the child restraint is properly secured.

Depending on where you place the child restraint and the size of the child restraint, you may not be able to access adjacent safety belt assemblies or LATCH anchors for additional passengers or child restraints. Adjacent seating positions should not be used if the child restraint prevents access to or interferes with the routing of the safety belt.

Wherever a child restraint is installed, be sure to secure the child restraint properly.

Keep in mind that an unsecured child restraint can move around in a collision or sudden stop and injure people in the vehicle. Be sure to properly secure any child restraint in the vehicle — even when no child is in it.

Lower Anchors and Tethers for Children (LATCH System)

The LATCH system secures a child restraint during driving or in a crash. LATCH attachments on the child restraint are used to attach the child restraint to the anchors in the vehicle. This system is designed to make installation of a child restraint easier.

In order to use the LATCH system in your vehicle, you need a child restraint that has LATCH attachments. LATCH-compatible rear-facing and forward-facing child seats can be properly installed using either the LATCH anchors or the vehicle's safety belts. Do not use both the safety belts and the LATCH anchorage system to secure a rear-facing or forward-facing child seat.

Booster seats use the vehicle's safety belts to secure the child in the booster seat. If the manufacturer

recommends that the booster seat be secured with the LATCH system, this can be done as long as the booster seat can be positioned properly and there is no interference with the proper positioning of the lap-shoulder belt on the child.

Make sure to follow the instructions that came with the child restraint, and also the instructions in this manual.

When installing a child restraint with a top tether, you must also use either the lower anchors or the safety belts to properly secure the child restraint. A child restraint must never be installed using only the top tether and anchor.

The LATCH anchorage system can be used until the combined weight of the child plus the child restraint is 29.5 kg (65 lbs). Use the safety belt alone instead of the LATCH anchorage system once the combined weight is more than 29.5 kg (65 lbs).

The following explains how to attach a child restraint with these attachments in the vehicle.

Not all vehicle seating positions or child restraints have lower anchors and attachments or top tether anchors and attachments.

Lower Anchors

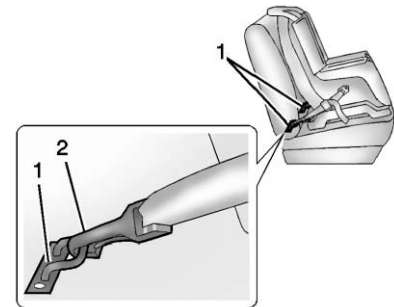

Lower anchors (1) are metal bars built into the vehicle. There are two lower anchors for each LATCH seating position that will accommodate a child restraint with lower attachments (2).

3-42 Seats and Restraints

Top Tether Anchor

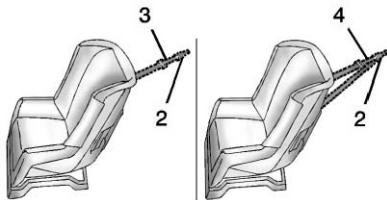

A top tether (3, 4) anchors the top of the child restraint to the vehicle. A top tether anchor is built into the vehicle. The top tether attachment (2) on the child restraint connects to the top tether anchor in the vehicle in order to reduce the forward movement and rotation of the child restraint during driving or in a crash.

The child restraint may have a single tether (3) or a dual tether (4). Either will have a single attachment (2) to secure the top tether to the anchor.

Some child restraints with top tethers are designed for use with or without the top tether being attached. Others require the top tether always to be attached. In Canada, the law requires that forward-facing child restraints have a top tether, and that the tether be attached. Be sure to read and follow the instructions for your child restraint.

Lower Anchor and Top Tether Anchor Locations



Rear Seat - Sedan or Wagon

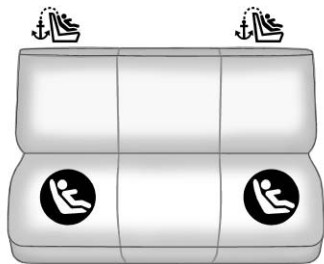

Rear Seat - Coupe

 **(Top Tether Anchor):** Seating positions with top tether anchors.

 **(Lower Anchor):** Seating positions with two lower anchors.



To assist in locating the lower anchors, each seating position with lower anchors has two labels, near the crease between the seatback and the seat cushion. For a wagon the lower anchors are beneath zippers, near the labels. Open the zippers to access the lower anchors.



To assist in locating the top tether anchors, the top tether anchor symbol is on the cover.

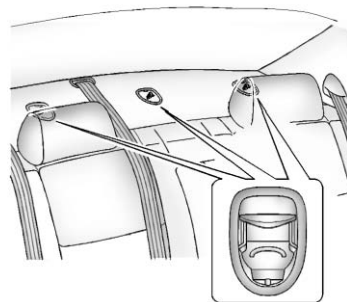

Sedan

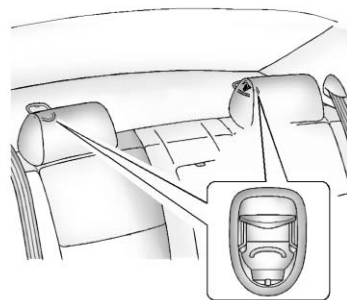

Coupe

3-44 Seats and Restraints

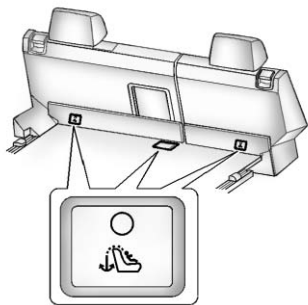

Wagon

The top tether anchors for a sedan or coupe are under the tether covers, on the rear seatback filler panel. For the wagon, the outboard top tether anchors are under the tether covers behind the rear seatback. The wagon's center top tether anchor is under the tether cover, on the vehicle floor, behind the rear seatback. Be sure to use an anchor on the same side of the vehicle as the seating position where the child restraint will be placed.

Do not secure a child restraint in a position without a top tether anchor if a national or local law requires that the top tether be attached, or if the instructions that come with the child restraint say that the top tether must be attached.

According to accident statistics, children and infants are safer when properly restrained in a child restraint system or infant restraint system secured in a rear seating position. See *Where to Put the Restraint* on page 3-39 for additional information.

Securing a Child Restraint Designed for the LATCH System

⚠ Warning

If a LATCH-type child restraint is not attached to anchors, the child restraint will not be able to protect the child correctly. In a crash, the

(Continued)

Warning (Continued)

child could be seriously injured or killed. Install a LATCH-type child restraint properly using the anchors, or use the vehicle safety belts to secure the restraint, following the instructions that came with the child restraint and the instructions in this manual.

⚠ Warning

Do not attach more than one child restraint to a single anchor. Attaching more than one child restraint to a single anchor could cause the anchor or attachment to come loose or even break during a crash. A child or others could be injured. To reduce the risk of serious or fatal injuries during a crash, attach only one child restraint per anchor.

 **Warning**

Children can be seriously injured or strangled if a shoulder belt is wrapped around their neck and the safety belt continues to tighten. Buckle any unused safety belts behind the child restraint so children cannot reach them. Pull the shoulder belt all the way out of the retractor to set the lock, if the vehicle has one, after the child restraint has been installed.

 **Caution**

Do not let the LATCH attachments rub against the vehicle's safety belts. This may damage these parts. If necessary, move buckled safety belts to avoid rubbing the LATCH attachments.

(Continued)

Caution (Continued)

Do not fold the empty rear seat with a safety belt buckled. This could damage the safety belt or the seat. Unbuckle and return the safety belt to its stowed position, before folding the seat.

If you need to secure more than one child restraint in the rear seat, see *Where to Put the Restraint on page 3-39*.

This system is designed to make installation of child restraints easier. When using lower anchors, do not use the vehicle's safety belts. Instead, use the vehicle's anchors and child restraint attachments to secure the restraints. Some restraints also use another vehicle anchor to secure the top tether.

1. Attach and tighten the lower attachments to the lower anchors. If the child restraint does not have lower

attachments or the desired seating position does not have lower anchors, secure the child restraint with the top tether and the safety belts. Refer to your child restraint manufacturer instructions and the instructions in this manual.

- 1.1. Find the lower anchors for the desired seating position.
- 1.2. Put the child restraint on the seat.
- 1.3. Attach and tighten the lower attachments on the child restraint to the lower anchors.
2. If the child restraint manufacturer recommends that the top tether be attached, attach and tighten the top tether to the top tether anchor, if equipped. Refer to the child restraint instructions and the following steps:
 - 2.1. Find the top tether anchor.

3-46 Seats and Restraints

- 2.2. Open the top tether anchor cover to expose the anchor.
- 2.3. Route, attach, and tighten the top tether according to your child restraint instructions and the following instructions:

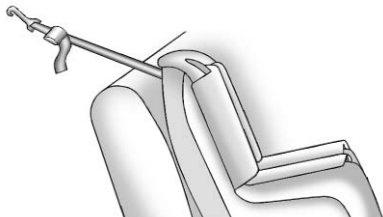

If the position you are using does not have head restraint and you are using a single tether, route the tether over the seatback.

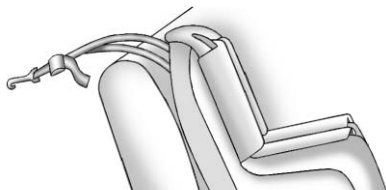

If the position you are using does not have head restraint and you are using a dual tether, route the tether over the seatback.

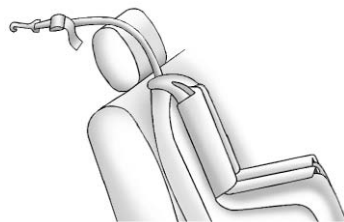

If the position you are using has a fixed head restraint and you are using a single tether, route the tether over the head restraint.

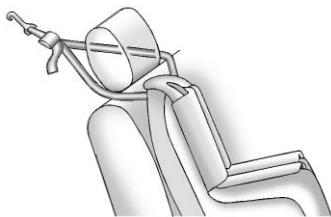

If the position you are using has a fixed head restraint and you are using a dual tether, route the tether around the head restraint.

- Before placing a child in the child restraint, make sure it is securely held in place. To check, grasp the child restraint at the LATCH path and attempt to move it side to side and back and forth. There should be no more than 2.5 cm (1 in) of movement for proper installation.

Replacing LATCH System Parts After a Crash

Warning

A crash can damage the LATCH system in the vehicle. A damaged LATCH system may not properly secure the child restraint, resulting in serious injury or even death in a crash. To help make sure the LATCH system is working properly after a crash, see your dealer to have the system inspected and any necessary replacements made as soon as possible.

If the vehicle has the LATCH system and it was being used during a crash, new LATCH system parts may be needed.

New parts and repairs may be necessary even if the LATCH system was not being used at the time of the crash.

Securing Child Restraints (Rear Seat)

When securing a child restraint in a rear seating position, study the instructions that came with the child restraint to make sure it is compatible with this vehicle.

If the child restraint has the LATCH system, see *Lower Anchors and Tethers for Children (LATCH System)* on page 3-41 for how and where to install your child restraint using LATCH. If a child restraint is secured in the vehicle using a safety belt and it uses a top tether, see *Lower Anchors and Tethers for Children (LATCH System)* on page 3-41 for top tether anchor locations.

Do not secure a child restraint in a position without a top tether anchor if a national or local law requires that the top tether be anchored, or if the instructions that come with the child restraint say that the top strap must be anchored.

3-48 Seats and Restraints

In Canada, the law requires that forward-facing child restraints have a top tether, and that the tether be attached.

If the child restraint does not have the LATCH system, you will be using the safety belt to secure the child restraint in this position. Be sure to follow the instructions that came with the child restraint. Secure the child in the child restraint when and as the instructions say.

If more than one child restraint needs to be installed in the rear seat, be sure to read *Where to Put the Restraint on page 3-39*.

1. Put the child restraint on the seat.
2. Pick up the latch plate, and run the lap and shoulder portions of the vehicle's safety belt through or around the restraint. The child restraint instructions will show you how.

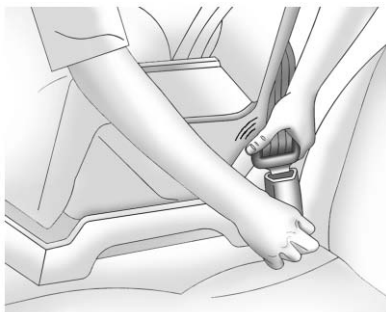

3. Push the latch plate into the buckle until it clicks.
Position the release button on the buckle so that the safety belt could be quickly unbuckled if necessary.

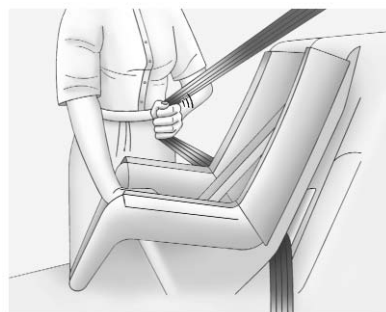

4. Pull the shoulder belt all the way out of the retractor to set the lock. When the retractor lock is set, the belt can be tightened but not pulled out of the retractor.

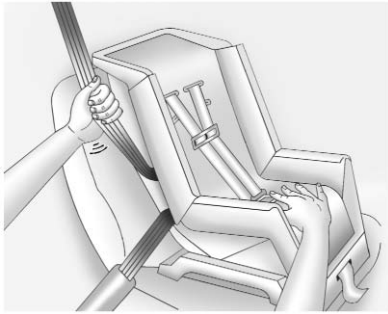

5. To tighten the belt, push down on the child restraint, pull the shoulder portion of the belt to tighten the lap portion of the belt, and feed the shoulder belt back into the retractor. When installing a forward-facing child restraint, it may be helpful to use your knee to push down on the child restraint as you tighten the belt.
Try to pull the belt out of the retractor to make sure the retractor is locked. If the retractor is not locked, repeat Steps 4 and 5.
6. If the child restraint has a top tether, follow the child restraint manufacturer instructions regarding the use of the top tether. See *Lower Anchors and Tethers for Children (LATCH System)* on page 3-41.
7. Before placing a child in the child restraint, make sure it is securely held in place. To check, grasp the child restraint at the safety belt path and attempt to move it side to side and back and forth. When the child restraint is properly installed, there should be no more than 2.5 cm (1 in) of movement.

To remove the child restraint, unbuckle the vehicle safety belt and let it return to the stowed position. If the top tether is attached to a top tether anchor, disconnect it.

Securing Child Restraints (Front Passenger Seat)

This vehicle has airbags. A rear seat is a safer place to secure a forward-facing child restraint. See *Where to Put the Restraint* on page 3-39

In addition, the vehicle has a passenger sensing system which is designed to turn off the front passenger frontal airbag under certain conditions. See *Passenger Sensing System* on page 3-26 and *Passenger Airbag Status Indicator* on page 5-18 for more information, including important safety information.

A label on the sun visor says, "Never put a rear-facing child seat in the front." This is because the risk to the rear-facing child is so great, if the airbag deploys.

Warning

A child in a rear-facing child restraint can be seriously injured or killed if the front passenger airbag inflates. This is because the back of the rear-facing child restraint would be very close to the inflating airbag. A child in a forward-facing child restraint can be seriously injured or killed if the front passenger airbag inflates and the passenger seat is in a forward position.

Even if the passenger sensing system has turned off the front passenger frontal airbag, no system is fail-safe. No one can guarantee that an airbag will not deploy under some unusual circumstance, even though it is turned off.

(Continued)

Warning (Continued)

Secure rear-facing child restraints in a rear seat, even if the airbag is off. If you secure a forward-facing child restraint in the front seat, always move the front passenger seat as far back as it will go. It is better to secure the child restraint in a rear seat.

See *Passenger Sensing System on page 3-26* for additional information.

If the child restraint has the LATCH system, see *Lower Anchors and Tethers for Children (LATCH System) on page 3-41* for how and where to install the child restraint using LATCH. If a child restraint is secured using a safety belt and it uses a top tether, see *Lower Anchors and Tethers for Children (LATCH System) on page 3-41* for top tether anchor locations.

Do not secure a child seat in a position without a top tether anchor if a national or local law requires that the top tether be anchored, or if the instructions that come with the child restraint say that the top strap must be anchored.

In Canada, the law requires that forward-facing child restraints have a top tether, and that the tether be attached.

You will be using the lap-shoulder belt to secure the child restraint in this position. Follow the instructions that came with the child restraint.

1. Move the seat as far back as it will go before securing the forward-facing child restraint.

When the passenger sensing system has turned off the front passenger frontal airbag, the off indicator on the passenger airbag status indicator should light and stay lit when the vehicle is started. See *Passenger Airbag Status Indicator on page 5-18*.

2. Put the child restraint on the seat.
3. Pick up the latch plate, and run the lap and shoulder portions of the vehicle's safety belt through or around the restraint. The child restraint instructions will show you how.

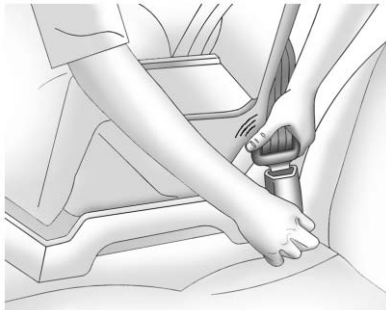

4. Push the latch plate into the buckle until it clicks.
Position the release button on the buckle, so that the safety belt could be quickly unbuckled if necessary.



5. Pull the shoulder belt all the way out of the retractor to set the lock. When the retractor lock is set, the belt can be tightened but not pulled out of the retractor.

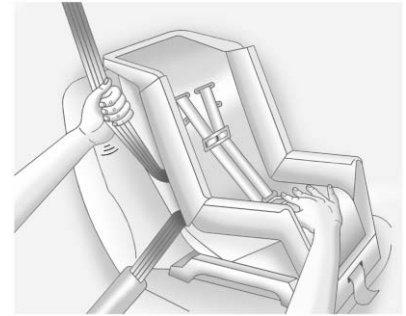

6. To tighten the belt, push down on the child restraint, pull the shoulder portion of the belt to tighten the lap portion of the belt, and feed the shoulder belt back into the retractor. When installing a forward-facing child restraint, it may be helpful to use your knee to push down on the child restraint as you tighten the belt.

Try to pull the belt out of the retractor to make sure the retractor is locked. If the retractor is not locked, repeat Steps 5 and 6.

3-52 Seats and Restraints

7. Before placing a child in the child restraint, make sure it is securely held in place. To check, grasp the child restraint at the safety belt path and attempt to move it side to side and back and forth. When the child restraint is properly installed, there should be no more than 2.5 cm (1 in) of movement.

If the airbag is off, the off indicator in the passenger airbag status indicator will come on and stay on when the vehicle is started.

If a child restraint has been installed and the on indicator is lit, see “If the On Indicator Is Lit for a Child Restraint” under *Passenger Sensing System* on page 3-26.

To remove the child restraint, unbuckle the vehicle safety belt and let it return to the stowed position.

Storage

Storage Compartments

- Storage Compartments 4-1
- Instrument Panel Storage 4-1
- Glove Box 4-1
- Cupholders 4-2
- Center Console Storage 4-2

Additional Storage Features

- Cargo Cover (Wagon) 4-2
- Cargo Management System (Sedan and Wagon) 4-3
- Cargo Net (Sedan and Wagon) 4-4
- Convenience Net (Coupe) 4-6

Roof Rack System

- Roof Rack System (Sedan and Wagon) 4-6

Storage Compartments

 Warning
Do not store heavy or sharp objects in storage compartments. In a crash, these objects may cause the cover to open and could result in injury.

Instrument Panel Storage

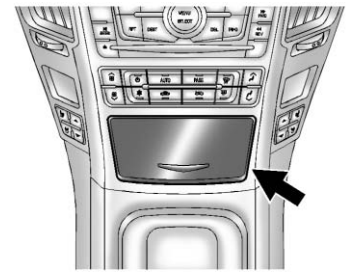

There is a storage area below the climate control system. To access, push the cover.

Glove Box

To open, press the button. Use the key to lock and unlock. The glove box has a shelf that can be removed by pulling it out.

4-2 Storage

Cupholders

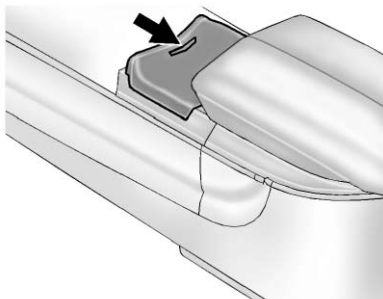

There are cupholders in the front of the center console. Push the cover to open.

There are also cupholders in the rear center armrest. Pull the armrest down to use.

Center Console Storage

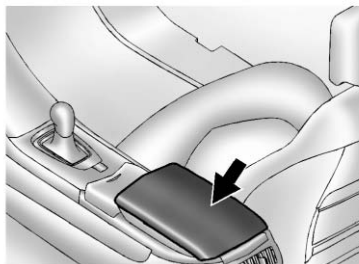

The center console has an upper and lower storage area. To access, lift the levers on either side of the center console. There is an additional storage area behind the center console. To access, push the cover.

Additional Storage Features

Cargo Cover (Wagon)

The cargo cover can be used to cover items in the cargo area.

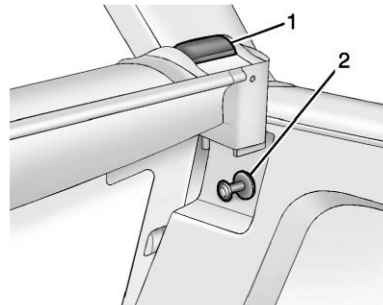

To install the cargo cover:

1. Hold the cartridge with the pull-out shade toward the rear of the vehicle.

- Align the cartridge over the pin (2) on both sides. Press the cartridge down and turn it slightly forward until it clicks.
- The cartridge is properly installed if it fits firmly when pulled and pushed.
- Grasp the handle and unroll the cover. Latch the posts into the sockets.

To remove the cargo cover:

- Release the cover from the latch posts and carefully roll it back up.
- Pull the handle (1) back and remove it from the pin (2) on the trim panel. Repeat this on the other side.

Warning

An unsecured cargo cover could strike people in a sudden stop or turn, or in a crash. Store the cargo cover securely or remove it from the vehicle.

Cargo Management System (Sedan and Wagon)

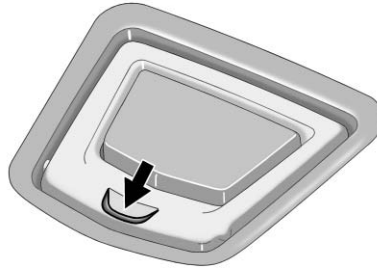

Press the bottom of the load floor handle assembly to lift the top on the handle. Pull up on the handle to open the cargo management system.

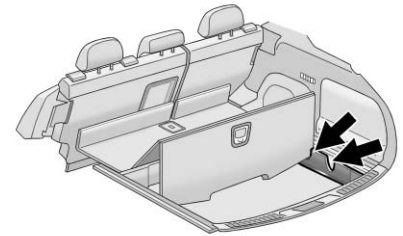

The cover can be opened to two positions to allow access to the storage area.

Some items may be stored in the cargo area when the cover is closed.

D-Ring Sliders

There are four D-Ring sliders that move along rails on both sides of the cargo management area. These can be used as tie-downs when storing cargo.

4-4 Storage

Installing D-Ring Sliders

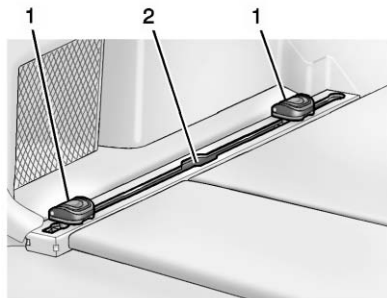

To install the D-Ring slider (1), insert it into the channel (2) in the middle of each rail.

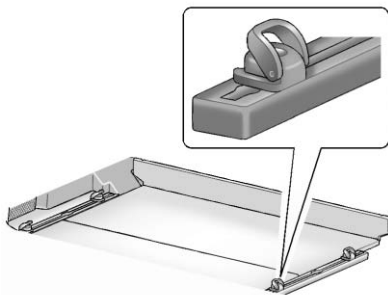

The loop of the D-Ring slider must be facing inward toward the storage area and the ring must be in the up position for proper usage.

Press the button to move the D-Ring slider. The rings can be locked into various positions along the rail.

Cargo Net (Sedan and Wagon)

Warning

Do not stack items higher than the upper end of the cargo net or hang anything from the net. Avoid items that have sharp edges or that apply excessive force to the net. If items are not properly stored, damage to the net could occur and items can be thrown about the vehicle. You or others could be injured. Always store items behind the net.

For vehicles equipped with a cargo net, it can be used to store light loads, keeping them from falling over or being thrown.

The net should not be overloaded or used to store heavy loads.

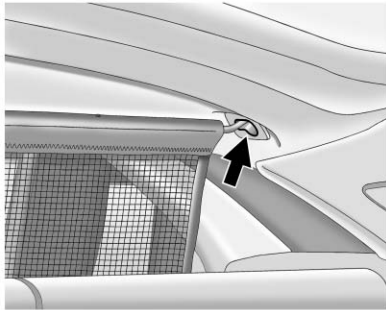

1. There are four installation points in the roof: two in front of and two behind the rear seats.

Insert the top corners of the cargo net into the large opening in the roof and secure by sliding them into the small opening.

2. There are four tether positions for the lower hook straps. In the front position, the seatbacks should be down for the net to properly hold items.

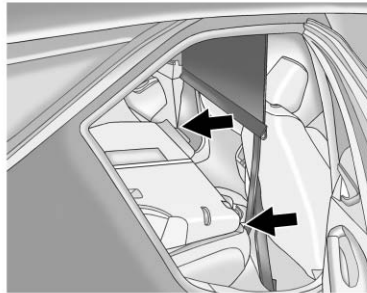

3. Mount the cargo net to the rear seat tethers on the front of the bottom cushions.

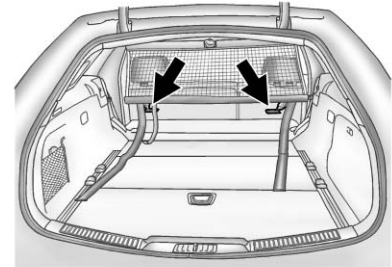

4. The net can also be mounted to the tethers on the back of the rear seats when the seats are upright.

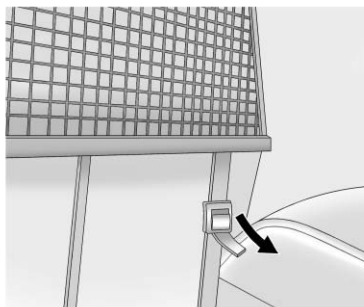

5. Pull on the straps to tighten the net.

Convenience Net (Coupe)

The vehicle may have a convenience net in the rear. Put small loads behind the net. It can also be positioned into an envelope style to hold smaller items. The net is not for heavier loads. Store items as far forward as you can.

Roof Rack System

Roof Rack System (Sedan and Wagon)

Warning

If something is carried on top of the vehicle that is longer or wider than the roof rack — like paneling, plywood, or a mattress — the wind can catch it while the vehicle is being driven. The item being carried could be violently torn off, and this could cause a collision and damage the vehicle. Never carry something longer or wider than the roof rack on top of the vehicle unless using a GM certified accessory carrier.

If equipped, the roof rack can be used to load items. For roof racks that do not have crossrails included, GM Certified crossrails can be

purchased as an accessory. See your dealer for additional information.

Caution

Loading cargo on the roof rack that weighs more than 75 kg (165 lb) or hangs over the rear or sides of the vehicle may damage the vehicle. Load cargo so that it rests evenly between the crossrails, making sure to fasten cargo securely.

To prevent damage or loss of cargo when driving, check to make sure crossrails and cargo are securely fastened. Loading cargo on the roof rack will make the vehicle's center of gravity higher. Avoid high speeds, sudden starts, sharp turns, sudden braking, or abrupt maneuvers, otherwise it may result in loss of control. If driving for a long distance, on rough roads, or at high speeds,

occasionally stop the vehicle to make sure the cargo remains in its place.

Do not exceed the maximum vehicle capacity when loading the vehicle. For more information on vehicle capacity and loading, see *Vehicle Load Limits* on page 9-11.

Installing the Crossrails

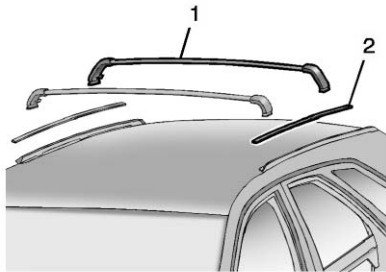

1. Crossrails
2. Siderail Cover

Before installing the crossrails (1), remove the siderail covers (2). Pull straight up on the rear of the siderail cover. Store covers flat; do not stack items on them.

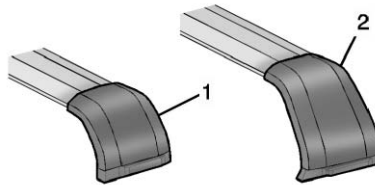

1. Identify the front and rear crossrail.
2. The front crossrail (1) is smaller than the rear crossrail (2).

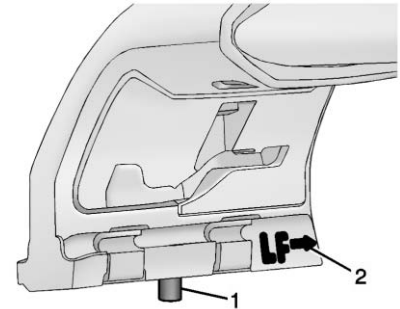

3. The crossrail supports are labeled with an arrow (2) that needs to point toward the front of the vehicle. A pin (1) will be visible on the bottom when the crossrail support lever is down. To install the crossrail support, move the lever into the forward upper position; the pin (1) will not be visible.

4-8 Storage

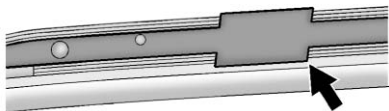

4. Locate the forward or rearward cut-out in the siderail channel.
5. Insert both crossrail ends into the cut-outs, making sure the arrows are pointed toward the front of the vehicle.

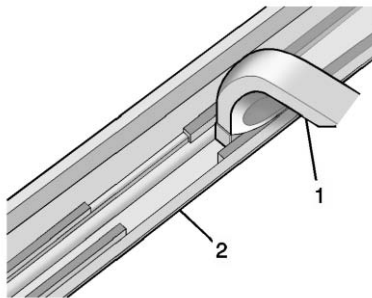

6. Levers must still be in the forward up position. Move the front crossrail forward beyond the cut-out area (2). For the rear crossrail, slide the crossrail assembly (1) rearward until the entire crossrail support is in first position beyond the channel cut-out area (2).

7. Move the levers on both crossrails to the down position. Slide the crossrail until the crossrail pin engages.
8. The crossrails should lock in the same hole position on each side.

Removing the Crossrails

1. Move both levers of the crossrail into the upper forward position.
2. Slide the crossrail into the cut-out area.
3. Remove the crossrail from the vehicle.
4. Repeat for the other crossrail.
5. Replace the siderail covers on the siderails.

Instruments and Controls

Controls

Steering Wheel Adjustment ...	5-2
Steering Wheel Controls	5-3
Heated Steering Wheel	5-4
Horn	5-4
Windshield Wiper/Washer	5-4
Rear Window Wiper/ Washer	5-6
Headlamp Washer	5-7
Compass	5-7
Clock	5-9
Power Outlets	5-9

Warning Lights, Gauges, and Indicators

Warning Lights, Gauges, and Indicators	5-10
Instrument Cluster	5-11
Speedometer	5-13
Odometer	5-13
Trip Odometer	5-13
Tachometer	5-13
Fuel Gauge	5-13
Boost Gauge	5-14

Engine Speed Limiter	5-14
Engine Oil Pressure Gauge	5-15
Engine Coolant Temperature Gauge	5-16
Safety Belt Reminders	5-16
Airbag Readiness Light	5-17
Passenger Airbag Status Indicator	5-18
Charging System Light	5-18
Malfunction Indicator Lamp	5-19
Brake System Warning Light	5-22
Antilock Brake System (ABS) Warning Light	5-23
Up-Shift Light	5-23
StabiliTrak [®] OFF Light	5-23
Traction Control System (TCS)/StabiliTrak [®] Light	5-24
Engine Coolant Temperature Warning Light	5-24
Tire Pressure Light	5-25
Engine Oil Pressure Light ...	5-25
Security Light	5-26
High-Beam On Light	5-26
Front Fog Lamp Light	5-26
Lamps On Reminder	5-26
Cruise Control Light	5-27

Information Displays

Driver Information Center (DIC)	5-27
--	------

Vehicle Messages

Vehicle Messages	5-31
Battery Voltage and Charging Messages	5-32
Brake System Messages ...	5-33
Compass Messages	5-34
Cruise Control Messages ...	5-34
Door Ajar Messages	5-34
Engine Cooling System Messages	5-35
Engine Oil Messages	5-36
Engine Power Messages ...	5-36
Fuel System Messages	5-37
Key and Lock Messages ...	5-37
Lamp Messages	5-39
Object Detection System Messages	5-40
Ride Control System Messages	5-41
Airbag System Messages ...	5-43
Security Messages	5-43
Service Vehicle Messages ...	5-44
Tire Messages	5-44

5-2 Instruments and Controls

Transmission Messages	5-45
Vehicle Speed Messages	5-46
Washer Fluid Messages	5-46

Vehicle Personalization

Vehicle Personalization	5-46
-----------------------------------	------

Universal Remote System

Universal Remote System	5-54
Universal Remote System Programming	5-54
Universal Remote System Operation	5-57

Controls

Steering Wheel Adjustment

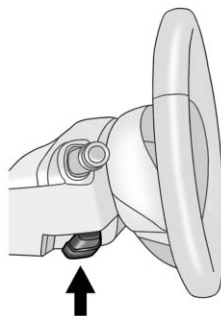

To adjust the steering wheel:

1. Pull the lever down.
2. Move the steering wheel up or down.
3. Pull or push the steering wheel closer or away from you.
4. Pull the lever up to lock the steering wheel in place.

Power Tilt Wheel

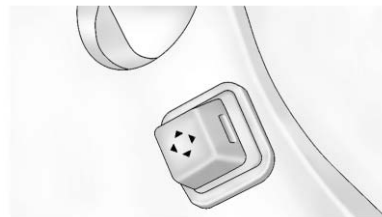

If equipped with the power tilt and telescoping wheel, the control is on the left side of the steering column.

- Push the control up or down to tilt the steering wheel up or down.
- Push the control forward or rearward to move the steering wheel toward the front or rear of the vehicle.

Do not adjust the steering wheel while driving.

Steering Wheel Controls

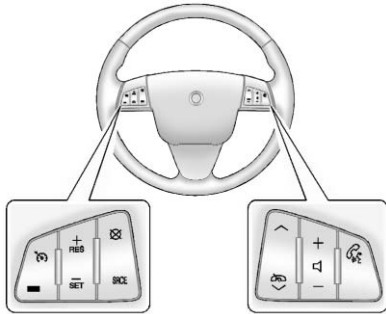

Some audio steering wheel controls could differ depending on the vehicle's options. Controls that can be adjusted at the steering wheel may include:

SRCE (Source): Press to switch between AM, FM, or SiriusXM (if equipped) radio, CD, DVD (if equipped), HDD (if equipped), auxiliary input jack, and USB (if equipped).

^ or ↶ / V (Previous/Next): Press to go to the previous or next radio station stored as a favorite, or the previous or next track of a CD.

Press to interact with the Bluetooth® system. See *Bluetooth* on page 7-35.

+ ◀ - (Volume): Press to increase or to decrease the volume.

🔇 / 🗣️ (Mute/Speech Recognition/ Push to Talk): Press and release to silence the vehicle speakers only. The audio of the wireless and wired headphones, if equipped, does not mute. Press and release 🔇 / 🗣️ again to turn the sound on.

- For vehicles with a navigation system, press and hold 🔇 / 🗣️ for two seconds to initiate speech recognition. See "Speech Recognition" in the navigation manual.

- For vehicles without a navigation system, press and hold 🔇 / 🗣️ for two seconds to interact with OnStar® or Bluetooth. See *OnStar Overview* on page 14-1 or *Bluetooth* on page 7-35.
- For vehicles with a navigation system, OnStar, or Bluetooth, press and hold 🔇 / 🗣️ for two seconds and say "hands free" to interact with OnStar or Bluetooth. See *OnStar Overview* on page 14-1 or *Bluetooth* on page 7-35.

5-4 Instruments and Controls

Heated Steering Wheel

The vehicle may be equipped with a heated steering wheel.

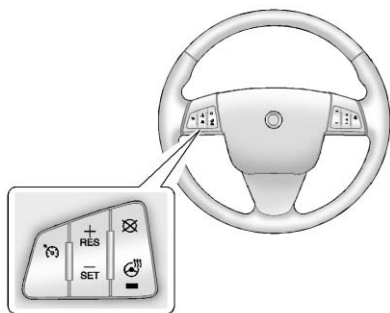

 **(Heated Steering Wheel):** Press to turn the heated steering wheel on or off. A light on the button displays when the feature is turned on.

The steering wheel takes about three minutes to start heating.

Horn

Press  on the steering wheel pad to sound the horn.

Windshield Wiper/Washer

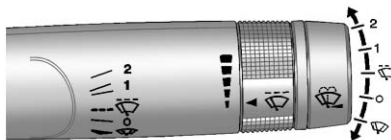

Sedan and Coupe Model

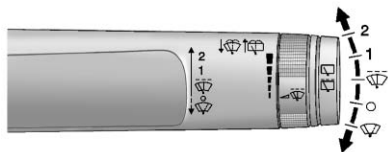

Wagon Model

The windshield wiper lever is on the right side of the steering column.

Move the windshield wiper lever to select the wiper speed.

 **(Mist):** Single wipe, briefly move the lever down and release. Several wipes, hold the lever down.

 **(Off):** Turns the wipers off.

 **(Adjustable Interval Wipes):** For a delayed wiping cycle. Turn the band up for more frequent wipes or down for less frequent wipes.

1: Slow wipes.

2: Fast wipes.

If the windshield wipers are in use for about six seconds while you are driving, the exterior lamps come on automatically if the exterior lamp control is in AUTO. See “Wiper Activated Headlamps” for more information.

Clear snow and ice from the wiper blades before using them. If frozen to the windshield, carefully loosen or thaw them. Damaged wiper blades should be replaced. For more information, see *Wiper Blade Replacement* on page 10-32.

Heavy snow or ice can overload the wiper motor. A circuit breaker will stop the motor until it cools down.



Rainsense™

For vehicles with Rainsense, a sensor near the top center of the windshield detects the amount of water on the windshield and automatically controls the frequency of the windshield wiper.

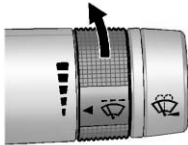
Keep this area of the windshield clear of debris to allow for best system performance.



Sedan and Coupe Model Shown,
Wagon Model Similar

 **(Rainsense Wipe Sensitivity Control):** Move the windshield wiper lever to . Turn the  band on the wiper lever to adjust the sensitivity.

- Turn the band up for more sensitivity to moisture.
- Turn the band down for less sensitivity to moisture.
- Move the windshield wiper lever out of the  position to deactivate Rainsense.

Wiper Arm Assembly Protection



When using an automatic car wash, move the windshield wiper lever to the  position. This disables the windshield wipers and/or rear wipers, if equipped.

Windshield Washer

Warning

In freezing weather, do not use the washer until the windshield is warmed. Otherwise the washer fluid can form ice on the windshield, blocking your vision.

Sedan and Coupe Model

 **(Washer Fluid):** Press the button with this symbol, on the end of the windshield washer lever to wash the windshield. The washer fluid sprays onto the windshield and the wipers run for a few cycles to clear the windshield. Press and hold  for more wash cycles.

Wagon Model

Pull the lever toward you to spray washer fluid on the windshield. The spray continues until the lever is released. The wipers will run a few times.

5-6 Instruments and Controls

WASHER FLUID LOW ADD FLUID displays on the Driver Information Center (DIC) when the washer fluid is low. See *Washer Fluid Messages* on page 5-46.

See *Washer Fluid* on page 10-26 for information on filling the windshield washer fluid reservoir.

If the headlamps are on while the windshield is being washed, the headlamp washers, if the vehicle has them, will also turn on. See “Headlamp Washer” following for more information.

Wiper Activated Headlamps

This feature activates the headlamps and parking lamps after the windshield wipers have been in use for about six seconds. For this feature to work, the exterior lamp control must be in AUTO.

The wiper-activated headlamps immediately turn off, when the ignition is turned to LOCK/OFF or the windshield wiper control is turned off.

Rear Window Wiper/Washer

For vehicles with a rear window wiper/washer, the controls are on the end of the windshield wiper lever.

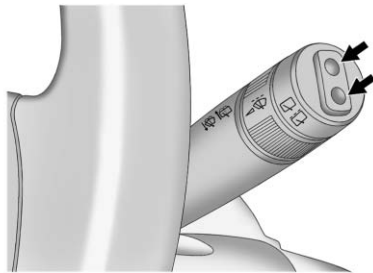

Press the upper or lower portion of the button to control the rear wiper and rear wiper delay.

The system turns off when the button is returned to the middle position.

 **(Rear Wiper Delay Short):** Sets a five-second delay between wipes.

 **(Rear Wiper Delay Long):** Sets a 10-second delay between wipes.

 **(Rear Washer):** Push the windshield wiper lever forward to spray washer fluid on the rear window. The lever returns to its starting position when released.

The windshield washer reservoir is used for the windshield and the rear window. Check the fluid level in the reservoir if either washer is not working. See *Washer Fluid* on page 10-26.

Headlamp Washer

For vehicles with headlamp washers they clear debris from the headlamp lenses.

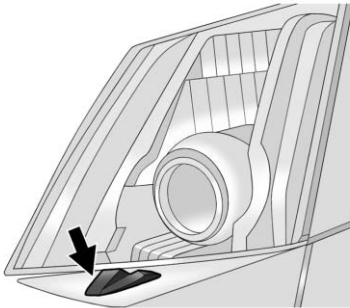

The headlamp washers are beneath the headlamps.

Press the washer button at the end of the windshield wiper lever to wash the headlamps. Both the headlamps and the windshield will

be washed. After the first wash, the headlamps will not be washed until the fifth press of the windshield washer button.

The headlamps must be on to be washed. If the headlamps are off, only the windshield will be washed when the washer button is pressed. If the washer fluid is low, the headlamp washers will not work.

See *Windshield Wiper/Washer* on page 5-4 for more information.

Compass

The vehicle may have a compass in the Driver Information Center (DIC).

Compass Zone

The zone is set to zone eight. If you do not live in zone eight or drive out of the area, the variance needs to be changed to the appropriate zone.

To adjust for compass variance, use the following procedure:



Compass Variance (Zone) Procedure

1. Do not set the compass zone when the vehicle is moving. On an automatic transmission vehicle, only set it when the vehicle is in P (Park). On a manual transmission vehicle, only set it when the vehicle is stopped.

Press  until PRESS ✓ TO CHANGE COMPASS ZONE displays.

5-8 Instruments and Controls



2. Find the vehicle's current location and variance zone number on the map.
Zones 1 through 15 are available.
3. Press  to scroll through and select the appropriate variance zone.
4. Press  until the vehicle heading, for example, N for North, is displayed in the DIC.
5. Calibrate the compass. See "Compass Calibration Procedure" following.





Compass Calibration

The compass can be manually calibrated. Only calibrate the compass in a magnetically clean and safe location, such as an open parking lot, where driving the vehicle in circles is not a danger. Also calibrate the compass, away from tall buildings, utility wires, manhole covers, or other industrial structures, if possible.

If the DIC display does not show a heading, for example, N for North, or the heading does not change after making turns, there may be a strong magnetic field interfering with the compass. Interference may be caused by a magnetic antenna mount, magnetic note pad holder, or any other magnetic item. Turn off the vehicle, move the magnetic item, then turn on the vehicle and calibrate the compass.

Compass Calibration Procedure

1. Before calibrating the compass, check that the compass is set to the correct variance zone. See "Compass Variance (Zone) Procedure" earlier in this section.

Do not operate any switches such as window, sunroof, climate controls, seats, etc. during the calibration procedure.
2. Press  until PRESS  TO CALIBRATE COMPASS displays.
3. Press  to start the compass calibration.
4. The DIC will display CALIBRATING DRIVE IN CIRCLES. Drive the vehicle in tight circles at less than 8 km/h (5 mph) to complete the calibration. The DIC will display CALIBRATION COMPLETE for a few seconds then returns to the PRESS  TO CALIBRATE COMPASS display.

Clock

The analog clock is on the instrument panel above the radio. The clock is not connected with any other vehicle system and runs by itself. To adjust the clock:

1. Locate the adjustment buttons directly below the clock.
2. Press and hold the right adjustment button to move the clock hands forward, or the left adjustment button to make the clock hands go backward. Holding either button down will cause the clock to advance faster. Release the button before the desired time is reached.
3. Press and release either button to adjust the time by one-minute increments.

Power Outlets

Accessory power outlets can be used to plug in electrical equipment, such as a cell phone or MP3 player.

There are three accessory power outlets. The power outlets below the climate control system, inside the center console, and on the rear of the center console are powered while the vehicle is in ON/RUN, START or ACC/ACCESSORY mode, or until the driver door is opened within 10 minutes of turning off the vehicle.

The CTS Wagon has an additional accessory power outlet near the rear cargo net that is powered at all times.

Remove the cover to access and replace when not in use.

Caution

Leaving electrical equipment plugged in for an extended period of time while the vehicle is off will drain the battery. Always unplug electrical equipment when not in use and do not plug in equipment that exceeds the maximum 20 amp rating.

Certain electrical accessories may not be compatible with the accessory power outlet and could overload vehicle or adapter fuses. If a problem is experienced, see your dealer.

When adding electrical equipment, be sure to follow the proper installation instructions included with the equipment. See *Add-On Electrical Equipment* on page 9-59.

Caution

Hanging heavy equipment from the power outlet can cause damage not covered by the vehicle warranty. The power outlets are designed for accessory power plugs only, such as cell phone charge cords.

Warning Lights, Gauges, and Indicators

Warning lights and gauges can signal that something is wrong before it becomes serious enough to cause an expensive repair or replacement. Paying attention to the warning lights and gauges could prevent injury.

Warning lights come on when there could be a problem with a vehicle function. Some warning lights come on briefly when the engine is started to indicate they are working.

Gauges can indicate when there could be a problem with a vehicle function. Often gauges and warning lights work together to indicate a problem with the vehicle.

When one of the warning lights comes on and stays on while driving, or when one of the gauges shows there may be a problem, check the section that explains what to do. Follow this manual's advice. Waiting to do repairs can be costly and even dangerous.

Instrument Cluster

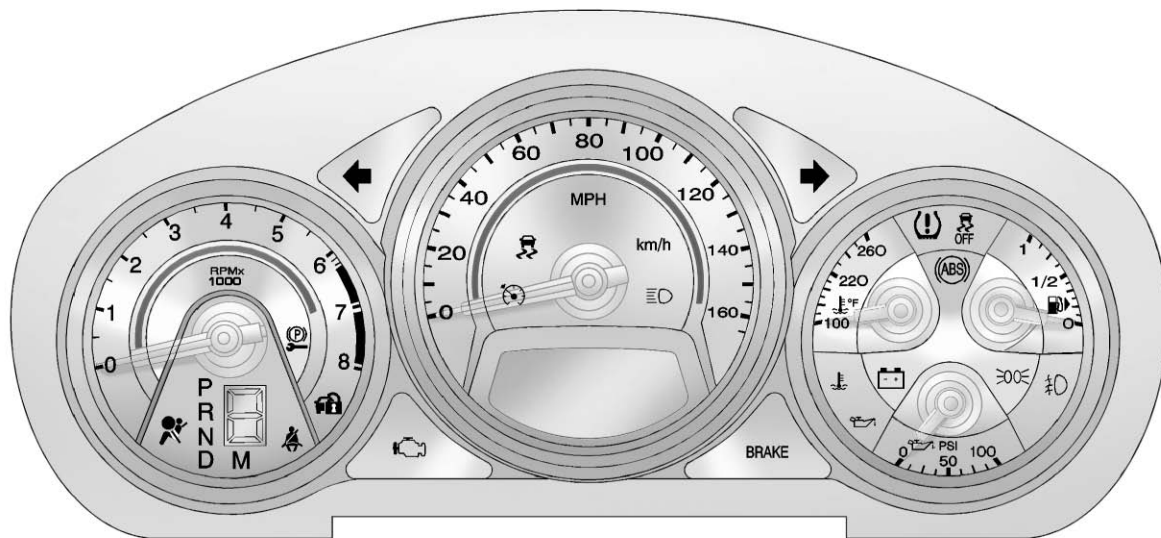

English Shown, Metric Similar

5-12 Instruments and Controls

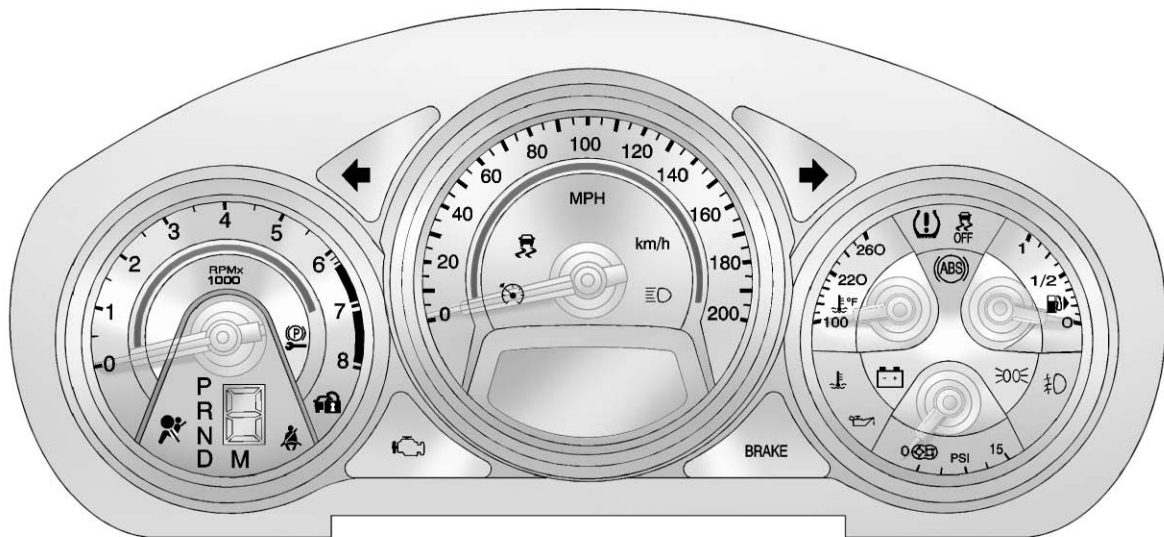

English V-Series Shown, Metric and Manual Similar

Speedometer

The speedometer shows the vehicle's speed in either kilometers per hour (km/h) or miles per hour (mph).

Odometer

The odometer shows how far the vehicle has been driven, in either kilometers or miles.

This vehicle has a tamper-resistant odometer. The digital odometer will read 999,999 if it is turned back.

If the vehicle needs a new odometer installed, it must be set to the mileage total of the old odometer. If that is not possible, then it must be set at zero and a label must be put on the driver door to show the old mileage reading when the new odometer was installed.

Trip Odometer

The trip odometer can record the number of kilometers or miles traveled for up to two trips.

The trip odometer is part of the Driver Information Center (DIC); for more information see *Driver Information Center (DIC) on page 5-27*.

For vehicles that have the navigation system, see the navigation manual for more information.

Tachometer

The tachometer displays the engine speed in revolutions per minute (rpm).

⚠ Caution

If the engine is operated with the tachometer in the shaded warning area, the vehicle could be damaged, and the damages would not be covered by the vehicle warranty. Do not operate the engine with the tachometer in the shaded warning area.

The CTS-V tachometer has tracer lights that follow the movement of the tachometer indicator. The tracer lights also flash when it is time to up-shift to avoid the engine speed limit. See *Automatic Transmission on page 9-26* or *Manual Transmission on page 9-31* for more information.

Fuel Gauge



When the ignition is on, the fuel gauge indicates how much fuel is left in the tank.

5-14 Instruments and Controls

An arrow on the fuel gauge indicates the side of the vehicle the fuel door is on.

The FUEL LEVEL LOW message appears in the Driver Information Center (DIC) and a single chime sounds. See *Fuel System Messages* on page 5-37 for more information.

Normal operation of the fuel gauge includes:

- At the service station, the fuel pump shuts off before the gauge reads full.
- It takes a little more or less fuel to fill up than the gauge indicated.
- The gauge moves a little while turning a corner or speeding up.
- The gauge takes a few seconds to stabilize after the ignition is turned on, and goes back to empty when the ignition is turned off.

Boost Gauge

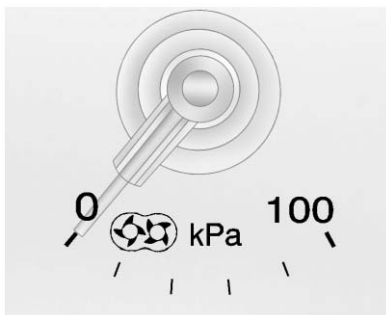

Metric



English

For the CTS-V, this gauge is in the instrument cluster.

This gauge indicates positive manifold pressure, which is the induction air pressure level in the intake manifold before it enters the combustion chamber. This gauge reads zero under light throttle before boost is generated.

The gauge automatically resets to zero every time the engine is started.

Engine Speed Limiter

This feature prevents the engine speed from reaching an unsafe level. If the level is too high, the throttle closes or limits the fuel supply until the engine speed returns to a safe level. Throttle operation and fuel supply return to normal when engine speed is lowered.

For the CTS-V, the tachometer tracer lights flash prior to reaching engine speed limit. The tracer lights also flash on automatic transmission vehicles while in the DSC or Tap Shift modes.

Engine Oil Pressure Gauge

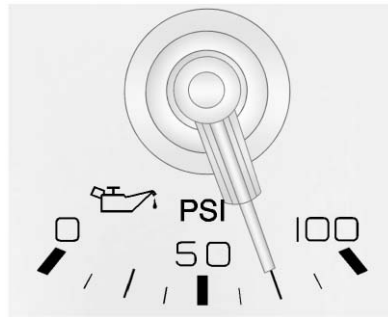
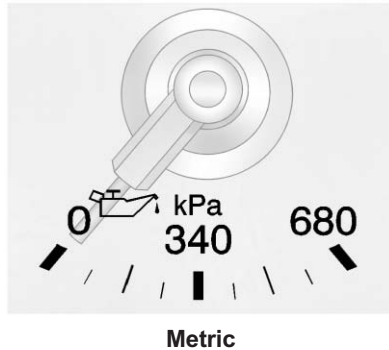

English

For vehicles with an engine oil pressure gauge, it shows the engine oil pressure in kPa (kilopascals) or psi (pounds per square inch) when the engine is running.

Oil pressure may vary with engine speed, outside temperature, and oil viscosity, but if readings are outside the normal operating range, the oil pressure light will come on. See *Engine Oil Pressure Light on* page 5-25 for more information.

A reading outside the normal operating range may be caused by a dangerously low oil level or some other problem causing low oil pressure. Oil should be checked as soon as possible. See *Oil Pressure Low Stop Engine* under *Engine Oil Messages* on page 5-36 and *Engine Oil* on page 10-10.

Caution

Lack of proper engine oil maintenance can damage the engine. Driving with the engine oil low can also damage the engine. The repairs would not be covered by the vehicle warranty. Check the oil level as soon as possible. Add oil if required, but if the oil level is within the operating range and the oil pressure is still low, have the vehicle serviced. Always follow the maintenance schedule for changing engine oil.

Engine Coolant Temperature Gauge



Metric

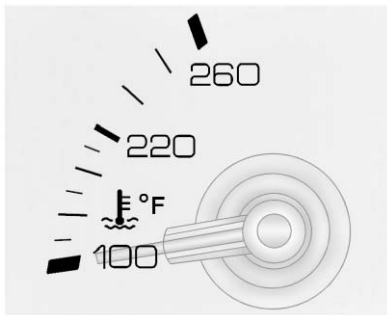

English

This gauge shows the engine coolant temperature. If the engine coolant overheats, the engine coolant temperature warning light comes on. See *Engine Coolant Temperature Warning Light* on page 5-24 and *Engine Overheating* on page 10-24 for more information.

Safety Belt Reminders

Driver Safety Belt Reminder Light

There is a driver safety belt reminder light on the instrument cluster.



When the vehicle is started, this light flashes and a chime may come on to remind the driver to fasten their safety belt. Then the light stays on solid until the belt is buckled. This cycle may continue several times if the driver remains or becomes unbuckled while the vehicle is moving.

If the driver safety belt is buckled, neither the light nor the chime comes on.

Passenger Safety Belt Reminder Light

There is a passenger safety belt reminder light near the passenger airbag status indicator. See *Passenger Sensing System* on page 3-26.



When the vehicle is started, this light flashes and a chime may come on to remind passengers to fasten their safety belt. Then the light stays on solid until the belt is buckled. This cycle continues several times if the passenger remains or becomes unbuckled while the vehicle is moving.

If the passenger safety belt is buckled, neither the chime nor the light comes on.

The front passenger safety belt warning light and chime may turn on if an object is put on the seat such as a briefcase, handbag, grocery bag, laptop, or other electronic device. To turn off the warning light and/or chime, remove the object from the seat or buckle the safety belt.

Airbag Readiness Light

This light shows if there is an electrical problem with the airbag system. The system check includes the airbag sensor(s), passenger sensing system, the pretensioners, the airbag modules, the wiring, and the crash sensing and diagnostic module. For more information on the airbag system, see *Airbag System* on page 3-20.



The airbag readiness light comes on for several seconds when the vehicle is started. If the light does not come on then, have it fixed immediately.

Warning

If the airbag readiness light stays on after the vehicle is started or comes on while driving, it means the airbag system might not be working properly. The airbags in the vehicle might not inflate in a crash, or they could even inflate without a crash. To help avoid injury, have the vehicle serviced right away.

If there is a problem with the airbag system, a Driver Information Center (DIC) message may also come on. See *Airbag System Messages* on page 5-43.

Passenger Airbag Status Indicator

The vehicle has a passenger sensing system. See *Passenger Sensing System* on page 3-26 for important safety information. The instrument panel has a passenger airbag status indicator.



United States



Canada and Mexico

When the vehicle is started, the passenger airbag status indicator will light the words ON and OFF, or the symbols for on and off, for

several seconds as a system check. Then, after several more seconds, the status indicator will light either ON or OFF, or either the on or off symbol, to let you know the status of the front outboard passenger frontal airbag.

If the word ON or the on symbol is lit on the passenger airbag status indicator, it means that the outboard front passenger frontal airbag is allowed to inflate.

If the word OFF or the off symbol is lit on the passenger airbag status indicator, it means that the passenger sensing system has turned off the outboard front passenger frontal airbag.

If, after several seconds, both status indicator lights remain on, or if there are no lights at all, there may be a problem with the lights or the passenger sensing system. See your dealer for service.

Warning

If the airbag readiness light ever comes on and stays on, it means that something may be wrong with the airbag system. To help avoid injury to yourself or others, have the vehicle serviced right away. See *Airbag Readiness Light* on page 5-17 for more information, including important safety information.

Charging System Light

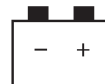

The charging system light comes on briefly when the ignition is turned on, but the engine is not running, as a check to show the light is working.

The light turns off when the engine is started. If it does not, have the vehicle serviced by your dealer.

If the light stays on, or comes on while driving, there may be a problem with the electrical charging system. Have it checked by your dealer. Driving while this light is on could drain the battery.

When this light comes on, the Driver Information Center (DIC) also displays a message.

See *Battery Voltage and Charging Messages* on page 5-32.

If a short distance must be driven with the light on, be sure to turn off all accessories, such as the radio and air conditioner.

Malfunction Indicator Lamp

A computer system called OBD II (On-Board Diagnostics-Second Generation) monitors the operation of the vehicle to ensure emissions are at acceptable levels, helping to maintain a clean environment. The malfunction indicator lamp comes on when the vehicle is placed in ON/RUN, as a check to show it is working. If it does not, have the vehicle serviced by your dealer. See *Ignition Positions (Keyless Access)* on page 9-15 or *Ignition Positions (Key Access)* on page 9-17 for more information.



This light should come on when the ignition is on, but the engine is not running, as a check to show it is working. If it does not, have the vehicle serviced by your dealer.

If the malfunction indicator lamp comes on while the engine is running, this indicates that the OBD II system has detected a problem and diagnosis and service might be required.

Malfunctions often are indicated by the system before any problem is apparent. Being aware of the light can prevent more serious damage to the vehicle. This system also assists the service technician in correctly diagnosing any malfunction.

Caution

If the vehicle is continually driven with this light on, the emission controls might not work as well, the vehicle fuel economy might not be as good, and the engine might not run as smoothly. This could lead to costly repairs that might not be covered by the vehicle warranty.

Caution

Modifications made to the engine, transmission, exhaust, intake, or fuel system of the vehicle or the replacement of the original tires with other than those of the same Tire Performance Criteria (TPC) can affect the vehicle's emission controls and can cause this light to come on. Modifications to these systems

(Continued)

Caution (Continued)

could lead to costly repairs not covered by the vehicle warranty. This could also result in a failure to pass a required Emission Inspection/Maintenance test. See *Accessories and Modifications on page 10-3*.

This light comes on during a malfunction in one of two ways:

Light Flashing: A misfire condition has been detected. A misfire increases vehicle emissions and could damage the emission control system on the vehicle. Diagnosis and service might be required.

To prevent more serious damage to the vehicle:

- Reduce vehicle speed.
- Avoid hard accelerations.
- Avoid steep uphill grades.

- If towing a trailer, reduce the amount of cargo being hauled as soon as it is possible.

If the light continues to flash, find a safe place to stop and park the vehicle. Turn the vehicle off, wait at least 10 seconds, and restart the engine. If the light is still flashing, follow the previous steps and see your dealer for service as soon as possible.

Light On Steady: An emission control system malfunction has been detected on the vehicle. Diagnosis and service might be required.

The following may correct an emission control system malfunction:

- Check that the fuel cap is fully installed. See *Filling the Tank on page 9-51*. The diagnostic system can determine if the fuel cap has been left off or improperly installed. A loose or missing fuel cap allows fuel to evaporate into the atmosphere.

A few driving trips with the cap properly installed should turn the light off.

- Check that good quality fuel is used. Poor fuel quality causes the engine not to run as efficiently as designed and may cause stalling after start-up, stalling when the vehicle is changed into gear, misfiring, hesitation on acceleration, or stumbling on acceleration. These conditions might go away once the engine is warmed up.

If one or more of these conditions occurs, change the fuel brand used. It may require at least one full tank of the proper fuel to turn the light off.

See *Fuel* on page 9-49.

If none of the above have made the light turn off, your dealer can check the vehicle. The dealer has the proper test equipment and diagnostic tools to fix any mechanical or electrical problems that might have developed.

Emissions Inspection and Maintenance Programs

Depending on where you live, your vehicle may be required to participate in an emission control system inspection and maintenance program. For the inspection, the emission system test equipment will likely connect to the vehicle's Data Link Connector (DLC).

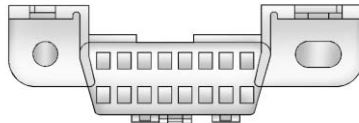

The DLC is under the instrument panel to the next to the steering wheel. See your dealer if assistance is needed.

The vehicle may not pass inspection if:

- The malfunction indicator lamp is on with the engine running, or if the light does not come on when

the ignition is turned to ON/RUN while the engine is off. See your dealer for assistance in verifying proper operation of the malfunction indicator lamp.

- The OBD II (On-Board Diagnostics) system determines that critical emission control systems have not been completely diagnosed. The vehicle would be considered not ready for inspection. This can happen if the 12-volt battery has recently been replaced or run down. The diagnostic system is designed to evaluate critical emission control systems during normal driving. This can take several days of routine driving. If this has been done and the vehicle still does not pass the inspection for lack of OBD II system readiness, your dealer can prepare the vehicle for inspection.

Brake System Warning Light

The vehicle brake system consists of two hydraulic circuits. If one circuit is not working, the remaining circuit can still work to stop the vehicle. For normal braking performance, both circuits need to be working

If the warning light comes on, there is a brake problem. Have the brake system inspected right away.



BRAKE

Metric

English

This light should come on briefly when the ignition is placed in ON/RUN. If it does not come on then, have it fixed so it will be ready to warn if there is a problem.

When the ignition is on, the brake system warning light also comes on when the parking brake is set.

The light flashes or stays on if the parking brake is not fully released.

If the light stays on after the parking brake is fully released, there is a base brake problem.

Warning

The brake system might not be working properly if the brake system warning light is on. Driving with the brake system warning light on can lead to a crash. If the light is still on after the vehicle has been pulled off the road and carefully stopped, have the vehicle towed for service.

For vehicles with the Electric Parking Brake (EPB), this red brake status light comes on when the parking brake is applied. If the light continues flashing after the parking

brake is released, or while driving, there is a problem with the Electric Parking Brake system.

If the light does not come on, or remains flashing, see your dealer.



For vehicles with the Electric Parking Brake (EPB), this parking brake warning light should come on briefly when ignition is placed in ON/RUN. If it does not come on then, have it fixed so it will be ready to warn if there is a problem.

If this parking brake light comes on, there is a problem with a system on the vehicle that is causing the parking brake system to work at a reduced level. The vehicle can still be driven, but should be taken to a dealer

See *Brake Assist* on page 9-37 for more information.

Antilock Brake System (ABS) Warning Light



The Antilock Brake System (ABS), this light comes on briefly when the engine is started.

If the light does not come on, have it fixed so it will be ready to warn if there is a problem.

If the ABS light stays on, turn the ignition off. If the light comes on while driving, stop as soon as it is safely possible and turn the ignition off. A chime may also sound when the light comes on steady. If this happens, start the engine again to reset the system. If the ABS light stays on, or comes on again while

driving, the vehicle needs service. If the regular brake system warning light is not on, the vehicle still has brakes, but not antilock brakes. If the regular brake system warning light is also on, the vehicle does not have antilock brakes and there is a problem with the regular brakes. See *Brake System Warning Light* on page 5-22.

For vehicles with a Driver Information Center (DIC), see *Driver Information Center (DIC)* on page 5-27 for all brake-related DIC messages.

Up-Shift Light



The vehicle may have an up-shift light. It indicates when to shift to the next higher gear for best fuel economy.

See *Manual Transmission* on page 9-31 for more information.

For the CTS-V, the tracer lights function as a performance up-shift light.

The tracers flash to indicate when to shift to the next higher gear to avoid the engine speed limit. See *Automatic Transmission* on page 9-26 or *Manual Transmission* on page 9-31 for more information.

StabiliTrak® OFF Light



This light comes on briefly while starting the engine. If it does not, have the vehicle serviced by your dealer.

5-24 Instruments and Controls

This light comes on when the StabiliTrak system is turned off. If StabiliTrak is off, the Traction Control System (TCS) is also off.

If the StabiliTrak and TCS are off, the system does not assist in controlling the vehicle. Turn on the TCS and the StabiliTrak systems and the warning light turns off.

See *Traction Control/Electronic Stability Control* on page 9-38.

Traction Control System (TCS)/StabiliTrak[®] Light



This light comes on briefly when the engine is started.

If the light does not come on, have the vehicle serviced by your dealer. If the system is working normally, the indicator light turns off.

If the light is on and not flashing, the TCS, and potentially the StabiliTrak system have been disabled. A DIC message may display. Check the DIC messages to determine which feature(s) is no longer functioning and whether the vehicle requires service.

If the indicator/warning light is on and flashing, the TCS and/or the StabiliTrak system is actively working.

See *Traction Control/Electronic Stability Control* on page 9-38.

Engine Coolant Temperature Warning Light



The engine coolant temperature warning light comes on briefly when the vehicle is started.

If it does not, have the vehicle serviced by your dealer. If the system is working normally, the indicator light then goes off.

If the light comes on and stays on while driving, the vehicle may have a problem with the cooling system. Stop and turn off the vehicle to avoid damage to the engine. A warning chime sounds when this light is on.

See *Engine Overheating* on page 10-24 for more information.

Tire Pressure Light



For vehicles with the Tire Pressure Monitor System (TPMS), this light comes on briefly when the engine is started. It provides information about tire pressures and the TPMS.

When the Light Is On Steady

This indicates that one or more of the tires are significantly underinflated.

A Driver Information Center (DIC) tire pressure message may also display. See *Tire Messages on page 5-44*. Stop as soon as possible, and inflate the tires to the pressure value shown on the Tire and Loading Information label. See *Tire Pressure on page 10-70*.

When the Light Flashes First and Then Is On Steady

If the light flashes for about a minute and then stays on, there may be a problem with the TPMS. If the problem is not corrected, the light will come on at every ignition cycle. See *Tire Pressure Monitor Operation on page 10-73*.

Engine Oil Pressure Light



Caution

Lack of proper engine oil maintenance can damage the engine. Driving with the engine oil low can also damage the engine. The repairs would not be covered by the vehicle warranty. Check the oil level as soon as possible. Add oil if required, but if the oil level is within the operating range and the oil pressure is still low, have the vehicle serviced. Always follow the maintenance schedule for changing engine oil.



This light should come on briefly as the engine is started. If it does not come on, have the vehicle serviced by your dealer.

If the light comes on and stays on, it means that oil is not flowing through the engine properly. The vehicle could be low on oil and might have some other system problem. See your dealer.

Security Light



The security light should come on briefly as the engine is started. If the system is working normally, the indicator light turns off. If it does not come on, have the vehicle serviced by your dealer.

If the light stays on and the engine does not start, there could be a problem with the theft-deterrent system.

This light is also used to indicate the status of the anti-theft alarm system when the ignition is turned off. The light will flash rapidly if the alarm system is arming and one or more of the monitored entry points is not closed. The light will stay on if the alarm is arming and all entry points are closed.

For information regarding this light and the vehicle's security system, see *Vehicle Alarm System* on page 2-23.

High-Beam On Light



The high-beam on light comes on when the high-beam headlamps are in use.

See *Headlamp High/Low-Beam Changer* on page 6-2 for more information.

Front Fog Lamp Light



The fog lamp light comes on when the fog lamps are in use.

The light goes out when the fog lamps are turned off. See *Fog Lamps* on page 6-5.

Lamps On Reminder



This light comes on whenever the parking lamps are on.

See *Exterior Lamps Off Reminder* on page 6-2 for more information.

Cruise Control Light



This light comes on whenever the cruise control is active.

The light goes out when the cruise control is turned off. See *Cruise Control on page 9-41* for more information.

Information Displays

Driver Information Center (DIC)

The Driver Information Center (DIC) provides status of many vehicle systems. The DIC displays warning/status messages. The DIC display is at the bottom of the instrument cluster. The DIC buttons are on the instrument panel next to the steering wheel.

The DIC comes on when the ignition is on. After a short delay, the DIC displays the information that was last displayed before the engine was turned off.

The top line of the DIC display shows the DIC information. The bottom line shows the compass. The compass displays in the trip/fuel menus and in some vehicle information menus.

If a problem is detected, a warning message appears on the display. All messages should be taken seriously; clearing the message does not correct the problem.

DIC Operation and Displays

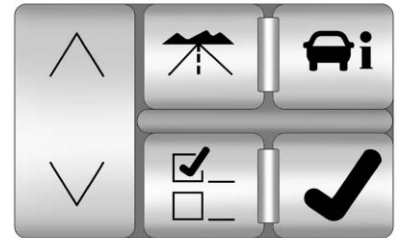

Press the DIC buttons to access the different displays.

Trip/Fuel: Press to scroll through the trip and fuel displays. See “Trip/Fuel Display Menu Items” following for more information.

 **(Vehicle Information):** Press to scroll through the vehicle information displays. See “Vehicle Information Display Menu Items” following for more information.

 **(Customization):** Press to scroll through each of the customization features. See *Vehicle Personalization on page 5-46* for more information.

✓ **(Set/Reset):** Press to reset certain DIC features and to acknowledge and clear DIC warning messages.

^ or v **(Menu Up/Down):** Press to scroll up and down the menu items.

Trip/Fuel Display Menu Items

 **(Trip/Fuel):** Press to display the following menu items:

Odometer

Displays the distance the vehicle has been driven in either kilometers (km) or miles (mi).

Trip A or Trip B

Displays the current distance traveled since the last reset for each trip odometer in either kilometers (km) or miles (mi). Both odometers can be used at the same time. Reset each trip odometer to zero by pressing and holding the set/reset button when Trip A or Trip B is displayed.

Fuel Range

Displays the approximate remaining kilometers (km) or miles (mi) you can drive without refilling the fuel tank. This estimate is based on the current driving conditions and changes if the driving conditions change. For example, freeway driving may produce better fuel economy than city driving with frequent stops, so the range would adjust for that.

Once the range drops below about 48 km (30 mi) remaining, the display shows Low Range.

If the fuel is low, the FUEL LEVEL LOW message displays. See “Fuel Level Low” under *Fuel System Messages on page 5-37* for more information.

AVG (Average) Economy

Displays the approximate average liters per 100 kilometers (L/100 km) or miles per gallon (mpg). The calculation is based on the number of L/100 km (mpg) recorded since the last time this display was reset. Press the set/reset button to reset to zero.

Timer

Can be used to measure time. For example, timing how long it takes to travel from one point to another. To access the timer, press the trip/fuel button until Timer 00:00:00 displays.

To turn on the timer, press the set/reset button.

To turn off the timer, press the set/reset button again. The timer displays the end timing value.

To reset the timer to zero, press and hold the set/reset button.

Inst (Instantaneous) Economy

Displays the current fuel economy in either liters per 100 kilometers (L/100 km) or miles per gallon (mpg). This number changes frequently as driving conditions change. It cannot be reset.

AVG (Average) Speed

Displays the average speed of the vehicle in either kilometers per hour (km/h) or miles per hour (mph). This calculation is based on the various vehicle speeds recorded since the last reset of this display. Press the set/reset button to reset to zero.

Speedometer

Displays a digital speedometer in the DIC. The speed displays in either kilometers per hour (km/h) or miles per hour (mph). To change the units from English to metric, see "Units" later in this section.

Blank Display

This display shows no information.

Vehicle Information Display Menu Items

 **(Vehicle Information):** Press to display the following menu items:

Oil Life Remaining

If the vehicle has this display, it shows the estimated oil life remaining. If you see 99% Oil Life Remaining on the display, that means that 99% of the current oil life remains.

When the oil life is depleted, the Change Engine Oil Soon message displays. Change the oil as soon as possible. Additional maintenance is also recommended in the Maintenance Schedule in this manual. See *Maintenance Schedule on page 11-4* and *Engine Oil on page 10-10*.

The Oil Life must be reset after each oil change. Avoid accidental resetting of the Oil Life system. It cannot be reset accurately until the next oil change. To reset the engine oil life system, See *Engine Oil Life System on page 10-13*. The system is reset when 100% displays.

Units

Select to display English or metric units of measure. Press the set/reset button to select when units is displayed.

Parking Assist

If the vehicle has the Ultrasonic Rear Parking Assist (URPA) system, this display allows the system to be turned on or off. Once in this display, press the set/reset button to select between On or Off. The URPA system automatically turns back on after each vehicle start. When the URPA system is turned off and the vehicle is shifted out of P (Park), the DIC displays the PARKING ASSIST OFF message as a reminder that the system has been turned off. See *Object Detection System Messages on page 5-40* and *Ultrasonic Parking Assist on page 9-43*.

Tire Pressure

Tire pressure is displayed in the DIC for each tire in either kilopascals (kPa) or pounds per square inch (psi). Press the vehicle information button until the DIC displays Front Tire kPa (PSI) Left ## Right ##. Press the vehicle

information button again until the DIC displays Rear Tire kPa (PSI) Left ## Right ##.

If a low tire pressure condition is detected by the system while driving, a message to add air to a specific tire displays. See *Tire Pressure on page 10-70* and *Tire Messages on page 5-44*.

Battery Voltage

This display shows the current battery voltage. The vehicle's charging system regulates voltage based on the state of the battery. The battery voltage may fluctuate when viewing this information on the DIC. This is normal.

If there is a problem with the battery charging system, the charging system light illuminates and/or the DIC displays a message. See *Charging System Light on page 5-18*, *Battery Voltage and Charging Messages on page 5-32* and *Battery Load Management on page 6-8*.

Side Blind Zone Alert

If your vehicle has the Side Blind Zone Alert (SBZA) system, this display allows the system to be turned on or off. Once in this display, press the set/reset button to select between ON or OFF. If you choose ON, the system will be turned on. If you choose OFF, the system will be turned off. When the SBZA system is turned off, the DIC will display the SIDE BLIND ZONE ALERT SYSTEM OFF message as a reminder that the system has been turned off. See *Object Detection System Messages on page 5-40* and *Side Blind Zone Alert (SBZA) on page 9-44*.

Calibrate Compass

The vehicle may have this feature. The compass can be manually calibrated. To calibrate the compass through the DIC, see *Compass on page 5-7*.

Change Compass Zone

The vehicle may have this feature. To change the compass zone through the DIC, see *Compass on page 5-7*.

Trans (Transmission) Temp (Temperature) (CTS-V Only)

This display shows the transmission fluid temperature in either degrees Celsius (°C) or degrees Fahrenheit (°F).

Oil Pressure (CTS-V Only)

This display shows the oil pressure in either kilopascals (kPa) or pounds per square inch (psi).

Lateral Acceleration (CTS-V Only)

Lateral Acceleration measures the force of a turn or corner. For example, when turning right, it forces to the left. This gauge displays the “g” force from 0.0 g to 2.0 g.

Blank Display

This display shows no information.

DIC Compass

The vehicle may have a compass in the Driver Information Center (DIC). See *Compass on page 5-7*.

Vehicle Messages

Messages displayed on the DIC indicate the status of the vehicle or some action that may be needed to correct a condition. Multiple messages may appear one after another.

The messages that do not require immediate action can be acknowledged and cleared by pressing ✓ (Set/Reset).

The messages that require immediate action cannot be cleared until that action is performed.

All messages should be taken seriously; clearing the message does not correct the problem.

The following are the possible messages and some information about them.

Battery Voltage and Charging Messages

BATTERY SAVER ACTIVE

This message displays when the system detects that the battery voltage is dropping below expected levels. The battery saver system starts reducing certain features of the vehicle that may be noticeable. At the point that the features are disabled, this message is displayed. It means that the vehicle is trying to save the charge in the battery.

Turn off all unnecessary accessories to allow the battery to recharge.

The normal battery voltage range is 11.5 to 15.5 volts. You can monitor battery voltage on the DIC by pressing the vehicle information button until Battery Voltage is displayed.

BATTERY VOLTS LOW

This message displays when the electrical system is charging less than 10 volts or the battery has been drained.

If this message appears immediately after starting the engine, it is possible that the generator can still recharge the battery. The battery should recharge while driving, but may take a few hours to do so. Consider using an auxiliary charger to boost the battery after returning home or arriving at a final destination. Make sure you follow the manufacturer's instructions.

If this message appears while driving or after starting the vehicle and stays on, have it checked immediately to determine the cause of this problem.

To help the generator recharge the battery quickly, reduce the load on the electrical system by turning off the accessories.

The normal battery voltage range is 11.5 to 15.5 volts. Monitor battery voltage on the DIC by pressing the vehicle information button until Battery Voltage is displayed.

SERVICE BATTERY CHARGING SYSTEM

This message displays when there is a problem with the generator and battery charging systems. Driving with this problem could drain the battery. Turn off all unnecessary accessories. Stop and turn off the vehicle as soon as it is safe to do so. Have the electrical system checked by your dealer. Under certain conditions, the charging system light may also turn on in the instrument cluster. See *Charging System Light* on page 5-18.

Brake System Messages

PARK BRAKE RELEASED

For vehicles with the electric parking brake, this message displays when the parking brake has been released from the set position. See the electric parking brake information under *Parking Brake (Manual)* on page 9-34 or *Parking Brake (Electric)* on page 9-35.

PARK BRAKE SET

For vehicles with the electric parking brake, this message displays when the parking brake has been applied to the set position. See the electric parking brake information under *Parking Brake (Manual)* on page 9-34 or *Parking Brake (Electric)* on page 9-35.

PRESS BRAKE TO START ENGINE (AUTOMATIC TRANSMISSION ONLY)

If equipped with the Keyless Access system, this message displays if you try to start the engine without having the brake pressed. The brake needs to be pressed when starting the engine. See *Ignition Positions (Keyless Access)* on page 9-15 or *Ignition Positions (Key Access)* on page 9-17.

RELEASE PARK BRAKE SWITCH

For vehicles with the electric parking brake, this message displays if the switch is pulled while the vehicle is moving. See the electric parking brake information under *Parking Brake (Manual)* on page 9-34 or *Parking Brake (Electric)* on page 9-35.

SERVICE BRAKE ASSIST

This message displays if there is a problem with the brake system. The brake system warning light and the antilock brake system (ABS) warning light may also display on the instrument cluster. See *Brake System Warning Light* on page 5-22 and *Antilock Brake System (ABS) Warning Light* on page 5-23. Stop as soon as possible and turn off the vehicle. Restart the vehicle and check for the message on the DIC display. If the message displays immediately or again after you begin driving, the brake system needs service. See your dealer as soon as possible. See *Antilock Brake System (ABS)* on page 9-33.

SERVICE BRAKE SYSTEM

This message displays, while the ignition is on, when the brake fluid level is low. The brake system warning light on the instrument panel cluster also comes on. See *Brake System Warning Light on page 5-22*. This message may also be displayed for other brake system problems. Have the brake system serviced by your dealer as soon as possible.

SERVICE PARK BRAKE

For vehicles with the electric parking brake, this message displays if a problem is detected with the electric parking brake system. See your dealer for service.

STEP ON BRAKE TO RELEASE PARK BRAKE

For vehicles with the electric parking brake, this message displays if you try to release the park brake system without first pressing the brake pedal. See the electric parking brake information under *Parking Brake (Manual) on page 9-34* or *Parking Brake (Electric) on page 9-35*.

Compass Messages

CALIBRATING DRIVE IN CIRCLES

This message displays when calibrating the compass. Drive the vehicle in circles at less than 8 km/h (5 mph) to complete the calibration. See *Compass on page 5-7* for more information.

CALIBRATION COMPLETE

This message displays when the compass calibration is complete. See *Compass on page 5-7* for more information.

Cruise Control Messages

CRUISE SET TO XXX MPH (KM/H)

This message displays whenever the cruise control is set. See *Cruise Control on page 9-41* for more information.

Door Ajar Messages

DRIVER DOOR OPEN

This message displays when the driver door is not closed completely. Close the door completely.

HOOD OPEN

This message displays when the hood is not closed completely. Make sure that the hood is closed completely.

LEFT REAR DOOR OPEN

This message displays when the driver side rear door is not closed completely. Make sure that the door is closed completely.

PASSENGER DOOR OPEN

This message displays when the passenger side front door is not closed completely. Make sure that the door is closed completely.

REAR ACCESS OPEN (Wagon)

This message displays when the liftgate is not closed completely. Make sure that the liftgate is closed completely.

RIGHT REAR DOOR OPEN

This message displays when the passenger side rear door is not closed completely. Make sure that the door is closed completely.

TRUNK OPEN (Sedan and Coupe)

This message displays when the trunk is not closed completely. Make sure that the trunk is closed completely.

Engine Cooling System Messages**ENGINE HOT A/C (AIR CONDITIONING) OFF**

This message displays when the engine coolant becomes hotter than the normal operating temperature. See *Engine Coolant Temperature Gauge* on page 5-16. To avoid added strain on a hot engine, the air conditioning compressor automatically turns off. When the coolant temperature returns to normal, the air conditioning compressor turns back on. You can continue to drive the vehicle.

If this message continues to appear, have the system repaired by your dealer as soon as possible to avoid damage to the engine.

ENGINE OVERHEATED IDLE ENGINE

This message displays when the engine coolant temperature is too hot. Stop and allow the vehicle to idle until it cools down. If the message does not clear in a few minutes or if the overheat light stays on, shut the vehicle off and have it serviced before driving again. See *Engine Coolant Temperature Warning Light* on page 5-24.

See *Overheated Engine Protection Operating Mode* on page 10-25 for information on driving to a safe place in an emergency.

Engine Oil Messages

CHANGE ENGINE OIL SOON

When this message displays, it means that service is required for the vehicle. See your dealer. See *Maintenance Schedule on page 11-4* and *Engine Oil on page 10-10*.

When you reset the CHANGE ENGINE OIL SOON message by clearing it from the display, you still must reset the engine oil life system separately. For more information on resetting the engine oil life system, see *Engine Oil Life System on page 10-13*.

ENGINE OIL LOW ADD OIL

On some vehicles, this message displays if the oil level in the vehicle is low. Check the oil level before filling to the recommended level. You may need to let the vehicle cool or warm up and cycle the ignition to be sure this message clears.

If the oil is not low and this message continues to be displayed, take the vehicle to your dealer for service.

This message clears itself after 10 seconds, until the next ignition cycle. See *Engine Oil on page 10-10*.

OIL PRESSURE LOW STOP ENGINE

This message displays when the vehicle's engine oil pressure is low. The oil pressure light may also appear on the instrument cluster. See *Engine Oil Pressure Light on page 5-25*. See *Engine Oil on page 10-10*.

Stop the vehicle immediately, as engine damage can result from driving a vehicle with low oil pressure. Have the vehicle serviced by your dealer as soon as possible when this message is displayed.

Engine Power Messages

ENGINE POWER IS REDUCED

This message displays when the engine power is being reduced to protect the engine from damage. There could be several malfunctions that might cause this message. Reduced engine power can affect the vehicle's ability to accelerate. If this message is on, but there is no reduction in performance, proceed to your destination. The performance may be reduced the next time the vehicle is driven. The vehicle may be driven at a reduced speed while this message is on, but acceleration and speed may be reduced. Anytime this message stays on, take the vehicle to your dealer for service as soon as possible.

Fuel System Messages

FUEL LEVEL LOW

This message displays when the vehicle is low on fuel. Refill the fuel tank as soon as possible. A chime may sound when this message displays. See *Filling the Tank* on page 9-51.

TIGHTEN GAS CAP

This message displays when the fuel cap has not been fully tightened. Recheck the fuel cap to ensure that it is on and tightened properly.

Key and Lock Messages

ACCESSORY MODE ACTIVE

If equipped with the Keyless Access system, this message displays when the accessory mode is active. See *Ignition Positions (Keyless Access)* on page 9-15 or *Ignition Positions (Key Access)* on page 9-17.

ELECTRONIC KEY ALREADY KNOWN

If equipped with the Keyless Access system, this message displays if you try to match a transmitter that has already been learned. See the Keyless Access information for *Remote Keyless Entry (RKE) System Operation (Keyless Access)* on page 2-4 or *Remote Keyless Entry (RKE) System Operation (Key Access)* on page 2-9.

ELECTRONIC KEY NOT DETECTED

If equipped with the Keyless Access system, this message displays if the vehicle does not detect the presence of a transmitter when you have attempted to start the vehicle or a vehicle door has just closed.

The following conditions may cause this message to appear:

- Driver-added equipment plugged into the accessory power outlet on the center console is causing interference. Examples of these

devices are cell phones and cell phone chargers, two-way radios, power inverters, or similar items. Try moving the RKE transmitter away from these devices when starting the vehicle. In addition, PDA devices and remote garage and gate openers may also generate Electromagnetic Interference (EMI) that may interfere with the RKE transmitter. Do not carry the RKE transmitter in the same pocket or bag as these devices.

- The vehicle is experiencing Electromagnetic Interference (EMI). Some locations, such as airports, automatic toll booths, and some gas stations have EMI fields which may interfere with the RKE transmitter.

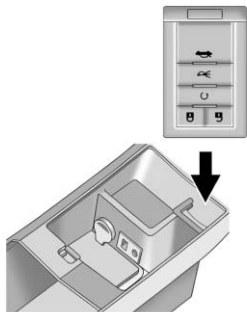

If moving the transmitter to different locations within the vehicle does not help, place the transmitter in the center console transmitter pocket with the buttons facing the front of the vehicle and then start the vehicle.

- The vehicle's battery voltage is low. The battery voltage must be above 10 volts for the RKE transmitter to be detected properly.

ELECTRONIC KEY NOT DETECTED RESTART ALLOWED

If equipped with the Keyless Access system, this message displays when the RKE transmitter is not detected inside the vehicle while you are trying to turn the ignition off. The vehicle may be near a strong radio antenna signal causing the Keyless Access system to be jammed. If you have the RKE transmitter with you, get out of the vehicle and lock the doors. If you do not have the RKE transmitter with you, you will be able to start the vehicle again within five minutes, or after the vehicle's content theft-deterrent system is armed. See *Starting the Engine on page 9-20*.

LEARN DELAY ACTIVE WAIT XX MIN (MINUTES)

If equipped with the Keyless Access system, this message displays when matching new transmitters to the vehicle. See the Keyless Access information for *Remote Keyless Entry (RKE) System Operation (Keyless Access) on page 2-4* or *Remote Keyless Entry (RKE) System Operation (Key Access) on page 2-9*.

MAXIMUM # ELECTRONIC KEYS LEARNED

If equipped with the Keyless Access system, this message displays when the maximum number of transmitters have been learned. See the Keyless Access information for *Remote Keyless Entry (RKE) System Operation (Keyless Access) on page 2-4* or *Remote Keyless Entry (RKE) System Operation (Key Access) on page 2-9*.

PRESS START CONTROL TO LEARN KEYS

If equipped with the Keyless Access system, this message displays when matching new transmitters to the vehicle. See the Keyless Access information for *Remote Keyless Entry (RKE) System Operation (Keyless Access)* on page 2-4 or *Remote Keyless Entry (RKE) System Operation (Key Access)* on page 2-9.

READY TO LEARN ELECTRONIC KEY # X

If equipped with the Keyless Access system, this message displays while matching new transmitters to the vehicle. See the Keyless Access information for *Remote Keyless Entry (RKE) System Operation (Keyless Access)* on page 2-4 or *Remote Keyless Entry (RKE) System Operation (Key Access)* on page 2-9.

REPLACE BATTERY IN REMOTE KEY

This message displays when the battery in the Remote Keyless Entry (RKE) transmitter needs to be replaced. To replace the battery, see “Battery Replacement” under *Remote Keyless Entry (RKE) System Operation (Keyless Access)* on page 2-4 or *Remote Keyless Entry (RKE) System Operation (Key Access)* on page 2-9.

ROTATE CONTROL TO OFF POSITION

If equipped with the Keyless Access system, this message displays as a reminder to turn the ignition off. To avoid draining the battery, make sure the ignition is turned off before leaving the vehicle.

SERVICE KEYLESS START SYSTEM

If equipped with the Keyless Access system, this message displays when there is a problem with this feature. See your dealer.

Lamp Messages

AFL (ADAPTIVE FORWARD LIGHTING) LAMPS NEED SERVICE

This message displays when the Adaptive Forward Lighting (AFL) system is disabled and needs service. See your dealer. See *Adaptive Forward Lighting (AFL)* on page 6-4 for more information.

AUTOMATIC LIGHT CONTROL OFF

This message displays when the automatic headlamps are turned off.

AUTOMATIC LIGHT CONTROL ON

This message displays when the automatic headlamps are turned on.

TURN SIGNAL ON

This message displays as a reminder to turn off the turn signal if you drive the vehicle for more than about 1.6 km (1 mi) with a turn signal on. A multiple chime sounds when this message displays.

Object Detection System Messages

PARKING ASSIST BLOCKED SEE OWNER'S MANUAL

If the vehicle has the Ultrasonic Rear Park Assist (URPA) system, this message displays if there is something interfering with the park assist system. See *Ultrasonic Parking Assist on page 9-43* for more information.

PARKING ASSIST OFF

After the vehicle has been started, this message displays to remind the driver that the URPA system has been turned off. This message also displays when there is a temporary condition causing the system to be disabled. See *Ultrasonic Parking Assist on page 9-43*. Press the set/reset button to acknowledge this message and clear it from the DIC display.

SERVICE PARKING ASSIST

This message displays if there is a problem with the Ultrasonic Rear Parking Assist (URPA) system. Do not use this system to help you park. See *Ultrasonic Parking Assist on page 9-43* for more information. See your dealer for service.

SERVICE SIDE BLIND ZONE ALERT SYSTEM

If this message appears, both SBZA displays will remain on indicating there is a problem with the SBZA system. If these displays remain on

after continued driving, the system needs service. Take the vehicle to your dealer.

SIDE BLIND ZONE ALERT SYSTEM OFF

This message indicates that the driver has turned the system off.

SIDE BLIND ZONE ALERT SYSTEM TEMPORARILY UNAVAILABLE

This message indicates that the SBZA system is disabled because the sensor is blocked and cannot detect vehicles in the blind zone. The sensor may be blocked by mud, dirt, snow, ice, or slush. This message may also activate during heavy rain or due to road spray. The vehicle does not need service. For cleaning, see *Exterior Care on page 10-112*.

Ride Control System Messages

ALL WHEEL DRIVE OFF

If the vehicle has the All-Wheel Drive (AWD) system, this message displays when there is a temporary condition making the AWD system unavailable. The vehicle will run in 2WD. This could be caused by:

- Loss of wheel or vehicle speed
- AWD system overheat
- Certain vehicle electrical conditions

This message turns off when the above conditions are no longer present and the warning message is reset.

To reset the warning message, turn the ignition off and then back on again after 30 seconds. If the message stays on, see your dealer right away. See *All-Wheel Drive on page 9-33*.

SERVICE ALL WHEEL DRIVE

This message displays if a problem occurs with the All-Wheel Drive (AWD) system. The vehicle will run in 2WD. This could be caused by:

- An electronics problem
- An AWD system oil overheat
- Worn out or overheated clutch plates
- Various electrical issues

If this message appears, stop as soon as possible and turn off the ignition for 30 seconds. Restart the vehicle and check for the message on the DIC display. If the message still displays or appears again when you begin driving, the system needs service. See your dealer right away.

SERVICE POWER STEERING

This message displays if a problem is detected with the speed variable assist steering system. When this message is displayed, you may

notice that the effort required to steer the vehicle increases or feels heavier, but you will still be able to steer the vehicle. See *Steering on page 9-4*.

SERVICE STABILITRAK

This message displays if there has been a problem detected with the StabiliTrak[®] system. The TCS/StabiliTrak warning light on the instrument cluster also comes on.

If this message comes on while you are driving, pull off the road as soon as possible and stop carefully. Try resetting the system by turning the ignition off then back on. If this message still stays on or comes back on again while you are driving, the vehicle needs service. Have the StabiliTrak system inspected by your dealer as soon as possible. See *Traction Control/Electronic Stability Control on page 9-38*.

SERVICE SUSPENSION SYSTEM

This message displays when there is a problem with the Magnetic Ride Control system. See *Magnetic Ride Control on page 9-40*. Have the vehicle serviced by your dealer.

SERVICE TRACTION CONTROL

This message displays when there is a problem with the Traction Control System (TCS). The TCS/StabiliTrak warning light on the instrument cluster also comes on. When this message displays, the system will not limit wheel spin. Adjust your driving accordingly. See your dealer for service. See *Traction Control/Electronic Stability Control on page 9-38*.

STABILITRAK COMPETITIVE MODE

This message displays when the Competitive Driving Mode is selected. When in this mode, the Traction Control System (TCS) will not be operating and the TCS/StabiliTrak warning light will turn on. Adjust your driving accordingly. See *Competitive Driving Mode on page 9-39*.

STABILITRAK NOT READY

This message may display after first driving the vehicle and exceeding 30 km/h (19 mph) for 30 seconds. The TCS/StabiliTrak warning light on the instrument cluster also comes on. The StabiliTrak system is not functional until the message has turned off. See *Traction Control/Electronic Stability Control on page 9-38*.

STABILITRAK OFF

This message displays when you turn off StabiliTrak, or when the stability control system has been automatically disabled. The TCS/StabiliTrak warning light on the instrument cluster also comes on.

To realize the full benefits of the stability enhancement system, you should normally leave StabiliTrak on. To turn StabiliTrak on or off, see *Traction Control/Electronic Stability Control on page 9-38*.

There are several conditions that can cause this message to appear:

- If there is overheating, which could occur if StabiliTrak activates continuously for an extended period of time.
- If the brake system warning light is on. See *Brake System Warning Light on page 5-22*.

- If the stability system takes longer than usual to complete its diagnostic checks due to driving conditions.
- If an engine or vehicle-related problem has been detected and the vehicle needs service. See your dealer.

The message turns off as soon as the conditions that caused the message to be displayed are no longer present.

SUSPENSION MODE SPORT (CTS-V ONLY)

This message will be displayed when sport mode is selected using the Magnetic Ride Control button in the center of the instrument panel. See *Magnetic Ride Control on page 9-40*.

SUSPENSION MODE TOUR (CTS-V ONLY)

This message will be displayed when touring mode is selected using the Magnetic Ride Control button in the center of the instrument panel. See *Magnetic Ride Control on page 9-40*.

TRACTION CONTROL OFF

This message displays when the traction control system has been turned off.

Airbag System Messages

SERVICE AIR BAG

This message displays when there is a problem with the airbag system. Have the vehicle serviced by your dealer immediately. See *Airbag Readiness Light on page 5-17* for more information.

Security Messages

SERVICE THEFT DETERRENT SYSTEM

This message displays when there is a problem with the theft-deterrent system programmed in the key. A fault has been detected in the system which means that the system is disabled and it is not protecting the vehicle. The vehicle usually restarts; however, you may want to take the vehicle to your dealer before turning off the engine. See *Immobilizer Operation (Key Access) on page 2-24* or *Immobilizer Operation (Keyless Access) on page 2-25*.

START ABORTED BY THEFT DETERRENT

This message displays if there is a communication problem between the Keyless Access system and the vehicle. The vehicle cannot be started when this message displays. See your dealer for service.

THEFT ATTEMPTED

This message displays if the theft-deterrent system has detected a break-in attempt while you were away from the vehicle. See *Vehicle Alarm System on page 2-23*.

Service Vehicle Messages

SERVICE A/C SYSTEM

This message displays when the electronic sensors that control the air conditioning and heating systems are no longer working. Have the climate control system serviced by your dealer if you notice a drop in heating and air conditioning efficiency.

SERVICE VEHICLE SOON

This message displays when a non-emissions related malfunction occurs. Have the vehicle serviced by your dealer as soon as possible.

Tire Messages

SERVICE TIRE MONITOR SYSTEM

This message displays if a part on the Tire Pressure Monitor System (TPMS) is not working properly. The tire pressure light also flashes and then remains on during the same ignition cycle. See *Tire Pressure Light on page 5-25*. Several conditions may cause this message to appear. See *Tire Pressure Monitor Operation on page 10-73* for more information. If the warning comes on and stays on, there may be a problem with the TPMS. See your dealer.

TIRE LEARNING ACTIVE

This message displays when the Tire Pressure Monitor System (TPMS) is re-learning the tire positions on the vehicle. The tire positions must be re-learned after rotating the tires or after replacing a tire or sensor. See *Tire Rotation on page 10-76*, *Tire Pressure Monitor System on page 10-72*, and *Tire Pressure on page 10-70* for more information.

TIRE LOW ADD AIR TO TIRE

On vehicles with the Tire Pressure Monitor System (TPMS), this message displays when the pressure in one or more of the vehicle's tires is low. This message also displays LEFT FRONT, RIGHT FRONT, LEFT REAR, or RIGHT REAR to indicate the location of the low tire.

The low tire pressure warning light will also come on. See *Tire Pressure Light* on page 5-25.

If a tire pressure message appears on the DIC, stop as soon as you can. Inflate the tires by adding air until the tire pressure is equal to the values shown on the Tire and Loading Information label. See *Tires* on page 10-61, *Vehicle Load Limits* on page 9-11, and *Tire Pressure* on page 10-70.

If the vehicle does not have a spare tire, the message will display **USE INFLATOR KIT IN TRUNK**. Use the inflator kit to inflate the tires to the correct pressure. See *Tire Sealant and Compressor Kit* on page 10-86 for more information.

More than one tire pressure message can be received at a time. To read the other messages, press the set/reset button.

The DIC display also shows the tire pressure values. See *Driver Information Center (DIC)* on page 5-27.

Transmission Messages

DIFFERENTIAL HOT, REDUCE SPEED (CTS-V ONLY)

This message displays and a chime sounds if the differential fluid temperature exceeds 150°C (300°F). Driving aggressively or at high speeds can cause the differential fluid temperature to be higher than normal. If this message appears, you may continue to drive at a slower speed. If you have been operating the vehicle under normal driving conditions, the vehicle may need service. See your dealer for an inspection.

To acknowledge the message, press ✓. The message reappears and a chime sounds every two minutes until this condition changes. If you do not clear the message, it will remain on until the condition changes.

SERVICE TRANSMISSION

This message displays when there is a problem with the vehicle's transmission. Have the vehicle serviced by your dealer.

SHIFT TO PARK (AUTOMATIC TRANSMISSION ONLY)

If equipped with the Keyless Access system, this message displays if the vehicle is not in P (Park) while the engine is being turned off. The vehicle will be in ACC/ACCESSORY. Once the shift lever is moved to P (Park), the ignition needs to be turned off. If the ignition is not turned off, the vehicle will remain in ACC/ACCESSORY. To avoid draining the battery, turn the ignition off before leaving the vehicle.

SPORT MODE

This message displays when the vehicle is in sport mode. The transmission gear position will also be displayed when DSC is in use. See *Manual Mode on page 9-28* for more information.

TRANSMISSION HOT IDLE ENGINE

This message displays when the transmission fluid in the vehicle is too hot. Stop the vehicle and allow it to idle until the transmission cools down or until this message is removed.

Vehicle Speed Messages

ICE POSSIBLE DRIVE WITH CARE

This message displays when the outside temperature is cold enough to create icy road conditions. Adjust your driving accordingly.

SPEED LIMITED TO XXX KM/H (MPH)

This message displays when the vehicle speed is limited to 128 km/h (80 mph) because the vehicle detects a problem in the speed variable assist steering or magnetic ride control systems. Have the vehicle serviced by your dealer.

Washer Fluid Messages

WASHER FLUID LOW ADD FLUID

This message displays when the vehicle is low on windshield washer fluid. Refill the windshield washer fluid reservoir as soon as possible. See *Washer Fluid on page 10-26* for more information.

Vehicle Personalization

Vehicle customization allows certain features to be programmed for one preferred setting.

Only the customization options available will be displayed on the DIC.

The default settings were preset when the vehicle left the factory, but may have been changed.

The customization preferences are automatically recalled.

To change customization preferences, use the following procedure.

Entering the Feature Settings Menu

1. Turn the ignition on.

To avoid excessive drain on the battery, it is recommended that the headlamps are turned off.

2. Press the customization button to enter the feature settings menu.

Feature Settings Menu Items

The following are customization features that allow you to program settings to the vehicle.

Display In English

This feature will only display if a language other than English has been set. This feature allows for changing the language of the DIC messages back to English.

Press the customization button until the Press ✓ To Display In English screen appears on the DIC display. Press the set/reset button once to select English as the language in which all DIC messages will appear.

Display Language

This feature allows you to select the language in which the DIC messages will appear.

Press the customization button until the Display Language screen appears on the DIC display. Press the set/reset button once to access the settings for this feature. Then press the menu up/down button to scroll through the following settings.

English (default): All messages will appear in English.

Deutsch: All messages will appear in German.

Italiano: All messages will appear in Italian.

Francais: All messages will appear in French.

Espanol: All messages will appear in Spanish.

Portuguese: All messages will appear in Portuguese.

Arabic: All messages will appear in Arabic.

Chinese: All messages will appear in Chinese.

Japanese: All messages will appear in Japanese.

Russian: All messages will appear in Russian.

No Change: No change will be made to this feature. The current setting will remain.

To select a setting, press the set/reset button while the desired setting is displayed on the DIC.

Auto Door Lock

This feature allows you to select when the vehicle's doors will automatically lock. See *Automatic Door Locks on page 2-16*.

Press the customization button until Auto Door Lock appears on the DIC display. Press the set/reset button once to access the settings for this feature. Then press the menu up/down button to scroll through the following settings.

Shift Out Of Park (default on Automatic Transmission) (Automatic Transmission Only): The vehicle's doors automatically lock when the doors are closed and the vehicle is shifted out of P (Park).

At Vehicle Speed (default on Manual Transmission): The vehicle's doors automatically lock when the vehicle speed is above 8 km/h (5 mph) for three seconds.

No Change: No change will be made to this feature. The current setting will remain.

To select a setting, press the set/reset button while the desired setting is displayed on the DIC.

Auto Door Unlock

This feature allows you to select whether or not the door(s) will automatically unlock. It also allows you to select which doors and when they will automatically unlock. See *Automatic Door Locks on page 2-16*.

Press the customization button until Auto Door Unlock appears on the DIC display. Press the set/reset button once to access the settings for this feature. Then press the menu up/down button to scroll through the following settings.

Off: None of the doors will automatically unlock.

Driver Only At Off: Only the driver door will unlock when the ignition is turned off.

All At Off (default on Manual Transmission): All of the doors will unlock when the ignition is turned off.

All In Park (default on Automatic Transmission) (Automatic Transmission Only): All of the doors will unlock when the vehicle is shifted into P (Park).

No Change: No change will be made to this feature. The current setting will remain.

To select a setting, press the set/reset button while the desired setting is displayed on the DIC.

Remote Door Lock Feedback

This feature allows you to select the type of feedback you will receive when locking the vehicle with the Remote Keyless Entry (RKE) transmitter, or when the vehicle is automatically locked using the Keyless Locking feature. You will not receive feedback when locking the vehicle with the transmitter if the doors are open. See *Remote Keyless Entry (RKE) System Operation (Keyless Access) on page 2-4* or *Remote Keyless Entry (RKE) System Operation (Key Access) on page 2-9*, or "Keyless Locking" later in this section for more information.

Press the customization button until Remote Door Lock appears on the DIC display. Press the set/reset button once to access the settings for this feature. Then press the menu up/down button to scroll through the following settings.

Off: There will be no feedback when you press the lock button on the transmitter.

Lights Only: The exterior lamps will flash when you press the lock button on the transmitter.

Horn Only: The horn will sound on the second press of the lock button on the transmitter.

Horn & Lights (default): The exterior lamps will flash when you press the lock button on the transmitter, and the horn will sound when the lock button is pressed again within five seconds of the previous command.

No Change: No change will be made to this feature. The current setting will remain.

To select a setting, press the set/reset button while the desired setting is displayed on the DIC.

Remote Door Unlock Feedback

This feature allows you to select the type of feedback you will receive when unlocking the vehicle with the Remote Keyless Entry (RKE) transmitter, or when the vehicle is automatically unlocked using the Keyless Unlock feature. You will not receive feedback when unlocking the vehicle with the transmitter if the doors are open. See *Remote Keyless Entry (RKE) System Operation (Keyless Access)* on page 2-4 or *Remote Keyless Entry (RKE) System Operation (Key Access)* on page 2-9 or “Keyless Unlock” later in this section for more information.

Press the customization button until Remote Door Unlock appears on the DIC display. Press the set/reset button once to access the settings

for this feature. Then press the menu up/down button to scroll through the following settings.

Lights Off: The exterior lamps will not flash when you press the unlock button on the transmitter.

Lights On (default): The exterior lamps will flash when you press the unlock button on the transmitter.

No Change: No change will be made to this feature. The current setting will remain.

To select a setting, press the set/reset button while the desired setting is displayed on the DIC.

Exit Lighting

This feature allows you to select the amount of time you want the exterior lamps to remain on when it is dark enough outside. This happens after the key is turned from ON/RUN to LOCK/OFF.

Press the customization button until Exit Lighting appears on the DIC display. Press the set/reset button once to access the settings for this feature. Then press the menu up/down button to scroll through the following settings.

Off: The exterior lamps will not turn on.

10 Seconds (default): The exterior lamps will stay on for 10 seconds.

30 Seconds: The exterior lamps will stay on for 30 seconds.

2 Minutes: The exterior lamps will stay on for two minutes.

No Change: No change will be made to this feature. The current setting will remain.

To select a setting, press the set/reset button while the desired setting is displayed on the DIC.

Approach Lighting

This feature allows you to select whether or not to have the exterior lights turn on briefly during low light periods after unlocking the vehicle using the Remote Keyless Entry (RKE) transmitter.

Press the customization button until Approach Lighting appears on the DIC display. Press the set/reset button once to access the settings for this feature. Then press the menu up/down button to scroll through the following settings.

Off: The exterior lights will not turn on when you unlock the vehicle with the transmitter.

On (default): If it is dark enough outside, the exterior lights will turn on briefly when you unlock the vehicle with the transmitter.

The lights will remain on for 20 seconds or until the lock button on the transmitter is pressed, or the vehicle is no longer off. See *Remote Keyless Entry (RKE) System Operation (Keyless Access)* on page 2-4 or *Remote Keyless Entry (RKE) System Operation (Key Access)* on page 2-9.

No Change: No change will be made to this feature. The current setting will remain.

To select a setting, press the set/reset button while the desired setting is displayed on the DIC.

Factory Settings

This feature allows you to set all of the customization features back to their factory default settings.

Press the customization button until Factory Settings appears on the DIC display. Press the set/reset button once to access the settings for this feature. Then press the menu up/down button to scroll through the following settings.

Restore All (default): The customization features will be set to their factory default settings.

No Change: The customization features will not be set to their factory default settings.

To select a setting, press the set/reset button while the desired setting is displayed on the DIC.

Keyless Locking

If equipped with the Keyless Access system, this feature allows you to select whether the doors automatically lock during normal vehicle exit. When the ignition is turned off and all doors become closed, the vehicle will determine how many RKE transmitters remain in the vehicle interior. If at least one

RKE transmitter has been removed from the interior of the vehicle, the doors will lock after several seconds.

For example, if there are two RKE transmitters in the vehicle and one is removed, the other will be locked in. The RKE transmitter locked in the vehicle can still be used to start the vehicle or unlock the doors, if needed. A person approaching the outside of the locked vehicle without an authorized RKE transmitter, however, will not be able to open the door, even with a transmitter in the vehicle. See the Keyless Access information for *Remote Keyless Entry (RKE) System Operation (Keyless Access)* on page 2-4 or *Remote Keyless Entry (RKE) System Operation (Key Access)* on page 2-9.

You may temporarily disable the keyless locking feature by pressing the door unlock switch for three seconds on an open door. To enable keyless locking, transition the power mode from off.

To select whether the horn sounds or the lights flash when the vehicle is locked, see “Remote Door Lock” earlier in this section.

Press the customization button until Keyless Locking appears on the DIC display. Press the set/reset button once to access the settings for this feature. Then press the menu up/down button to scroll through the following settings.

Off (default): The keyless locking feature will be disabled.

On: The keyless locking feature will be enabled.

The doors will automatically lock several seconds after you turn the ignition off, remove an RKE transmitter from the interior of the vehicle, and close all of the doors.

No Change: No change will be made to this feature. The current setting will remain.

To select a setting, press the set/reset button while the desired setting is displayed on the DIC.

Keyless Unlock

If equipped with the Keyless Access system, this feature allows you to select which doors will automatically unlock when you approach the vehicle with the RKE transmitter and open the driver door. See the Keyless Access information for *Remote Keyless Entry (RKE) System Operation (Keyless Access) on page 2-4* or *Remote Keyless Entry (RKE) System Operation (Key Access) on page 2-9*.

To select whether the lights flash when the vehicle is unlocked, see “Remote Door Unlock” earlier in this section.

Press the customization button until Keyless Unlock appears on the DIC display. Press the set/reset button once to access the settings for this feature. Then press the menu up/down button to scroll through the following settings.

Entry Door Only: Only the driver door will automatically unlock when you approach the vehicle with the RKE transmitter and open the driver door.

All Doors (default): All doors will automatically unlock when you approach the vehicle with the RKE transmitter and open the driver door.

No Change: No change will be made to this feature. The current setting will remain.

To select a setting, press the set/reset button while the desired setting is displayed on the DIC.

Chime Volume

This feature allows you to select the volume level of the chime.

Press the customization button until Chime Volume appears on the DIC display. Press the set/reset button once to access the settings for this

feature. Then press the menu up/down button to scroll through the following settings.

Normal: The chime volume will be set to a normal level.

Loud: The chime volume will be set to a loud level.

No Change: No change will be made to this feature. The current setting will remain.

There is no default for chime volume. The volume will stay at the last known setting.

To select a setting, press the set/reset button while the desired setting is displayed on the DIC.

Entry/Exit Recall

If the vehicle has this feature, it allows you to select your preferred automatic recall of stored memory and exit positions. See *Memory Seats on page 3-7*.

Press the customization button until Entry/Exit Recall appears on the DIC display. Press the set/reset button once to access the settings for this feature. Then press the menu up/down button to scroll through the following settings.

To select a setting, press the set/reset button while the desired setting is displayed on the DIC.

Entry/Exit Recall Off (default): No automatic Entry/Exit Recall will occur when entering or leaving the vehicle. The Exit Recall will only occur after pressing the door mounted exit button. This button will cause the driver seat to move rearward a certain distance, and the steering column to move full up and full forward, if equipped. Entry Recall will only occur by pressing the door mounted “1” or “2” button.

Entry/Exit Recall On (Vehicles without Power Tilt Steering Wheel): If this setting is selected the following option will be available:

Easy Exit will automatically move the driver seat rearward a certain distance when the key is removed from the ignition on key access vehicles, or when the ignition is turned off and the driver door is opened on Keyless Access vehicles. This movement will also occur when the door mounted exit button is pressed.

Easy Entry will automatically recall the driver seat and outside mirror memory positions of the current driver (1 or 2) when the ignition is turned on.

Entry/Exit Recall On (Vehicles with Power Tilt Steering Wheel): If this setting is selected the following two options will be available:

- **Entry/Exit Steering and Seat:** Easy Exit will automatically move the steering column to a full up and full forward position and move the driver seat rearward a certain distance when the key is removed from the ignition on key access vehicles, or when the ignition is turned off and the driver door is opened on Keyless Access vehicles. These movements will also occur when the door mounted exit button is pressed.

Easy Entry will automatically recall the driver seat, outside mirrors, and steering column memory positions of the current driver (1 or 2) when the ignition is turned on.

- **Entry/Exit Steering Only:** Easy Exit will automatically move the steering column to a full up and full forward position when the key is removed from the ignition on key access vehicles, or when the ignition is turned off and the driver door is opened on Keyless Access vehicles. This movement will also occur when the door mounted exit button is pressed.

Easy Entry will automatically recall the driver seat, outside mirrors, and steering column memory positions of the current driver (1 or 2) when the ignition is turned on.

No Change: No change will be made to this feature. The current setting will remain.

Exiting the Feature Settings Menu

The feature settings menu will be exited when any of the following occurs:

- The vehicle is no longer in ON/RUN.
- The trip/fuel or vehicle information DIC buttons are pressed.
- The end of the feature settings menu is reached and exited.
- A 40-second time period has elapsed with no selection made.

Universal Remote System

See *Radio Frequency Statement on page 13-15*.

Universal Remote System Programming

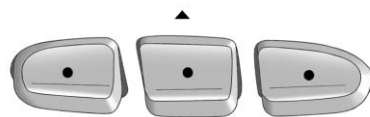

If equipped, these buttons are in the overhead console.

This system can replace up to three remote control transmitters used to activate devices such as garage door openers, security systems, and home automation devices. These instructions refer to a garage door opener, but can be used for other devices.

Do not use the Universal Remote system with any garage door opener that does not have the stop and reverse feature. This includes any garage door opener model manufactured before April 1, 1982.

Read these instructions completely before programming the Universal Remote system. It may help to have another person assist with the programming process.

Keep the original hand-held transmitter for use in other vehicles as well as for future programming. Erase the programming when vehicle ownership is terminated. See "Erasing Universal Remote System Buttons" later in this section.

To program a garage door opener, park outside directly in line with and facing the garage door opener receiver. Clear all people and objects near the garage door.

Make sure the hand-held transmitter has a new battery for quicker and more accurate transmission of the radio-frequency signal.

Programming the Universal Remote System

For questions or help programming the Universal Remote system, call 1-800-355-3515 or see www.homelink.com.

Programming involves time-sensitive actions, and may time out causing the procedure to be repeated.

To program up to three devices:

1. Hold the end of the hand-held transmitter about 3 to 8 cm (1 to 3 in) away from the Universal Remote system buttons with the indicator light in view. The hand-held transmitter was supplied by the manufacturer of the garage door opener receiver.

2. At the same time, press and hold both the hand-held transmitter button and one of the three Universal Remote system buttons to be used to operate the garage door. Do not release either button until the indicator light changes from a slow to a rapid flash. Then release both buttons.

Some garage door openers may require substitution of Step 2 with the procedure under "Radio Signals for Canada and Some Gate Operators" later in this section.

5-56 Instruments and Controls

3. Press and hold the newly programmed Universal Remote system button for five seconds while watching the indicator light and garage door activation.

- If the indicator light stays on continuously or the garage door moves when the button is pressed, then programming is complete. There is no need to complete Steps 4–6.
- If the indicator light does not come on or the garage door does not move, a second button press may be required. For a second time, press and hold the newly programmed button for five seconds. If the light stays on or the garage door moves, programming is complete.

- If the indicator light blinks rapidly for two seconds, then changes to a solid light and the garage door does not move, continue with programming Steps 4–6.

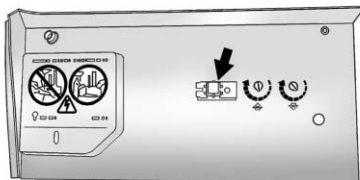

Learn or Smart Button

4. After completing Steps 1–3, locate the Learn or Smart button inside the garage on the garage door opener receiver. The name and color of the button may vary by manufacturer.
5. Press and release the Learn or Smart button. Step 6 must be completed within 30 seconds of pressing this button.

6. Inside the vehicle, press and hold the newly programmed Universal Remote system button for two seconds, then release it. If the garage door does not move or the lamp on the garage door opener receiver does not flash, press and hold the same button a second time for two seconds, then release it. Again, if the door does not move or the garage door lamp does not flash, press and hold the same button a third time for two seconds, then release it.

The Universal Remote system should now activate the garage door.

Repeat the process for programming the two remaining buttons.

Radio Signals for Canada and Some Gate Operators

For questions or programming help, call 1-800-355-3515 or see www.homelink.com.

Canadian radio-frequency laws and some U.S. gate operators require transmitter signals to time out or quit after several seconds of transmission. This may not be long enough for the Universal Remote system to pick up the signal during programming.

If the programming did not work, replace Step 2 under "Programming the Universal Remote System" with the following:

Press and hold the Universal Remote system button while pressing and releasing the hand-held transmitter button every two seconds until the signal has been successfully accepted by the Universal Remote system. The Universal Remote system indicator light will flash slowly at first and then

rapidly. Proceed with Step 3 under "Programming the Universal Remote System" to complete.

Universal Remote System Operation

Using the Universal Remote System

Press and hold the appropriate Universal Remote system button for at least one-half second. The indicator light will come on while the signal is being transmitted.

Erasing Universal Remote System Buttons

Erase all programmed buttons when vehicle ownership is terminated.

To erase:

1. Press and hold the two outside buttons until the indicator light begins to flash. This should take about 10 seconds.
2. Release both buttons.

Reprogramming a Single Universal Remote System Button

To reprogram any of the system buttons:

1. Press and hold any one of the buttons. Do not release the button.
2. The indicator light will begin to flash after 20 seconds. Without releasing the button, proceed with Step 1 under "Programming the Universal Remote System."

Lighting

Exterior Lighting

Exterior Lamp Controls	6-1
Exterior Lamps Off Reminder	6-2
Headlamp High/Low-Beam Changer	6-2
Flash-to-Pass	6-2
Daytime Running Lamps (DRL)	6-2
Automatic Headlamp System	6-3
Adaptive Forward Lighting (AFL)	6-4
Hazard Warning Flashers	6-4
Turn and Lane-Change Signals	6-5
Fog Lamps	6-5

Interior Lighting

Instrument Panel Illumination Control	6-6
Reading Lamps	6-6

Lighting Features

Entry Lighting	6-7
Exit Lighting	6-7
Parade Dimming	6-7
Battery Load Management	6-8
Battery Power Protection	6-8
Exterior Lighting Battery Saver	6-9

Exterior Lighting

Exterior Lamp Controls

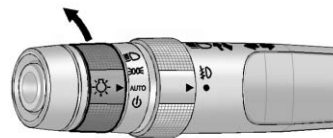

The exterior lamp control is toward the end of the turn signal lever.

☀️ (Exterior Lamp Control): Turn the band with this symbol on it to operate the exterior lamps.

The exterior lamp control has four positions:

⏻ (Off): Turns off all lamps, except the Daytime Running Lamps (DRL).

AUTO (Automatic): Automatically turns the exterior lamps on and off, depending on outside lighting.

🅂 (Parking Lamps): Turns on the parking lamps including all lamps, except the headlamps.

6-2 Lighting

 **(Headlamps):** Turns on the headlamps together with the parking lamps and instrument panel lights.

Exterior Lamps Off Reminder

A warning chime will sound if the exterior lamp control is left on in either the headlamp or parking lamp position and the driver door is opened with the ignition off.

Headlamp High/Low-Beam Changer

Push the turn signal lever away from you to turn the high beams on. Pull the lever toward you and then release it to return to low beams.

If the vehicle is turned off while the high beams are on, they will come on the next time the vehicle is started.



This indicator light turns on in the instrument cluster when the high-beam headlamps are on.

Flash-to-Pass

This feature allows the high-beam headlamps to be used to signal the driver in front of you that you want to pass.

Pull and hold the turn signal lever toward you to use this feature. When this is done the following will occur:

- If the headlamps are off or in low-beam mode, the high-beam headlamps will turn on at full brightness. Release the lever to turn them off.

- If the headlamps are already in high-beam mode, they will remain on high beam.

Daytime Running Lamps (DRL)

DRL can make it easier for others to see the front of your vehicle during the day. Fully functional DRL are required on all vehicles first sold in Canada.

The DRL system will make either the reduced intensity low-beam headlamps or dedicated DRLs come on when the following conditions are met:

- It is still daylight and the ignition is in ON/RUN or START.
- The exterior lamp control is in  or AUTO and the headlamps are off.
- The automatic transmission is not in P (Park).

When DRLs are on, only the reduced intensity low-beam headlamps or dedicated DRLs will be on. The other exterior lamps and the instrument cluster will not be on.

When the exterior lamp control is in AUTO and it is dark enough outside, the DRL turn off and the low-beam headlamps will turn on. When it is bright enough outside, the low-beam headlamps will go off, and the DRL will turn back on. If the vehicle is started in a dark garage, the automatic headlamp system comes on immediately. Once the vehicle leaves the garage, it takes about one minute for the automatic headlamp system to change to DRL if it is light outside. During that delay, the instrument cluster may not be as bright as usual. Make sure the instrument panel brightness knob is in the full bright position. See *Instrument Panel Illumination Control* on page 6-6.

Turning the exterior lamp control to off or to the low-beam headlamp position will turn off the DRL. If the parking lamps or the fog lamps were turned on instead, the DRL will still turn off.

This will work regardless of gear position and whether or not the parking brake is set.

When the DRL are active and a turn signal is operated, the DRL on the side the turn signal is activated, will turn off until the turn signal is turned off.

Automatic Headlamp System

When it is dark enough outside, the automatic headlamp system turns on the headlamps at the normal brightness, along with the taillamps, sidemarker, parking lamps, and the instrument panel lights. The radio lights will also be dim.

To turn off the automatic headlamp system, turn the exterior lamp control to the off position and then release it.

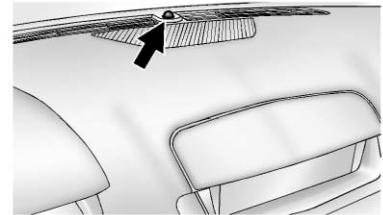

The vehicle has a light sensor on the top of the instrument panel in the defroster grille which regulates when the automatic headlamps turn on. Do not cover the sensor, otherwise the headlamps will come on whenever the ignition is on.

The system may also turn on the headlamps when driving through a parking garage, heavy overcast weather, or a tunnel. This is normal.

6-4 Lighting



If the vehicle is started in a dark garage, the automatic headlamp system will come on immediately. Once the vehicle leaves the garage, it takes approximately one minute for the automatic headlamp system to change if it is bright enough outside. During that delay, the instrument cluster may not be as bright as usual. Make sure the instrument panel brightness control is in the full bright position. See *Instrument Panel Illumination Control* on page 6-6.

To idle the vehicle with the automatic headlamp system off, turn the control to the off position.

The headlamps will also stay on after you exit the vehicle. This feature can be programmed using the Driver Information Center (DIC). See *Vehicle Personalization* on page 5-46.

The regular headlamp system can be turned on when needed.

Lights On with Wipers

If the windshield wipers are activated in daylight with the engine on, and the exterior lamp control is in AUTO, the headlamps, parking lamps, and other exterior lamps come on. The transition time for the lamps coming on varies based on wiper speed. When the wipers are not operating, these lamps turn off. Move the exterior lamp control to  or  to disable this feature.

Adaptive Forward Lighting (AFL)

If equipped, the Adaptive Forward Lighting System (AFL) pivots the headlamps horizontally to provide greater road illumination while turning. To enable AFL, set the exterior lamp control on the turn signal lever to the AUTO position. Moving the switch out of the AUTO position will deactivate the system. AFL will operate when the vehicle speed is greater than 3 km/h

(2 mph). AFL will not operate when the transmission is in R (Reverse). AFL is not immediately operable after starting the vehicle; driving a short distance is required to calibrate the AFL. See *Exterior Lamp Controls* on page 6-1.

Hazard Warning Flashers



 **(Hazard Warning Flasher):** Press this button to make the front and rear turn signal lamps flash on and off. This warns others that you are having trouble. Press again to turn the flashers off.

Turn and Lane-Change Signals

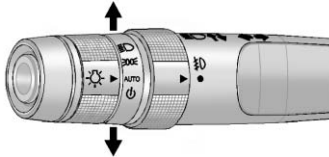

Move the lever all the way up or down to signal a turn.

An arrow on the instrument cluster flashes in the direction of the turn or lane change.

Raise or lower the lever until the arrow starts to flash to signal a lane change. Hold it briefly until the lane change is complete. The arrow will automatically flash three times.

The lever returns to its starting position when it is released.

If after signaling a turn or lane change the arrow flashes rapidly or does not come on, a signal bulb may be burned out.

Have any burned out bulbs replaced. If a bulb is not burned out, check the fuse. See *Fuses and Circuit Breakers* on page 10-38.

Turn Signal On Chime

If the turn signal is left on for about 1.6 km (1 mi), a warning chime will sound and the TURN SIGNAL ON message will appear on the Driver Information Center (DIC) display. See "Turn Signal On" under *Lamp Messages* on page 5-39.

Fog Lamps

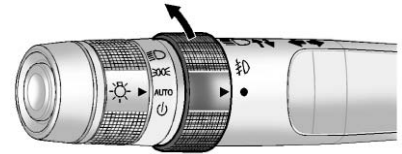

Use the fog lamps for better vision in foggy or misty conditions. The fog lamp control is on the turn signal lever.

☞ (Fog Lamps): Turn the fog lamp band on the lever up to ☞ and release it, to turn the fog lamps on or off. The band will return to its original position.

The parking lamps must be on for the fog lamps to work.

6-6 Lighting

If the high-beam headlamps are turned on, the fog lamps will also turn off. They will turn back on again when you change back to low-beam headlamps.

Some localities have laws that require the headlamps to be on along with the fog lamps.

Interior Lighting

Instrument Panel Illumination Control

The instrument panel brightness knob is on the instrument panel next to the steering column.



(Instrument Panel

Brightness): Turn the knob clockwise or counterclockwise to brighten or dim the lights. Turn the knob completely clockwise to turn on the interior lamps.

Reading Lamps



The reading lamps are on the overhead console. These lamps come on automatically when any door is opened.

For manual operation, press the button next to each lamp to turn it on or off.

If the reading lamps are left on, they automatically shut off 10 minutes after the ignition has been turned off.

Lighting Features

Entry Lighting

The headlamps, taillamps, license plate lamps, dome lamps, and most of the interior lights turn on briefly when the Remote Keyless Entry (RKE)  is pressed, or when the door handle is pulled on a keyless access vehicle. See *Ignition Positions (Keyless Access)* on page 9-15 or *Ignition Positions (Key Access)* on page 9-17. After about 30 seconds the exterior lamps turn off, then the dome and remaining interior lights dim to off. Entry lighting can be disabled manually by changing the ignition out of the OFF position, or by pressing the Remote Keyless Entry (RKE)  button.

This feature can be changed. See *Vehicle Personalization* on page 5-46.

Exit Lighting

The headlamps, taillamps, parking lamps, and license plate lamps come on at night, or in areas with limited lighting, when the key is removed from the ignition. The dome lamps also come on when the key is removed from the ignition. The exterior lamps and dome lamps remain on after the door is closed for a set amount of time, then automatically turn off.

If equipped with Keyless Access, the exterior lamps and dome lamps automatically turn on when a door is opened after the ignition is turned off. See *Ignition Positions (Keyless Access)* on page 9-15 or *Ignition Positions (Key Access)* on page 9-17.

The exterior lamps turn off immediately by turning the exterior lamp control off.

This feature can be changed. See *Vehicle Personalization* on page 5-46.

Parade Dimming

This feature does not let the instrument panel display screens dim during daylight hours while the ignition is in the ACC/ACCESSORY or ON/RUN position and the parking lamps or headlamps are on. Parade dimming automatically works with the light sensor on top of the dashboard. If it is dark enough outside and the parking lamps or headlamps are on, the instrument panel display screens can be adjusted by turning the instrument panel brightness knob clockwise or counterclockwise to brighten or dim the lighting. See *Instrument Panel Illumination Control* on page 6-6. The instrument panel control backlighting can still be adjusted while in parade mode.

Battery Load Management

The vehicle has Electric Power Management (EPM), which estimates the battery's temperature and state of charge. It then adjusts the voltage for best performance and extended life of the battery.

When the battery's state of charge is low, the voltage is raised slightly to quickly bring the charge back up. When the state of charge is high, the voltage is lowered slightly to prevent overcharging. If the vehicle has a voltmeter gauge or a voltage display on the Driver Information Center (DIC), you may see the voltage move up or down. This is normal. If there is a problem, an alert will be displayed.

The battery can be discharged at idle if the electrical loads are very high. This is true for all vehicles.

This is because the generator (alternator) may not be spinning fast enough at idle to produce all the power that is needed for very high electrical loads.

A high electrical load occurs when several of the following are on, such as: headlamps, high beams, fog lamps, rear window defogger, climate control fan at high speed, heated seats, engine cooling fans, trailer loads, and loads plugged into accessory power outlets.

EPM works to prevent excessive discharge of the battery. It does this by balancing the generator's output and the vehicle's electrical needs. It can increase engine idle speed to generate more power, whenever needed. It can temporarily reduce the power demands of some accessories.

Normally, these actions occur in steps or levels, without being noticeable. In rare cases at the highest levels of corrective action, this action may be noticeable to the driver. If so, a Driver Information Center (DIC) message might be displayed. If a battery message is displayed, it is recommended that the driver reduce the electrical loads as much as possible. See *Driver Information Center (DIC) on page 5-27*.

Battery Power Protection

This feature helps to prevent battery drain if accessory lamps are left on. If accessory lamps such as the vanity mirror, cargo, reading, console, or glove box are left on, they automatically time out after about 10 minutes. To reset the battery protection, all of the above lamps must be turned off or the ignition must be in the ACC/ACCESSORY position.

Exterior Lighting Battery Saver

The exterior lamps turn off about 10 minutes after the ignition is turned off, if the parking lamps or headlamps have been manually left on. This protects against draining the battery. To restart the 10-minute timer, turn the exterior lamp control to the off position and then back to the parking lamp or headlamp position.

To keep the lamps on for more than 10 minutes, the ignition must be in the ACC/ACCESSORY or ON/RUN position.

Infotainment System

Introduction

Infotainment 7-1
 Theft-Deterrent Feature 7-3
 Operation 7-3

Radio

AM-FM Radio 7-8
 Satellite Radio 7-10
 Radio Reception 7-14
 Backglass Antenna 7-15
 Multi-Band Antenna 7-15

Audio Players

CD Player 7-16
 CD/DVD Player 7-19
 MP3 7-23
 Hard Drive Device (HDD) 7-27
 Auxiliary Devices 7-33

Phone

Bluetooth 7-35

Trademarks and License

Agreements

Trademarks and License
 Agreements 7-43

Introduction

Infotainment

Read the following pages to become familiar with the audio system's features.

 **Warning**

Taking your eyes off the road for extended periods could cause a crash resulting in injury or death to you or others. Do not give extended attention to infotainment tasks while driving.

This system provides access to many audio and non-audio listings.

7-2 Infotainment System

To minimize taking your eyes off the road while driving, do the following while the vehicle is parked:

- Become familiar with the operation and controls of the audio system.
- Set up the tone, speaker adjustments, and preset radio stations.

For more information, see *Defensive Driving* on page 9-3.

Caution

Contact your dealer before adding any equipment.

Adding audio or communication equipment could interfere with the operation of the engine, radio, or other systems, and could damage them. Follow federal rules covering mobile radio and telephone equipment.

The vehicle has Retained Accessory Power (RAP). With RAP, the audio system can be played even after the ignition is turned off. See *Retained Accessory Power (RAP)* on page 9-22.

Navigation System

If equipped with a navigation system, see the navigation manual.

Theft-Deterrent Feature

TheftLock[®] is designed to discourage theft of the vehicle's radio by learning a portion of the Vehicle Identification Number (VIN). The radio does not operate if it is stolen or moved to a different vehicle.

Operation



Full View of Radio with CD Shown, Radio with Six-Disc CD Similar

7-4 Infotainment System

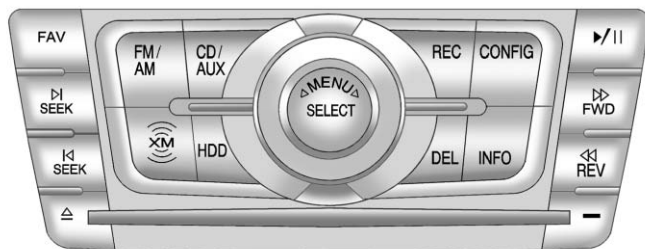

Partial View of Radio with CD/DVD Audio, Hard Drive Device (HDD), and USB

The vehicle may have one of these radios as its audio system.

If the vehicle does not have one of these radio systems, it may have a navigation radio system. See the navigation manual for more information on the navigation audio system.

Turning the System On or Off

VOL/  (Volume/Power): Press to turn the system on and off.

Volume Control



VOL/  (Volume/Power): Turn clockwise or counterclockwise to increase or decrease the volume.

SiriusXM

 : Press to choose the SiriusXM band (if equipped).

Setting the Tone (Bass/Midrange/Treble)

BASS/MID/TREB (Bass, Midrange, or Treble): To adjust bass, midrange, or treble:

1. Press the TUNE/TONE knob until the tone control tabs display.
2. Continue pressing the TUNE/TONE knob, or press the softkey under the desired tab to highlight the desired tone setting.
3. To increase the highlighted setting, do one of the following:
 - Turn the TUNE/TONE knob clockwise.
 - Turn the MENU/SELECT knob clockwise.
 - Press the  FWD button.
 - Press the  SEEK button.

4. To decrease the highlighted setting, do one of the following:
 - Turn the TUNE/TONE knob counterclockwise.
 - Turn the MENU/SELECT knob counterclockwise.
 - Press the ◀◀ REV button.
 - Press the ⏪ SEEK button.

To quickly adjust bass, midrange, or treble to the middle position, press the softkey under the BASS, MID, or TREB tab for more than two seconds.

To quickly adjust all tone and speaker controls to the middle position, press the TUNE/TONE knob for more than two seconds.

Adjusting the Speakers (Balance/Fade)

BAL/FADE (Balance/Fade): To adjust balance or fade:

1. Press the TUNE/TONE knob until the speaker control tabs display.

2. Continue pressing the TUNE/TONE knob, or press the softkey under the desired tab to highlight the desired tone setting.
3. To increase the highlighted setting, do one of the following:
 - Turn the TUNE/TONE knob clockwise.
 - Turn the MENU/SELECT knob clockwise.
 - Press the ▶▶ FWD button.
 - Press the ⏩ SEEK button.
4. To decrease the highlighted setting, do one of the following:
 - Turn the TUNE/TONE knob counterclockwise.
 - Turn the MENU/SELECT knob counterclockwise.
 - Press the ◀◀ REV button.
 - Press the ⏪ SEEK button.

To quickly adjust balance or fade to the middle position, press the softkey under the BAL or FADE tab for more than two seconds.

To quickly adjust all speaker and tone controls to the middle position, press the TUNE/TONE knob for more than two seconds.

Adjusting the Equalizer (EQ)

If equipped, the EQ can be adjusted between talk and manual.

To choose an EQ setting:

1. Press the TUNE/TONE knob.
2. Select EQ.
3. Select Talk or Manual.
4. Press the Back button to go back to the Tone Settings menu.

7-6 Infotainment System

Digital Signal Processing (DSP)

If the radio has this feature, it has either a Bose® sound system or a Bose® 5.1 Cabin Surround® sound system. DSP is used to provide a choice of different listening experiences.

To choose a DSP setting:

1. Press the TUNE/TONE knob to display the tone/speaker and DSP tabs.
2. Press the softkey under the DSP tab.
3. Press the softkey below the Back tab to return to the original tone/speaker display, or wait for the display to time out.

The DSP settings available are:

- **Normal:** Select for normal mode; this provides the best sound quality for all seating positions.
- **Driver:** Select to adjust the audio for the driver to receive the best possible sound quality.

- **Rear:** Select to adjust the audio for the rear seat passengers to receive the best possible sound quality.
- **Centerpoint®:** Select to automatically enable Bose Centerpoint signal processing circuitry. Centerpoint creates a Bose® surround sound from stereo CDs, MP3s, and satellite radio.

This feature is not available in AM/FM radio mode.

If equipped with the Bose 5.1 Cabin Surround sound system, the radio can support the playback of 5.1 surround sound DVD-A discs or DTS 5.1 surround sound CD discs. When a 5.1 surround sound formatted disc is playing, DSP options available are:

- 5.1 Surround + Normal: Best for all seating positions.
- 5.1 Surround + Rear: Best for the rear seating positions.

System Settings

CONFIG: Press to adjust the number of favorites pages, auto volume, and HDD (if available) settings. The FAV, AUTO VOL, and HDD (if available) tabs display. The display will time out after approximately 10 seconds.

Configuring the Number of Favorite Pages

The number of favorite pages can be set using the CONFIG button. To set the number of favorite pages:

1. Press the CONFIG button to display the radio setup menu.
2. Press the softkey below the FAV tab.
3. Select the desired number of favorite pages by pressing the softkey below the displayed page numbers.
4. Press the FAV button, or let the menu time out, to return to the original main radio screen showing the radio station

frequency tabs and to begin the process of programming favorites for the chosen number of pages.

Speed Compensated Volume (SCV)

A radio with SCV automatically adjusts the sound to compensate for road and wind noise as the vehicle speeds up or slows down, so that the volume is consistent while driving. To activate SCV:

1. Set the radio volume to the desired level.
2. Press the CONFIG button to display the radio setup menu.
3. Press the softkey under the AUTO VOL tab on the radio display.
4. Press the softkey under the desired Speed Compensated Volume setting (OFF, Low, Med, or High) to select the level of radio volume compensation. The display times out after approximately 10 seconds. Each

higher setting allows for more radio volume compensation at faster vehicle speeds.

Noise Compensation Technology

If the vehicle has the radio with DVD Audio, HDD, and USB, it has Bose AudioPilot® noise compensation technology.

When turned on, AudioPilot continuously adjusts the audio system equalization, to compensate for background noise.

To activate AudioPilot:

1. Press the CONFIG button to display the radio setup menu.
2. Press the softkey under the AUTO VOL tab on the radio display.
3. Press the softkey below the On or Off tab under the AUTO VOL display, to turn this feature on or off. The display times out after approximately 10 seconds.

This feature is most effective at lower radio volume settings where background noise can affect how the music being played through the vehicle's audio system is heard. At higher volume settings, where the music is much louder than the background noise, there may be little or no adjustments by AudioPilot. For additional information on AudioPilot, visit www.bose.com/audiopilot.

Radio Message

Locked: Displays when the TheftLock® system has locked up the infotainment system. Take the vehicle to your dealer for service.

If any error occurs repeatedly or if an error cannot be corrected, contact your dealer.

Radio

AM-FM Radio

Control Buttons

The knobs and buttons used to control the radio are:

FM/AM: Press to choose between FM and AM.

TUNE/TONE: Turn to search for stations. Press to enter the Tone menu.

MENU/SELECT: Turn clockwise or counterclockwise to scroll through the station list. Press the MENU/SELECT knob to select the desired station.

INFO: Press to display additional information that may be available for the current song. When information is not available, No Information displays.

↻ SEEK or ⏪ SEEK: Press to go to the previous or to the next radio station and stay there.

The radio only tunes to stations with a strong signal that are in the selected band.

FAV: Press to change the favorites page.

Softkeys: Press to select preset stations.

Radio Data System (RDS)

The audio system has an RDS feature. RDS is available for use only on FM stations that broadcast RDS information. This system relies upon receiving specific information from these stations and only works when the information is available. While the radio is tuned to an FM-RDS station, the station name or call letters display. In rare cases, a radio station can broadcast incorrect information that causes the radio features to work improperly. If this happens, contact the radio station.

Selecting a Station

Seek Tuning

If the radio station is not known:

Briefly press **↻ SEEK** or **⏪ SEEK**. The radio will search for the next receivable station. If the radio does not find a station, it switches automatically to a more sensitive search level. If it still does not find a station, the frequency that was last active begins to play and “None Found” displays.

If the radio station is known:

Press and hold **↻ SEEK** or **⏪ SEEK** until the desired station on the pop-up frequency display is almost reached, then release the button.

Manual Tuning

Turn the TUNE/TONE knob to select the frequency on the pop-up display.

Station List

Turn the MENU/SELECT knob to display the station list. To create a list of available stations, select Refresh AM Station List or Refresh FM Station List, depending on which band is being used.

In FM, RDS information may be utilized to categorize the stations by genre.

In both AM and FM, the stations are arranged in frequency order.

Storing a Radio Station as a Favorite

Radio station favorites should be set up while the vehicle is stopped. Tune to favorite stations using the presets, favorites button, and steering wheel controls, if equipped.

FAV (Favorites): A maximum of 36 stations can be programmed as favorites using the six softkeys below the radio station frequency tabs on the display and by using the

radio favorites page button (FAV button). Press the FAV button to go through up to six pages of favorites, each having six favorite stations available per page. Each page of favorites can contain any combination of AM, FM, or SiriusXM® stations.

To store a station as a favorite:

1. Tune to the desired radio station.
2. Press the FAV button to display the page where the station is to be stored.
3. Press and hold one of the six softkeys until a beep sounds and "Favorite Saved" displays. When that softkey is pressed and released, the radio recalls the station that was set.
4. Repeat the steps for each radio station to be stored as a favorite.

The number of favorites pages can be set up using the CONFIG button.

To set up the number of favorites pages:

1. Press the CONFIG button to display the radio setup menu.
2. Press the softkey below the FAV label.
3. Select the desired number of favorites pages by pressing the softkey below the displayed page numbers.
4. Press the FAV button, or let the menu time out, to return to the original main radio screen showing the radio station frequency labels and to begin the process of programming favorites for the chosen number of pages.

Time Shifting — Pause and Rewind Live FM and AM

The Radio with DVD Audio, HDD, and USB has the ability to rewind 60 minutes of FM and AM content. While listening to the radio, the content from the current station is always being buffered to the HDD.

7-10 Infotainment System

Press ► / || (play/pause) to pause the radio. The radio display will show the Time Shift buffer status bar. The status bar shows the amount of content stored in the buffer and the current pause point.

To resume playback from the current pause point, press ► / || again. The radio will no longer be playing “live” radio. Instead, time shifted content is being played from the buffer. When the radio is playing time shifted content from the buffer, a buffer status bar shows below the station number on the left side of the screen.

Press and hold the ◀◀ REV or ▶▶ FWD buttons to rewind or fast forward through the time shift buffer. Hold FWD until the end of the currently recorded buffer to resume “live” radio playback. With “live” radio playing, the radio display will no longer show the buffer bar below the station number.

On FM or AM, press the ◀◀ REV or ▶▶ FWD button multiple times to rewind or fast forward. Each press will rewind or fast forward 30 seconds of content.

When the radio station is changed, the buffer is cleared and automatically restarted for the current station. You cannot rewind to content from a previously tuned station.

Time shifting of FM or AM is not available while recording or while other sources of playback are selected.

Pausing FM or AM with the Vehicle Turned Off

If FM or AM is paused before the vehicle is turned off, the radio will continue to buffer the current radio station for up to one hour. If the vehicle is turned back on within one hour, the radio will automatically resume playback from the pause point.

Satellite Radio

Vehicles with a SiriusXM Satellite Radio tuner and a valid SiriusXM Satellite Radio subscription can receive SiriusXM programming.

SiriusXM Satellite Radio Service

SiriusXM is a satellite radio service based in the 48 contiguous United States and 10 Canadian provinces. SiriusXM Satellite Radio has a wide variety of programming and commercial-free music, coast to coast, and in digital-quality sound. A service fee is required to receive the SiriusXM service. Renew on channel XM1. For more information, contact SiriusXM at www.siriusxm.com or 1-866-635-2349 in the U.S. In Canada, see www.xmradio.ca or call 1-877-209-0079.

Control Buttons



The knobs and buttons used to control the radio are:

 **(SiriusXM):** Press to choose the SiriusXM band (if equipped).

TUNE/TONE: Turn to search for stations. Press to enter the Tone menu.

MENU/SELECT: Turn clockwise or counterclockwise to scroll through the category list. Press to select the desired category.

INFO: Press to display additional information that may be available for the current song. When information is not available, No Information displays.

 **SEEK** or  **SEEK:** Press to go to the next or to the previous radio station.

FAV: Press to change the favorites page.

Softkeys: Press to select preset stations.

SiriusXM Categories



SiriusXM stations are organized in categories.

Removing or Adding Categories (Radio with CD and Radio with Six-Disc CD Only)

1. Press the CONFIG button.
2. Press the softkey below the XM tab.
3. Turn the TUNE/TONE knob or the MENU/SELECT knob to scroll through the available categories.
4. Press any softkey below the Remove or Add tab to add or remove the displayed category.
5. Press any softkey below the Restore All tab to restore all removed categories.

Selecting a SiriusXM Station

Seek Tuning

Press  SEEK or  SEEK to go to the next or previous station.

Selecting a Station by Station List

The infotainment system can list all SiriusXM stations.

To select a station from the station list:

1. Turn the TUNE/TONE knob and highlight the desired station.
2. Press the TUNE/TONE knob to select the station.

The highlighted station will also automatically be selected if TUNE/TONE is released and no longer turned.

Selecting a Station by Category

The infotainment system can list SiriusXM stations by genre.

To select a station from the category list:

1. Turn the MENU/SELECT knob and highlight the desired genre, then press the MENU/SELECT knob to select the genre.

7-12 Infotainment System

2. Turn the MENU/SELECT knob and highlight the desired station, then press the MENU/SELECT knob to select the station.

Storing a SiriusXM Station as a Favorite

Radio station favorites should be set up while the vehicle is stopped. Tune to favorite stations using the presets, favorites button, and steering wheel controls, if equipped.

FAV (Favorites): A maximum of 36 stations can be programmed as favorites using the six softkeys below the radio station frequency tabs on the display and by using the radio favorites page button (FAV button). Press the FAV button to go through up to six pages of favorites, each having six favorite stations available per page. Each page of favorites can contain any combination of AM, FM, or SiriusXM stations.

To store a station as a favorite:

1. Tune to the desired radio station.
2. Press the FAV button to display the page where the station is to be stored.
3. Press and hold one of the six softkeys until a beep sounds. When that softkey is pressed and released, the radio recalls the station that was set.
4. Repeat the steps for each radio station to be stored as a favorite.

The number of favorites pages can be set up using the CONFIG button.

To set up the number of favorites pages:

1. Press the CONFIG button to display the radio setup menu.
2. Press the softkey below the FAV label.
3. Select the desired number of favorites pages by pressing the softkey below the displayed page numbers.

4. Press the FAV button, or let the menu time out, to return to the original main radio screen showing the radio station frequency labels and to begin the process of programming favorites for the chosen number of pages.

Time Shifting — Pause and Rewind Live SiriusXM

The Radio with DVD Audio, HDD, and USB has the ability to rewind 60 minutes of SiriusXM content. While listening to the radio, the content from the current station is always being buffered to the HDD.

Press ► / || to pause the radio. The radio display will show the Time Shift buffer status bar. The status bar shows the amount of content stored in the buffer and the current pause point.

To resume playback from the current pause point, press ► / || again. The radio will no longer be playing “live” radio. Instead, time shifted content is being played from the buffer. When the radio is playing time shifted content from the buffer, a buffer status bar shows below the station number on the left side of the screen.

Press and hold the ◀◀ REV or ▶▶ FWD buttons to rewind or fast forward through the time shift buffer. Hold ▶▶ FWD until the end of the currently recorded buffer to resume “live” radio playback. With “live” radio playing, the radio display will no longer show the buffer bar below the station number.

Press the ◀◀ REV or ▶▶ FWD button multiple times to jump to the previous or next song or commercial.

When the radio station is changed, the buffer is cleared and automatically restarted for the

current station. You cannot rewind to content from a previously tuned station.

Time shifting of SiriusXM is not available while recording or while other sources of playback are selected.

Pausing SiriusXM with the Vehicle Turned Off

If SiriusXM is paused before the vehicle is turned off, the radio will continue to buffer the current radio station for up to one hour. If the vehicle is turned back on within one hour, the radio will automatically resume playback from the pause point.

SiriusXM Messages

XL (Explicit Language

Channels): These channels, or any others, can be blocked at a customer's request, by calling 1-866-635-2349 in the U.S., and 1-877-209-0079 in Canada.

XM Updating: The encryption code in the receiver is being updated, and no action is required. This process should take no longer than 30 seconds.

No XM Signal: The system is functioning correctly, but the vehicle is in a location that is blocking the SiriusXM signal. When the vehicle is moved into an open area, the signal should return.

Loading XM: The audio system is acquiring and processing audio and text data. No action is needed. This message should disappear shortly.

Channel Off Air: This channel is not currently in service. Tune in to another channel.

Channel Unauth: This channel is blocked or cannot be received with your SiriusXM Subscription package.

Channel Unavail: This previously assigned channel is no longer assigned. Tune to another station.

7-14 Infotainment System

If this station was one of the presets, choose another station for that preset button.

No Artist Info: No artist information is available at this time on this channel. The system is working properly.

No Title Info: No song title information is available at this time on this channel. The system is working properly.

No CAT Info: No category information is available at this time on this channel. The system is working properly.

No Information: No text or informational messages are available at this time on this channel. The system is working properly.

No Subscription Please Renew: The XM subscription needs to be reactivated. Contact XM at www.siriusxm.com or

1-866-635-2349 in the U.S. In Canada, see www.xmradio.ca or call 1-877-209-0079.

CAT Not Found: There are no channels available for the selected category. The system is working properly.

XM Radio ID: If tuned to channel 0, this message alternates with the SiriusXM Radio eight-digit radio ID label. This label is needed to activate the service.

Unknown: If this message is received when tuned to channel 0, there could be a receiver fault. Consult with your dealer.

Check XM Receiver: If this message does not clear within a short period of time, the receiver could have a fault. Consult with your dealer.

XM Not Available: If this message does not clear within a short period of time, the receiver could have a fault. Consult with your dealer.

Radio Reception

Frequency interference and static can occur during normal radio reception if items such as phone chargers, vehicle convenience accessories, and external electronic devices are plugged into the accessory power outlet. If there is interference or static, unplug the item from the accessory power outlet.

FM

FM signals only reach about 16 to 65 km (10 to 40 mi). Although the radio has a built-in electronic circuit that automatically works to reduce interference, some static can occur, especially around tall buildings or hills, causing the sound to fade in and out.

AM

The range for most AM stations is greater than for FM, especially at night. The longer range can cause station frequencies to interfere with each other. Static can also occur

when things like storms and power lines interfere with radio reception. When this happens, try reducing the treble on the radio.

SiriusXM Satellite Radio Service

SiriusXM Satellite Radio Service provides digital radio reception. Tall buildings or hills can interfere with satellite radio signals, causing the sound to fade in and out. In addition, traveling or standing under heavy foliage, bridges, garages, or tunnels may cause loss of the SiriusXM signal for a period of time.

Cell Phone Usage

Cell phone usage, such as making or receiving phone calls, charging, or just having the phone on may cause static interference in the radio. Unplug the phone or turn it off if this happens.

Backglass Antenna

The AM-FM antenna is integrated with the rear window defogger in the rear window. Do not scratch the inside surface or damage the lines in the glass. If the inside surface is damaged, it could interfere with radio reception. For proper radio reception, the antenna connector needs to be properly attached to the post on the glass.

If attaching a cell phone antenna to the glass, attach it between the grid lines.

Caution

Using a razor blade or sharp object to clear the inside rear window can damage the rear window antenna and/or the rear window defogger. Repairs would not be covered by the vehicle warranty. Do not clear the inside rear window with sharp objects.

Caution

Do not apply aftermarket glass tinting with metallic film. The metallic film in some tinting materials will interfere with or distort the incoming radio reception. Any damage caused to the backglass antenna due to metallic tinting materials will not be covered by the vehicle warranty.

Multi-Band Antenna

The roof antenna is for OnStar, SiriusXM Satellite Radio (U.S. and Canada only), and GPS (Global Positioning System). Keep clear of obstructions for clear reception. If the vehicle has a sunroof, and it is open, reception can also be affected.

Audio Players

CD Player

The infotainment system's CD player can play audio CDs and MP3 CDs.

CDs that are 8 cm (3 in) in diameter will not work in the CD player.

Care of CDs

If playing a CD, the sound quality can be reduced due to disc quality, the method of recording, the quality of the music that has been recorded, and the way the disc has been handled. Handle discs carefully. Store CDs in their original cases or other protective cases and away from direct sunlight and dust. The CD player scans the bottom surface of the disc. If the surface of a disc is damaged, such as cracked, broken, or scratched, the disc may not play properly or not at all. Do not touch the bottom side of a disc while handling it; this could damage

the surface. Pick up discs by grasping the outer edges or the edge of the hole and the outer edge.

If the surface of a disc is soiled, take a soft, lint-free cloth or dampen a clean, soft cloth in a mild, neutral detergent solution mixed with water, and clean it. Make sure the wiping process starts from the center to the edge.

Care of the CD Player

Do not add a label to a disc; it could get caught in the CD player. If a label is needed, label the top of the recorded disc with a marking pen.

The use of disc lens cleaners for discs is not advised, due to the risk of contaminating the lens of the disc optics with lubricants internal to the CD player mechanism.

Caution

If a label is added to a CD, more than one CD is inserted into the slot at a time, or an attempt is made to play scratched or damaged CDs, the CD player could be damaged. While using the CD player, use only CDs in good condition without any label, load one CD at a time, and keep the CD player and the loading slot free of foreign materials, liquids, and debris.

Control Buttons

The knobs and buttons used to control the CD player are:

CD: Press to play a CD when listening to the radio. The disc and/or track number display when a CD is in the player.

 **SEEK** or  **SEEK:** Press to select tracks.

TUNE/TONE: Turn and then press to select tracks.

MENU/SELECT: Turn and then press to select.

▶ / || (Play/Pause): Press to pause and restart CD playback.

◀◀ REV (Fast Reverse): Press and hold to reverse playback quickly within a track.

▶▶ FWD (Fast Forward): Press and hold to advance playback quickly within a track.

△ (Eject): Press to eject the disc.

For the Six-Disc CD player, press and hold for two seconds to eject all discs.

Inserting a CD (Single Disc Player)

With the printed side facing up, insert a CD into the audio CD slot until it is drawn in. The CD track number and a Shuffle tab display and playback begins.

If the ignition or radio is turned off while a CD is in the player, it stays in the player. When the ignition or radio is turned on, the CD starts playing where it stopped, if it was the last selected audio source.

Inserting a CD (Six-Disc CD Player)

▽ (Load): Press to load CDs into the CD player. This CD player holds up to six CDs.

To insert one CD:

1. Press and release **▽**.
2. Wait for the message to insert the disc.
3. Load a CD. Insert the CD partway into the slot, label side up. The player pulls the CD in. A Shuffle tab and the DISC icon display.
4. Press the softkey below the Shuffle tab to play the tracks of a current disc in random order. Press the softkey again to turn Shuffle off. Shuffle Off displays.

5. The CD resumes normal playback.

To insert multiple CDs:

1. Press and hold **▽** for five seconds. A beep sounds and Load All Discs displays.
2. Follow the displayed instruction on when to insert the discs. The CD player takes up to six CDs.
3. Press **▽** again to cancel loading more CDs.

If the ignition or radio is turned off while a CD is in the player, it stays in the player. When the ignition or radio is turned on, the CD starts playing where it stopped, if it was the last selected audio source.

When a CD is inserted, the disc number displays on the upper right side of the screen and the track number displays at the left and center of the screen. The Shuffle and Disc labels appear below. Press the softkeys under the Disc tab to change to another disc.

The CD begins playback of the first track on the selected disc. As each new track starts to play, the track number displays in the left and center of the screen.

Playing a CD

Selecting a CD Track

Tracks can be selected using the seek buttons, TUNE/TONE knob, or MENU/SELECT knob.

To use the seek buttons:

Press **⏮** SEEK to go to the start of the current track, if more than five seconds have played.

Press **⏭** SEEK to go to the next track. If **⏮** SEEK or **⏭** SEEK is held, or pressed multiple times, the player continues moving backward or forward through the tracks on the CD.

To use the TUNE/TONE knob or the MENU/SELECT knob:

Turn the TUNE/TONE knob or the MENU/SELECT knob to highlight the desired track, then press the TUNE/TONE knob or MENU/SELECT knob to select the track.

Fast Forward and Rewind

⏮ REV (Fast Reverse): Press and hold to reverse playback quickly within a track. Sound is heard at a reduced volume and the elapsed time of the track displays. Release to resume playing the track.

⏭ FWD (Fast Forward): Press and hold to advance playback quickly within a track. Sound is heard at a reduced volume and the elapsed time of the track displays. Release to resume playing the track.

Playing Tracks in Random Order

Press the softkey under the Shuffle tab to play the tracks of a CD in random order. Press again to turn Shuffle off. Shuffle Off displays.

For vehicles with a Radio with Six-Disc CD player, the shuffle feature only works on the disc that is currently playing.

Playing an MP3/WMA Disc

CD players with the MP3 feature are capable of playing an MP3/WMA CD-R or CD-RW disc. See *MP3 on page 7-23* for more information.

Disc Messages

DISC ERROR: If this message displays and/or the disc ejects, it could be for one of the following reasons:

- The radio system does not support the playlist format, the compressed audio format, or the data file format.
- It is very hot. When the temperature returns to normal, the disc should play.
- The road is very rough. When the road becomes smoother, the disc should play.

- The disc is dirty, scratched, wet, or upside down.
- The air is very humid. If so, wait about an hour and try again.
- There was a problem while burning the disc.
- The label is caught in the CD/DVD-A player.

If the disc is not playing correctly, for any other reason, try a known good disc.

If any error occurs repeatedly or if an error cannot be corrected, contact your dealer. If the radio displays an error message, write it down and provide it to your dealer when reporting the problem.

CD/DVD Player

The infotainment system's CD/DVD player can play audio discs and MP3 discs.

Discs that are 8 cm (3 in) in diameter will not work in the CD/DVD player.

The CD/DVD player does not support the playback of DVD video discs. If a DVD video disc is inserted into the player, the radio displays "Read Error Please Check Disc" and ejects the disc.

Care of CDs and DVDs

If playing a CD/DVD, the sound quality can be reduced due to disc quality, the method of recording, the quality of the music that has been recorded, and the way the disc has been handled. Handle discs carefully. Store CDs and DVDs in their original cases or other protective cases and away from direct sunlight and dust. The CD/DVD player scans the bottom surface of the disc. If the surface of a disc is damaged, such as cracked, broken, or scratched, the disc may not play properly or not at all. Do not touch the bottom side of a disc

while handling it; this could damage the surface. Pick up discs by grasping the outer edges or the edge of the hole and the outer edge.

If the surface of a disc is soiled, take a soft, lint-free cloth or dampen a clean, soft cloth in a mild, neutral detergent solution mixed with water, and clean it. Make sure the wiping process starts from the center to the edge.

Care of the CD/DVD Player

Do not add a label to a disc; it could get caught in the CD/DVD player. If a label is needed, label the top of the recorded disc with a marking pen.

The use of disc lens cleaners for discs is not advised, due to the risk of contaminating the lens of the disc optics with lubricants internal to the CD/DVD player mechanism.

Caution

If a label is added to a disc, or more than one disc is inserted into the slot at a time, or an attempt is made to play scratched or damaged discs, the CD/DVD player could be damaged. While using the CD/DVD player, use only discs in good condition without any label, load one disc at a time, and keep the CD/DVD player and the loading slot free of foreign materials, liquids, and debris.

Control Buttons

The knobs and buttons used to control the CD/DVD player are:

CD/AUX (CD/Auxiliary): Press to switch between CD/DVD, auxiliary input, and USB devices.

◀ SEEK or ▶ SEEK: Press to select tracks.

TUNE/TONE: Turn and then press to select tracks.

MENU/SELECT: Turn and then press to select.

▶ / || (Play/Pause): Press to pause and restart CD or DVD playback.

◀◀ REV (Fast Reverse): In CD or MP3 playback mode, press and hold to reverse playback quickly within a track. Sound is heard at a reduced volume. When released, normal playback resumes and the elapsed time of the track displays.

In DVD-Audio playback mode, press once to change playback to a speed of 2X. Each successive press changes playback to a speed of 4X, 10X, or 21X. Press ▶ / || to resume normal playback.

▶▶ FWD (Fast Forward): In CD or MP3 playback mode, press and hold to advance playback quickly within a track. Sound is heard at a reduced volume. When released, normal playback resumes and the elapsed time of the track displays.

In DVD-Audio playback mode, press once to change playback to a speed of 2X. Each successive press changes playback to a speed of 4X, 10X, or 21X. Press ▶ / || to resume normal playback.

△ (Eject): Press to eject the disc.

Inserting a Disc

With the printed side facing up, insert a disc into the audio CD/DVD slot until it is drawn in. The disc track number and a Shuffle tab display and playback begins.

If the ignition or radio is turned off while a disc is in the player, it stays in the player. When the ignition or radio is turned on, the disc starts playing where it stopped, if it was the last selected audio source.

Playing a CD

Selecting a CD Track

Tracks can be selected using the seek buttons, TUNE/TONE knob, or MENU/SELECT knob.

To use the seek buttons:

Press **⏮** SEEK to go to the start of the current track, if more than five seconds have played. Press **⏭** SEEK to go to the next track.

If **⏮** SEEK or **⏭** SEEK is held, or pressed multiple times, the player continues moving backward or forward through the tracks on the CD.

To use the TUNE/TONE knob:

Turn the TUNE/TONE knob to highlight the desired track, then press the TUNE/TONE knob to select the track.

To use the MENU/SELECT knob:

Turn the MENU/SELECT knob to highlight the desired track, then press the MENU/SELECT knob to select the track.

Fast Forward and Rewind

⏮ REV (Fast Reverse): Press and hold to reverse playback quickly within a track. Sound is heard at a

reduced volume and the elapsed time of the track displays. Release to resume playing the track.

⏭ FWD (Fast Forward): Press and hold to advance playback quickly within a track. Sound is heard at a reduced volume and the elapsed time of the track displays. Release to resume playing the track.

Playing Tracks in Random Order

Press the softkey under the Shuffle tab to play the tracks of a CD in random order. Press again to turn Shuffle off. Shuffle Off displays.

Playing a DVD-A (Audio) Disc

The Radio with DVD Audio, HDD, and USB is capable of playing DVD audio discs in the Bose® 5.1 Cabin surround sound system.

Insert the DVD audio disc into the CD/DVD player. DVD Audio displays and playback begins. The Group and track number display during playback.

Selecting a DVD-A Track

Tracks can be selected using the seek buttons, or the TUNE/TONE knob.

To use the seek buttons:

Press **⏮** SEEK to go to the start of the current track, if more than five seconds have played. Press **⏭** SEEK to go to the next track.

If **⏮** SEEK or **⏭** SEEK is held, or pressed multiple times, the player continues moving backward or forward through the tracks within the current group.

To use the TUNE/TONE knob:

Turn the TUNE/TONE knob to display a list of all tracks in all groups on the DVD audio disc and to highlight tracks. Stop turning the TUNE/TONE knob or press the TUNE/TONE knob to start playback of the highlighted track.

7-22 Infotainment System

To use the MENU/SELECT knob:

Press the softkey under the Menu tab to display a list of all Groups. To change Groups, turn the MENU/SELECT knob to highlight the desired Group. Press the MENU/SELECT knob to select it. Playback begins from track 1 of the highlighted Group.

Fast Forward and Rewind

◀◀ REV (Fast Reverse): Press to reverse playback quickly within a track. Sound is heard at a reduced volume. Press once to change playback to a speed of 2X. Each successive press changes playback to a speed of 4X, 10X, or 21X.

Press ▶ / || to resume normal playback.

▶▶ FWD (Fast Forward): Press to advance playback quickly within a track. Sound is heard at a reduced volume. Press once to change playback to a speed of 2X. Each successive press changes playback

to a speed of 4X, 10X, or 21X.

Press ▶ / || to resume normal playback.

Playing Tracks in Random Order

Press the softkey under the Shuffle tab to begin random playback of all songs in the current Group. Press again to turn off random playback.

Stopping DVD Audio Playback

Press the softkey under the ■ tab to stop playback of the DVD audio disc. "DVD PreStop" displays. Press the ▶ / || button to resume playback from where it was stopped.

Press the softkey under the ■ tab again while in DVD PreStop. "DVD Stop" displays. Press the ▶ / || button while in DVD Stop to begin playback from the beginning of the DVD audio disc.

Press the ▶ / || button during DVD audio playback to pause or resume playback.

Selecting DVD Audio Streams

Each DVD audio Group may contain audio content that is encoded in one or two formats. For example, a particular Group may have both a 5.1 surround audio stream and a 2.0 stereo audio stream available.

Press the softkey under the Audio tab to display the current audio stream playing. "Audio Stream 1" or "Audio Stream 2" briefly displays. Press the softkey under the Audio tab again to toggle between Audio Stream 1 or Audio Stream 2 (if available).

Check the DSP settings to determine if a 5.1 surround sound audio stream is playing. See *Operation on page 7-3*. Press the DSP tab to see if the 5.1 + Normal or 5.1 + Rear settings are available for selection. If these settings are available, Audio Stream 1 is playing.

Playing an MP3/WMA Disc

CD/DVD players with the MP3 feature are capable of playing an MP3/WMA on DVD+/-R, CD-R, or CD-RW discs. See *MP3* on page 7-23.

Disc Messages

DISC ERROR: If this message displays and/or the disc ejects, it could be for one of the following reasons:

- The radio system does not support the playlist format, the compressed audio format, or the data file format.
- It is very hot. When the temperature returns to normal, the disc should play.
- The road is very rough. When the road becomes smoother, the disc should play.
- The disc is dirty, scratched, wet, or upside down.
- The air is very humid. If so, wait about an hour and try again.

- There was a problem while burning the disc.
- The label is caught in the CD/DVD player.

If the disc is not playing correctly, for any other reason, try a known good disc.

If any error occurs repeatedly or if an error cannot be corrected, contact your dealer. If the radio displays an error message, write it down and provide it to your dealer when reporting the problem.

MP3

MP3/WMA Format

The Single CD and the Six-Disc CD Radio will play MP3/WMA files that were recorded on a CD-R or CD-RW disc. The HDD Radio can also play MP3/WMA files recorded on DVD+/-R discs or stored on a USB storage device. Some USB storage devices may not be supported.

The files can be recorded with the following fixed bit rates: 32 kbps, 40 kbps, 56 kbps, 64 kbps, 80 kbps, 96 kbps, 112 kbps, 128 kbps, 160 kbps, 192 kbps, 224 kbps, 256 kbps, and 320 kbps or a variable bit rate. Song title, artist name, and album can display when files are recorded using ID3 tags version 1 and 2.

Creating an MP3/WMA Disc

When creating an MP3/WMA disc:

- Make sure the MP3/WMA files are recorded on a CD-R or CD-RW disc.
- Do not mix standard audio and MP3/WMA files on one disc.
- Make sure the CD does not have more than a maximum of 50 folders and playlists, and 255 files to read and play.

7-24 Infotainment System

- Create a folder structure that makes it easy to find songs while driving. Organize songs by albums using one folder for each album. Each folder or album should contain 18 songs or less.
- Avoid subfolders. The system can support up to eight subfolders deep. Keep the total number of folders to a minimum to reduce the complexity and confusion during playback.
- Create playlists that have a .m3u or .wpl extension; other file extensions may not work.
- Minimize the length of the file, folder, or playlist names. Long file, folder, or playlist names, or a combination of a large number of files, folders, or playlists can cause the player to be unable to play up to the maximum number of files, folders, playlists, or sessions.

- Finalize the audio disc before burning it. Adding music to an existing disc can cause the disc not to function.

Playlists can be selected by using the previous and next folder buttons, the SEEK arrows, or the \triangleright FWD or \triangleleft REV buttons. An MP3/WMA CD-R or CD-RW that was recorded using no file folders can also be played. If a CD-R or CD-RW contains more than the maximum of 50 folders and playlists, and 255 files, the player lets you access and navigate up to the maximum, but all items over the maximum are not accessible.

The HDD Radio can support more than 255 files on an MP3/WMA disc.

The HDD Radio does not support playlists on a disc or USB storage device.

Root Directory

The root directory of the CD-R or CD-RW is treated as a folder. If the root directory has compressed audio files, the directory displays as

F1 DISC. All files contained directly under the root directory are accessed prior to any root directory folders. Playlists (Px) are always accessed after root folders or files.

The HDD Radio displays the root directory of an MP3/WMA disc as F1 MP3 and the root directory of a USB storage device as F1 USB.

Empty Directory or Folder

If a root directory or a folder exists somewhere in the file structure that contains empty folders and no compressed files in them, the player advances to the next folder in the file structure that contains compressed audio files.

No Folder

When the CD contains only compressed files, the files are under the root folder. The next and previous folder functions do not display on a CD that was recorded without folders or playlists. The radio displays F1 DISC for the root directory.

When the CD contains only playlists and compressed audio files, but no folders, all files are under the root folder. The folder down and the folder up buttons search playlists (Px) first and then go to the root folder. The radio displays F1 DISC for the root directory.

Order of Play

Tracks recorded to the CD-R or CD-RW play in the following order:

- Play begins from the first track in the first folder and continues sequentially through all tracks in each folder. When the last track of the last folder has played, play continues from the first track of the first playlist.
- Play begins from the first track in the first playlist and continues sequentially through all tracks in each playlist. When the last track of the last playlist has played, play continues from the first track of the first folder.

Playlists can be changed by pressing the next and previous folder button.

When play enters a new folder, the display does not automatically show the new folder name unless the folder mode has been chosen as the default display. The new track name displays.

File System and Naming

The song name contained in the ID3 tag displays. If the song name is not in the ID3 tag, the radio displays the file name without the extension.

Track names longer than 32 characters are shortened. Parts of words on the last page of text and the extension of the file name are not displayed.

The HDD Radio will display file names with the extension.

Preprogrammed Playlists

Preprogrammed playlists created using WinAmp[®], MusicMatch[®], or RealPlayer[®] software can be accessed, however they cannot be edited using the radio. These playlists are special folders containing compressed audio song files. Playlists must have a file extension of PLS or M3U.

Playlists can be selected using the previous and next folder buttons. Tracks can be changed by pressing the seek buttons or turning the TUNE/TONE knob. Songs are played sequentially; press ◀◀ REV or ▶▶ FWD to reverse or advance through the playing song.

The HDD Radio does not support preprogrammed playlists. To create a playlist on the HDD radio from songs recorded to the HDD, see *Hard Drive Device (HDD)* on page 7-27.

Playing an MP3/WMA from a Disc or a USB Storage Device

Selecting an MP3 Track

Tracks can be selected using the seek buttons, the TUNE/TONE knob, or the softkeys below the folder tabs on the infotainment display.

To use the seek buttons:

Press the **⏮** SEEK button to go to the start of the current track, if more than five seconds have played.

Press the **⏭** SEEK button to go to the next track. If **⏮** SEEK or **⏭** SEEK is held, or pressed multiple times, the player continues moving backward or forward through the tracks on the disc.

To use the TUNE/TONE knob:

Turn the TUNE/TONE knob to highlight the desired track, then press the TUNE/TONE knob to select the track.

To use the softkeys below the folder tabs:

< Folder (Previous Folder): Press the softkey under the Folder tab to go to the first track in the previous folder.

Folder > (Next Folder): Press the softkey under the Folder tab to go to the first track in the next folder.

Fast Forward and Rewind

⏮ REV (Fast Reverse): Press and hold to reverse playback quickly within a track. Sound is heard at a reduced volume and the elapsed time of the track displays. Release to resume playing the track.

⏭ FWD (Fast Forward): Press and hold to advance playback quickly within a track. Sound is heard at a reduced volume and the elapsed time of the track displays. Release to resume playing the track.

Searching for MP3 Tracks

Tracks can be searched for by using the menu system.

To use the menu system:

1. Press the MENU/SELECT knob to display the MP3 Menu.
2. Turn the MENU/SELECT knob to highlight an option from the MP3 Menu. The available options are:
 - Playlists*
 - Tracks
 - Folders
 - Artists
 - Albums
 - Song Titles
 - AudioBook
3. Press the MENU/SELECT knob to select the desired option.

*The HDD Radio does not support preprogrammed playlists. To create a playlist on the HDD radio from

songs recorded to the HDD, see *Hard Drive Device (HDD)* on page 7-27.

Quick Jump

To scroll up or down the list of Artists, Albums, or Song Titles, press and hold the softkey under the FWD or REV tab.

To jump to the beginning, middle, or last section of the list:

- Press the first softkey under the display to go to the beginning section of the list.
- Press the second softkey under the display to go to the middle section of the list.
- Press the third softkey under the display to go to the last section of the list.

Playing Tracks in Random Order

Press the softkey under the Shuffle tab to play the tracks of the current folder in random order. Press again to turn Shuffle off. Shuffle Off displays.

Hard Drive Device (HDD)

If equipped with a 40GB HDD, tracks must be recorded from a CD, MP3 Disc, or USB device first to use it.

Recording from Audio Discs

REC (Record): Press to start recording tracks from the disc while it is playing. The radio has the option to record the current track playing or all tracks from the CD. Press the softkey under the desired record option.

The last radio station that was on begins playing and a status bar appears on the top of the display when the recording process starts. The status bar disappears when the process has ended. The recorded songs are now available.

Copy-Protected CD(s)

Make sure the disc is not copy protected. The radio does not copy a copy-protected CD to the HDD.

Deleting a Recorded Song or Category

DEL (Delete): Press the DEL button to delete the track currently playing or select a track from one of the song lists.

To delete an entire category, select a category and press DEL.

Stopping the Recording

While recording from the audio CD, press the REC button to display the stop recording option. Press the softkey under this option to confirm the selection.

Ejecting a CD or Turning Off the Vehicle While Recording

If the CD is ejected or the vehicle is turned off before the recording process has completed, tracks that have been completely recorded are stored to the HDD. Incomplete tracks are discarded.

Re-recording Audio CDs

If a CD has already been recorded, the radio system will not record the contents again. If a partially recorded CD is selected for recording, only those songs that are not already on the HDD will be recorded.

Audio CD Song, Artist, Album, and Genre Information

Radios with HDD contain a Gracenote® Database that the radio uses to determine the song, artist, album, and genre information. The Gracenote Database allows the radio to record an audio CD to the HDD and store the content using song, artist, album, and genre information.

Newly released audio CDs as well as some less common audio CDs may not be found in the Gracenote Database stored on the HDD. If these audio CDs contain CD-text, the radio will use the CD-text information when recording the content to the HDD. If an audio CD

is not found in the Gracenote Database and it does not have CD-text information, the radio will record the audio CD with all song, artist, album and genre names as “NO INFO.”

Songs recorded with “NO INFO” to the HDD will be hard to sort, identify, and select. To make HDD navigation easier, CDs with “NO INFO” can first be converted to MP3 format with Tag information on a home computer and then recorded to the HDD from an MP3 disc or USB device.

Occasionally, the radio may find more than one match in the Gracenote Database for an audio CD that has been recorded. If this happens, the radio will display “Multi-Hit” for the name information when the songs are selected from the HDD. With a “Multi-Hit” song playing, press the button below the EDIT tab to bring up the list of multiple names found in the Gracenote Database. Use the

MENU/SELECT knob to highlight and select the correct name for the “Multi-Hit” recorded CD.

The Gracenote Database stored on the HDD can be updated so that it includes name information for more recently released audio CDs. See your dealer for more information on Gracenote Database updates for the HDD radio.

Recording from MP3/WMA Discs or USB

REC (Record): Press to start recording tracks from an MP3/WMA disc or a USB device (excluding iPods) while it is playing. The radio has the option to record the current track playing or all tracks from the CD. Press the softkey under the desired record option.

The last radio station that was on begins playing and a status bar appears on the top of the display when the recording process starts. The status bar disappears when the process has ended. The recorded songs are now available.

AAC and OGG Vorbis file types are not fully supported. These file types may or may not play and may be shown without Tag information. Without Tag information available, these file types may be identified only by file name.

AudioBooks from www.audible.com can also be transferred to the HDD using the record function. See “AudioBook” later in this section for more information.

USB Host Support

The USB connector uses the USB standards, 1.1 and 2.0.

USB Supported Devices

- USB Flash Drives
- Portable USB Hard Drives

Playing from the Hard Drive Device

HDD (Hard Drive Device): Press the HDD button to start playing tracks from the HDD. HDD displays and playback resumes from where it was last stopped.

HDD Playback Mode

The infotainment system displays the current HDD playback mode. The following table shows the display mode options and what happens as the mode is displayed:

Mode	When Displayed
Shuffle	System is randomly playing back all HDD content.
Artist	System is playing back content by a selected artist in alphabetical order.
Album	System is playing back content from a selected album in track order.
Genre	System is playing back content in a selected genre in alphabetical order.
Song	System is playing back all songs in alphabetical order.
Playlist	System is playing back all songs from the selected playlist in the order they were added.
AudioBook	System is playing back AudioBook content.

HDD Menu

1. Press the MENU/SELECT knob to display the HDD Menu.

2. Turn the MENU/SELECT knob to highlight an option from the HDD Menu. The available options are:
 - Shuffle Songs
 - Playlist

7-30 Infotainment System

- Artists
 - Albums
 - Song Titles
 - Genres
 - Recently Saved
 - AudioBook
3. Press the MENU/SELECT knob to select the desired option.

Quick Jump

To scroll up or down the list of Artists, Albums, or Song Titles, press and hold the softkey under the FWD or REV tab.

To jump to the beginning, middle, or last section of the list:

- Press the first softkey under the display to go to the beginning section of the list.
- Press the second softkey under the display to go to the middle section of the list.

- Press the third softkey under the display to go to the last section of the list.

Shuffle Songs

Select this option from the HDD Menu to randomly play back HDD content.

Playlist

Select this option from the HDD Menu to display all six favorite playlists, then select one of the six playlists to display a list of songs that have been added to that favorite playlist. Select a song from the list to begin playback of that song and to put the HDD into the Playlist mode. See “Saving HDD Favorites” later in this section for more information.

HDD Categories

The HDD category mode can be used to select a song by a particular artist, album, or genre for playback. As an example, the HDD Menu displays a layout such as:

	Artists (5)
	Albums (6)
	Song Titles (77)
	Genres (3)

The radio system displays the number of available items in each individual category as shown on the sample display. For example, the sample display shows there is content on the hard drive from five individual artists.

Select the HDD Menu category to display the available items in each individual category, then select an item from one of these submenus to display a list of songs related to that menu item. Select a song to begin playback of that song and to put the HDD in the playback mode.

Recently Saved

Select this option from the HDD Menu to display the last 50 songs added since the vehicle was last turned on. The songs are categorized into songs recorded from CDs or USB devices.

AudioBook

The radio is able to play back AudioBook content downloaded from www.audible.com. This content can be transferred into the HDD by either burning it to a CD or copying it to a USB storage device and then recording it to the HDD.

The audible.com[®] playback requires activation of the vehicle as a player for downloaded content. The radio system activates the audible.com system when information is found on either a CD inserted into the CD/DVD player or a USB storage device that is connected. The Vehicle Identification Number (VIN) is required in order to activate the vehicle.

Saving HDD Favorites

Press the FAV button to change between favorite modes during HDD playback. The following favorite modes are supported:

- Playlists
- Artists
- Albums
- Genres

7-32 Infotainment System

Favorites can be saved by pressing and holding the softkey under the favorites selection. Store favorites according to the following table:

Favorites Display Mode	Action on Press-and-Hold
Playlist	Adds the currently playing track to the playlist selected.
Artist	Saves the artist associated with the currently playing track in the indicated favorites position.
Album	Saves the album associated with the currently playing track in the indicated favorites position.
Genre	Saves the genre associated with the currently playing track in the indicated favorites position.

Deleting a Song from a Playlist

Once a song has been added to a Playlist, to remove the song from the Playlist, select the song and start playback. Press the DEL button to display the options to delete the song from Playlist, HDD or Delete Playlist, and select the softkey below Playlist.

Configuring HDD Favorites

Press the CONFIG button to display the radio configuration options. Press the softkey under the HDD tab to display the available favorite modes. Press the softkey under the favorite tab to set the available favorite modes. Available favorite modes are highlighted.

Time Shifting — Pause and Rewind Live FM/AM and SiriusXM (if equipped)

The Radio with DVD Audio, HDD, and USB has the ability to rewind 60 minutes of FM/AM and SiriusXM (if equipped) content. While listening to the radio, the content from the current station is always being buffered to the HDD.

Press ► / || (play/pause) to pause the radio. The radio display will show the Time Shift buffer status bar. The status bar shows the amount of content stored in the buffer and the current pause point.

To resume playback from the current pause point, press ► / || again. The radio will no longer be playing “live” radio. Instead, time shifted content is being played from the buffer. When the radio is playing time shifted content from the buffer, a buffer status bar shows below the station number on the left side of the screen.

Press and hold ◀◀ REV or ▶▶ FWD to rewind or fast forward through the time shift buffer. Hold ▶▶ FWD until the end of the currently recorded buffer to resume “live” radio playback. With “live” radio playing, the radio display will no longer show the buffer bar below the station number.

On AM/FM, press ◀◀ REV or ▶▶ FWD multiple times to rewind or fast forward. Each press will rewind or fast forward 30 seconds of content. On SiriusXM, press ◀◀ REV or ▶▶ FWD multiple times to jump to the previous or next song or commercial.

When the radio station is changed, the buffer is cleared and automatically restarted for the current station. You cannot rewind the content from a previously tuned station.

Time shifting of AM/FM or SiriusXM is not available while recording or while other sources of playback are selected.

Pausing AM/FM or SiriusXM (if equipped) with the Vehicle Turned Off

If AM/FM or SiriusXM is paused before the vehicle is turned off, the radio will continue to buffer the current radio station for up to one hour. If the vehicle is turned back on within one hour, the radio will automatically resume playback from the pause point.

Auxiliary Devices

The 3.5 mm (1/8 in) auxiliary input jack and the USB port (if equipped) in the center console, allow portable devices to connect to the vehicle. This is not an audio output; do not plug headphones into the auxiliary input jack.

Set up auxiliary devices while the vehicle is stopped. See *Defensive Driving on page 9-3* for more information on driver distraction.

When a device is first connected to the 3.5 mm (1/8 in) input jack or the USB port (if equipped) the infotainment system automatically switches to that device. If an auxiliary device has already been connected, press the AUX or CD/AUX button.

3.5 mm Jack

Connect a 3.5 mm (1/8 in) cable to the auxiliary input jack to use a portable audio player.

Playback of an audio device that is connected to the 3.5 mm (1/8 in) jack can only be controlled using the controls on the device.

VOL/ ⏻ (Volume/Power): Turn clockwise or counterclockwise to increase or decrease the volume of the portable player. Use the portable device to make additional volume adjustments.

7-34 Infotainment System

CD or CD/AUX (CD/Auxiliary):

Press to play a CD when a portable audio device is playing. Press again to start playing audio from the connected portable audio player. If a portable audio player is not connected, "No Aux Device" displays.

USB Port

The USB connector uses the USB standards, 1.1 and 2.0.

USB Supported Devices

- USB Flash Drives
- Portable USB Hard Drives
- Fifth generation or later iPods*
- First, Second, or Third generation iPod nanos^{®*}
- iPod classics^{®*}

*For proper operation, make sure the iPod has the latest firmware from Apple[®]. The iPod firmware can be updated using the latest iTunes[®] application. See www.apple.com/itunes.

Connecting a USB Storage Device

Connect the USB storage device to the USB port in the center console. Some USB devices may not be supported.

Playing an MP3/WMA from a USB Storage Device

See *MP3 on page 7-23*.

Connecting an iPod

To connect the iPod, connect one end of the special iPod connection cable to the iPod's dock connector. Connect the other end to both the USB port and the auxiliary input jack in the center console. The USB port (if equipped) and the auxiliary input jack are in the center console. If the vehicle is on and the USB connection works, a GM logo may appear on the iPod. The iPod's music information will be shown on the radio's display and the music begins playing through the vehicle's audio system.

The iPod's battery charges while it is connected to the vehicle and if the ignition is turned to ACC/ACCESSORY or ON/RUN. It can also be left connected to the vehicle after the vehicle is turned off. With the vehicle turned off, the iPod will automatically be powered off and will not charge or draw power from the vehicle's battery.

A standard iPod USB cable, like the one that came with the iPod, cannot be used to connect an iPod to the vehicle. The special iPod connection cable that came equipped with the vehicle or that was made available from your dealer must be used to command and control an iPod.

Use a standard 3.5 mm (1/8 in) stereo cable to connect an older iPod model that is not supported, or if the special iPod connection cable is missing. Command and control of the iPod using the infotainment control buttons and knobs is not supported when only a 3.5 mm (1/8 in) stereo cable is used.

Commanding and Controlling an iPod

An iPod can be controlled by using the radio buttons and knobs; the song information shows on the infotainment system's display. To connect and control the iPod using the radio controls, use the special iPod connection cable that came as standard equipment with the vehicle as part of the USB option. The special iPod connection cable can also be purchased or made available from your dealer. See your dealer for more information.

Use the MENU/SELECT knob to bring up the iPod Menu and select Songs, Artists, Albums, Playlists, and Audio Books to play from the iPod.

Disconnecting an iPod

To properly dismount the iPod USB device before disconnecting from the vehicle, press the softkey under the EJECT tab on the infotainment display screen during iPod playback.

Phone

Bluetooth

For vehicles equipped with Bluetooth capability, the system can interact with many cell phones, allowing:

- Placement and receipt of calls in a hands-free mode.
- Sharing of the cell phone's address book or contact list with the vehicle.

To minimize driver distraction, before driving, and with the vehicle parked:

- Become familiar with the features of the cell phone. Organize the phone book and contact lists clearly and delete duplicate or rarely used entries. If possible, program speed dial or other shortcuts.
- Review the controls and operation of the infotainment system.

- Pair cell phone(s) to the vehicle. The system may not work with all cell phones. See "Pairing" in this section for more information.
- If the cell phone has voice dialing capability, learn to use that feature to access the address book or contact list. See "Voice Pass-Thru" in this section for more information.
- See "Storing and Deleting Phone Numbers" in this section for more information.

Warning

When using a cell phone, it can be distracting to look too long or too often at the screen of the phone or the infotainment (navigation) system. Taking your eyes off the road too long or too often could cause a crash resulting in injury or death. Focus your attention on driving.

7-36 Infotainment System

Vehicles with a Bluetooth® system can use a Bluetooth-capable cell phone with a Hands-Free Profile to make and receive phone calls. The system can be used while the ignition is in the ON/RUN or ACC/ACCESSORY position. The range of the Bluetooth system can be up to 9.1 m (30 ft). Not all phones support all functions, and not all phones work with the Bluetooth system. See www.gm.com/bluetooth for more information on compatible phones.

Voice Recognition

The Bluetooth system uses voice recognition to interpret voice commands to dial phone numbers and name tags.

For additional information say “Help” while you are in a voice recognition menu.

Noise: Keep interior noise levels to a minimum. The system may not recognize voice commands if there is too much background noise.

When to Speak: A short tone sounds after the system responds indicating when it is waiting for a voice command. Wait until the tone and then speak.



How to Speak: Speak clearly in a calm and natural voice.



Audio System

When using the in-vehicle Bluetooth system, sound comes through the vehicle's front audio system speakers and over-rides the audio system. Use the audio system volume knob, during a call, to change the volume level. The adjusted volume level remains in memory for later calls. To prevent missed calls, a minimum volume level is used if the volume is turned down too low.

Bluetooth Controls

Use the buttons on the steering wheel to operate the in-vehicle Bluetooth system. See *Steering Wheel Controls* on page 5-3 for more information.

 /  (Push To Talk): Press to answer incoming calls, confirm system information, and start speech recognition.

 /  (Phone On Hook): Press to end a call, reject a call, or cancel an operation.

For vehicles without a navigation system, the system responds with “Ready” followed by a tone.

For vehicles with a navigation system, the system responds with a tone. After the tone, say “Hands Free.” The system responds with “Ready” followed by a tone.

Pairing

A Bluetooth-enabled cell phone must be paired to the in-vehicle Bluetooth system and then connected to the vehicle before it can be used. See the cell phone manufacturer's user guide for Bluetooth functions before pairing the cell phone. If a Bluetooth phone is not connected, calls will be made



using OnStar Hands-Free Calling, if available. See *OnStar Overview on page 14-1* for more information.

Pairing Information:

- A Bluetooth phone with MP3 capability cannot be paired to the vehicle as a phone and an MP3 player at the same time.
- Up to five cell phones can be paired to the Bluetooth system.
- The pairing process is disabled when the vehicle is moving.
- Pairing only needs to be completed once, unless the pairing information on the cell phone changes or the cell phone is deleted from the system.
- Only one paired cell phone can be connected to the Bluetooth system at a time.
- If multiple paired cell phones are within range of the system, the system connects to the first available paired cell phone in the order that they were first paired to the system. To link to a

different paired phone, see “Connecting to a Different Phone” later in this section.



Pairing a Phone

1. Press and hold  /  for two seconds. For vehicles with a navigation system say “Hands Free” after the tone.
2. Say “Bluetooth.” This command can be skipped.
3. Say “Pair.” The system responds with instructions and a four-digit Personal Identification Number (PIN). The PIN will be used in Step 5.
4. Start the pairing process on the cell phone that you want to pair. For help with this process, see your cell phone manufacturer’s user guide.
5. Locate the device named “Your Vehicle” in the list on the cell phone. Follow the instructions on the cell phone to enter the PIN that was provided in Step 3. After the PIN is successfully



entered, the system prompts you to provide a name for the paired cell phone. This name will be used to indicate which phones are paired and connected to the vehicle. The system responds with “<phone name> has been successfully paired” after the pairing process is complete.

6. Repeat Steps 1 through 5 to pair additional phones.

Listing All Paired and Connected Phones

1. Press and hold  /  for two seconds. For vehicles with a navigation system say “Hands Free” after the tone.
2. Say “Bluetooth.”
3. Say “List.”

Deleting a Paired Phone

1. Press and hold  /  for two seconds. For vehicles with a navigation system say “Hands Free” after the tone.



7-38 Infotainment System

2. Say “Bluetooth.”
3. Say “Delete.” The system asks which phone to delete.
4. Say the name of the phone you want to delete.

If the phone name to delete is unknown, see “Listing All Paired and Connected Phones.”

Connecting to a Different Phone

To connect to a different cell phone, the Bluetooth system looks for the next available cell phone in the order in which all available cell phones were paired. Depending on which cell phone you want to connect to, you may have to use this command several times.

1. Press and hold  /  for two seconds. For vehicles with a navigation system say “Hands Free” after the tone.
2. Say “Bluetooth.”

3. Say “Change phone.”
 - If another phone is found, the response will be “<Phone name> is now connected.”
 - If another phone is not found, the original phone remains connected.

Storing and Deleting Phone Numbers

The system can store up to 30 phone numbers as name tags in the Hands-Free Directory that is shared between the Bluetooth and OnStar systems.

The following commands are used to delete and store phone numbers.



Store: This command will store a phone number, or a group of numbers as a name tag.

Digit Store: This command allows a phone number to be stored as a name tag by entering the digits one at a time.

Delete: This command is used to delete individual name tags.

Delete All Name Tags: This command deletes all stored name tags in the Hands-Free Calling Directory and the OnStar Turn-by-Turn Destinations Directory.



Using the “Store” Command

1. Press and hold  /  for two seconds. For vehicles with a navigation system say “Hands Free” after the tone.
2. Say “Store.”
3. Say the phone number or group of numbers you want to store all at once with no pauses, then follow the directions given by the system to save a name tag for this number.



Using the “Digit Store” Command

If an unwanted number is recognized by the system, say “Clear” at any time to clear the last number.

To hear all of the numbers recognized by the system, say "Verify" at any time.

1. Press and hold  /  for two seconds. For vehicles with a navigation system say "Hands Free" after the tone.
2. Say "Digit Store."
3. Say each digit, one at a time, that you want to store. After each digit is entered, the system repeats back the digit it heard followed by a tone. After the last digit has been entered, say "Store," and then follow the directions given by the system to save a name tag for this number.



Using the "Delete" Command

1. Press and hold  /  for two seconds. For vehicles with a navigation system say "Hands Free" after the tone.
2. Say "Delete."
3. Say the name tag you want to delete.

Using the "Delete All Name Tags" Command

This command deletes all stored name tags in the Hands-Free Calling Directory and the OnStar Turn-by-Turn Destinations Directory.



To delete all name tags:

1. Press and hold  /  for two seconds. For vehicles with a navigation system say "Hands Free" after the tone.
2. Say "Delete all name tags."

Listing Stored Numbers

The list command will list all stored numbers and name tags.

Using the "List" Command

1. Press and hold  /  for two seconds. For vehicles with a navigation system say "Hands Free" after the tone.
2. Say "Directory."
3. Say "Hands-Free Calling."
4. Say "List."

Making a Call



Calls can be made using the following commands.

Dial or Call: The dial or call command can be used interchangeably to dial a phone number or a stored name tag.



Digit Dial: This command allows a phone number to be dialed by entering the digits one at a time.

Re-dial: This command is used to dial the last number used on the cell phone.

Using the "Dial" or "Call" Command

1. Press and hold  /  for two seconds. For vehicles with a navigation system say "Hands Free" after the tone.
2. Say "Dial" or "Call."
3. Say the entire number without pausing or say the name tag.

Calling 911 Emergency

1. Press and hold  /  for two seconds. For vehicles with a navigation system say “Hands Free” after the tone.
2. Say “Dial” or “Call.”
3. Say “911.”



Once connected, the person called will be heard through the audio speakers.

Using the “Digit Dial” Command

The digit dial command allows a phone number to be dialed by entering the digits one at a time. After each digit is entered, the system repeats back the digit it heard followed by a tone.



If an unwanted number is recognized by the system, say “Clear” at any time to clear the last number.

To hear all of the numbers recognized by the system, say “Verify” at any time.

1. Press and hold  /  for two seconds. For vehicles with a navigation system say “Hands Free” after the tone.
2. Say “Digit Dial.”
3. Say each digit, one at a time, that you want to dial. After each digit is entered, the system repeats back the digit it heard followed by a tone. After the last digit has been entered, say “Dial.”

Once connected, the person called will be heard through the audio speakers.

Using the “Re-dial” Command





1. Press and hold  /  for two seconds. For vehicles with a navigation system say “Hands Free” after the tone.

2. After the tone, say “Re-dial.” The system dials the last number called from the connected cell phone.

Once connected, the person called will be heard through the audio speakers.





Receiving a Call



When an incoming call is received, the audio system mutes and a ring tone is heard in the vehicle.

- Press  /  to answer the call.
- Press  /  to ignore a call.

Call Waiting





Call waiting must be supported on the cell phone and enabled by the wireless service carrier.

- Press  /  to answer an incoming call when another call is active. The original call is placed on hold.
- Press  /  again to return to the original call.

- To ignore the incoming call, no action is required.
- Press  /  to disconnect the current call and switch to the call on hold.

Three-Way Calling

Three-Way Calling must be supported on the cell phone and enabled by the wireless service carrier to work.



1. While on a call press  / .
2. Say “Three-way call.”
3. Use the dial or call command to dial the number of the third party to call.
4. Once the call is connected, press  /  to link all callers together.



Ending a Call

Press  /  to end a call.

Muting a Call

During a call, all sounds from inside the vehicle can be muted so that the person on the other end of the call cannot hear them.

To mute a call, press  /  and then say “Mute Call.”

To cancel mute, press  /  and then say “Un-mute Call.”



Transferring a Call

Audio can be transferred between the in-vehicle Bluetooth system and the cell phone.



The cell phone must be paired and connected with the Bluetooth system before a call can be transferred. The connection process can take up to two minutes after the ignition is turned to ON/RUN.

Transferring Audio from the Bluetooth System to a Cell Phone

To transfer a call with the audio in the vehicle:



1. Press  / .
2. Say “Transfer Call.”

Transferring Audio to the Bluetooth System from a Cell Phone

During a call with the audio on the cell phone, press  /  for two seconds. For vehicles with a navigation system say “Hands Free” after the tone. The audio transfers to the vehicle. If the audio does not transfer to the vehicle, use the audio transfer feature on the cell phone. See your cell phone manufacturer’s user guide for more information.

Voice Pass-Thru



Voice Pass-Thru allows access to the voice recognition commands on the cell phone. See the cell phone manufacturer's user guide to see if the cell phone supports this feature. This feature can be used to verbally access contacts stored in the cell phone.

1. Press and hold  /  for two seconds. For vehicles with a navigation system say "Hands Free" after the tone.
2. Say "Bluetooth." This command can be skipped.
3. Say "Voice." The system responds with "OK, accessing <phone name>."
 - The cell phone's normal prompt messages will go through their cycle according to the phone's operating instructions.

Dual Tone Multi-Frequency (DTMF) Tones

The Bluetooth system can send numbers and the numbers stored as name tags during a call. You can use this feature when calling a menu-driven phone system. Account numbers can also be stored for use.

To send a number or name tag during a call:

1. Press  / . For vehicles with a navigation system say "Hands Free" after the tone.
2. Say "Dial."
3. Say the number or name tag to send.

Clearing the System

Unless information is deleted out of the in-vehicle Bluetooth system, it will be retained indefinitely. This includes all saved name tags in the phone book and phone pairing information. For information on how to delete this information, see the previous sections on "Deleting a Paired Phone" and "Storing and Deleting Phone Numbers."

Other Information

The Bluetooth[®] word mark and logos are owned by the Bluetooth[®] SIG, Inc. and any use of such marks by General Motors is under license. Other trademarks and trade names are those of their respective owners.

See *Radio Frequency Statement on page 13-15*.

Trademarks and License Agreements



Manufactured under license under U.S. Patent #'s: 5,451,942; 5,956,674; 5,974,380; 5,978,762; 6,487,535 & other U.S. and worldwide patents issued & pending. DTS and the Symbol are registered trademarks and DTS Digital Surround and the DTS logos are trademarks of DTS Inc. All Rights Reserved.



Manufactured under license from Dolby Laboratories. Dolby and the double-D symbol are trademarks of Dolby Laboratories.



“Made for iPod” and “Made for iPhone” mean that an electronic accessory has been designed to connect specifically to iPod or iPhone, respectively, and has been certified by the developer to meet Apple performance standards.

Apple is not responsible for the operation of this device or its compliance with safety and regulatory standards. Please note that the use of this accessory with iPod or iPhone may affect wireless performance.

iPhone, iPod, iPod classic, iPod nano, and iPod touch are trademarks of Apple Inc., registered in the U.S. and other countries.



Music and video recognition technology and related data are provided by Gracenote®. Gracenote is the industry standard in music recognition technology and related content delivery. For more information, visit www.gracenote.com.

CD and music data from Gracenote, Inc., copyright © 2000 to present Gracenote. One or more patents owned by Gracenote apply to this product and service. See the Gracenote website for a non-exhaustive list of applicable Gracenote patents. Gracenote and CDDB, MusicID, Media VOCS, the Gracenote logo and logotype, and the "Powered by Gracenote" logo are either registered trademarks or trademarks of Gracenote in the United States and/or other countries.

If you require more information regarding the use of the Gracenote Service, visit: www.gracenote.com/corporate.

For the data provided by Gracenote[®] Music Recognition Service, the content is not necessarily guaranteed 100%.

Regarding the use of Gracenote Music Recognition Service, when this product is used, it is necessary to agree to the following articles.

Gracenote[®] End User License

This application or device contains software from Gracenote, Inc. of Emeryville, California ("Gracenote"). The software from Gracenote (the "Gracenote Software") enables this application to perform disc and/or file identification and obtain music-related information, including name, artist, track, and title information ("Gracenote Data") from online servers or embedded databases (collectively, "Gracenote Servers") and to perform other functions. You may use Gracenote Data only by means of the intended End-User functions of this application or device. You agree that you will use Gracenote Data, the Gracenote Software, and Gracenote Servers for your own personal non-commercial use only. You agree not to assign, copy, transfer or transmit the Gracenote Software or any Gracenote Data to any third party.

YOU AGREE NOT TO USE OR EXPLOIT GRACENOTE DATA, THE GRACENOTE SOFTWARE, OR GRACENOTE SERVERS, EXCEPT AS EXPRESSLY PERMITTED HEREIN. You agree that your non-exclusive license to use the Gracenote Data, the Gracenote Software, and Gracenote Servers will terminate if you violate these restrictions. If your license terminates, you agree to cease any and all use of the Gracenote Data, the Gracenote Software, and Gracenote Servers.

Gracenote reserves all rights in Gracenote Data, the Gracenote Software, and the Gracenote Servers, including all ownership rights.

Under no circumstances will Gracenote become liable for any payment to you for any information that you provide. You agree that Gracenote, Inc. may enforce its rights under this Agreement against you directly in its own name.

The Gracenote service uses a unique identifier to track queries for statistical purposes.

The purpose of a randomly assigned numeric identifier is to allow the Gracenote service to count queries without knowing anything about who you are. For more information, see the web page for the Gracenote Privacy Policy for the Gracenote service.

The Gracenote Software and each item of Gracenote Data are licensed to you "AS IS." Gracenote makes no representations or warranties, express or implied, regarding the accuracy of any Gracenote Data from in the Gracenote Servers.

Gracenote reserves the right to delete data from the Gracenote Servers or to change data categories for any cause that Gracenote deems sufficient.

No warranty is made that the Gracenote Software or Gracenote Servers are error-free or that functioning of Gracenote Software or Gracenote Servers will be uninterrupted.

Gracenote is not obligated to provide you with new enhanced or additional data types or categories that Gracenote may provide in the future and is free to discontinue its services at any time.

Gracenote disclaims all warranties express or implied, including, but not limited to, implied warranties of merchantability, fitness for a particular purpose, title, and non-infringement. Gracenote does not warrant the results that will be obtained by your use of the Gracenote software or any Gracenote server. In no case will Gracenote be liable for any consequential or incidental damages or for any lost profits or lost revenues.

Climate Controls

Climate Control Systems

Dual Automatic Climate Control System 8-1

Air Vents

Air Vents 8-6

Maintenance

Passenger Compartment Air Filter 8-6

Climate Control Systems

Dual Automatic Climate Control System

The heating, cooling, and ventilation for the vehicle can be controlled with this system.

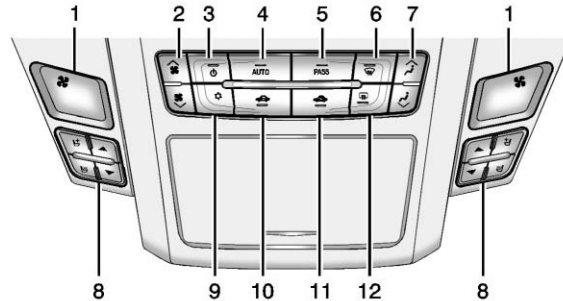

1. Driver and Passenger Displays
2. Fan
3. Power
4. AUTO (Automatic Operation)
5. PASS (Passenger Climate Control)

6. Defrost
7. Air Delivery Mode
8. Temperature and Heated/Ventilated Seat
9. Air Conditioning
10. Recirculation

8-2 Climate Controls

11. Outside Air
12. Rear Window Defogger

Automatic Operation

AUTO (Automatic): The system automatically controls fan speed, air delivery, and air conditioning in order to heat or cool the vehicle to the desired temperature. When the indicator light is on, the system is in full automatic operation. If the air delivery mode or fan setting is manually adjusted, the auto indicator turns off and displays will show the selected settings.

1. Press the AUTO button.
2. Adjust the temperature to a comfortable setting between 21°C (70°F) and 27°C (80°F).

Choosing the coldest or warmest temperature setting will not cause the system to heat or cool any faster.

To avoid blowing cold air in cold weather, the system delays turning on the fan until warm air

is available. The system starts out blowing air at the floor, but can automatically change modes as the vehicle warms up to maintain the chosen temperature setting. The length of time needed for warm up depends on the outside temperature and the length of time that has elapsed since the vehicle was last driven.

3. Wait for the system to regulate. This may take from 10 to 30 minutes. Then adjust the temperature, if necessary.

English can be changed to metric units through the Driver Information Center (DIC). See *Driver Information Center (DIC)* on page 5-27.

▲ / ▼ (Temperature Control): The temperature can be adjusted separately for the driver and the passenger. Press to increase or decrease the automatic temperature settings.

PASS (Passenger Climate

Control): Press to set a different temperature for the passenger. Then adjust the passenger temperature buttons to a comfortable setting.

Pressing the PASS button again automatically sets the passenger's temperature to the driver's setting.

Turning the passenger's temperature display off does not shut the passenger's climate control system off.

Manual Operation

⏻ (Power): Press to turn the climate control system on or off. When the climate control system is turned off the air inlet defaults to outside air.

⚙️ (Fan Control): Press the buttons to increase or decrease the fan speed. Pressing either button cancels automatic fan control. Press AUTO to return to automatic

operation. The blower may reduce during an Onstar® session to limit background noise.

If the airflow seems low when the fan speed is at the highest setting, the passenger compartment air filter might need to be replaced. For more information, see *Passenger Compartment Air Filter on page 8-6*.

 **(Air Delivery Mode Control):** Press the buttons to change the direction of the airflow. The current mode appears in the display screen. Changing the mode cancels the automatic air delivery. Press AUTO to return to automatic operation.

The outboard air outlets always receive some airflow in every mode, except defrost.

To change the current mode, select one of the following:

 **(Vent):** Air is directed to the instrument panel outlets.

 **(Bi-Level):** Air is divided between the instrument panel outlets and the floor outlets. In

automatic operation, cooler air is directed to the upper outlets and warmer air to the floor outlets.

 **(Floor):** Air is directed to the floor outlets, with some air directed to the windshield and outboard outlets.

 **(Defog):** This mode clears the windows of fog or moisture. Air is directed to the windshield, floor, and side window outlets. When this mode is selected, the system turns off recirculation and runs the air-conditioning compressor unless the outside temperature is at or below freezing. If recirculation is selected while in defog mode, it is cancelled after 10 minutes.

 **(Defrost):** This mode clears the windshield of fog or frost more quickly. Air is directed to the windshield, with some air directed to the side windows. In this mode, the system automatically turns off recirculation and runs the

air-conditioning compressor, unless the outside temperature is at or below freezing.

This mode can also cause the fan speed and air temperature to increase.

 **(Air Conditioning):** Press to turn the air conditioning system on or off and override the automatic system. When in AUTO, the air conditioning compressor comes on automatically, as needed.

The air conditioning system removes moisture from the air, so water might drip under the vehicle while idling or after turning off the engine. This is normal.

 **(Recirculation):** Press to turn on recirculation. An indicator light comes on. Air is recirculated inside the vehicle. It helps to quickly cool the air inside the vehicle or prevent outside air and odors from entering. Press the AUTO button to have the system select the best air delivery mode for the temperature setting.

8-4 Climate Controls

Recirculation is not available in the defrost mode and automatically turns off 10 minutes after defog is selected. This helps to limit window fogging in the vehicle.

Using recirculation for long periods of time could cause the air inside the vehicle to become too dry or stuffy. To prevent this from happening, after the air in the vehicle has cooled, select outside air or press the auto button.

 **(Outside Air):** Press to turn on the outside air. An indicator light turns on. The outside air mode pulls fresh air from outside the vehicle. Outside air is always selected in defrost mode to prevent fogging.

Rear Window Defogger

The rear window defogger uses a warming grid to remove fog or frost from the rear window. It only works when the ignition is in ON/RUN.

 **(Rear Window Defogger):** Press to turn the rear window defogger on or off.

The rear window defogger stays on for about 15 minutes, before turning off if the vehicle is moving at a slower speed. At higher speeds, the rear window defogger may stay on continuously. With each additional press, the defogger runs for about 10 minutes. The defogger can also be turned off by turning off the engine.

The heated outside rearview mirrors turn on when the rear window defogger button is on and helps to clear fog or frost from the surface of the mirrors. See *Heated Mirrors on page 2-27*.

Caution

Do not try to clear frost or other material from the inside of the front windshield and rear window with a razor blade or anything else that is sharp. This may damage the rear window defogger grid and affect the

(Continued)

Caution (Continued)

radio's ability to pick up stations clearly. The repairs would not be covered by the vehicle warranty.

 **(Heated and Ventilated Seats, If Equipped):** Press to heat or ventilate the seat. See *Heated and Ventilated Front Seats on page 3-9*.

Remote Start Climate Control

Operation: If equipped with remote vehicle start, the climate control system automatically heats and cools the vehicle based on the temperature inside and outside of the vehicle. The climate control displays will be blank. See *Remote Vehicle Start on page 2-11*.

In cold weather the windshield defroster and/or rear window defogger automatically turn on. If the vehicle has heated seats, they will also turn on.

When the ignition is turned to ON/RUN, the climate control system returns to the settings used before the vehicle was last turned off. The heated seats will turn off, if equipped.

Sensors

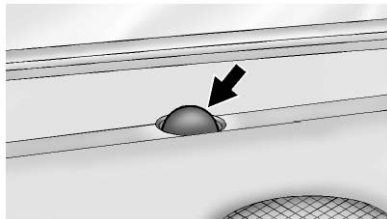

The solar sensor on the instrument panel, near the windshield, monitors the solar heat.

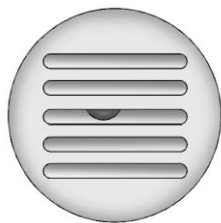

The interior temperature sensor, on the instrument panel to the right of the steering wheel, measures the temperature of the air inside the vehicle.

The climate control system uses the information from these sensors to adjust the fan speed and the air delivery, in order to maintain the selected temperature. The system may also supply cooler air to the side of the vehicle facing the sun. The recirculation mode will also be activated, as necessary.

Do not cover the sensors or the automatic climate control system will not work properly.

Air Quality Sensor

For vehicles with an air quality sensor, the climate control system adjusts to limit some exhaust fumes from being pulled inside your vehicle.

Press the AUTO button on the climate control to activate the air quality sensor. The recirculation indicator light comes on when poor quality air is detected. The air quality sensor will not maintain recirculation for an extended period to prevent the air inside the vehicle from becoming too dry or stuffy.

Under certain conditions, the air quality sensor will not activate, such as during cold weather or with extreme odors. Press  to activate recirculation.

The air quality sensor system does not protect against carbon monoxide (CO), which you cannot see or smell. See *Engine Exhaust* on page 9-25.

Air Vents

Use the air outlets in the center and on the side of the instrument panel to direct the airflow. Use the thumbwheels near the air outlets to open or close off the airflow.

Operation Tips

- Clear away any ice, snow, or leaves from air inlets at the base of the windshield that could block the flow of air into the vehicle.
- Keep the path under the front seats clear of objects to help circulate the air inside of the vehicle more effectively.
- Use of non-GM approved hood deflectors can adversely affect the performance of the system. Check with your dealer before adding equipment to the outside of the vehicle.

Maintenance

Passenger Compartment Air Filter

The passenger compartment air filter traps most of the dust and pollen from the air entering the vehicle. The filter will need to be changed periodically. See *Maintenance Schedule on page 11-4*.

Using the climate control system without the passenger air filter installed could let water or other debris enter the system. This could cause a water leak or noises. Make sure a new air filter is installed after removing the old one.

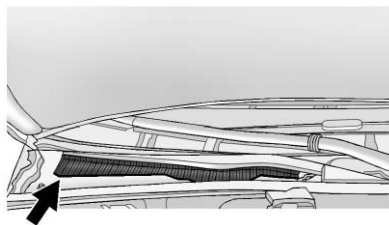

The passenger compartment air filter is under the hood below the windshield wiper arm and the screen on the passenger side of the vehicle. See *Engine Compartment Overview on page 10-6* for more information on location.

To replace the passenger compartment air filter:

1. Turn the ignition to ON/RUN with the engine off.

2. Turn on the windshield wipers and turn the ignition off again when the wipers are straight up on the windshield.

This allows access to the leaf screen. The passenger compartment air filter is under the screen.

3. Open the hood to access the engine compartment. See *Hood on page 10-5*.
4. Remove the three screws that hold the screen in place and lift off the screen by lifting and sliding it toward the center of the vehicle.

5. Pull out on the two tabs on each end of the filter cover.
6. Lift the filter cover off by pulling it straight up.
7. Remove the old filter and insert a new one.
See Maintenance Replacement Parts on page 11-15 for the correct part number for the filter.
8. Reverse Steps 1–6 to reinstall the cover.

Driving and Operating

Driving Information

Distracted Driving	9-2
Defensive Driving	9-3
Drunk Driving	9-3
Control of a Vehicle	9-3
Braking	9-3
Steering	9-4
Off-Road Recovery	9-5
Loss of Control	9-5
Track Events and Competitive Driving	9-6
Driving on Wet Roads	9-6
Highway Hypnosis	9-7
Hill and Mountain Roads	9-8
Winter Driving	9-8
If the Vehicle Is Stuck	9-10
Vehicle Load Limits	9-11

Starting and Operating

New Vehicle Break-In	9-15
Ignition Positions (Keyless Access)	9-15
Ignition Positions (Key Access)	9-17
Starting the Engine	9-20
Retained Accessory Power (RAP)	9-22
Engine Coolant Heater	9-22
Shifting Into Park	9-23
Shifting out of Park	9-24
Parking (Manual Transmission)	9-25
Parking over Things That Burn	9-25

Engine Exhaust

Engine Exhaust	9-25
Running the Vehicle While Parked	9-26

Automatic Transmission

Automatic Transmission	9-26
Manual Mode	9-28

Manual Transmission

Manual Transmission	9-31
---------------------------	------

Drive Systems

All-Wheel Drive	9-33
-----------------------	------

Brakes

Antilock Brake System (ABS)	9-33
Parking Brake (Manual)	9-34
Parking Brake (Electric)	9-35
Brake Assist	9-37

Ride Control Systems

Traction Control/Electronic Stability Control	9-38
Competitive Driving Mode	9-39
Magnetic Ride Control	9-40
Limited-Slip Rear Axle	9-40

Cruise Control

Cruise Control	9-41
----------------------	------

Driver Assistance Systems

Ultrasonic Parking Assist	9-43
Side Blind Zone Alert (SBZA)	9-44
Rear Vision Camera (RVC)	9-46

9-2 Driving and Operating

Fuel

Fuel	9-49
Gasoline Specifications	9-50
California Fuel Requirements	9-50
Fuels in Foreign Countries ...	9-50
Fuel Additives	9-50
Filling the Tank	9-51
Filling a Portable Fuel Container	9-52

Trailer Towing

General Towing Information	9-53
Driving Characteristics and Towing Tips	9-53
Trailer Towing (CTS-V and Coupe)	9-56
Trailer Towing (Except CTS-V and Coupe)	9-56
Towing Equipment	9-58

Conversions and Add-Ons

Add-On Electrical Equipment	9-59
-----------------------------------	------

Driving Information

Distracted Driving

Distraction comes in many forms and can take your focus from the task of driving. Exercise good judgment and do not let other activities divert your attention away from the road. Many local governments have enacted laws regarding driver distraction. Become familiar with the local laws in your area.

To avoid distracted driving, always keep your eyes on the road, hands on the wheel, and mind on the drive.

- Do not use a phone in demanding driving situations. Use a hands-free method to place or receive necessary phone calls.
- Watch the road. Do not read, take notes, or look up information on phones or other electronic devices.

- Designate a front seat passenger to handle potential distractions.
- Become familiar with vehicle features before driving, such as programming favorite radio stations and adjusting climate control and seat settings. Program all trip information into any navigation device prior to driving.
- Wait until the vehicle is parked to retrieve items that have fallen to the floor.
- Stop or park the vehicle to tend to children.
- Keep pets in an appropriate carrier or restraint.
- Avoid stressful conversations while driving, whether with a passenger or on a cell phone.

 **Warning**

Taking your eyes off the road too long or too often could cause a crash resulting in injury or death. Focus your attention on driving.

Refer to the infotainment section for more information on using that system and the navigation system, if equipped, including pairing and using a cell phone.

Defensive Driving

Defensive driving means “always expect the unexpected.” The first step in driving defensively is to wear the safety belt. See *Safety Belts on page 3-12*.

- Assume that other road users (pedestrians, bicyclists, and other drivers) are going to be careless and make mistakes. Anticipate what they might do and be ready.

- Allow enough following distance between you and the driver in front of you.
- Focus on the task of driving.

Drunk Driving

Death and injury associated with drinking and driving is a global tragedy.

 **Warning**

Drinking and then driving is very dangerous. Your reflexes, perceptions, attentiveness, and judgment can be affected by even a small amount of alcohol. You can have a serious — or even fatal — collision if you drive after drinking.

Do not drink and drive or ride with a driver who has been drinking. Ride home in a cab; or if you are with a group, designate a driver who will not drink.

Control of a Vehicle

Braking, steering, and accelerating are important factors in helping to control a vehicle while driving.

Braking

Braking action involves perception time and reaction time. Deciding to push the brake pedal is perception time. Actually doing it is reaction time.

Average driver reaction time is about three-quarters of a second. In that time, a vehicle moving at 100 km/h (60 mph) travels 20 m (66 ft), which could be a lot of distance in an emergency.

Helpful braking tips to keep in mind include:

- Keep enough distance between you and the vehicle in front of you.
- Avoid needless heavy braking.
- Keep pace with traffic.

9-4 Driving and Operating

If the engine ever stops while the vehicle is being driven, brake normally but do not pump the brakes. Doing so could make the pedal harder to push down. If the engine stops, there will be some power brake assist but it will be used when the brake is applied. Once the power assist is used up, it can take longer to stop and the brake pedal will be harder to push.

Steering

Hydraulic Power Steering

This vehicle has hydraulic power steering. It may require maintenance. See *Power Steering Fluid* on page 10-25.

If power steering assist is lost because the engine stops or because of a system malfunction, the vehicle can be steered but may require increased effort. See your dealer if there is a problem.

 Caution
If the steering wheel is turned until it reaches the end of its travel, and is held in that position for more than 15 seconds, damage may occur to the power steering system and there may be loss of power steering assist.

Curve Tips

- Take curves at a reasonable speed.
- Reduce speed before entering a curve.
- Maintain a reasonable steady speed through the curve.
- Wait until the vehicle is out of the curve before accelerating gently into the straightaway.

Steering in Emergencies

- There are some situations when steering around a problem may be more effective than braking.
- Holding both sides of the steering wheel allows you to turn 180 degrees without removing a hand.
- Antilock Brake System (ABS) allows steering while braking.

Off-Road Recovery

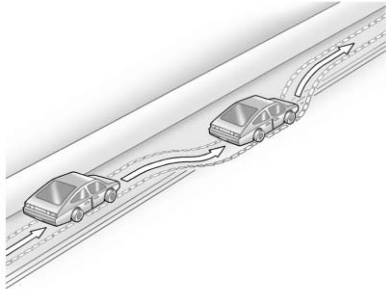

The vehicle's right wheels can drop off the edge of a road onto the shoulder while driving. Follow these tips:

1. Ease off the accelerator and then, if there is nothing in the way, steer the vehicle so that it straddles the edge of the pavement.
2. Turn the steering wheel about one-eighth of a turn, until the right front tire contacts the pavement edge.

3. Turn the steering wheel to go straight down the roadway.

Loss of Control

Skidding

There are three types of skids that correspond to the vehicle's three control systems:

- Braking Skid — wheels are not rolling.
- Steering or Cornering Skid — too much speed or steering in a curve causes tires to slip and lose cornering force.
- Acceleration Skid — too much throttle causes the driving wheels to spin.

Defensive drivers avoid most skids by taking reasonable care suited to existing conditions, and by not overdriving those conditions. But skids are always possible.

If the vehicle starts to slide, follow these suggestions:

- Ease your foot off the accelerator pedal and steer the way you want the vehicle to go. The vehicle may straighten out. Be ready for a second skid if it occurs.
- Slow down and adjust your driving according to weather conditions. Stopping distance can be longer and vehicle control can be affected when traction is reduced by water, snow, ice, gravel, or other material on the road. Learn to recognize warning clues — such as enough water, ice, or packed snow on the road to make a mirrored surface — and slow down when you have any doubt.
- Try to avoid sudden steering, acceleration, or braking, including reducing vehicle speed by shifting to a lower gear. Any sudden changes could cause the tires to slide.

9-6 Driving and Operating

Remember: Antilock brakes help avoid only the braking skid.

Track Events and Competitive Driving

Track events and competitive driving may affect the vehicle warranty. See the warranty manual before using the vehicle for competitive driving.

Caution

If the vehicle is used for track events and competitive driving, the engine may use more oil than it would with normal use. Low oil levels can damage the engine. Check the oil level often and at the proper level. See *Engine Oil* on page 10-10.

Caution

During a first time track or racing event, high rear axle temperatures can occur. Damage could be caused to the rear axle and would not be covered by the vehicle warranty.

Do not drive as long or as fast the first time the vehicle is driven on the track or raced.

CTS-V Only: Be sure to check the oil level often during racing, track testing or other competitive driving and keep the level at or near the upper mark that shows the proper operating range on the engine oil dipstick.

For track testing and competitive driving, it is recommended that the brake fluid be replaced with a high performance brake fluid that has a dry boiling point greater than 279°C (534°F). After conversion to the high performance brake fluid, follow

the brake fluid service recommendations outlined by the fluid manufacturer. Do not use silicone or DOT-5 brake fluids.

HF V6 Engine Only: Be sure to check the oil level often during racing, track testing or other competitive driving and keep the level at or near 0.5 L (0.5 qt) above the upper mark that shows the proper operating range on the engine oil dipstick. For racing, track testing or other competitive driving an engine oil cooler must be installed.

Driving on Wet Roads

Rain and wet roads can reduce vehicle traction and affect your ability to stop and accelerate. Always drive slower in these types of driving conditions and avoid driving through large puddles and deep-standing or flowing water.

 **Warning**

Wet brakes can cause crashes. They might not work as well in a quick stop and could cause pulling to one side. You could lose control of the vehicle.

After driving through a large puddle of water or a car/vehicle wash, lightly apply the brake pedal until the brakes work normally.

Flowing or rushing water creates strong forces. Driving through flowing water could cause the vehicle to be carried away. If this happens, you and other vehicle occupants could drown. Do not ignore police warnings and be very cautious about trying to drive through flowing water.

Hydroplaning

Hydroplaning is dangerous. Water can build up under the vehicle's tires so they actually ride on the water. This can happen if the road is wet enough and you are going fast enough. When the vehicle is hydroplaning, it has little or no contact with the road.

There is no hard and fast rule about hydroplaning. The best advice is to slow down when the road is wet.

Other Rainy Weather Tips

Besides slowing down, other wet weather driving tips include:

- Allow extra following distance.
- Pass with caution.
- Keep windshield wiping equipment in good shape.
- Keep the windshield washer fluid reservoir filled.

- Have good tires with proper tread depth. See *Tires* on page 10-61.
- Turn off cruise control.

Highway Hypnosis

Always be alert and pay attention to your surroundings while driving. If you become tired or sleepy, find a safe place to park the vehicle and rest.

Other driving tips include:

- Keep the vehicle well ventilated.
- Keep the interior temperature cool.
- Keep your eyes moving — scan the road ahead and to the sides.
- Check the rearview mirror and vehicle instruments often.

Hill and Mountain Roads

Driving on steep hills or through mountains is different than driving on flat or rolling terrain. Tips for driving in these conditions include:

- Keep the vehicle serviced and in good shape.
- Check all fluid levels and brakes, tires, cooling system, and transmission.
- Shift to a lower gear when going down steep or long hills.

Warning

Using the brakes to slow the vehicle on a long downhill slope can cause brake overheating, can reduce brake performance, and could result in a loss of braking. Shift the transmission to a lower gear to let the engine assist the brakes on a steep downhill slope.

Warning

Coasting downhill in N (Neutral) or with the ignition off is dangerous. This can cause overheating of the brakes and loss of steering. Always have the engine running and the vehicle in gear.

- Stay in your own lane. Do not swing wide or cut across the center of the road. Drive at speeds that let you stay in your own lane.
- Be alert on top of hills; something could be in your lane (stalled car, accident).
- Pay attention to special road signs (falling rocks area, winding roads, long grades, passing or no-passing zones) and take appropriate action.

Winter Driving

Driving on Snow or Ice

Drive carefully when there is snow or ice between the tires and the road, creating less traction or grip. Wet ice can occur at about 0°C (32°F) when freezing rain begins to fall, resulting in even less traction. Avoid driving on wet ice or in freezing rain until roads can be treated with salt or sand.

Drive with caution, whatever the condition. Accelerate gently so traction is not lost. Accelerating too quickly causes the wheels to spin and makes the surface under the tires slick, so there is even less traction.

Try not to break the fragile traction. If you accelerate too fast, the drive wheels will spin and polish the surface under the tires even more.

The Antilock Brake System (ABS) improves vehicle stability during hard stops on slippery roads, but apply the brakes sooner than when on dry pavement.

Allow greater following distance on any slippery road and watch for slippery spots. Icy patches can occur on otherwise clear roads in shaded areas. The surface of a curve or an overpass can remain icy when the surrounding roads are clear. Avoid sudden steering maneuvers and braking while on ice.

See *Antilock Brake System (ABS)* on page 9-33.

Turn off cruise control on slippery surfaces.

Blizzard Conditions

Being stuck in snow can be a serious situation. Stay with the vehicle unless there is help nearby. If possible, use Roadside Service.

See *Roadside Service* on page 13-5. To get help and keep everyone in the vehicle safe:

- Turn on the hazard warning flashers.
- Tie a red cloth to an outside mirror.

Warning

Snow can trap engine exhaust under the vehicle. This may cause exhaust gases to get inside. Engine exhaust contains carbon monoxide (CO) which cannot be seen or smelled. It can cause unconsciousness and even death.

If the vehicle is stuck in the snow:

- Clear away snow from around the base of your vehicle, especially any that is blocking the exhaust pipe.

(Continued)

Warning (Continued)

- Check again from time to time to be sure snow does not collect there.
- Open a window about 5 cm (2 in) on the side of the vehicle that is away from the wind to bring in fresh air.
- Fully open the air outlets on or under the instrument panel.
- Adjust the climate control system to a setting that circulates the air inside the vehicle and set the fan speed to the highest setting. See “Climate Control Systems” in the Index.

For more information about carbon monoxide, see *Engine Exhaust* on page 9-25.

9-10 Driving and Operating

To save fuel, run the engine for only short periods as needed to warm the vehicle and then shut the engine off and close the window most of the way to save heat. Repeat this until help arrives but only when you feel really uncomfortable from the cold. Moving about to keep warm also helps.

If it takes some time for help to arrive, now and then when you run the engine, push the accelerator pedal slightly so the engine runs faster than the idle speed. This keeps the battery charged to restart the vehicle and to signal for help with the headlamps. Do this as little as possible to save fuel.

If the Vehicle Is Stuck

Slowly and cautiously spin the wheels to free the vehicle when stuck in sand, mud, ice, or snow.

If stuck too severely for the traction system to free the vehicle, turn the traction system off and use the rocking method. See *Traction Control/Electronic Stability Control* on page 9-38.

Warning

If the vehicle's tires spin at high speed, they can explode, and you or others could be injured. The vehicle can overheat, causing an engine compartment fire or other damage. Spin the wheels as little as possible and avoid going above 56 km/h (35 mph).

Rocking the Vehicle to Get it Out

Turn the steering wheel left and right to clear the area around the front wheels. Turn off any traction system. Shift back and forth between R (Reverse) and a low forward gear, spinning the wheels as little as possible. To prevent transmission wear, wait until the wheels stop spinning before shifting gears. Release the accelerator pedal while shifting, and press lightly on the accelerator pedal when the transmission is in gear. Slowly spinning the wheels in the forward and reverse directions causes a rocking motion that could free the vehicle. If that does not get the vehicle out after a few tries, it might need to be towed out. If the vehicle does need to be towed out, see *Towing the Vehicle* on page 10-109.

Vehicle Load Limits

It is very important to know how much weight the vehicle can carry. This weight is called the vehicle capacity weight and includes the weight of all occupants, cargo and all nonfactory-installed options. Two labels on the vehicle show how much weight it may properly carry, the Tire and Loading Information label and the Certification label.

Warning

Do not load the vehicle any heavier than the Gross Vehicle Weight Rating (GVWR), or either the maximum front or rear Gross Axle Weight Rating (GAWR). This can cause systems to break and change the way the

(Continued)

Warning (Continued)

vehicle handles. This could cause loss of control and a crash. Overloading can also shorten the life of the vehicle.

Tire and Loading Information Label

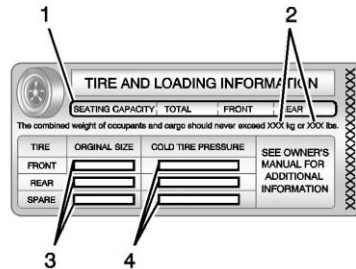

Label Example

A vehicle-specific Tire and Loading Information label is attached to the vehicle's center

pillar (B-pillar). With the driver door open, you will find the label attached near the door lock post. The Tire and Loading Information label shows the number of occupant seating positions (1), and the maximum vehicle capacity weight (2) in kilograms and pounds.

The Tire and Loading Information label also shows the tire size of the original equipment tires (3) and the recommended cold tire inflation pressures (4). For more information on tires and inflation see *Tires on page 10-61* and *Tire Pressure on page 10-70*.

There is also important loading information on the Certification label. It tells you the Gross Vehicle Weight Rating (GVWR) and the Gross Axle Weight

9-12 Driving and Operating

Rating (GAWR) for the front and rear axle. See "Certification Label" later in this section.

"Steps for Determining Correct Load Limit—

1. Locate the statement "The combined weight of occupants and cargo should never exceed XXX kg or XXX lbs." on your vehicle's placard.
2. Determine the combined weight of the driver and passengers that will be riding in your vehicle.
3. Subtract the combined weight of the driver and passengers from XXX kg or XXX lbs.
4. The resulting figure equals the available amount of cargo and luggage load capacity.

For example, if the "XXX" amount equals 1400 lbs. and there will be five 150 lb passengers in your vehicle, the amount of available cargo and luggage load capacity is 650 lbs. (1400-750 (5 x 150) = 650 lbs.)

5. Determine the combined weight of luggage and cargo being loaded on the vehicle. That weight may not safely exceed the available cargo and luggage load capacity calculated in Step 4.
6. If your vehicle will be towing a trailer, load from your trailer will be transferred to your vehicle. Consult this manual to determine how this reduces the available cargo and luggage load capacity of your vehicle."

See *Trailer Towing (CTS-V and Coupe)* on page 9-56 or *Trailer Towing (Except CTS-V and Coupe)* on page 9-56 for important information on towing a trailer, towing safety rules and trailering tips.

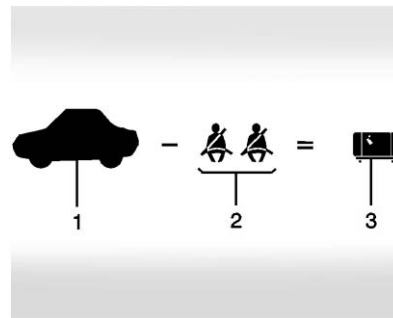

Example 1

1. Vehicle Capacity Weight for Example 1 = 453 kg (1,000 lbs).
2. Subtract Occupant Weight @ 68 kg (150 lbs) × 2 = 136 kg (300 lbs).

3. Available Occupant and Cargo Weight = 317 kg (700 lbs).

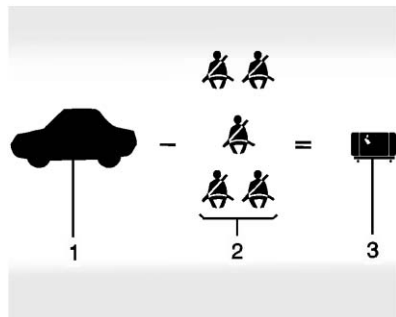

Example 2

1. Vehicle Capacity Weight for Example 2 = 453 kg (1,000 lbs).
2. Subtract Occupant Weight @ 68 kg (150 lbs) × 5 = 340 kg (750 lbs).
3. Available Cargo Weight = 113 kg (250 lbs).

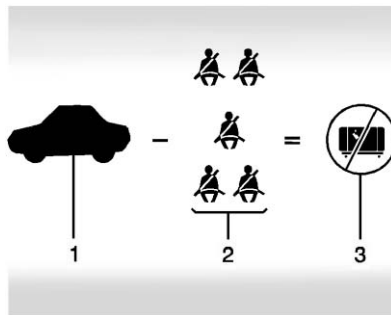

Example 3

1. Vehicle Capacity Weight for Example 3 = 453 kg (1,000 lbs).
2. Subtract Occupant Weight @ 91 kg (200 lbs) × 5 = 453 kg (1,000 lbs).
3. Available Cargo Weight = 0 kg (0 lbs).

Refer to the vehicle's Tire and Loading Information label for specific information about the vehicle's capacity weight and

seating positions. The combined weight of the driver, passengers, and cargo should never exceed the vehicle's capacity weight.

Certification Label

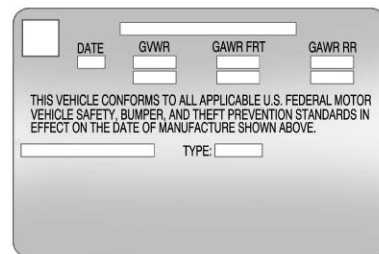

Label Example

A vehicle-specific Certification label is attached to either the driver door edge or the lower center pillar on the driver side of the vehicle. The label tells the gross weight capacity of the vehicle, called the Gross Vehicle Weight Rating (GVWR).

9-14 Driving and Operating

The GVWR includes the weight of the vehicle, all occupants, fuel, and cargo. Never exceed the GVWR for the vehicle, or the Gross Axle Weight Rating (GAWR) for either the front or rear axle.

If the vehicle is carrying a heavy load, it should be spread out. See “Steps for Determining Correct Load Limit” earlier in this section.

Warning

Do not load the vehicle any heavier than the Gross Vehicle Weight Rating (GVWR), or either the maximum front or rear Gross Axle Weight Rating (GAWR). This can cause systems to break and change the way the vehicle handles. This could

(Continued)

Warning (Continued)

cause loss of control and a crash. Overloading can also shorten the life of the vehicle.

Warning

Things inside the vehicle can strike and injure people in a sudden stop or turn, or in a crash.

- Put things in the cargo area of the vehicle. In the cargo area, put them as far forward as possible. Try to spread the weight evenly.

(Continued)

Warning (Continued)

- Never stack heavier things, like suitcases, inside the vehicle so that some of them are above the tops of the seats.
- Do not leave an unsecured child restraint in the vehicle.
- Secure loose items in the vehicle.
- Do not leave a seat folded down unless needed.

Starting and Operating

New Vehicle Break-In

Follow these recommended guidelines during the first 2 414 km (1,500 miles) of driving this vehicle. Parts have a break-in period and performance will be better in the long run.

For the first 2 414 km (1,500 miles):

- Avoid full throttle starts and abrupt stops.
- Do not exceed 4,000 engine rpm.
- Avoid driving at any one constant speed, fast or slow.
- Avoid downshifting to brake or slow the vehicle when the engine speed will exceed 4000 rpm.
- Do not let the engine labor. Never lug the engine in high gear at low speeds. With a

manual transmission, shift to the next lower gear. This rule applies at all times, not just during the break-in period.

- Do not participate in track events, sport driving schools, or similar activities during this break-in period.
- Check engine oil with every refueling and add if necessary. Oil and fuel consumption may be higher than normal during the first 2 414 km (1,500 miles).
- To break in new tires, drive at moderate speeds and avoid hard cornering for the first 322 km (200 miles). New tires do not have maximum traction and may tend to slip.
- New brake linings also need a break-in period. Avoid making hard stops during the first 322 km (200 miles). This is recommended every time brake linings are replaced.

Ignition Positions (Keyless Access)

The ignition control knob can be turned to four different positions.

To shift out of P (Park), the ignition must be in ON/RUN or ACC/ACCESSORY and the regular brake pedal must be applied.

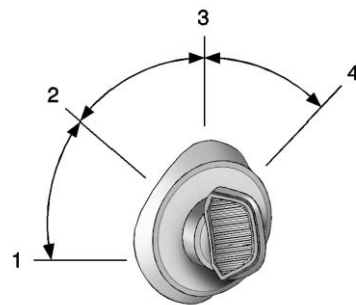

Using a tool to force the ignition control knob from its cylinder could damage it.

9-16 Driving and Operating

Make sure the Remote Keyless Entry (RKE) transmitter is inside the vehicle when trying to turn the ignition control knob.

1 (STOPPING THE ENGINE/LOCK/OFF): When the vehicle is stopped, turn the ignition switch to LOCK/OFF to turn the engine off. Retained Accessory Power (RAP) will remain active. See *Retained Accessory Power (RAP)* on page 9-22.

The ignition control knob cannot be removed from the vehicle. The RKE transmitter must be inside the vehicle to start the engine. This position locks the ignition and shift lever on automatic transmission vehicles, and the ignition and steering wheel on manual transmission vehicles.

Do not turn the engine off when the vehicle is moving. This will cause a loss of power assist in the brake and steering systems and disable the airbags.

If the vehicle must be shut off in an emergency:

1. Brake using a firm and steady pressure. Do not pump the brakes repeatedly. This may deplete power assist, requiring increased brake pedal force.
2. Shift the vehicle to neutral. This can be done while the vehicle is moving. After shifting to neutral, firmly apply the brakes and steer the vehicle to a safe location.
3. Come to a complete stop. Shift to P (Park) with an automatic transmission, or Neutral with a manual transmission. Turn the ignition to LOCK/OFF.
4. Set the parking brake. See *Parking Brake (Manual)* on page 9-34 or *Parking Brake (Electric)* on page 9-35.

Warning

Turning off the vehicle while moving may cause loss of power assist in the brake and steering systems and disable the airbags. While driving, only shut the vehicle off in an emergency.

If the vehicle cannot be pulled over, and must be shut off while driving, switch the ignition to ACC/ACCESSORY.

2 (ACC/ACCESSORY): This position allows you to use things like the radio and the windshield wipers when the engine is off. This position will allow you to turn off the engine.

3 (ON/RUN): This position is for driving. It is the position the ignition switch returns to after the engine starts, and the control knob is released. This position can also be used for service and diagnostics, and to verify the proper operation of

the malfunction indicator lamp as may be required for emission inspection purposes.

If you need to shift the transmission out of P (Park), the ignition control knob has to be in ACC/ACCESSORY or ON/RUN.

The battery could be drained if you leave the ignition in the ACC/ACCESSORY or ON/RUN position with the engine off. You may not be able to start the vehicle if the battery is allowed to drain for an extended period of time.

4 (START): This position starts the engine.

Ignition Positions (Key Access)

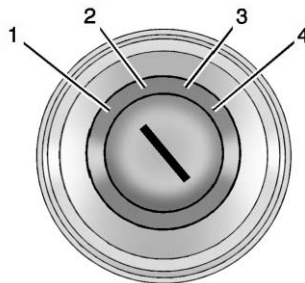

The ignition switch can be turned to four different positions.

To shift out of P (Park), the ignition switch must be in ON/RUN or ACC/ACCESSORY and the brake pedal must be applied.

Caution

Using a tool to force the key from its cylinder could cause damage or break the key. Use the correct key and turn the key only with your hand. Make sure the key is all the way in. If it is and you have a manual transmission vehicle, turn the steering wheel left and right while you turn the key hard. If none of this works, then the vehicle needs service.

1 (STOPPING THE ENGINE/LOCK/OFF): When the vehicle is stopped, turn the ignition switch to LOCK/OFF to turn the engine off. Retained Accessory Power (RAP) will remain active. See *Retained Accessory Power (RAP)* on page 9-22 for more information.

9-18 Driving and Operating

This is the only position in which the key can be removed. This position locks the ignition and shift lever on automatic transmission vehicles, and the ignition and steering wheel on manual transmission vehicles.

Do not turn the engine off when the vehicle is moving. This will cause a loss of power assist in the brake and steering systems and disable the airbags.

The ignition switch can bind in the LOCK/OFF position with the wheels turned off center. If this happens, move the steering wheel from right to left while turning the key to ACC/ACCESSORY. If this does not work, then the vehicle needs service.

If the vehicle must be shut off in an emergency:

1. Brake using a firm and steady pressure. Do not pump the brakes repeatedly. This may deplete power assist, requiring increased brake pedal force.

2. Shift the vehicle to neutral. This can be done while the vehicle is moving. After shifting to neutral, firmly apply the brakes and steer the vehicle to a safe location.
3. Come to a complete stop. Shift to P (Park) with an automatic transmission, or Neutral with a manual transmission. Turn the ignition to LOCK/OFF.
4. Set the parking brake. See *Parking Brake (Manual)* on page 9-34 or *Parking Brake (Electric)* on page 9-35.

Warning

Turning off the vehicle while moving may cause loss of power assist in the brake and steering systems and disable the airbags. While driving, only shut the vehicle off in an emergency.

If the vehicle cannot be pulled over, and must be shut off while driving, turn the ignition to ACC/ACCESSORY.

2 (ACC/ACCESSORY): This position lets you use things like the radio and the windshield wipers when the engine is off. This position allows you to turn off the engine.

3 (ON/RUN): This position is for driving. It is the position the ignition switch returns to after the engine starts, and the key is released. This position can also be used for service and diagnostics, and to verify the proper operation of the malfunction indicator lamp as may be required for emission inspection purposes.

To shift the transmission out of P (Park), the ignition key has to be in ACC/ACCESSORY or ON/RUN.

The battery could be drained if the key is left in the ACC/ACCESSORY or ON/RUN position with the engine off. The vehicle might not start if the battery is allowed to drain for an extended period of time.

4 (START): This position starts the engine. When the engine starts, release the key. The ignition switch returns to ON/RUN for driving.

A warning tone will sound when the driver door is opened, the ignition is in ACC/ACCESSORY or LOCK/OFF, and the key is in the ignition.

Key Lock Release

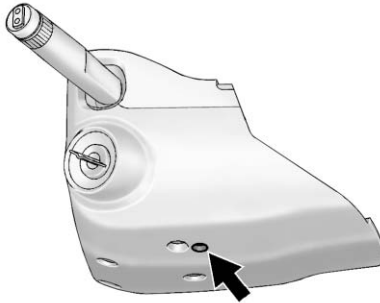

Vehicles with an automatic transmission are equipped with an electronic key lock release system. The key lock release is designed to prevent ignition key removal unless the shift lever is in P (Park).

The key lock release is always functional except in the case of an uncharged or low voltage (less than 9-volt) battery. If the vehicle has an uncharged battery or a battery with low voltage, try charging or jump starting the battery. See *Jump Starting* on page 10-105.

If charging or jump starting the battery does not work, locate the hole below the ignition lock. Insert a flat bladed tool or another key from the key chain into the opening. When the lever can be felt, actuate the lever away from the driver, and remove the key from the ignition.

Starting the Engine

Place the transmission in the proper gear.

If equipped with the keyless access system, the Remote Keyless Entry (RKE) transmitter must be authenticated in order for the ignition control knob to turn. The transmitter can be authenticated either by putting your foot on the brake pedal or by pushing the ignition control knob in.

Automatic Transmission

Move the shift lever to P (Park) or N (Neutral). The engine will not start in any other position. To restart the engine when the vehicle is already moving, use N (Neutral) only.

If the vehicle has the Keyless Access system, your foot must be on the brake pedal to start the engine. To rotate the ignition control knob, put your foot on the brake pedal and turn the ignition control

knob to the START position. If the ignition control knob does not turn, try pushing the knob in and turning again. When the engine begins cranking, let go of the ignition control knob, it will return to the ON/RUN position.

If the transmitter is not in the vehicle or something is interfering with the transmitter, the Driver Information Center (DIC) will display ELECTRONIC KEY NOT DETECTED. See *Driver Information Center (DIC)* on page 5-27.

If the battery in the RKE transmitter needs replacing, the DIC displays REPLACE BATTERY IN REMOTE KEY. The vehicle can still be driven. See "Battery Replacement" under *Remote Keyless Entry (RKE) System Operation (Keyless Access)* on page 2-4 or *Remote Keyless Entry (RKE) System Operation (Key Access)* on page 2-9.

Caution

Do not try to shift to P (Park) if the vehicle is moving. If you do, you could damage the transmission. Shift to P (Park) only when the vehicle is stopped.

Caution

If the steering wheel is turned until it reaches the end of its travel, and is held in that position while starting the vehicle, damage may occur to the hydraulic power steering system and there may be loss of power steering assist.

Manual Transmission

The shift lever should be in neutral position and the parking brake engaged. Hold the clutch pedal down to the floor and start the

engine. The vehicle will not start if the clutch pedal is not all the way down.

Starting Procedure

1. With your foot off the accelerator pedal, turn the ignition key to START. If the vehicle has the Keyless Access system, push the ignition control knob in and rotate the knob to the START position. When the engine starts, let go of the ignition. The idle speed will go down as your engine gets warm. Do not race the engine immediately after starting it. Operate the engine and transmission gently to allow the oil to warm up and lubricate all moving parts.

The vehicle has a Computer-Controlled Cranking System. This feature assists in starting the engine and protects components. If the ignition key is turned to the START position, and then released when the engine begins cranking, the engine will continue cranking for a few seconds or until the vehicle starts. If the engine does not start and the key is held in START for many seconds, cranking will be stopped after 15 seconds to prevent cranking motor damage. To prevent gear damage, this system also prevents cranking if the engine is already running. Engine cranking can be stopped by turning the ignition switch to ACC/ACCESSORY or LOCK/OFF.

When first starting the vehicle, the engine idle speed will be elevated to allow the catalytic converter, an emissions control device, to quickly reach operating temperature. After approximately 20 seconds, the engine will begin to transition to its normal, quieter idle speed, which can vary depending on the temperature. This is normal operation.

Caution

Cranking the engine for long periods of time, by returning the ignition to the START position immediately after cranking has ended, can overheat and damage the cranking motor, and drain the battery. Wait at least 15 seconds between each try, to let the cranking motor cool down.

- If the engine does not start after five to 10 seconds, especially in very cold weather (below 0°F or -18°C), it could be flooded with too much gasoline. Try pushing the accelerator pedal all the way to the floor and holding it there as you hold the key in START for up to a maximum of 15 seconds. Wait at least 15 seconds between each try, to allow the cranking motor to cool down. When the engine starts, let go of the key and accelerator. If the vehicle starts briefly but then stops again, do the same thing. This clears the extra gasoline from the engine. Do not race the engine immediately after starting it. Operate the engine and transmission gently until the oil warms up and lubricates all moving parts.

Caution

If you add electrical parts or accessories, you could change the way the engine operates. Any resulting damage would not be covered by the vehicle warranty. See *Add-On Electrical Equipment on page 9-59*.

Retained Accessory Power (RAP)

These vehicle accessories can be used for up to 10 minutes after the engine is turned off:

- Audio System
- Power Windows
- Sunroof (if equipped)

Power to the audio system will work up to 10 minutes or until the driver door is opened. Power to the windows or sunroof will work up to 10 minutes or until any door is opened. For an additional

10 minutes of operation, close all the doors and turn the key to ON/RUN and then back to LOCK/OFF.

Engine Coolant Heater

If equipped, the engine coolant heater can be used in cold weather conditions at or below -18°C (0°F) for easier starting and better fuel economy during engine warm-up. Plug in the coolant heater at least four hours before starting the vehicle. An internal thermostat in the plug end of the cord may exist which will prevent engine coolant heater operation at temperatures above -18°C (0°F).

To Use the Engine Coolant Heater

1. Turn off the engine.
2. Open the hood and unwrap the electrical cord. The cord is near the driver side strut tower.

Remove the plastic cap to access the plug.

3. Plug it into a normal, grounded 110-volt AC outlet.

 **Warning**

Plugging the cord into an ungrounded outlet could cause an electrical shock. Also, the wrong kind of extension cord could overheat and cause a fire. You could be seriously injured. Plug the cord into a properly grounded three-prong 110-volt AC outlet. If the cord will not reach, use a heavy-duty three-prong extension cord rated for at least 15 amps.

4. Before starting the engine, be sure to unplug and store the cord as it was before to keep it away from moving engine parts. If you do not, it could be damaged.

Contact your dealer for information on how long to use the heater in your particular area.

Shifting Into Park

Use this procedure to shift into P (Park):

1. Hold the brake pedal down and set the parking brake.

See Parking Brake (Manual) on page 9-34 or Parking Brake (Electric) on page 9-35 for more information.
2. Move the shift lever into P (Park) by holding in the button on the shift lever and pushing the lever all the way toward the front of the vehicle.
3. Turn the ignition to LOCK/OFF.
4. For vehicles with key access, remove the key and take it with you. If you can leave the vehicle with the ignition key in your hand, the vehicle is in P (Park). For vehicles with the Keyless Access system, take the RKE transmitter with you.

Leaving the Vehicle With the Engine Running (Automatic Transmission)

 **Warning**

It can be dangerous to leave the vehicle with the engine running. It could overheat and catch fire.

It is dangerous to get out of the vehicle if the shift lever is not fully in P (Park) with the parking brake firmly set. The vehicle can roll.

Do not leave the vehicle when the engine is running. If you have left the engine running, the vehicle can move suddenly. You or others could be injured. To be sure the vehicle will not move, even when you are on fairly level ground, always set the parking brake and move the shift lever to P (Park). See *Shifting Into Park* on page 9-23. If you are towing a trailer, see *Driving Characteristics and Towing Tips* on page 9-53.

If you have to leave the vehicle with the engine running, the vehicle must be in P (Park) and the parking brake set. After shifting into P (Park), try to move the shift lever out without first pushing the button on the shift lever.

If you can, the shift lever was not fully locked into P (Park).

Torque Lock (Automatic Transmission)

Torque lock is when the weight of the vehicle puts too much force on the parking pawl in the transmission. This happens when parking on a hill and shifting the transmission into P (Park) is not done properly and then it is difficult to shift out of P (Park). To prevent torque lock, set the parking brake and then shift into P (Park). To find out how, see "Shifting Into Park" listed previously.

If torque lock does occur, the vehicle may need to be pushed uphill by another vehicle to relieve the parking pawl pressure, so you can shift out of P (Park).

Shifting out of Park

This vehicle is equipped with an electronic shift lock release system. The shift lock release is designed to:

- Prevent ignition key removal unless the shift lever is in P (Park) with the shift lever button fully released, for vehicles with key access.
- Prevent movement of the shift lever out of P (Park), unless the ignition is in ON/RUN or ACC/ACCESSORY and the brake pedal is applied.

The shift lock release is always functional except in the case of an uncharged or low voltage (less than 9 volt) battery.

If the vehicle has an uncharged battery or a battery with low voltage, try charging or jump starting the battery. See *Jump Starting on page 10-105* for more information.

To shift out of P (Park):

1. Apply the brake pedal.
2. Release the parking brake. See *Parking Brake (Manual) on page 9-34* or *Parking Brake (Electric) on page 9-35*.
3. Press the shift lever button.
4. Move the shift lever.

If unable to shift out of P (Park):

1. Fully release the shift lever button.
2. While holding down the brake pedal, press the shift lever button again.
3. Move the shift lever.

If the shift lever will not move from P (Park), consult your dealer or a professional towing service.

Parking (Manual Transmission)

Before getting out of the vehicle, place the shift lever in R (Reverse) and firmly apply the parking brake.

For vehicles with the key access ignition, turn the ignition key to OFF/LOCK, and remove the key. See *Ignition Positions (Keyless Access)* on page 9-15 or *Ignition Positions (Key Access)* on page 9-17.

For vehicles with the Keyless Access ignition, turn the ignition to LOCK/OFF and remove the Remote Keyless Entry (RKE) transmitter.

If towing a trailer, see *Driving Characteristics and Towing Tips* on page 9-53.

Parking over Things That Burn

Warning

Things that can burn could touch hot exhaust parts under the vehicle and ignite. Do not park over papers, leaves, dry grass, or other things that can burn.

Engine Exhaust

Warning

Engine exhaust contains carbon monoxide (CO) which cannot be seen or smelled. Exposure to CO can cause unconsciousness and even death.

Exhaust may enter the vehicle if:

- The vehicle idles in areas with poor ventilation (parking garages, tunnels, deep snow that may block underbody airflow or tail pipes).
- The exhaust smells or sounds strange or different.
- The exhaust system leaks due to corrosion or damage.
- The vehicle exhaust system has been modified, damaged, or improperly repaired.

(Continued)

Warning (Continued)

- There are holes or openings in the vehicle body from damage or aftermarket modifications that are not completely sealed.

If unusual fumes are detected or if it is suspected that exhaust is coming into the vehicle:

- Drive it only with the windows completely down.
- Have the vehicle repaired immediately.

Never park the vehicle with the engine running in an enclosed area such as a garage or a building that has no fresh air ventilation.

Running the Vehicle While Parked

It is better not to park with the engine running.

If the vehicle is left with the engine running, follow the proper steps to be sure the vehicle will not move. See *Shifting Into Park* on page 9-23 and *Engine Exhaust* on page 9-25. If the vehicle has a manual transmission, see *Parking (Manual Transmission)* on page 9-25.

If parking on a hill and pulling a trailer, see *Driving Characteristics and Towing Tips* on page 9-53.

Automatic Transmission



There are several different positions for the shift lever.

P (Park): This position locks the rear wheels. Use this position when starting the engine because the vehicle cannot move easily.

 **Warning**

It is dangerous to get out of the vehicle if the shift lever is not fully in P (Park) with the parking brake firmly set. The vehicle can roll.

Do not leave the vehicle when the engine is running unless you have to. If you have left the engine running, the vehicle can move suddenly. You or others could be injured. To be sure the vehicle will not move, even when you are on fairly level ground, always set the parking brake and move the shift lever to P (Park). See *Shifting Into Park on page 9-23*. If you are pulling a trailer, see *Driving Characteristics and Towing Tips on page 9-53*.

Make sure the shift lever is fully in P (Park) before starting the engine. The vehicle has an electronic shift lock release system. Fully apply the regular brakes first and then press the shift lever button before shifting from P (Park) when the ignition is in ON/RUN. If you cannot shift out of P (Park), ease pressure on the shift lever and push the shift lever all the way into P (Park) as you maintain brake application. Then press the shift lever button and move the shift lever into another gear. See *Shifting out of Park on page 9-24*.

 **Caution**

Shifting to R (Reverse) while the vehicle is moving forward could damage the transmission. The repairs would not be covered by the vehicle warranty. Shift to R (Reverse) only after the vehicle is stopped.

R (Reverse): Use this gear to back up.

At low vehicle speeds, R (Reverse) can be used to rock the vehicle back and forth to get out of snow, ice, or sand without damaging your transmission. See *If the Vehicle Is Stuck on page 9-10*.

N (Neutral): In this position, the engine does not connect with the wheels. To restart when the vehicle is already moving, use N (Neutral) only. You can also use N (Neutral) when the vehicle is being towed.

 **Warning**

Shifting into a drive gear while the engine is running at high speed is dangerous. Unless your foot is firmly on the brake pedal, the vehicle could move very rapidly. You could lose control and hit people or objects. Do not shift into a drive gear while the engine is running at high speed.

Caution

Shifting out of P (Park) or N (Neutral) with the engine running at high speed may damage the transmission. The repairs would not be covered by the vehicle warranty. Be sure the engine is not running at high speed when shifting the vehicle.

D (Drive): This position is for normal driving. It provides the best fuel economy. If you need more power for passing, and you are:

- Going less than 55 km/h (35 mph), push the accelerator pedal about halfway down.
- Going about 55 km/h (35 mph) or more, push the accelerator all the way down.

The transmission will shift down to a lower gear and have more power.

Downshifting the transmission in slippery road conditions could result in skidding; see “Skidding” under *Loss of Control* on page 9-5

When the CTS-V is in D (Drive), the first forward gear automatic shift after start will be from 1 (First) gear. Following starts will begin in 2 (Second) gear. When in M (Manual Mode), the vehicle will start in 1 (First) gear every time.

M (Manual Mode): This position allows the driver to select the range of gears appropriate for current driving conditions. See “Driver Shift Control (DSC) or Tap Shift” later in this section.

Caution

Spinning the tires or holding the vehicle in one place on a hill using only the accelerator pedal may damage the transmission. The repair will not be covered by the vehicle warranty. If you are

(Continued)

Caution (Continued)

stuck, do not spin the tires. When stopping on a hill, use the brakes to hold the vehicle in place.

Manual Mode

Driver Shift Control (DSC) or Tap Shift

Caution

Driving with the engine at a high rpm without upshifting while using Driver Shift Control (DSC), could damage the vehicle. Always upshift when necessary while using DSC.

Vehicles with DSC may either use the shift lever or the tap shift controls on back of the steering wheel to manually shift the automatic transmission.

To use the DSC feature using the shift lever:

1. Move the shift lever to the right from D (Drive) to M (Manual Mode).

The vehicle will be in sport mode and will shift automatically if the shift lever is not moved forward or rearward. The transmission may remain in a gear longer than it would in the normal driving mode based on braking, throttle input, and vehicle lateral acceleration. SPORT MODE will be displayed in the DIC momentarily.

2. To go from sport mode to DSC, move the shift lever forward to upshift or rearward to downshift.
3. To exit DSC and enter sport mode, hold the shift lever in the upshift/forward position briefly.



If equipped, the tap shift controls are on the back of the steering wheel. The tap shift controls can be used in D (Drive), M (Manual Mode) with Sport Mode automatic shift active, or M (Manual Mode) with Manual Shifting Mode.

To use the DSC feature using the Tap Shift controls:

1. Move the shift lever to the right from D (Drive) to M (Manual Mode).

2. Tap the left control to downshift, and the right control to upshift.
3. To return to sport mode, hold the right upshift control briefly, or hold the shift lever forward briefly, or return the shift lever to D (Drive).

With the shift lever in D (Drive), the tap shift controls will activate a temporary tap manual shift mode, allowing the transmission to be manually shifted. Automatic shifts return after no manual shifts have been done for seven to 10 second. The temporary tap mode can also be deactivated by holding the right upshift control briefly.



The tachometer display indicates which gear the vehicle is in. The number indicates the requested gear range when moving the shift lever forward or rearward.

CTS-V vehicles use tracer lights around the outside of the tachometer as a performance upshift light. These tracers flash to indicate when to shift to the next higher gear to avoid the engine speed limit. See *Tachometer* on page 5-13 for more information.

While using the DSC feature, the vehicle will have firmer, quicker shifting. You can use this for sport driving or when climbing or descending hills, to stay in gear longer, or to downshift for more power or engine braking.

The transmission will only allow you to shift into gears appropriate for the vehicle speed and engine revolutions per minute (RPM). The transmission will not automatically shift to the next lower gear if the engine rpm is too high, nor to the next higher gear when the maximum engine rpm is reached.

If shifting is prevented for any reason, the currently selected gear will flash multiple times, indicating that the transmission has not shifted gears.

While in the DSC mode, the CTS automatic transmission will automatically downshift when the vehicle comes to a stop. This will allow for more power during acceleration.

The CTS-V automatic transmission will not automatically downshift on hard acceleration when in DSC mode.

When accelerating the vehicle from a stop in snowy and icy conditions, it is suggested to shift into second gear. A higher gear allows the vehicle to gain more traction on slippery surfaces.

Manual Transmission

If equipped with a manual transmission, the shift lever is on the center console between the front seats.

CTS-V

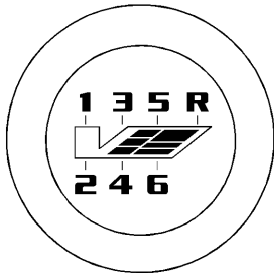

1 (First): Press the clutch pedal and shift into 1 (First). Slowly let up on the clutch pedal while pressing on the accelerator pedal.

Shift into 1 (First) when you are going less than 40 km/h (25 mph). For CTS-V, shift into 1 (First) when you are going less than 64 km/h (40 mph). After a complete stop, if it is hard to shift into 1 (First), let up on the clutch pedal, then press it back down and shift into 1 (First).

2 (Second): Press the clutch pedal and let up on the accelerator pedal, then shift into 2 (Second). Then, slowly let up on the clutch pedal while accelerating.

3 (Third), 4 (Fourth), 5 (Fifth), and 6 (Sixth): Shift into 3 (Third), 4 (Fourth), 5 (Fifth), and 6 (Sixth) the same for 2 (Second).

To stop, let up on the accelerator pedal and press the brake pedal. Just before the vehicle stops, press the clutch pedal and the brake pedal, and shift to Neutral.

Neutral: Use this position when you start or idle your engine. Your shift lever is in Neutral when it is centered in the shift pattern, not in any gear.

R (Reverse): To back up, press down the clutch pedal, completely stop the vehicle, and shift into R (Reverse). Let up on the clutch pedal slowly while pressing the accelerator pedal.

The CTS-V transmission prevents easily shifting into R (Reverse) using normal shifting force while the vehicle is moving at more than 5 km/h (3 mph), or when the ignition is in LOCK/OFF.

Shift Speeds (Manual Transmission)

Warning

If you skip a gear when downshifting, you could lose control of the vehicle. You could injure yourself or others. Do not shift down more than one gear at a time when downshifting.

Caution

When downshifting, if more than one gear is skipped, or the engine is racing when the clutch pedal is released, the engine, clutch, driveshaft or transmission could be damaged.

If the vehicle speed drops below 32 km/h (20 mph), or if the engine is not running smoothly, downshift to the next lower gear. You may have to downshift two or more gears to keep the engine running smoothly or for good performance.

Up-Shift Light



Vehicles with a manual transmission have an up-shift light on the instrument panel. This light shows when to shift to the next higher gear for the best fuel economy.

When this light comes on, you can shift to the next higher gear if weather, road, and traffic conditions allow. For the best fuel economy, accelerate slowly and shift when the light comes on.

While you accelerate, it is normal for the light to go on and off if you quickly change the position of the accelerator. Ignore the light when you downshift.

CTS-V vehicles use tracer lights around the outside of the tachometer as a performance up-shift light. These tracers flash to indicate when to shift to the next higher gear to avoid the engine speed limit. See *Tachometer on page 5-13* for more information.

Skip Shift (CTS-V)

Under light acceleration, the transmission will only allow you to shift from 1 (First) to 4 (Fourth). Shifts from 1 (First) to 2 (Second) or 3 (Third) are not allowed. This helps improve fuel mileage.

Under harder acceleration, Skip Shift is disabled, and all gears are available.

Drive Systems

All-Wheel Drive

Vehicles with this feature always send engine power to all four wheels. It is fully automatic, and adjusts itself as needed for road conditions.

When using a compact spare tire on an AWD vehicle, the system automatically detects the compact spare and disables AWD. To restore AWD operation and prevent excessive wear on the system, replace the compact spare with a full-size tire as soon as possible. See *Compact Spare Tire* on page 10-104.

Brakes

Antilock Brake System (ABS)

This vehicle has ABS, an advanced electronic braking system that helps prevent a braking skid.

When the vehicle begins to drive away, ABS checks itself. A momentary motor or clicking noise might be heard while this test is going on, and it might even be noticed that the brake pedal moves a little. This is normal.



If there is a problem with ABS, this warning light stays on. See *Antilock Brake System (ABS) Warning Light* on page 5-23.

If driving safely on a wet road and it becomes necessary to slam on the brakes and continue braking to avoid a sudden obstacle, a computer senses that the wheels are slowing down. If one of the wheels is about to stop rolling, the computer will separately work the brakes at each wheel.

ABS can change the brake pressure to each wheel, as required, faster than any driver could. This can help you steer around the obstacle while braking hard.

As the brakes are applied, the computer keeps receiving updates on wheel speed and controls braking pressure accordingly.

9-34 Driving and Operating

Remember: ABS does not change the time needed to get a foot up to the brake pedal or always decrease stopping distance. If you get too close to the vehicle in front of you, there will not be enough time to apply the brakes if that vehicle suddenly slows or stops. Always leave enough room up ahead to stop, even with ABS.

Using ABS

Do not pump the brakes. Just hold the brake pedal down firmly and let ABS work. You might hear the ABS pump or motor operating and feel the brake pedal pulsate, but this is normal.

Braking in Emergencies

ABS allows you to steer and brake at the same time. In many emergencies, steering can help more than even the very best braking.

Parking Brake (Manual)

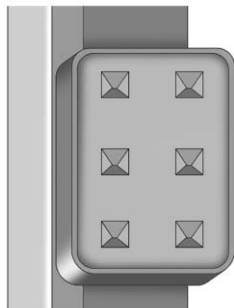

The parking brake pedal is on the lower portion of the instrument panel to the left of the steering wheel.

To set the parking brake, hold the brake pedal down, then push the parking brake pedal down.

If the ignition is on, the brake system warning light on the instrument cluster should come on. If it does not, you need to have the vehicle serviced. See *Brake System Warning Light* on page 5-22 for more information.



To release the parking brake, pull the release lever to the left of the steering wheel on the instrument panel.

Caution

Driving with the parking brake on can overheat the brake system and cause premature wear or damage to brake system parts. Make sure that the parking brake is fully released and the brake warning light is off before driving.

A warning chime will sound if the parking brake is set, the ignition is on, and the vehicle begins to move. To stop the chime, fully release the parking brake.

If you are towing a trailer and parking on a hill, see *Driving Characteristics and Towing Tips* on page 9-53 for more information.

Parking Brake (Electric)

Warning

On vehicles with a manual transmission, releasing the clutch and pressing the accelerator will release the Electric Parking Brake. If the vehicle is not in a gear, the vehicle could move, and you or others could be injured. Make sure the vehicle is in a gear before attempting to drive away. To avoid unexpected vehicle movement, do not partially release the clutch or press the

(Continued)

Warning (Continued)

accelerator pedal until you are ready to release the parking brake and drive away.

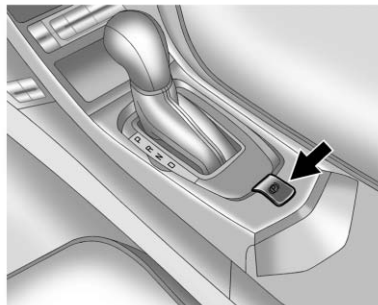

Vehicles with the electric parking brake (EPB) have a switch in the center console.

The EPB takes the place of the manual parking brake system, the foot pedal, and release handle.

The EPB can always be activated, even if the ignition is off. To avoid draining the battery, do not operate the EPB too often without the engine running.

The system has two warning lights and five Driver Information Center (DIC) messages. See *Brake System Warning Light* on page 5-22 and *Driver Information Center (DIC)* on page 5-27 for more information. In case of insufficient electrical power, the EPB cannot be applied or released.

EPB Apply

The EPB can be applied any time the vehicle is stopped. The EPB is applied by momentarily lifting up on the EPB switch. Once fully applied, the BRAKE light will be on, and the DIC message PARK BRAKE SET will be displayed. While the brake is being applied, the status light will flash until full apply is reached.

If the light does not come on, or remains flashing, you need to have the vehicle serviced. Do not drive the vehicle if the BRAKE light is flashing. See your dealer. See *Brake System Warning Light on page 5-22* for more information.

If the EPB is applied while the vehicle is in motion, a chime will sound, and the DIC message RELEASE PARK BRAKE SWITCH will be displayed. The vehicle will decelerate as long as the switch is held in the up position. Releasing the EPB switch during the deceleration will release the parking brake. If the switch is held in the up position until the vehicle comes to a stop, the EPB will remain applied.

If the BRAKE light is on, either the EPB is applied, or there is a failure in the hydraulic brake system.

If this light is flashing continuously, the EPB is only partially applied or released, or there is a problem with the EPB. The DIC message SERVICE PARK BRAKE will be

displayed. If this light is flashing continuously, release the EPB, and attempt to apply it again. If this light continues to flash, do not drive the vehicle. See your dealer.

If the yellow light is on, the EPB has detected an error in another system and is operating with reduced functionality. To apply the EPB when this light is on, lift up on the EPB switch and hold it in the up position. Full application of the parking brake by the EPB system may take a longer period of time than normal when this light is on. Continue to hold the switch until the BRAKE light remains on. If the yellow light is on, see your dealer.

If the EPB fails to apply, the rear wheels should be blocked to prevent vehicle movement.

EPB Release

To release the EPB, turn the ignition switch to the ACC/ACCESSORY or ON/RUN position, apply and hold the brake pedal, and push down momentarily on the EPB switch.

If you attempt to release the EPB without the brake pedal applied, a chime will sound, and the DIC message STEP ON BRAKE TO RELEASE PARK BRAKE will be displayed. The EPB is released when the BRAKE light is off and the DIC message PARK BRAKE RELEASED is displayed.

If the yellow light is on, the EPB has detected an error in another system and is operating with reduced functionality. To release the EPB when this light is on, push down on the EPB switch and hold it in the down position. EPB release may take a longer period of time than normal when this light is on. Continue to hold the switch until the BRAKE light is off. If the yellow light is on, see your dealer.

 **Caution**

Driving with the parking brake on can overheat the brake system and cause premature wear or damage to brake system parts. Make sure that the parking brake is fully released and the red brake warning light is off before driving.

Automatic EPB Release

The EPB will automatically release if the vehicle is running, placed into gear, and an attempt is made to drive away. Avoid rapid acceleration when the EPB is applied, to preserve park brake lining life.

The EPB can also be used to prevent roll back for vehicles with a manual transmission taking off on a hill. In a situation where no roll back is desired, an applied EPB will allow

both feet to be used for the clutch and accelerator pedals in preparation for starting the vehicle moving in the intended direction.

In this situation, perform the normal clutch and/or accelerator actions required to begin moving the vehicle. There is no need to push the switch to release the EPB.

If you are towing a trailer and parking on a hill, see *Driving Characteristics and Towing Tips* on page 9-53 for more information.

Brake Assist

This vehicle has a brake assist feature designed to assist the driver in stopping or decreasing vehicle speed in emergency driving conditions. This feature uses the stability system hydraulic brake control module to supplement the power brake system under

conditions where the driver has quickly and forcefully applied the brake pedal in an attempt to quickly stop or slow down the vehicle. The stability system hydraulic brake control module increases brake pressure at each corner of the vehicle until the ABS activates. Minor brake pedal pulsation or pedal movement during this time is normal and the driver should continue to apply the brake pedal as the driving situation dictates. The brake assist feature will automatically disengage when the brake pedal is released or brake pedal pressure is quickly decreased.

Ride Control Systems

Traction Control/ Electronic Stability Control

The vehicle has a Traction Control System (TCS) and StabiliTrak[®], an electronic stability control system. These systems help limit wheel slip and assist the driver in maintaining control, especially on slippery road conditions.

TCS activates if it senses that any of the drive wheels are spinning or beginning to lose traction. When this happens, the system brakes the spinning wheel(s) and/or reduces engine power to limit wheel spin.

StabiliTrak activates when the computer senses a difference between the intended path and the direction the vehicle is actually traveling. StabiliTrak selectively applies braking pressure at any one of the vehicle's brakes to help steer the vehicle in the intended direction.

If cruise control is being used and traction control or StabiliTrak begins to limit wheel spin, cruise control will disengage. Cruise control may be turned back on when road conditions allow.

Both systems come on automatically when the vehicle is started and begins to move. The systems may be heard or felt while they are operating or while performing diagnostic checks. This is normal and does not mean there is a problem with the vehicle.

It is recommended to leave both systems on for normal driving conditions, but it may be necessary to turn TCS off if the vehicle gets stuck in sand, mud, ice, or snow. See *If the Vehicle Is Stuck on page 9-10* and "Turning the Systems Off and On" later in this section.



The indicator light for both systems is in the instrument cluster. This light will:

- Flash when TCS is limiting wheel spin.
- Flash when StabiliTrak is activated.
- Turn on and stay on when either system is not working.

If either system fails to turn on or to activate, a message displays in the Driver Information Center (DIC), and  comes on and stays on to indicate that the system is inactive and is not assisting the driver in maintaining control. The vehicle is safe to drive, but driving should be adjusted accordingly.

If  comes on and stays on:

1. Stop the vehicle.
2. Turn the engine off and wait 15 seconds.
3. Start the engine.

Drive the vehicle. If  comes on and stays on, the vehicle may need more time to diagnose the problem. If the condition persists, see your dealer.



Turning the Systems Off and On





The TCS/StabiliTrak button is on the instrument panel (CTS) or the steering wheel (CTS-V).



Caution

Do not repeatedly brake or accelerate heavily when TCS is off. The vehicle driveline could be damaged.

To turn off only TCS, press and release the  button. The appropriate DIC message will be displayed. See *Ride Control System Messages on page 5-41*. To turn TCS on again, press and release the  button.

If TCS is limiting wheel spin when the  button is pressed, the system will not turn off until the wheels stop spinning.

To turn off both TCS and StabiliTrak, press and hold the  button until the StabiliTrak OFF light  comes on in the instrument cluster. The appropriate DIC message displays. See *Ride Control System Messages on page 5-41*. To turn TCS and

StabiliTrak on again, press and release the  button. The StabiliTrak OFF light  in the instrument cluster turns off.

Adding accessories can affect the vehicle's performance. See *Accessories and Modifications on page 10-3*.

Competitive Driving Mode

To select this optional handling mode, press the TCS/StabiliTrak button quickly two times and STABILITRAK COMPETITIVE MODE displays in the Driver Information Center (DIC). While in the StabiliTrak Competitive Mode, the StabiliTrak Off light comes on, TCS does not limit wheel spin, and more effort is required to turn the steering wheel. Adjust your driving accordingly.

Press the TCS/StabiliTrak button again, or turn the ignition to ACC/ACCESSORY and restart the vehicle, to turn TCS back on and turn the TCS/StabiliTrak warning light off.

Caution

When traction control is turned off, or Competitive Driving Mode is active, it is possible to lose traction. If you attempt to shift with the drive wheels spinning with a loss of traction, it is possible to cause damage to the transmission. Damage caused by misuse of the vehicle is not covered. Do not attempt to shift when the drive wheels do not have traction.

Magnetic Ride Control

With this feature on the CTS-V, the Magnetic Ride Control system adjusts the ride of the vehicle to Tour or Sport modes. Magnetic Ride Control monitors the suspension system to determine the proper system response.

TOUR: Use for normal city and highway driving. This setting provides a smooth, soft ride.

SPORT: Use where road conditions or personal preference demand more control. This setting provides more “feel,” or response to road conditions.

The setting can be changed at any time. Based on road conditions, steering wheel angle, and the vehicle speed, the system automatically adjusts to provide the best handling while providing a smooth ride. The Tour and Sport modes will feel similar on a smooth road. Select a new setting whenever driving conditions change.

The Driver Information Center (DIC) briefly displays SUSPENSION MODE TOUR or SUSPENSION MODE SPORT on vehicle startup or when a new mode is selected.



Press and release this button in the center of the instrument panel, to change modes.

Limited-Slip Rear Axle

Vehicles with a limited-slip rear axle can give more traction on snow, mud, ice, sand, or gravel. When traction is low, this feature allows the drive wheel with the most traction to move the vehicle. The limited-slip rear axle also gives the driver enhanced control when cornering hard or completing a maneuver, such as a lane change.

Cruise Control

Warning

Cruise control can be dangerous where you cannot drive safely at a steady speed. Do not use the cruise control on winding roads or in heavy traffic.

Cruise control can be dangerous on slippery roads. On such roads, fast changes in tire traction can cause excessive wheel slip, and you could lose control. Do not use cruise control on slippery roads.

With cruise control, a speed of about 40 km/h (25 mph) or more can be maintained without keeping your foot on the accelerator. Cruise control does not work at speeds below about 40 km/h (25 mph).

When the brakes are applied, the cruise control turns off.

If the vehicle has the Stabilitrak[®] system and begins to limit wheel spin while you are using cruise control, the cruise control will automatically disengage. See *Traction Control/Electronic Stability Control* on page 9-38. When road conditions allow you to safely use it again, the cruise control can be turned back on.

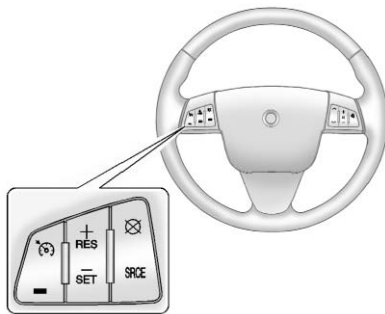

CTS Shown, CTS-V Similar

 **(On/Off):** Press to turn cruise control on or off. The indicator light on the button turns on when cruise control is on.

+RES (Resume/Accelerate):

Press briefly to make the vehicle resume to a previously set speed, or press and hold to accelerate. If cruise control is already active, use to increase vehicle speed.

-SET (Set/Coast): Press briefly to set the speed and activate cruise control. If cruise control is already active, use to decrease vehicle speed.

 **(Cancel):** Press to disengage cruise control without erasing the set speed from memory.

Setting Cruise Control

If the cruise button is on when not in use, it could get bumped and go into cruise when not desired. Keep the cruise control switch off when cruise is not being used.

9-42 Driving and Operating

The cruise control light on the instrument cluster comes on after the cruise control has been set to the desired speed.

1. Press the  button.
2. Get up to the desired speed.
3. Press the -SET button and release it.
4. Remove foot from the accelerator.

Resuming a Set Speed

If the cruise control is set at a desired speed and then the brakes are applied, the cruise control is disengaged without erasing the set speed from memory.

Once the vehicle is driving at about 40 km/h (25 mph) or more, press the +RES button on the steering wheel. The vehicle returns to the previous set speed.

Increasing Speed While Using Cruise Control

If the cruise control system is already activated:

- Press and hold the +RES button on the steering wheel until the desired speed is reached, then release it.
- To increase vehicle speed in small increments, briefly press the +RES button. Each time this is done, the vehicle goes about 1.6 km/h (1 mph) faster.

Reducing Speed While Using Cruise Control

If the cruise control system is already activated:

- Press and hold the -SET button on the steering wheel until the desired speed is reached, then release it.
- To decrease the vehicle speed in small increments, briefly press the -SET button on the steering

wheel. For each press, the vehicle goes about 1.6 km/h (1 mph) slower.

Passing Another Vehicle While Using Cruise Control

Use the accelerator pedal to increase vehicle speed. When you take your foot off the pedal, the vehicle will slow down to the previous cruise set speed. While pressing the accelerator pedal or shortly following the release to override cruise control, briefly pressing the -SET button will result in cruise control set to the current vehicle speed.



Using Cruise Control on Hills

How well the cruise control works on hills depends upon the vehicle speed, load, and the steepness of the hills. When going up steep hills, you might have to step on the accelerator pedal to maintain the vehicle speed. When going downhill, the vehicle may automatically shift to a lower gear to keep the vehicle's speed down.

The vehicle may then shift to a higher gear when braking assistance is no longer required. When the brakes are applied manually the cruise control is disengaged.

Ending Cruise Control

There are four ways to end cruise control:

- Step lightly on the brake pedal (manual and automatic transmissions).
- Press the clutch pedal to the floor (manual transmissions).
- Press  on the steering wheel.
- To turn off the cruise control, press  on the steering wheel.

Erasing Speed Memory

The cruise control set speed is erased from memory by pressing  or if the ignition is turned off.

Driver Assistance Systems

Ultrasonic Parking Assist

If available, the Ultrasonic Rear Parking Assist (URPA) system assists the driver with parking and avoiding objects while in R (Reverse). URPA operates at speeds less than 8 km/h (5 mph). The sensors on the rear bumper detect objects up to 2.5 m (8 ft) behind the vehicle, and at least 25 cm (10 in) off the ground.

Warning

The URPA system does not detect children, pedestrians, bicyclists, animals, or objects below the bumper or that are too close or too far from the vehicle. It is not available at speeds greater than 8 km/h (5 mph). To prevent injury, death, or vehicle

(Continued)

Warning (Continued)

damage, even with URPA, always check the area around the vehicle and check all mirrors before backing.

How the System Works

URPA comes on automatically when the shift lever is moved into R (Reverse). A single tone sounds to indicate the system is working.

URPA operates only at speeds less than 8 km/h (5 mph).

An obstacle is indicated by audible beeps. The interval between the beeps becomes shorter as the vehicle gets closer to the obstacle. When the distance is less than 30 cm (12 in), the beeping is a continuous tone for five seconds.

9-44 Driving and Operating

To be detected, objects must be at least 25 cm (10 in) off the ground and below trunk or liftgate level. Objects must also be within 2.5 m (8 ft) of the rear bumper. This distance may be less during warmer or humid weather.

Turning the System On and Off

The system can be disabled through the Driver Information Center (DIC). See "Parking Assist" under *Driver Information Center (DIC)* on page 5-27 for more information.

URPA defaults to the on setting each time the vehicle is started.

When the System Does Not Seem to Work Properly

The following messages may be displayed on the DIC:

PARKING ASSIST OFF: This message occurs if the driver disables the system or if vehicle is driven above 8 km/h (5 mph) in R (Reverse).

SERVICE PARKING ASSIST: If this message occurs, take the vehicle to your dealer to repair the system.

PARK ASSIST BLOCKED SEE OWNER'S MANUAL: If the URPA system does not activate due to a temporary condition, this message displays on the DIC. This can occur under the following conditions:

- The ultrasonic sensors are not clean. Keep the vehicle's rear bumper free of mud, dirt, snow, ice and slush. For cleaning instructions, see *Exterior Care* on page 10-112.
- The park assist sensors are covered by frost or ice. Frost or ice can form around and behind the sensors and may not always be seen; this can occur after washing the vehicle in cold weather. The message may not clear until the frost or ice has melted.

- A trailer was attached to the vehicle, or an object was hanging out of the trunk or liftgate during the last drive cycle. Once the object is removed, URPA will return to normal operation.
- A tow bar is attached to the vehicle.
- The bumper is damaged. Take the vehicle to your dealer to repair the system.
- Other conditions, such as vibrations from a jackhammer or the compression of air brakes on a very large truck, are affecting system performance.

Side Blind Zone Alert (SBZA)

If equipped, the Side Blind Zone Alert system is a lane-changing aid that assists drivers with avoiding crashes that occur with vehicles in the side blind zone (or spot) areas.

The SBZA warning display will light up in the corresponding outside side mirror and will flash if the turn signal is on.

Warning

SBZA does not alert the driver to vehicles rapidly approaching outside of the side blind zones, pedestrians, bicyclists, or animals. It may not provide alerts when changing lanes under all driving conditions. Failure to use proper care when changing lanes may result in injury, death, or vehicle damage. Before making a lane change, always check mirrors, glance over your shoulder, and use the turn signals.

SBZA Detection Zones

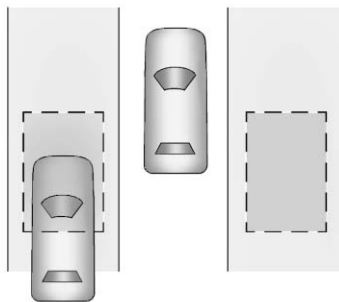

The SBZA sensor covers a zone of approximately one lane over from both sides of the vehicle, or 3.5 m (11 ft). The height of the zone is approximately between 0.5 m (1.5 ft) and 2 m (6 ft) off the ground. This zone starts at approximately the middle of the vehicle and goes back 5 m (16 ft).

How the System Works

The SBZA symbol lights up in the side mirrors when the system detects a vehicle in the next lane

over that is in the side blind zone. This indicates it may be unsafe to change lanes. Before making a lane change, check the SBZA display, check mirrors, glance over your shoulder, and use the turn signals.

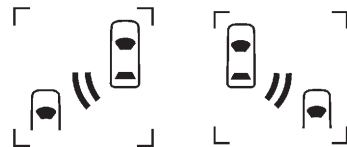

Left Side Mirror Display Right Side Mirror Display

When the vehicle is started, both outside mirror SBZA displays will briefly come on to indicate the system is operating. When the vehicle is moving forward, the left- or right-side mirror display will light up if a vehicle is detected in that blind zone. If the turn signal is activated in the same direction of a detected vehicle, this display will flash as an extra warning not to change lanes.

SBZA can be disabled through the Driver Information Center (DIC). See *Driver Information Center (DIC)* on page 5-27. If SBZA is disabled by the driver, the SBZA mirror displays will not light up.

When the System Does Not Seem to Work Properly

SBZA displays may not come on when passing a vehicle quickly or when towing a trailer. Keep in mind the SBZA detection zones that extend back from the side of the vehicle do not move further back when a trailer is towed. Use extra caution while changing lanes when towing a trailer. SBZA may alert you to objects attached to the vehicle, such as a trailer, bicycle, or object extending out to either side of the vehicle. This is normal system operation; the vehicle does not need service.

SBZA may not always alert the driver to vehicles in the side blind zone, especially in wet conditions. The system does not need to be

serviced. The system may light up due to guardrails, signs, trees, shrubs, and other non-moving objects. This is normal system operation; the vehicle does not need service.

SBZA may not operate when the SBZA sensors in the left or right corners of the rear bumper are covered with mud, dirt, snow, ice, or slush, or in heavy rainstorms. For cleaning instructions, see "Washing the Vehicle" under *Exterior Care* on page 10-112. If the DIC still displays the SIDE BLIND ZONE ALERT SYSTEM TEMPORARILY UNAVAILABLE message after cleaning both sides of the vehicle toward the rear corners of the vehicle, see your dealer.

If the SBZA displays do not light up when vehicles are in the blind zone and the system is clean, the system may need service. Take the vehicle to your dealer.

When SBZA is disabled for any reason other than the driver turning it off, the Side Blind Zone Alert ON option will not be available on the DIC menu.

FCC Information

See *Radio Frequency Statement* on page 13-15.

Rear Vision Camera (RVC)

The vehicle may have a rear vision camera system. Read this entire section before using it.

The rear vision camera system is designed to help the driver when backing up by displaying a view of the area behind the vehicle.

Warning

The RVC system does not display children, pedestrians, bicyclists, animals, or any other object

(Continued)

Warning (Continued)

located outside the camera's field of view, below the bumper, or under the vehicle. Perceived distances may be different from actual distances. Do not back the vehicle using only the RVC screen, during longer, higher speed backing maneuvers, or where there could be cross traffic. Failure to use proper care before backing may result in injury, death, or vehicle damage. Always check behind and around the vehicle before backing.

Using the System

When the driver shifts the vehicle into R (Reverse), the video image automatically appears on the navigation screen, or on the inside rearview mirror. Once the driver shifts out of R (Reverse), the navigation screen will go back to the

previous screen, or the video image will automatically disappear from the mirror after a delay.

The delay after shifting out of R (Reverse) is approximately five seconds. The delay can be canceled by performing one of the following:

- Shift into P (Park).
- Reach a vehicle speed of 8 km/h (5 mph).

Rear Vision Camera Error Messages**Service Rear Vision Camera**

System: This message can display when the system is not receiving information it requires from other vehicle systems.

🚗 (Service Rear Vision Camera

System Icon): This icon can display when the system is not receiving information it requires from other vehicle systems.

If any other problem occurs or if a problem persists, see your dealer.

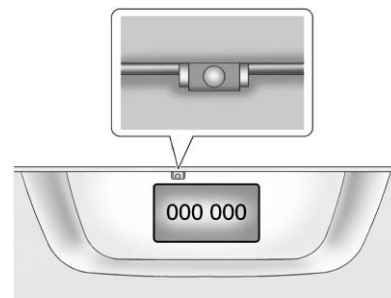
Rear Vision Camera Location

The camera is above the license plate.

The area displayed by the camera is limited and does not display objects that are close to either corner or under the bumper. The area displayed can vary depending on vehicle orientation or road conditions. Displayed images may be farther or closer than they appear.

9-48 Driving and Operating

The following illustrations show the field of view that the camera provides.

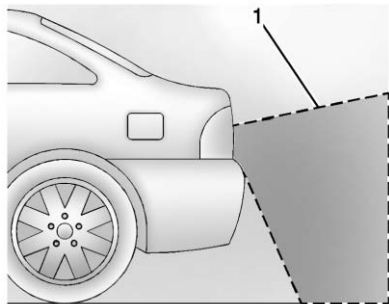

1. View displayed by the camera.

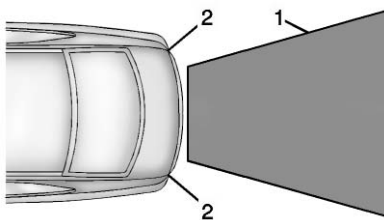

1. View displayed by the camera.
2. Corner of the rear bumper.

When the System Does Not Seem to Work Properly

The rear vision camera system might not work properly or display a clear image if the following occurs:

- It is dark.
- The sun or the beam of headlamps is shining directly into the camera lens.

- Ice, snow, mud, or anything else builds up on the camera lens. Clean the lens, rinse it with water, and wipe it with a soft cloth.
- The back of the vehicle is in an accident. The position and mounting angle of the camera can change or the camera can be affected. Be sure to have the camera and its position and mounting angle checked at your dealer.
- There are extreme temperature changes.

Fuel

Use of the recommended fuel is an important part of the proper maintenance of this vehicle. To help keep the engine clean and maintain optimum vehicle performance, we recommend TOP TIER Detergent Gasolines. See www.toptiergas.com for a list of TOP TIER Detergent Gasolines.



If the vehicle has a V6 engine, use regular unleaded gasoline with a posted octane rating of 87 or higher. If the octane rating is less than 87,

an audible knocking noise, commonly referred to as spark knock, might be heard when driving. If this occurs, use a gasoline rated at 87 octane or higher as soon as possible. If heavy knocking is heard when using gasoline rated at 87 octane or higher, the engine needs service.

If the vehicle has a V8 engine, use premium unleaded gasoline with a posted octane rating of 91 or higher. If the octane is less than 91, you could damage the engine and may void your vehicle warranty. If heavy knocking is heard when using gasoline rated at 91 octane or higher, the engine needs service.

Use of Seasonal Fuels

Use summer and winter fuels in the appropriate season. Driving or starting could be affected if the incorrect fuel is used. Drive the vehicle with the engine running until the fuel is a half tank or less, then refuel with the current seasonal fuel.

Prohibited Fuels

Gasolines containing oxygenates, such as ethers and ethanol, as well as reformulated gasolines are available in some cities. If these gasolines comply with the previously described specification, then they are acceptable to use. However, E85 and other fuels containing more than 15% ethanol must be used only in FlexFuel vehicles.

Caution

Do not use fuel containing methanol. It can corrode metal parts in the fuel system and also damage plastic and rubber parts. That damage would not be covered under the vehicle warranty.

Some gasolines that are not reformulated for low emissions can contain an octane-enhancing additive called methylcyclopentadienyl manganese tricarbonyl (MMT). Do not use gasolines with MMT as they can reduce spark plug life and affect emission control system performance. The malfunction indicator lamp may turn on. If this occurs, see your dealer for service.

Gasoline Specifications

At a minimum, gasoline should meet ASTM specification D 4814. Some gasolines contain an octane-enhancing additive called methylcyclopentadienyl manganese tricarbonyl (MMT). We recommend against the use of gasolines containing MMT. See "Prohibited Fuels" in *Fuel on page 9-49*.

California Fuel Requirements

If the vehicle is certified to meet California Emissions Standards, it is designed to operate on fuels that meet California specifications. See the underhood emission control label. If this fuel is not available in states adopting California Emissions Standards, the vehicle will operate satisfactorily on fuels meeting federal specifications, but emission control system performance might be affected. The malfunction indicator lamp could turn on and the vehicle may not pass a smog-check test. See *Malfunction Indicator Lamp on page 5-19*. If this occurs, return to your authorized dealer for diagnosis. If it is determined that the condition is caused by the type of fuel used, repairs may not be covered by the vehicle warranty.

Fuels in Foreign Countries

If planning to drive in countries outside the U.S. or Canada, the proper fuel might be hard to find. Check regional auto club or fuel retail brand websites for availability in the country where driving. Never use leaded gasoline, fuel containing methanol, or any other fuel not recommended. Costly repairs caused by use of improper fuel would not be covered by the vehicle warranty.

Fuel Additives

To keep fuel systems clean, TOP TIER Detergent Gasoline is recommended. See *Fuel on page 9-49*.

If TOP TIER Detergent Gasoline is not available, one bottle of Fuel System Treatment PLUS, part number 88861013, added to the fuel tank at every engine oil change, can help. Fuel System Treatment PLUS

is the only gasoline additive recommended by General Motors. It is available at your dealer.

Filling the Tank

Warning

Fuel vapors and fuel fires burn violently and can cause injury or death.

- To help avoid injuries to you and others, read and follow all the instructions on the fuel pump island.
- Turn off the engine when refueling.
- Keep sparks, flames, and smoking materials away from fuel.
- Do not leave the fuel pump unattended.
- Do not reenter the vehicle while pumping fuel.

(Continued)

Warning (Continued)

- Keep children away from the fuel pump and never let children pump fuel.
- Fuel can spray out if the fuel cap is opened too quickly. This spray can happen if the tank is nearly full, and is more likely in hot weather. Open the fuel cap slowly and wait for any hiss noise to stop then unscrew the cap all the way

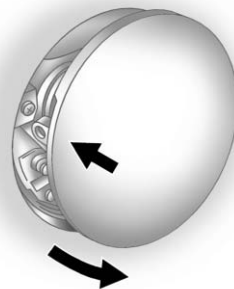

The cap is behind a locking fuel door on the passenger side of the vehicle.

To open the fuel door, push the rearward center edge in and release and it will open.

To remove the tethered fuel cap, turn it slowly counterclockwise.

While refueling, hang the tethered fuel cap from the hook on the fuel door.

9-52 Driving and Operating

If the fuel cap is not installed properly, a message will appear on the Driver Information Center display. See *Fuel System Messages* on page 5-37.

When reinstalling the cap, turn it clockwise until it clicks once, otherwise the malfunction indicator lamp could turn on. See *Malfunction Indicator Lamp* on page 5-19.

Be careful not to spill fuel. Do not top off or overfill the tank and wait a few seconds after you have finished pumping before removing the nozzle. Clean fuel from painted surfaces as soon as possible. See *Exterior Care* on page 10-112.

When replacing the fuel cap, turn it clockwise until it clicks once. Make sure the cap is fully installed. The diagnostic system can determine if the fuel cap has been left off or improperly installed. This would allow fuel to evaporate into the atmosphere. See *Malfunction Indicator Lamp* on page 5-19.

Warning

If a fire starts while you are refueling, do not remove the nozzle. Shut off the flow of fuel by shutting off the pump or by notifying the station attendant. Leave the area immediately.

Caution

If a new fuel cap is needed, be sure to get the right type of cap from your dealer. The wrong type of fuel cap might not fit properly, might cause the malfunction indicator lamp to light, and could damage the fuel tank and emissions system. See *Malfunction Indicator Lamp* on page 5-19.

Filling a Portable Fuel Container

Warning

Filling a portable fuel container while it is in the vehicle can cause fuel vapors that can ignite either by static electricity or other means. You or others could be badly burned and the vehicle could be damaged. Always:

- Use approved fuel containers.
- Remove the container from the vehicle, trunk, or pickup bed before filling.
- Place the container on the ground.
- Place the nozzle inside the fill opening of the container before dispensing fuel, and

(Continued)

Warning (Continued)

keep it in contact with the fill opening until filling is complete.

- Fill the container no more than 95% full to allow for expansion.
- Do not smoke, light matches, or use lighters while pumping fuel.
- Avoid using cell phones or other electronic devices.

Trailer Towing**General Towing Information**

Only use towing equipment that has been designed for the vehicle. Contact your dealer or trailering dealer for assistance with preparing the vehicle for towing a trailer. Read the entire section before towing a trailer.

For towing a disabled vehicle, see *Towing the Vehicle on page 10-109*. For towing the vehicle behind another vehicle such as a motor home, see *Recreational Vehicle Towing on page 10-109*.

Driving Characteristics and Towing Tips**Driving with a Trailer**

When towing a trailer:

- Become familiar with the state and local laws that apply specifically to trailer towing.
- Do not tow a trailer during the first 800 km (500 mi), to prevent damage to the engine, axle or other parts.
- Then, during the first 800 km (500 mi) trailer towing, do not drive over 80 km/h (50 mph) and do not make starts at full throttle.
- Vehicles with automatic transmissions can tow in D (Drive) but M (Manual Mode) is recommended. See *Manual Mode on page 9-28*. Use a lower gear if the transmission shifts too often. For vehicles with a manual transmission, it is better not to use the highest gear.

9-54 Driving and Operating

- Turn off Park Assist when towing.

Warning

When towing a trailer, exhaust gases may collect at the rear of the vehicle and enter if the liftgate, trunk/hatch, or rear-most window is open.

When towing a trailer:

- Do not drive with the liftgate, trunk/hatch, or rear-most window open.
- Fully open the air outlets on or under the instrument panel.
- Also adjust the Climate Control system to a setting that brings in only outside air. See "Climate Control Systems" in the Index.

For more information about Carbon Monoxide, see *Engine Exhaust* on page 9-25.

Towing a trailer requires a certain amount of experience. The combination you are driving is longer and not as responsive as the vehicle itself. Get acquainted with the handling and braking of the rig before setting out for the open road.

Before starting, check all trailer hitch parts and attachments, safety chains, electrical connectors, lamps, tires and mirrors. If the trailer has electric brakes, start the combination moving and then apply the trailer brake controller by hand to be sure the brakes work.

During the trip, check occasionally to be sure that the load is secure and the lamps and any trailer brakes still work.

Towing with a Stability Control System

When towing, the sound of the stability control system might be heard. The system is reacting to the vehicle movement caused by the

trailer, which mainly occurs during cornering. This is normal when towing heavier trailers.

Following Distance

Stay at least twice as far behind the vehicle ahead as you would when driving the vehicle without a trailer. This can help to avoid situations that require heavy braking and sudden turns.

Passing

More passing distance is needed when towing a trailer. Because the rig is longer, it is necessary to go farther beyond the passed vehicle before returning to the lane.

Backing Up

Hold the bottom of the steering wheel with one hand. To move the trailer to the left, move your hand to the left. To move the trailer to the right, move your hand to the right. Always back up slowly and, if possible, have someone guide you.

Making Turns

Caution

Making very sharp turns while trailering could cause the trailer to come in contact with the vehicle. The vehicle could be damaged. Avoid making very sharp turns while trailering.

When turning with a trailer, make wider turns than normal so the trailer will not strike soft shoulders, curbs, road signs, trees or other objects. Use the turn signal well in advance and avoid jerky or sudden maneuvers.

Turn Signals When Towing a Trailer

The turn signal indicators on the instrument cluster flash whenever signaling a turn or lane change. Properly hooked up, the trailer

lamps also flash, telling other drivers the vehicle is turning, changing lanes or stopping.

When towing a trailer, the arrows on the instrument cluster flash for turns even if the bulbs on the trailer are burned out. Check occasionally to be sure the trailer bulbs are still working.

Driving on Grades

Reduce speed and shift to a lower gear before starting down a long or steep downgrade. If the transmission is not shifted down, the brakes might have to be used so much that they would get hot and no longer work well.

The vehicle can tow in D (Drive). Use a lower gear if the transmission shifts too often.

When towing at high altitude on steep uphill grades, engine coolant boils at a lower temperature than at normal altitudes. If the engine is turned off immediately after towing at high altitude on steep uphill

grades, the vehicle could show signs similar to engine overheating. To avoid this, let the engine run while parked, preferably on level ground, with the transmission in P (Park) for a few minutes before turning the engine off. If the overheat warning comes on, see *Engine Overheating on page 10-24*.

Parking on Hills

Warning

Parking the vehicle on a hill with the trailer attached can be dangerous. If something goes wrong, the rig could start to move. People can be injured, and both the vehicle and the trailer can be damaged. When possible, always park the rig on a flat surface.

If parking the rig on a hill:

1. Press the brake pedal, but do not shift into P (Park) yet. Turn the wheels into the curb if facing downhill or into traffic if facing uphill.
2. Have someone place chocks under the trailer wheels.
3. When the wheel chocks are in place, release the brake pedal until the chocks absorb the load.
4. Reapply the brake pedal. Then apply the parking brake and shift into P (Park) for vehicles with an automatic transmission or into gear for vehicles with a manual transmission.
5. Release the brake pedal.

Leaving After Parking on a Hill

1. Apply and hold the brake pedal while you:
 - Start the engine.
 - Shift into a gear.
 - Release the parking brake.

2. Let up on the brake pedal.
3. Drive slowly until the trailer is clear of the chocks.
4. Stop and have someone pick up and store the chocks.

Maintenance When Trailer Towing

The vehicle needs service more often when pulling a trailer. See the *Maintenance Schedule on page 11-4*. Things that are especially important in trailer operation are automatic transmission fluid, engine oil, axle lubricant, belts, cooling system and brake system. Inspect these before and during the trip.

Check periodically to see that all hitch nuts and bolts are tight.

Engine Cooling When Trailer Towing

The cooling system may temporarily overheat during severe operating conditions. See *Engine Overheating on page 10-24*.

Trailer Towing (CTS-V and Coupe)

The vehicle is neither designed nor intended to tow a trailer.

Trailer Towing (Except CTS-V and Coupe)

Before pulling a trailer, three important considerations have to do with weight:

- Weight of the trailer.
- Weight of the trailer tongue.
- Total weight on your vehicle's tires.

Weight of the Trailer

How heavy can a trailer safely be?

It should never weigh more than 454 kg (1,000 lb). But even that can be too heavy.

It depends on how the rig is used. For example, speed, altitude, road grades, outside temperature, and how much the vehicle is used to pull

a trailer are all important. It can depend on any special equipment on the vehicle, and the amount of tongue weight the vehicle can carry. See "Weight of the Trailer Tongue" later in this section.

Maximum trailer weight is calculated assuming only the driver is in the tow vehicle and it has all the required trailering equipment. The weight of additional optional equipment, passengers, and cargo in the tow vehicle must be subtracted from the maximum trailer weight.

Ask your dealer for trailering information or advice, or write us at our Customer Assistance Offices. See *Customer Assistance Offices* on page 13-3.

Weight of the Trailer Tongue

The tongue load (1) of any trailer is an important weight to measure because it affects the total gross weight of the vehicle. The Gross Vehicle Weight (GVW) includes the curb weight of the vehicle, any cargo carried in it, and the people who will be riding in the vehicle. If there are a lot of options, equipment, passengers, or cargo in the vehicle, it will reduce the tongue weight the vehicle can carry, which will also reduce the trailer weight the vehicle can tow. If towing a trailer, the tongue load must be added to the GVW because the vehicle will be carrying that weight, too. See *Vehicle Load Limits* on page 9-11.

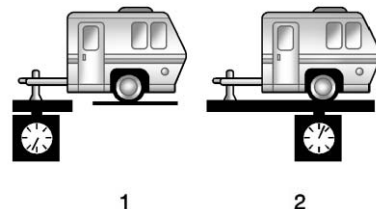

The trailer tongue (1) should weigh 10 percent of the total loaded trailer weight (2).

After loading the trailer, weigh the trailer and then the tongue, separately, to see if the weights are proper. If they are not, adjustments might be made by moving some items around in the trailer.

Total Weight on Your Vehicle's Tires

Be sure the vehicle's tires are inflated to the upper limit for cold tires. These numbers can be found on the Tire and Loading Information label. See *Vehicle Load Limits* on page 9-11. Make sure not to go over the GVW limit for the vehicle, including the weight of the trailer tongue.

Towing Equipment

Hitches

Use the correct hitch equipment. See your dealer or a hitch dealer for assistance.

- The rear bumper on the vehicle is not intended for hitches. Do not attach rental hitches or other bumper-type hitches to it. Use only a frame-mounted hitch that does not attach to the bumper.

- Will any holes be made in the body of the vehicle when the trailer hitch is installed? If so, seal the holes when the hitch is removed. If the holes are not sealed, dirt, water, and deadly carbon monoxide (CO) from the exhaust can get into the vehicle. See *Engine Exhaust* on page 9-25.

Safety Chains

Always attach chains between the vehicle and the trailer. Cross the safety chains under the tongue of the trailer to help prevent the tongue from contacting the road if it becomes separated from the hitch. Leave enough slack so the rig can turn. Never allow safety chains to drag on the ground.

Trailer Brakes

Does the trailer have its own brakes? Be sure to read and follow the instructions for the trailer brakes so they are installed, adjusted, and maintained properly.

Because the vehicle has antilock brakes, do not tap into the vehicle's brake system. If this is done, both brake systems will not work well, or at all.

Conversions and Add-Ons

Add-On Electrical Equipment

 **Caution**

Some electrical equipment can damage the vehicle or cause components to not work and would not be covered by the warranty. Always check with your dealer before adding electrical equipment.

Add-on equipment can drain the vehicle's 12-volt battery, even if the vehicle is not operating.

The vehicle has an airbag system. Before attempting to add anything electrical to the vehicle, see *Servicing the Airbag-Equipped Vehicle on page 3-31* and *Adding Equipment to the Airbag-Equipped Vehicle on page 3-31*.

Vehicle Care

General Information

General Information	10-3
California Proposition 65 Warning	10-3
California Perchlorate Materials Requirements	10-3
Accessories and Modifications	10-3

Vehicle Checks

Doing Your Own Service Work	10-4
Hood	10-5
Engine Compartment Overview	10-6
Engine Cover	10-9
Engine Oil	10-10
Engine Oil Life System	10-13
Automatic Transmission Fluid	10-14
Manual Transmission Fluid	10-14
Hydraulic Clutch	10-15
Engine Air Cleaner/Filter	10-15
Cooling System	10-18
Engine Coolant	10-19

Engine Overheating	10-24
Overheated Engine Protection Operating Mode	10-25
Power Steering Fluid	10-25
Washer Fluid	10-26
Brakes	10-27
Brake Fluid	10-28
Battery	10-29
All-Wheel Drive	10-30
Starter Switch Check	10-31
Automatic Transmission Shift Lock Control Function Check	10-31
Ignition Transmission Lock Check	10-32
Park Brake and P (Park) Mechanism Check	10-32
Wiper Blade Replacement	10-32

Headlamp Aiming

Headlamp Aiming	10-34
-----------------------	-------

Bulb Replacement

Bulb Replacement	10-35
Halogen Bulbs	10-35
High Intensity Discharge (HID) Lighting	10-35

LED Lighting	10-35
Fog Lamps	10-35
License Plate Lamp (Coupe and Sedan)	10-36
License Plate Lamp (Wagon)	10-36
Replacement Bulbs	10-37

Electrical System

Electrical System Overload	10-37
Fuses and Circuit Breakers	10-38
Engine Compartment Fuse Block (CTS Coupe)	10-38
Engine Compartment Fuse Block (CTS Wagon)	10-42
Engine Compartment Fuse Block (CTS-V Coupe and Sedan)	10-46
Engine Compartment Fuse Block (CTS-V Wagon)	10-49
Rear Compartment Fuse Block (CTS Wagon)	10-53

10-2 Vehicle Care

Rear Compartment Fuse Block (CTS-V Wagon)	10-55	Tire Pressure Monitor Operation	10-73	Storing the Tire Sealant and Compressor Kit (Wagon)	10-95
Rear Compartment Fuse Block (CTS Coupe)	10-57	Tire Inspection	10-76	Storing the Tire Sealant and Compressor Kit (Sedan)	10-96
Rear Compartment Fuse Block (CTS-V Coupe and Sedan)	10-59	Tire Rotation	10-76	Tire Changing	10-96
Wheels and Tires		When It Is Time for New Tires	10-78	Compact Spare Tire	10-104
Tires	10-61	Buying New Tires	10-79	Jump Starting	
All-Season Tires	10-62	Different Size Tires and Wheels	10-81	Jump Starting	10-105
Winter Tires	10-63	Uniform Tire Quality Grading	10-82	Towing the Vehicle	
Low-Profile Tires	10-63	Wheel Alignment and Tire Balance	10-83	Towing the Vehicle	10-109
Summer Tires	10-64	Wheel Replacement	10-83	Recreational Vehicle Towing	10-109
Tire Sidewall Labeling	10-64	Tire Chains	10-84	Appearance Care	
Tire Designations	10-66	If a Tire Goes Flat	10-85	Exterior Care	10-112
Tire Terminology and Definitions	10-67	Tire Sealant and Compressor Kit	10-86	Interior Care	10-116
Tire Pressure	10-70	Storing the Tire Sealant and Compressor Kit (Coupe)	10-94	Floor Mats	10-119
Tire Pressure for High-Speed Operation	10-71				
Tire Pressure Monitor System	10-72				

General Information

For service and parts needs, visit your dealer. You will receive genuine GM parts and GM-trained and supported service people.

Genuine GM parts have one of these marks:

ACDelco[®]

Genuine  | **Parts**

 **Accessories**

California Proposition 65 Warning

Most motor vehicles, including this one, contain and/or emit chemicals known to the State of California to cause cancer and birth defects or other reproductive harm. Engine exhaust, many parts and systems, many fluids, and some component wear by-products contain and/or emit these chemicals.

California Perchlorate Materials Requirements

Certain types of automotive applications, such as airbag initiators, safety belt pretensioners, and lithium batteries contained in Remote Keyless Entry transmitters, may contain perchlorate materials. Special handling may be necessary. For additional information, see www.dtsc.ca.gov/hazardouswaste/perchlorate.

Accessories and Modifications

Adding non-dealer accessories or making modifications to the vehicle can affect vehicle performance and safety, including such things as airbags, braking, stability, ride and handling, emissions systems, aerodynamics, durability, and electronic systems like antilock brakes, traction control, and stability control. These accessories or modifications could even cause malfunction or damage not covered by the vehicle warranty.

Damage to vehicle components resulting from modifications or the installation or use of non-GM certified parts, including control module or software modifications, is not covered under the terms of the vehicle warranty and may affect remaining warranty coverage for affected parts.

GM Accessories are designed to complement and function with other systems on the vehicle. See your dealer to accessorize the vehicle using genuine GM Accessories installed by a dealer technician.

Also, see *Adding Equipment to the Airbag-Equipped Vehicle* on page 3-31.

Vehicle Checks

Doing Your Own Service Work

 **Warning**

It can be dangerous to work on your vehicle if you do not have the proper knowledge, service manual, tools, or parts. Always follow owner manual procedures and consult the service manual for your vehicle before doing any service work.

If doing some of your own service work, use the proper service manual. It tells you much more about how to service the vehicle than this manual can. To order the proper service manual, see *Service Publications Ordering Information* on page 13-11.

This vehicle has an airbag system. Before attempting to do your own service work, see *Servicing the Airbag-Equipped Vehicle* on page 3-31.

Keep a record with all parts receipts and list the mileage and the date of any service work performed. See *Maintenance Records* on page 11-17.

 **Caution**

Even small amounts of contamination can cause damage to vehicle systems. Do not allow contaminants to contact the fluids, reservoir caps, or dipsticks.

Hood

To open the hood:



1. Pull the hood release lever with this symbol on it. It is inside the vehicle on the lower side of the instrument panel.

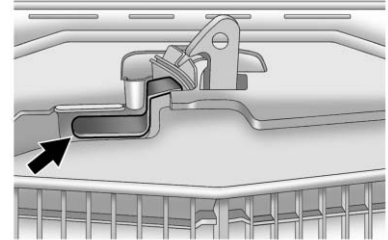

2. Go to the front of the vehicle and find the secondary hood release lever. The lever is under the front edge of the grille near the center. Lift the release lever up and raise the hood.

Before closing the hood, be sure all the filler caps are on properly. Then pull the hood down and close it firmly.

Engine Compartment Overview

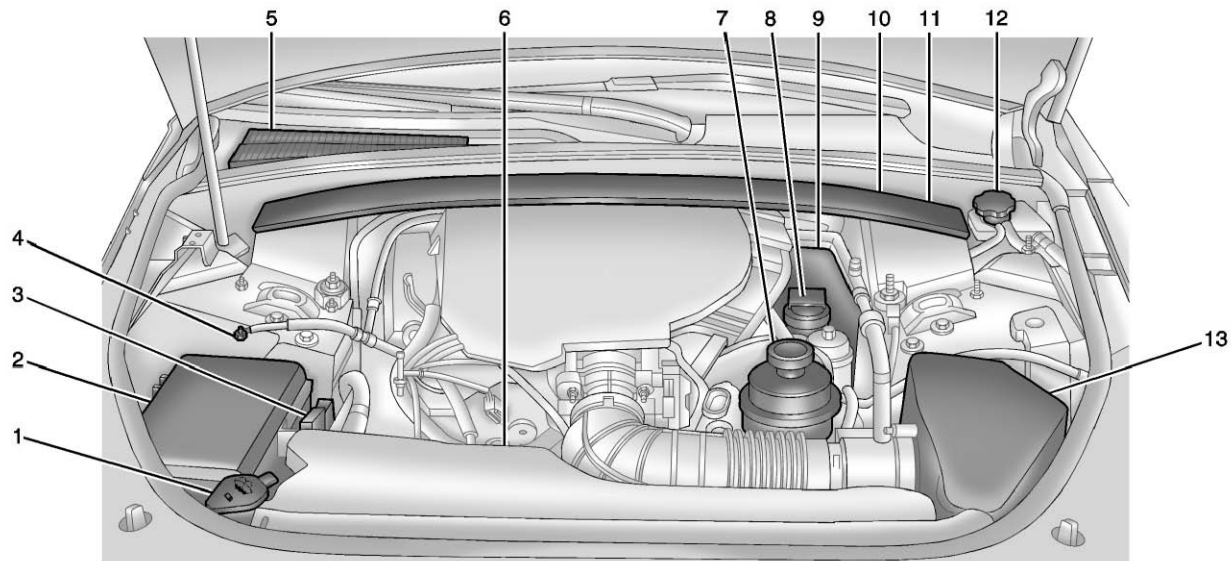

CTS 3.6L V6 Engine Shown, 3.0L V6 Engine Similar

1. Windshield Washer Fluid Reservoir. See *Washer Fluid* on page 10-26.
2. *Engine Compartment Fuse Block (CTS Coupe)* on page 10-38 or *Engine Compartment Fuse Block (CTS Wagon)* on page 10-42 or *Engine Compartment Fuse Block (CTS-V Coupe and Sedan)* on page 10-46 or *Engine Compartment Fuse Block (CTS-V Wagon)* on page 10-49.
3. Remote Positive (+) Terminal. See *Jump Starting* on page 10-105.
4. Remote Negative (-) Terminal. See *Jump Starting* on page 10-105.
5. *Passenger Compartment Air Filter* on page 8-6.
6. Engine Cooling Fan (Out of View). See *Cooling System* on page 10-18.
7. Power Steering Fluid Reservoir. See *Power Steering Fluid* on page 10-25.
8. Engine Oil Fill Cap. See *Engine Oil* on page 10-10.
9. Engine Oil Dipstick (Out of View). See *Engine Oil* on page 10-10.
10. Hydraulic Clutch Reservoir (If Equipped) (Not Shown). See *Hydraulic Clutch* on page 10-15.
11. Brake Master Cylinder Reservoir (Out of View). See *Brakes* on page 10-27.
12. Engine Coolant Surge Tank and Pressure Cap. See *Engine Coolant* on page 10-19.
13. *Engine Air Cleaner/Filter* on page 10-15.

10-8 Vehicle Care

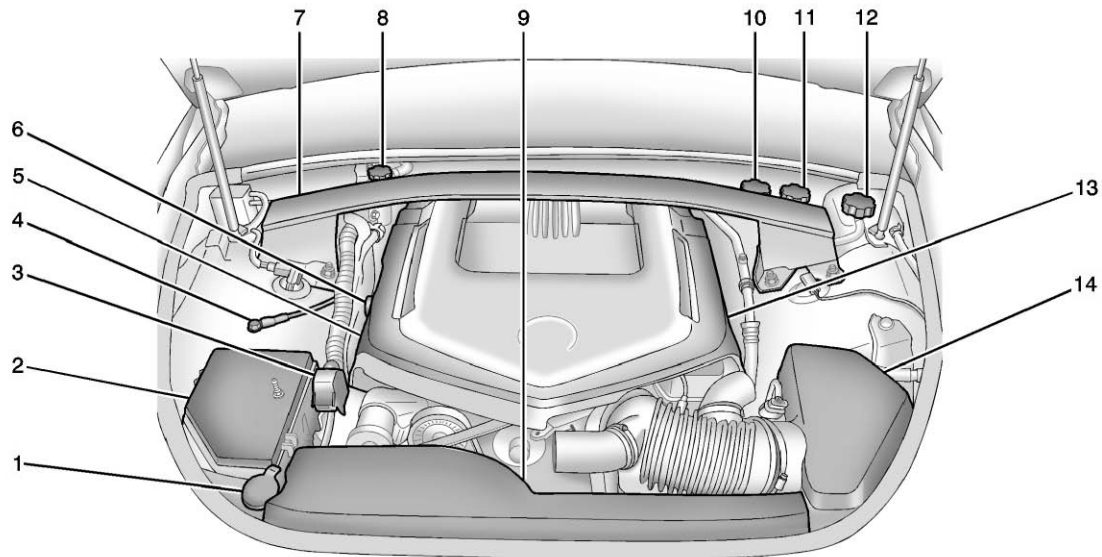

CTS-V 6.2L V8 Engine

1. Windshield Washer Fluid Reservoir. See *Washer Fluid* on page 10-26.
2. Engine Compartment Fuse Block (CTS Coupe) on page 10-38 or Engine Compartment Fuse Block (CTS Wagon) on page 10-42 or Engine Compartment Fuse Block (CTS-V Coupe and Sedan) on page 10-46 or Engine Compartment Fuse Block (CTS-V Wagon) on page 10-49.
3. Remote Positive (+) Terminal. See *Jump Starting* on page 10-105.
4. Remote Negative (-) Terminal. See *Jump Starting* on page 10-105.
5. Engine Oil Fill Cap (Out of View). See *Engine Oil* on page 10-10.
6. Engine Oil Dipstick. See *Engine Oil* on page 10-10.
7. Passenger Compartment Air Filter on page 8-6.
8. Intercooler System Pressure Cap. See *Cooling System* on page 10-18.
9. Engine Cooling Fans (Out of View). See *Cooling System* on page 10-18.
10. Hydraulic Clutch Reservoir (If Equipped). See *Hydraulic Clutch* on page 10-15.
11. Brake Master Cylinder Reservoir. See *Brakes* on page 10-27.
12. Engine Coolant Surge Tank and Pressure Cap. See *Engine Coolant* on page 10-19.
13. Power Steering Fluid Reservoir (Under Engine Cover). See *Power Steering Fluid* on page 10-25.
14. Engine Air Cleaner/Filter on page 10-15.

Engine Cover

Engine Cover (CTS)

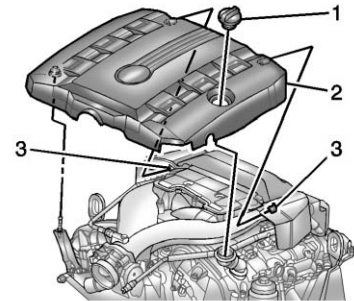

1. Oil Fill Cap
2. Engine Cover
3. Rear Tabs

To remove:

1. Remove the oil fill cap (1).
2. Raise the right front corner of the engine cover (2) to release it from the ball stud.

10-10 Vehicle Care

3. Pull the engine cover (2) forward to slide the rear tabs (3) out from under the retainers.
4. Lift and remove the engine cover.
5. Reverse Steps 1–4 to reinstall the engine cover.

Engine Cover (CTS-V)

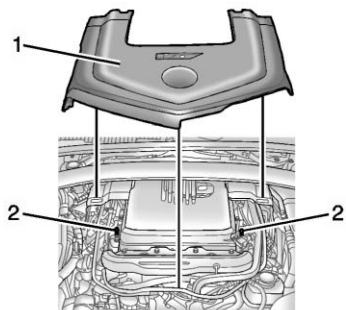

1. Engine Cover
2. Ball Studs

To remove:

The engine cover consists of two pieces. Only the larger front piece needs to be removed to access the engine oil and power steering fill caps.

1. Raise the front of the engine cover (1) to release it from the ball studs (2).
2. Pull the engine cover forward until it is clear of the smaller piece.
3. Lift and remove the engine cover.
4. Reverse Steps 1–3 to reinstall the engine cover.

Engine Oil

To ensure proper engine performance and long life, careful attention must be paid to engine oil. Following these simple, but important steps will help protect your investment:

- Always use engine oil approved to the proper specification and of the proper viscosity grade. See “Selecting the Right Engine Oil” in this section.
- Check the engine oil level regularly and maintain the proper oil level. See “Checking Engine Oil” and “When to Add Engine Oil” in this section.
- Change the engine oil at the appropriate time. See *Engine Oil Life System on page 10-13*.
- Always dispose of engine oil properly. See “What to Do with Used Oil” in this section.

Checking Engine Oil

It is a good idea to check the engine oil level at each fuel fill. In order to get an accurate reading, the vehicle must be on level ground. The engine oil dipstick handle is a loop. See *Engine Compartment Overview on page 10-6* for the location of the engine oil dipstick.

1. If the engine has been running recently, turn off the engine and allow several minutes for the oil to drain back into the oil pan. Checking the oil level too soon after engine shutoff will not provide an accurate oil level reading.

Warning

The engine oil dipstick handle may be hot; it could burn you. Use a towel or glove to touch the dipstick handle.

2. Pull out the dipstick and clean it with a paper towel or cloth, then push it back in all the way. Remove it again, keeping the tip down, and check the level.

When to Add Engine Oil



If the oil is below the cross-hatched area at the tip of the dipstick, add 1 L (1 qt) of the recommended oil and then recheck the level. See “Selecting the Right Engine Oil” in this section for an explanation of what kind of oil to use. For engine oil crankcase capacity, see *Capacities and Specifications on page 12-2*.

Caution

Do not add too much oil. Oil levels above or below the acceptable operating range shown on the dipstick are harmful to the engine. If you find that you have an oil level above the operating range, i.e., the engine has so much oil that the oil level gets above the cross-hatched area that shows the proper operating range, the engine could be damaged. You should drain out the excess oil or limit driving of the vehicle and seek a service professional to remove the excess amount of oil.

See *Engine Compartment Overview on page 10-6* for the location of the engine oil fill cap.

Add enough oil to put the level somewhere in the proper operating range. Push the dipstick all the way back in when through.

Selecting the Right Engine Oil

Selecting the right engine oil depends on both the proper oil specification and viscosity grade. See *Recommended Fluids and Lubricants* on page 11-13.

Specification

Use and ask for licensed engine oils with the dexos1[®] approved certification mark. Engine oils meeting the requirements for the vehicle should have the dexos1 approved certification mark. This certification mark indicates that the oil has been approved to the dexos1 specification.



Caution

Failure to use the recommended engine oil can result in engine damage not covered by the vehicle warranty. Check with your dealer or service provider on whether the oil is approved to the dexos1 specification.

Viscosity Grade

SAE 5W-30 is the best viscosity grade for the vehicle. Do not use other viscosity grade oils such as SAE 10W-30, 10W-40, or 20W-50.

Cold Temperature Operation: In an area of extreme cold, where the temperature falls below -29°C (-20°F), an SAE 0W-30 oil may be used. An oil of this viscosity grade will provide easier cold starting for the engine at extremely low temperatures. When selecting an oil of the appropriate viscosity grade,

always select an oil of the correct specification. See "Specification" earlier in this section.

Engine Oil Additives/Engine Oil Flushes

Do not add anything to the oil. The recommended oils with the dexos specification and displaying the dexos certification mark are all that is needed for good performance and engine protection.

Engine oil system flushes are not recommended and could cause engine damage not covered by the vehicle warranty.

What to Do with Used Oil

Used engine oil contains certain elements that can be unhealthy for your skin and could even cause cancer. Do not let used oil stay on your skin for very long. Clean your skin and nails with soap and water, or a good hand cleaner. Wash or properly dispose of clothing or rags

containing used engine oil. See the manufacturer's warnings about the use and disposal of oil products.

Used oil can be a threat to the environment. If you change your own oil, be sure to drain all the oil from the filter before disposal. Never dispose of oil by putting it in the trash or pouring it on the ground, into sewers, or into streams or bodies of water. Recycle it by taking it to a place that collects used oil.

Engine Oil Life System

When to Change Engine Oil

This vehicle has a computer system that indicates when to change the engine oil and filter. This is based on a combination of factors which include engine revolutions, engine temperature, and miles driven.

Based on driving conditions, the mileage at which an oil change is indicated can vary considerably. For the oil life system to work properly, the system must be reset every time the oil is changed.

When the system has calculated that oil life has been diminished, it indicates that an oil change is necessary. A CHANGE ENGINE OIL SOON message comes on. See *Engine Oil Messages on page 5-36*. Change the oil as soon as possible within the next 1 000 km (600 mi). It is possible that, if driving under the best conditions, the oil life system might indicate that an oil change is not necessary for up to a year. The engine oil and filter must be changed at least once a year and at this time the system must be reset. Your dealer has trained service people who will perform this work and reset the system. It is also important to check the oil regularly over the course of an oil drain interval and keep it at the proper level.

If the system is ever reset accidentally, the oil must be changed at 5 000 km (3,000 mi) since the last oil change. Remember to reset the oil life system whenever the oil is changed.

How to Reset the Engine Oil Life System

Reset the system whenever the engine oil is changed so that the system can calculate the next engine oil change. To reset the system:

1. Using the DIC, display OIL LIFE REMAINING. See *Driver Information Center (DIC) on page 5-27* and *Engine Oil Messages on page 5-36*.
2. Press ✓ and hold for two seconds to clear the CHANGE ENGINE OIL SOON message and reset the oil life at 100%.

Be careful not to reset the oil life display accidentally at any time other than after the oil is changed. It cannot be reset accurately until the next oil change.

The oil life system can also be reset as follows:

1. Turn the ignition on with the engine off.
2. Fully press and release the accelerator pedal three times within five seconds.

If the CHANGE ENGINE OIL SOON message is not on, the system is reset.

The system is reset when the CHANGE ENGINE OIL SOON message is off.

If the CHANGE ENGINE OIL SOON message comes back on when the vehicle is started, the engine oil life system has not been reset. Repeat the procedure.

Automatic Transmission Fluid

How to Check Automatic Transmission Fluid

It is not necessary to check the transmission fluid level. A transmission fluid leak is the only reason for fluid loss. If a leak occurs, take the vehicle to the dealer and have it repaired as soon as possible.

The vehicle is not equipped with a transmission fluid level dipstick. There is a special procedure for checking and changing the transmission fluid. Because this procedure is difficult, it should be done at the dealer. Contact your dealer for additional information or refer to the procedure in the service manual. To purchase a service manual, see *Service Publications Ordering Information on page 13-11*.

Change the fluid and filter at the intervals listed in *Maintenance Schedule on page 11-4*, and be sure to use the fluid listed in *Recommended Fluids and Lubricants on page 11-13*.

Manual Transmission Fluid

It is not necessary to check the manual transmission fluid level. A transmission fluid leak is the only reason for fluid loss. If a leak occurs, take the vehicle to a dealer for service. Have it repaired as soon as possible. You may also have the fluid level checked by your dealer when the oil is changed. See *Recommended Fluids and Lubricants on page 11-13* for the proper fluid to use.

Hydraulic Clutch

It is not necessary to regularly check clutch fluid unless you suspect there is a leak in the system. Adding fluid will not correct a leak. A fluid loss in this system could indicate a problem. Have the system inspected and repaired.

When to Check and What to Use



The hydraulic clutch fluid reservoir cap has this symbol on it. See *Engine Compartment Overview on page 10-6* for reservoir location.

Refer to the Maintenance Schedule for the proper fluid to use. See *Recommended Fluids and Lubricants on page 11-13*. The fluid requires changing every two years. See *Maintenance Schedule on page 11-4*.

How to Check and Add Fluid

Visually check the clutch fluid reservoir to make sure the fluid level is at the MIN (minimum) line on the side of the reservoir. The hydraulic clutch fluid system should be closed and sealed.

Do not remove the cap to check the fluid level or to top-off the fluid level. Remove the cap only when necessary to add the proper fluid until the level reaches the MIN line.

Engine Air Cleaner/Filter

The engine air cleaner/filter is in the engine compartment on the driver side of the vehicle, near the front. See *Engine Compartment Overview on page 10-6*.

When to Inspect the Engine Air Cleaner/Filter

Inspect and replace the air cleaner/filter at the scheduled maintenance intervals. See *Maintenance Schedule on page 11-4*. If you are driving in dusty/dirty conditions, inspect the filter at each engine oil change.

How to Inspect the Engine Air Cleaner/Filter

To inspect the air cleaner/filter, remove the filter from the vehicle and lightly shake the filter to release loose dust and dirt. If the filter remains covered with dirt, a new filter is required.

10-16 Vehicle Care

To inspect or replace the engine air cleaner/filter:

1. Turn the ignition off.

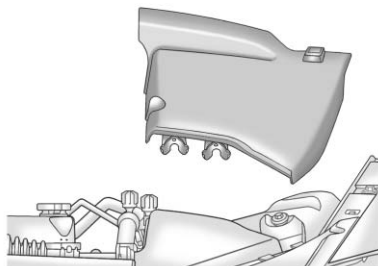

2. Remove the side cover by pulling up on the front of the cover.

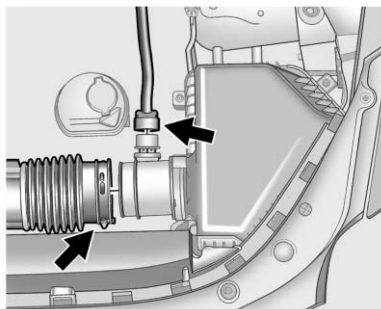

3. Disconnect the electrical connector from the air box.
4. Loosen the screw on the clamp holding the air outlet duct in place. Do not remove the clamp. Move the duct aside.
5. Remove the hose from the air cleaner housing mounting arm. Move the hose aside.

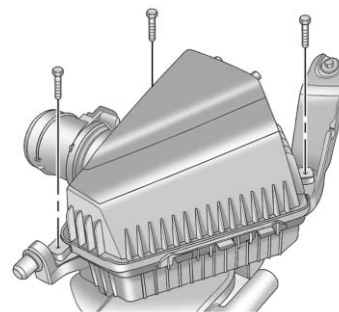

6. Remove the three air cleaner housing cover screws.

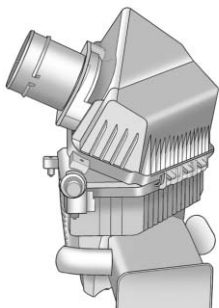

7. Move the air cleaner housing cover and remove the cover from the air cleaner housing.

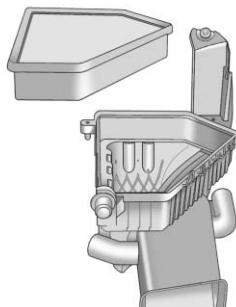

8. Remove the air cleaner filter from the air cleaner housing.

How to Reinstall Engine Air Cleaner/Filter

1. Install the air cleaner into the air cleaner housing. The outer air cleaner filter seal must be fitted properly in the air cleaner housing.
2. Align the air cleaner housing cover tabs to the air cleaner housing.
3. Install the air cleaner housing cover.

4. Install the air cleaner housing cover screws.
5. Install the hose to the air cleaner housing mounting arm. The hose must be routed correctly.
6. Install the air cleaner outlet duct to the air cleaner housing.
7. Tighten the air cleaner outlet duct screw clamp.
8. Attach the electrical connector to the air box.
9. Reinstall the side cover.

Warning

Operating the engine with the air cleaner/filter off can cause you or others to be burned. The air cleaner not only cleans the air; it helps to stop flames if the engine backfires. Use caution when working on the engine and do not drive with the air cleaner/filter off.

Caution

If the air cleaner/filter is off, dirt can easily get into the engine, which could damage it. Always have the air cleaner/filter in place when you are driving.

Cooling System

The cooling system allows the engine to maintain the correct working temperature.

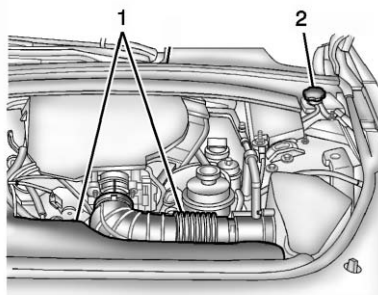

3.6L V6 Shown, 3.0L V6 Engine and 6.2L V8 Engine Similar

1. Engine Cooling Fan(s) (Out of View)
2. Coolant Surge Tank and Pressure Cap

Warning

An electric engine cooling fan under the hood can start up even when the engine is not running and can cause injury. Keep hands, clothing, and tools away from any underhood electric fan.

Warning

Heater and radiator hoses, and other engine parts, can be very hot. Do not touch them. If you do, you can be burned.

Do not run the engine if there is a leak. If you run the engine, it could lose all coolant. That could cause an engine fire, and you could be burned. Get any leak fixed before you drive the vehicle.

 **Caution**

Using coolant other than DEX-COOL[®] can cause premature engine, heater core, or radiator corrosion. In addition, the engine coolant could require changing sooner. Any repairs would not be covered by the vehicle warranty. Always use DEX-COOL (silicate-free) coolant in the vehicle.

Engine Coolant

The cooling system in the vehicle for all engines and the intercooler is filled with DEX-COOL[®]. This coolant is designed to remain in the vehicle for 5 years or 240 000 km (150,000 mi), whichever occurs first.

The following explains the cooling system and how to check and add coolant when it is low. If there is a problem with engine overheating, see *Engine Overheating* on page 10-24.

What to Use

 **Warning**

Adding only plain water or some other liquid to the cooling system can be dangerous. Plain water and other liquids, can boil before the proper coolant mixture will. The coolant warning system is set for the proper coolant mixture. With plain water or the wrong mixture, the engine could get too hot but you would not get the overheat warning. The engine could catch fire and you or others could be burned. Use a 50/50 mixture of clean, drinkable water and DEX-COOL coolant.

Use a 50/50 mixture of clean, drinkable water and DEX-COOL coolant. If using this mixture, nothing else needs to be added. This mixture:

- Gives freezing protection down to -37°C (-34°F), outside temperature.
- Gives boiling protection up to 129°C (265°F), engine temperature.
- Protects against rust and corrosion.
- Will not damage aluminum parts.
- Helps keep the proper engine temperature.

Caution

If improper coolant mixture, inhibitors, or additives are used in the vehicle cooling system, the engine could overheat and be damaged. Too much water in the mixture can freeze and crack engine cooling parts. The repairs would not be covered by the vehicle warranty. Use only the proper mixture of engine coolant for the cooling system. See *Recommended Fluids and Lubricants on page 11-13*.

Never dispose of engine coolant by putting it in the trash, pouring it on the ground, or into sewers, streams, or bodies of water. Have the coolant changed by an authorized service center, familiar with legal requirements regarding used coolant disposal. This will help protect the environment and your health.

Checking Coolant

The vehicle must be on a level surface when checking the coolant level.

The engine coolant reservoir is in the engine compartment on the driver side of the vehicle. See *Engine Compartment Overview on page 10-6*.

Check to see if coolant is visible in the surge tank. If the coolant inside the surge tank is boiling, do not do anything else until it cools down. If coolant is visible but the coolant level is not at or above the FULL COLD mark, add a 50/50 mixture of clean, drinkable water and DEX-COOL coolant at the coolant surge tank, but be sure the cooling system is cool before this is done.

If the engine is warm or hot, the coolant level should be at or above the FROID/FULL COLD line on the side of the coolant surge tank. If the engine is cold, the coolant level should be near the FROID/FULL

COLD line on the side of the coolant surge tank. If it is not, there could be a leak in the cooling system.

How to Add Coolant to the Surge Tank

Warning

You can be burned if you spill coolant on hot engine parts. Coolant contains ethylene glycol and it will burn if the engine parts are hot enough. Do not spill coolant on a hot engine.

Caution

This vehicle has a specific coolant fill procedure. Failure to follow this procedure could cause the engine to overheat and be severely damaged.

Warning

Steam and scalding liquids from a hot cooling system can blow out and burn you badly. Never turn the cap when the cooling system, including the surge tank pressure cap, is hot. Wait for the cooling system and surge tank pressure cap to cool.

If coolant is needed, add the proper DEX-COOL coolant mixture at the coolant surge tank.

If no coolant is visible in the surge tank, add coolant as follows:

1. Remove the coolant surge tank pressure cap when the cooling system, including the coolant surge tank pressure cap and upper radiator hose, is no longer hot. Turn the pressure cap slowly counterclockwise about one-quarter turn and then stop.

If you hear a hiss, wait for that to stop. A hiss means there is still some pressure left.

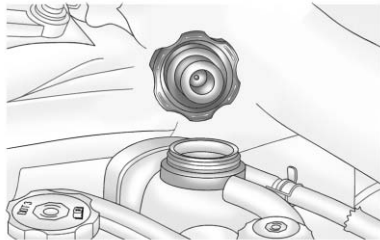

2. Keep turning the pressure cap slowly and remove it.

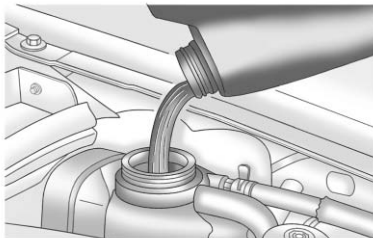

3. Fill the coolant surge tank with the proper mixture, to slightly above the FROID/FULL COLD line on the side of the coolant surge tank.

4. With the coolant surge tank pressure cap off, start the engine and let it run until you can feel the upper radiator hose getting hot. The upper radiator hose is the top hose coming out of the radiator, on the passenger side of the vehicle. Watch out for the engine cooling fans.

By this time, the coolant level inside the coolant surge tank may be lower. If the level is lower, add more of the proper mixture to the coolant surge tank until the level reaches the FROID/FULL COLD line on the side of the coolant surge tank.

5. Replace the pressure cap. Be sure the pressure cap is hand-tight and fully seated.

Caution

If the pressure cap is not tightly installed, coolant loss and possible engine damage may occur. Be sure the cap is properly and tightly secured.

Recheck the coolant level in the bottle next time you use your vehicle to ensure the system is full when cold.

Checking Coolant in the Intercooler System (CTS-V)

The vehicle must be on a level surface when checking the coolant level.

The super charged engine intercooler coolant fill neck is in the engine compartment on the passenger side of the vehicle. See *Engine Compartment Overview on page 10-6*.

On the coolant fill neck, there is a cold fill region between the two horizontal lines shown.

Check to see if coolant is visible in the coolant fill neck. If the coolant is not visible or below the cold fill region in the fill neck, add a 50/50 mixture of clean, drinkable water and DEX-COOL coolant at the coolant fill bottle, but be sure the cooling system is cool before this is done.

Adding Coolant to the Intercooler System Coolant (CTS-V)

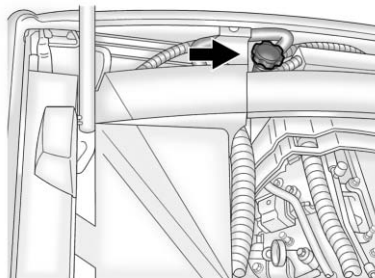

1. Remove the intercooler system pressure cap when the intercooler system hoses are no longer hot. Turn the pressure cap slowly counterclockwise about one-quarter of a turn. If you hear a hiss, wait for that to stop. This allows any pressure still left to be vented.
2. Keep turning the pressure cap slowly and remove it.

3. Add the proper DEX-COOL coolant mixture to the fill neck until the coolant is within the cold fill region.

With the intercooler system pressure cap off, start the engine and let it run for a couple of minutes. Then turn the engine off. By this time, the coolant level inside the fill neck may be lower. If the level drops where coolant is no longer within the cold fill region of the fill neck with the engine off, add more of the DEX-COOL coolant mixture to the fill neck until the level is again visible in the cold fill region.

4. Replace the pressure cap tightly.

Caution

If the pressure cap is not tightly installed, coolant loss and possible engine damage may occur. Be sure the cap is properly and tightly secured.

10-24 Vehicle Care

If the coolant is not at the proper level when the system cools down again, see your dealer.

Engine Overheating

The vehicle has several indicators to warn of engine overheating.

There are two engine hot messages that may be displayed in the Driver Information Center (DIC). See *Engine Cooling System Messages on page 5-35*.

If the decision is made not to lift the hood when one of these warnings appear, but get service help right away. See *Roadside Service on page 13-5*.

If the decision is made to lift the hood, make sure the vehicle is parked on a level surface.

Then check to see if the engine cooling fans are running. If the engine is overheating, the fan(s) should be running. If they are not, do not continue to run the engine and have the vehicle serviced.

Caution

Running the engine without coolant may cause damage or a fire. Vehicle damage would not be covered by the vehicle warranty. See *Overheated Engine Protection Operating Mode on page 10-25* for information on driving to a safe place in an emergency.

If Steam Is Coming from the Engine Compartment

Warning

Steam from an overheated engine can burn you badly, even if you just open the hood. Stay away from the engine if you see or hear steam coming from it. Just turn it off and get everyone away from the vehicle until it cools down. Wait until there is no sign of steam or coolant before you open the hood.

If you keep driving when the engine is overheated, the liquids in it can catch fire. You or others could be badly burned. Stop the engine if it overheats, and get out of the vehicle until the engine is cool.

If No Steam Is Coming from the Engine Compartment

If an engine overheat warning is displayed but no steam can be seen or heard, the problem may not be too serious. Sometimes the engine can get a little too hot when the vehicle:

- Climbs a long hill on a hot day.
- Stops after high-speed driving.
- Idles for long periods in traffic.
- Tows a trailer.

If the overheat warning is displayed with no sign of steam:

1. Turn the air conditioning off.
2. Turn the heater on to the highest temperature and to the highest fan speed. Open the windows as necessary.
3. When it is safe to do so, pull off the road, shift to P (Park) or N (Neutral) and let the engine idle.

If the temperature overheat gauge is no longer in the overheat zone or an overheat warning no longer displays, the vehicle can be driven. Continue to drive the vehicle slow for about 10 minutes. Keep a safe vehicle distance from the car in front of you. If the warning does not come back on, continue to drive normally and have the cooling system checked for proper fill and function.

If the warning continues, pull over, stop, and park the vehicle right away.

If there is no sign of steam, idle the engine for three minutes while parked. If the warning is still displayed, turn off the engine until it cools down. Also, see “Overheated Engine Protection Operating Mode” next in this section.

Overheated Engine Protection Operating Mode

This operating mode allows the vehicle to be driven to a safe place in an emergency. Should a hot engine condition exist, an overheat protection mode which alternates firing groups of cylinders helps prevent engine damage. In this mode, there is a loss in power and engine performance. Driving extended distances and/or towing a trailer in the overheat protection mode should be avoided.

Power Steering Fluid

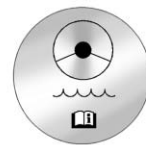

See *Engine Compartment Overview* on page 10-6 for the location of the power steering fluid reservoir.

When to Check Power Steering Fluid

It is not necessary to regularly check power steering fluid unless you suspect there is a leak in the system or you hear an unusual noise. A fluid loss in this system could indicate a problem. Have the system inspected and repaired.

How to Check Power Steering Fluid

To check the power steering fluid:

1. Turn the key off and let the engine compartment cool down.
2. Wipe the cap and the top of the reservoir clean.
3. Unscrew the cap and wipe the dipstick with a clean rag.
4. Replace the cap and completely tighten it.
5. Remove the cap again and look at the fluid level on the dipstick.

The level should be between the HOT and COLD marks. If necessary, add only enough fluid to bring the level between the marks.

What to Use

To determine what kind of fluid to use, see *Recommended Fluids and Lubricants on page 11-13*. Always use the proper fluid.

Washer Fluid

What to Use

When adding windshield washer fluid to the vehicle, be sure to read the manufacturer's instructions before use. If you will be operating your vehicle in an area where the temperature may fall below freezing, use a fluid that has sufficient protection against freezing.

Adding Washer Fluid

The WASHER FLUID LOW ADD FLUID message will appear on the Driver Information Center (DIC) when the fluid level is low. See *Washer Fluid Messages on page 5-46*.

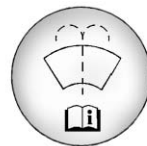

Open the cap with the washer symbol on it. Add washer fluid until the tank is full. See *Engine Compartment Overview on page 10-6* for reservoir location.

 **Caution**

- Do not use engine coolant (antifreeze) in the windshield washer. It can damage the windshield washer system and paint.
- Do not mix water with ready-to-use washer fluid. Water can cause the solution to freeze and damage the washer fluid tank and other parts of the washer system.
- When using concentrated washer fluid, follow the manufacturer instructions for adding water.
- Fill the washer fluid tank only three-quarters full when it is very cold. This allows for fluid expansion if freezing occurs, which could damage the tank if it is completely full.

Brakes

This vehicle has disc brakes. Disc brake pads have built-in wear indicators that make a high-pitched warning sound when the brake pads are worn and new pads are needed. The sound can come and go or be heard all the time when the vehicle is moving, except when applying the brake pedal firmly.

 **Warning**

The brake wear warning sound means that soon the brakes will not work well. That could lead to a crash. When the brake wear warning sound is heard, have the vehicle serviced.

 **Caution**

Continuing to drive with worn-out brake pads could result in costly brake repair.

Some driving conditions or climates can cause a brake squeal when the brakes are first applied or lightly applied. This does not mean something is wrong with the brakes.

Properly torqued wheel nuts are necessary to help prevent brake pulsation. When tires are rotated, inspect brake pads for wear and evenly tighten wheel nuts in the proper sequence to torque specifications. See *Capacities and Specifications on page 12-2*.

Brake linings should always be replaced as complete axle sets.

Brake Pedal Travel

See your dealer if the brake pedal does not return to normal height, or if there is a rapid increase in pedal travel. This could be a sign that brake service might be required.

Brake Adjustment

Every time the brakes are applied, with or without the vehicle moving, the brakes adjust for wear.

Replacing Brake System Parts

The braking system on a vehicle is complex. Its many parts have to be of top quality and work well together if the vehicle is to have really good braking. The vehicle was designed and tested with top-quality brake parts. When parts of the braking system are replaced, be sure to get new, approved replacement parts. If this is not done, the brakes might not work properly. For example, installing disc brake pads that are wrong for the vehicle, can change the balance between the front and rear brakes — for the worse. The braking performance expected can change in many other ways if the wrong replacement brake parts are installed.

Brake Fluid



The brake master cylinder reservoir is filled with DOT 3 brake fluid as indicated on the reservoir cap. See *Engine Compartment Overview on page 10-6* for the location of the reservoir.

There are only two reasons why the brake fluid level in the reservoir might go down:

- The brake fluid level goes down because of normal brake lining wear. When new linings are installed, the fluid level goes back up.
- A fluid leak in the brake hydraulic system can also cause a low fluid level. Have the brake

hydraulic system fixed, since a leak means that sooner or later the brakes will not work well.

Do not top off the brake fluid. Adding fluid does not correct a leak. If fluid is added when the linings are worn, there will be too much fluid when new brake linings are installed. Add or remove brake fluid, as necessary, only when work is done on the brake hydraulic system.

Warning

If too much brake fluid is added, it can spill on the engine and burn, if the engine is hot enough. You or others could be burned, and the vehicle could be damaged. Add brake fluid only when work is done on the brake hydraulic system.

When the brake fluid falls to a low level, the brake warning light comes on. See *Brake System Warning Light on page 5-22*.

What to Add

Use only new DOT 3 brake fluid from a sealed container. See *Recommended Fluids and Lubricants* on page 11-13.

Always clean the brake fluid reservoir cap and the area around the cap before removing it. This helps keep dirt from entering the reservoir.

 **Warning**

With the wrong kind of fluid in the brake hydraulic system, the brakes might not work well. This could cause a crash. Always use the proper brake fluid.

 **Caution**

- Using the wrong fluid can badly damage brake hydraulic system parts. For example, just a few drops of mineral-based oil, such as engine oil, in the brake hydraulic system can damage brake hydraulic system parts so badly that they will have to be replaced. Do not let someone put in the wrong kind of fluid.
- If brake fluid is spilled on the vehicle's painted surfaces, the paint finish can be damaged. Be careful not to spill brake fluid on the vehicle. If you do, wash it off immediately.

Battery

The battery is in the trunk, behind the trim panel, on the passenger side of the vehicle. Refer to the replacement number shown on the original battery label when a new battery is needed.

 **Warning**

Battery posts, terminals, and related accessories contain lead and lead compounds, chemicals known to the State of California to cause cancer and reproductive harm. Wash hands after handling.

After a power loss, such as disconnecting the battery or removing the maxi fuses in the power distribution fuse block, the following steps must be performed to calibrate the electronic throttle control. If this is not done, the engine will not run properly.

1. Turn the ignition on but do not start the engine.

10-30 Vehicle Care

2. Leave the ignition on for at least three minutes so that the electronic throttle control will cycle and relearn its home position.
3. Turn the ignition off.
4. Start and run the engine for at least 30 seconds.

Vehicle Storage

Warning

Batteries have acid that can burn you and gas that can explode. You can be badly hurt if you are not careful. See *Jump Starting* on page 10-105 for tips on working around a battery without getting hurt.

Infrequent Usage: Remove the black, negative (-) cable from the battery to keep the battery from running down.

Extended Storage: Remove the black, negative (-) cable from the battery or use a battery trickle charger.

All-Wheel Drive

If your vehicle is equipped with all-wheel-drive, this is an additional system that needs lubrication.

Transfer Case

When to Check Lubricant

It is not necessary to regularly check the transfer case fluid unless you suspect there is a leak or you hear an unusual noise. A fluid loss could indicate a problem. Have it inspected and repaired.

How to Check Lubricant

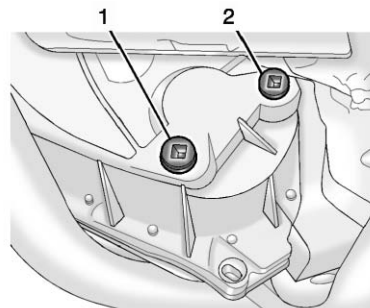

1. Drain Plug
2. Fill Plug

To get an accurate reading, the vehicle should be on a level surface.

If the level is below the bottom of the filler plug hole, located on the transfer case, you'll need to add some lubricant. Add enough lubricant to raise the level to the bottom of the filler plug hole. Use care not to overtighten the plug.

What to Use

Refer to the *Maintenance Schedule* on page 11-4 to determine what kind of lubricant to use. See *Recommended Fluids and Lubricants* on page 11-13.

Starter Switch Check

Warning

When you are doing this inspection, the vehicle could move suddenly. If the vehicle moves, you or others could be injured.

1. Before starting this check, be sure there is enough room around the vehicle.
2. Firmly apply both the parking brake and the regular brake. See *Parking Brake (Manual)* on page 9-34 or *Parking Brake (Electric)* on page 9-35.

Do not use the accelerator pedal, and be ready to turn off the engine immediately if it starts.

3. For automatic transmission vehicles, try to start the engine in each gear. The vehicle should start only in P (Park) or N (Neutral). If the vehicle starts in any other position, contact your dealer for service.

For manual transmission vehicles, put the shift lever in Neutral, push the clutch pedal down halfway, and try to start the engine. The vehicle should start only when the clutch pedal is pushed down all the way to the floor. If the vehicle starts when the clutch pedal is not pushed all the way down, contact your dealer for service.

Automatic Transmission Shift Lock Control Function Check

Warning

When you are doing this inspection, the vehicle could move suddenly. If the vehicle moves, you or others could be injured.

1. Before starting this check, be sure there is enough room around the vehicle. It should be parked on a level surface.
2. Firmly apply the parking brake. Be ready to apply the regular brake immediately if the vehicle begins to move.

3. With the engine off, turn the ignition on, but do not start the engine. Without applying the regular brake, try to move the shift lever out of P (Park) with normal effort. If the shift lever moves out of P (Park), contact your dealer for service.

Ignition Transmission Lock Check

While parked, and with the parking brake set, try to turn the ignition to LOCK/OFF in each shift lever position.

- The ignition should turn to LOCK/OFF only when the shift lever is in P (Park).
- With the key access ignition system, the ignition key should come out only in LOCK/OFF. See *Ignition Positions (Keyless Access)* on page 9-15 or *Ignition Positions (Key Access)* on page 9-17.

Contact your dealer if service is required.

Park Brake and P (Park) Mechanism Check

Warning

When you are doing this check, the vehicle could begin to move. You or others could be injured and property could be damaged. Make sure there is room in front of the vehicle in case it begins to roll. Be ready to apply the regular brake at once should the vehicle begin to move.

Park on a fairly steep hill, with the vehicle facing downhill. Keeping your foot on the regular brake, set the parking brake.

- To check the parking brake's holding ability: With the engine running and the transmission in N (Neutral), slowly remove foot

pressure from the regular brake pedal. Do this until the vehicle is held by the parking brake only.

- To check the P (Park) mechanism's holding ability: With the engine running, shift to P (Park). Then release the parking brake followed by the regular brake.

Contact your dealer if service is required.

Wiper Blade Replacement

Windshield wiper blades should be inspected for wear or cracking. See *Maintenance Schedule* on page 11-4.

It is a good idea to clean or replace the wiper blade assembly on a regular basis or when worn. For proper windshield wiper blade length and type, see *Maintenance Replacement Parts* on page 11-15.

To replace the wiper blade assembly:

1. Turn the ignition to ON/RUN with the engine off.
2. Turn on the windshield wipers and turn them off again when the wipers are in the out-wipe position. The driver side blade will be straight up and down on the windshield.
3. Pull the windshield wiper assembly away from the windshield.

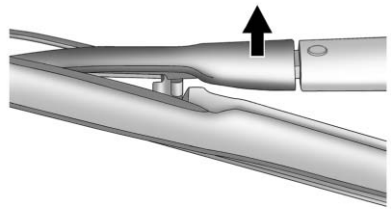

4. Lift up the wiper blade assembly cap.
5. Pull the wiper blade assembly down far enough to release it from the J-hooked end of the wiper arm. Slide the assembly away from the arm.

Allowing the wiper blade arm to touch the windshield when no wiper blade is installed could damage the windshield. Any damage that occurs would not be covered by your warranty. Do not allow the wiper blade arm to touch the windshield.

6. Replace the blade with a new one.

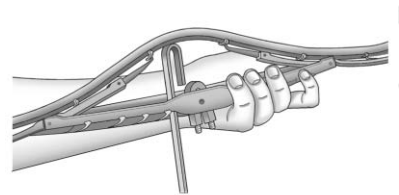

7. Reinstall the wiper blade assembly by sliding it over the wiper arm to engage the J-hooked end. Pull up on the assembly to lock it into place.
8. Repeat the steps for the other wiper.

Rear Wiper Blade Replacement (Wagon)

The rear wiper blade and wiper arm have a cover for protection. The cover must be removed before the wiper blade can be replaced.

To remove the cover:



1. Slide a plastic tool under the cover and push upward to unsnap.
2. Slide the cover toward the wiper blade tip to unhook it from the blade assembly.
3. Remove the cover.
4. After wiper blade replacement, ensure that the cover hook slides into the slot in the blade assembly.

5. Snap the cover down to secure.

To remove the wiper blade:

1. Lift the wiper arm away from the windshield.

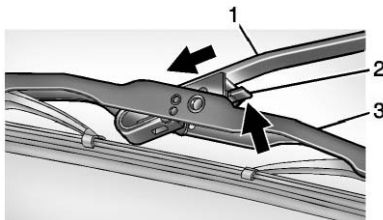

2. Push the release lever (2) to disengage the hook and push the wiper arm (1) out of the blade assembly (3).
3. Push the new blade assembly securely on the wiper arm until the release lever clicks into place.
4. Replace the wiper cover.

Headlamp Aiming

Headlamp aim has been preset and should need no further adjustment.

If the vehicle is damaged in a crash, the headlamp aim may be affected. If adjustment to the headlamps is necessary, see your dealer.

Bulb Replacement

For the proper type of replacement bulbs, see *Replacement Bulbs on page 10-37*.

For any bulb-changing procedure not listed in this section, contact your dealer.

Halogen Bulbs

Warning

Halogen bulbs have pressurized gas inside and can burst if you drop or scratch the bulb. You or others could be injured. Be sure to read and follow the instructions on the bulb package.

High Intensity Discharge (HID) Lighting

Warning

The high intensity discharge lighting system operates at a very high voltage. If you try to service any of the system components, you could be seriously injured. Have your dealer or a qualified technician service them.

After an HID headlamp bulb has been replaced, the beam might be a slightly different shade than it was originally. This is normal.

LED Lighting

This vehicle has several LED lamps. For replacement of any LED lighting assembly, contact your dealer.

Fog Lamps

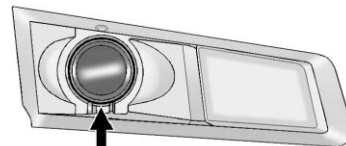

To replace a front fog lamp bulb:

1. Pull out the push-pins on the underside of the protection shield to remove the shield.
2. Reach up behind the front bumper area from under the vehicle to access the lamp housing.
3. Remove the electrical connector from the bulb by lifting the two plastic clips.
4. Remove the bulb socket from the lamp housing by turning the bulb socket one-quarter turn counterclockwise.

5. Pull the old bulb from the lamp housing keeping the bulb straight as you pull it out.
6. Install a new bulb.
7. Reinstall the electrical connector by pushing in the two plastic clips.
8. Push the bulb socket into the lamp housing and turn the socket one-quarter turn clockwise.

License Plate Lamp (Coupe and Sedan)

To replace one of these bulbs:

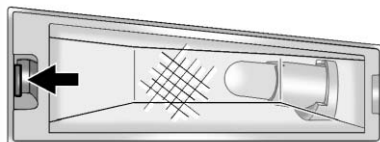

1. Push the tab to remove the license plate lamp.
2. Turn the license plate lamp assembly down to remove it.
3. Turn the socket counterclockwise and remove it.
4. Pull the bulb straight out to remove it.
5. Push the new bulb straight into the socket.
6. Reverse Steps 1 through 3 to reinstall the license plate lamp assembly.

License Plate Lamp (Wagon)

To replace one of these bulbs:

1. Open the liftgate. See *Liftgate* on page 2-19.

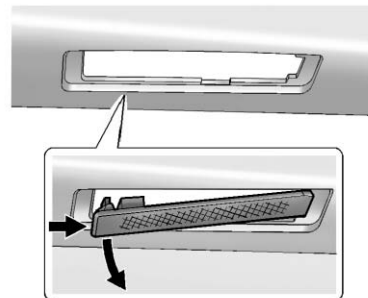

Passenger Side Shown, Driver Side Similar

2. Push the left end of the lamp assembly toward the right.
3. Turn the lamp assembly down to remove it from the liftgate.

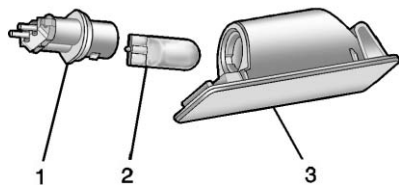

4. Turn the bulb socket (1) counterclockwise to remove it from the lamp assembly (3).
5. Pull the bulb (2) straight out of the bulb socket.
6. Push the replacement bulb straight into the bulb socket and turn the bulb socket clockwise to install it into the lamp assembly.

7. Turn the lamp assembly into the liftgate engaging the clip side first.
8. Push on the lamp side opposite the clip until the lamp assembly snaps into place.

Replacement Bulbs

Exterior Lamp	Bulb Number
Fog Lamp (Uplevel Only)	H11LL
License Plate Lamp	W5WLL

For replacement bulbs not listed here, contact your dealer.

Electrical System

Electrical System Overload

The vehicle has fuses and circuit breakers to protect against an electrical system overload.

When the current electrical load is too heavy, the circuit breaker opens and closes, protecting the circuit until the current load returns to normal or the problem is fixed. This greatly reduces the chance of circuit overload and fire caused by electrical problems.

Fuses and circuit breakers protect power devices in the vehicle.

Replace a bad fuse with a new one of the identical size and rating.

If there is a problem on the road and a fuse needs to be replaced, the same amperage fuse can be borrowed. Choose some feature of the vehicle that is not needed to use and replace it as soon as possible.

Headlamp Wiring

An electrical overload may cause the lamps to go on and off, or in some cases to remain off. Have the headlamp wiring checked right away if the lamps go on and off or remain off.

Windshield Wipers

If the wiper motor overheats due to heavy snow or ice, the windshield wipers will stop until the motor cools and will then restart.

Although the circuit is protected from electrical overload, overload due to heavy snow or ice may cause wiper linkage damage. Always clear ice and heavy snow from the windshield before using the windshield wipers.

If the overload is caused by an electrical problem and not snow or ice, be sure to get it fixed.

Fuses and Circuit Breakers

The wiring circuits in the vehicle are protected from short circuits by a combination of fuses and circuit breakers. This greatly reduces the chance of damage caused by electrical problems.

To check a fuse, look at the silver-colored band inside the fuse. If the band is broken or melted, replace the fuse. Be sure to replace a bad fuse with a new one of the identical size and rating.

Fuses of the same amperage can be temporarily borrowed from another fuse location, if a fuse goes out. Replace the fuse as soon as you can.

To identify and check fuses, circuit breakers, and relays, see *Engine Compartment Fuse Block (CTS Coupe)* on page 10-38 or *Engine Compartment Fuse Block (CTS Wagon)* on page 10-42 or *Engine Compartment Fuse Block (CTS-V Coupe and Sedan)* on page 10-46 or *Engine Compartment Fuse Block (CTS-V Wagon)* on page 10-49 and *Rear Compartment Fuse Block (CTS Wagon)* on page 10-53 or *Rear Compartment Fuse Block (CTS-V Wagon)* on page 10-55 or *Rear Compartment Fuse Block (CTS Coupe)* on page 10-57 or *Rear Compartment Fuse Block (CTS-V Coupe and Sedan)* on page 10-59.

Engine Compartment Fuse Block (CTS Coupe)

The underhood fuse block is on the left side of the engine compartment.

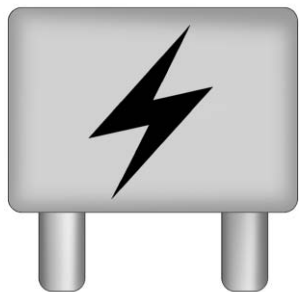

Lift the fuse block cover to access the fuses.

The vehicle may not be equipped with all of the fuses and relays shown.

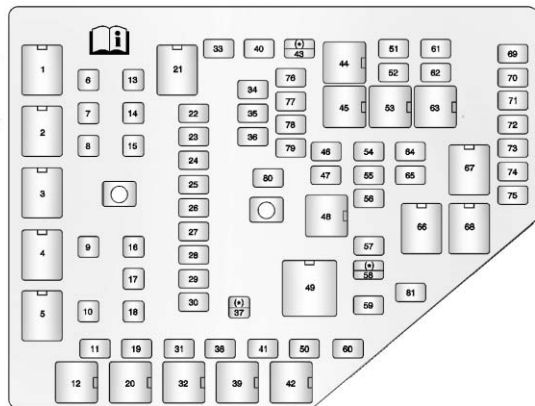
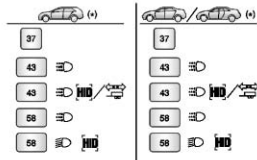

⚠ Caution

Spilling liquid on any electrical component on the vehicle may damage it. Always keep the covers on any electrical component.

Mini-Fuses	Usage
11	Not Used
19	Antilock Braking System (ABS)
22	Display
23	Not Used

Mini-Fuses	Usage
24	Body Control Module 1
25	Automatic Forward Lighting System (HID Only)
26	Body Control Module 5

10-40 Vehicle Care

Mini-Fuses	Usage
27	Body Control Module 4
28	Navigation Motor
29	All-Wheel Drive
30	Transmission Control Module Battery
31	Horn
33	Left Low-Beam Headlamp (Domestic Non-HID Only)
34	Pedestrian Protection System (Export Only)
35	Body Control Module 3
36	Body Control Module 2
38	Headlamp Washer (HID Only)

Mini-Fuses	Usage
40	Right Low-Beam Headlamp (Domestic Non-HID Only)
41	Air Conditioning Compressor Clutch
43	Low-Beam Daytime Running Lamps (non-HID), Left Daytime Running Lamps (HID), Left Trailer Turn Signal (Export Only)
46	Left High-Beam Headlamp
47	Right High-Beam Headlamp
50	Right Daytime Running Lamp, Windshield Washer Pump
51	Airbag System Ignition Switch

Mini-Fuses	Usage
52	Engine Control Module Ignition, Transmission Control Module Ignition
54	Power Moding (Immobilizer Module, Ignition Switch)
55	Not Used
56	Windshield Wipers
57	Right Low-Beam (HID Only)
58	Daytime Running Lamps (non-HID), Left Low-Beam (HID Only)
59	Right Daytime Running Lamp (HID Only), Right Trailer Turn Signal (Export Only)

Mini-Fuses	Usage
60	Instrument Panel Auxiliary Power Outlet
61	Air Quality Sensor, Inside Rear View Mirror, Rear Camera
62	Ignition
64	Steering Wheel Illumination
65	Front Fog Lamps (HID Only)
69	Body Control Module 6, Body Control Module 7
70	Emissions 1
71	Even Ignition Coils
72	Engine Control Module
73	Emissions 2
74	Odd Ignition Coils

Mini-Fuses	Usage
75	Transmission Output Speed Sensor, Brake Vacuum Relay
76	Spare
77	Spare
78	Spare
79	Spare
80	Spare
81	Spare

J-Case Fuses	Usage
6	Cooling Fan 2
7	Cooling Fan 1
8	Starter
9	Brake Vacuum Pump
10	Antilock Brake System Motor

J-Case Fuses	Usage
13	Not Used
14	Electric Parking Brake
15	Not Used
16	Not Used
17	Blower Motor
18	Rear Window Defogger
37	Not Used

Relays	Usage
1	Cooling Fan 2
2	Cooling Fan 1
3	Starter
4	Rear Window Defogger
5	Instrument Panel Auxiliary Power Outlet

Relays	Usage
12	Horn
20	Headlamp Washer (HID Only)
21	Cooling Fan (Series/Parallel)
32	Air Conditioning Compressor Clutch
39	Windshield Washer Pump
42	Right Daytime Running Lamp, Trailer Turn Signal
44	Low-Beam (non-HID), Left Daytime Running Lamps (HID), Left Trailer Turn Signal (Export Only)
45	Front Fog Lamps (HID Only)
48	High-Beam Headlamps

Relays	Usage
49	Daytime Running Lamps (Non-HID), Low-Beam Headlamps (HID)
53	Not Used
63	Main Ignition
66	Windshield Wipers
67	Powertrain
68	Windshield Wipers High Speed

Engine Compartment Fuse Block (CTS Wagon)

This fuse block is on the left side of the engine compartment.

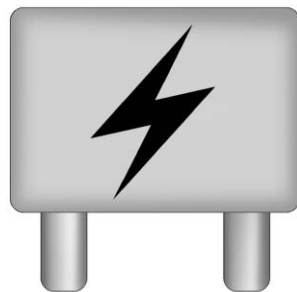

Lift the fuse block cover to access the fuses.

The vehicle may not be equipped with all of the fuses and relays shown.



Spilling liquid on any electrical component on the vehicle may damage it. Always keep the covers on any electrical component.

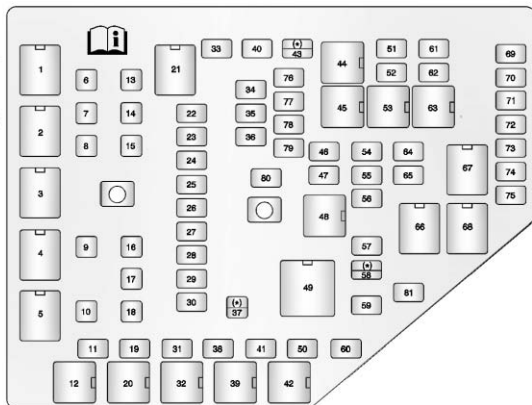
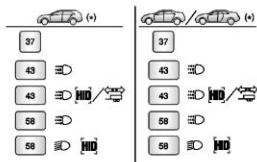

Mini-Fuses	Usage
11	Not Used
19	Antilock Braking System (ABS)
22	Display
23	Not Used

Mini-Fuses	Usage
24	Body Control Module 1
25	Automatic Forward Lighting System (HID Only)
26	Body Control Module 5

Mini-Fuses	Usage
27	Body Control Module 4
28	Navigation Motor
29	All-Wheel Drive
30	Transmission Control Module Battery
31	Horn
33	Left Low-Beam Headlamp (Domestic Non-HID Only)
34	Pedestrian Protection System (Export Only)
35	Body Control Module 3
36	Body Control Module 2
38	Headlamp Washer (HID Only)

10-44 Vehicle Care

Mini-Fuses	Usage
40	Right Low-Beam Headlamp (Domestic Non-HID Only)
41	Air Conditioning Compressor Clutch
43	Low-Beam Daytime Running Lamps (non-HID), Left Daytime Running Lamps (HID), Left Trailer Turn Signal (Export Only)
46	Left High-Beam Headlamp
47	Right High-Beam Headlamp
50	Right Daytime Running Lamp
51	Airbag System Ignition Switch

Mini-Fuses	Usage
52	Engine Control Module Ignition, Transmission Control Module Ignition
54	Power Moding (Immobilizer Module, Ignition Switch)
55	Not Used
56	Windshield Wipers
57	Right Low-Beam (HID Only)
58	Daytime Running Lamps (non-HID), Left Low-Beam (HID Only)
59	Right Daytime Running Lamp (HID Only), Right Trailer Turn Signal (Export Only)

Mini-Fuses	Usage
60	Instrument Panel Auxiliary Power Outlet
61	Air Quality Sensor, Inside Rear View Mirror, Rear Camera
62	Ignition
64	Steering Wheel Illumination
65	Front Fog Lamps (HID Only)
69	Body Control Module 6, Body Control Module 7
70	Emissions 1
71	Even Ignition Coils
72	Engine Control Module
73	Emissions 2
74	Odd Ignition Coils

Mini-Fuses	Usage
75	Transmission Output Speed Sensor, Brake Vacuum Relay
76	Spare
77	Spare
78	Spare
79	Spare
80	Spare
81	Spare

J-Case Fuses	Usage
6	Cooling Fan 2
7	Cooling Fan 1
8	Starter
9	Brake Vacuum Pump
10	Antilock Brake System Motor

J-Case Fuses	Usage
13	Not Used
14	Electric Parking Brake
15	Not Used
16	Not Used
17	Blower Motor
18	Transmission Control Module Battery
37	Trailer (Export Only)

Relays	Usage
1	Cooling Fan 2
2	Cooling Fan 1
3	Starter
4	Rear Window Defogger
5	Instrument Panel Auxiliary Power Outlet

Relays	Usage
12	Horn
20	Headlamp Washer (HID Only)
21	Cooling Fan (Series/Parallel)
32	Air Conditioning Compressor Clutch
39	Not Used
42	Right Daytime Running Lamp, Trailer Turn Signal
44	Low-Beam (non-HID), Left Daytime Running Lamps (HID), Left Trailer Turn Signal (Export Only)
45	Front Fog Lamps (HID Only)
48	High-Beam Headlamps

Relays	Usage
49	Daytime Running Lamps (Non-HID), Low-Beam Headlamps (HID)
53	Not Used
63	Main Ignition
66	Windshield Wipers
67	Powertrain
68	Windshield Wipers High Speed

Engine Compartment Fuse Block (CTS-V Coupe and Sedan)

This fuse block is on the left side of the engine compartment.

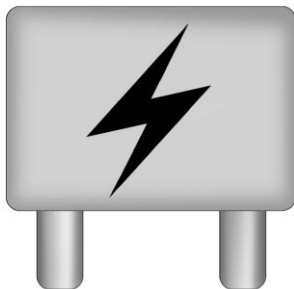

Lift the fuse block cover to access the fuses.

The vehicle may not be equipped with all of the fuses and relays shown.

Caution

Spilling liquid on any electrical component on the vehicle may damage it. Always keep the covers on any electrical component.

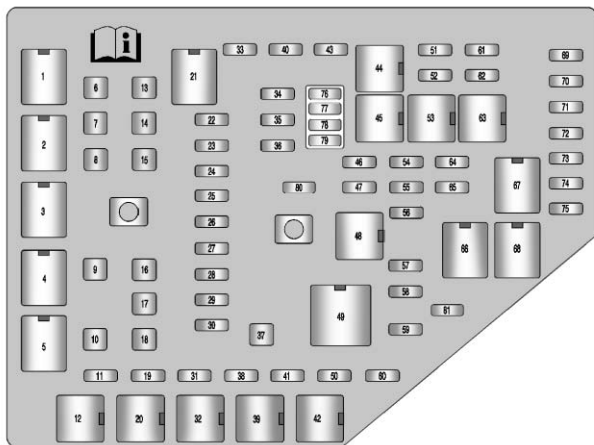

Mini-Fuses	Usage
11	Not Used
19	Antilock Braking System (ABS)
22	Display
23	Sunroof

Mini-Fuses	Usage
24	Body Control Module 1
25	Automatic Forward Lighting System (HID Only)
26	Body Control Module 5

Mini-Fuses	Usage
27	Body Control Module 4
28	Navigation Motor
29	Not Used
30	Transmission Control Module Battery
31	Horn
33	Not Used
34	Pedestrian Protection System (Export Only)
35	Body Control Module 3
36	Body Control Module 2
38	Headlamp Washer (HID Only)
40	Not Used
41	Air Conditioning Compressor Clutch

10-48 Vehicle Care

Mini-Fuses	Usage
43	Left Daytime Running Lamps (HID)
46	Left High-Beam Headlamp
47	Right High-Beam Headlamp
50	Right Daytime Running Lamp, Windshield Washer Pump
51	Airbag System Ignition Switch
52	Engine Control Module Ignition, Transmission Control Module Ignition
54	Power Moding (Immobilizer Module, Ignition Switch)
55	Intercooler Pump

Mini-Fuses	Usage
56	Windshield Wipers
57	Right Low-Beam (HID Only)
58	Left Low-Beam (HID Only)
59	Right Daytime Running Lamp (HID Only)
60	Instrument Panel Auxiliary Power Outlet
61	Air Quality Sensor, Inside Rear View Mirror, Rear Camera
62	Ignition
64	Steering Wheel Illumination
65	Front Fog Lamps (HID Only)

Mini-Fuses	Usage
69	Body Control Module 6, Body Control Module 7
70	Emissions 1
71	Even Ignition Coils
72	Odd Ignition Coils
73	Emissions 2
74	Engine Control Module
75	Not Used
76	Spare
77	Spare
78	Spare
79	Spare
80	Spare
81	Spare

J-Case Fuses	Usage
6	Cooling Fan 2
7	Cooling Fan 1
8	Starter
9	Not Used
10	Antilock Brake System Motor
13	Not Used
14	Electric Parking Brake
15	Not Used
16	Not Used
17	Blower Motor
18	Rear Window Defogger
37	Magnetic Ride/Suspension Control

Relays	Usage
1	Cooling Fan 2
2	Cooling Fan 1
3	Starter
4	Rear Window Defogger
5	Instrument Panel Auxiliary Power Outlet
12	Horn
20	Headlamp Washer (HID Only)
21	Cooling Fan (Series/Parallel)
32	Air Conditioning Compressor Clutch
39	Windshield Washer Pump
42	Right Daytime Running Lamp
44	Left Daytime Running Lamp (HID)

Relays	Usage
45	Front Fog Lamps (HID Only)
48	High-Beam Headlamps
49	Low-Beam Headlamps (HID)
53	Not Used
63	Main Ignition
66	Windshield Wipers
67	Powertrain
68	Windshield Wipers High Speed

Engine Compartment Fuse Block (CTS-V Wagon)

The underhood fuse block is on the left side of the engine compartment.

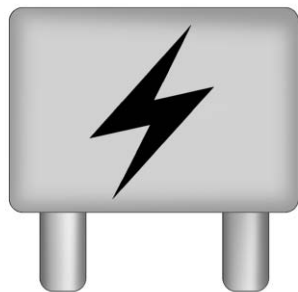

Lift the fuse block cover to access the fuses.

The vehicle may not be equipped with all of the fuses and relays shown.

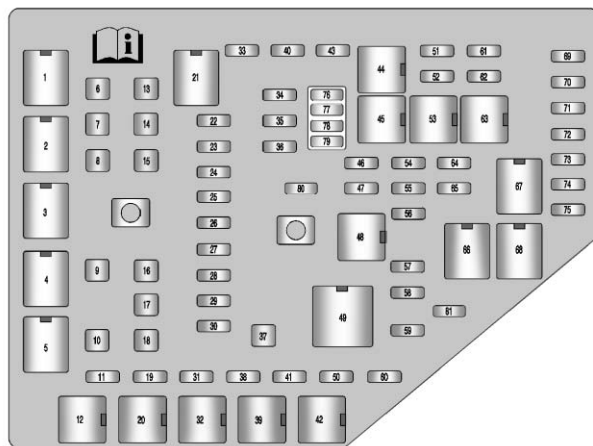

⚠ Caution

Spilling liquid on any electrical component on the vehicle may damage it. Always keep the covers on any electrical component.

Mini-Fuses	Usage
11	Not Used
19	Antilock Braking System (ABS)
22	Display
23	Sunroof

Mini-Fuses	Usage
24	Body Control Module 1
25	Automatic Forward Lighting System (HID Only)
26	Body Control Module 5

Mini-Fuses	Usage
27	Body Control Module 4
28	Navigation Motor
29	Not Used
30	Transmission Control Module Battery
31	Horn
33	Not Used
34	Pedestrian Protection System (Export Only)
35	Body Control Module 3
36	Body Control Module 2
38	Headlamp Washer (HID Only)
40	Not Used
41	Air Conditioning Compressor Clutch

Mini-Fuses	Usage
43	Left Daytime Running Lamp (HID)
46	Left High-Beam Headlamp
47	Right High-Beam Headlamp
50	Right Daytime Running Lamp
51	Airbag System Ignition Switch
52	Engine Control Module Ignition, Transmission Control Module Ignition
54	Power Moding (Immobilizer Module, Ignition Switch)
55	Intercooler Pump
56	Windshield Wipers

Mini-Fuses	Usage
57	Right Low-Beam (HID Only)
58	Left Low-Beam (HID Only)
59	Right Daytime Running Lamp (HID Only)
60	Instrument Panel Auxiliary Power Outlet
61	Air Quality Sensor, Inside Rear View Mirror, Rear Camera
62	Ignition
64	Steering Wheel Illumination
65	Front Fog Lamps (HID Only)
69	Body Control Module 6, Body Control Module 7

10-52 Vehicle Care

Mini-Fuses	Usage
70	Emissions 1
71	Even Ignition Coils
72	Odd Ignition Coils
73	Emissions 2
74	Engine Control Module
75	Not Used
76	Spare
77	Spare
78	Spare
79	Spare
80	Spare
81	Spare

J-Case Fuses	Usage
6	Cooling Fan 2
7	Cooling Fan 1
8	Starter

J-Case Fuses	Usage
9	Not Used
10	Antilock Brake System Motor
13	Not Used
14	Electric Parking Brake
15	Not Used
16	Not Used
17	Blower Motor
18	Rear Window Defogger
37	Magnetic Ride/Suspension Control

Relays	Usage
1	Cooling Fan 2
2	Cooling Fan 1
3	Starter

Relays	Usage
4	Rear Window Defogger
5	Instrument Panel Auxiliary Power Outlet
12	Horn
20	Headlamp Washer (HID Only)
21	Cooling Fan (Series/Parallel)
32	Air Conditioning Compressor Clutch
39	Not Used
42	Right Daytime Running Lamp
44	Left Daytime Running Lamp (HID)
45	Front Fog Lamps (HID Only)
48	High-Beam Headlamps

Relays	Usage
49	Low-Beam Headlamps (HID)
53	Not Used
63	Main Ignition
66	Windshield Wipers
67	Powertrain
68	Windshield Wipers High Speed

Rear Compartment Fuse Block (CTS Wagon)

This fuse block is on the right side of the vehicle, behind the trim panel in the rear compartment.

The vehicle may not be equipped with all of the fuses, relays, and features shown.

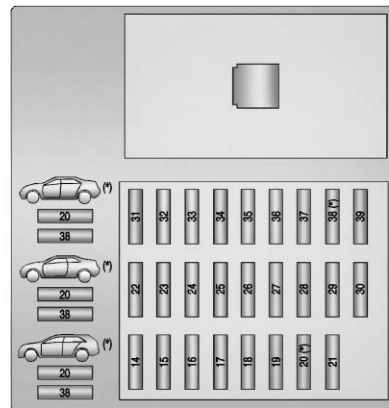
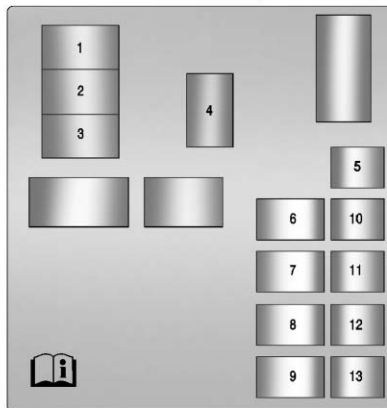

Relays	Usage
5	Stop Lamps (Export Only)
6	Door Lock
7	Door Unlock
8	Fuel Door Unlock (Export Only)

Relays	Usage
9	Right Position Lamp (Export Only)
10	Console/Auxiliary Power Outlet
11	Not Used

10-54 Vehicle Care

Relays	Usage
12	Side Marker Lamps
13	Left Position Lamps

Mini-Fuses	Usage
14	Right Position Lamp
15	Left Position Lamp
16	Door Lock
17	Console/Auxiliary Power Outlet
18	Rear Fog/Export Body Control Module (Export Only)
19	Rear Windshield Wiper/Washer
20	Windshield Washer Pump
21	Sunroof
22	Right Position Lamp (Export Only)

Mini-Fuses	Usage
23	Regulated Voltage Control Sensor
24	Audio System (Radio)
25	Airbag System
26	Remote Keyless Entry/PASS-Key® Theft Deterrent Module
27	Audio Speakers/Subwoofer
28	OnStar® System (If Equipped)
29	Engine Control Module
30	Canister Vent
31	Fuel Pump
33	Stop Lamps (Export Only)

Mini-Fuses	Usage
34	Theft Deterrent System/Universal Garage Door Opener
35	Memory Seat Module
36	Passenger Door Module
38	Rear Auxiliary Power Outlet
39	Amplifier

Circuit Breakers	Usage
1	Driver Power Seat Switch
2	Passenger Power Seat Switch
3	Power Windows
4	Power Steering Column

Circuit Breakers	Usage
32	Left Rear Window Switch
37	Right Rear Window Switch

Rear Compartment Fuse Block (CTS-V Wagon)

The rear compartment fuse block is on the passenger side of the vehicle, behind the trim panel in the rear compartment.

The vehicle may not be equipped with all of the fuses and relays shown.

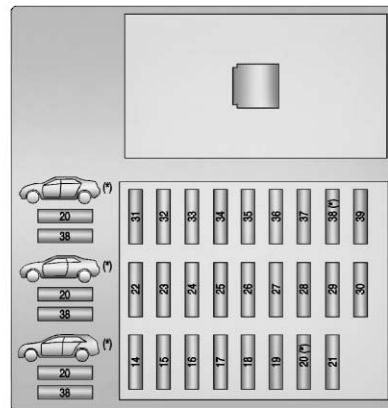
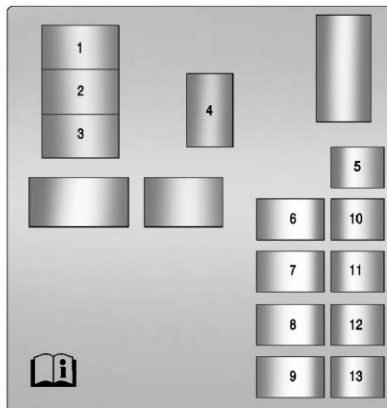

Relays	Usage
5	Stop Lamps (Export Only)
6	Door Lock
7	Door Unlock
8	Fuel Door Unlock (Export Only)

Relays	Usage
9	Right Position Lamp (Export Only)
10	Console/Auxiliary Power Outlet
11	Not Used

10-56 Vehicle Care

Relays	Usage
12	Side Marker Lamps
13	Left Position Lamps

Mini-Fuses	Usage
14	Right Position Lamp
15	Left Position Lamp
16	Door Lock
17	Console/Auxiliary Power Outlet
18	Rear Fog/Export Body Control Module (Export Only)
19	Rear Windshield Wiper/Washer
20	Windshield Washer Pump
21	Fuel Pump
22	Right Position Lamp (Export Only)

Mini-Fuses	Usage
23	Regulated Voltage Control Sensor
24	Audio System (Radio)
25	Airbag System
26	Remote Keyless Entry/PASS-Key [®] Theft Deterrent Module
27	Audio Speakers/Subwoofer
28	OnStar [®] System
29	Engine Control Module
30	Canister Vent
31	Rear Differential Cooling Pump
33	Stop Lamps (Export Only)

Mini-Fuses	Usage
34	Theft Deterrent System/Universal Garage Door Opener
35	Memory Seat Module
36	Passenger Door Module
38	Rear Auxiliary Power Outlet
39	Amplifier

Circuit Breakers	Usage
1	Driver Power Seat Switch
2	Passenger Power Seat Switch
3	Power Windows
4	Power Steering Column

Circuit Breakers	Usage
32	Left Rear Window Switch
37	Right Rear Window Switch

Rear Compartment Fuse Block (CTS Coupe)

The rear compartment fuse block is on top of the battery, on the right side of the trunk. The battery access door must be removed to access the fuse block.

The vehicle may not be equipped with all of the fuses, relays, and features shown.

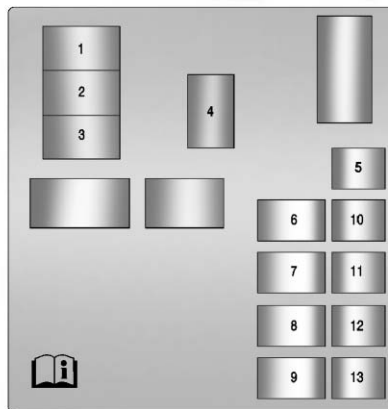

Relays	Usage
5	Stop Lamps (Export Only)
6	Door Lock
7	Door Unlock
8	Fuel Door Unlock (Export Only)

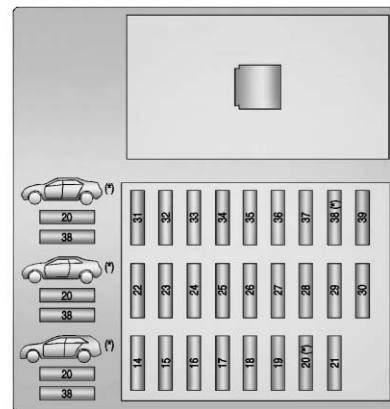

Relays	Usage
9	Right Position Lamp (Export Only)
10	Console/Auxiliary Power Outlet

10-58 Vehicle Care

Relays	Usage
11	Sedan Trunk Release/Coupe Rear Fog (Export Only)
12	Side Marker Lamps
13	Left Position Lamps

Mini-Fuses	Usage
14	Right Position Lamp
15	Left Position Lamp
16	Door Lock
17	Console/Auxiliary Power Outlet
18	Rear Fog/Export Body Control Module (Export Only)
19	Trunk Release
20	Easy Entry Seats (Coupe Only)
21	Sunroof

Mini-Fuses	Usage
22	Right Position Lamp (Export Only)
23	Regulated Voltage Control Sensor
24	Audio System (Radio)
25	Airbag System
26	Remote Keyless Entry/PASS-Key® Theft Deterrent Module
27	Audio Speakers/Subwoofer
28	OnStar® System (If Equipped)
29	Engine Control Module
30	Canister Vent
31	Fuel Pump
33	Stop Lamps (Export Only)

Mini-Fuses	Usage
34	Theft Deterrent System/Universal Garage Door Opener
35	Memory Seat Module
36	Passenger Door Module
38	Side Blind Zone Alert (Coupe Only)
39	Amplifier

Circuit Breakers	Usage
1	Driver Power Seat Switch
2	Passenger Power Seat Switch
3	Power Windows
4	Power Steering Column

Circuit Breakers	Usage
32	Left Rear Window Switch
37	Right Rear Window Switch

Rear Compartment Fuse Block (CTS-V Coupe and Sedan)

The rear compartment fuse block is on top of the battery, on the right side of the trunk. The battery access door must be removed to access the fuse block.

The vehicle may not be equipped with all of the fuses, relays, and features shown.

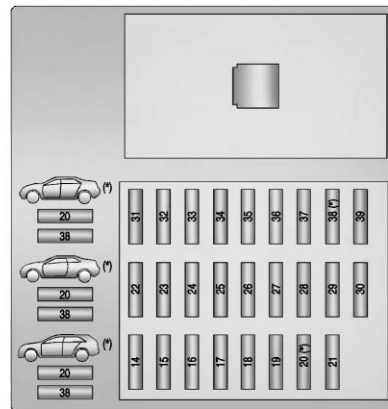
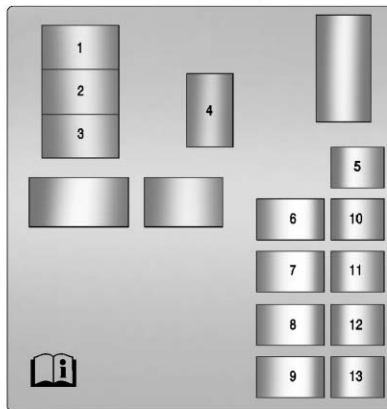

Relays	Usage
5	Stop Lamps (Export Only)
6	Door Lock
7	Door Unlock
8	Fuel Door Unlock (Export Only)

Relays	Usage
9	Right Position Lamp (Export Only)
10	Console/Auxiliary Power Outlet

10-60 Vehicle Care

Relays	Usage
11	Sedan Trunk Release/Coupe Rear Fog (Export Only)
12	Side Marker Lamps
13	Left Position Lamps

Mini-Fuses	Usage
14	Right Position Lamp
15	Left Position Lamp
16	Door Lock
17	Console/Auxiliary Power Outlet
18	Rear Fog/Export Body Control Module (Export Only)
19	Trunk Release
20	Easy Entry Seats (Coupe Only)
21	Fuel Pump

Mini-Fuses	Usage
22	Right Position Lamp (Export Only)
23	Regulated Voltage Control Sensor
24	Audio System (Radio)
25	Airbag System
26	Remote Keyless Entry/PASS-Key [®] Theft Deterrent Module
27	Audio Speakers/Subwoofer
28	OnStar [®] System (If Equipped)
29	Engine Control Module
30	Canister Vent
31	Rear Differential Cooling Pump
33	Stop Lamps (Export Only)

Mini-Fuses	Usage
34	Theft Deterrent System/Universal Garage Door Opener
35	Memory Seat Module
36	Passenger Door Module
38	Side Blind Zone Alert (Coupe Only)
39	Amplifier

Circuit Breakers	Usage
1	Driver Power Seat Switch
2	Passenger Power Seat Switch
3	Power Windows
4	Power Steering Column

Circuit Breakers	Usage
32	Left Rear Window Switch
37	Right Rear Window Switch

Wheels and Tires

Tires

Every new GM vehicle has high-quality tires made by a leading tire manufacturer. See the warranty manual for information regarding the tire warranty and where to get service. For additional information refer to the tire manufacturer.

Warning

- Poorly maintained and improperly used tires are dangerous.
- Overloading the tires can cause overheating as a result of too much flexing. There could be a blowout and a serious crash. See *Vehicle Load Limits on page 9-11*.
- Underinflated tires pose the same danger as overloaded tires. The resulting crash could cause serious injury. Check all tires frequently to maintain the recommended pressure. Tire pressure should be checked when the tires are cold.

(Continued)

Warning (Continued)

- Overinflated tires are more likely to be cut, punctured, or broken by a sudden impact — such as when hitting a pothole. Keep tires at the recommended pressure.
- Worn or old tires can cause a crash. If the tread is badly worn, replace them.
- Replace any tires that have been damaged by impacts with potholes, curbs, etc.
- Improperly repaired tires can cause a crash. Only the dealer or an authorized tire service

(Continued)

Warning (Continued)

- center should repair, replace, dismount, and mount the tires.
- Do not spin the tires in excess of 56 km/h (35 mph) on slippery surfaces such as snow, mud, ice, etc. Excessive spinning may cause the tires to explode.

See *Tire Pressure for High-Speed Operation on page 10-71* for inflation pressure adjustment for high-speed driving.

All-Season Tires

This vehicle may come with all-season tires. These tires are designed to provide good overall performance on most road surfaces and weather conditions. Original equipment tires designed to GM's specific tire performance criteria have a TPC specification code molded onto the sidewall. Original equipment all-season tires can be identified by the last two characters of this TPC code, which will be "MS."

Consider installing winter tires on the vehicle if frequent driving on snow or ice-covered roads is expected. All-season tires provide adequate performance for most winter driving conditions, but they may not offer the same level of traction or performance as winter tires on snow or ice-covered roads. See *Winter Tires on page 10-63*.

Winter Tires

This vehicle was not originally equipped with winter tires. Winter tires are designed for increased traction on snow and ice-covered roads. Consider installing winter tires on the vehicle if frequent driving on snow or ice-covered roads is expected. See your dealer for details regarding winter tire availability and proper tire selection. Also, see *Buying New Tires* on page 10-79.

With winter tires, there may be decreased dry road traction, increased road noise, and shorter tread life. After changing to winter tires, be alert for changes in vehicle handling and braking.

If using winter tires:

- Use tires of the same brand and tread type on all four wheel positions.

- Use only radial ply tires of the same size, load range, and speed rating as the original equipment tires.

Winter tires with the same speed rating as the original equipment tires may not be available for H, V, W, Y, and ZR speed rated tires. If winter tires with a lower speed rating are chosen, never exceed the tire's maximum speed capability.

Low-Profile Tires

If the vehicle has P235/50R18, 245/45ZR19, P245/45R19, 255/40ZR19, P265/45R18, 275/40ZR19 or 285/35ZR19 size tires, they are classified as low-profile tires. These tires are designed for very responsive driving on wet or dry pavement, however, may produce more road noise and tend to wear faster.

Caution

Low-profile tires are more susceptible to damage from road hazards or curb impact than standard profile tires. Tire and/or wheel assembly damage can occur when coming into contact with road hazards like potholes, or sharp edged objects, or when sliding into a curb. The warranty does not cover this type of damage. Keep tires set to the correct inflation pressure and when possible, avoid contact with curbs, potholes, and other road hazards.

Summer Performance Tires

Many General Motors high performance models come factory-equipped with tires that are optimized for maximum dry and wet road performance while still retaining satisfactory tread life, excellent durability, and low noise levels. In severe winter climates where snowfall may be significant, these tires may be found to provide less traction.

Summer Tires

This vehicle may come with high performance summer tires. These tires have a special tread and compound that are optimized for maximum dry and wet road performance. This special tread and compound will decrease performance in cold climates, and on ice and snow. We recommend installing winter tires on the vehicle if frequent driving in cold

temperatures or on snow or ice covered roads is expected. See *Winter Tires* on page 10-63.

Tire Sidewall Labeling

Useful information about a tire is molded into its sidewall. The examples show a typical passenger vehicle tire and a compact spare tire sidewall.

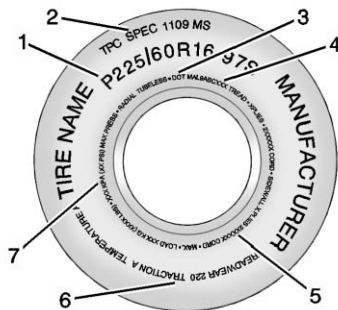

Passenger (P-Metric) Tire Example

(1) Tire Size: The tire size is a combination of letters and numbers used to define a

particular tire's width, height, aspect ratio, construction type, and service description. See the "Tire Size" illustration later in this section.

(2) TPC Spec (Tire Performance Criteria Specification): Original equipment tires designed to GM's specific tire performance criteria have a TPC specification code molded onto the sidewall. GM's TPC specifications meet or exceed all federal safety guidelines.

(3) DOT (Department of Transportation): The Department of Transportation (DOT) code indicates that the tire is in compliance with the U.S. Department of Transportation Motor Vehicle Safety Standards.

DOT Tire Date of

Manufacture: The last four digits of the TIN indicate the tire manufactured date. The first two digits represent the week (01–52) and the last two digits, the year. For example, the third week of the year 2010 would have a four-digit DOT date of 0310.

(4) Tire Identification Number (TIN): The letters and numbers following the DOT (Department of Transportation) code are the Tire Identification Number (TIN). The TIN shows the manufacturer and plant code, tire size, and date the tire was manufactured. The TIN is molded onto both sides of the tire, although only one side may have the date of manufacture.

(5) Tire Ply Material: The type of cord and number of plies in the sidewall and under the tread.

(6) Uniform Tire Quality Grading (UTQG): Tire manufacturers are required to grade tires based on three performance factors: treadwear, traction, and temperature resistance. For more information see *Uniform Tire Quality Grading on page 10-82*.

(7) Maximum Cold Inflation Load Limit: Maximum load that can be carried and the maximum pressure needed to support that load.

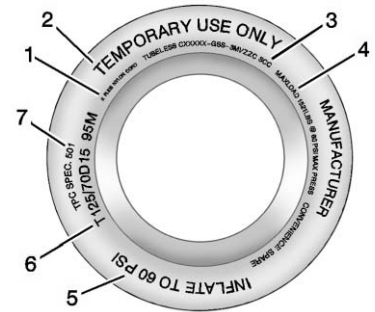

Compact Spare Tire Example

(1) Tire Ply Material: The type of cord and number of plies in the sidewall and under the tread.

(2) Temporary Use Only: The compact spare tire or temporary use tire should not be driven at speeds over 80 km/h (50 mph). The compact spare tire is for emergency use when a regular road tire has lost air and gone flat. If the vehicle has a compact spare tire, see *Compact Spare Tire on page 10-104* and *If a Tire Goes Flat on page 10-85*.

(3) Tire Identification Number (TIN): The letters and numbers following the DOT (Department of Transportation) code are the Tire Identification Number (TIN). The TIN shows the manufacturer and plant code, tire size, and date the tire was manufactured. The TIN is molded onto both sides of the tire, although only one side may have the date of manufacture.

(4) Maximum Cold Inflation Load Limit: Maximum load that can be carried and the maximum pressure needed to support that load.

(5) Tire Inflation: The temporary use tire or compact spare tire should be inflated to 420 kPa (60 psi). For more information on tire pressure and inflation see *Tire Pressure on page 10-70*.

(6) Tire Size: A combination of letters and numbers define a tire's width, height, aspect ratio, construction type, and service description. The letter T as the first character in the tire size means the tire is for temporary use only.

(7) TPC Spec (Tire Performance Criteria Specification): Original equipment tires designed to GM's specific tire performance criteria have a TPC specification code molded onto the sidewall. GM's TPC specifications meet or exceed all federal safety guidelines.

Tire Designations

Tire Size

The following is an example of a typical passenger vehicle tire size.

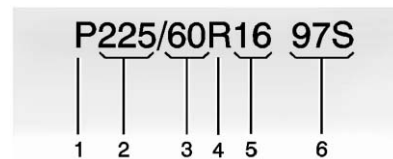

(1) Passenger (P-Metric) Tire:

The United States version of a metric tire sizing system. The letter P as the first character in the tire size means a passenger vehicle tire engineered to standards set by the U.S. Tire and Rim Association.

(2) Tire Width: The three-digit number indicates the tire section width in millimeters from sidewall to sidewall.

(3) Aspect Ratio: A two-digit number that indicates the tire height-to-width measurements. For example, if the tire size aspect ratio is 60, as shown in item 3 of the illustration, it would mean that the tire's sidewall is 60 percent as high as it is wide.

(4) Construction Code: A letter code is used to indicate the type of ply construction in the tire. The letter R means radial ply construction; the letter D means

diagonal or bias ply construction; and the letter B means belted-bias ply construction.

(5) Rim Diameter: Diameter of the wheel in inches.

(6) Service Description: These characters represent the load index and speed rating of the tire. The load index represents the load carrying capacity a tire is certified to carry. The speed rating is the maximum speed a tire is certified to carry a load.

Tire Terminology and Definitions

Air Pressure: The amount of air inside the tire pressing outward on each square inch of the tire. Air pressure is expressed in kPa (kilopascal) or psi (pounds per square inch).

Accessory Weight: The combined weight of optional accessories. Some examples of optional accessories are automatic transmission, power windows, power seats, and air conditioning.

Aspect Ratio: The relationship of a tire's height to its width.

Belt: A rubber coated layer of cords between the plies and the tread. Cords may be made from steel or other reinforcing materials.

Bead: The tire bead contains steel wires wrapped by steel cords that hold the tire onto the rim.

Bias Ply Tire: A pneumatic tire in which the plies are laid at alternate angles less than 90 degrees to the centerline of the tread.

Cold Tire Pressure: The amount of air pressure in a tire, measured in kPa (kilopascal) or psi (pounds per square inch) before a tire has built up heat from driving. See *Tire Pressure on page 10-70*.

Curb Weight: The weight of a motor vehicle with standard and optional equipment including the maximum capacity of fuel, oil, and coolant, but without passengers and cargo.

DOT Markings: A code molded into the sidewall of a tire signifying that the tire is in compliance with the U.S. Department of Transportation (DOT) Motor Vehicle Safety Standards. The DOT code includes the Tire Identification Number (TIN), an alphanumeric designator which can also

identify the tire manufacturer, production plant, brand, and date of production.

GVWR: Gross Vehicle Weight Rating. See *Vehicle Load Limits on page 9-11*.

GAWR FRT: Gross Axle Weight Rating for the front axle. See *Vehicle Load Limits on page 9-11*.

GAWR RR: Gross Axle Weight Rating for the rear axle. See *Vehicle Load Limits on page 9-11*.

Intended Outboard Sidewall: The side of an asymmetrical tire that must always face outward when mounted on a vehicle.

Kilopascal (kPa): The metric unit for air pressure.

Light Truck (LT-Metric) Tire: A tire used on light duty trucks and some multipurpose passenger vehicles.

Load Index: An assigned number ranging from 1 to 279 that corresponds to the load carrying capacity of a tire.

Maximum Inflation Pressure: The maximum air pressure to which a cold tire can be inflated. The maximum air pressure is molded onto the sidewall.

Maximum Load Rating: The load rating for a tire at the maximum permissible inflation pressure for that tire.

Maximum Loaded Vehicle Weight: The sum of curb weight, accessory weight, vehicle capacity weight, and production options weight.

Normal Occupant Weight: The number of occupants a vehicle is designed to seat multiplied by 68 kg (150 lb). See *Vehicle Load Limits on page 9-11*.

Occupant Distribution:

Designated seating positions.

Outward Facing Sidewall: The side of an asymmetrical tire that has a particular side that faces outward when mounted on a vehicle. The side of the tire that contains a whitewall, bears white lettering, or bears manufacturer, brand, and/or model name molding that is higher or deeper than the same moldings on the other sidewall of the tire.

Passenger (P-Metric) Tire: A tire used on passenger cars and some light duty trucks and multipurpose vehicles.

Recommended Inflation

Pressure: Vehicle manufacturer's recommended tire inflation pressure as shown on the tire placard. See *Tire Pressure on page 10-70* and *Vehicle Load Limits on page 9-11*.

Radial Ply Tire: A pneumatic tire in which the ply cords that extend to the beads are laid at 90 degrees to the centerline of the tread.

Rim: A metal support for a tire and upon which the tire beads are seated.

Sidewall: The portion of a tire between the tread and the bead.

Speed Rating: An alphanumeric code assigned to a tire indicating the maximum speed at which a tire can operate.

Traction: The friction between the tire and the road surface. The amount of grip provided.

Tread: The portion of a tire that comes into contact with the road.

Treadwear Indicators: Narrow bands, sometimes called wear bars, that show across the tread of a tire when only 1.6 mm (1/16 in) of tread remains. See *When It Is Time for New Tires on page 10-78*.

UTQGS (Uniform Tire Quality Grading Standards): A tire information system that provides consumers with ratings for a tire's traction, temperature, and treadwear. Ratings are determined by tire manufacturers using government testing procedures.

The ratings are molded into the sidewall of the tire. See *Uniform Tire Quality Grading on page 10-82*.

Vehicle Capacity Weight: The number of designated seating positions multiplied by 68 kg (150 lb) plus the rated cargo load. See *Vehicle Load Limits on page 9-11*.

Vehicle Maximum Load on the Tire: Load on an individual tire due to curb weight, accessory weight, occupant weight, and cargo weight.

Vehicle Placard: A label permanently attached to a vehicle showing the vehicle capacity weight and the original equipment tire size and recommended inflation pressure. See "Tire and Loading Information Label" under *Vehicle Load Limits on page 9-11*.

Tire Pressure

Tires need the correct amount of air pressure to operate effectively.

Caution

Neither tire underinflation nor overinflation is good. Underinflated tires, or tires that do not have enough air, can result in:

- Tire overloading and overheating which could lead to a blowout.
- Premature or irregular wear.
- Poor handling.
- Reduced fuel economy.

(Continued)

Caution (Continued)

Overinflated tires, or tires that have too much air, can result in:

- Unusual wear.
- Poor handling.
- Rough ride.
- Needless damage from road hazards.

The Tire and Loading Information label on the vehicle indicates the original equipment tires and the correct cold tire inflation pressures. The recommended pressure is the minimum air pressure needed to support the vehicle's maximum load carrying capacity. See *Vehicle Load Limits on page 9-11*.

How the vehicle is loaded affects vehicle handling and ride comfort. Never load the vehicle with more weight than it was designed to carry.

When to Check

Check the tires once a month or more. Do not forget the compact spare, if the vehicle has one. The cold compact spare tire pressure should be at 420 kPa (60 psi). See *Compact Spare Tire* on page 10-104.

How to Check

Use a good quality pocket-type gauge to check tire pressure. Proper tire inflation cannot be determined by looking at the tire. Check the tire inflation pressure when the tires are cold, meaning the vehicle has not been driven for at least three hours or no more than 1.6 km (1 mi).

Remove the valve cap from the tire valve stem. Press the tire gauge firmly onto the valve to get a pressure measurement. If the cold tire inflation pressure matches the recommended pressure on the Tire and Loading Information label, no further adjustment is necessary. If the inflation pressure is low, add air until the recommended pressure is reached. If the inflation pressure is high, press on the metal stem in the center of the tire valve to release air.

Recheck the tire pressure with the tire gauge.

Return the valve caps on the valve stems to prevent leaks and keep out dirt and moisture.

Tire Pressure for High-Speed Operation

Warning

Driving at high speeds, 160 km/h (100 mph) or higher, puts an additional strain on tires. Sustained high-speed driving causes excessive heat buildup and can cause sudden tire failure. You could have a crash and you or others could be killed. Some high-speed rated tires require inflation pressure adjustment for high-speed operation. When speed limits and road conditions are such that a vehicle can be driven at high speeds, make sure the tires are rated for high-speed operation, in excellent condition, and set to the correct cold tire inflation pressure for the vehicle load.

Vehicles with 255/40ZR19 or 285/35ZR19 size tires require inflation pressure adjustment when driving the vehicle at speeds of 160 km/h (100 mph) or higher. Set the cold inflation pressure to the maximum inflation pressure shown on the tire sidewall, or 300 kPa (44 psi), whichever is lower. See the example following. Return the tires to the recommended cold tire inflation pressure when high-speed driving has ended. See *Vehicle Load Limits* on page 9-11 and *Tire Pressure* on page 10-70.

Example:

The maximum load and inflation pressure is molded on the tire sidewall, in small letters, near the rim flange. It will read something like this: Maximum load 690 kg (1521 lbs) 300 kPa (44 psi) Max. Press.

For this example, set the inflation pressure for high-speed driving at 300 kPa (44 psi).

Tire Pressure Monitor System

The Tire Pressure Monitor System (TPMS) uses radio and sensor technology to check tire pressure levels. The TPMS sensors monitor the air pressure in your tires and transmit tire pressure readings to a receiver located in the vehicle.

Each tire, including the spare (if provided), should be checked monthly when cold and inflated to the inflation pressure recommended by the vehicle manufacturer on the vehicle placard or tire inflation pressure label. (If your vehicle has tires of a different size than the size indicated on the vehicle placard or tire inflation pressure label, you should determine the proper tire inflation pressure for those tires.)

As an added safety feature, your vehicle has been equipped with a tire pressure monitoring system (TPMS) that illuminates a low tire

pressure telltale when one or more of your tires is significantly under-inflated.

Accordingly, when the low tire pressure telltale illuminates, you should stop and check your tires as soon as possible, and inflate them to the proper pressure. Driving on a significantly under-inflated tire causes the tire to overheat and can lead to tire failure. Under-inflation also reduces fuel efficiency and tire tread life, and may affect the vehicle's handling and stopping ability.

Please note that the TPMS is not a substitute for proper tire maintenance, and it is the driver's responsibility to maintain correct tire pressure, even if under-inflation has not reached the level to trigger illumination of the TPMS low tire pressure telltale.

Your vehicle has also been equipped with a TPMS malfunction indicator to indicate when the system is not operating properly.

The TPMS malfunction indicator is combined with the low tire pressure telltale. When the system detects a malfunction, the telltale will flash for approximately one minute and then remain continuously illuminated.

This sequence will continue upon subsequent vehicle start-ups as long as the malfunction exists.

When the malfunction indicator is illuminated, the system may not be able to detect or signal low tire pressure as intended. TPMS malfunctions may occur for a variety of reasons, including the installation of replacement or alternate tires or wheels on the vehicle that prevent the TPMS from functioning properly. Always check the TPMS malfunction telltale after replacing one or more tires or wheels on your vehicle to ensure that the replacement or alternate tires and wheels allow the TPMS to continue to function properly.

See *Tire Pressure Monitor Operation* on page 10-73.

See *Radio Frequency Statement* on page 13-15.

Tire Pressure Monitor Operation

This vehicle may have a Tire Pressure Monitor System (TPMS). The TPMS is designed to warn the driver when a low tire pressure condition exists. TPMS sensors are mounted onto each tire and wheel assembly, excluding the spare tire and wheel assembly, if the vehicle has one. The TPMS sensors monitor the air pressure in the tires and transmits the tire pressure readings to a receiver located in the vehicle.



When a low tire pressure condition is detected, the TPMS illuminates the low tire pressure warning light located on the instrument cluster. If the warning light comes on, stop as soon as possible and inflate the tires to the recommended pressure shown on the tire loading information label. See *Vehicle Load Limits* on page 9-11.

A message to check the pressure in a specific tire displays in the DIC display screen. The low tire pressure warning light and the DIC warning message come at each ignition cycle until the tires are inflated to the correct inflation pressure. Using the Driver Information Center (DIC), tire pressure levels can be viewed. For additional information and details about the DIC operation and displays see *Driver Information Center (DIC)* on page 5-27 and *Tire Messages* on page 5-44.

The low tire pressure warning light may come on in cool weather when the vehicle is first started, and then turn off as the vehicle is driven. This could be an early indicator that the air pressure is getting low and needs to be inflated to the proper pressure.

The Tire and Loading Information label shows the size of the original equipment tires and the correct inflation pressure for the tires when they are cold. See *Vehicle Load Limits on page 9-11*, for an example of the Tire and Loading Information label and its location. Also see *Tire Pressure on page 10-70*.

The TPMS can warn about a low tire pressure condition but it does not replace normal tire maintenance. See *Tire Inspection on page 10-76*, *Tire Rotation on page 10-76* and *Tires on page 10-61*.

Caution

Tire sealant materials are not all the same. A non-approved tire sealant could damage the TPMS sensors. TPMS sensor damage caused by using an incorrect tire sealant is not covered by the vehicle warranty. Always use only the GM approved tire sealant available through your dealer or included in the vehicle.

Factory-installed Tire Inflator Kits use a GM approved liquid tire sealant. Using non-approved tire sealants could damage the TPMS sensors. See *Tire Sealant and Compressor Kit on page 10-86* for information regarding the inflator kit materials and instructions.

TPMS Malfunction Light and Message

The TPMS will not function properly if one or more of the TPMS sensors are missing or inoperable. When the system detects a malfunction, the low tire warning light flashes for about one minute and then stays on for the remainder of the ignition cycle. A DIC warning message also displays. The malfunction light and DIC warning message come on at each ignition cycle until the problem is corrected. Some of the conditions that can cause these to come on are:

- One of the road tires has been replaced with the spare tire, if the vehicle has one. The spare tire does not have a TPMS sensor. The malfunction light and the DIC message should go off after the road tire is replaced and the sensor matching process is performed successfully. See “TPMS Sensor Matching Process” later in this section.

- The TPMS sensor matching process was not done or not completed successfully after rotating the tires. The malfunction light and the DIC message should go off after successfully completing the sensor matching process. See “TPMS Sensor Matching Process” later in this section.
- One or more TPMS sensors are missing or damaged. The malfunction light and the DIC message should go off when the TPMS sensors are installed and the sensor matching process is performed successfully. See your dealer for service.
- Replacement tires or wheels do not match the original equipment tires or wheels. Tires and wheels other than those recommended could prevent the TPMS from functioning properly. See *Buying New Tires* on page 10-79.

- Operating electronic devices or being near facilities using radio wave frequencies similar to the TPMS could cause the TPMS sensors to malfunction.

If the TPMS is not functioning properly, it cannot detect or signal a low tire condition. See your dealer for service if the TPMS malfunction light and DIC message comes on and stays on.

TPMS Sensor Matching Process

Each TPMS sensor has a unique identification code. The identification code needs to be matched to a new tire/wheel position after rotating the vehicle’s tires or replacing one or more of the TPMS sensors. Also, the TPMS sensor matching process should be performed after replacing a spare tire with a road tire containing the TPMS sensor. The malfunction light and the DIC message should go off at the next ignition cycle. The sensors are matched to the tire/wheel positions,

using a TPMS relearn tool, in the following order: driver side front tire, passenger side front tire, passenger side rear tire, and driver side rear. See your dealer for service or to purchase a relearn tool.

There are two minutes to match the first tire/wheel position, and five minutes overall to match all four tire/wheel positions. If it takes longer, the matching process stops and must be restarted.

The TPMS matching process is:

1. Set the parking brake.
2. Turn the ignition to ON/RUN with the engine off.
3. Press the Remote Keyless Entry (RKE) transmitter’s lock and unlock buttons at the same time for approximately five seconds. The horn sounds twice to signal the receiver is in relearn mode and Tire Learning Active message displays on the DIC screen.

4. Start with the driver side front tire.
5. Place the relearn tool against the tire sidewall, near the valve stem. Then press the button to activate the TPMS sensor. A horn chirp confirms that the sensor identification code has been matched to this tire and wheel position.
6. Proceed to the passenger side front tire, and repeat the procedure in Step 5.
7. Proceed to the passenger side rear tire, and repeat the procedure in Step 5.
8. Proceed to the driver side rear tire, and repeat the procedure in Step 5. After hearing the confirming horn chirp, for the driver side rear tire, the horn sounds two more times to signal the tire learning mode is no longer active.

9. Turn the ignition to LOCK/OFF.
10. Set all four tires to the recommended air pressure level as indicated on the tire and loading information label.

Tire Inspection

We recommend that the tires, including the spare tire, if the vehicle has one, be inspected for signs of wear or damage at least once a month.

Replace the tire if:

- The indicators at three or more places around the tire can be seen.
- There is cord or fabric showing through the tire's rubber.

- The tread or sidewall is cracked, cut, or snagged deep enough to show cord or fabric.
- The tire has a bump, bulge, or split.
- The tire has a puncture, cut, or other damage that cannot be repaired well because of the size or location of the damage.

Tire Rotation

If the vehicle has non-directional tires, they should be rotated every 12 000 km/7,500 mi. See *Maintenance Schedule on page 11-4*.

Tires are rotated to achieve a uniform wear for all tires. The first rotation is the most important.

Anytime unusual wear is noticed, rotate the tires as soon as possible, check for proper tire inflation pressure, and check for damaged tires or wheels. If the unusual wear continues after the rotation, check the wheel alignment. See *When It Is Time for New Tires* on page 10-78 and *Wheel Replacement* on page 10-83.

Directional tires should not be rotated. Each tire and wheel should be used only in the position it is in. Directional tires will have an arrow on the tire indicating the proper direction of rotation or will have "left" or "right" molded on the sidewall.

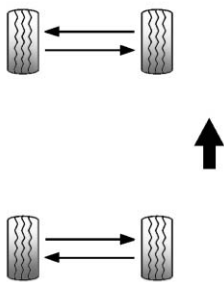

Use this rotation pattern if the vehicle has different size tires on the front and rear and they are non-directional.

Different tire sizes should not be rotated front to rear.

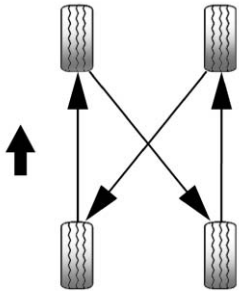

Use this rotation pattern when rotating tires of the same size installed on all four wheel positions.

If the vehicle has a compact spare tire, do not include it in the tire rotation.

Adjust the front and rear tires to the recommended inflation pressure on the Tire and Loading Information label after the tires have been rotated. See *Tire Pressure on page 10-70* and *Vehicle Load Limits on page 9-11*.

Reset the Tire Pressure Monitor System. See *Tire Pressure Monitor Operation on page 10-73*.

Check that all wheel nuts are properly tightened. See “Wheel Nut Torque” under *Capacities and Specifications on page 12-2*.

Warning

Rust or dirt on a wheel, or on the parts to which it is fastened, can make wheel nuts become loose after time. The wheel could come off and cause an accident. When changing a wheel, remove any rust or dirt from places where the wheel attaches to the vehicle. In an emergency, a cloth or a paper towel can be used; however, use a scraper or wire brush later to remove all rust or dirt.

Lightly coat the center of the wheel hub with wheel bearing grease after a wheel change or tire rotation to prevent corrosion or rust build-up. Do not get grease on the flat wheel mounting surface or on the wheel nuts or bolts.

When It Is Time for New Tires

Factors such as maintenance, temperatures, driving speeds, vehicle loading, and road conditions affect the wear rate of the tires.

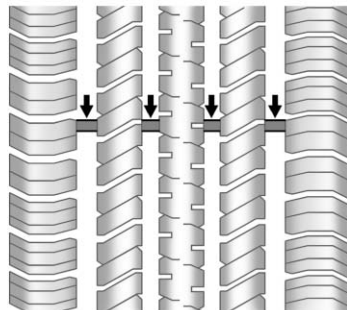

Treadwear indicators are one way to tell when it is time for new tires. Treadwear indicators appear when the tires have only 1.6 mm (1/16 in) or less of tread remaining. See *Tire Inspection on page 10-76* and *Tire Rotation on page 10-76*.

The rubber in tires ages over time. This also applies to the spare tire, if the vehicle has one, even if it is never used. Multiple factors including temperatures, loading conditions, and inflation pressure maintenance affect how fast aging takes place. GM recommends that tires, including the spare if equipped, be replaced after six years, regardless of tread wear. The tire manufacturer date is the last four digits of the DOT Tire Identification Number (TIN) which is molded into one side of the tire sidewall. The first two digits represent the week (01–52) and the last two digits, the year. For example, the third week of the year 2010 would have a four-digit DOT date of 0310.

Vehicle Storage

Tires age when stored normally mounted on a parked vehicle. Park a vehicle that will be stored for at least a month in a cool, dry, clean area away from direct sunlight to

slow aging. This area should be free of grease, gasoline, or other substances that can deteriorate rubber.

Parking for an extended period can cause flat spots on the tires that may result in vibrations while driving. When storing a vehicle for at least a month, remove the tires or raise the vehicle to reduce the weight from the tires.

Buying New Tires

GM has developed and matched specific tires for the vehicle. The original equipment tires installed were designed to meet General Motors Tire Performance Criteria Specification (TPC Spec) system rating. When replacement tires are needed, GM strongly recommends buying tires with the same TPC Spec rating.

GM's exclusive TPC Spec system considers over a dozen critical specifications that impact the overall performance of the vehicle, including brake system performance, ride and handling, traction control, and tire pressure monitoring performance. GM's TPC Spec number is molded onto the tire's sidewall near the tire size. If the tires have an all-season tread design, the TPC Spec number will be followed by MS for mud and snow. See *Tire Sidewall Labeling on page 10-64*, for additional information.

GM recommends replacing worn tires in complete sets of four. Uniform tread depth on all tires will help to maintain the performance of the vehicle. Braking and handling performance may be adversely affected if all the tires are not replaced at the same time.

If proper rotation and maintenance have been done, all four tires should wear out at about the same time. See *Tire Rotation on page 10-76* for information on proper tire rotation. However, if it is necessary to replace only one axle set of worn tires, place the new tires on the rear axle.

Winter tires with the same speed rating as the original equipment tires may not be available for H, V, W, and ZR speed rated tires. Never exceed the winter tire's maximum speed capability when using winter tires with a lower speed rating.

Warning

Tires could explode during improper service. Attempting to mount or dismount a tire could cause injury or death. Only your dealer or authorized tire service center should mount or dismount the tires.

Warning

Mixing tires of different sizes (other than those originally installed on the vehicle), brands, or types may cause loss of control of the vehicle, resulting in a crash or other vehicle damage. Use the correct size, brand, and type of tire on all four wheels.

Warning

Using bias-ply tires on the vehicle may cause the wheel rim flanges to develop cracks after many miles of driving. A tire and/or wheel could fail suddenly and cause a crash. Use only radial-ply tires with the wheels on the vehicle.

If the vehicle tires must be replaced with a tire that does not have a TPC Spec number, make sure they are the same size, load range, speed rating, and construction (radial) as the original tires.

Vehicles that have a tire pressure monitoring system could give an inaccurate low-pressure warning if non-TPC Spec rated tires are installed. See *Tire Pressure Monitor Operation* on page 10-73.

The Tire and Loading Information label indicates the original equipment tires on the vehicle. See *Vehicle Load Limits* on page 9-11, for the label location and more information about the Tire and Loading Information label.

Different Size Tires and Wheels

If wheels or tires are installed that are a different size than the original equipment wheels and tires, vehicle performance, including its braking, ride and handling characteristics, stability, and resistance to rollover may be affected. If the vehicle has electronic systems such as antilock brakes, rollover airbags, traction control, electronic stability control, or All-Wheel Drive, the performance of these systems can also be affected.

Warning

If different sized wheels are used, there may not be an acceptable level of performance and safety if tires not recommended for those wheels are selected. This increases the chance of a crash and serious injury. Only use GM specific wheel and tire systems developed for the vehicle, and have them properly installed by a GM certified technician.

See *Buying New Tires* on page 10-79 and *Accessories and Modifications* on page 10-3.

Uniform Tire Quality Grading

Quality grades can be found where applicable on the tire sidewall between tread shoulder and maximum section width. For example:

Treadwear 200 Traction AA Temperature A

The following information relates to the system developed by the United States National Highway Traffic Safety Administration (NHTSA), which grades tires by treadwear, traction, and temperature performance. This applies only to vehicles sold in the United States. The grades are molded on the sidewalls of most passenger car tires. The Uniform Tire Quality Grading (UTQG) system does not apply to deep tread, winter tires, compact spare tires, tires with

nominal rim diameters of 10 to 12 inches (25 to 30 cm), or to some limited-production tires.

While the tires available on General Motors passenger cars and light trucks may vary with respect to these grades, they must also conform to federal safety requirements and additional General Motors Tire Performance Criteria (TPC) standards.

All Passenger Car Tires Must Conform to Federal Safety Requirements In Addition To These Grades.

Treadwear

The treadwear grade is a comparative rating based on the wear rate of the tire when tested under controlled conditions on a specified government test course. For example, a tire

graded 150 would wear one and one-half (1½) times as well on the government course as a tire graded 100. The relative performance of tires depends upon the actual conditions of their use, however, and may depart significantly from the norm due to variations in driving habits, service practices and differences in road characteristics and climate.

Traction

The traction grades, from highest to lowest, are AA, A, B, and C. Those grades represent the tire's ability to stop on wet pavement as measured under controlled conditions on specified government test surfaces of asphalt and concrete. A tire marked C may have poor traction performance. Warning: The traction grade assigned to this tire is based on

straight-ahead braking traction tests, and does not include acceleration, cornering, hydroplaning, or peak traction characteristics.

Temperature

The temperature grades are A (the highest), B, and C, representing the tire's resistance to the generation of heat and its ability to dissipate heat when tested under controlled conditions on a specified indoor laboratory test wheel. Sustained high temperature can cause the material of the tire to degenerate and reduce tire life, and excessive temperature can lead to sudden tire failure. The grade C corresponds to a level of performance which all passenger car tires must meet under the Federal Motor Safety Standard No. 109. Grades B and A represent higher levels of

performance on the laboratory test wheel than the minimum required by law. Warning: The temperature grade for this tire is established for a tire that is properly inflated and not overloaded. Excessive speed, underinflation, or excessive loading, either separately or in combination, can cause heat buildup and possible tire failure.

Wheel Alignment and Tire Balance

The tires and wheels were aligned and balanced at the factory to provide the longest tire life and best overall performance. Adjustments to wheel alignment and tire balancing are not necessary on a regular basis. Consider an alignment check if there is unusual tire wear or the vehicle is significantly pulling to one side or the other. Some slight pull to the left or right, depending on the crown of the road and/or other road

surface variations such as troughs or ruts, is normal. If the vehicle is vibrating when driving on a smooth road, the tires and wheels may need to be rebalanced. See your dealer for proper diagnosis.

CTS-V models should only use adhesive wheel weights to balance the tires and wheels.

Wheel Replacement

Replace any wheel that is bent, cracked, or badly rusted or corroded. If wheel nuts keep coming loose, the wheel, wheel bolts, and wheel nuts should be replaced. If the wheel leaks air, replace it. Some aluminum wheels can be repaired. See your dealer if any of these conditions exist.

Your dealer will know the kind of wheel that is needed.

Each new wheel should have the same load-carrying capacity, diameter, width, offset, and be mounted the same way as the one it replaces.

Replace wheels, wheel bolts, wheel nuts, or Tire Pressure Monitor System (TPMS) sensors with new GM original equipment parts.

Warning

Using the wrong replacement wheels, wheel bolts, or wheel nuts can be dangerous. It could affect the braking and handling of the vehicle. Tires can lose air, and cause loss of control, causing a crash. Always use the correct wheel, wheel bolts, and wheel nuts for replacement.

Caution

The wrong wheel can also cause problems with bearing life, brake cooling, speedometer or odometer calibration, headlamp aim, bumper height, vehicle

(Continued)

Caution (Continued)

ground clearance, and tire or tire chain clearance to the body and chassis.

Used Replacement Wheels

Warning

Replacing a wheel with a used one is dangerous. How it has been used or how far it has been driven may be unknown. It could fail suddenly and cause a crash. When replacing wheels, use a new GM original equipment wheel.

Tire Chains

Warning

Do not use tire chains. There is not enough clearance. Tire chains used on a vehicle without the proper amount of clearance can cause damage to the brakes, suspension, or other vehicle parts. The area damaged by the tire chains could cause loss of control and a crash. Use another type of traction device only if its manufacturer recommends it for the vehicle's tire size combination and road conditions. Follow that manufacturer's instructions. To avoid vehicle damage, drive slowly and readjust or remove the traction device if it contacts the vehicle. Do not spin the wheels. If traction devices are used, install them on the rear tires.

If a Tire Goes Flat

It is unusual for a tire to blow out while driving, especially if the tires are maintained properly. See *Tires on page 10-61*. If air goes out of a tire, it is much more likely to leak out slowly. But if there is ever a blowout, here are a few tips about what to expect and what to do:

If a front tire fails, the flat tire creates a drag that pulls the vehicle toward that side. Take your foot off the accelerator pedal and grip the steering wheel firmly. Steer to maintain lane position, and then gently brake to a stop, well off the road, if possible.

A rear blowout, particularly on a curve, acts much like a skid and may require the same correction as used in a skid. Stop pressing the accelerator pedal and steer to straighten the vehicle. It may be very bumpy and noisy. Gently brake to a stop, well off the road, if possible.

Warning

Driving on a flat tire will cause permanent damage to the tire. Re-inflating a tire after it has been driven on while severely underinflated or flat may cause a blowout and a serious crash. Never attempt to re-inflate a tire that has been driven on while severely underinflated or flat. Have your dealer or an authorized tire service center repair or replace the flat tire as soon as possible.

Warning

Lifting a vehicle and getting under it to do maintenance or repairs is dangerous without the appropriate safety equipment and training. If a jack is provided with the vehicle, it is designed only for changing a flat tire. If it is used for anything else, you or others could be badly injured or killed if the vehicle slips off the jack. If a jack is provided with the vehicle, only use it for changing a flat tire.

If a tire goes flat, avoid further tire and wheel damage by driving slowly to a level place, well off the road, if possible. Turn on the hazard warning flashers. See *Hazard Warning Flashers on page 6-4*.

⚠ Warning

Changing a tire can be dangerous. The vehicle can slip off the jack and roll over or fall causing injury or death. Find a level place to change the tire. To help prevent the vehicle from moving:

1. Set the parking brake firmly.
2. Put an automatic transmission in P (Park) or a manual transmission in 1 (First) or R (Reverse).
3. Turn off the engine and do not restart while the vehicle is raised.
4. Do not allow passengers to remain in the vehicle.
5. Place wheel blocks on both sides of the tire at the opposite corner of the tire being changed.

This vehicle may come with a jack and spare tire or a tire sealant and compressor kit. To use the jacking equipment to change a spare tire safely, follow the instructions below. Then see *Tire Changing* on page 10-96. To use the tire sealant and compressor kit, see *Tire Sealant and Compressor Kit* on page 10-86.

When the vehicle has a flat tire (2), use the following example as a guide to assist you in the placement of wheel blocks (1).

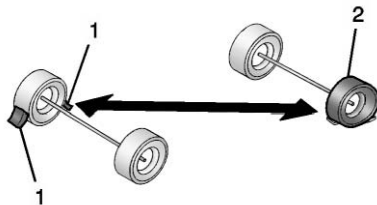

1. Wheel Block
2. Flat Tire

The following information explains how to repair or change a tire.

Tire Sealant and Compressor Kit**⚠ Warning**

Idling a vehicle in an enclosed area with poor ventilation is dangerous. Engine exhaust may enter the vehicle. Engine exhaust contains carbon monoxide (CO) which cannot be seen or smelled. It can cause unconsciousness and even death. Never run the engine in an enclosed area that has no fresh air ventilation. For more information, see *Engine Exhaust* on page 9-25.

 **Warning**

Overinflating a tire could cause the tire to rupture and you or others could be injured. Be sure to read and follow the tire sealant and compressor kit instructions and inflate the tire to its recommended pressure. Do not exceed the recommended pressure.

 **Warning**

Storing the tire sealant and compressor kit or other equipment in the passenger compartment of the vehicle could cause injury. In a sudden stop or collision, loose equipment could strike someone. Store the tire sealant and compressor kit in its original location.

If this vehicle has a tire sealant and compressor kit, there may not be a spare tire or tire changing equipment, and on some vehicles there may not be a place to store a tire.

The tire sealant and compressor can be used to temporarily seal punctures up to 6 mm (0.25 in) in the tread area of the tire. It can also be used to inflate an underinflated tire.

If the tire has been separated from the wheel, has damaged sidewalls, or has a large puncture, the tire is too severely damaged for the tire sealant and compressor kit to be effective. See *Roadside Service on page 13-5*.

Read and follow all of the tire sealant and compressor kit instructions.

10-88 Vehicle Care

The kit includes:

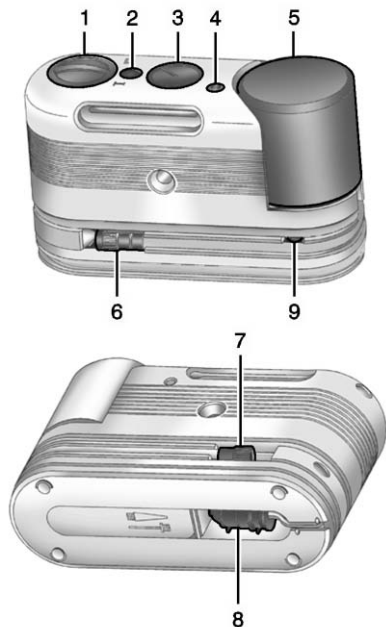

1. Selector Switch (Sealant/Air or Air Only)

2. On/Off Button
3. Pressure Gauge
4. Pressure Deflation Button
5. Tire Sealant Canister
6. Sealant/Air Hose (Clear)
7. Air Only Hose (Black)
8. Power Plug
9. Canister Release Button (Under Sealant/Air Hose)

Tire Sealant

Read and follow the safe handling instructions on the label adhered to the sealant canister.

Check the tire sealant expiration date on the sealant canister. The sealant canister should be replaced before its expiration date. Replacement sealant canisters are available at your local dealer. See "Removal and Installation of the Sealant Canister" following.

There is only enough sealant to seal one tire. After usage, the sealant canister and sealant/air hose assembly must be replaced. See "Removal and Installation of the Sealant Canister" following.

Using the Tire Sealant and Compressor Kit to Temporarily Seal and Inflate a Punctured Tire

Follow the directions closely for correct sealant usage.

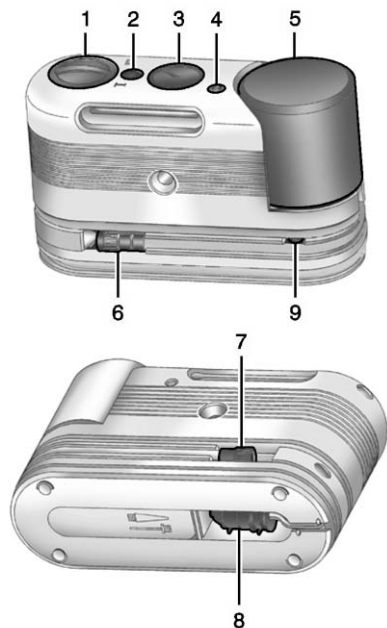

1. Selector Switch (Sealant/Air or Air Only)
2. On/Off Button

3. Pressure Gauge
4. Pressure Deflation Button
5. Tire Sealant Canister
6. Sealant/Air Hose (Clear)
7. Air Only Hose (Black)
8. Power Plug
9. Canister Release Button (Under Sealant/Air Hose)

When using the tire sealant and compressor kit during cold temperatures, warm the kit in a heated environment for five minutes. This will help to inflate the tire faster.

If a tire goes flat, avoid further tire and wheel damage by driving slowly to a level place. Turn on the hazard warning flashers. See *Hazard Warning Flashers* on page 6-4.

See *If a Tire Goes Flat* on page 10-85 for other important safety warnings.

Do not remove any objects that have penetrated the tire.

1. Remove the tire sealant and compressor kit from its storage location. See *Storing the Tire Sealant and Compressor Kit (Coupe)* on page 10-94 or *Storing the Tire Sealant and Compressor Kit (Wagon)* on page 10-95 or *Storing the Tire Sealant and Compressor Kit (Sedan)* on page 10-96.
2. Unwrap the sealant/air hose (6) and the power plug (8).
3. Place the kit on the ground.

Make sure the tire valve stem is positioned close to the ground so the hose will reach it.
4. Remove the valve stem cap from the flat tire by turning it counterclockwise.
5. Attach the sealant/air hose (6) onto the tire valve stem. Turn it clockwise until it is tight.

10-90 Vehicle Care

6. Plug the power plug (8) into the accessory power outlet in the vehicle. Unplug all items from other accessory power outlets. See *Power Outlets on page 5-9*.

If the vehicle has an accessory power outlet, do not use the cigarette lighter.

If the vehicle only has a cigarette lighter, use the cigarette lighter.

Do not pinch the power plug cord in the door or window.

7. Start the vehicle. The vehicle must be running while using the air compressor.
8. Press and turn the selector switch (1) counterclockwise to the Sealant + Air position.
9. Press the on/off button (2) to turn the tire sealant and compressor kit on.

The compressor will inject sealant and air into the tire.

The pressure gauge (3) will initially show a high pressure while the compressor pushes the sealant into the tire. Once the sealant is completely dispersed into the tire, the pressure will quickly drop and start to rise again as the tire inflates with air only.

10. Inflate the tire to the recommended inflation pressure using the pressure gauge (3). The recommended inflation pressure can be found on the Tire and Loading Information label. See *Tire Pressure on page 10-70*.

The pressure gauge (3) may read higher than the actual tire pressure while the compressor is on. Turn the compressor off to get an accurate pressure reading. The compressor may be turned on/off until the correct pressure is reached.

Caution

If the recommended pressure cannot be reached after approximately 25 minutes, the vehicle should not be driven farther. The tire is too severely damaged and the tire sealant and compressor kit cannot inflate the tire. Remove the power plug from the accessory power outlet and unscrew the inflating hose from the tire valve. See *Roadside Service on page 13-5*.

11. Press the on/off button (2) to turn the tire sealant and compressor kit off.

The tire is not sealed and will continue to leak air until the vehicle is driven and the sealant is distributed in the tire, therefore, Steps 12–18 must be done immediately after Step 11.

Be careful while handling the tire sealant and compressor kit as it could be warm after usage.

12. Unplug the power plug (8) from the accessory power outlet in the vehicle.
13. Turn the sealant/air hose (6) counterclockwise to remove it from the tire valve stem.
14. Replace the tire valve stem cap.
15. Replace the sealant/air hose (6), and the power plug (8) back in their original location.



16. If the flat tire was able to inflate to the recommended inflation pressure, remove the

maximum speed label from the sealant canister (5) and place it in a highly visible location. Do not exceed the speed on this label until the damaged tire is repaired or replaced.

17. Return the equipment to its original storage location in the vehicle.
18. Immediately drive the vehicle 8 km (5 mi) to distribute the sealant in the tire.
19. Stop at a safe location and check the tire pressure. Refer to Steps 1–11 under “Using the Tire Sealant and Compressor Kit without Sealant to Inflate a Tire (Not Punctured).”

If the tire pressure has fallen more than 68 kPa (10 psi) below the recommended inflation pressure, stop driving the vehicle. The tire is too severely damaged and the tire sealant cannot seal the tire. See *Roadside Service on page 13-5*.

If the tire pressure has not dropped more than 68 kPa (10 psi) from the recommended inflation pressure, inflate the tire to the recommended inflation pressure.

20. Wipe off any sealant from the wheel, tire, and vehicle.
21. Dispose of the used sealant canister (5) and sealant/air hose (6) assembly at a local dealer or in accordance with local state codes and practices.

10-92 Vehicle Care

22. Replace with a new canister assembly available from your dealer.
23. After temporarily sealing the tire using the tire sealant and compressor kit, take the vehicle to an authorized dealer within 161 km (100 mi) of driving to have the tire repaired or replaced.

Using the Tire Sealant and Compressor Kit without Sealant to Inflate a Tire (Not Punctured)

To use the air compressor to inflate a tire with air only and not sealant:

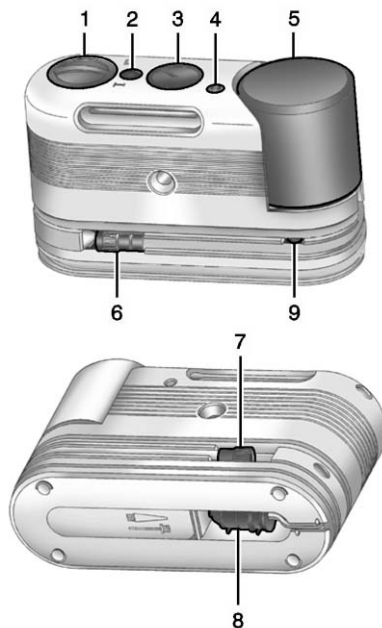

1. Selector Switch (Sealant/Air or Air Only)
2. On/Off Button

3. Pressure Gauge
4. Pressure Deflation Button
5. Tire Sealant Canister
6. Sealant/Air Hose (Clear)
7. Air Only Hose (Black)
8. Power Plug
9. Canister Release Button (Under Sealant/Air Hose)

If a tire goes flat, avoid further tire and wheel damage by driving slowly to a level place. Turn on the hazard warning flashers. See *Hazard Warning Flashers* on page 6-4.

See *If a Tire Goes Flat* on page 10-85 for other important safety warnings.

1. Remove the tire sealant and compressor kit from its storage location. See *Storing the Tire Sealant and Compressor Kit (Coupe)* on page 10-94 or *Storing the Tire Sealant and Compressor Kit (Wagon)* on page 10-95 or *Storing the Tire Sealant and Compressor Kit (Sedan)* on page 10-96.
2. Unwrap the air only hose (7) and the power plug (8).
3. Place the kit on the ground.
Make sure the tire valve stem is positioned close to the ground so the hose will reach it.
4. Remove the tire valve stem cap from the flat tire by turning it counterclockwise.
5. Attach the air only hose (7) onto the tire valve stem by turning it clockwise until it is tight.

6. Plug the power plug (8) into the accessory power outlet in the vehicle. Unplug all items from other accessory power outlets. See *Power Outlets* on page 5-9.

If the vehicle has an accessory power outlet, do not use the cigarette lighter.

If the vehicle only has a cigarette lighter, use the cigarette lighter.

Do not pinch the power plug cord in the door or window.
7. Start the vehicle. The vehicle must be running while using the air compressor.
8. Press and turn the selector switch (1) clockwise to the Air Only position.
9. Press the on/off button (2) to turn the compressor on.

The compressor will inflate the tire with air only.

10. Inflate the tire to the recommended inflation pressure using the pressure gauge (3). The recommended inflation pressure can be found on the Tire and Loading Information label. See *Tire Pressure* on page 10-70.

The pressure gauge (3) may read higher than the actual tire pressure while the compressor is on. Turn the compressor off to get an accurate reading. The compressor may be turned on/off until the correct pressure is reached.

If you inflate the tire higher than the recommended pressure you can adjust the excess pressure by pressing the pressure deflation button (4) until the proper pressure reading is reached. This option is only functional when using the air only hose (7).

10-94 Vehicle Care

11. Press the on/off button (2) to turn the tire sealant and compressor kit off.

Be careful while handling the tire sealant and compressor kit as it could be warm after usage.

12. Unplug the power plug (8) from the accessory power outlet in the vehicle.
13. Disconnect the air only hose (7) from the tire valve stem, by turning it counterclockwise, and replace the tire valve stem cap.
14. Replace the air only hose (7) and the power plug (8) and cord back in its original location.
15. Place the equipment in the original storage location in the vehicle.

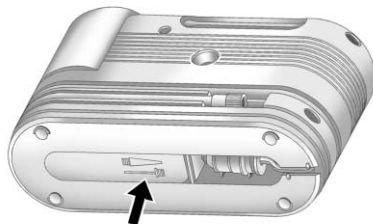

The tire sealant and compressor kit has an accessory adapter located in a compartment on the bottom of its housing that may be used to inflate air mattresses, balls, etc.

Removal and Installation of the Sealant Canister

To remove the sealant canister:

1. Unwrap the sealant hose.
2. Press the canister release button (9).
3. Pull up and remove the canister.
4. Replace with a new canister which is available from your dealer.
5. Push the new canister into place.

Storing the Tire Sealant and Compressor Kit (Coupe)

The tire sealant and compressor kit is in the trunk in one of the following locations.

1. Open the trunk. See *Trunk* on page 2-17.

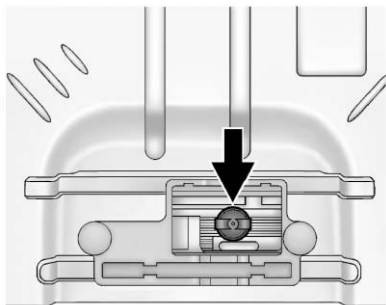
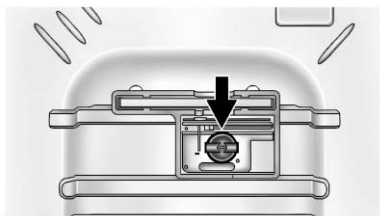

2. Remove the retainer that holds the tire sealant and compressor kit in place.

3. Remove the tire sealant and compressor kit from the foam container.

To store the tire sealant and compressor kit, reverse the steps.

Storing the Tire Sealant and Compressor Kit (Wagon)

The tire sealant and compressor kit is in the rear of the vehicle.

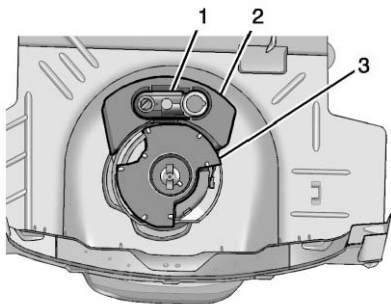

1. Tire Sealant and Compressor Kit
2. Foam Container

3. Subwoofer (Optional)

1. Open the liftgate. See *Liftgate* on page 2-19.

2. Pull up on the tire sealant and compressor kit (1) to remove it from the foam container (2).

It is not necessary to remove the subwoofer (3) to access the tire sealant and compressor kit; however, if you want to remove it see *Tire Changing* on page 10-96 for instructions.

To store the tire sealant and compressor kit, reverse the steps.

Storing the Tire Sealant and Compressor Kit (Sedan)

The tire sealant and compressor kit is in the trunk in one of the following locations.

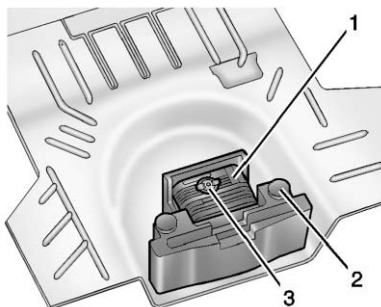
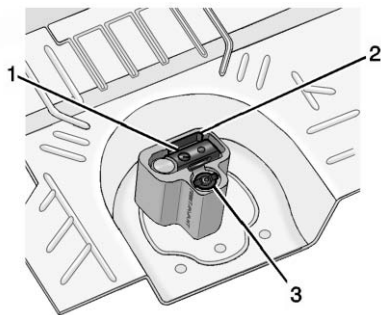

1. Tire Sealant and Compressor Kit
2. Foam Container
3. Wing Nut

1. Open the trunk. See *Trunk on page 2-17*.
2. Locate the tire sealant and compressor kit (1) in the center of the cargo area.
3. Remove the wing nut (3) that holds the tire sealant and compressor kit (1) in place.
4. Remove the tire sealant and compressor kit (1) from the foam container (2).

To store the tire sealant and compressor kit, reverse the steps.

Tire Changing

Removing the Spare Tire and Tools (Sedan)

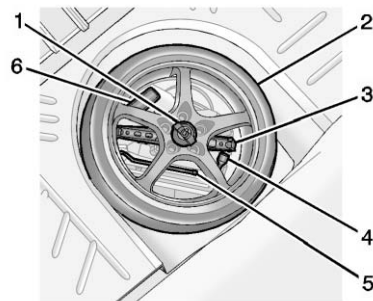

Sedan

1. Wing Nut
2. Spare Tire
3. Jack
4. Wheel Wrench
5. Extension (If Equipped)
6. Strap

To access the spare tire and jacking equipment:

1. Remove the spare tire cover.
2. Remove the foam cover, if equipped.
3. Remove the stow rod cap by pulling it straight up off of the rod.
4. Turn the wing nut (1) on the compact spare tire (2) counterclockwise to remove.
5. Remove the spare tire and place it next to the flat tire.
6. The tools you will be using next include the jack (3), wheel wrench (4), and extension (5), if the vehicle has one.

Removing the Spare Tire and Tools (Wagon)

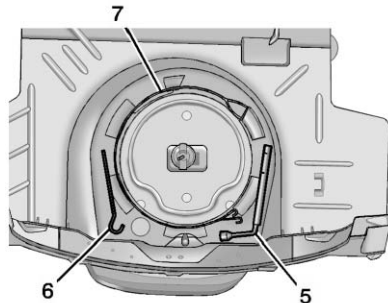
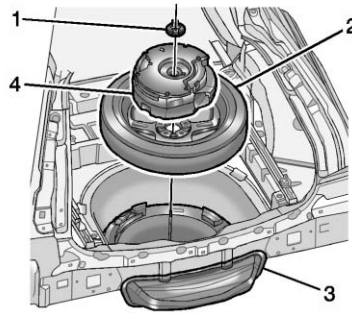

1. Wing Nut
2. Spare Tire
3. Jack
4. Subwoofer (If Equipped)
5. Wheel Wrench (Two-Piece Shown, Three-Piece Similar)
6. Extension (If Equipped)
7. Cable

To access the spare tire and jacking equipment:

1. Remove the spare tire cover.
2. Remove the subwoofer (4), if the vehicle has one.

To remove the subwoofer:

- 2.1. Turn the nut (1) counterclockwise to remove.
- 2.2. Disconnect the connector wire.
- 2.3. Pull the subwoofer (4) up to remove it from the stow rod.
3. Remove the spare tire (2) and place it next to the flat tire.

10-98 Vehicle Care

4. Remove the jack (3), wheel wrench (5), and extension (6), if the vehicle has one.

To remove the jack:

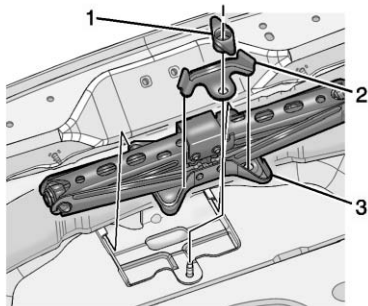

1. Retainer Nut
 2. Jack Storage Bracket
 3. Jack
1. Turn the retainer nut (1) counterclockwise to remove.
 2. Remove the jack storage bracket (2).

3. Slide the jack (3) forward to remove it from the floor storage bracket.

Removing the Flat Tire and Installing the Spare Tire

1. Do a safety check before proceeding. See *If a Tire Goes Flat* on page 10-85

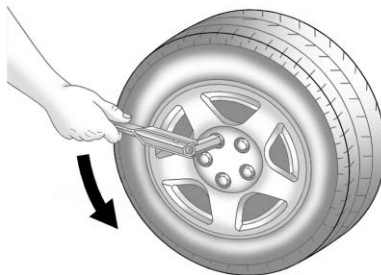

2. Use the wrench to loosen all of the wheel nuts. Do not remove them yet.

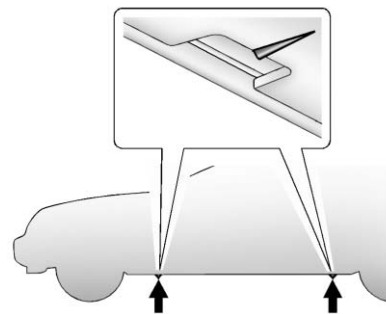

3. Find the jacking location using the diagram above, and the corresponding V-shaped locating notches in the plastic molding.

Warning

Getting under a vehicle when it is lifted on a jack is dangerous. If the vehicle slips off the jack, you could be badly injured or killed. Never get under a vehicle when it is supported only by a jack.

⚠ Warning

Lifting a vehicle and getting under it to do maintenance or repairs is dangerous without the appropriate safety equipment and training. If a jack is provided with the vehicle, it is designed only for changing a flat tire. If it is used for anything else, you or others could be badly injured or killed if the vehicle slips off the jack. If a jack is provided with the vehicle, only use it for changing a flat tire.

⚠ Warning

Raising the vehicle with the jack improperly positioned can damage the vehicle and even make the vehicle fall. To help avoid personal injury and vehicle damage, be sure to fit the jack lift head into the proper location before raising the vehicle.

⚠ Caution

If you position the jack under the rocker molding and attempt to raise the vehicle, you could break the molding and/or cause other damage to your vehicle. Always position the jack so that when the jack head is raised, it will fit firmly in the notch located inboard from the rocker molding.

4. If you have a coin/pierce jack, attach the jack handle extension to the jack by sliding the hook through the end of the jack and insert the other end of the jack handle into the wrench.

If you have a hex head jack, place the hex tube end of the wrench over the hex head of the jack.

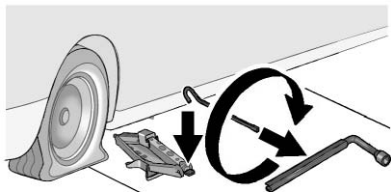

Coin/Pierce Jack and Wrench

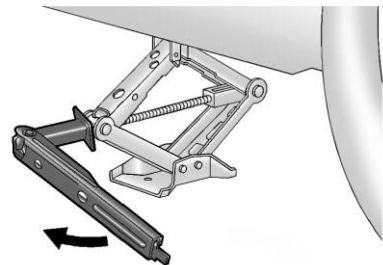

Hex Head Jack and Wrench

5. Turn the wheel wrench counterclockwise to lower the jack lift head until the jack fits under the vehicle.

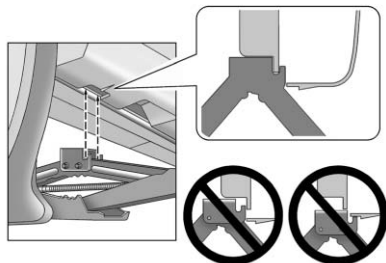

6. Raise the jack by turning the wheel wrench clockwise until the slots in the jack head fit into the metal flange located behind the V-shaped locating notches on the plastic molding as shown.
7. Put the compact spare tire near you.
8. Raise the vehicle by turning the wheel wrench clockwise. Raise the vehicle far enough off the ground for the compact spare tire to fit under the vehicle.

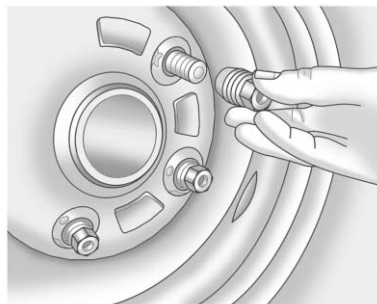

9. Remove all of the wheel nuts and the flat tire.

Warning

Rust or dirt on a wheel, or on the parts to which it is fastened, can make wheel nuts become loose after time. The wheel could come off and cause an accident. When changing a wheel, remove any rust or dirt from places where the wheel attaches to the vehicle. In an emergency, a cloth or a paper

(Continued)

Warning (Continued)

towel can be used; however, use a scraper or wire brush later to remove all rust or dirt.

Warning

Never use oil or grease on bolts or nuts because the nuts might come loose. The vehicle's wheel could fall off, causing a crash.

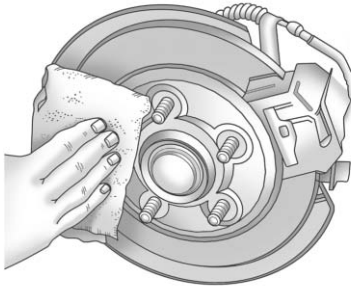

10. Remove any rust or dirt from the wheel bolts, mounting surfaces, and spare wheel.
11. Install the spare tire.
12. Put the wheel nuts back on with the rounded end of the nuts toward the wheel.
13. Tighten each wheel nut by turning it clockwise with your hand until the wheel is held against the hub.

14. Lower the vehicle by turning the wheel wrench counterclockwise. Lower the jack completely.

⚠ Warning

Wheel nuts that are improperly or incorrectly tightened can cause the wheels to become loose or come off. The wheel nuts should be tightened with a torque wrench to the proper torque specification after replacing. Follow the torque specification supplied by the aftermarket manufacturer when using accessory locking wheel nuts. See *Capacities and Specifications* on page 12-2 for original equipment wheel nut torque specifications.

⚠ Caution

Improperly tightened wheel nuts can lead to brake pulsation and rotor damage. To avoid expensive brake repairs, evenly tighten the wheel nuts in the proper sequence and to the proper torque specification. See *Capacities and Specifications* for the wheel nut torque specification.

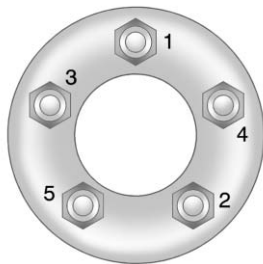

15. Tighten the wheel nuts firmly in a crisscross sequence as shown.

Storing a Flat or Spare Tire and Tools

Warning

Storing a jack, a tire, or other equipment in the passenger compartment of the vehicle could cause injury. In a sudden stop or
(Continued)

Warning (Continued)

collision, loose equipment could strike someone. Store all these in the proper place.

Storing the Flat Tire with a Flat Load Floor (Sedan)

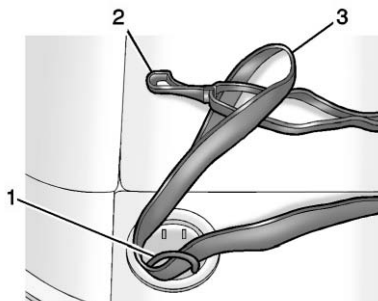

1. Cargo Tie-Down
2. Hook
3. Loop

1. Put back all tools as they were stored in the rear storage compartment and put the compartment cover back on.
2. Put the flat tire in the tire storage bag, if there is one.
3. Place the tire, lying flat, in the rear storage compartment.
4. Route the loop end of the strap (3) through one of the cargo tie-downs (1) in the rear of the vehicle.
5. Route the hook (2) through the loop (3).
6. Pull the strap to tighten it around the cargo tie-down (1).

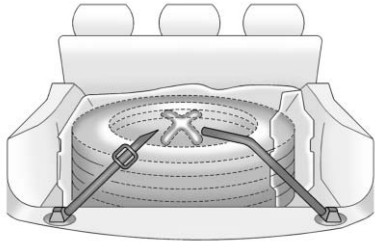

7. Route the hook end of the strap through the wheel.
8. Attach the hook to the cargo tie-down in the rear of the vehicle.
9. Slide the buckle to tighten the cargo tie-down strap.

Storing the Flat Tire with a Flat Load Floor (Wagon)

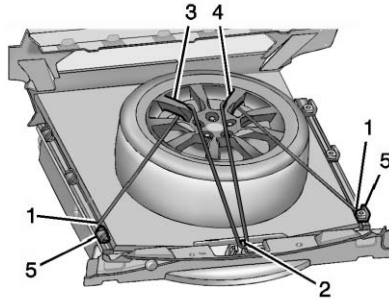

1. Hook
 2. Liftgate Striker
 3. Wheel Spoke
 4. Wheel Spoke
 5. D-rings
1. Return all tools as they were stored in the rear storage compartment and put the compartment cover on.

2. Put the flat tire in the tire storage bag, if there is one.
3. Place the tire, lying flat, in the rear storage compartment.
4. Route one of the hooks (1), at the end of the cable provided, through the liftgate striker (2).
5. Slide both D-rings (5) on each side of the vehicle as far rearward as they will go.
6. Route one hook (1) under the wheel spoke (3) and place the hook into the slot in the cargo rail on the driver side of the vehicle.
7. Slide the D-ring (5) on that side forward to engage the hook.
8. Route the other hook under the wheel spoke (4) and place the hook into the slot in the cargo rail on the passenger side of the vehicle.
9. Slide the D-ring (5) on that side forward to engage the hook.

Storing the Compact Spare Tire and Tools

Reverse the instructions for removing the spare tire and tools to store the compact spare tire.

Compact Spare Tire

Warning

Driving with more than one compact spare tire at a time could result in loss of braking and handling. This could lead to a crash and you or others could be injured. Use only one compact spare tire at a time.

If this vehicle has a compact spare tire, it was fully inflated when new; however, it can lose air over time. Check the inflation pressure regularly. It should be 420 kPa (60 psi).

Stop as soon as possible and check that the spare tire is correctly inflated after being installed on the vehicle. The compact spare tire is designed for temporary use only. The vehicle will perform differently with the spare tire installed and it is recommended that the vehicle speed be limited to 80 km/h (50 mph). To conserve the tread of the spare tire, have the standard tire repaired or replaced as soon as convenient and return the spare tire to the storage area.

When using a compact spare tire, the ABS and Traction Control systems may engage until the spare tire is recognized by the vehicle, especially on slippery roads. Adjust driving to reduce possible wheel slip.

Caution

When the compact spare is installed, do not take the vehicle through an automatic car wash with guide rails. The compact spare can get caught on the rails which can damage the tire, wheel, and other parts of the vehicle.

Do not use the compact spare on other vehicles.

Do not mix the compact spare tire or wheel with other wheels or tires. They will not fit. Keep the spare tire and its wheel together.

Caution

Tire chains will not fit the compact spare. Using them can damage the vehicle and the chains. Do not use tire chains on the compact spare.

Jump Starting

For more information about the vehicle battery, see *Battery* on page 10-29.

If the vehicle battery has run down, you may want to use another vehicle and some jumper cables to start your vehicle. Be sure to use the following steps to do it safely.

Warning

Batteries can hurt you. They can be dangerous because:

- They contain acid that can burn you.
- They contain gas that can explode or ignite.
- They contain enough electricity to burn you.

If you do not follow these steps exactly, some or all of these things can hurt you.

Caution

Ignoring these steps could result in costly damage to the vehicle that would not be covered by the vehicle warranty. Trying to start the vehicle by pushing or pulling it will not work, and it could damage the vehicle.

1. Check the other vehicle. It must have a 12-volt battery with a negative ground system.

Caution

If the other vehicle does not have a 12-volt system with a negative ground, both vehicles can be damaged. Only use a vehicle that has a 12-volt system with a negative ground for jump starting.

2. Get the vehicles close enough so the jumper cables can reach, but be sure the vehicles are not touching each other. If they are, it could cause a ground connection you do not want. You would not be able to start your vehicle and the bad grounding could damage the electrical systems.

To avoid the possibility of the vehicles rolling, set the parking brake firmly on both vehicles involved in the jump start procedure. Put an automatic transmission in P (Park) or a manual transmission in Neutral before setting the parking brake.

Caution

If any accessories are left on or plugged in during the jump starting procedure, they could be damaged. The repairs would not be covered by the vehicle warranty. Whenever possible, turn off or unplug all accessories on either vehicle when jump starting.

3. Turn off the ignition on both vehicles. Unplug unnecessary accessories plugged into the cigarette lighter or the accessory power outlets. Turn off the radio and all lamps that are not needed. This will avoid sparks and help save both batteries. And it could save the radio!

4. Open the hoods and locate the positive (+) and negative (-) terminal locations or the remote positive (+) and remote negative (-) terminals of the other vehicle. Then locate the remote positive (+) location on your vehicle. See *Engine Compartment Overview on page 10-6* for locations of the terminals.

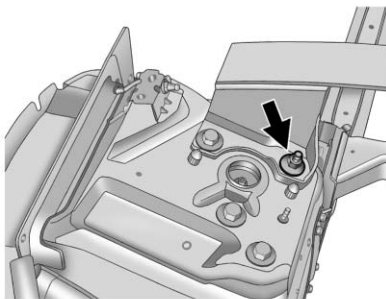

Your vehicle has a remote negative (-) ground location, as shown in the illustration.

It is on the left side of the engine compartment. See *Engine Compartment Overview on page 10-6*. You should always use this remote ground location, instead of the terminal on the battery.

Caution

Do not connect a negative cable to the Engine Control Module (ECM), ECM mounting bracket, or any cables that attach to the ECM bracket. This may damage the ECM. Always attach the negative cable to the vehicle's remote negative ground location, instead of the ECM, ECM bracket, or any cables attached to the ECM bracket.

 **Warning**

An electric fan can start up even when the engine is not running and can injure you. Keep hands, clothing and tools away from any underhood electric fan.

 **Warning**

Using an open flame near a battery can cause battery gas to explode. People have been hurt doing this, and some have been blinded. Use a flashlight if you need more light.

Be sure the battery has enough water. You do not need to add water to the battery installed in your new vehicle. But if a battery has filler caps, be sure the right amount of fluid is there. If it is low,

(Continued)

Warning (Continued)

add water to take care of that first. If you do not, explosive gas could be present.

Battery fluid contains acid that can burn you. Do not get it on you. If you accidentally get it in your eyes or on your skin, flush the place with water and get medical help immediately.

 **Warning**

Fans or other moving engine parts can injure you badly. Keep your hands away from moving parts once the engine is running.

5. Check that the jumper cables do not have loose or missing insulation. If they do, you could get a shock. The vehicles could be damaged too.

Before you connect the cables, here are some basic things you should know. Positive (+) will go to positive (+) or to a remote positive (+) terminal if the vehicle has one. Negative (-) will go to a heavy, unpainted metal engine part or to a remote negative (-) terminal if the vehicle has one.

Do not connect positive (+) to negative (-) or you will get a short that would damage the battery and maybe other parts too. And do not connect the negative (-) cable to the negative (-) terminal on the dead battery because this can cause sparks.

10-108 Vehicle Care

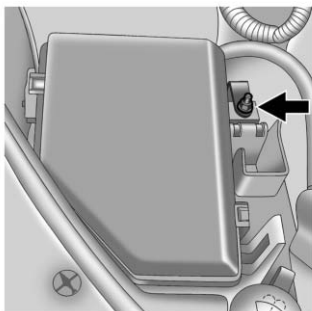

6. Connect the red positive (+) cable to the positive (+) terminal of the dead battery. Use a remote positive (+) terminal if the vehicle has one.
7. Do not let the other end touch metal. Connect it to the positive (+) terminal of the good battery. Use a remote positive (+) terminal if the vehicle has one.
8. Now connect the black negative (-) cable to the negative (-) terminal of the good battery. Use a remote negative (-) terminal if the vehicle has one.

Do not let the other end touch anything until the next step. The other end of the negative (-) cable does not go to the dead battery. It goes to a heavy, unpainted metal engine part or to a remote negative (-) terminal on the vehicle with the dead battery.
9. Connect the other end of the negative (-) cable at least 45 cm (18 in) away from the dead battery, but not near engine parts that move. The electrical connection is just as good there, and the chance of sparks getting back to the battery is much less.

Use a remote negative (-) terminal if the vehicle has one. Your vehicle's remote negative (-) ground location is for this purpose.
10. Now start the vehicle with the good battery and run the engine for a while.
11. Try to start the vehicle that had the dead battery. If it will not start after a few tries, it probably needs service.

 **Caution**

If the jumper cables are connected or removed in the wrong order, electrical shorting may occur and damage the vehicle. The repairs would not be covered by the vehicle warranty. Always connect and remove the jumper cables in the correct order, making sure that the cables do not touch each other or other metal.

Jumper Cable Removal

Reverse the sequence exactly when removing the jumper cables.

Towing the Vehicle

 **Caution**

Incorrectly towing a disabled vehicle may cause damage. The damage would not be covered by the vehicle warranty. Do not lash or hook to the chassis components — including the front and rear subframes, suspension control arms, and links — during towing and recovery of a disabled vehicle, or when securing the vehicle to a flatbed car carrier. Use the proper nylon strap harnesses around the tires to secure them to the flatbed car carrier.

Have the vehicle towed on a flatbed car carrier. A wheel lift tow truck could damage the vehicle.

Consult your dealer or a professional towing service if the disabled vehicle must be towed.

To tow the vehicle behind another vehicle for recreational purposes, such as behind a motor home, see “Recreational Vehicle Towing” following.

Recreational Vehicle Towing

Recreational vehicle towing means towing the vehicle behind another vehicle — such as behind a motorhome. The two most common types of recreational vehicle towing are known as dinghy towing and dolly towing. Dinghy towing is towing the vehicle with all four wheels on the ground. Dolly towing is towing the vehicle with two wheels on the ground and two wheels up on a device known as a dolly.

10-110 Vehicle Care

Here are some important things to consider before recreational vehicle towing:

- What is the towing capacity of the towing vehicle? Be sure to read the tow vehicle manufacturer's recommendations.
- What is the distance that will be traveled? Some vehicles have restrictions on how far and how long they can tow.
- Is the proper towing equipment going to be used? See your dealer or trailering professional for additional advice and equipment recommendations.
- Is the vehicle ready to be towed? Just as preparing the vehicle for a long trip, make sure the vehicle is prepared to be towed.

Dinghy Towing

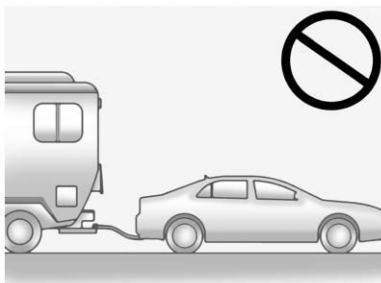
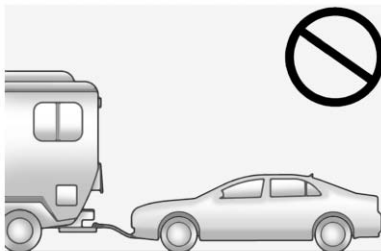

Caution

If the vehicle is towed with all four wheels on the ground, the drivetrain components could be damaged. The repairs would not be covered by the vehicle warranty. Do not tow the vehicle with all four wheels on the ground.

The vehicle was not designed to be towed with all four wheels on the ground. If a rear-wheel-drive vehicle must be towed, a dolly or a trailer should be used. If an all-wheel-drive vehicle must be towed, a trailer should be used. See "Dolly Towing" following for more information.

Dolly Towing (Rear-Wheel-Drive Vehicles)

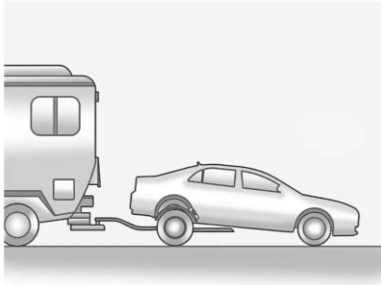

Use the following procedure to dolly tow a rear-wheel-drive vehicle from the rear:

1. Attach the dolly to the tow vehicle following the dolly manufacturer's instructions.
2. Put the rear wheels on the dolly.
3. Firmly set the parking brake. See *Parking Brake (Manual)* on page 9-34 or *Parking Brake (Electric)* on page 9-35.

4. Put the vehicle in P (Park) for an automatic transmission or in 1 (First) for a manual transmission.
5. Securely attach the vehicle being towed to the dolly.
6. Clamp the steering wheel in a straight-ahead position with a clamping device designed for towing.
7. Turn the ignition to LOCK/OFF.

Dolly Towing (All-Wheel-Drive Vehicles)

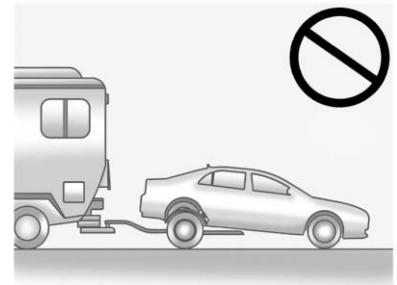
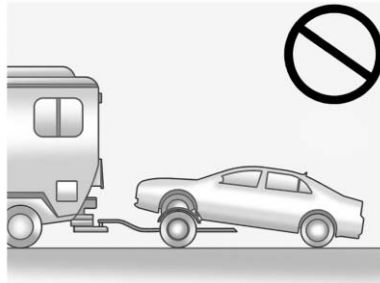

Caution

Towing an all-wheel-drive vehicle with all four wheels on the ground, or even with only two of its wheels on the ground, will damage drivetrain components. Do not tow an all-wheel-drive vehicle with any of its wheels on the ground.

All-wheel-drive vehicles can only be towed with all four wheels on a trailer.

Appearance Care

Exterior Care

Locks

Locks are lubricated at the factory. Use a de-icing agent only when absolutely necessary, and have the locks greased after using. See *Recommended Fluids and Lubricants* on page 11-13.

Washing the Vehicle

To preserve the vehicle's finish, wash it often and out of direct sunlight.

Caution

Do not use petroleum-based, acidic, or abrasive cleaning agents as they can damage the vehicle's paint, metal, or plastic parts. If damage occurs, it would not be covered by the vehicle warranty. Approved cleaning

(Continued)

Caution (Continued)

products can be obtained from your dealer. Follow all manufacturer directions regarding correct product usage, necessary safety precautions, and appropriate disposal of any vehicle care product.

Caution

Avoid using high-pressure washes closer than 30 cm (12 in) to the surface of the vehicle. Use of power washers exceeding 8,274 kPa (1,200 psi) can result in damage or removal of paint and decals.

The  symbol is on any underhood compartment electrical center that should not be power

washed. This could cause damage that would not be covered by the vehicle warranty.

If using an automatic car wash, follow the car wash instructions. The windshield wiper and rear window wiper, if equipped, must be off. Remove any accessories that may be damaged or interfere with the car wash equipment.

Rinse the vehicle well, before washing and after, to remove all cleaning agents completely. If they are allowed to dry on the surface, they could stain.

Dry the finish with a soft, clean chamois or an all-cotton towel to avoid surface scratches and water spotting.

Finish Care

Application of aftermarket clearcoat sealant/wax materials is not recommended. If painted surfaces are damaged, see your dealer to have the damage assessed and repaired. Foreign materials such as

calcium chloride and other salts, ice melting agents, road oil and tar, tree sap, bird droppings, chemicals from industrial chimneys, etc., can damage the vehicle's finish if they remain on painted surfaces. Wash the vehicle as soon as possible. If necessary, use non-abrasive cleaners that are marked safe for painted surfaces to remove foreign matter.

Occasional hand waxing or mild polishing should be done to remove residue from the paint finish. See your dealer for approved cleaning products.

Do not apply waxes or polishes to uncoated plastic, vinyl, rubber, decals, simulated wood, or flat paint as damage can occur.

 **Caution**

Machine compounding or aggressive polishing on a basecoat/clearcoat paint finish may damage it. Use only non-abrasive waxes and polishes that are made for a basecoat/clearcoat paint finish on the vehicle.

To keep the paint finish looking new, keep the vehicle garaged or covered whenever possible.

Protecting Exterior Bright Metal Moldings

 **Caution**

Failure to clean and protect the bright metal moldings can result in a hazy white finish or pitting. This damage would not be covered by the vehicle warranty.

The bright metal moldings on the vehicle are aluminum. To prevent damage always follow these cleaning instructions:

- Be sure the molding is cool to the touch before applying any cleaning solution.
- Use a cleaning solution approved for aluminum. Some cleaners are highly acidic or contain alkaline substances and can damage the moldings.
- Always dilute a concentrated cleaner according to the manufacturer's instructions.
- Do not use chrome cleaners.
- Do not use cleaners that are not intended for automotive use.
- Use a nonabrasive wax on the vehicle after washing to protect and extend the molding finish.

Cleaning Exterior Lamps/ Lenses and Emblems

Use only lukewarm or cold water, a soft cloth, and a car washing soap to clean exterior lamps, lenses and emblems. Follow instructions under "Washing the Vehicle" previously in this section.

Lamp covers are made of plastic, and some have a UV protective coating.

Use only lukewarm water, a soft cloth, and mild car washing soap to clean exterior lamps and lenses. Do not clean or wipe them while they are dry.

Do not use any of the following on lamp covers:

- Abrasive or caustic agents.
- Washer fluids and other cleaning agents in higher concentrations than suggested by the manufacturer.
- Solvents, alcohols, fuels, or other harsh cleaners.

- Ice scrapers or other hard items.
- Aftermarket appearance caps or covers while the lamps are illuminated, due to excessive heat generated.

Caution

Failure to clean lamps properly can cause damage to the lamp cover that would not be covered by the vehicle warranty.

Air Intakes

Clear debris from the air intakes, between the hood and windshield when washing the vehicle.

Windshield and Wiper Blades

Clean the outside of the windshield with glass cleaner.

Clean rubber blades using a lint-free cloth or paper towel soaked with windshield washer fluid or a mild detergent. Wash the windshield

thoroughly when cleaning the blades. Bugs, road grime, sap, and a buildup of vehicle wash/wax treatments may cause wiper streaking.

Replace the wiper blades if they are worn or damaged. Damage can be caused by extreme dusty conditions, sand, salt, heat, sun, snow, and ice.

Weatherstrips

Apply Dielectric silicone grease on weatherstrips to make them last longer, seal better, and not stick or squeak. Lubricate weatherstrips at least once a year. Hot, dry climates may require more frequent application. Black marks from rubber material on painted surfaces can be removed by rubbing with a clean cloth. See *Recommended Fluids and Lubricants on page 11-13*.

Tires

Use a stiff brush with tire cleaner to clean the tires.

Caution

Using petroleum-based tire dressing products on the vehicle may damage the paint finish and/or tires. When applying a tire dressing, always wipe off any overspray from all painted surfaces on the vehicle.

Wheels and Trim — Aluminum or Chrome

Use a soft, clean cloth with mild soap and water to clean the wheels. After rinsing thoroughly with clean water, dry with a soft, clean towel. A wax may then be applied.

Caution

Chrome wheels and other chrome trim may be damaged if the vehicle is not washed after driving on roads that have been sprayed with magnesium, calcium, or sodium chloride. These chlorides are used on roads for conditions such as ice and dust. Always wash the chrome with soap and water after exposure.

Caution

To avoid surface damage, do not use strong soaps, chemicals, abrasive polishes, cleaners, brushes, or cleaners that contain acid on aluminum or chrome-plated wheels. Use only approved cleaners. Also, never drive a vehicle with aluminum or chrome-plated wheels through an

(Continued)

Caution (Continued)

automatic car wash that uses silicone carbide tire cleaning brushes. Damage could occur and the repairs would not be covered by the vehicle warranty.

Steering, Suspension, and Chassis Components

Visually inspect the front and rear suspension and steering system for damaged, loose, or missing parts or signs of wear. If equipped, inspect the hydraulic power steering for proper hook-up, binding, leaks, cracks, chafing, etc. Visually check constant velocity joints, rubber boots, and axle seals for leaks.

Body Component Lubrication

Lubricate all key lock cylinders, hood hinges, liftgate hinges, and the steel fuel door hinge unless the components are plastic.

Applying silicone grease on weatherstrips with a clean cloth will make them last longer, seal better, and not stick or squeak.

Underbody Maintenance

At least twice a year, Spring and Fall, use plain water to flush dirt and debris from the vehicle's underbody. Your dealer or an underbody car washing system can do this. If not removed, rust and corrosion can develop.

Sheet Metal Damage

If the vehicle is damaged and requires sheet metal repair or replacement, make sure the body repair shop applies anti-corrosion material to parts repaired or replaced to restore corrosion protection.

Original manufacturer replacement parts will provide the corrosion protection while maintaining the vehicle warranty.

Finish Damage

Quickly repair minor chips and scratches with touch-up materials available from your dealer to avoid corrosion. Larger areas of finish damage can be corrected in your dealer's body and paint shop.

Chemical Paint Spotting

Airborne pollutants can fall upon and attack painted vehicle surfaces causing blotchy, ring-shaped discolorations, and small, irregular dark spots etched into the paint surface. See "Finish Care" previously in this section.

Interior Care

To prevent dirt particle abrasions, regularly clean the vehicle's interior. Immediately remove any soils. Note that newspapers or dark garments that can transfer color to home furnishings can also permanently transfer color to the vehicle's interior.

Use a soft bristle brush to remove dust from knobs and crevices on the instrument cluster. Using a mild soap solution, immediately remove hand lotions, sunscreen, and insect repellent from all interior surfaces or permanent damage may result.

Your dealer may have products for cleaning the interior. Use cleaners specifically designed for the surfaces being cleaned to prevent permanent damage. Apply all cleaners directly to the cleaning cloth. Do not spray cleaners directly on any switches or controls. Cleaners should be removed quickly. Never allow cleaners to remain on the surface being cleaned for extended periods of time.

Cleaners may contain solvents that can become concentrated in the interior. Before using cleaners, read and adhere to all safety instructions on the label. While cleaning the interior, maintain adequate ventilation by opening the doors and windows.

To prevent damage, do not clean the interior using the following cleaners or techniques:

- Never use a razor or any other sharp object to remove a soil from any interior surface.
- Never use a brush with stiff bristles.
- Never rub any surface aggressively or with excessive pressure.
- Do not use laundry detergents or dishwashing soaps with degreasers. For liquid cleaners, use approximately 20 drops per 3.8 L (1 gal) of water. A concentrated soap solution will leave a residue that creates streaks and attracts dirt. Do not use solutions that contain strong or caustic soap.
- Do not heavily saturate the upholstery when cleaning.
- Do not use solvents or cleaners containing solvents.

Interior Glass

To clean, use a terry cloth fabric dampened with water. Wipe droplets left behind with a clean dry cloth. Commercial glass cleaners may be used, if necessary, after cleaning the interior glass with plain water.

 **Caution**

To prevent scratching, never use abrasive cleaners on automotive glass. Abrasive cleaners or aggressive cleaning may damage the rear window defogger.

Cleaning the windshield with water during the first three to six months of ownership will reduce tendency to fog.

Speaker Covers

Vacuum around a speaker cover gently, so that the speaker will not be damaged. Clean spots with just water and mild soap.

Coated Moldings

Coated moldings should be cleaned.

- When lightly soiled, wipe with a sponge or soft lint-free cloth dampened with water.
- When heavily soiled, use warm soapy water.

Fabric/Carpet/Suede

Start by vacuuming the surface using a soft brush attachment. If a rotating brush attachment is being used during vacuuming, only use it on the floor carpet. Before cleaning, gently remove as much of the soil as possible using one of the following techniques:

- Gently blot liquids with a paper towel. Continue blotting until no more soil can be removed.
- For solid soils, remove as much as possible prior to vacuuming.

To clean:

1. Saturate a clean lint-free colorfast cloth with water or club soda. Microfiber cloth is recommended to prevent lint transfer to the fabric or carpet.
2. Remove excess moisture by gently wringing until water does not drip from the cleaning cloth.
3. Start on the outside edge of the soil and gently rub toward the center. Fold the cleaning cloth to a clean area frequently to prevent forcing the soil in to the fabric.
4. Continue gently rubbing the soiled area until there is no longer any color transfer from the soil to the cleaning cloth.
5. If the soil is not completely removed, use a mild soap solution followed only by club soda or plain water.

If the soil is not completely removed, it may be necessary to use a commercial upholstery cleaner or spot lifter. Test a small hidden area for colorfastness before using a commercial upholstery cleaner or spot lifter. If ring formation occurs, clean the entire fabric or carpet.

Following the cleaning process, a paper towel can be used to blot excess moisture.

Cleaning High Gloss Surfaces and Vehicle Information and Radio Displays

For vehicles with high gloss surfaces or vehicle displays, use a microfiber cloth to wipe surfaces. Before wiping the surface with the microfiber cloth, use a soft bristle brush to remove dirt that could scratch the surface. Then use the microfiber cloth by gently rubbing to clean. Never use window cleaners or solvents. Periodically hand wash the microfiber cloth separately,

using mild soap. Do not use bleach or fabric softener. Rinse thoroughly and air dry before next use.



Caution

Do not attach a device with a suction cup to the display. This may cause damage and would not be covered by the warranty.

Instrument Panel, Leather, Vinyl, Other Plastic Surfaces and Low Gloss Paint Surfaces

Use a soft microfiber cloth dampened with water to remove dust and loose dirt. For a more thorough cleaning, use a soft microfiber cloth dampened with a mild soap solution.

 **Caution**

Soaking or saturating leather, especially perforated leather, as well as other interior surfaces, may cause permanent damage. Wipe excess moisture from these surfaces after cleaning and allow them to dry naturally. Never use heat, steam, spot lifters, or spot removers. Do not use cleaners that contain silicone or wax-based products. Cleaners containing these solvents can permanently change the appearance and feel of leather or soft trim and are not recommended.

Do not use cleaners that increase gloss, especially on the instrument panel. Reflected glare can decrease visibility through the windshield under certain conditions.

 **Caution**

Use of air fresheners may cause permanent damage to plastics and painted surfaces. If an air freshener comes in contact with any plastic or painted surface in the vehicle, blot immediately and clean with a soft cloth dampened with a mild soap solution. Damage caused by air fresheners would not be covered by the vehicle warranty.

Cargo Cover and Convenience Net

Wash with warm water and mild detergent. Do not use chlorine bleach. Rinse with cold water, and then dry completely.

Care of Safety Belts

Keep belts clean and dry.

 **Warning**

Do not bleach or dye safety belts. It may severely weaken them. In a crash, they might not be able to provide adequate protection. Clean safety belts only with mild soap and lukewarm water.

Floor Mats

 **Warning**

If a floor mat is the wrong size or is not properly installed, it can interfere with the pedals. Interference with the pedals can cause unintended acceleration and/or increased stopping distance which can cause a crash and injury. Make sure the floor mat does not interfere with the pedals.

10-120 Vehicle Care

Use the following guidelines for proper floor mat usage.

- The original equipment floor mats were designed for your vehicle. If the floor mats need replacing, it is recommended that GM certified floor mats be purchased. Non-GM floor mats may not fit properly and may interfere with the pedals. Always check that the floor mats do not interfere with the pedals.
- Use the floor mat with the correct side up. Do not turn it over.
- Do not place anything on top of the driver side floor mat.
- Use only a single floor mat on the driver's side.
- Do not place one floor mat on top of another.

The driver side floor mat is held in place by a button-type retainer.

Removing and Replacing the Floor Mats

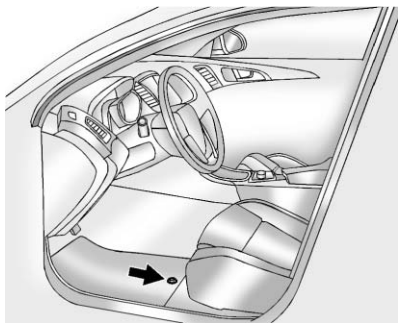

1. Pull up on the rear of the floor mat to unlock the retainer and remove.
2. Reinstall by lining up the floor mat retainer opening over the carpet retainer and snap into position.
3. Make sure the floor mat is properly secured in place.

Service and Maintenance

General Information

General Information 11-1

Cadillac Premium Care Maintenance

Cadillac Premium Care Maintenance 11-3

Maintenance Schedule

Maintenance Schedule 11-4

Special Application Services

Special Application Services 11-10

Additional Maintenance and Care

Additional Maintenance and Care 11-10

Recommended Fluids, Lubricants, and Parts

Recommended Fluids and Lubricants 11-13

Maintenance Replacement Parts 11-15

Maintenance Records

Maintenance Records 11-17

General Information

Your vehicle is an important investment. This section describes the required maintenance for the vehicle. Follow this schedule to help protect against major repair expenses resulting from neglect or inadequate maintenance. It may also help to maintain the value of the vehicle if it is sold. It is the responsibility of the owner to have all required maintenance performed.

Your dealer has trained technicians who can perform required maintenance using genuine replacement parts. They have up-to-date tools and equipment for fast and accurate diagnostics. Many dealers have extended evening and Saturday hours, courtesy transportation, and online scheduling to assist with service needs.

11-2 Service and Maintenance

Your dealer recognizes the importance of providing competitively priced maintenance and repair services. With trained technicians, the dealer is the place for routine maintenance such as oil changes and tire rotations and additional maintenance items like tires, brakes, batteries, and wiper blades.

Caution

Damage caused by improper maintenance can lead to costly repairs and may not be covered by the vehicle warranty. Maintenance intervals, checks, inspections, recommended fluids, and lubricants are important to keep the vehicle in good working condition.

The Tire Rotation and Required Services are the responsibility of the vehicle owner. It is recommended to have your dealer perform these services every 12 000 km/7,500 mi. Proper vehicle maintenance helps to keep the vehicle in good working condition, improves fuel economy, and reduces vehicle emissions.

Because of the way people use vehicles, maintenance needs vary. There may need to be more frequent checks and services. The Additional Required Services - Normal are for vehicles that:

- Carry passengers and cargo within recommended limits on the Tire and Loading Information label. See *Vehicle Load Limits on page 9-11*.
- Are driven on reasonable road surfaces within legal driving limits.
- Use the recommended fuel. See *Fuel on page 9-49*.

Refer to the information in the Maintenance Schedule Additional Required Services - Normal chart.

The Additional Required Services - Severe are for vehicles that are:

- Mainly driven in heavy city traffic in hot weather.
- Mainly driven in hilly or mountainous terrain.
- Frequently towing a trailer.
- Used for high speed or competitive driving.
- Used for taxi, police, or delivery service.

Refer to the information in the Maintenance Schedule Additional Required Services - Severe chart.

 **Warning**

Performing maintenance work can be dangerous and can cause serious injury. Perform maintenance work only if the required information, proper tools, and equipment are available. If they are not, see your dealer to have a trained technician do the work. See *Doing Your Own Service Work* on page 10-4.

Cadillac Premium Care Maintenance

Your vehicle comes with the Cadillac Premium Care Maintenance. It is a maintenance program that covers select maintenance services during the first 4 years or 80 000 km (50,000 mi), whichever comes first.

Cadillac Premium Care Maintenance covers routine maintenance services, when scheduled in accordance with the owner manual, including:

- Oil changes based on the vehicle's oil life monitor system.
- Tire rotation every 12 000 km (7,500 mi).

- Engine air cleaner filter replacement.
- Passenger compartment air filter replacement.
- Multi-point vehicle inspection (MPVI) performed by a qualified technician.

Cadillac requires that all Cadillac Premium Care Maintenance services be performed by a Cadillac authorized service dealer.

Maintenance Schedule

Owner Checks and Services

At Each Fuel Stop

- Check the engine oil level. See *Engine Oil on page 10-10*.

Once a Month

- Check the tire inflation pressures. See *Tire Pressure on page 10-70*.
- Inspect the tires for wear. See *Tire Inspection on page 10-76*.
- Check the windshield washer fluid level. See *Washer Fluid on page 10-26*.

Engine Oil Change

When the CHANGE ENGINE OIL SOON message displays, have the engine oil and filter changed within the next 1 000 km/600 mi. If driven under the best conditions, the engine oil life system might not indicate the need for vehicle service for more than a year. The engine oil and filter must be changed at least once a year and the oil life system must be reset. Your trained dealer technician can perform this work. If the engine oil life system is reset accidentally, service the vehicle within 5 000 km/3,000 mi since the last service. Reset the oil life system when the oil is changed. See *Engine Oil Life System on page 10-13*.

Tire Rotation and Required Services Every 12 000 km/7,500 mi

Rotate the tires, if recommended for the vehicle, and perform the following services. See *Tire Rotation on page 10-76*.

- Check engine oil level and oil life percentage. If needed, change engine oil and filter, and reset oil life system. See *Engine Oil on page 10-10* and *Engine Oil Life System on page 10-13*.
- Check engine coolant level. See *Engine Coolant on page 10-19*.
- Check windshield washer fluid level. See *Washer Fluid on page 10-26*.

- Visually inspect windshield wiper blades for wear, cracking, or contamination. See *Exterior Care on page 10-112*. Replace worn or damaged wiper blades. See *Wiper Blade Replacement on page 10-32*.
- Check tire inflation pressures. See *Tire Pressure on page 10-70*.
- Inspect tire wear. See *Tire Inspection on page 10-76*.
- Visually check for fluid leaks.
- Inspect engine air cleaner filter. See *Engine Air Cleaner/Filter on page 10-15*.
- Inspect brake system.
- Visually inspect steering, suspension, and chassis components for damaged, loose, or missing parts or signs of wear. See *Exterior Care on page 10-112*.
- Check restraint system components. See *Safety System Check on page 3-19*.
- Visually inspect fuel system for damage or leaks.
- Visually inspect exhaust system and nearby heat shields for loose or damaged parts.
- Lubricate body components. See *Exterior Care on page 10-112*.
- Check starter switch. See *Starter Switch Check on page 10-31*.
- Check automatic transmission shift lock control function. See *Automatic Transmission Shift Lock Control Function Check on page 10-31*.
- Check ignition transmission lock. See *Ignition Transmission Lock Check on page 10-32*.
- Check parking brake and automatic transmission park mechanism. See *Park Brake and P (Park) Mechanism Check on page 10-32*.
- Check accelerator pedal for damage, high effort, or binding. Replace if needed.
- Visually inspect gas strut for signs of wear, cracks, or other damage. Check the hold open ability of the strut. See your dealer if service is required.
- Check tire sealant expiration date, if equipped. See *Tire Sealant and Compressor Kit on page 10-86*.
- Inspect sunroof track and seal, if equipped. See *Sunroof on page 2-30*.

Maintenance Schedule Additional Required Services - Normal	12000km/7,500mi	24000km/15,000mi	36000km/22,500mi	48000km/30,000mi	60000km/37,500mi	72000km/45,000mi	84000km/52,500mi	96000km/60,000mi	108000km/67,500mi	120000km/75,000mi	132000km/82,500mi	144000km/90,000mi	156000km/97,500mi	168000km/105,000mi	180000km/112,500mi	192000km/120,000mi	204000km/127,500mi	216000km/135,000mi	228000km/142,500mi	240000km/150,000mi	
6.2L Supercharged V8 Engine Only: Drain, flush, and fill intercooler system. (6)																					✓
Replace brake fluid. (9)												✓				✓					✓
Replace clutch fluid. (10)				✓				✓				✓				✓					✓

Footnotes — Maintenance Schedule Additional Required Services - Normal

(1) (1) (1) Vehicles with different size front and rear tires do not have tire rotation. See *Tire Rotation on page 10-76*.

(2) Or every two years, whichever comes first. More frequent replacement may be needed if the vehicle is driven in areas with heavy traffic, areas with poor air quality, or areas with high dust levels. Replacement may also be needed if there is a reduction in air flow, excessive window fogging, or odors.

(3) Check all fuel and vapor lines and hoses for proper hook-up, routing, and condition.

(4) Or every four years, whichever comes first.

(5) Do not directly power wash the transfer case output seals. High pressure water can overcome the seals and contaminate the transfer case fluid. Contaminated fluid will decrease the life of the transfer case and should be replaced.

(6) Or every five years, whichever comes first. See *Cooling System on page 10-18*.

(7) Or every 10 years, whichever comes first. Inspect for fraying, excessive cracking, or damage; replace, if needed.

(8) Inspect for fraying, excessive cracking, or damage; replace, if needed.

(9) Or every 10 years, whichever comes first.

(10) Or every two years, whichever comes first.

Maintenance Schedule Additional Required Services - Severe	12000km/7,500mi	24000km/15,000mi	36000km/22,500mi	48000km/30,000mi	60000km/37,500mi	72000km/45,000mi	84000km/52,500mi	96000km/60,000mi	108000km/67,500mi	120000km/75,000mi	132000km/82,500mi	144000km/90,000mi	156000km/97,500mi	168000km/105,000mi	180000km/112,500mi	192000km/120,000mi	204000km/127,500mi	216000km/135,000mi	228000km/142,500mi	240000km/150,000mi	
Replace brake fluid. (9)																					✓
Replace clutch fluid. (10)			✓				✓					✓				✓					✓

Footnotes — Maintenance Schedule Additional Required Services - Severe

(1) (1) (1) Vehicles with different size front and rear tires do not have tire rotation. See *Tire Rotation* on page 10-76.

(2) Or every two years, whichever comes first. More frequent replacement may be needed if the vehicle is driven in areas with heavy traffic, areas with poor air quality, or areas with high dust levels. Replacement may also be needed if there is a reduction in air flow, excessive window fogging, or odors.

(3) Check all fuel and vapor lines and hoses for proper hook-up, routing, and condition.

(4) Or every four years, whichever comes first.

(5) Do not directly power wash the transfer case output seals. High pressure water can overcome the seals and contaminate the transfer case fluid. Contaminated fluid will decrease the life of the transfer case and should be replaced.

(6) Or every five years, whichever comes first. See *Cooling System* on page 10-18.

(7) Or every 10 years, whichever comes first. Inspect for fraying, excessive cracking, or damage; replace, if needed.

(8) Inspect for fraying, excessive cracking, or damage; replace, if needed.

(9) Or every 10 years, whichever comes first.

(10) Or every two years, whichever comes first.

Special Application Services

- Severe Commercial Use Vehicles Only: Lubricate chassis components every 5 000 km/ 3,000 mi.
- Have underbody flushing service performed once a year. See "Underbody Maintenance" in *Exterior Care on page 10-112*.

Additional Maintenance and Care

Your vehicle is an important investment and caring for it properly may help to avoid future costly repairs. To maintain vehicle performance, additional maintenance services may be required.

It is recommended that your dealer perform these services — their trained dealer technicians know your vehicle best. Your dealer can also perform a thorough assessment with a multi-point inspection to recommend when your vehicle may need attention.

The following list is intended to explain the services and conditions to look for that may indicate services are required.

Battery

The battery supplies power to start the engine and operate any additional electrical accessories.

- To avoid break-down or failure to start the vehicle, maintain a battery with full cranking power.
- Trained dealer technicians have the diagnostic equipment to test the battery and ensure that the connections and cables are corrosion-free.

Belts

- Belts may need replacing if they squeak or show signs of cracking or splitting.
- Trained dealer technicians have access to tools and equipment to inspect the belts and recommend adjustment or replacement when necessary.

Brakes

Brakes stop the vehicle and are crucial to safe driving.

- Signs of brake wear may include chirping, grinding, or squealing noises, or difficulty stopping.
- Trained dealer technicians have access to tools and equipment to inspect the brakes and recommend quality parts engineered for the vehicle.

Fluids

Proper fluid levels and approved fluids protect the vehicle's systems and components. See *Recommended Fluids and Lubricants on page 11-13* for GM approved fluids.

- Engine oil and windshield washer fluid levels should be checked at every fuel fill.

- Instrument cluster lights may come on to indicate that fluids may be low and need to be filled.

Hoses

Hoses transport fluids and should be regularly inspected to ensure that there are no cracks or leaks. With a multi-point inspection, your dealer can inspect the hoses and advise if replacement is needed.

Lamps

Properly working headlamps, taillamps, and brake lamps are important to see and be seen on the road.

- Signs that the headlamps need attention include dimming, failure to light, cracking, or damage. The brake lamps need to be checked periodically to ensure that they light when braking.

- With a multi-point inspection, your dealer can check the lamps and note any concerns.

Shocks and Struts

Shocks and struts help aid in control for a smoother ride.

- Signs of wear may include steering wheel vibration, bounce/sway while braking, longer stopping distance, or uneven tire wear.
- As part of the multi-point inspection, trained dealer technicians can visually inspect the shocks and struts for signs of leaking, blown seals, or damage, and can advise when service is needed.

11-12 Service and Maintenance

Tires

Tires need to be properly inflated, rotated, and balanced. Maintaining the tires can save money and fuel, and can reduce the risk of tire failure.

- Signs that the tires need to be replaced include three or more visible treadwear indicators; cord or fabric showing through the rubber; cracks or cuts in the tread or sidewall; or a bulge or split in the tire.
- Trained dealer technicians can inspect and recommend the right tires. Your dealer can also provide tire/wheel balancing services to ensure smooth vehicle operation at all speeds. Your dealer sells and services name brand tires.

Vehicle Care

To help keep the vehicle looking like new, vehicle care products are available from your dealer. For information on how to clean and protect the vehicle's interior and exterior, see *Interior Care on page 10-116* and *Exterior Care on page 10-112*.

Wheel Alignment

Wheel alignment is critical for ensuring that the tires deliver optimal wear and performance.

- Signs that the alignment may need to be adjusted include pulling, improper vehicle handling, or unusual tire wear.
- Your dealer has the required equipment to ensure proper wheel alignment.

Windshield

For safety, appearance, and the best viewing, keep the windshield clean and clear.

- Signs of damage include scratches, cracks, and chips.
- Trained dealer technicians can inspect the windshield and recommend proper replacement if needed.

Wiper Blades

Wiper blades need to be cleaned and kept in good condition to provide a clear view.

- Signs of wear include streaking, skipping across the windshield, and worn or split rubber.
- Trained dealer technicians can check the wiper blades and replace them when needed.

Recommended Fluids, Lubricants, and Parts

Recommended Fluids and Lubricants

Usage	Fluid/Lubricant
Engine Oil	Use only engine oil licensed to the dexos1 specification of the proper SAE viscosity grade. ACDelco dexos1 Synthetic Blend is recommended. See <i>Engine Oil on page 10-10</i> .
Engine Coolant	50/50 mixture of clean, drinkable water and use only DEX-COOL Coolant. See <i>Engine Coolant on page 10-19</i> .
Fuel Additive	Fuel System Treatment PLUS (Part number 88861013). See <i>Fuel Additives on page 9-50</i> .
Hydraulic Brake System	DOT 3 Hydraulic Brake Fluid (GM Part No. 19299818, in Canada 19299819).
Windshield Washer	Automotive windshield washer fluid that meets regional freeze protection requirements.
Hydraulic Power Steering System	GM Power Steering Fluid (GM Part No. 89021185, in Canada 89021186).
Hydraulic Clutch System	DOT 4 Hydraulic Clutch Fluid (GM Part No. 19299570, in Canada 19299571).
Manual Transmission (CTS)	SAE 75W-90 GL5 Gear Oil (GM Part No. 88862475, in Canada 88862476).
Manual Transmission (CTS-V)	Manual Transmission Fluid (GM Part No. 88861800, in Canada 88861801).
Automatic Transmission	DEXRON®-VI Automatic Transmission Fluid.

11-14 Service and Maintenance

Usage	Fluid/Lubricant
Transfer Case (All-Wheel Drive)	Transfer Case Fluid (GM Part No. 88861950, in Canada 88861951).
Rear Drive Module	SAE 75W-90 Synthetic Axle Lubricant (GM Part No. 89021677, in Canada 89021678) meeting GM Specification 9986115.
Rear Drive Module (Limited-Slip Differential)	SAE 75W-90 Synthetic Axle Lubricant (GM Part No. 89021677, in Canada 89021678) meeting GM Specification 9986115. With a complete drain and refill, add 118 ml (4 oz) of Limited-Slip Axle Lubricant Additive (GM Part No. 88900330, in Canada 992694) where required.
Chassis Lubrication	Chassis Lubricant (GM Part No. 12377985, in Canada 88901242) or lubricant meeting requirements of NLGI #2, Category LB or GC-LB.
Key Lock Cylinders	Multi-Purpose Lubricant, Superlube (GM Part No. 12346241, in Canada 10953474).
Hood Latch Assembly, Secondary Latch, Pivots, Spring Anchor, and Release Pawl	Lubriplate Lubricant Aerosol (GM Part No. 89021668, in Canada 89021674) or lubricant meeting requirements of NLGI #2, Category LB or GC-LB.
Hood and Door Hinges	Multi-Purpose Lubricant, Superlube (GM Part No. 12346241, in Canada 10953474).
Power Liftgate Actuator Ball Joint	Multi-Purpose Lubricant (GM Part No. 89021668, in Canada 89021674).
Weatherstrip Conditioning	Weatherstrip Lubricant (GM Part No. 3634770, in Canada 10953518) or Dielectric Silicone Grease (GM Part No. 12345579, in Canada 10953481).

Maintenance Replacement Parts

Replacement parts identified below by name, part number, or specification can be obtained from your dealer.

Part	GM Part Number	ACDelco Part Number
Engine Air Cleaner/Filter		
3.0L V6 Engine	15875795	A3096C
3.6L V6 Engine	15875795	A3096C
6.2L V8 Engine	25898499	A3105C
Engine Oil Filter		
3.0L V6 Engine	25177917	PF2129
3.6L V6 Engine	25177917	PF2129
6.2L V8 Engine	89017524	PF48
Passenger Compartment Air Filter	19130403	CF133
Spark Plugs		
3.0L V6 Engine	12622561	41-109
3.6L V6 Engine	12622561	41-109
6.2L V8 Engine	12571165	41-104

11-16 Service and Maintenance

Part	GM Part Number	ACDelco Part Number
Wiper Blades — Except CTS-V		
Driver Side – 56.5 cm (22 in)	15890062	—
Passenger Side – 53.3 cm (21 in)	15890064	—
Wiper Blades — CTS-V		
Driver Side – 56.5 cm (22 in)	20791461	—
Passenger Side – 53.3 cm (21 in)	20791462	—
Rear Wiper Blade (Wagon) – 30.5 cm (12 in)	20825882	—

Technical Data

Vehicle Identification

Vehicle Identification Number (VIN)	12-1
Service Parts Identification Label	12-1

Vehicle Data

Capacities and Specifications	12-2
Engine Drive Belt Routing ...	12-4

Vehicle Identification

Vehicle Identification Number (VIN)



This legal identifier is in the front corner of the instrument panel, on the left side of the vehicle. It can be seen through the windshield from outside. The VIN also appears on the Vehicle Certification and Service Parts labels and certificates of title and registration.

Engine Identification

The eighth character in the VIN is the engine code. This code identifies the vehicle's engine, specifications, and replacement parts. See "Engine Specifications" under *Capacities and Specifications* on page 12-2 for the vehicle's engine code.

Service Parts Identification Label

This label, on the spare tire cover, has the following information:

- Vehicle Identification Number (VIN).
- Model designation.
- Paint information.
- Production options and special equipment.

Do not remove this label from the vehicle.

Vehicle Data

Capacities and Specifications

The following approximate capacities are given in metric and English conversions. See *Recommended Fluids and Lubricants on page 11-13* for more information.

Application	Capacities	
	Metric	English
Air Conditioning Refrigerant	For the air conditioning system refrigerant type and charge amount, see the refrigerant label under the hood. See your dealer for more information.	
Cooling System— Engine		
3.0L V6 Engine	10.3 L	10.9 qt
3.6L V6 Engine	11.3 L	11.9 qt
6.2L V8 Engine	11.8 L	12.5 qt
Cooling System— Intercooler, 6.2L V8 Engine	2.3 L	2.4 qt
Engine Oil with Filter		
3.0L V6 Engine	5.7 L	6.0 qt
3.6L V6 Engine	5.7 L	6.0 qt
6.2L V8 Engine	5.7 L	6.0 qt

Application	Capacities	
	Metric	English
Fuel Tank	68.1 L	18.0 gal
Transfer Case— AWD	1.0 L	1.1 qt
Wheel Nut Torque	150 N•m	110 lb ft
All capacities are approximate. When adding, be sure to fill to the approximate level, as recommended in this manual. Recheck fluid level after filling.		

Engine Specifications

Engine	VIN Code	Transmission	Spark Plug Gap
3.0L V6 Engine	5	Automatic Manual	0.95–1.10 mm (0.037– 0.043 in)
3.6L V6 Engine	3	Automatic	0.95–1.10 mm (0.037– 0.043 in)
6.2L V8 Engine	P	Automatic Manual	0.95–1.10 mm (0.037– 0.043 in)

Engine Drive Belt Routing

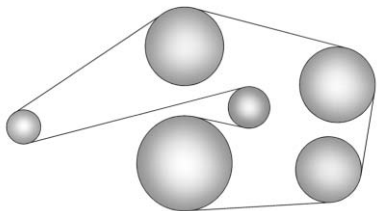

CTS V6 Engine

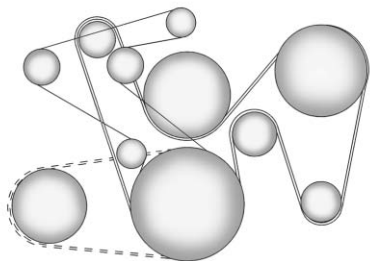

CTS-V 6.2L V8 Engine

Customer Information

Customer Information

Customer Satisfaction Procedure	13-1
Customer Assistance Offices	13-3
Customer Assistance for Text Telephone (TTY) Users	13-4
Online Owner Center	13-4
GM Mobility Reimbursement Program	13-5
Roadside Service	13-5
Scheduling Service Appointments	13-7
Courtesy Transportation Program	13-8
Collision Damage Repair	13-9
Service Publications Ordering Information	13-11

Reporting Safety Defects

Reporting Safety Defects to the United States Government	13-12
Reporting Safety Defects to the Canadian Government	13-13
Reporting Safety Defects to General Motors	13-13

Vehicle Data Recording and Privacy

Vehicle Data Recording and Privacy	13-14
Event Data Recorders	13-14
OnStar®	13-15
Navigation System	13-15
Radio Frequency Identification (RFID)	13-15
Radio Frequency Statement	13-15

Customer Information

Customer Satisfaction Procedure

Your satisfaction and goodwill are important to your dealer and to Cadillac. Normally, any concerns with the sales transaction or the operation of the vehicle will be resolved by your dealer's sales or service departments. Sometimes, however, despite the best intentions of all concerned, misunderstandings can occur. If your concern has not been resolved to your satisfaction, the following steps should be taken:

STEP ONE: Discuss your concern with a member of dealership management. Normally, concerns can be quickly resolved at that level. If the matter has already been reviewed with the sales, service or parts manager, contact the owner of your dealership or the general manager.

13-2 Customer Information

STEP TWO: If after contacting a member of dealership management, it appears your concern cannot be resolved by your dealership without further help, in the U.S., call the Cadillac Customer Assistance Center at 1-800-458-8006. In Canada, call the Canadian Cadillac Customer Care Centre at 1-888-446-2000.

We encourage you to call the toll-free number in order to give your inquiry prompt attention. Have the following information available to give the Customer Assistance representative:

- Vehicle Identification Number (VIN). This is available from the vehicle registration or title, or the plate at the top left of the instrument panel and visible through the windshield.
- Dealership name and location.
- Vehicle delivery date and present mileage.

When contacting Cadillac, remember that your concern will likely be resolved at a dealer's facility. That is why we suggest following Step One first.

STEP THREE — U.S. Owners:

Both General Motors and your dealer are committed to making sure you are completely satisfied with the new vehicle. However, if you continue to remain unsatisfied after following the procedure outlined in Steps One and Two, you can file with the Better Business Bureau (BBB) Auto Line® Program to enforce your rights.

The BBB Auto Line Program is an out-of-court program administered by the Council of Better Business Bureaus to settle automotive disputes regarding vehicle repairs or the interpretation of the New Vehicle Limited Warranty. Although you may be required to resort to this informal dispute resolution program prior to filing a court action, use of the program is free of charge and your case will generally be heard within

40 days. If you do not agree with the decision given in your case, you may reject it and proceed with any other venue for relief available to you.

You may contact the BBB Auto Line Program using the toll-free telephone number or write them at the following address:

BBB Auto Line Program
Council of Better Business
Bureaus, Inc.
4200 Wilson Boulevard
Suite 800
Arlington, VA 22203-1838

Telephone: 1-800-955-5100
www.dr.bbb.org/goauto

This program is available in all 50 states and the District of Columbia. Eligibility is limited by vehicle age, mileage, and other factors. General Motors reserves the right to change eligibility limitations and/or discontinue its participation in this program.

STEP THREE — Canadian

Owners: In the event that you do not feel your concerns have been addressed after following the procedure outlined in Steps One and Two, General Motors of Canada Limited wants you to be aware of its participation in a no-charge mediation/arbitration program. General Motors of Canada Limited has committed to binding arbitration of owner disputes involving factory-related vehicle service claims. The program provides for the review of the facts involved by an impartial third party arbiter, and may include an informal hearing before the arbiter. The program is designed so that the entire dispute settlement process, from the time you file your complaint to the final decision, should be completed in approximately 70 days. We believe

our impartial program offers advantages over courts in most jurisdictions because it is informal, quick, and free of charge.

For further information concerning eligibility in the Canadian Motor Vehicle Arbitration Plan (CAMVAP), call toll-free 1-800-207-0685, or call the General Motors Customer Care Centre, 1-888-446-2000 (English), 1-800-263-7854 (French), or write to:

Mediation/Arbitration Program
c/o Customer Care Centre
General Motors of Canada Limited
Mail Code: CA1-163-005
1908 Colonel Sam Drive
Oshawa, Ontario L1H 8P7

The inquiry should be accompanied by the Vehicle Identification Number (VIN).

Customer Assistance Offices

Cadillac encourages customers to call the toll-free number for assistance. However, if a customer wishes to write or e-mail Cadillac, the letter should be addressed to:

United States and Puerto Rico

Cadillac Customer Assistance Center
Cadillac Motor Car Division
P.O. Box 33169
Detroit, MI 48232-5169
www.Cadillac.com

1-800-458-8006
1-800-833-2622 (For Text Telephone devices (TTYs))
Roadside Service: 1-800-224-1400

From U.S. Virgin Islands:
1-800-496-9994

13-4 Customer Information

Canada

General Motors of Canada Limited
Canadian Cadillac Customer Care
Centre, Mail Code: CA1-163-005
1908 Colonel Sam Drive
Oshawa, Ontario L1H 8P7
www.gm.ca

1-888-446-2000 (English)
1-800-263-7854 (French)
Roadside Service: 1-800-882-1112

Overseas

Contact the local General Motors
Business Unit.

Customer Assistance for Text Telephone (TTY) Users

To assist customers who are deaf,
hard of hearing, or speech-impaired
and who use Text Telephones
(TTYs), Cadillac has TTY equipment
available at its Customer Assistance
Center. Any TTY user can

communicate with Cadillac by
dialing: 1-800-833-2622. TTY users
in Canada can dial 1-800-263-3830.

Online Owner Center

Online Owner Experience (U.S.) my.cadillac.com

The Cadillac online owner
experience is a one-stop resource
that allows interaction with Cadillac
and keeps important vehicle-specific
information in one place.

Membership Benefits

 **(Vehicle Information):**
Download owner manuals and view
vehicle-specific how-to videos.

 **(Maintenance Information):**
View maintenance schedules,
required alerts, OnStar onboard
vehicle diagnostic information, and
schedule service appointments.

 **(Service History):** View
printable dealer-recorded service
records and self-recorded service
records.

 **(Preferred Dealer
Information):** Select a preferred
dealer and view dealer location,
maps, phone numbers, and hours.

 **(Warranty Tracking
Information):** Track the vehicle's
warranty information.

 **(Recall Information):** View
active recalls or search by Vehicle
Identification Number (VIN). See
Vehicle Identification Number (VIN)
on page 12-1.

 **(Other Account Information):**
View GM Card, SiriusXM Satellite
radio, and OnStar account
information.

 **(Live Chat Support):** Chat live
with online help representatives.

Visit my.cadillac.com to register your
vehicle.

Cadillac Owner Centre (Canada) cadillacowner.ca

Take a trip to the Cadillac Owner Centre:

- Chat live with online help representatives.
- Locate owner resources such as lease-end, financing, and warranty information.
- Retrieve favorite articles, quizzes, tips, and multimedia galleries organized into the Features and Auto Care Sections.
- Download owner manuals.
- Find Cadillac-recommended maintenance services.

GM Mobility Reimbursement Program



This program is available to qualified applicants for cost reimbursement of eligible aftermarket adaptive equipment required for the vehicle, such as hand controls or a wheelchair/scooter lift for the vehicle.

For more information on the limited offer, visit www.gmmobility.com or call the GM Mobility Assistance Center at 1-800-323-9935. Text Telephone (TTY) users, call 1-800-833-9935.

General Motors of Canada also has a Mobility Program. Visit www.gm.ca or call 1-800-GM-DRIVE (463-7483) for details. TTY users call 1-800-263-3830.

Roadside Service

U.S.: 1-800-224-1400.

Canada: 1-800-882-1112.

Text Telephone (TTY) Users (U.S. Only): 1-888-889-2438.

Service is available 24 hours a day, 365 days a year.

Calling for Service

When calling Roadside Service, have the following information ready:

- Your name, home address, and home telephone number.
- Telephone number of your location.
- Location of the vehicle.
- Model, year, color, and license plate number of the vehicle.

13-6 Customer Information

- Odometer reading, Vehicle Identification Number (VIN), and delivery date of the vehicle.
- Description of the problem.

Coverage

Services are provided up to 6 years/110 000 km (70,000 mi), whichever comes first.

In the U.S., anyone driving the vehicle is covered. In Canada, a person driving the vehicle without permission from the owner is not covered.

Roadside Service is not a part of the New Vehicle Limited Warranty. Cadillac and General Motors of Canada Limited reserve the right to make any changes or discontinue the Roadside Service program at any time without notification.

Cadillac and General Motors of Canada Limited reserve the right to limit services or payment to an owner or driver if they decide the

claims are made too often, or the same type of claim is made many times.

Cadillac Owner Privileges™

- **Emergency Fuel Delivery:** Delivery of enough fuel for the vehicle to get to the nearest service station.
- **Lock-Out Service:** Service to unlock the vehicle if you are locked out. A remote unlock may be available if you have OnStar. For security reasons, the driver must present identification before this service is given.
- **Emergency Tow from a Public Road or Highway:** Tow to the nearest Cadillac dealer for warranty service, or if the vehicle was in a crash and cannot be driven. Assistance is also given when the vehicle is stuck in the sand, mud, or snow.

- **Flat Tire Change:** Service to change a flat tire with a spare tire. The spare tire, if equipped, must be in good condition and properly inflated. It is your responsibility for the repair or replacement of the tire if it is not covered by the warranty.
- **Battery Jump Start:** Service to jump start a dead battery.
- **Trip Interruption Benefits and Service:** If your trip is interrupted due to a warranty failure, incidental expenses may be reimbursed during the 6 years/110 000 km (70,000 mi) Powertrain warranty period. Items considered are hotel, meals, and rental car.

Cadillac Technician Roadside Service (U.S. Only)

Cadillac's exceptional Roadside Service is more than an auto club or towing service. It provides every Cadillac owner in the United States with the advantage of contacting a Cadillac advisor and, where

available, a Cadillac trained dealer technician who can provide on-site service.

A dealer technician will travel to your location within a 30-mile radius of a participating Cadillac dealership. If beyond this radius, we will arrange to have your car towed to the nearest Cadillac dealership. Each technician travels with a specially equipped service vehicle complete with the necessary Cadillac parts and tools required to handle most roadside repairs.

Services Not Included in Roadside Service

- Impound towing caused by violation of any laws.
- Legal fines.
- Mounting, dismounting, or changing of snow tires, chains, or other traction devices.
- Towing or services for vehicles driven on a non-public road or highway.

Services Specific to Canadian-Purchased Vehicles

- **Fuel delivery:** Reimbursement is approximately \$5 Canadian. Diesel fuel delivery may be restricted. Propane and other fuels are not provided through this service.
- **Lock-Out Service:** Vehicle registration is required.
- **Trip Interruption Benefits and Service:** Pre-authorization, original detailed receipts, and a copy of the repair orders are required. Once authorization has been received, the Roadside Service advisor will help you make arrangements and explain how to receive payment.
- **Alternative Service:** If assistance cannot be provided right away, the Roadside Service advisor may give you permission to get local emergency road service. You will receive payment, up to \$100, after sending the original receipt to

Roadside Service. Mechanical failures may be covered, however any cost for parts and labor for repairs not covered by the warranty are the owner responsibility.

Scheduling Service Appointments

When the vehicle requires warranty service, contact your dealer and request an appointment. By scheduling a service appointment and advising the service consultant of your transportation needs, your dealer can help minimize your inconvenience.

If the vehicle cannot be scheduled into the service department immediately, keep driving it until it can be scheduled for service, unless, of course, the problem is safety related. If it is, please call your dealership, let them know this, and ask for instructions.

13-8 Customer Information

If your dealer requests you to bring the vehicle for service, you are urged to do so as early in the work day as possible to allow for same-day repair.

Courtesy Transportation Program

To enhance your ownership experience, we and our participating dealers are proud to offer Courtesy Transportation, a customer support program for vehicles with the Bumper-to-Bumper (Base Warranty Coverage period in Canada), extended powertrain, and/or hybrid-specific warranties in both the U.S. and Canada.

Several Courtesy Transportation options are available to assist in reducing inconvenience when warranty repairs are required.

Courtesy Transportation is not a part of the New Vehicle Limited Warranty. A separate booklet entitled "Limited Warranty and Owner Assistance Information"

furnished with each new vehicle provides detailed warranty coverage information.

Transportation Options

Warranty service can generally be completed while you wait. However, if you are unable to wait, GM helps to minimize inconvenience by providing several transportation options. Depending on the circumstances, your dealer can offer one of the following:

Shuttle Service

Shuttle service is the preferred means of offering Courtesy Transportation. Dealers may provide shuttle service to get you to your destination with minimal interruption of your daily schedule. This includes one-way or round-trip shuttle service within reasonable time and distance parameters of your dealer's area.

Public Transportation or Fuel Reimbursement

If the vehicle requires overnight warranty repairs, and public transportation is used instead of your dealer's shuttle service, the expense must be supported by original receipts and can only be up to the maximum amount allowed by GM for shuttle service. In addition, for U.S. customers, should you arrange transportation through a friend or relative, limited reimbursement for reasonable fuel expenses may be available. Claim amounts should reflect actual costs and be supported by original receipts. See your dealer for information regarding the allowance amounts for reimbursement of fuel or other transportation costs.

Courtesy Rental Vehicle

Your dealer may arrange to provide you with a courtesy rental vehicle or reimburse you for a rental vehicle that you obtain if the vehicle is kept for an overnight warranty repair.

Rental reimbursement will be limited and must be supported by original receipts. This requires that you sign and complete a rental agreement and meet state/provincial, local, and rental vehicle provider requirements. Requirements vary and may include minimum age requirements, insurance coverage, credit card, etc. You are responsible for fuel usage charges and may also be responsible for taxes, levies, usage fees, excessive mileage, or rental usage beyond the completion of the repair.

It may not be possible to provide a like vehicle as a courtesy rental.

Additional Program Information

All program options, such as shuttle service, may not be available at every dealer. Please contact your dealer for specific information about availability. All Courtesy Transportation arrangements will be administered by appropriate dealer personnel.

General Motors reserves the right to unilaterally modify, change, or discontinue Courtesy Transportation at any time and to resolve all questions of claim eligibility pursuant to the terms and conditions described herein at its sole discretion.

Collision Damage Repair

If the vehicle is involved in a collision and it is damaged, have the damage repaired by a qualified technician using the proper equipment and quality replacement parts. Poorly performed collision repairs diminish the vehicle resale value, and safety performance can be compromised in subsequent collisions.

Collision Parts

Genuine GM Collision parts are new parts made with the same materials and construction methods as the parts with which the vehicle was originally built. Genuine GM

Collision parts are the best choice to ensure that the vehicle's designed appearance, durability, and safety are preserved. The use of Genuine GM parts can help maintain the GM New Vehicle Limited Warranty.

Recycled original equipment parts may also be used for repair. These parts are typically removed from vehicles that were total losses in prior crashes. In most cases, the parts being recycled are from undamaged sections of the vehicle. A recycled original equipment GM part may be an acceptable choice to maintain the vehicle's originally designed appearance and safety performance; however, the history of these parts is not known. Such parts are not covered by the GM New Vehicle Limited Warranty, and any related failures are not covered by that warranty.

Aftermarket collision parts are also available. These are made by companies other than GM and may not have been tested for the vehicle.

13-10 Customer Information

As a result, these parts may fit poorly, exhibit premature durability/corrosion problems, and may not perform properly in subsequent collisions. Aftermarket parts are not covered by the GM New Vehicle Limited Warranty, and any vehicle failure related to such parts is not covered by that warranty.

Repair Facility

GM also recommends that you choose a collision repair facility that meets your needs before you ever need collision repairs. Your dealer may have a collision repair center with GM-trained technicians and state-of-the-art equipment, or be able to recommend a collision repair center that has GM-trained technicians and comparable equipment.

Insuring the Vehicle

Protect your investment in the GM vehicle with comprehensive and collision insurance coverage. There are significant differences in the

quality of coverage afforded by various insurance policy terms. Many insurance policies provide reduced protection to the GM vehicle by limiting compensation for damage repairs by using aftermarket collision parts. Some insurance companies will not specify aftermarket collision parts. When purchasing insurance, we recommend that you ensure that the vehicle will be repaired with GM original equipment collision parts. If such insurance coverage is not available from your current insurance carrier, consider switching to another insurance carrier.

If the vehicle is leased, the leasing company may require you to have insurance that ensures repairs with Genuine GM Original Equipment Manufacturer (OEM) parts or Genuine Manufacturer replacement parts. Read the lease carefully, as you may be charged at the end of the lease for poor quality repairs.

If a Crash Occurs

If there has been an injury, call emergency services for help. Do not leave the scene of a crash until all matters have been taken care of. Move the vehicle only if its position puts you in danger, or you are instructed to move it by a police officer.

Give only the necessary information to police and other parties involved in the crash.

For emergency towing see *Roadside Service on page 13-5*.

Gather the following information:

- Driver name, address, and telephone number.
- Driver license number.
- Owner name, address, and telephone number.
- Vehicle license plate number.
- Vehicle make, model, and model year.

- Vehicle Identification Number (VIN).
- Insurance company and policy number.
- General description of the damage to the other vehicle.

Choose a reputable repair facility that uses quality replacement parts. See “Collision Parts” earlier in this section.

If the airbag has inflated, see *What Will You See after an Airbag Inflates?* on page 3-25.

Managing the Vehicle Damage Repair Process

In the event that the vehicle requires damage repairs, GM recommends that you take an active role in its repair. If you have a pre-determined repair facility of choice, take the vehicle there, or have it towed there. Specify to the facility that any required replacement collision parts be original equipment parts, either

new Genuine GM parts or recycled original GM parts. Remember, recycled parts will not be covered by the GM vehicle warranty.

Insurance pays the bill for the repair, but you must live with the repair. Depending on your policy limits, your insurance company may initially value the repair using aftermarket parts. Discuss this with the repair professional, and insist on Genuine GM parts. Remember, if the vehicle is leased, you may be obligated to have the vehicle repaired with Genuine GM parts, even if your insurance coverage does not pay the full cost.

If another party's insurance company is paying for the repairs, you are not obligated to accept a repair valuation based on that insurance company's collision policy repair limits, as you have no contractual limits with that company.

In such cases, you can have control of the repair and parts choices as long as the cost stays within reasonable limits.

Service Publications Ordering Information

Service Manuals

Service Manuals have the diagnosis and repair information on the engines, transmission, axle, suspension, brakes, electrical, steering, body, etc.

Service Bulletins

Service Bulletins give additional technical service information needed to knowledgeably service General Motors cars and trucks. Each bulletin contains instructions to assist in the diagnosis and service of the vehicle.

13-12 Customer Information

Owner Information

Owner publications are written specifically for owners and intended to provide basic operational information about the vehicle. The Owner Manual includes the Maintenance Schedule for all models.

In-Portfolio: Includes a Portfolio, Owner Manual, and Warranty Manual.

RETAIL SELL PRICE:
\$35.00 (U.S.) plus handling and shipping fees.

Without Portfolio: Owner Manual only.

RETAIL SELL PRICE:
\$25.00 (U.S.) plus handling and shipping fees.

Current and Past Models

Technical Service Bulletins and Manuals are available for current and past model GM vehicles.

ORDER TOLL FREE:
1-800-551-4123 Monday – Friday
8:00 AM – 6:00 PM Eastern Time

For Credit Card Orders Only
(VISA-MasterCard-Discover), see
Helm, Inc. at: www.helminc.com.

Or write to:

Helm, Incorporated
Attention: Customer Service
47911 Halyard Drive
Plymouth, MI 48170

Prices are subject to change without notice and without incurring obligation. Allow ample time for delivery.

All listed prices are quoted in U.S. funds. Make checks payable in U.S. funds.

Reporting Safety Defects

Reporting Safety Defects to the United States Government

If you believe that your vehicle has a defect which could cause a crash or could cause injury or death, you should immediately inform the National Highway Traffic Safety Administration (NHTSA) in addition to notifying General Motors.

If NHTSA receives similar complaints, it may open an investigation, and if it finds that a safety defect exists in a group of vehicles, it may order a recall and remedy campaign.

However, NHTSA cannot become involved in individual problems between you, your dealer, or General Motors.

To contact NHTSA, you may call the Vehicle Safety Hotline toll-free at 1-888-327-4236 (TTY: 1-800-424-9153); go to <http://www.safercar.gov>; or write to:

Administrator, NHTSA
1200 New Jersey Avenue, S.E.
Washington, D.C. 20590

You can also obtain other information about motor vehicle safety from <http://www.safercar.gov>.

Reporting Safety Defects to the Canadian Government

If you live in Canada, and you believe that the vehicle has a safety defect, notify Transport Canada immediately, and notify General Motors of Canada Limited. Call Transport Canada at 1-800-333-0510 or write to:

Transport Canada
Road Safety Branch
80 rue Noel
Gatineau, QC J8Z 0A1

Reporting Safety Defects to General Motors

In addition to notifying NHTSA (or Transport Canada) in a situation like this, notify General Motors.

Call 1-800-458-8006, or write:

Cadillac Customer Assistance Center
Cadillac Motor Car Division
P.O. Box 33169
Detroit, MI 48232-5169

In Canada, call 1-888-446-2000, or write:

Canadian Cadillac Customer Care Centre, Mail Code: CA1-163-005
General Motors of Canada Limited
1908 Colonel Sam Drive
Oshawa, Ontario L1H 8P7

Vehicle Data Recording and Privacy

The vehicle has a number of computers that record information about the vehicle's performance and how it is driven. For example, the vehicle uses computer modules to monitor and control engine and transmission performance, to monitor the conditions for airbag deployment and deploy them in a crash, and, if equipped, to provide antilock braking to help the driver control the vehicle. These modules may store data to help the dealer technician service the vehicle. Some modules may also store data about how the vehicle is operated, such as rate of fuel consumption or average speed. These modules may retain personal preferences, such as radio presets, seat positions, and temperature settings.

Event Data Recorders

This vehicle is equipped with an event data recorder (EDR). The main purpose of an EDR is to record, in certain crash or near crash-like situations, such as an air bag deployment or hitting a road obstacle, data that will assist in understanding how a vehicle's systems performed. The EDR is designed to record data related to vehicle dynamics and safety systems for a short period of time, typically 30 seconds or less. The EDR in this vehicle is designed to record such data as:

- How various systems in your vehicle were operating;
- Whether or not the driver and passenger safety belts were buckled/fastened;
- How far (if at all) the driver was depressing the accelerator and/or brake pedal; and,
- How fast the vehicle was traveling.

These data can help provide a better understanding of the circumstances in which crashes and injuries occur. NOTE: EDR data are recorded by your vehicle only if a non-trivial crash situation occurs; no data are recorded by the EDR under normal driving conditions and no personal data (e.g., name, gender, age, and crash location) are recorded. However, other parties, such as law enforcement, could combine the EDR data with the type of personally identifying data routinely acquired during a crash investigation.

To read data recorded by an EDR, special equipment is required, and access to the vehicle or the EDR is needed. In addition to the vehicle manufacturer, other parties, such as law enforcement, that have the special equipment, can read the information if they have access to the vehicle or the EDR.

GM will not access this data or share it with others except: with the consent of the vehicle owner or, if the vehicle is leased, with the consent of the lessee; in response to an official request by police or similar government office; as part of GM's defense of litigation through the discovery process; or, as required by law. Data that GM collects or receives may also be used for GM research needs or may be made available to others for research purposes, where a need is shown and the data is not tied to a specific vehicle or vehicle owner.

OnStar®

If the vehicle is equipped with OnStar® and has an active subscription, additional data may be collected through the OnStar system. This includes information about the vehicle's operation; about collisions involving the vehicle; the use of the vehicle and its features; and, in certain situations, the location and approximate GPS

speed of the vehicle. Refer to the OnStar Terms and Conditions and Privacy Statement on the OnStar website.

Navigation System

If the vehicle is equipped with a navigation system, use of the system may result in the storage of destinations, addresses, telephone numbers, and other trip information. See the navigation manual for information on stored data and for deletion instructions.

Radio Frequency Identification (RFID)

RFID technology is used in some vehicles for functions such as tire pressure monitoring and ignition system security, as well as in connection with conveniences such as Remote Keyless Entry (RKE) transmitters for remote door locking/unlocking and starting, and in-vehicle transmitters for garage door openers. RFID technology in

GM vehicles does not use or record personal information or link with any other GM system containing personal information.

Radio Frequency Statement

This vehicle has systems that operate on a radio frequency that comply with Part 15 of the Federal Communications Commission (FCC) rules and with Industry Canada Standards RSS-GEN/210/220/310.

Operation is subject to the following two conditions:

1. The device may not cause harmful interference.
2. The device must accept any interference received, including interference that may cause undesired operation of the device.

Changes or modifications to any of these systems by other than an authorized service facility could void authorization to use this equipment.

OnStar

OnStar Overview

OnStar Overview 14-1

OnStar Services

Emergency 14-2
 Security 14-2
 Navigation 14-2
 Connections 14-3
 Diagnostics 14-5

OnStar Additional Information

OnStar Additional Information 14-5

OnStar Overview



If equipped, this vehicle has a comprehensive, in-vehicle system that can connect to a live Advisor for Emergency, Security, Navigation, Connection, and Diagnostic Services.

The OnStar system status light is next to the OnStar buttons. If the status light is:

- Solid Green: System is ready.
- Flashing Green: On a call.
- Red: Indicates a problem.

Press  or call 1-888-4-ONSTAR (1-888-466-7827) to speak to an Advisor.

Press  to:

- Make a call, end a call, or answer an incoming call.
- Give OnStar Hands-Free Calling voice commands.
- Give OnStar Turn-by-Turn Navigation voice commands. Requires the available Directions and Connections service plan.

Press  to connect to a live Advisor to:

- Verify account information or update contact information.
- Get driving directions. Requires the available Directions and Connections service plan.
- Receive On-Demand Diagnostics for a check of the vehicle's key operating systems.
- Receive Roadside Assistance.

Press the OnStar Emergency button  to get a priority connection to an Emergency Advisor available 24/7 to:

- Get help for an emergency.
- Be a Good Samaritan or respond to an AMBER Alert.
- Get assistance in severe weather or other crisis and evacuation routes.

OnStar Services

Emergency

With Automatic Crash Response, the built-in system can automatically connect to help in most crashes, even if help cannot be requested.

Press  to connect to an Emergency Advisor. GPS technology is used to identify the vehicle location and can provide critical information to emergency personnel. The Advisor is also trained to offer critical assistance in emergency situations.

Security

OnStar provides services like Stolen Vehicle Assistance, Remote Ignition Block, and Roadside Assistance, if equipped. OnStar can unlock the vehicle doors remotely, if equipped with automatic door locks, and can help police locate the vehicle if it is stolen.

Navigation

OnStar navigation requires the Directions and Connections service plan.

Press  to receive directions or have them sent to the vehicle navigation screen, if equipped. Destinations can also be forwarded to the vehicle from MapQuest.com. The OnStar mapping database is continuously updated. For coverage maps, see www.onstar.com (U.S.) or www.onstar.ca (Canada).

Turn-by-Turn Navigation

1. Press  to connect to a live Advisor.
2. Request directions.
3. Directions are downloaded to the vehicle.
4. Follow the voice-guided commands.

Using Voice Commands During a Planned Route

Cancel Route

1. Press . System responds: "OnStar ready," then a tone. Say "Cancel route." System responds: "Do you want to cancel directions?"
2. Say "Yes." System responds: "OK, request completed, thank you, goodbye."

Route Preview

1. Press . System responds: "OnStar ready," then a tone.
2. Say "Route preview." System responds with the next three maneuvers.

Repeat

1. Press . System responds: "OnStar ready," then a tone.

2. Say "Repeat." System responds with the last direction given, then responds with "OnStar ready," then a tone.

Get My Destination

1. Press . System responds: "OnStar ready," then a tone.
2. Say "Get my destination." System responds with address and the distance to the destination, then responds with "OnStar ready," then a tone.

Other Navigation Services Available from OnStar

OnStar eNav: Allows subscribers to send destinations from MapQuest.com to their Turn-by-Turn Navigation or screen-based navigation system. When ready, the directions will be downloaded to the vehicle.

Destination Download: Press , then request the Advisor to download directions to the navigation system in the vehicle.

After the call ends, press the "Go" button on the navigation screen to begin driving directions.

If directions are downloaded to the navigation system, the route can only be canceled through the navigation system.

Destinations can also be downloaded on the go. For information about eNav, Destination Download, and coverage maps see www.onstar.com (U.S.) or www.onstar.ca (Canada).

Connections

OnStar Hands-Free Calling allows calls to be made and received from the vehicle. The vehicle can also be controlled through the OnStar RemoteLink[®] mobile app. For coverage maps, see www.onstar.com (U.S.) or www.onstar.ca (Canada).

OnStar Mobile App

Download the OnStar RemoteLink mobile app to select Apple[®], Android[™], and BlackBerry[®] devices to check vehicle fuel level, oil life, or tire pressure; to start the vehicle (if equipped) or unlock it; or to connect to an OnStar Advisor. For OnStar RemoteLink information and compatibility, see www.onstar.com (U.S.) or www.onstar.ca (Canada).

Hands-Free Calling

1. Press . System responds: "OnStar ready."
2. Say "Call." System responds: "Please say the name or number to call."
3. Say the entire number without pausing, including a "1" and the area code. System responds: "OK calling."

Calling 911 Emergency

1. Press . System responds: "OnStar Ready," followed by a tone.
2. Say "Call." System responds: "Please say the name or number to call."
3. Say "911" without pausing. System responds: "911."
4. Say "Call." System responds: "OK, dialing 911."

Retrieve My Number

1. Press . System responds: "OnStar ready."
2. Say "My number." System responds: "Your OnStar Hands-Free Calling number is," then says the number.

End a Call

Press . System responds: "Call ended."

Store a Name Tag for Speed Dialing

1. Press . System responds: "OnStar ready."
2. Say "Store." System responds: "Please say the number you would like to store."
3. Say the entire number without pausing. System responds: "Please say the name tag."
4. Pick a name tag. System responds: "About to store <name tag>. Does that sound OK?"
5. Say "Yes" or say "No" to try again. System responds: "OK, storing <name tag>."

Place a Call Using a Stored Number

1. Press . System responds: "OnStar ready."
2. Say "Call <name tag>." System responds: "OK, calling <name tag>."

Verify Minutes and Expiration

Press  and say “Minutes” then “Verify” to check how many minutes remain and their expiration date.

Diagnostics

OnStar Vehicle Diagnostics will perform a vehicle check every month. It will check the engine, transmission, antilock brakes, and major vehicle systems. It also checks the tire pressures, if the vehicle is equipped with the Tire Pressure Monitoring System. If an On-Demand Diagnostics check is needed between e-mails, press , and an Advisor can run a check.

OnStar Additional Information

Transferring Service

Press  to request account transfer eligibility information. The Advisor can assist in canceling or removing account information. If OnStar receives information that vehicle ownership has changed, OnStar may send a voice message to the vehicle, requesting updated account information.

Reactivation for Subsequent Owners

Press  and follow the prompts to speak to an Advisor as soon as possible after acquiring the vehicle.

The Advisor will update vehicle records and will explain the OnStar service offers and options available.

How OnStar Service Works

Automatic Crash Response, Emergency Services, Crisis Assist, Stolen Vehicle Assistance, Vehicle Diagnostics, Remote Door Unlock, Roadside Assistance, Turn-by-Turn Navigation, and Hands-Free Calling are available on most vehicles. Not all OnStar services are available everywhere or on all vehicles. For more information, a full description of OnStar services, system limitations, and OnStar terms and conditions:

- Call 888-4-ONSTAR (888-466-7827).
- See www.onstar.com (U.S.).
- See www.onstar.ca (Canada).
- Call TTY 1-877-248-2080.
- Press  to speak with an Advisor.

OnStar services require a vehicle electrical system, wireless service, and GPS satellite technologies to be available and operating for features to function properly. These systems may not operate if the battery is discharged or disconnected.

OnStar service cannot work unless your vehicle is in a place where OnStar has an agreement with a wireless service provider for service in that area, and the wireless service provider has coverage, network capacity, reception, and technology compatible with OnStar service. Service involving location information about the vehicle cannot work unless GPS signals are available, unobstructed, and compatible with the OnStar hardware. OnStar service may not work if the OnStar equipment is not properly installed or it has not been properly maintained. If equipment or software is added, connected, or modified, OnStar service may not work. Other problems beyond the

control of OnStar may prevent service such as hills, tall buildings, tunnels, weather, electrical system design and architecture of the vehicle, damage to the vehicle in a crash, or wireless phone network congestion or jamming.

See *Radio Frequency Statement on page 13-15*.

Services for People with Disabilities

Advisors provide services to help subscribers with physical disabilities and medical conditions.

Press  for help with:

- Locating a gas station with an attendant to pump gas.
- Finding a hotel, restaurant, etc., that meets accessibility needs.
- Providing directions to the closest hospital or pharmacy in urgent situations.

TTY Users

OnStar has the ability to communicate to the deaf, hard-of-hearing, or speech-impaired customers while in the vehicle. The available dealer-installed TTY system can provide in-vehicle access to all of the OnStar services, except Virtual Advisor and OnStar Turn-by-Turn Navigation.

OnStar.com (U.S.) or OnStar.ca (Canada)

The website provides access to account information, allows management of the OnStar subscription, and viewing of videos of each service. Get subscription plan pricing and sign up for OnStar Vehicle Diagnostics. Click on the “My Account” tab on the home page. The website navigation and services provided may vary by country.

OnStar Personal Identification Number (PIN)

A PIN is needed to access some of the OnStar services, like Remote Door Unlock and Stolen Vehicle Assistance. You will be prompted to change the PIN the first time when speaking with an Advisor. To change the OnStar PIN, call OnStar and provide the Advisor with the current number.

Warranty

OnStar equipment may be warranted as part of the New Vehicle Limited Warranty. The manufacturer of the vehicle furnishes detailed warranty information.

Languages

The vehicle can be programmed to respond in multiple languages.

Press  and ask an Advisor. Advisors are available in English, Spanish and French. Available languages may vary by country.

Potential Issues

OnStar cannot perform Remote Door Unlock or Stolen Vehicle Assistance after the vehicle has been off continuously for five days. After five days, OnStar can contact Roadside Assistance and a locksmith to help gain access to the vehicle.

Global Positioning System (GPS)

- Obstruction of the GPS can occur in a large city with tall buildings; in parking garages; around airports; in tunnels, underpasses, or parking garages; or in an area with very dense trees. If GPS signals are not available, the OnStar system should still operate to call OnStar. However, OnStar could have difficulty identifying the exact location.

- In emergency situations, OnStar can use the last stored GPS location to send to emergency responders.
- A temporary loss of GPS can cause loss of the ability to send a Turn-by-Turn Navigation route. The Advisor may give a verbal route or may ask for a call back after the vehicle is driven into an open area.

Cellular and GPS Antennas

Avoid placing items over or near the antenna to prevent blocking cellular and GPS signal reception. Cellular reception is required for OnStar to send remote signals to the vehicle.

Unable to Connect to OnStar Message

If there is limited cellular coverage or the cellular network has reached maximum capacity, this message may come on. Press  to try the call again or try again after driving a few miles into another cellular area.

Vehicle and Power Issues

OnStar services require a vehicle electrical system, wireless service, and GPS satellite technologies to be available and operating for features to function properly. These systems may not operate if the battery is discharged or disconnected.

Add-on Electrical Equipment

The OnStar system is integrated into the electrical architecture of the vehicle. Do not add any electrical equipment. See *Add-On Electrical Equipment on page 9-59*. Added electrical equipment may interfere with the operation of the OnStar system and cause it to not operate.

Privacy

The complete OnStar Privacy Statement may be found at www.onstar.com (U.S.), or www.onstar.ca (Canada). Privacy-sensitive users of wireless communications are cautioned that the privacy of any information sent via wireless cellular communications

cannot be assured. Third parties may unlawfully intercept or access transmissions and private communications without consent.

OnStar - libcurl and unzip acknowledgments

Certain OnStar components include libcurl and unzip software. Below are the notices and licenses associated with this software:

libcurl:

COPYRIGHT AND PERMISSION NOTICE

Copyright (c) 1996 - 2010, Daniel Stenberg, <daniel@haxx.se>.

All rights reserved.

Permission to use, copy, modify, and distribute this software for any purpose with or without fee is hereby granted, provided that the above copyright notice and this permission notice appear in all copies.

THE SOFTWARE IS PROVIDED "AS IS," WITHOUT WARRANTY OF ANY KIND, EXPRESS OR IMPLIED, INCLUDING BUT NOT LIMITED TO THE WARRANTIES OF MERCHANTABILITY, FITNESS FOR A PARTICULAR PURPOSE AND NONINFRINGEMENT OF THIRD PARTY RIGHTS. IN NO EVENT SHALL THE AUTHORS OR COPYRIGHT HOLDERS BE LIABLE FOR ANY CLAIM, DAMAGES OR OTHER LIABILITY, WHETHER IN AN ACTION OF CONTRACT, TORT OR OTHERWISE, ARISING FROM, OUT OF OR IN CONNECTION WITH THE SOFTWARE OR THE USE OR OTHER DEALINGS IN THE SOFTWARE.

Except as contained in this notice, the name of a copyright holder shall not be used in advertising or otherwise to promote the sale, use or other dealings in this Software without prior written authorization of the copyright holder.

unzip:

This is version 2005-Feb-10 of the Info-ZIP copyright and license. The definitive version of this document should be available at <ftp://ftp.info-zip.org/pub/infozip/license.html> indefinitely.

Copyright (c) 1990-2005 Info-ZIP. All rights reserved.

For the purposes of this copyright and license, "Info-ZIP" is defined as the following set of individuals:

Mark Adler, John Bush, Karl Davis, Harald Denker, Jean-Michel Dubois, Jean-loup Gailly, Hunter Goatley, Ed Gordon, Ian Gorman, Chris Herborth, Dirk Haase, Greg Hartwig, Robert Heath, Jonathan Hudson, Paul Kienitz, David Kirschbaum, Johnny Lee, Onno van der Linden, Igor Mandrichenko, Steve P. Miller, Sergio Monesi, Keith Owens, George Petrov, Greg Roelofs,

Kai Uwe Rommel, Steve Salisbury, Dave Smith, Steven M. Schweda, Christian Spieler, Cosmin Truta, Antoine Verheijen, Paul von Behren, Rich Wales, Mike White

This software is provided "as is," without warranty of any kind, express or implied. In no event shall Info-ZIP or its contributors be held liable for any direct, indirect, incidental, special or consequential damages arising out of the use of or inability to use this software.

Permission is granted to anyone to use this software for any purpose, including commercial applications, and to alter it and redistribute it freely, subject to the following restrictions:

1. Redistributions of source code must retain the above copyright notice, definition, disclaimer, and this list of conditions.

2. Redistributions in binary form (compiled executables) must reproduce the above copyright notice, definition, disclaimer, and this list of conditions in documentation and/or other materials provided with the distribution. The sole exception to this condition is redistribution of a standard UnZipSFX binary (including SFXWiz) as part of a self-extracting archive; that is permitted without inclusion of this license, as long as the normal SFX banner has not been removed from the binary or disabled.
3. Altered versions—including, but not limited to, ports to new operating systems, existing ports with new graphical interfaces, and dynamic, shared, or static library versions—must be plainly marked as such and must not be misrepresented as being the original source.

Such altered versions also must not be misrepresented as being Info-ZIP releases—including, but not limited to, labeling of the altered versions with the names “Info-ZIP” (or any variation thereof, including, but not limited to, different capitalizations), “Pocket UnZip,” “WiZ” or “MacZip” without the explicit permission of Info-ZIP.

Such altered versions are further prohibited from misrepresentative use of the Zip-Bugs or Info-ZIP e-mail addresses or of the Info-ZIP URL(s).

4. Info-ZIP retains the right to use the names “Info-ZIP,” “Zip,” “UnZip,” “UnZipSFX,” “WiZ,” “Pocket UnZip,” “Pocket Zip,” and “MacZip” for its own source and binary releases.

A

Accessories and
Modifications 10-3

Accessory Power 9-22

Adaptive Forward
Lighting (AFL) 6-4

Add-On Electrical
Equipment 9-59

Additional Information
OnStar® 14-5

Adjustments
Lumbar, Front Seats 3-5
Thigh Support 3-6

Air Cleaner/Filter, Engine 10-15

Air Filter, Passenger
Compartment 8-6

Air Vents 8-6

Airbag System
Check 3-32
How Does an Airbag
Restrain? 3-24
Passenger Sensing
System 3-26
What Makes an Airbag
Inflate? 3-24

Airbag System (cont'd)
What Will You See after an
Airbag Inflates? 3-25
When Should an Airbag
Inflate? 3-23
Where Are the Airbags? 3-22

Airbags
Adding Equipment to the
Vehicle 3-31
Passenger Status Indicator 5-18
Readiness Light 5-17
Servicing Airbag-Equipped
Vehicles 3-31
System Check 3-20

Alarm
Vehicle Security 2-23

Alert
Side Blind Zone (SBZA) 9-44

All-Wheel Drive 10-30, 9-33

AM-FM Radio 7-8

Antenna
Multi-band 7-15

Antilock Brake
System (ABS) 9-33
Warning Light 5-23

Appearance Care
Exterior 10-112
Interior 10-116

Audio Players 7-16
CD 7-16
CD/DVD 7-19
MP3 7-23

Audio System
Backglass Antenna 7-15
Hard Drive Device (HDD) 7-27
Radio Reception 7-14
Theft-Deterrent Feature 7-3

Automatic
Door Locks 2-16
Headlamp System 6-3
Transmission 9-26
Transmission Fluid 10-14

Automatic Transmission
Manual Mode 9-28
Shift Lock Control
Function Check 10-31

Auxiliary
Devices 7-33

B

Battery	10-29
Exterior Lighting Battery Saver	6-9
Jump Starting	10-105
Load Management	6-8
Power Protection	6-8
Voltage and Charging Messages	5-32
Blade Replacement, Wiper ...	10-32
Bluetooth	
Overview	7-35
Boost Gauge	5-14
Brake	
System Warning Light	5-22
Brakes	10-27
Antilock	9-33
Assist	9-37
Fluid	10-28
Parking	9-34, 9-35
System Messages	5-33
Braking	9-3
Break-In, New Vehicle	9-15

Bulb Replacement	10-37
Fog Lamps	10-35, 6-5
Halogen Bulbs	10-35
Headlamp Aiming	10-34
Headlamps	10-35
High Intensity Discharge (HID) Lighting	10-35
License Plate Lamps	10-36
Buying New Tires	10-79

C

Calibration	5-7
California	
Fuel Requirements	9-50
Perchlorate Materials Requirements	10-3
Warning	10-3
Camera	
Rear Vision (RVC)	9-46
Canadian Vehicle Owners	iii
Capacities and Specifications	12-2

Carbon Monoxide	
Engine Exhaust	9-25
Liftgate	2-19
Trunk	2-17
Winter Driving	9-8
Cargo	
Cover	4-2
Management System	4-3
Cargo Net	4-4
Cautions, Danger, and Warnings	iv
CD Player	7-16
CD/DVD Player	7-19
Center Console Storage	4-2
Central Door Unlock System ...	2-15
Chains, Tire	10-84
Charging System Light	5-18
Check	
Engine Light	5-19
Ignition	
Transmission Lock	10-32

Child Restraints
 Infants and Young
 Children 3-35
 Lower Anchors and
 Tethers for Children 3-41
 Older Children 3-33
 Securing 3-47, 3-49
 Systems 3-38
 Circuit Breakers 10-38
 Cleaning
 Exterior Care 10-112
 Interior Care 10-116
 Climate Control Systems
 Dual Automatic 8-1
 Clock 5-9
 Cluster, Instrument 5-11
 Clutch, Hydraulic 10-15
 Collision Damage Repair 13-9
 Compact Spare Tire 10-104
 Compartments
 Storage 4-1
 Compass 5-7
 Messages 5-34
 Competitive Driving Mode 9-39
 Compressor Kit, Tire
 Sealant 10-86

Connections
 OnStar® 14-3
 Control
 Traction and Electronic
 Stability 9-38
 Control of a Vehicle 9-3
 Convenience Net 4-6
 Convex Mirrors 2-26
 Coolant
 Engine 10-19
 Engine Temperature
 Gauge 5-16
 Engine Temperature
 Warning Light 5-24
 Cooling System 10-18
 Engine Messages 5-35
 Courtesy Transportation
 Program 13-8
 Cover
 Cargo 4-2
 Engine 10-9
 Cruise Control 9-41
 Light 5-27
 Messages 5-34
 Cupholders 4-2

Customer Assistance 13-4
 Offices 13-3
 Text Telephone (TTY)
 Users 13-4
 Customer Information
 Service Publications
 Ordering Information 13-11
 Customer Satisfaction
 Procedure 13-1

D

Damage Repair, Collision 13-9
 Danger, Warnings, and
 Cautions iv
 Data Recorders, Event 13-14
 Daytime Running
 Lamps (DRL) 6-2
 Defensive Driving 9-3
 Delayed Locking 2-15
 Devices
 Auxiliary 7-33
 Diagnostics
 OnStar® 14-5
 Distracted Driving 9-2

Door
 Ajar Messages 5-34
 Central Door Unlocking
 System 2-15
 Delayed Locking 2-15
 Locks 2-13
 Power Locks 2-15
Drive Belt Routing, Engine 12-4
Drive Systems
 All-Wheel Drive 10-30, 9-33
Driver Information
 Center (DIC) 5-27
Driving
 Characteristics and
 Towing Tips 9-53
 Competitive 9-39
 Defensive 9-3
 Drunk 9-3
 For Better Fuel Economy 1-23
 Highway Hypnosis 9-7
 Hill and Mountain Roads 9-8
 If the Vehicle is Stuck 9-10
 Loss of Control 9-5
 Off-Road Recovery 9-5

Driving (cont'd)
 Vehicle Load Limits 9-11
 Wet Roads 9-6
 Winter 9-8
Dual Automatic Climate
 Control System 8-1
DVD/CD Player 7-19

E

Easy Entry Seat 3-3
Electrical Equipment,
 Add-On 9-59
Electrical System
 Engine
 Compartment
 Fuse Block 10-38, 10-42,
 10-46, 10-49
 Fuses and Circuit
 Breakers 10-38
 Overload 10-37
 Rear
 Compartment
 Fuse Block 10-53, 10-55,
 10-57, 10-59
Emergency
 OnStar® 14-2

Engine
 Air Cleaner/Filter 10-15
 Check and Service Engine
 Soon Light 5-19
 Compartment Overview 10-6
 Coolant 10-19
 Coolant Heater 9-22
 Coolant Temperature
 Gauge 5-16
 Coolant Temperature
 Warning Light 5-24
 Cooling System 10-18
 Cooling System Messages 5-35
 Cover 10-9
 Drive Belt Routing 12-4
 Exhaust 9-25
 Oil Life System 10-13
 Oil Messages 5-36
 Oil Pressure Gauge 5-15
 Overheated Protection
 Operating Mode 10-25
 Overheating 10-24
 Power Messages 5-36
 Pressure Light 5-25

Engine (cont'd)
 Running While Parked 9-26
 Speed Limiter 5-14
 Starting 1-4, 9-20
 Entry Lighting 6-7
 Equipment, Towing 9-58
 Event Data Recorders 13-14
 Exit Lighting 6-7
 Extender, Safety Belt 3-19
 Exterior Lamp Controls 6-1
 Exterior Lamps Off Reminder ... 6-2
 Exterior Lighting Battery
 Saver 6-9

F

Features
 Memory 1-9
 Filter,
 Engine Air Cleaner 10-15
 Flash-to-Pass 6-2
 Flashers, Hazard Warning 6-4
 Flat Tire 10-85
 Changing 10-96
 Floor Mats 10-119

Fluid
 Automatic Transmission 10-14
 Brakes 10-28
 Power Steering 10-25
 Washer 10-26
 Fog Lamps
 Bulb
 Replacement 10-35, 6-5
 Folding Mirrors 2-27
 Front Fog Lamp
 Light 5-26
 Front Seats
 Adjustment 3-3
 Heated and Ventilated 3-9
 Fuel 9-49
 Additives 9-50
 Economy Driving 1-23
 Filling a Portable Fuel
 Container 9-52
 Filling the Tank 9-51
 Foreign Countries 9-50
 Gasoline Specifications 9-50
 Gauge 5-13
 Requirements, California 9-50
 System Messages 5-37

Fuses
 Engine
 Compartment
 Fuse Block 10-38, 10-42,
 10-46, 10-49
 Fuses and Circuit
 Breakers 10-38
 Rear
 Compartment
 Fuse Block 10-53, 10-55,
 10-57, 10-59

G

Garage Door Opener 5-54
 Programming 5-54
 Gasoline
 Specifications 9-50
 Gauges
 Boost 5-14
 Engine Coolant
 Temperature 5-16
 Engine Oil Pressure 5-15
 Fuel 5-13
 Odometer 5-13
 Speedometer 5-13

Gauges (cont'd)	
Tachometer	5-13
Trip Odometer	5-13
Warning Lights and Indicators	5-10
General Information	
Service and Maintenance	11-1
Towing	9-53
Vehicle Care	10-3
Glove Box	4-1
GM Mobility Reimbursement Program	13-5

H

Halogen Bulbs	10-35
Hard Drive Device (HDD)	7-27
Hazard Warning Flashers	6-4
Head Restraints	3-2
Active	3-3
Headlamps	
Adaptive Forward Lighting (AFL)	6-4
Aiming	10-34
Automatic	6-3
Bulb Replacement	10-35

Headlamps (cont'd)	
Daytime Running Lamps (DRL)	6-2
Flash-to-Pass	6-2
High Intensity Discharge (HID) Lighting	10-35
High-Beam On Light	5-26
High/Low Beam Changer	6-2
Lamps On Reminder	5-26
Washer	5-7
Heated Steering Wheel	5-4
Heated and Ventilated Front Seats	3-9
Heated Mirrors	2-27
Heater	
Engine Coolant	9-22
High-Beam On Light	5-26
High-Speed Operation	10-71
Highway Hypnosis	9-7
Hill and Mountain Roads	9-8
Hood	10-5
Horn	5-4
How to Wear Safety Belts Properly	3-13
Hydraulic Clutch	10-15

I

Ignition Positions	9-15, 9-17
Ignition Transmission Lock Check	10-32
Immobilizer	2-24
Infants and Young Children, Restraints	3-35
Infotainment	7-1
Instrument Cluster	5-11
Instrument Panel Storage Area	4-1
Introduction	iii

J

Jump Starting	10-105
---------------------	--------

K

Key and Lock Messages	5-37
Keyless Entry Remote (RKE) System ...	2-4, 2-9
Keys	2-2

- L**
- Labeling, Tire Sidewall 10-64
 - Lamps
 - Daytime Running (DRL) 6-2
 - Exterior Controls 6-1
 - Exterior Lamps Off
 - Reminder 6-2
 - Exterior Lighting Battery
 - Saver 6-9
 - License Plate 10-36
 - Malfunction Indicator 5-19
 - Messages 5-39
 - On Reminder 5-26
 - Reading 6-6
 - Lap-Shoulder Belt 3-14
 - LATCH System
 - Replacing Parts after a
 - Crash 3-47
 - LATCH, Lower Anchors and
 - Tethers for Children 3-41
 - LED Lighting 10-35
 - Liftgate
 - Carbon Monoxide 2-19
- Lighting
 - Adaptive Forward 6-4
 - Entry 6-7
 - Exit 6-7
 - Illumination Control 6-6
 - LED 10-35
 - Parade Dimming 6-7
 - Lights
 - Airbag Readiness 5-17
 - Antilock Brake System
 - (ABS) Warning 5-23
 - Brake System Warning 5-22
 - Charging System 5-18
 - Cruise Control 5-27
 - Engine Coolant
 - Temperature Warning 5-24
 - Engine Oil Pressure 5-25
 - Flash-to-Pass 6-2
 - Front Fog Lamp 5-26
 - High-Beam On 5-26
 - High/Low Beam Changer 6-2
 - Safety Belt Reminders 5-16
 - Security 5-26
 - StabiliTrak® OFF 5-23
 - Lights (cont'd)
 - Tire Pressure 5-25
 - Traction Control System
 - (TCS)/StabiliTrak® 5-24
 - Up-Shift 5-23
 - Limited-Slip Rear Axle 9-40
 - Locks
 - Automatic Door 2-16
 - Central Door Unlocking
 - System 2-15
 - Delayed Locking 2-15
 - Door 2-13
 - Lockout Protection 2-16
 - Power Door 2-15
 - Safety 2-16
 - Loss of Control 9-5
 - Low-Profile Tires 10-63
 - Lower Anchors and Tethers
 - for Children (LATCH
 - System) 3-41
 - Lumbar Adjustment 3-5
 - Front Seats 3-5

M

Magnetic Ride Control	9-40
Maintenance	
Records	11-17
Maintenance Schedule	
Recommended Fluids	
and Lubricants	11-13
Malfunction Indicator Lamp	5-19
Manual Mode	9-28
Manual Transmission	9-31
Fluid	10-14
Memory Features	1-9
Memory Seats	3-7
Messages	
Airbag System	5-43
Battery Voltage and	
Charging	5-32
Brake System	5-33
Compass	5-34
Door Ajar	5-34
Engine Cooling System	5-35
Engine Oil	5-36
Engine Power	5-36

Messages (cont'd)

Fuel System	5-37
Key and Lock	5-37
Lamp	5-39
Object Detection System	5-40
Ride Control System	5-41
Security	5-43
Service Vehicle	5-44
Tire	5-44
Transmission	5-45
Vehicle	5-31
Vehicle Speed	5-46
Washer Fluid	5-46
Mirrors	
Automatic Dimming	
Rearview	2-27
Convex	2-26
Folding	2-27
Heated	2-27
Power	2-27
Monitor System, Tire	
Pressure	10-72
MP3	7-23
Multi-band Antenna	7-15

N

Navigation	
OnStar®	14-2
Vehicle Data Recording	
and Privacy	13-15
Net	
Cargo	4-4
Net, Convenience	4-6
New Vehicle Break-In	9-15

O

Object Detection System	
Messages	5-40
Odometer	5-13
Trip	5-13
Off-Road	
Recovery	9-5
Oil	
Engine	10-10
Engine Oil Life System	10-13
Engine Oil Pressure	
Gauge	5-15
Messages	5-36
Pressure Light	5-25

Older Children, Restraints 3-33
 Online Owner Center 13-4
 OnStar®
 System, In Brief 1-23
 OnStar® Additional
 Information 14-5
 OnStar® Connections 14-3
 OnStar® Diagnostics 14-5
 OnStar® Emergency 14-2
 OnStar® Navigation 14-2
 OnStar® Overview 14-1
 OnStar® Security 14-2
 Operation, Infotainment
 System 7-3
 Ordering
 Service Publications 13-11
 Outlets
 Power 5-9
 Overheated Engine
 Protection
 Operating Mode 10-25
 Overheating, Engine 10-24

P

Parade Dimming 6-7
 Park
 Shifting Into 9-23
 Shifting Out of 9-24
 Parking 9-25
 Brake 9-34, 9-35
 Brake and P (Park)
 Mechanism Check 10-32
 Over Things That Burn 9-25
 Parking Assist
 Ultrasonic 9-43
 Passenger Airbag Status
 Indicator 5-18
 Passenger Compartment Air
 Filter 8-6
 Passenger Sensing System ... 3-26
 Perchlorate Materials
 Requirements, California 10-3
 Personalization
 Vehicle 5-46

Phone
 Bluetooth 7-35
 Power
 Door Locks 2-15
 Mirrors 2-27
 Outlets 5-9
 Protection, Battery 6-8
 Retained Accessory (RAP) ... 9-22
 Seat Adjustment 3-4
 Steering Fluid 10-25
 Windows 2-28
 Pregnancy, Using Safety
 Belts 3-18
 Privacy
 Radio Frequency
 Identification (RFID) 13-15
 Program
 Courtesy Transportation 13-8
 Proposition 65 Warning,
 California 10-3

R

Radio Frequency	
Identification (RFID)	13-15
Statement	13-15
Radios	
AM-FM Radio	7-8
CD/DVD Player	7-19
Reception	7-14
Satellite	7-10
Reading Lamps	6-6
Rear Axle	
Limited-Slip	9-40
Rear Seats	3-11
Rear Vision Camera (RVC)	9-46
Rear Window Washer/Wiper	5-6
Rearview Mirrors	
Automatic Dimming	2-27
Reclining Seatbacks	3-6
Recommended Fluids and	
Lubricants	11-13
Records	
Maintenance	11-17
Recreational Vehicle	
Towing	10-109
Reimbursement Program,	
GM Mobility	13-5

Remote Keyless Entry	
(RKE) System	2-4, 2-9
Remote Vehicle Start	2-11
Replacement Bulbs	10-37
Replacement Parts	
Airbags	3-32
Maintenance	11-15
Replacing Airbag System	3-32
Replacing LATCH System	
Parts after a Crash	3-47
Replacing Safety Belt	
System Parts after a Crash ...	3-19
Reporting Safety Defects	
Canadian Government	13-13
General Motors	13-13
U.S. Government	13-12
Restraints	
Where to Put	3-39
Retained Accessory	
Power (RAP)	9-22
Ride Control Systems	
Limited Slip Rear Axle	9-40
Magnetic	9-40
Messages	5-41
Roads	
Driving, Wet	9-6

Roadside Service	13-5
Roof	
Sunroof	2-30
Roof Rack System	4-6
Rotation, Tires	10-76
Routing, Engine Drive Belt	12-4
Running the Vehicle While	
Parked	9-26

S

Safety Belts	3-12
Care	3-19
Extender	3-19
How to Wear Safety Belts	
Properly	3-13
Lap-Shoulder Belt	3-14
Reminders	5-16
Replacing after a Crash	3-19
Use During Pregnancy	3-18
Safety Defects Reporting	
Canadian Government	13-13
General Motors	13-13
U.S. Government	13-12
Safety Locks	2-16
Safety System Check	3-19
Satellite Radio	7-10

Scheduling Appointments	13-7	Service (cont'd)		StabiliTrak	
Sealant Kit, Tire	10-86	Maintenance, General		OFF Light	5-23
Seats		Information	11-1	Start Vehicle, Remote	2-11
Adjustment, Front	3-3	Parts Identification Label	12-1	Starter Switch Check	10-31
Easy Entry Seat	3-3	Publications Ordering		Starting the Engine	1-4, 9-20
Head Restraints	3-2	Information	13-11	Steering	9-4
Heated and Ventilated Front	3-9	Scheduling Appointments	13-7	Fluid, Power	10-25
Lumbar Adjustment, Front	3-5	Vehicle Messages	5-44	Heated Wheel	5-4
Memory	3-7	Servicing the Airbag	3-31	Wheel Adjustment	5-2
Power Adjustment, Front	3-4	Shift Lock Control Function		Wheel Controls	5-3
Rear	3-11	Check, Automatic		Storage Areas	
Reclining Seatbacks	3-6	Transmission	10-31	Cargo Cover	4-2
Securing Child		Shifting		Cargo Management System	4-3
Restraints	3-47, 3-49	Into Park	9-23	Center Console	4-2
Security		Out of Park	9-24	Convenience Net	4-6
Light	5-26	Side Blind Zone		Glove Box	4-1
Messages	5-43	Alert (SBZA)	9-44	Instrument Panel	4-1
OnStar®	14-2	Signals, Turn and		Roof Rack System	4-6
Vehicle	2-23	Lane-Change	6-5	Storage Compartments	4-1
Vehicle Alarm	2-23	Spare Tire		Storing the Tire	
Service		Compact	10-104	Sealant and	
Accessories and		Specifications and		Compressor Kit	10-94–10-96
Modifications	10-3	Capacities	12-2	Stuck Vehicle	9-10
Doing Your Own Work	10-4	Speed Limiter, Engine	5-14	Sun Visors	2-30
Engine Soon Light	5-19	Speedometer	5-13	Sunroof	2-30
Maintenance Records	11-17			Symbols	iv

System
 Infotainment 7-1
 Roof Rack 4-6

T

Tachometer 5-13
Text Telephone (TTY) Users ... 13-4
Theft-Deterrent
 Systems 2-24, 2-25
 Immobilizer 2-24
Thigh Support Adjustment 3-6
Time 5-9
Tires
 Buying New Tires 10-79
 Chains 10-84
 Changing 10-96
 Compact Spare 10-104
 Designations 10-66
 Different Size 10-81
 If a Tire Goes Flat 10-85
 Inflation Monitor System ... 10-73
 Inspection 10-76
 Low Profile 10-63
 Messages 5-44
 Pressure 10-71
 Pressure Light 5-25

Tires (cont'd)
 Pressure Monitor System ... 10-72
 Rotation 10-76
 Sealant and
 Compressor Kit 10-86
 Sealant and
 Compressor
 Kit, Storing 10-94–10-96
 Sidewall Labeling 10-64
 Terminology and
 Definitions 10-67
 Uniform Tire Quality
 Grading 10-82
 Wheel Alignment and Tire
 Balance 10-83
 Wheel Replacement 10-83
 When It Is Time for New
 Tires 10-78
 Winter 10-63
Towing
 Driving Characteristics 9-53
 Equipment 9-58
 General Information 9-53
 Recreational Vehicle 10-109

Towing (cont'd)
 Trailer 9-56
 Vehicle 10-109
Track Events and
 Competitive Driving 9-6
Traction
 Control System (TCS)/
 StabiliTrak[®] Light 5-24
 Limited-Slip Rear Axle 9-40
Traction Control/Electronic
 Stability Control 9-38
Trailer
 Towing 9-56
Transmission
 Automatic 9-26
 Fluid, Automatic 10-14
 Fluid, Manual 10-14
 Messages 5-45
Transportation Program,
 Courtesy 13-8
Trip Odometer 5-13
Trunk 2-17
Turn and Lane-Change
 Signals 6-5

U

Ultrasonic Parking Assist 9-43
 Uniform Tire Quality
 Grading 10-82
 Universal Remote System 5-54
 Operation 5-57
 Programming 5-54
 Up-Shift Light 5-23
 Using This Manual iv

V

Vehicle
 Alarm System 2-23
 Canadian Owners iii
 Control 9-3
 Identification
 Number (VIN) 12-1
 Load Limits 9-11
 Messages 5-31
 Personalization 5-46
 Remote Start 2-11
 Security 2-23
 Speed Messages 5-46
 Towing 10-109

Vehicle Care
 Storing the Tire
 Sealant and
 Compressor
 Kit 10-94–10-96
 Tire Pressure 10-70
 Ventilation, Air 8-6
 Visors 2-30

W

Warning
 Brake System Light 5-22
 Warning Lights, Gauges,
 and Indicators 5-10
 Warnings iv
 Cautions and Danger iv
 Hazard Flashers 6-4
 Washer Fluid 10-26
 Messages 5-46
 Washer, Headlamps 5-7
 Wheels
 Alignment and Tire
 Balance 10-83
 Different Size 10-81
 Replacement 10-83

When It Is Time for New
 Tires 10-78
 Where to Put the Restraint 3-39
 Windows 2-28
 Power 2-28
 Windshield
 Wiper/Washer 5-4
 Winter
 Driving 9-8
 Winter Tires 10-63
 Wiper Blade Replacement 10-32
 Wipers
 Rear Washer 5-6

