

JSLM

Synthesized Telemetry Module

Preliminary



Part Number: 001-2100-101
Revision 000
September 2005

Copyright 2005 Dataradio COR Ltd.

About Dataradio

Dataradio is the leading designer and manufacturer of trusted wireless products and systems for critical infrastructure applications. Our products have been found at the heart of mobile and SCADA data networks around the world for over 20 years. Dataradio products include mobile data products and systems, telemetry devices, integrated wireless modems for fixed point-to-point and point to multi-point applications and OEM solutions. Our product line is one of the broadest and most trusted in the industry.

Product Warranty

The manufacturer's warranty statement for this product is available in our manuals or by contacting Dataradio COR Ltd. 299 Johnson Avenue, Suite 110, Waseca, MN 56093-0833. Phone (507) 833-8819.

www.dataradio.com

Dataradio provides product brochures, case studies software downloads and product information on our website.

Every effort is taken to provide accurate, timely product information in this installation manual. Product updates may result in differences between the information provided herein and the product shipped. The information in this document is subject to change without notice.

DATARADIO[®]

Dataradio is a registered trademark of Dataradio, Inc.

TABLE OF CONTENTS

1 GENERAL INFORMATION

1.1	SCOPE OF MANUAL	1-1
1.2	EQUIPMENT DESCRIPTION	1-1
	GENERAL	1-1
	JSLM ² RADIO/LOADER	1-1
1.3	MODULE IDENTIFICATION	1-1
1.4	PART NUMBER BREAKDOWN	1-2
1.5	ACCESSORIES	1-2
1.6	TECHNICAL SUPPORT	1-3
1.7	PRODUCT WARRANTY	1-3
1.8	REPLACEMENT PARTS	1-3
1.9	FACTORY REPAIR	1-3
	GENERAL JSLM ² INFORMATION (SPECIFICATIONS)	1-4

2 INSTALLATION

2.1	PRE-INSTALLATION CHECKS	2-1
2.2	INTERFACING WITH THE JSLM ²	2-1
	PROGRAMMING AND POWER CABLE	2-1
	ANTENNA AND VSWR	2-1
	CONNECTOR J204 USER INTERFACE	2-1
	GENERAL PINOUT DESCRIPTION	2-2

3 PROGRAMMING

3.1	INTRODUCTION	3-1
	GENERAL	3-1
3.2	JSLM ² FIELD PROGRAMMING SOFTWARE	3-1
	INTRODUCTION	3-1
	RADIO PARAMETERS	3-2
	SETTINGS TAB	3-2
	RADIO TAB	3-4
	FREQUENCIES TAB	3-6
	VERSION REQUEST	3-7
	READ/WRITE PROGRAMMABLE SETTINGS	3-7
	PORT SETTINGS	3-8
	PORT STATISTICS	3-10
	USER TEST	3-11
	ASCII/HEX TERMINAL	3-13
3.3	JSLM ² FIELD PROGRAMMING SOFTWARE HELP FILES	3-13

4 ALIGNMENT AND TROUBLESHOOTING

4.1	GENERAL	4-1
	PERIODIC CHECKS	4-1
	SERVICING	4-1
4.2	PERFORMANCE CHECKS	4-1
	CHANNEL FREQUENCY	4-1

TABLE OF CONTENTS

RF OUTPUT POWER	4-1
TRANSMIT DEVIATION	4-2
TRANSMIT DEVIATION LIMITING	4-2
RECEIVE AUX OUT AND AUDIO OUT LEVELS	4-2
4.3 TROUBLESHOOTING	4-2

APPENDIX A

TECHNICAL SUPPORT APPLICATION NOTE	A-1/3
RF EXPOSURE COMPLIANCE - VHF JSLM² TELEMETRY MODULE	A-4
RF EXPOSURE COMPLIANCE - UHF JSLM² TELEMETRY MODULE	A-5
PRODUCT WARRANTY	A-6

LIST OF FIGURES

MODULE IDENTIFICATION	1-1
1-1 JSLM ² TELEMETRY MODULE	1-2
1-2 VHF TYPICAL OUTPUT POWER VS. SUPPLY VOLTAGE	1-6
1-3 UHF TYPICAL OUTPUT POWER VS. SUPPLY VOLTAGE	1-7
2-1 JSLM ² MODULE	2-1
2-2 JSLM ² ACCESSORY INTERCONNECT POWER CABLE	2-3
3-1 JSLM ² FIELD PROGRAMMING SOFTWARE SETUP	3-1
3-2 JSLM ² FIELD PROGRAMMING SOFTWARE START-UP SCREEN	3-2
3-3 SETUP JSLM ² PARAMETERS - SETTINGS TAB	3-3
3-4 SETUP RADIO PARAMETERS SCREEN	3-5
3-5 SETUP FREQUENCIES SCREEN	3-6
3-6 JSLM ² VERSION REQUEST	3-7
3-7 SERIAL PC PORT SETTINGS SCREENS	3-8
3-8 SERIAL PC PORT STATISTICS SCREEN	3-10
3-9 JSLM ² USER TEST SCREEN	3-11
3-10 ASCII TERMINAL SCREEN	3-13
4-1 JSLM ² RF BOARD ADJUSTMENT POINTS	4-4
4-2 JSLM ² LOADER ADJUSTMENT POINTS	4-4

LIST OF TABLES

1-1 ACCESSORIES	1-2
1-2 VHF RSSI VOLTAGES VS RF INPUT LEVEL @ J204, PIN 11	1-5
1-2 UHF RSSI VOLTAGES VS RF INPUT LEVEL @ J204, PIN 11	1-5
2-1 CHANNEL SELECT	2-2
3-1 LED FUNCTIONS	3-4
3-2 COMMUNICATION MODES	3-9

Revision History

Revision 000
Manual release

SECTION 1

GENERAL INFORMATION

1.1 SCOPE OF MANUAL

This installation manual contains operating instructions for the Dataradio JSLM² Synthesized Telemetry module. This document is intended for system designers, system consultants and JSLM² end-users.

1.2 EQUIPMENT DESCRIPTION

1.2.1 GENERAL

The Dataradio JSLM² module (transmitter and receiver) operates in the VHF or UHF frequency range. The transmitter power output is electrically programmable from 0.10 to 5.00 Watts. Operation is simplex or half duplex. The JSLM² module has a frequency stability of ± 1.5 PPM. The module may be used for voice and/or low speed data communications with an external modem.

1.2.2 JSLM² RADIO/LOADER

The JSLM² includes the 8-channel Loader Board which performs synthesizer loading. The Loader Board has circuitry which provides transmit/receive audio conditioning and gating, carrier detect, and RSSI buffering. The gating circuits allow the user to select audio response type: flat, pre-emphasis or de-emphasis. The receiver audio outputs and transmitter audio inputs are electronically programmable.

This board is programmed using a personal computer with a Windows® 95 or newer operating system and the JSLM² Field Programming Software. Programming information is stored by an EEPROM on the RF Board.

1.3 MODULE IDENTIFICATION

The module identification number is a random, unique serial number (SN) printed on the shipping box and the model label on the side of the module.

DATARADIO
JSLM²
Model: 242-2140-XXX
FCC ID: NP4-2422140510
Canada: 773B-2140510

SN XXXX
Made in USA

DATARADIO
JSLM²
Model: 242-2110-XXX
FCC ID: NP4-2422110610
Canada: 773B-2110610

SN XXXX
Made in USA

1.4 PART NUMBER BREAKDOWN

The following is a breakdown of the part number used to identify this module:

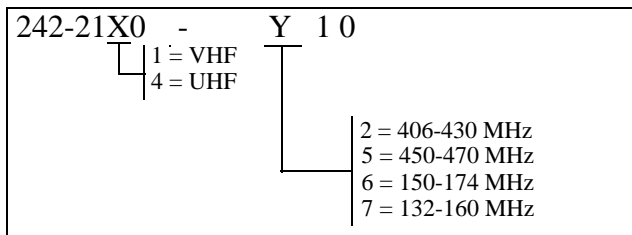

1.5 ACCESSORIES

Accessories available for the JSLM² module are listed in Table 1-1.

Table 1-1 ACCESSORIES

Accessory	Part No.
JSLM ² Programming Kit	250-2100-001
External 1200 Baud Modem*	250-3282-002
JSLM ² Interconnect Power Cable	023-3414-003
JSLM ² to 3282 Interconnect Cable	697-3282-012

*See Appendix A for the Technical Support Application note to interface the JSLM² with the external 1200 Baud Modem.



Figure 1-1 JSLM² Telemetry Module

1.6 TECHNICAL SUPPORT

The Technical Service Department of Dataradio provides customer assistance on technical problems and serves as an interface with factory repair facilities. They can be reached by mail, phone, and E-mail at:

Dataradio COR Ltd. Technical Service Department
299 Johnson Avenue, Suite 110
Waseca, MN 56093-0833

Technical Service hours are: Monday to Friday 7:30 AM to 4:30 PM, Central Time

Phone: 800-992-7774 or 507-833-8819

Fax: 507-833-6758

E-mail address: support@dataradio.com

1.7 PRODUCT WARRANTY

The warranty statement for the JSLM² is available in the Appendix area of this manual.

1.8 REPLACEMENT PARTS

This product is not field serviceable, except by the replacement of complete units. Specialized equipment and training is required to repair logic boards and radio modules.

1.9 FACTORY REPAIR

Dataradio products are designed for long life and failure-free operation. If a problem arises, factory service is available. Contact the Technical Service Department before returning equipment. A service representative may suggest a solution eliminating the need to return equipment.

A Return Material Authorization (RMA) is required when returning equipment to Dataradio for repair. Contact the Technical Service Department at 800-992-7774, extension 6707 to request an RMA number. Be prepared to give the equipment model and serial number, your account number (if known), and billing and shipping addresses. Information regarding equipment return is also available on our website at www.dataradio.com

Include the RMA number, a complete description of the problem, and the name and phone number of a contact person with the returned units. This information is important. The technician may have questions that need to be answered to identify the problem and repair the equipment. The RMA number helps locate your equipment in the repair lab if there is a need to contact Dataradio concerning the equipment. Units sent in for repair will be returned to the customer re-tuned to the current Dataradio Test and Tune Procedure and will conform to all specifications noted in this section

Customers are responsible for shipping charges (to Dataradio) for returned units in warranty. Units in warranty are repaired free of charge unless there is evidence of abuse or damage beyond the terms of the warranty. Dataradio covers return shipping costs for equipment repaired while under warranty.

Units out of warranty are subject to repair service charges. Customers are responsible for shipping charges (to and from Dataradio) on units out of warranty. Return shipping instructions are the responsibility of the customer.

GENERAL SPECIFICATIONS

These specifications are subject to change without notice.

GENERAL JSLM² INFORMATION

Frequency Range	137-162 MHz, 150-174 MHz, 450-470 MHz, 406-430 MHz
Frequency Control	Synthesized
Operating Voltage	6-15 VDC
Channel Spacing	12.5 kHz
Mode of Operation	Simplex or Half Duplex
RF Input/Output	BNC Jack
Power and Data Interface	DA-15 (15 pin D)
Receive Current Drain	≤100 mA (w/o Field Programming Software Cable)
Transmit Current Drain	1200 mA max @ 7.2 VDC, ≤2000 mA max @ 12.5 VDC
Operating Temperature	-30° to +60° C (-22° to +140° F)
Maximum Dimensions	1.0" (H)x2.5"(W) x 3.7"(L)[2.54cm (H) x 6.35 cm (W) x 9.40 cm (L)]
Weight	8 oz.
Regulatory	FCC, Industry Canada

JSLM² RECEIVER

Bandwidth	UHF: 16 MHz (-210) 20 MHz (-510) VHF: 24 MHz (610), 25 MHz (710)
Frequency Stability	±1.5 PPM
Sensitivity -12 dB SINAD	<-116 dBm
RF Input Impedance	50 ohms
Selectivity	60 dB (12.5 kHz)
Spurious and Image Rejection	70 dB
Intermodulation	70 dB
FM Hum and Noise	40 dB (12.5 kHz)
Conducted Spurious	≤-57 dBm

RECEIVE CARRIER DETECT

Attack Time	<3ms to 50% rated audio out with a -80 dBm RF input from audio squelch
Cold Start	≤40 ms from power on cold start to carrier detect with a -80 dBm RF input

RECEIVE AUDIO RESPONSE referenced to 1 kHz tone

Auxiliary Out w/o de-emphasis	+1/-3 dB from 300 Hz to 2.5 kHz
Auxiliary Out with de-emphasis	+1/-3 dB with 6 dB de-emphasis
Audio Out	+1/-3 dB with 6 dB de-emphasis

RECEIVE AUDIO OUTPUT LEVEL @ 1 kHz tone 60% rated deviation (factory set levels)

Auxiliary Out w/o de-emphasis	212 mVrms ±18 mV, 0.60 Vp-p ± 0.05 Vp-p, into 600 ohm, AC Coupled
Auxiliary Out with de-emphasis	160 mVrms ±18 mV, 0.45 Vp-p ± 0.05 Vp-p, into 600 ohm, AC Coupled
Audio Out	212 mVrms ±18 mV, 0.60 Vp-p ± 0.05 Vp-p, into 2k ohm, AC Coupled

RECEIVE AUDIO OUTPUT MIN./MAX. ADJUSTMENT RANGE 1 kHz tone 60% rated deviation

Auxiliary Out w/o de-emphasis	50-400 mVrms into 600 ohm load
Auxiliary Out with de-emphasis	50-300 mVrms into 600 ohm load
Audio Out	50-212 mVrms into 2k ohm load

RECEIVE AUDIO DISTORTION

Auxiliary Out	<3%(Psophometrically weighted)
Audio Out	<3%(Psophometrically weighted)

JSLM² TRANSMITTER

Bandwidth	UHF: 16 MHz (-210) 20 MHz (-510) VHF: 24 MHz (610), 25 MHz (710)
Frequency Stability	±1.5 PPM
TCXO Coupling	DC
RF Power Output	Programmable 0.10 to 2.00 @ 7.2 Vdc Programmable 0.50 to 5.00 Watts @ 12.5 Vdc

Output Power vs Supply Voltage	See Figures 1-2, 1-3
RF Output Impedance	50 ohms
Modulation Distortion	< 3% (Psophometrically weighted)
Spurious and Harmonic FM	≤-20 dBm
FM Hum and Noise	-40 dB, -35 dB (242-2110-710)
TRANSMIT AUDIO RESPONSE	referenced to 1 kHz tone:
Auxiliary In w/o pre-emphasis	+1/-3 dB from 300 Hz to 2.5 kHz
Auxiliary In with pre-emphasis	+1/-3 dB with 6 dB pre-emphasis
Audio In	+1/-3 dB with 6 dB pre-emphasis
MODULATION CAPABILITY @ 1 kHz tone: (Factory Set)	
Auxiliary In w/o pre-emphasis	40 mVrms ± 20% for 60% of rated deviation
Auxiliary In with pre-emphasis	200 mVrms ± 20% for 60% of rated deviation
Audio In	30 mVrms ± 20% for 60% of rated deviation
TRANSMIT AUDIO DISTORTION	
Auxiliary In	<3% (Psophometrically weighted)
Audio In	<3% (Psophometrically weighted)
TRANSMIT ATTACK TIME	<15 ms from PTT to 100% rated power out
MODULATION CAPABILITY MIN/MAX ADJUSTMENT	
Auxiliary In w/o pre-emphasis	10-80 mVrms (electronically programmable)
Auxiliary In with pre-emphasis	50-300 mVrms
Audio In	No adjustment available

Measurements per TIA/EIA 603 or Dataradio COR Ltd. Specification 003-0000-000.

Table 1-2 VHF JSLM² RSSI Voltages vs RF Input Level @ J204, Pin 11

RF Input Level dBm	RSSI Typical Voltage 610 & 710	RSSI Low Voltage 610 & 710	RSSI High Voltage 610 & 710
-120	0.69	0.40	0.98
-110	0.85	0.50	1.19
-100	1.02	0.66	1.38
-90	1.21	0.79	1.63
-80	1.38	0.99	1.77
-70	1.56	1.13	1.99
-60	1.75	1.32	2.18
-50	1.95	1.47	2.42

Table 1-3 UHF JSLM² RSSI Voltages vs RF Input Level @ J204, Pin 11

RF Input Level dBm	RSSI Typical Voltage 210 & 510	RSSI Low Voltage 210 & 510	RSSI High Voltage 210 & 510
-120	0.85	0.42	1.28
-110	1.00	0.45	1.55
-100	1.19	0.57	1.81
-90	1.38	0.86	1.90
-80	1.55	0.95	2.15
-70	1.73	1.16	2.31
-60	1.93	1.25	2.60
-50	2.09	1.79	2.40

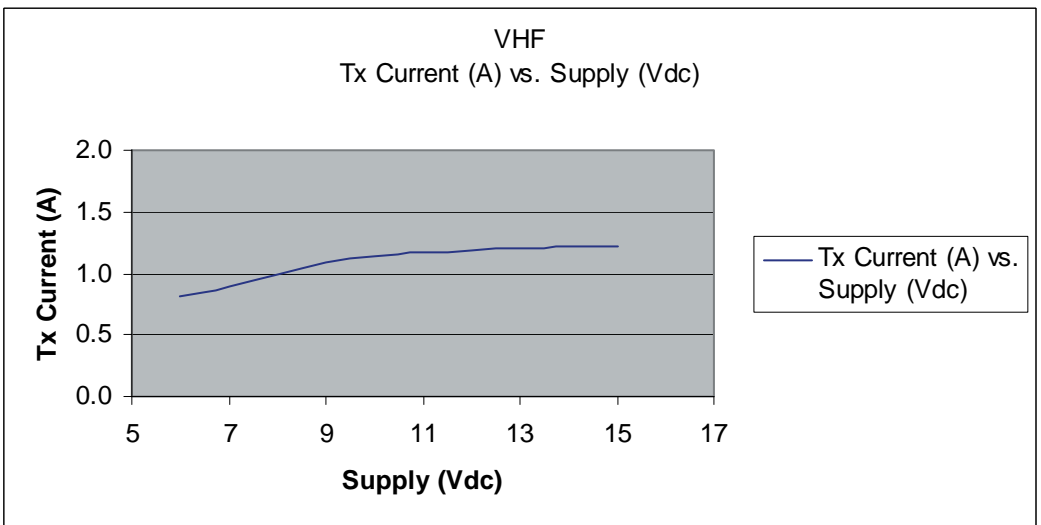
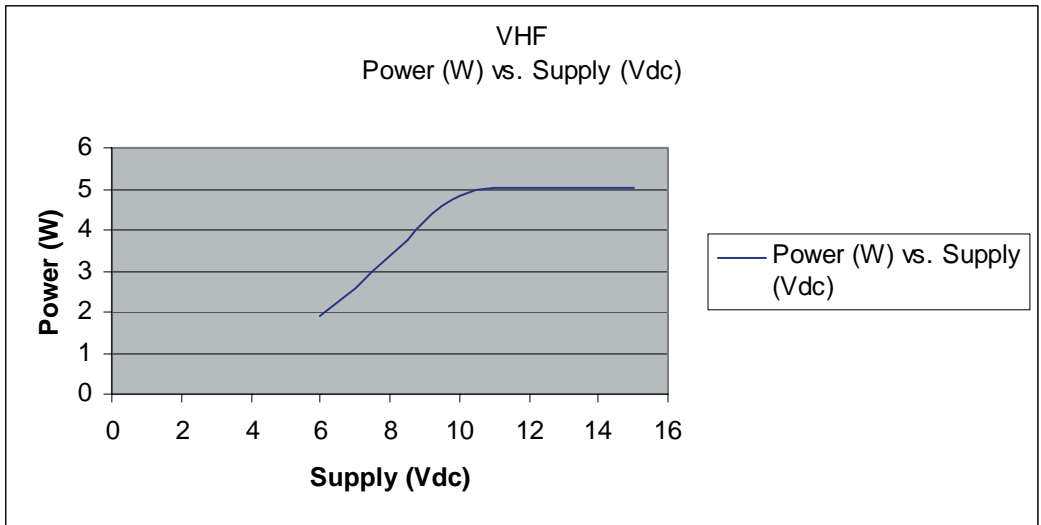

Figure 1-2 VHF Typical Output Power vs Supply Voltage

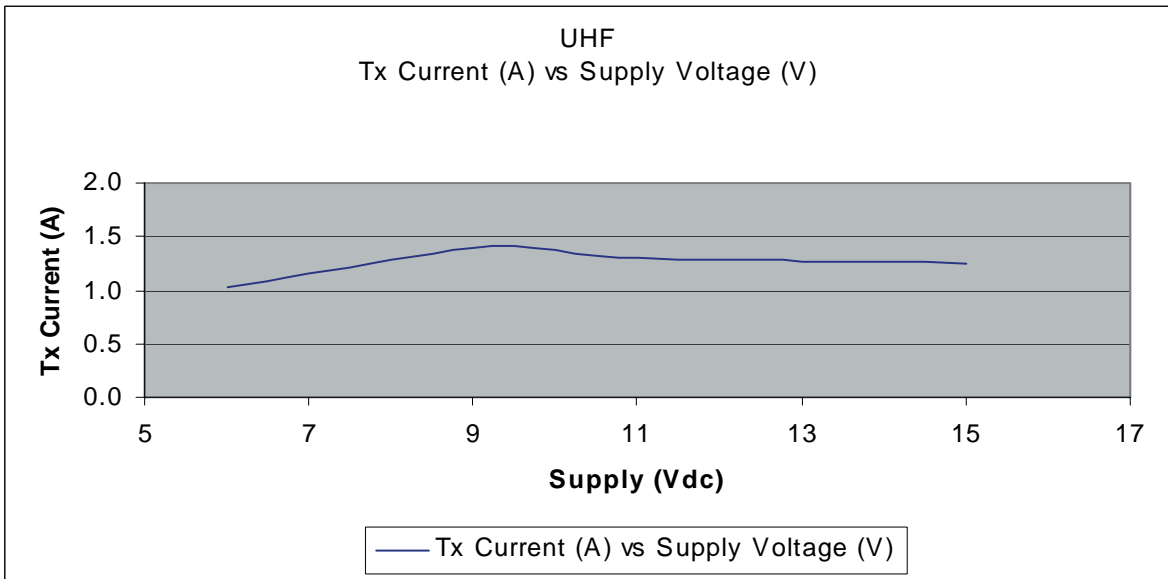
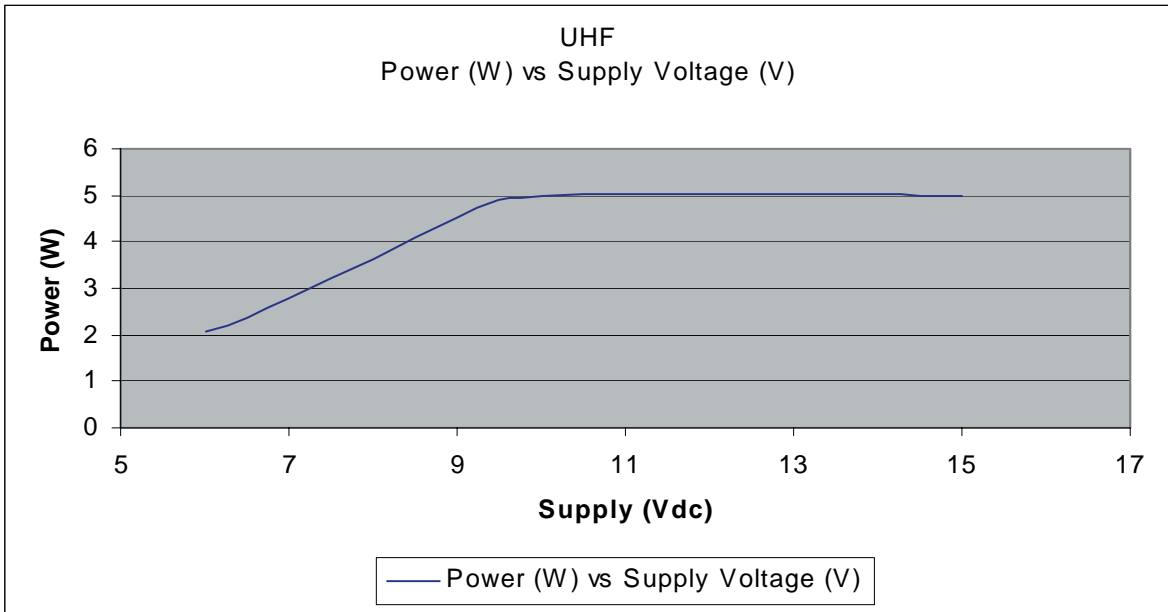

Figure 1-3 UHF Typical Output Power vs Supply Voltage

SECTION 2

INSTALLATION

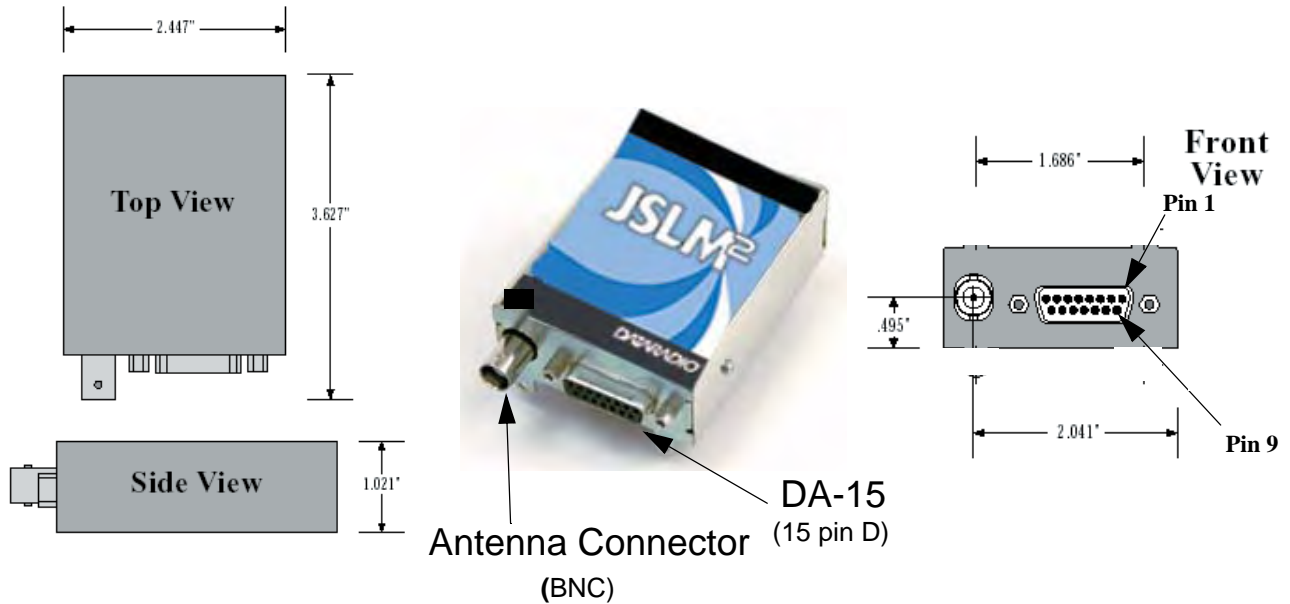

Figure 2-1 JSLM² Module

2.1 PRE-INSTALLATION CHECKS

Unpack the JSLM² Module. Inspect the unit to ensure the Module was not damaged during shipment. Save the packing material and documentation.

2.2 INTERFACING WITH THE JSLM²

2.2.1 PROGRAMMING AND POWER CABLE

Programming and pre-installation checks may be performed with the Programming Cable supplied in the JSLM² Field Programming Kit (Part Number 250-2100-001). For final installation, a Dataradio JSLM² Accessory / Interconnect Power Cable is available (see Figure 2-2). See Appendix A for the Technical Support Application note to interface the JSLM² with the external 1200 Baud Modem.

2.2.2 ANTENNA AND VSWR

A VSWR measurement of the antenna system should be made before the module is put into service. An accurate VSWR meter or directional wattmeter appropriate for the frequency of operation should be used. A VSWR of less than 2:1 is recommended. If the VSWR reading is high, check cables and connectors. Verify the antenna is properly installed and is specified to operate on your frequency.

2.2.3 CONNECTOR J204 USER INTERFACE

Connector J204 (DA-15) provides the interface with the JSLM² module. This is a 15-pin, female connector. See Appendix A for the Technical Support Application note to interface the JSLM² with the external 1200 Baud Modem.

2.2.4 GENERAL PINOUT DESCRIPTION

Table 2-1 Channel Select Table

CH	CSO_N	CS1_N	CS2_N
1	0	0	0
2	1	0	0
3	0	1	0
4	1	1	0
5	0	0	1
6	1	0	1
7	0	1	1
8	1	1	1

CSO_N.... CS2_N internally pulled up to 5 VDC, ground pin for logic low.

PIN 1: Channel Select 0 (CSO_N) Switch 0

PIN 2: Channel Select 1 (CS1_N) Switch 1

PIN 3: Channel Select 2 (CS2_N) Switch 2

PIN 4: TX Microphone Input (MIC_IN) 30 mVrms nominal for 60% rated deviation.

PIN 5: Connected internally to Pin 1

PIN 6: Raw Battery Supply (7.2 or 12.5 VDC nominal) Power supply 6-15 VDC, 3 Amps maximum.

PIN 7: TX Auxiliary Input (AUX_IN) Audio input for the transmitter.
 Without pre-emphasis: 40 mVrms nominal for 60% rated deviation.
 With pre-emphasis: 200 mVrms nominal for 60% rated deviation.

PIN 8: RX Auxiliary Output (AUX_OUT): Audio from the receiver.
 Without pre-emphasis: 212 Vrms \pm 18 mV
 With pre-emphasis: 160 mVrms \pm 18 mV
 Into a 600 ohm load

PIN 9: Program I/O From Computer (PGM_IN_OUT) (TTL) The Interface cable (see Table 1-1) converts RS-232 to TTL logic for JSLM² programming information.

PIN 10: Ready to Send (RS) (TTL) Radio is locked on frequency and transmitter is ready to accept audio input, set with software active high or low.

PIN 11: _Squelch_Disable/RSSI Out

User programmable to:

Squelch Disable - When the Squelch Disable box is unchecked, the receive audio is squelched. Grounding Pin 11 will un-squelch the receive audio
RSSI Analog Out - RSSI DC output voltage level

PIN 12: RX Audio Out (AUDIO_OUT) Audio Output 212 mVrms \pm 18 mV into a 2000 ohm load.

PIN 13: Carrier Detect (DCD) Carrier Detect (TTL). Indicates receiver is locked on channel and receiving a signal. Can be active high or low, set with software.

PIN 14: Push To Talk (PTT_RTS)(TTL) Keys the transmitter. Can be active high or low, set with software. Internal 10k ohm pullup.

Pin 15: Ground

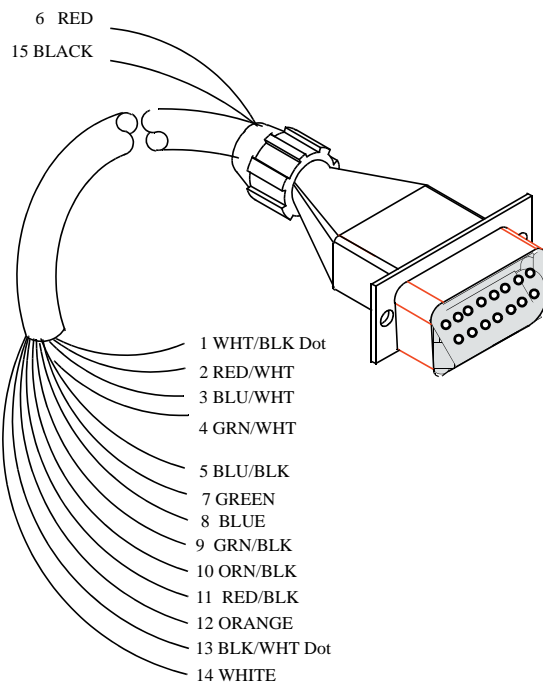

Figure 2-2 JSLM² Accessory Interconnect Power Cable

SECTION 3

PROGRAMMING

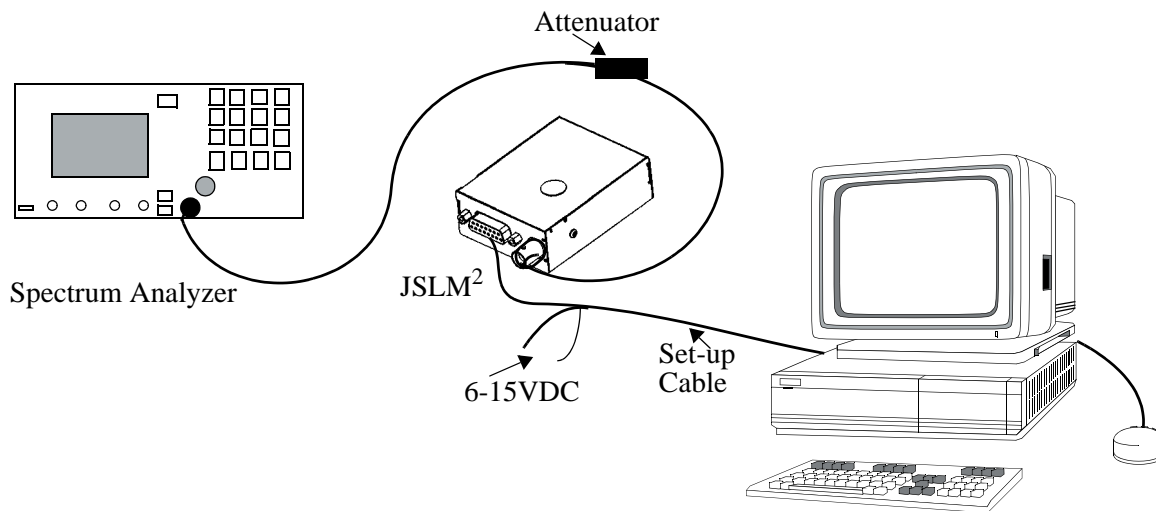

Figure 3-1 JSLM² Field Programming Software Setup

3.1 INTRODUCTION

3.1.1 GENERAL

Section 3 describes the use of the Field Programming Software used to configure and test the JSLM² transceiver. Mechanical adjustments for frequency, deviation and audio levels are described in Section 4 (Alignment and Troubleshooting). This information is designed for use by installation personnel. Radio adjustments described in this section should be done by technicians familiar with radio shop procedures.

3.2 JSLM² FIELD PROGRAMMING SOFTWARE

3.2.1 INTRODUCTION

The JSLM² Programmer is the Field Programming Software for tuning and programming the Dataradio JSLM² series data transceiver (see Figure 3-2). The Field Programming Software helps the user:

- Edit and program the programmable settings for the JSLM² transceiver
- Change the transmit and receive frequencies
- Monitor diagnostic data from the JSLM²

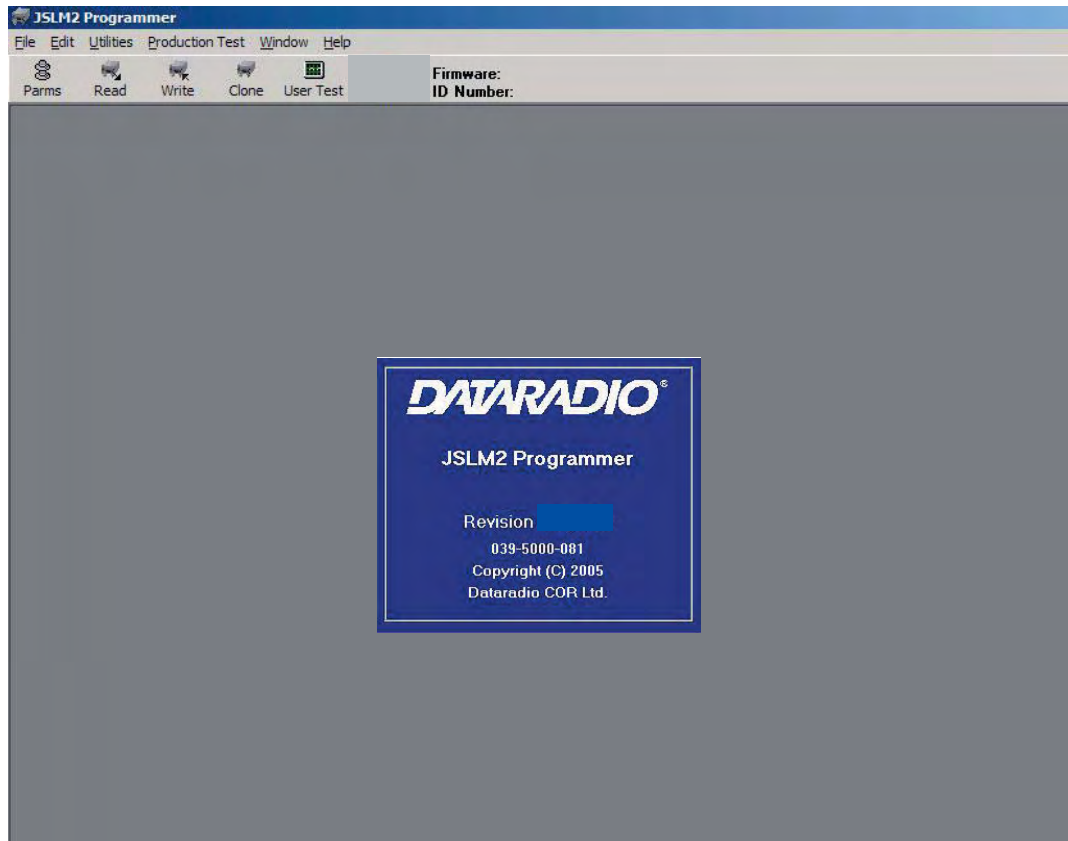

Figure 3-2 JSLM² Field Programming Software Start-up Screen

3.2.2 RADIO PARAMETERS

The Setup JSLM² Parameters screen allows the user to view and edit the JSLM's programmable parameters (see Figure 3-3). The programmable parameters can be stored in a data file with the .DAT file extension by selecting "Save Data File" from the file menu. These programmable parameters are used by the Read/Write Parameters screen for programming into nonvolatile memory of the JSLM².

3.2.2.1 SETTINGS TAB

The Settings tab allows the user to program various JSLM² operating parameters (see Figure 3-3).

ID Number

The ID Number is customer programmable from 0 to 4294967295.

NOTE: This ID is not the same as the printed serial number. Use the printed serial number to identify the unit's warranty status.

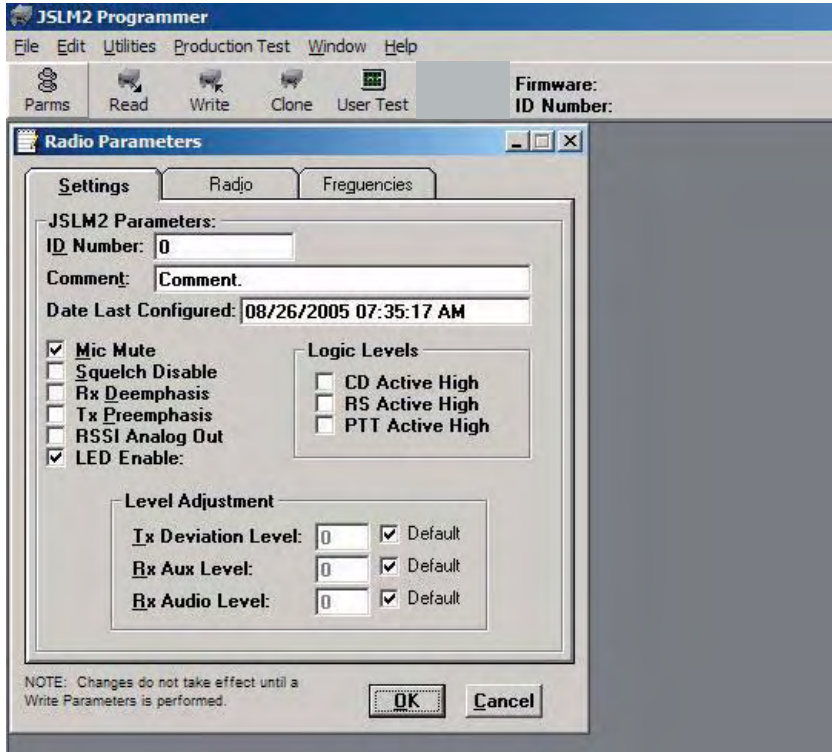

Figure 3-3 Setup JSLM² Parameters - Settings Tab

Comment

The Comment field can be used as a notepad (customer name, location, technical information...) for text up to 40 characters in length (including spaces).

Date Last Configured

Date Last Configured shows the date the JSLM² was last programmed. The date is taken from the operating system. No entry is allowed in this field.

Mic Mute

Mic Mute allows the user to enable or disable the microphone audio input. The default for MIC input is enabled (box checked) to prevent stray noise pickup.

MIC Input (J204, Pin 4) is passed through a separate audio path that has 300-3000 Hz filtering and a 6 dB per octave pre-emphasis response before the limiter.

Squelch Disable

Squelch Disable allows the user to squelch audio outputs. The default for Squelch Disable is box checked (enabled) - the audio outputs are always un-squelched. When disabled (box un-checked), the audio outputs are squelched and un-squelch on Carrier Detect.

Rx De-emphasis

Since data equipment normally requires a flat audio response, the default value for Rx De-emphasis is disabled (unchecked). With Rx De-emphasis disabled, the JSLM² provides a 300 - 2500 Hz +1/-3 dB flat audio response. When the Rx De-emphasis is enabled (checked), data output is passed through a 300 Hz - 3000 Hz filter and a 6 dB per octave de-emphasis response.

Tx Pre-Emphasis

Since data equipment normally requires a flat audio response, the default value for Tx Pre-emphasis is disabled (unchecked). With Tx Pre-Emphasis disabled, the JSLM² provides a 300 - 2500 Hz +1/-3 dB flat audio response before the limiter. When Tx Pre-Emphasis is enabled (box checked), the JSLM² provides 300-3000 Hz filtering and a 6 dB per octave pre-emphasis response before the limiter.

RSSI Analog Out

The default value for the RSSI Analog Out is disabled (unchecked) which provides Squelch Disable (from J204, Pin 11). When the RSSI Analog Out is enabled (checked), J204 - Pin 11 is switched from Squelch Disable to a Receive Signal Strength Indicator (RSSI) DC voltage.

LED Enable

The default value for LED Enable is enabled (box checked). If unchecked, the LEDs are disabled.

Table 3-1 LED Functions

Color	Indicates
Continuous Green	Unit has DC power
Continuous Red	Unit is transmitting
Continuous Amber	Unit has Receive Carrier Detect
Flashing Green	Unit DC power exceeds 15 Vdc
Flashing Red	Unit internal temperature exceeded 85 degrees C
Flashing Amber	Unit VCO/synthesizer is unlocked

Logic Levels

Logic Levels allows the user to select the polarity of some pins on the data interface connector. The Carrier Detect (CD), Ready to Send (RS) and Push to Talk (PTT) polarity is programmable as Active High or Active Low.

Level Adjustment

Level Adjustment allows the user to program the Transmit Deviation Input, Rx Aux Out and Rx Audio Out levels.

3.2.2.2 RADIO TAB

The Radio tab allows user programming of radio operating parameters.

Radio Parameters

Radio

The Radio drop-down box shows the type JSLM² (UHF or VHF). The Radio type is uploaded from the JSLM² or from an opened file. No entry is allowed in this field.

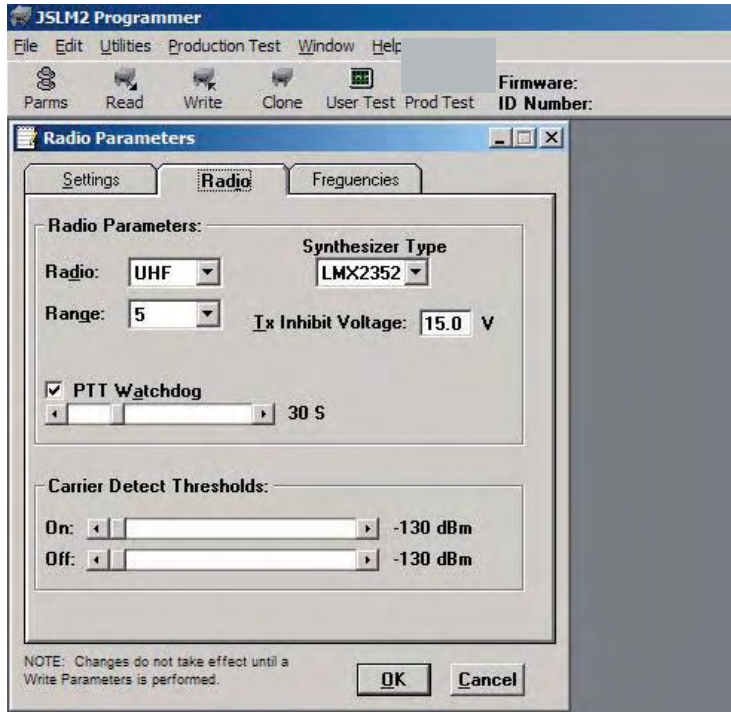

Figure 3-4 Setup Radio Parameters Screen

Range

The Range drop down box shows the frequency range of the JSLM². The frequency range is uploaded from the JSLM² or from an opened file. No entry is allowed in this field.

Synthesizer Type

Shows the synthesizer type for the JSLM². No entry is allowed in this field.

Tx Inhibit Voltage

Tx Inhibit Voltage shows the maximum voltage level for transmitter key up. No entry is allowed in this field.

PTT Watchdog

The default for PTT Watchdog is enabled (box checked). PTT Watchdog range is 1 - 120 seconds selectable by moving slider bar. When disabled (unchecked), the transmitter can transmit up to 5 minutes before a firmware shutdown is invoked.

Carrier Detect On Threshold

Carrier Detect On Threshold indicates the RSSI level for a received carrier. The Carrier Detect On Threshold value should be greater than (a less negative number) the Carrier Detect Off Threshold value.

Carrier Detect Off Threshold

Carrier Detect Off Threshold indicates the RSSI level for a lost carrier. The Carrier Detect Off Threshold value should be less than (a larger negative number) the Carrier Detect On Threshold value.

3.2.2.3 FREQUENCIES TAB

The Frequencies tab is used for user programming of the eight frequency pairs.

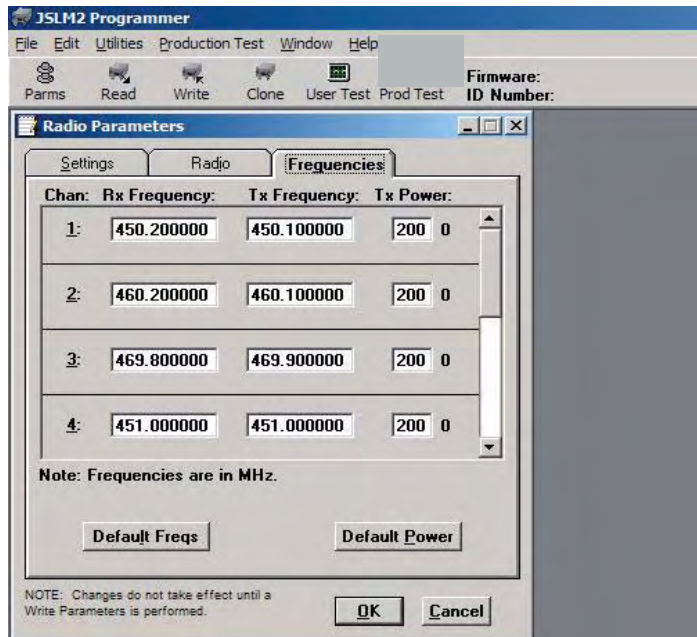

Figure 3-5 Setup Frequencies Screen

Chan

Chan displays the frequency channel pair.

Rx Frequency

Rx Frequency displays the receive frequency for the channel pair (in MHz).

Tx Frequency

Tx Frequency displays the transmit frequency for the channel pair (in MHz).

Tx Power

Tx Power allows the user to vary the power output setting of the transmitter.

Default Freqs

The Default Freqs button returns the Rx and Tx frequencies to default values. The default frequencies are based on radio type and range.

Default Power

The Default Power button allows the user to return the Tx Power to factory power output settings.

3.2.3 VERSION REQUEST



Figure 3-6 JSLM² Version Request

Version Request displays JSLM² hardware and firmware version information.

3.2.4 READ/WRITE PROGRAMMABLE SETTINGS

Read Programmable Settings

Read Programmable Settings reads and displays the programmable settings currently programmed in the EEPROM of the JSLM².

Write Programmable Settings

Write Programmable Settings writes the currently loaded settings to the EEPROM of the JSLM².

Clone Programmable Settings

Clone Programmable Settings clones (writes) the currently loaded programmable settings (except ID Number and Comment) to the EEPROM of the JSLM². Clone Programmable Settings is used to program a Data File (.DAT) to multiple JSLM²s.



Figure 3-7 Serial PC Port Settings Screens

3.2.5 PORT SETTINGS

Port Settings are used to configure the user PC's serial COM ports (Primary and Secondary). Port Settings can be used to test data links using the ASCII and HEX terminals (available in the Utilities menu). The JSLM² Field Programming Software will override these settings when using any other screen to communicate with the JSLM². NOTE: A modem is required to transmit serial data using this program. The JSLM² is an analog signal device.

COM Port

The COM Port field allows the user to select the COM port number (1-4) for the Primary and Secondary COM port.

Baud Rate

The Baud Rate field allows the user to select the communication speed for the Primary and Secondary COM ports.

Data Bits

The Data Bits field allows the user to select the number of Data Bits (4 - 8) to transmit or receive over the Primary and Secondary COM ports.

Parity

The Parity field permits the user to select Parity Bits (None/Odd/Even) to transmit or receive for the Primary and Secondary COM ports.

Stop Bits

The Stop Bits field permits the user to select the number of Stop Bits (1 or 2) to transmit or receive for the Primary and Secondary COM Ports.

DTR Enable

The DTR field allows the user to select whether the DTR (Data Terminal Ready) line of the RS-232 port is asserted when the port is open for the Primary and Secondary COM ports.

Mode

Mode allows the user to select the communications mode for the Primary and Secondary COM ports. See Table 3-2 for available modes.

Table 3-2 Communications Modes

Mode	Description
Sync/Esc with No HS	Send data using the Sync/Esc byte-stuffing protocol with no handshaking
Buffered with No HS	Send buffered data without handshaking
Sync/Esc with RTS/CTS HS	Send data using the Sync/Esc byte-stuffing protocol with RTS/CTS hardware handshaking
Buffered with RTS/CTS HS	Send buffered data with RTS/CTS hardware handshaking
Sync/Esc with Flow Control HS	Send data using the Sync/Esc byte-stuffing protocol with flow control handshaking
Buffered with Flow Control HS	Send buffered data with flow control hardware handshaking

Sync/Esc Framing

A typical Sync/Esc frame resembles the following character stream:

SYNC	ML	Data0	---	DataN	Chksum
8 bits	8 bits	8 bits	---	8 bits	8 bits

with the following definitions made:

Sync (8 bits) - marks the start of a frame when not preceded by an ESC character. When using a Sync/Esc (Framing) Mode, the Field Programming Software will stuff this character automatically.

ML (8 bits) - the length of the frame. ML is the number of characters left to be received including the checksum but excluding any ESC characters added as part of the protocol. When using a Sync/Esc (Framing) Mode, the Field Programming Software will stuff this character automatically based on the number of Data Characters.

Data 0 - N(8 bits each) - frame information

Chksum (8 bits) - the 8 bit 2s complement of the sum of the frame less the SYNC character and any additional ESC added characters ignoring the carryout of the high order bits. When using a Sync/Esc (Framing) Mode, the Field Programming Software will stuff this character automatically.

Swap COM Ports

Swap COM Ports allows the user to swap the Primary and Secondary COM ports. For example, if the Primary is COM1 and the Secondary is COM2, the Primary becomes COM2 and the Secondary becomes COM1 after a Swap COM Ports is issued. This utility is useful when more than one JSLM² is connected to a PC since the programming screens all use the Primary COM port. By issuing a Swap COM Ports, the JSLM² connected to the second COM port can be programmed without switching cables.

3.2.6 PORT STATISTICS

The Port Statistics utility shows some of the statistics of the PC's serial COM ports (Primary and Secondary). (A check in the check box indicates an active state). No entry is allowed in these fields.

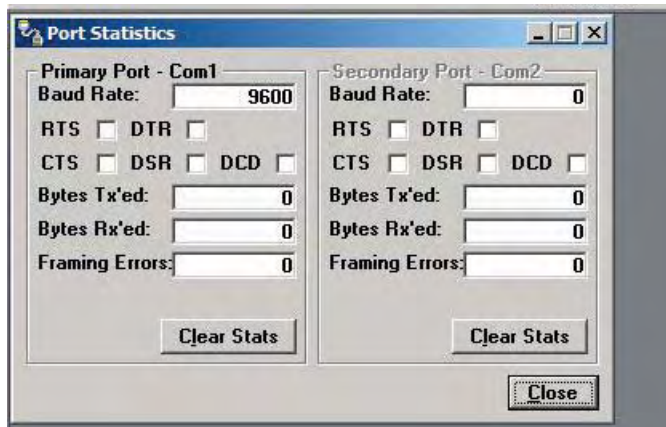

Figure 3-8 Serial PC Port Statistics Screen

Baud Rate

Baud Rate displays the baud rate of the transmitter.

RTS

The RTS field shows the current state of the RTS (request-to-send) line. RTS is an output from the PC.

DTR

The DTR field shows the current state of the DTR (data-terminal-ready) line. DTR is an output from the PC.

CTS

The CTS field shows the current state of the CTS (clear-to-send) line. CTS is an input to the PC.

DSR

The DSR field shows the current state of the DSR (data-set-ready) line. DSR is an input to the PC.

DCD

The DCD field shows the current state of the DCD (data-carrier-detect) line. DCD is an input to the PC.

Bytes Tx'ed

The Bytes Tx'ed field shows the number of bytes (characters) transmitted since the port was last opened.

Bytes Rx'ed

The Bytes Rx'ed field shows the number of bytes (characters) received since the port was last opened.

Framing Errors

The Framing Errors field shows the number of Framing Errors received since the port was last opened.

Dribble Bytes

The Dribble Bytes field shows the number of extra (not expected) bytes (characters) received since the port was last opened.

3.2.7. USER TEST

The User Test Utility allows the user to test the functionality of the JSLM². This utility makes diagnostic information available and gives the user the ability to change channels and transmit or receive a modulated signal.

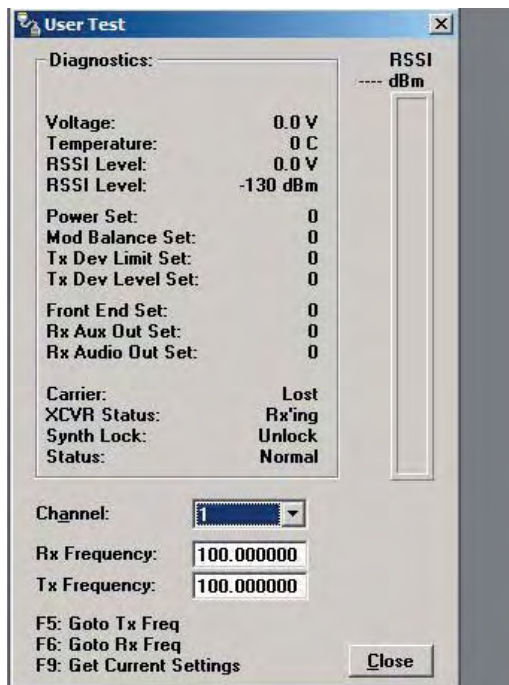

Figure 3-9 JSLM² User Test Screen

Diagnostic parameters include:

Voltage - Supply voltage (in volts)

Temperature - Internal case temperature (in Celsius)

RSSI Level - Received Signal Strength indicator (in volts)

RSSI Level - Received Signal Strength indicator (in dBm)

Power Set: Transmitter power digipot setting

Mod Balance Set: Transmitter modulation balance digipot setting

Tx Dev Limit Set: Transmitter deviation limit digipot setting

Tx Dev Level Set: Transmitter deviation level digipot setting

Front End Set: Displays receive front end digipot setting (VHF module only)

Rx Out Set: Receive auxiliary output digipot setting

Rx Audio Out Set: Receive audio output digipot setting

Carrier: Indicates lost or found Recieve Carrier

XCVR Status - State of transceiver (receiving or transmitting)

Synth Lock - Indicates VCO/Synthesizer “lock” or “unlock”

Status: Indicates Over Voltage, Over Temp or Voltage/Temp (if both conditions exceeded)

RSSI

The RSSI panel shows the current RSSI (received signal strength indicator) level (in dBm) while the local unit is receiving.

Channel

The Channel field allows the user to select one of the 8 programmed channels for the unit’s use.

Rx/Tx Frequency

The Rx and Tx Frequency fields display the current receive and transmit frequencies.

F5

Pressing the F5 key causes the unit to transmit on the programmed transmit frequency.

F6

Pressing the F6 key causes the unit to go to receive on the programmed receive frequency.

F9

Pressing the F9 key causes the programmer to read the current settings from the module.

3.2.8. ASCII / HEX TERMINAL

The Terminal Screens allow the user to select an ASCII or Hexadecimal Terminal Screen for the Primary and Secondary COM ports that were configured in the Port Settings screen. The data is sent according to the port configuration (setup in the Port Settings screen). NOTE: A modem is required to utilize this feature.

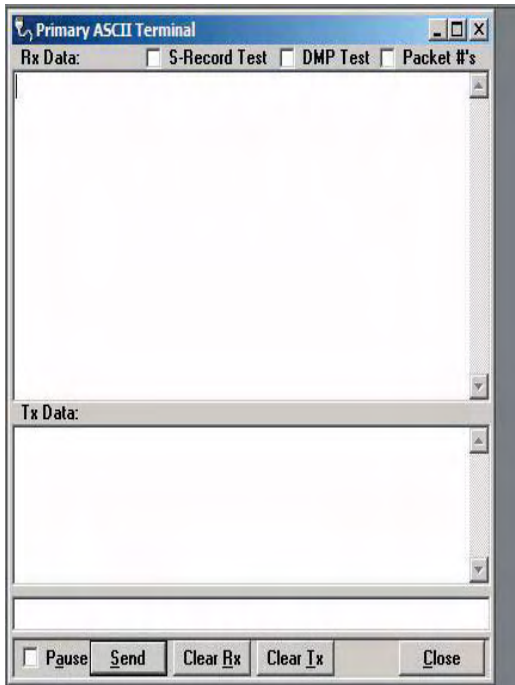

Figure 3-10 ASCII Terminal Screen

ASCII Terminal

Primary - selects an ASCII Terminal screen to send and receive ASCII data on the Primary COM port (setup the Port Settings).

Secondary - selects an ASCII Terminal screen to send and receive ASCII data on the Secondary COM port (setup in Port settings).

Hex Terminal

Primary - selects a Hexadecimal Terminal screen to send and receive Hexadecimal data on the Primary COM port (setup the Port Settings).

Secondary - selects a Hexadecimal Terminal screen to send and receive Hexadecimal data on the Secondary COM port (setup in Port settings).

3.3 JSLM² FIELD PROGRAMMING SOFTWARE HELP FILES

JSLM Field Programming Software's online help files are accessed by the menu bar at the top of the Field Programming Software window.

SECTION 4

ALIGNMENT AND TROUBLESHOOTING

4.1 GENERAL

4.1.1 PERIODIC CHECKS

This module should be put on a regular maintenance schedule and an accurate performance record maintained. Important checks are receiver sensitivity, transmitter frequency, modulation, and power output. It is recommended that module performance be checked annually even though periodic checks are not required by the FCC. Section 4 outlines these tests.

4.1.2 SERVICING

The majority of the components used on the printed circuit boards are surface mount devices. JSLM² module component level field repair is not recommended. Specialized training and equipment are required to service board level components. Equipment should be returned to the factory for repair.

4.2 PERFORMANCE CHECKS

4.2.1 CHANNEL FREQUENCY

The module frequency is controlled by a temperature compensated crystal oscillator (DCXO) which has a frequency stability of ± 1.5 parts per million over a temperature range of -30 to $+60^{\circ}$ C. When transmitting (for example) at 450 MHz, the output frequency should be $450 \text{ MHz} \pm 675 \text{ Hz}$ over temperature. The operating frequency may be adjusted through the case of the JSLM². Connect the User Interface Cable included in the JSLM² Field Programming Kit (part number: 250-2100-001). Connect the antenna port to a frequency counter or other frequency measurement instrument. Locate the Frequency Adjust Access Hole on the bottom side of the Loader Board (see Figure 4-2). Enable the transmitter PTT Line and use a small screwdriver to adjust the DCXO for the desired transmit frequency.

Caution: An RF attenuator may be required depending on the power handling capability of the measuring instrument.

4.2.2 RF OUTPUT POWER

The RF output power may be verified with an accurate power meter connected with a short 50 ohm cable to the Antenna Connector. See Section 1, General Specifications for module specifications. Transmitter alignment is performed in the factory and is not a recommended field adjustment.

4.2.3 TRANSMIT DEVIATION

Transmit deviation is preset at the factory. It is adjustable utilizing the JSLM² Field Programming Software. Select Parameters Settings/Transmit Deviation Level. The value is changed by:

1. Un-check the Default box
2. Highlight the value
3. Change the value
 - a. Increment by 1 using the Arrow Up/Arrow Down keys
 - b. Increment by 10 using the Page Up/Page Down keys

After changing the Transmit Deviation Level, a Write must be performed to the JSLM² transmitter. To return to the factory default level, check the Default box and perform a Write to the JSLM² transmitter.

4.2.4 TRANSMIT DEVIATION LIMITING

Transmit Deviation Limiting is preset at the factory to 2.20 ± 10 kHz and is not field programmable. Deviation Limiting may be checked by injecting a 1000 Hz tone at 1.0 Vrms to the Aux Input or Mic Input.

4.2.5 RECEIVE AUX OUT AND AUDIO OUT LEVELS

Receive Aux Out and Audio Out levels are preset by the factory. Refer to General Information, Section 1, for specifications and levels. These levels are adjustable utilizing the JSLM² Field Programming Software. Select Parameters Settings/Rx Aux Level or Rx Audio Level. Values are changed by:

1. Un-check the Default box
2. Highlight the value
3. Change the value
 - c. Increment by 1 using the Arrow Up/Arrow Down keys
 - d. Increment by 10 using the Page Up/Page Down keys

After changing the Receive Aux Out or Audio Out Level, a Write must be performed to the JSLM² transmitter. To return to the factory default level, check the Default box and perform a Write to the JSLM² transmitter.

4.3 TROUBLESHOOTING

PROBLEM

Radio Inoperative

CHECK

- Verify the DC power source is properly connected.
- Verify DC power source is set at the correct voltage.
- Check the fuse on the Loader Board (see Figure 4-2).

PROBLEM

No/Poor Transmit

CHECK

- Verify power supply voltage.
- Verify power supply voltage can source 2000 mA minimum.
- Verify proper programming including frequency and time-out-timer.
- Check system VSWR, feedline loss, connectors, and antenna.
- Check radio output power with wattmeter.

PROBLEM

No/Poor Receive

CHECK

- Verify Power Supply voltage.
- Verify proper receive frequency programming.
- Check feedline loss, connectors and antenna.
- Apply -100 dBm RF signal at antenna connector and check RSSI indicator in User Test utility.
- Verify that the channel is unoccupied.

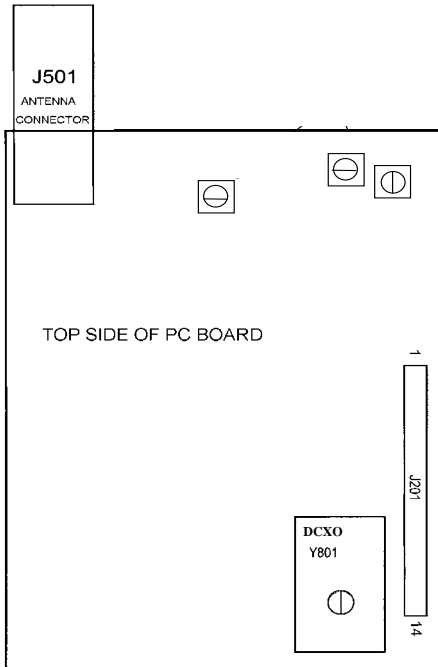

Figure 4-1 JSLM² RF Board Adjustment Points

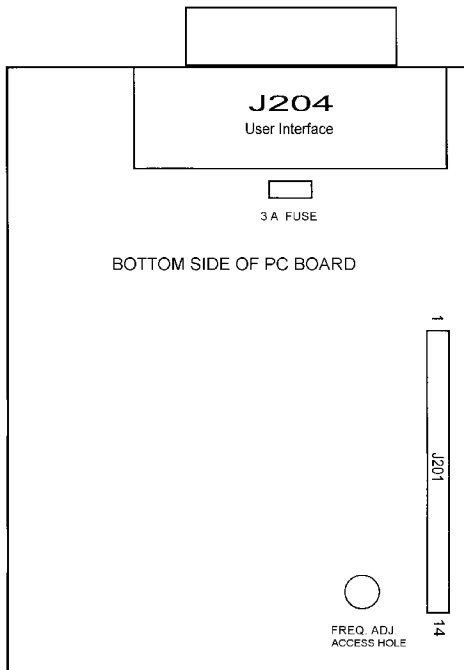

Figure 4-2 JSLM² Loader Board Frequency Adjustment Access

Technical Support Application Note
#0600003

Dataradio COR Ltd.

USA 800-992-7774; International 507-833-8819

Product: JSLM² module – DL-3282 Bell 103, Bell 202 Modem Configuration

Application:

To provide technical information for connecting a JSLM² analog module with a DL-3282 RS-232 Modem. The JSLM² module family is designated as part number 242-2040-XXX for UHF models. The DL-3282 Modem is part number 250-3282-002 and is available as Bell 202 or Bell 103 format. Combined with an interface cable (part number 697-3414-003), the module and modem will provide a reliable 300 baud or 1200 baud RS-232 serial Dataradio system.

Setup:

DL-3282 Modem: The DL-3282 modem does not require special programming for normal Bell 202 or Bell 103 format. All data parameters are set using an eight-position DIP switch located inside the

Table 1: DL-3282 Dip Switch Functions

Position	Function	Factory Default
1. Normal/Loop	Normal operation/loopback test mode	Off-normal
2. Conventional	Normal operation of interfacing to trunking radio system	Off - conventional
3. Bell 202/103	Selects modem format	Off – Bell 202
4. Squelch Invert	Carrier Detect inversion	Off – Active high
5. Half/Full Duplex	Duplex mode determination	Off – Half
6. Option 1	Self-test mode	Off – Self test off
7. and 8. RTS/CTS Delay	Set RTS/CTS Delay Timer	On, On – 240 msec delay

modem.

Programming:

JSLM² Module – The JSLM² module is computer programmable using the Windows® based programming kit (part number 250-2100-001). (The Field Programming Software requires Windows® 95 or better.) This kit includes the programming software (on CD-ROM) and the programming cable. Software upgrades are available on our website at http://www.dataradio.com/download_form.shtml.

Power to the module is applied through the programming cable using the Red (B+) and Black (ground) wires. Supply voltage is specified from +6.0VDC to +15 VDC. Nominal operating voltage is +7.2 VDC or +12.5 VDC.

Dataradio recommends storing the programming software on the hard drive of the computer. When the program is loaded, click on the “Read” button to read the unit’s current programming. Click on “Parms” and select the appropriate tab (Settings, Radio or Frequencies) to make settings as required. NOTE: If your application requires one frequency pair, Dataradio recommends all channel locations be programmed with the same frequencies.

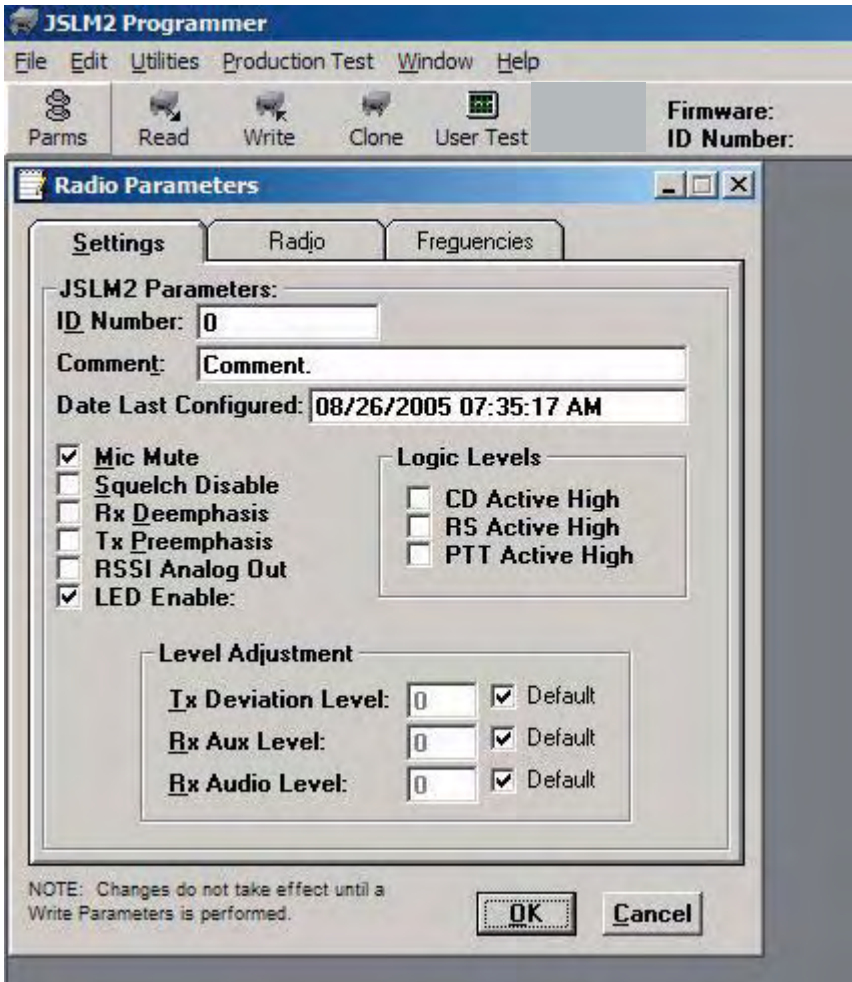

Table 2: Recommended JSLM² Programming Settings (for interfacing with DL-3282 Modem)

CD – Carrier Detect	Active high (Settings tab)
RS – Ready to Send	Active high (Settings tab)
PTT – Push to Talk	Active low (Settings tab)
Mic Mute	On (Settings tab)
Squelch Disable	Off (Settings tab)
Rx De-emphasis	Off (Settings tab)
Tx Pre-emphasis	Off (Settings tab)
RNET Xtal Compatibility Mode	Off (Settings tab)
PTT Watchdog	Optional (Radio tab Revs A - I)
Carrier Detect	On: -110 dBm; Off: -115 dBm Carrier Detect settings are selected to optimize the system based on Receive Signal Strength. (Radio tab)

Clicking OK will close the Settings (or Radio, Frequencies) window and save current settings to local memory. A Write must be performed to program settings to the JSLM².

Connections:

Connection between the JSLM² and DL-3282 is made with the interface cable (697-3414-003).

Figure 1 Typical JSLM²– Modem Configuration and Connection

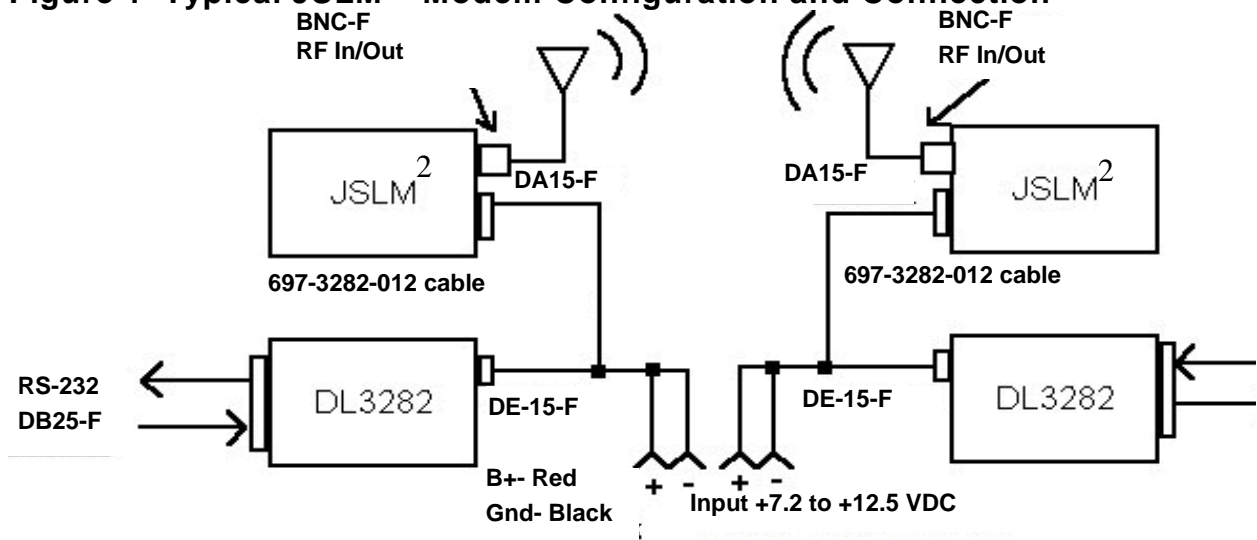

RF Exposure Compliance Requirements

JSLM² VHF Analog Telemetry Module

FCC Rule: 1.1307, 1.1310, 2.1091 (b) (d), 2.1093

IC Rule: RSS-119 Section 9, RSS-102 Section 2.2

Description of Compliance:

The JSLM² will be professionally installed in the SCADA (Supervisory Control And Data Acquisition) market and will be mounted with a fixed RTU (Remote Terminal Unit). A typical installation would use a maximum gain antenna of 10 dBi mounted on a tower. A minimum separation distance of more than 141 cm must be maintained between the radiating structure and any person to classify as a mobile under FCC MPE regulations. **Note: It is the responsibility of the user to guarantee compliance with the FCC MPE regulations when operating this device in a way other than described above.**

The calculation for the more stringent specification, a General Population/Uncontrolled Mobile device according to section 2.1091(b) and section 1.1310 Note 2 is shown below:

Limits for General Population/Uncontrolled Exposure:

Frequency Range (MHz)	Electric Field Strength (V/m)	Magnetic Field Strength (A/m)	Power Density (mW/cm ²)	Averaging Time (mins)
0.3-1.34	614	1.63	*(100)	30
1.34-30	824/f	2.19/f	*(180/f ²)	30
30-300	27.5	0.073	0.2	30
300-1500	---	---	f (MHz)/1500 (MHz)	30
1500-100000	---	---	1.0	30

Environmental Specification: 0.2 mW/cm²

$$S = (PG)/(4\pi R^2) \quad (\text{OET Bulletin 65})$$

Where:

S = Power Density (mW/cm²)

P = Power input to the antenna (mW)

G = Power Gain of the antenna in the direction of interest relative to an isotropic radiator

R = Distance to the center of radiation of the antenna (cm)

Distance Calculation:

$$R = \sqrt{((PG)/(4\pi S))}$$

Typical Antenna Gain: 10.0 dBi $10^{(10.0 \text{ dBi}/10)} = 10.0$

Power input to the Antenna: 37dBm = $10^{(37\text{dBm}/10)} = 5000 \text{ mW}$

$$R = \sqrt{((5000\text{mW}*10.0)/(4\pi*0.2 \text{ mW/cm}^2))} = 141 \text{ cm (Minimum Distance)}$$

JSLM² UHF Analog Telemetry Module

FCC Rule: 1.1307, 1.1310, 2.1091 (b) (d), 2.1093

IC Rule: RSS 119 Section 9, RSS-102 Section 2.2

Description of Compliance:

The JSLM² will be professionally installed in the SCADA (Supervisory Control And Data Acquisition) market and will be mounted with a fixed RTU (Remote Terminal Unit). A typical installation would use a maximum gain antenna of 10 dBi mounted on a tower. A minimum separation distance of more than 121 cm must be maintained between the radiating structure and any person to classify as a mobile under FCC MPE regulations. **Note: It is the responsibility of the user to guarantee compliance with the FCC MPE regulations when operating this device in a way other than described above.**

The calculation for the more stringent specification, a General Population/Uncontrolled Mobile device according to section 2.1091(b) and section 1.1310 Note 2 is shown below:

Limits for General Population/Uncontrolled Exposure:

Frequency Range (MHz)	Electric Field Strength (V/m)	Magnetic Field Strength (A/m)	Power Density (mW/cm ²)	Averaging Time (mins)
0.3-1.34	614	1.63	*(100)	30
1.34-30	824/f	2.19/f	*(180/f ²)	30
30-300	27.5	0.073	0.2	30
300-1500	---	---	f (MHz)/1500 (MHz)	30
1500-100000	---	---	1.0	30

Environmental Specification: $f(\text{MHz})/(1500 \text{ mW/cm}^2)$
 $406 \text{ MHz}/(1500 \text{ MHz mW/cm}^2) = 0.27 \text{ mW/cm}^2$ (worst case)

$$S = (PG)/(4\pi R^2) \quad (\text{OET Bulletin 65})$$

Where:

S = Power Density (mW/cm²)

P = Power input to the antenna (mW)

G = Power Gain of the antenna in the direction of interest relative to an isotropic radiator

R = Distance to the center of radiation of the antenna (cm)

Distance Calculation:

$$R = \sqrt{((PG)/(4\pi S))}$$

Typical Antenna Gain: 10.0 dBi $10^{(10.0 \text{ dBi}/10)} = 10.0$

Power input to the Antenna: 37dBm = $10^{(37\text{dBm}/10)} = 5000 \text{ mW}$

$$R = \sqrt{((5000\text{mW}*10.0)/(4\pi*0.27 \text{ mW/cm}^2))} = 121 \text{ cm (Minimum Distance)}$$

DATA TELEMETRY PRODUCT WARRANTY

Dataradio COR Ltd. ("DRL") warrants to the original purchaser for use ("Buyer") that data telemetry products manufactured by DRL ("Products") are free from defects in material and workmanship and will conform to DRL's published technical specifications for a period of, except as noted below, two (2) years from the date of shipment to Buyer. DRL makes no warranty with respect to any equipment not manufactured by DRL, and any such equipment shall carry the original equipment manufacturer's warranty only. DRL further makes no warranty as to and specifically disclaims liability for, availability, range, coverage, grade of service or operation of the repeater system provided by the carrier or repeater operator. Any return shipping charges for third party equipment to their respective repair facilities are chargeable and will be passed on to the Buyer.

If any Product fails to meet the warranty set forth above during the applicable warranty period and is returned to a location designated by DRL. DRL, at its option, shall either repair or replace such defective Product, directly or through an authorized service agent, within thirty (30) days of receipt of same. No Products may be returned without prior authorization from DRL. Any repaired or replaced Products shall be warranted for the remainder of the original warranty period. Buyer shall pay all shipping charges, handling charges, fees and duties for returning defective Products to DRL or DRL's authorized service agent. DRL will pay the return shipping charges if the Product is repaired or replaced under warranty, exclusive of fees and duties. Repair or replacement of defective Products as set forth in this paragraph fulfills any and all warranty obligations on the part of DRL.

This warranty is void and DRL shall not be obligated to replace or repair any Products if (i) the Product has been used in other than its normal and customary manner; (ii) the Product has been subject to misuse, accident, neglect or damage or has been used other than with DRL approved accessories and equipment; (iii) unauthorized alteration or repairs have been made or unapproved parts have been used in or with the Product; or (iv) Buyer failed to notify DRL or DRL's authorized service agent of the defect during the applicable warranty period. DRL is the final arbiter of such claims.

THE AFORESAID WARRANTIES ARE IN LIEU OF ALL OTHER WARRANTIES, EXPRESSED AND IMPLIED, INCLUDING BUT NOT LIMITED TO, ANY IMPLIED WARRANTY OF MERCHANTABILITY OR FITNESS FOR A PARTICULAR PURPOSE. DRL AND BUYER AGREE THAT BUYER'S EXCLUSIVE REMEDY FOR ANY BREACH OF ANY OF SAID WARRANTIES IT AS SET FORTH ABOVE. BUYER AGREES THAT IN NO EVENT SHALL DRL BE LIABLE FOR INCIDENTAL, CONSEQUENTIAL, SPECIAL, INDIRECT OR EXEMPLARY DAMAGES WHETHER ON THE BASIS OF NEGLIGENCE, STRICT LIABILITY OR OTHERWISE. The purpose of the exclusive remedies set forth above shall be to provide Buyer with repair or replacement of non-complying Products in the manner provided above. These exclusive remedies shall not be deemed to have failed of their essential purpose so long as DRL is willing and able to repair or replace non-complying Products in the manner set forth above.

This warranty applies to all Products sold worldwide.

Some states do not allow limitations on implied warranties so the above limitations may not be applicable. You may also have other rights which vary from state to state.

EXCEPTIONS

- ONE YEAR:** Labor to replace defective parts in repeaters or base stations
- THIRTY DAY:** Tuning and adjustment of telemetry radios
- NO WARRANTY:** Fuses, lamps and other expendable parts