

ViPR

Wireless Radio Modem User Manual

Preliminary – For Internal Use Only

Copyright DATARADIO Inc.
April 2007

Part no.:

Table of Contents

1. PRODUCT OVERVIEW	11
1.1 INTENDED AUDIENCE	11
1.2 GENERAL DESCRIPTION	11
1.2.1 Characteristics	12
1.2.2 Configuration	12
1.2.3 Accessories and Options	13
1.3 FACTORY TECHNICAL SUPPORT	13
1.4 PRODUCT WARRANTY, RMA AND CONTACT INFORMATION	13
1.4.1 RMA REQUEST	13
1.4.2 PRODUCT DOCUMENTATION	14
1.5 UNPACKING	14
2. INSTALLATION	15
2.1 UL APPROVED FOR CLASS I, DIVISION 2 OR ZONE 2	15
2.2 ANTENNA INSTALLATION	15
2.2.1 Professional Installation & RF Exposure Compliance Requirements	15
2.2.2 Antenna Connection	15
2.2.3 RF Path and communications range	16
2.2.4 Antennas	16
2.3 NETWORK APPLICATION	16
2.3.1 Modes	16
2.3.1.1 Bridge mode	16
2.3.1.2 Router mode	16
2.3.2 Connections	16
2.4 SELECTABLE DATA RATES	17
2.5 POINT TO POINT SYSTEM	18
3. PHYSICAL DESCRIPTION	19
3.1 LEDS	20
3.2 USER CONNECTOR PIN-OUTS	21
3.2.1 Ethernet LAN Port	21
3.2.2 SETUP & COM Ports	21
3.3 DIAGNOSTIC CONNECTIONS	23
3.3.1 Parameter	23
3.3.2 Output Format	23
3.3.2.1 Output Samples	25
4. OPERATION & CONFIGURATION	26
4.1 BROWSER-BASED SETUP AND STATUS	26
4.2 LAN SETUP	26
4.3 LOGIN SCREEN	26
4.3.1 Initial Installation Login	26
4.4 INTERFACE	27
4.4.1 Apply, Cancel, Save Config, and Reset Unit	27
4.5 SETUP WIZARD (BRIDGE MODE)	29
4.5.1 Procedure	29
4.6 DEFAULT IP SETTINGS	32
4.6.1 Ethernet Interface	32
4.6.2 RF Interface	32
4.7 IP NETWORK SETTINGS	32
4.7.1 Factory Settings in Bridge Mode	32
4.7.2 IP Network Settings in Bridge Mode	33
4.7.3 IP Network Settings in Router Mode (with Host)	33
4.7.4 IP Network Settings in Router Mode (with Router)	34
4.8 ADVANCED IP SETTINGS	35

4.8.1	Unit Status	35
4.8.2	Setup (Basic).....	36
4.8.2.1	Setup (General).....	36
4.8.2.2	Basic IP Configuration.....	37
4.8.2.3	RF Setup	38
4.8.2.4	Serial Ports Setup.....	39
4.8.2.5	Diagnostics.....	41
4.8.3	Setup (Advanced).....	42
4.8.3.1	LAN (IP).....	42
4.8.3.2	RF (IP).....	43
4.8.3.3	IP Services Setup	44
4.8.3.3.1	NAT Overview.....	45
4.8.3.4	IP addressing modes	47
4.8.3.4.1	IP Broadcast/Multicast Overview	48
4.8.3.5	IP Optimization & Tuning	52
4.8.3.6	Time Source.....	53
4.8.3.7	Ethernet (PHY)	54
4.8.3.8	RF Link.....	54
4.8.4	Security.....	55
4.8.4.1	Pass Control.....	55
4.8.4.2	Access List.....	56
4.8.5	Statistics.....	57
4.8.5.1	TCP/IP	57
4.8.5.2	AirLink	58
4.8.5.3	Interfaces.....	58
4.8.6	Maintenance	59
4.8.6.1	Ping Test.....	59
4.8.6.2	Unit Configuration Control.....	60
4.8.6.3	Package Control.....	61
4.8.7	Radio - RF Tests	62
4.8.8	Help	62
5.	OPTIMIZATION & TROUBLESHOOTING	63
5.1	MAXIMIZING TCP/IP.....	65
5.2	MAXIMIZING VIA SETUP PAGES.....	65
5.2.1	Use Router Mode.....	65
5.2.2	Reduce RF MTU size	<i>Error! Bookmark not defined.</i>
5.2.3	Reduce RF network bit rate	65
5.2.4	Increase OIP Retries Limit	66
5.3	TROUBLESHOOTING TOOLS	66
5.3.1	Network Connectivity.....	66
5.3.2	Configuration Information	67
5.3.3	Statistics Information.....	67
5.4	FIRMWARE UPGRADING	68
5.4.1	Procedure	68
5.4.1.1	File Integrity Failure	69
6.	SPECIFICATIONS	70
	FIGURE 1 – ViPR – TO BE UPDATED WHEN AVAILABLE.....	11
	FIGURE 3 – ANTENNA	16
	FIGURE 4 - BASIC SETUP	17
	FIGURE 5 - SETUP USING SWITCH (OR HUB) AND POE POWER INJECTOR.....	17
	FIGURE 6 - POINT-TO-POINT IP NETWORK SYSTEM	18
	FIGURE 7 - POINT-TO-MULTIPOINT SYSTEM.....	18
	FIGURE 8 - ViPR FRONT PANEL.....	19
	FIGURE 9 - PACKETS COUNTS FOR PER	24

FIGURE 10 - ENTER NETWORK PASSWORD SCREEN (APPEARANCE MAY VARY WITH BROWSER USED)	26
FIGURE 11 - WEB USER INTERFACE – WELCOME SCREEN	27
FIGURE 13 – ATTENTION SUB-WINDOW.....	27
FIGURE 14 - SETUP WIZARD - PAGE ONE.....	29
FIGURE 15 - SETUP WIZARD - PAGE TWO	29
FIGURE 16 - SETUP WIZARD - PAGE THREE	30
FIGURE 17 - SETUP WIZARD - PAGE FOUR	30
FIGURE 18 - SETUP WIZARD - PAGE FIVE (ROUTER MODE).....	31
FIGURE 19 - SETUP WIZARD – PAGE FIVE (BRIDGE MODE).....	31
FIGURE 20 - FACTORY IP NETWORK SETTINGS IN TRANSPARENT BRIDGE MODE WITH NO SERVICES	32
FIGURE 21 - IP NETWORK SETTINGS IN TRANSPARENT BRIDGE MODE WITH SERVICES.....	33
FIGURE 22 - IP NETWORK SETTINGS IN ROUTER MODE (WITH HOST).....	33
FIGURE 23 - IP NETWORK SETTINGS IN ROUTER MODE (WITH ROUTER)	34
FIGURE 24 - UNIT STATUS.....	35
FIGURE 25 – SETUP (BASIC) GENERAL	36
FIGURE 26 - SETUP (BASIC) – BASIC IP CONFIGURATION.....	37
FIGURE 27 - SETUP (BASIC) – RF SETUP.....	38
FIGURE 28 - SETUP (BASIC) – RF SETUP.....	39
FIGURE 29 - DIAGNOSTICS – THINNING VALUE	41
FIGURE 30 - ADVANCED IP CONFIGURATION - LAN (IP).....	42
FIGURE 31 - ADVANCED IP CONFIGURATION - RF (IP).....	43
FIGURE 32 - ADVANCED IP CONFIGURATION – IP SERVICES SETUP	44
FIGURE 33 - BASIC NAT OPERATIONS.....	45
FIGURE 34 - NAT ENABLED ON ViPR.....	46
FIGURE 35 - PRIVATE TO PUBLIC.....	46
FIGURE 36 - ADVANCED IP CONFIGURATION – IP ADDRESSING MODES.....	47
FIGURE 37 - REGISTRATION TO MULTICAST GROUP (FIRST STEP)	48
FIGURE 38 - RECEPTION OF MULTICAST PACKETS (SECOND STEP).....	49
FIGURE 39 - BROADCAST WINDOW DETAIL	49
FIGURE 40 - TYPICAL ViPR MULTICAST GROUPS.....	50
FIGURE 41 - MULTICAST WINDOW DETAILS (ON THE MAIN ViPR UNIT).....	51
FIGURE 42 - REGISTRATION TO MULTICAST GROUP	51
FIGURE 43 - ADVANCED IP CONFIGURATION – IP OPTIMIZATION & TUNING (ROUTER MODE)	52
FIGURE 44 - ADVANCED IP CONFIGURATION – TIME SOURCE.....	53
FIGURE 45 - ADVANCED IP CONFIGURATION – ETHERNET (PHY).....	54
FIGURE 46 - ADVANCED IP CONFIGURATION – RF LINK	54
FIGURE 47 - SECURITY – PASS CONTROL.....	55
FIGURE 48 - SECURITY – ACCESS LIST.....	56
FIGURE 49 - STATISTICS – TCP/IP	57
FIGURE 50 - STATISTICS – AIRLINK – CHANNEL UTILIZATION.....	58
FIGURE 51 - STATISTICS – INTERFACES	58
FIGURE 52 - MAINTENANCE – PING TEST.....	59
FIGURE 53 - MAINTENANCE - UNIT CONFIGURATION CONTROL (INITIAL SCREEN).....	60
FIGURE 54 – PACKAGE CONTROL.....	61
FIGURE 55 - RF TESTS	62
FIGURE 56 - HELP ICON.....	62
FIGURE 57 - SAMPLE FTP PROGRAM	69
TABLE 1 – ON-AIR DATA RATES, BIT AND BAUD RATES	12
TABLE 2 - ACCESSORIES	13
TABLE 3 - ViPR LEDs INDICATIONS	20
TABLE 4 - PIN-OUT FOR IEEE-802.3AF RJ-45 RECEPTACLE CONTACTS	21
TABLE 5 - PIN-OUT FOR DCE J11A & B, 9-CONTACT DE-9 CONNECTOR.....	21
TABLE 6 - SIMPLIFIED RATING OF OUTPUT VALUE REPRESENTING PACKET ERROR RATE (PER)	24

TABLE 7 – DECODING SAMPLE OUTPUT FOR ROUTER MODE 25

APPENDIX 1 - DATA TELEMETRY WARRANTY 72

What's New in this version

History

Version 1.00, Preliminary, 12December 2006

- Draft leading to Initial release of Dataradio® ViPR™ wireless radio modem User Manual

Version 2.00, Preliminary, 11 April 2007

- Changed iPR radio name to ViPR. Made numerous updates to specifications. Removed references to HiPR-900.

About Dataradio

Dataradio is a leading designer and manufacturer of advanced wireless data products and systems for mission critical applications. Our products are found at the heart of mobile data and SCADA networks around the world.

With over 25 years dedicated to data technology and innovation, Dataradio is the premier source for wireless data solutions. Our products include mobile data products, telemetry devices, integrated wireless modems for fixed point-to-point and point to multi-point applications, and OEMs. Our product line is one of the broadest in the industry covering the most often-used frequency bands.

Dataradio COR Ltd.

Dataradio COR Ltd. designs and manufactures radios and integrated wireless modems to serve a wide variety of data communication needs. Dataradio produces equipment for the fixed data market including SCADA systems for utilities, petrochemical, waste and fresh water management markets and RF boards for OEM applications in the Radio Frequency Data Capture market.

Product Warranty

The manufacturer's warranty statement for this product is available in Appendix 1.

www.dataradio.com

Dataradio provides product brochures, case studies, software downloads, and product information on our website. Every effort is taken to provide accurate, timely product information in this user manual. Product updates may result in differences between the information provided herein and the product shipped. The information in this document is subject to change without notice.

DATARADIO is a registered trademark, ViPR and TRUSTED WIRELESS DATA are trademarks of Dataradio Inc

Definitions

<u>Item</u>	<u>Definition</u>
Access Point	Communication hub for users to connect to a LAN. Access Points are important for providing heightened wireless security and for extending the physical range of service a wireless user has access to.
AES	Advanced Encryption Standard (AES)
Airlink	Physical radio frequency connections used for communications between units.
ARP	Address Resolution Protocol – Maps Internet address to physical address.
Backbone	The part of a network that connects most of the systems and networks together, and handles the most data.
Bandwidth	The transmission capacity of a given device or network.
Browser	An application program that provides a way to look at and interact with all the information on the World Wide Web.
Collision LED	Connection is established but collisions are occurring.
COM Port	Both RS-232 serial communications ports of the ViPR wireless radio modem are configured as DCE and are designed to connect directly to a DTE.
Default Gateway	A device that forwards Internet traffic from your local area network.
DCE	Data Communications Equipment. This designation is applied to equipment such as modems. DCE is designed to connect to DTE.
DHCP	Dynamic Host Configuration Protocol - A networking protocol that allows administrators to assign temporary IP addresses to network computers by "leasing" an IP address to a user for a limited amount of time, instead of assigning permanent IP addresses.
DNS	Domain Name Server - translates the domain name into an IP address.
Domain	A specific name for a network of computers.
DTE	Data Terminal Equipment. This designation is applied to equipment such as terminals, PCs, RTUs, PLCs, etc. DTE is designed to connect to DCE.
Dynamic IP Addr	A temporary IP address assigned by a DHCP server.
Ethernet	IEEE standard network protocol that specifies how data is placed on and retrieved from a common transmission medium.
Endspan PSE	Power Sourcing Equipment – Equipment used to inject PoE over the unused conductors, over the data bearing conductor, or over both types of conductors of a 4-pair standard cable (E.g: CAT5).
Firewall	A set of related programs located at a network gateway server that protects the resources of a network from users from other networks.
Firmware	The programming code that runs a networking device.
Fragmentation	Breaking a packet into smaller units when transmitting over a network medium that cannot support the original size of the packet.
FTP	File Transfer Protocol - A protocol used to transfer files over a TCP/IP network.

Gateway	A device that interconnects networks with different, incompatible communications protocols.
HDX	Half Duplex. Data transmission that can occur in two directions over a single line, using separate Tx and Rx frequencies, but only one direction at a time.
HiPR-900	Frequency hopping spread spectrum wireless modem that operates in the license-free 902-928 MHz band.
ViPR™	DSP-based narrowband Ethernet IP radio (6.25 / 12.5 / 25 kHz – UHF). Licensed narrowband OIP radio, “companion” to the un-licensed HiPR product.
HTTP	HyperText Transport Protocol - The communications protocol used to connect to servers on the World Wide Web.
IPCONFIG	A Windows 2000 and XP utility that displays the IP address for a particular networking device.
LNK/ACT LED	Ethernet connection established – Ethernet data activity.
MAC	Media Access Control - The unique address that a manufacturer assigns to each networking device.
Midspan PSE	Power Sourcing Equipment – Equipment used to inject PoE over the unused conductors of a 4-pair standard cable (E.g.: CAT5)
MTU	Maximum Transmission Unit - The largest TCP/IP packet that the hardware can carry.
NAT	Network Address Translation - NAT technology translates IP addresses of a local area network to a different IP address for the Internet.
Network	A series of computers or devices connected for the purpose of data sharing, storage, and/or transmission between users.
Network speed	This is the <i>bit rate</i> on the RF link between units.
Node	A network junction or connection point, typically a computer or work station.
OIP	Optimized IP – Compresses TCP and UDP headers, and filters unnecessary acknowledgments. This makes the most use of the available bandwidth.
OTA	Over-The-Air - Standard for the transmission and reception of application-related information in a wireless communications system
Parallel Decode	Patented technology used by HiPR products featuring dual receivers for added data decode sensitivity in multi-path and fading environments. (<i>United States Patent No: 6,853,694 B1</i>)
PHY	A PHY chip (called PHYceiver) provides interface to the Ethernet transmission medium. Its purpose is digital access of the modulated link (usually used together with an MII-chip). <i>The PHY defines data rates and transmission method parameters.</i>
Ping	Packet INternet Groper - An Internet utility used to determine whether a particular IP address is online.
PLC	Programmable Logic Controller. A user-provided intelligent device that can make decisions, gather and report information, and control other devices.
Powered Device	Device that is drawing power from an Ethernet cable. A powered device is compatible with both midspan PSE and endspan PSE; it is insensitive to polarity
PWR LED	Indicates presence of DC power input.
RIPv2	Dynamic IP routing protocol based on the distance vector algorithm.
Router	A networking device that connects multiple networks together.

RS-232	Industry–standard interface for data transfer.
RTU	Remote Terminal Unit. A user-provided SCADA device used to gather information or control other devices.
Rx/Tx LED	Transmission /Reception activity
SCADA	Supervisory Control And Data Acquisition. A general term referring to systems that gather data and/or perform control operations.
SNTP	Simple Network Time Protocol - Protocol for synchronizing the clocks of computer systems over packet-switched, variable-latency data networks. <i>Uses UDP as its transport layer.</i>
Static IP Address	A fixed address assigned to a computer or device that is connected to a network.
Static Routing	Forwarding data in a network via a fixed path.
Subnet Mask	An Ethernet address code that determines the size of the network.
Switch	A data switch that connects computing devices to host computers, allowing a large number of devices to share a limited number of ports.
Sync	Data transmitted on a wireless network that keeps the network synchronized.
TCP	Transmission Control Protocol - A network protocol for transmitting data that requires acknowledgement from the recipient of data sent.
TCP/IP	Transmission Control Protocol/Internet Protocol - A set of protocols to communicate over a network.
TDD	Time Division Duplex - Allows (virtually) simultaneous transmission in both directions. The uplink and downlink transmissions use the same frequency, but are allocated different time slots.
Telnet	A user command and TCP/IP protocol used for accessing remote PCs.
TFTP	Trivial File Transfer Protocol – UDP/IP based file transfer protocol.
Topology	The physical layout of a network.
Transparent	A transparent unit transmits all data without regard to special characters, etc.
Terminal Server	Acts as a converter between Ethernet/IP and RS-232 protocols.
Tx/Rx LED	Airlink data activity
UDP	User Datagram Protocol - A network protocol for transmitting data that does not require acknowledgement from the recipient of the data that is sent.
Upgrade	To replace existing software or firmware with a newer version.
URL	Universal Resource Locator - The address of a file located on the Internet.
VPN	Virtual Private Network - A security measure to protect data as it leaves one network and goes to another over the Internet.
WINIPCFG	A Windows 98 and Me utility that displays the IP address for a particular networking device.
WLAN	Wireless Local Area Network - A group of computers and associated devices that communicate with each other wirelessly.

1. Product Overview

This document provides information required for the operation and verification of the DATARADIO® ViPR narrowband Ethernet IP radiomodem.

1.1 Intended Audience

This manual is intended for system designers, professional installers, and maintenance technicians.

1.2 General Description

Dataradio's ViPR radiomodem is a DSP-based narrowband Ethernet IP radio that operates in the UHF (406.1-512 MHz) frequency ranges.

The ViPR radiomodem is designed for SCADA, telemetry, control, and industrial applications in Point-to-Point and Point-to-Multipoint configurations.

The ViPR radiomodem supports serial and Ethernet/IP Remote Terminal Units (RTU) and programmable logic controllers (PLC). It is standard IEEE 802.3af compliant.

The ViPR wireless modem consists of two logic PCBs; one that includes the modem circuitry and the other the radio module. Both are installed in a cast aluminum case.

The unit is not hermetically sealed and should be mounted in a suitable enclosure when dust and/or a corrosive atmosphere are anticipated. There are no external switches or adjustments; all operating parameters are set via a web browser.

Figure 1 – ViPR – to be updated when available

1.2.1 Characteristics

The ViPR product has the following operational characteristics:

- An ViPR RF deck, frequency range of 406.1-470 MHz and 450-512 MHz.
- High-speed user-selectable data rates of up to 32 Kbps in full channel, 16 Kbps in half channel, and 8 Kbps in quarter channel.
- Built-in transceiver adjustable to 10 watts.
- Used as an access point or an end point with each configurable in:
 - ◆ Bridge mode – *for quick setup of units on same network*
 - ◆ Router mode - *for advanced networks*
- Embedded web server to access status and/or setup information.
- Remote access for over-the-air system firmware upgrades.
- Wide input power range of 10 to 30 volts DC
- AES 128-bit data encryption
- Superior data compression
- Native UDP and TCP/IP support
- Optimized IP (OIP) protocol reduction
- Diagnostics
- Supports up to 32 different frequency channel pairs
- SNMP for first-level service by non IT personnel
- RF diagnostics
- Store/Forward feature

Table 1 – On-air Data Rates, Bit and Baud Rates

	Quarter Channel Channel spacing 6.25 kHz	Half Channel Channel spacing 12.5 kHz	Full Channel Channel Spacing 25 kHz
Bit Rates	4-8 kb/s	8 - 16 kb/s	16 – 32 kb/s
Baud Rates	4 kHz	8 kHz	16 kHz

1.2.2 Configuration

The ViPR units are factory-configured to default settings. Configuration changes or upgrades are web browser-based.

1.2.3 Accessories and Options

Table 2 lists various accessory items available for the ViPR Wireless Modem.

Table 2 - Accessories

Accessory	Dataradio Part Number
ViPR DIN-rail Mounting Kit	250-5099-005 (150-5099-005)
Antenna kits	
7 dB 450-470 MHz Yagi Antenna Kit	250-0241-507
10 dB 450-470 MHz Yagi Antenna Kit	250-0241-510

For information on accessories and options, contact your sales representative. In the United States, call 1-800-992-7774 or 1-507-833-8819. For International inquiries, call 507-833-8819.

1.3 Factory Technical Support

M-F 8:00 AM to 5:00 PM

Dataradio COR Ltd.
299 Johnson Ave.
Ste 110, Waseca, MN 56093

Tel 507.833.8819 Fax 507.833.6758 Email support@dataradio.com

For application assistance, consult the Technical Support Application Notes (TSAN) at:
Dataradio.com/support.shtml

1.4 Product Warranty, RMA and Contact Information

Dataradio guarantees that every ViPR Radiomodem will be free from physical defects in material and workmanship for two (2) years from the date of purchase when used within the limits set forth in the Specifications section of this manual.

The manufacturer's warranty statement is available in Appendix 1. If the product proves defective during the warranty period, contact Dataradio COR Ltd. Customer Service to obtain a Return Material Authorization (RMA).

1.4.1 RMA REQUEST

Contact Customer Service:
299 Johnson Ave., Ste 110, Waseca, MN 56093
Tel 1.507.833.8819 Email rma@dataradio.com

BE SURE TO HAVE THE EQUIPMENT MODEL AND SERIAL NUMBER, AND BILLING AND SHIPPING ADDRESSES ON HAND WHEN CALLING. You may also request an RMA online at www.dataradio.com/rma.

When returning a product, mark the RMA clearly on the outside of the package. Include a complete description of the problem and the name and telephone number of a contact person. **RETURN REQUESTS WILL NOT BE PROCESSED WITHOUT THIS INFORMATION.**

For units in warranty, customers are responsible for shipping charges to Dataradio. For units returned out of warranty, customers are responsible for all shipping charges. Return shipping instructions are the responsibility of the customer.

1.4.2 PRODUCT DOCUMENTATION

Dataradio reserves the right to update its products, software, or documentation without obligation to notify any individual or entity. Product updates may result in differences between the information provided in this manual and the product shipped. For the most current product documentation, visit www.dataradio.com for datasheets, programming software and user manuals.

1.5 Unpacking

When ready for installation, carefully unpack your ViPR radiomodem shipping carton and identify each item as listed below:

- One ViPR radiomodem
- Power cable (5 ft) and connector
- Ethernet cable (5 ft)
- Quick Start Guide

If damage has occurred to the equipment during shipment, file a claim with the carrier immediately.

2. Installation

2.1 UL Approved for Class I, Division 2 or Zone 2

The ViPR radiomodem is suitable for use in Class I, Division 2, Groups A, B, A, D or non-hazardous locations. To meet UL compliance, the ViPR unit must be installed in an enclosure and power must be supplied by a SELV (Safety Extra Low Voltage), non-energy hazardous source. This device is powered by a terminal block (\pm).

Warning – Explosion Hazard – Do not disconnect while circuit is live unless area is known to be non-hazardous. Substitution of components may impair suitability for Class I, Division 2 or Zone 2 operation.

2.2 Antenna Installation

2.2.1 Professional Installation & RF Exposure Compliance Requirements

The ViPR radio is intended for use in the Industrial and SCADA market. The ViPR unit must be professionally installed and must ensure a minimum separation distance of more than 74 in. (188 cm) between the radiating structure and any person. An antenna mounted on a pole or tower is the typical installation and in rare instances, a 1/2-wave whip antenna is used.



The ViPR radio uses a low power radio frequency transmitter. The concentrated energy from an antenna may pose a health hazard. People should not be in front of the antenna when the transmitter is operating.

The installer of this equipment must ensure the antenna is located or pointed such that it does not emit an RF field in excess of Health Canada limits for the general population. Recommended safety guidelines for the human exposure to radio frequency electromagnetic energy are contained in the Canadian Safety Code 6 (available from Health Canada) and the Federal Communications Commission (FCC) Bulletin 65.

Notes:

Any changes or modifications not expressly approved by the party responsible for compliance (in the country where used) could void the user's authority to operate the equipment.

2.2.2 Antenna Connection

The required antenna impedance is 50 ohms. To reduce potential radio interference, the antenna type and its gain should be chosen to ensure the effective isotropic radiated power (EIRP) is not more than required for successful communication.

For installation of ground-plane dependent antennas, the center of the surface used for mounting is preferable for best omni-directional pattern. For ground-plane independent antennas, installation may be close to the edges of the mounting surface.

Figure 2 – Antenna

2.2.3 RF Path and communications range

The range of the ViPR radiomodem is dependent on terrain, RF (radio frequency) path obstacles, and antenna system. To assure reliable communications, a competent professional should study the RF path to determine what antennas are required and whether or not a repeater is needed.

2.2.4 Antennas

The antennas listed in Table 1, page 13 were tested and typed for maximum gain. These antennas are FCC-approved for use with the ViPR product. Similar antenna types from other manufacturers are also acceptable.

2.3 Network application

The ViPR radiomodem is suited to a variety of point-to-point or point-to-multipoint applications. This section gives an overview of some common configurations.

2.3.1 Modes

2.3.1.1 Bridge mode

Bridge mode provides for fast set-up. IP bridging allows for quick deployment of basic point-to-point and point-to-multipoint networks with minimal configuration to all units on a same network. Bridge mode carries ARP and is transparent to any IP-based or IP-encapsulated protocols.

2.3.1.2 Router mode

Used in advanced networks, router mode enables OIP optimization for reduced overhead and improved throughput, and supports more complex network topologies such as store-and-forward links. Only one radio model is needed because any ViPR unit can be configured for bridge or router mode, router gateway (access point), remote station, or even as a combined store-and-forward remote with a local drop.

2.3.2 Connections

The connections required are shown in Figure 3 below and in Figure 4 on the next page. While serial and/or Ethernet RTU or PLC are shown in the diagrams, master stations often use a PC running an application designed to communicate with remote RTUs or PLCs, or intelligent controllers.

Figure 4 shows a common connection scenario. The TX/RX antenna is required for basic operation. The power connection allows for a wide range of input DC power, whether the user system is a nominal 12 or 24 VDC supply system. A setup PC can be connected via the serial port, allowing for setup and configuration of the ViPR unit as well as local and remote diagnostics. It may be left connected at all times but is not required for normal operation once the unit has been configured. *The Ethernet port allows end users Ethernet-capable RTU or PLC to be connected.*

Figure 3 - Basic Setup

Figure 5 shows the various connection opportunities for the ViPR radiomodem. The TX/RX antenna is required for basic operation.

Figure 4 - Setup using Switch (or Hub)

2.4 Selectable Data Rates

Switchable data rates allow optimizing installations for highest throughput or maximum range. The sophisticated DSP modem gives optimal performance in either mode, whether a short-range LAN extension or long-range link.

2.5 Point to Point System

Shown below are typical “point to point” and “point to multipoint” connections between ViPR units. The connections indicated allow for either Ethernet or serial interfaces. The Ethernet connection provides Ethernet IP connectivity for network devices. In bridge mode, all the network devices are on the same IP Subnet. In router mode, the Ethernet connection on Master unit and the remote(s) use different IP Subnets. A hub or switch may be used to allow multiple Ethernet devices to connect to the ViPR radiomodem. Serial connections are transparent pass-through connections, allowing the use of legacy serial devices in the ViPR product environment.

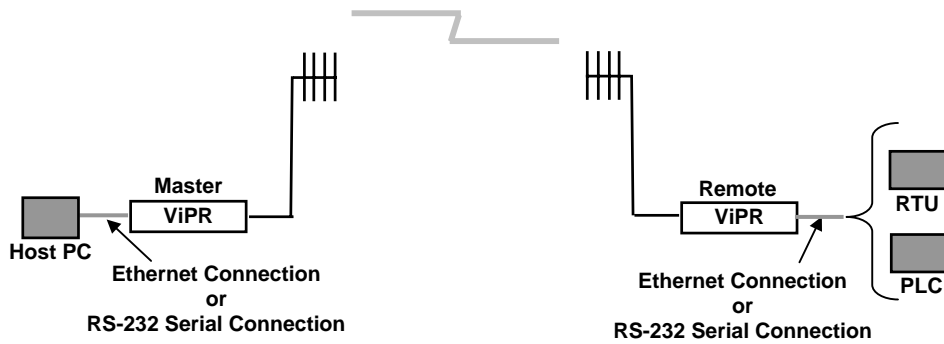

Figure 5 - Point-to-Point IP Network System

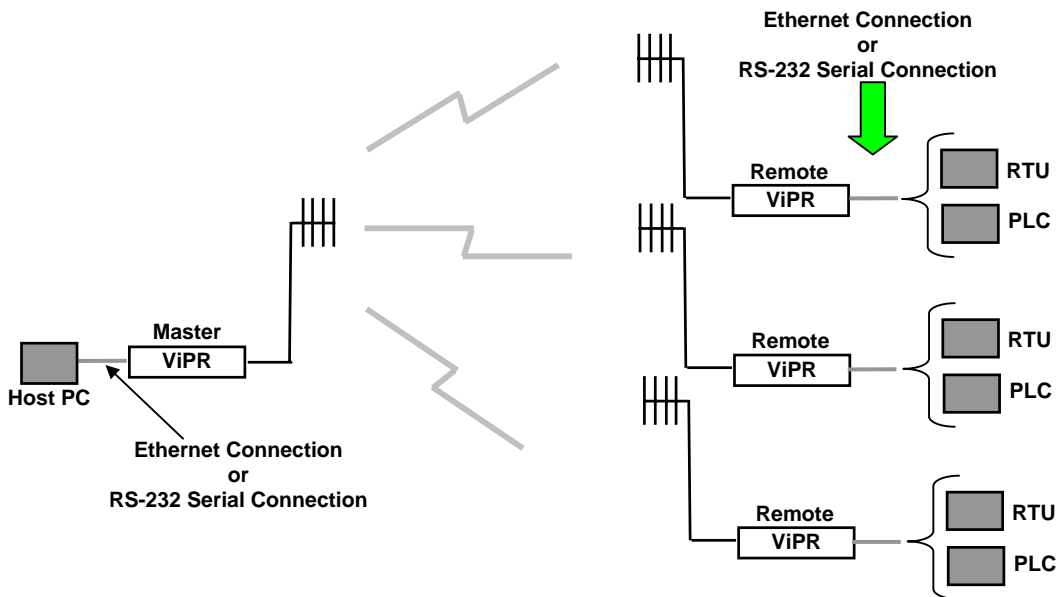

Figure 6 - Point-to-Multipoint System

3. Physical Description

Figure 7 - ViPR Front Panel

The front panel only has connections and indicators. They are:

- One standard RJ-45 auto-sensing 10/100 UTP Ethernet connection with Auto-MDIX. Supports direct connection to both Terminal Devices and Ethernet hubs or switches without resorting to crossover cables. LED indicators make it simple to verify that Ethernet cables and connections are good.
- Two DE-9F RS232 ports. Serial baud rates from 300 to 115,200 are supported. ViPR units are factory set (default) for 115,200 b/s, 8 bits, no parity, and 1 stop bit.
- The antenna connector for the transceiver is a female 50-ohm TNC type.
- One right-angle power connector. The 10 to 30 VDC wide-range switching power supply permits powering from 12 volt as well as 24 volt systems, and the high-efficiency switching design runs cooler with less loss.

LEDS

The ViPR unit has five dual-color LED indicators. Their functions are shown in Table 3.

Table 3 - ViPR LEDs indications

ViPR LEDs indications						
Power-on Sequence (LEDs are grouped)						
	PWR		RX / TX	STATUS	Indication	
Off	Off		Off	Off	ViPR Off	
Boot 1	Solid Red		Off	Off	Boot in progress	
	Blinking Red on Black (3 short red)		Off	Off	RAM or Self Test Error	
	Blinking Red on Black (Long / Short reds)		Off	Off	Unable to proceed to next boot step	
Boot 2	Solid Amber		Off	Off	Boot in progress	
	Blinking Amber on Black (Short amber blink)		Off	Off	Exception error (Reboot in 10 secs)	
	Blinking Red on Amber (Short red blink)		Off	Off	Unable to complete boot process	
Power ON (LEDs are grouped)						
	PWR		RX / TX	STATUS	Indication	
Special	Blinking Amber on Black (1/2 sec each)		Blinking Amber on Black	Blinking Amber on Black	Service mode	
	Solid Amber		Solid Amber	Solid Amber	Test jumpers installed	
Normal Operation (LEDs are independent)						
Normal	PWR	Indication	RX / TX	Indication	STATUS	Indication
	Solid Green	Normal state	Flashing Green	Receiving Data	Flashing Green on Black	Neighbor Discovery
					Solid Green	Connectivity Established
			Flashing Red	RF Transmit Activity (PTT ON)	Solid Amber	Transients (CWID, TXON, other test modes)
					Solid Red	Fault
	Link/ACT	Indication			Collision	Indication
	Off	Link not OK			Off	Connection OK, No collision
	Green	Link ON, No activity			Amber	Connection OK, With collision

Notes:

Blinking refers to the LEDs turning ON and OFF based on time (such as number of times per second)

Flashing refers to the LEDs turning ON and OFF in response to an event occurring (such as packets)

Power LED steadily lit red or flashing red will require factory repair. Power LED flashing green will require factory repair only if the unit is unable to transport traffic. Refer to section 1.4.1 for mandatory factory repair procedure.

3.1 User Connector Pin-outs

3.1.1 Ethernet LAN Port

Table 4 - Pin-out for IEEE-802.3af RJ-45 receptacle contacts

Contact	10/100Base-T signal
1	TXP ⁽¹⁾
2	TXN ⁽¹⁾
3	RXP ⁽¹⁾
4	SPARE +
5	SPARE +
6	RXN ⁽¹⁾
7	SPARE -
8	SPARE -
SHELL	Shield
(1) The name shows the default function. Given the auto-MDIX capability of the Ethernet transceiver, TX and RX function could be swapped.	

3.1.2 SETUP & COM Ports

For serial ports considerations:

- ViPR radiomodem is a DCE
- Equipment connected to the ViPR SETUP / COM serial port is a DTE

Table 5 - Pin-out for DCE J11A & B, 9-contact DE-9 connector

Contact	EIA-232F Function	Signal Direction
1	DCD	DTE ← DCE
2	RXD	DTE ← DCE
3	TXD	DTE → DCE
4 ⁽¹⁾	DTR	DTE → DCE
5	GND	DTE --- DCE
6 ⁽²⁾	DSR	DTE ← DCE
7 ⁽³⁾	RTS	DTE → DCE
8	CTS	DTE ← DCE
9	RING ⁽⁴⁾	DTE --- DCE
(1) Depends on connection control mode		
(2) Always keeps DSR asserted		
(3) Ignores status of RTS (internally always asserted)		
(4) For future use		

DCD (pin 1) handling by ViPR unit UART

- Asserts the DCD signal while sending data on the UART
- Negates the DCD signal when it no longer has data queued up for TX on the UART

DTR (Data Terminal Ready) (pin 4) signal handling by ViPR UART - Depends on the serial port's connection control mode.

The connection control mode dictates how the ViPR establishes/breaks the connection (referred to as "session") between the ViPR serial ports and the selected ViPR service (CLI, Serial/RF bridge, Online Diagnostics, etc.)

- Permanent (3-wire) connection control - In this mode, the session is permanently established, so the ViPR ignores the status of the DTR signal.
- Switched (DTR bringup/teardown) connection control - In this mode, the ViPR monitors the status of the DTR signal.

- Upon DTR assertion: the session in established (bringup) phase
- Upon DTR negation: the session in closed (teardown) phase

CTS (Clear to Send) (pin 8) signal handling by the ViPR UART

- If CTS-based flow control is not used, always asserts CTS
- If CTS-based flow control is used:
 - ◆ Asserted – If level of unprocessed data in internal RX buffers is below a threshold watermark
 - ◆ Negated – If level of unprocessed data in internal RX buffers is above a threshold watermark

3.2 Diagnostic Connections

The ViPR units continually monitor and report on their environmental and operating conditions. The diagnostic information is in TCP format and is available via any telnet session to port 6272.

Transmission of online diagnostics may be enabled or disabled at any station or stations without affecting their ability to communicate with other stations. Diagnostics can be sent anywhere, including being back hauled. Back hauling adds to the network traffic flow and must be taken into account in designing a network. If a return flow is necessary, it needs to be reduced substantially to have a minimal effect on the network as described in section 3.2.1.

The ViPR radiomodem can support up to 4 diagnostics socket connections at once. This may be used, for instance, to carry out monitoring at a main office and at up to three separate field locations. It is also possible that one of the four connections use a serial port instead by enabling it on the ViPR's web browser interface.

More information, statistics, and offline test facilities are available via the browser. RF paths can be monitored and checked from either end of a link, without traveling to the other station.

3.2.1 Parameter

Adjusting the return diagnostics flow is done via parameter. This parameter indicates that only one out of every x packets delivered will generate an online diagnostic message. The "thinning value" can be adjusted using the web interface (see paragraph 4.8.2.5) and set as follows:

- ◆ 0 off
- ◆ 1 every packet delivers a diagnostics message
- ◆ 1000 every 1000th packet delivers a diagnostic message

3.2.2 Output Format

Output format is man / machine-readable, ASCII, comma-delimited format. Reader program used (*or written*) must decode the "type field" and check for type 0 as more types will be released in future. This will ensure that no changes will be required to the user online diagnostic reader program when the ViPR radio modem gets updated. The fields are:

- ◆ IP or MAC address: Depends if unit is in Bridge mode or in Router mode
 - MAC: Hex numbers format [00:01:02:03]
 - IP: Dotted decimal format [111.222.333.444]
- ◆ Type of report: Decimal number (n) that identifies the report as a "type n"
- ◆ # of fields: Decimal number indicating number of comma-delimited fields to follow
- ◆ Thinning value: Number of data packets before a diagnostic message is delivered
- ◆ Volts: Decimal indications in decivolts when source is DC input (*125 for 12.5V*)
- ◆ Temperature: Decimal internal unit temperature in Celsius degrees
- ◆ Packet error rate (or PER): 0 or negative decimal value

$$10\log_{10}\left(\frac{bad}{good}\right) \quad \text{See Figure 8 for details}$$

Thus, -51 is CRC error rate of $10^{-5.1}$ (*since reset or when net stats were cleared*). See Table 6.

Table 6 - Simplified rating of output value representing Packet Error Rate (PER)

Figure 8 - Packets Counts for PER

- ◆ Signal RSSI: Decimal level in calibrated dBm
- ◆ Background RSSI: Decimal level in calibrated dBm
- ◆ Forward power: Decimal indications in milliwatts
- ◆ Reverse power: Decimal indications in milliwatts

Value -10	Bad
Value -20	Mediocre
Value -30	Good
Value -40	Very Good
Value -50	Excellent

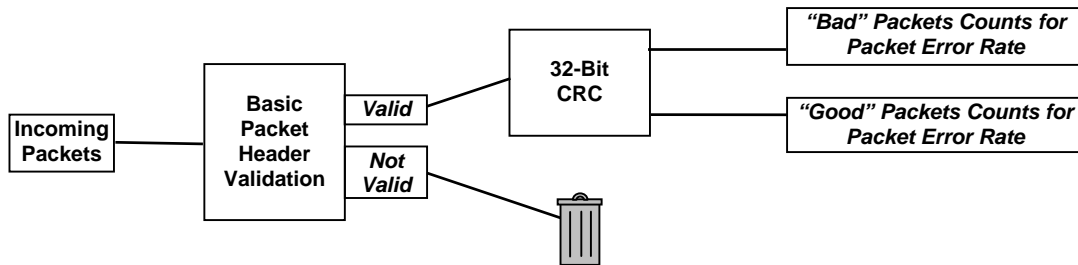

3.2.2.1 Output Samples

From command window, type `telnet nnn.nnn.nnn.nnn 6272` and the unit's diagnostic output will display on screen (*where nnn.nnn.nnn.nnn is your unit's address in dot decimal format*) (*Thinning value must not be zero*).

Note:

No overhead is generated in the ViPR unit if no online diagnostic connection is actually made.

Sample output for bridge mode (no IP address available)

```
[00:00:03:09], 0, 9, 100, 1, 5, 38, -51, -70, -108, 1000, 200
[00:00:03:09], 0, 9, 100, 1, 5, 38, -51, -70, -111, 1000, 200
```

Sample output for router mode

```
[192.168.36.188], 0, 9, 10, 0, 127, 46, -42, -70, -107, 1000, 200
[192.168.36.204], 0, 9, 10, 0, 103, 42, -53, -70, -110, 1000, 200
```

Decoding the last line (see Table 7): unit is 192.168.36.204 IP address (in router mode), type of report is 0, there are 9 fields to follow, 1/10 sampled packets are output, DC input is used, Volts are 10.3, Internal temperature is 42°C, PER of $10^{-5.3}$, with a carrier level of -70 dBm signal, an average background level of -110dBm, a forward power of 1000 milliwatts (1.0 watt), and a reverse power of 200 milliwatts (0.2 watt).

Table 7 – Decoding Sample Output for Router Mode

Field #	Field Name	Sample Output	Sample Output Decoded
1	IP address	[192.168.36.188]	Unit's IP address is 192.168.36.204
2	Report Type	0	0
3	Number of Fields to Follow	9	9
4	Number of data packets before a diagnostic message is delivered	10	1/10 sampled packets are output
5	Flags	0	DC input
6	Voltage Level	103	10.3 V
7	Internal Temperature	42	42°C
8	PER	-53	$10^{-5.3}$
9	Signal RSSI	-70	-70 dBm
10	Background RSSI	-110	-110 dBm
11	Forward power	1000	1000 mW (1.0 Watt)
12	Reverse power	200	200 mW (0.2 Watt)

4. Operation & Configuration

4.1 Browser-Based Setup and Status

A built-in web server makes configuration and status monitoring possible from any browser-equipped computer, either locally or remotely. Status, configuration, and online help are available without requiring special client software. Setup is password-protected to avoid tampering or unauthorized changes.

Both the configuration parameters and operating firmware can be updated remotely, even over the RF network itself, using the standard FTP protocol.

4.2 LAN Setup

Check that DC power is applied to the ViPR radio modem. On a PC running MS-Windows with an existing LAN connection, connect to the RJ-45 input of the ViPR. Set-up PC as follows:

1. Click Start → Control Panel → Network Connections
2. Click on the relevant Local Area Connection
3. On the Local Area Connection Status screen, click Properties
4. On the Local Area Connection Properties screen, scroll the List Box until “Internet Protocol (TCP/IP)” is highlighted, click Properties
5. On the Internet Protocol (TCP/IP) Properties screen, follow either method below:
 - A) Select “Obtain an IP address automatically”
 - B) Select “Use the following IP address” → Enter 192.168.204.254 in the IP address field → 255.255.255.0 in the Subnet mask → Leave the Default gateway blank.
6. Click the OK button

Note: Certain Operating Systems require rebooting to complete the connection process.

4.3 Login Screen

On your Internet browser address line, type the factory-default IP address given to all ViPR radio modem units: 192.168.204.1. Press Enter. The Enter Network Password screen opens.

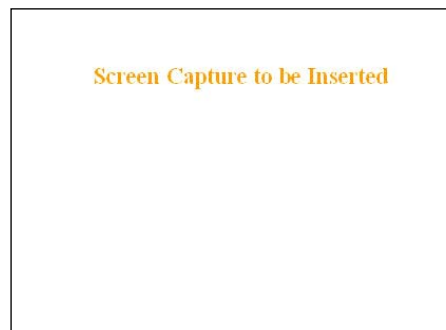

Figure 9 - Enter Network Password screen (appearance may vary with browser used)

4.3.1 Initial Installation Login

For an initial installation, enter a User Name of 1 to 15 characters and the default Password ADMINISTRATOR (*upper case letters*). Click OK. The web interface “Welcome” screen (Figure 10) opens together with the “Attention” sub-window.

Dataradio recommends immediately running the Setup Wizard. Once completed, proceed to change the ViPR radiomodem login password as detailed in section 4.8.4.1 below. Do not lose the new password! Should the password be lost, you will need to contact Dataradio support as detailed in section 1.3 earlier.

For subsequent access to the ViPR unit, use the User Name and Password that you will have configured.

Note:

The User Name entry is currently not an access-limiting factor. It only serves to identify the person gaining access. User Name may be required by future versions.

4.4 Interface

Important note: *Record all original ViPR factory settings for possible future use.*

Note: *Screen captures used throughout this document may vary slightly from actual screens.*

The ViPR user interface is used to configure and view your network settings. To navigate, use the eight top-level menus on the left, five of which expand to offer submenus. One gives Unit Status information and one allows access to the Setup Wizard.

The interface main screen lists available selections for the selected menu or presents instructions. The remaining buttons are used to save your configuration, reset the unit, or access help.

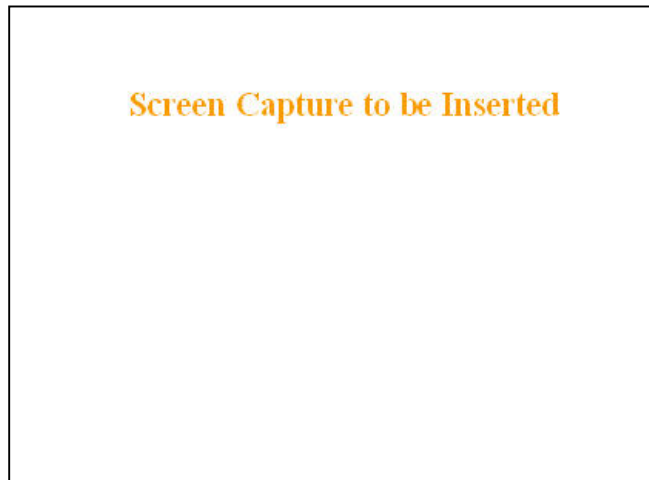
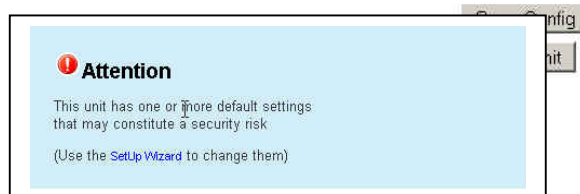

Figure 10 - Web User Interface – Welcome Screen

Figure 12 – Attention sub-window

4.4.1 Apply, Cancel, Save Config, and Reset Unit

Several submenus have “Apply” and “Cancel” buttons.



The navigation area has “Save Config” and “Reset Unit” buttons.

After making an entry into a dialog box, click on Apply to temporarily apply the value(s) entered to the relevant parameter(s). If not satisfied, click on Cancel button to restore to the value(s) present before a change was made.

Note:

Cancel command only affects the dialog boxes or radio buttons in the opened window.

If needed, go to other Submenu(s) and make more entries. Click Apply before leaving each window. When finished, click the Save Config button to make all changed entries permanent.

Use the Save Config command button before doing a Reset Unit otherwise temporarily entered parameters would be lost.

Click on Save Config button:

- If there are changes to be saved, saving occurs automatically.
- If there are no changes to be saved, a sub-window prompts user to confirm saving.

Click on “Reset Unit” button:

- If there are changes to be saved, a sub-window prompts user to confirm resetting.
- If there are no changes to be saved, resetting occurs automatically.

A “Station Reset” 20-second timer counts down while the status reports: “Working...”

When done, the status reports: “Ready”

4.5 Setup Wizard (Bridge Mode)

Four pages of the quick setup wizard have buttons to “Apply your changes” or to “Cancel your changes” during the setup process. Once all five pages are done, use the “Save Config” and the “Reset Unit” buttons to make parameter settings permanent.

If a change is made to any parameter marked:  you will need to do a “Save Config” and a “Reset Unit” in order for the change to take effect.

4.5.1 Procedure

1. Select “Setup Wizard” on the top-level menu list, or click the link on the “Attention” sub-window (Figure 12) above.
2. On page one (Figure 13) of the Setup Wizard, read the on-screen instructions. Once the Operating mode is selected, click Apply Your Changes. Wait for the Progress bar activity to stop (*right side of the Status bar*). Click on Proceed to Next Step. *If no change is made to the Operating mode, click on Proceed to Next Step.*
3. On page two (Figure 14) of the Setup Wizard, read the on-screen instructions. Once the System ID is entered, click Apply Your Changes. Wait for the Progress bar activity to stop (*right side of the Status bar*). Click on Proceed to Next Step. *If no change is made to the System ID dialog box, click on Proceed to Next Step.*

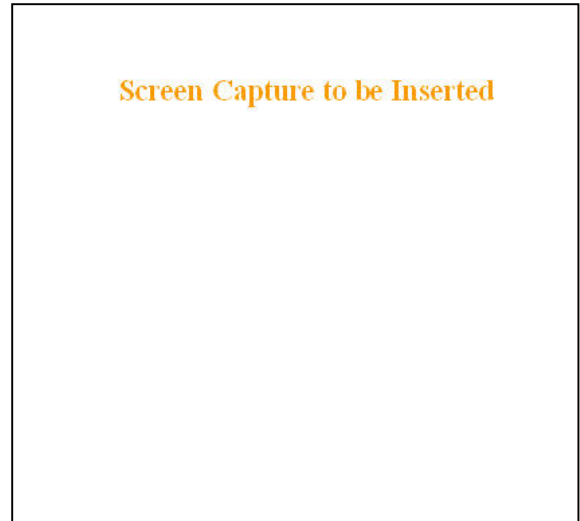

Figure 13 - Setup Wizard - Page One

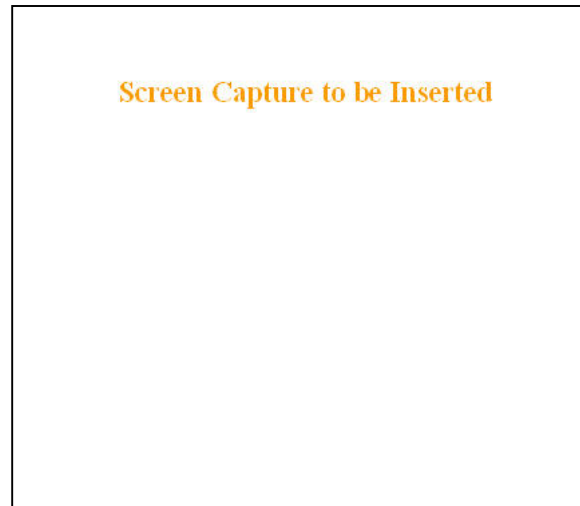

Figure 14 - Setup Wizard - Page Two

4. On page three (Figure 15) of the Setup Wizard, read the on-screen instructions. Once the Encryption Pass Phrase is entered, note the Encryption Key. Click Apply Your Changes. Wait for the Progress bar activity to stop (*right side of the Status bar*). Click on Proceed to Next Step. *If no change is made to the Encryption dialog box, click on Proceed to Next Step.*
Important: Be sure to record your encryption pass phrase for future reference.

Screen Capture to be Inserted

Figure 15 - Setup Wizard - Page Three

5. Figure 16 of the Setup Wizard, read the on-screen instructions. Once the IP Address and Network Mask are entered (optional at this point), click Apply Your Changes. Wait for the Progress bar activity to stop (*right side of the Status bar*). Click on Proceed to Next Step. *If no changes are made to the IP dialog boxes, click on Proceed to Next Step.*

Screen Capture to be Inserted

Figure 16 - Setup Wizard - Page Four

6. On page five (Figure 17) of the Setup Wizard, read the on-screen instructions. If configuring for Router mode, you have completed. For Bridge mode, click the “Switch to Bridge mode” button and follow the instructions below for both modes of operation:

Click one of the “Save Config” buttons. Wait for the Progress bar activity to stop

The status reports: “Success. Click on “Reset Unit” button. Wait for the Progress bar activity to stop. A “Station Reset” 20-second timer counts down while the status reports: “Working...”When done, the status reports: “Ready”.

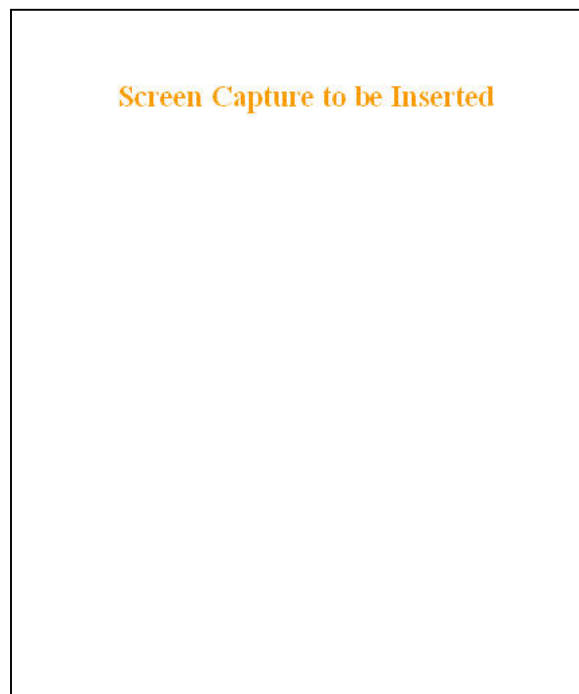

Figure 17 - Setup Wizard - Page Five (Router mode)

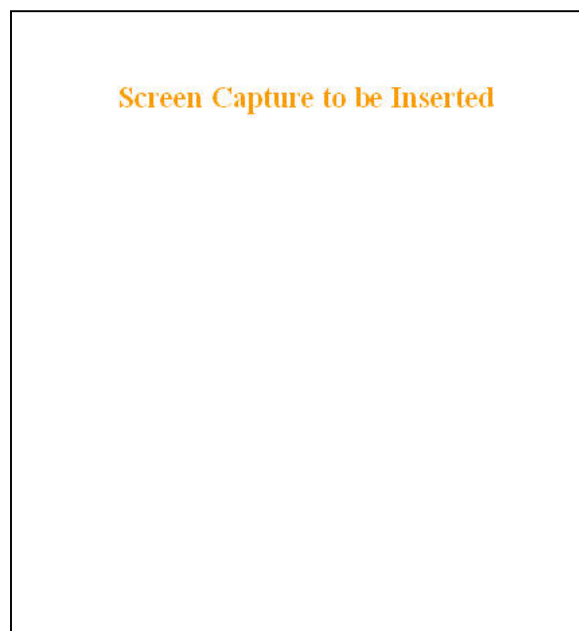

Figure 18 - Setup Wizard – Page Five (Bridge mode)

4.6 Default IP Settings

- Default RF mode is Remote
- Default IP Forwarding mode is Bridge
- Time Division Duplex (TDD) RF protocol is enabled by default

4.6.1 Ethernet Interface

- MAC: 00:0A:99:XX:YY:ZZ
- IP ADDR: 192.168.204.1
- NETMASK: 255.255.255.0
- Default Gateway: 0.0.0.0
- DHCP Server Enabled

4.6.2 RF Interface

- MAC: 00:XX:YY:ZZ
- IP ADDR: 10.XX.YY.ZZ
- NETMASK: 255.0.0.0
- TCP Proxy Disabled

Notes:

RF Interface IP settings are irrelevant in bridge mode.

XX:YY:ZZ refer to lower three bytes of Ethernet MAC address

4.7 IP Network Settings

For Advanced IP Settings, web interface screen captures, and descriptions, see section 4.8.

4.7.1 Factory Settings in Bridge Mode

Referring to Figure 19, set one of the ViPR unit as a Master for a basic transparent Bridge network.

In the illustration, Host and RTU are part of the same IP subnet and IP addresses of ViPR units are irrelevant in transparent Bridge mode setup.

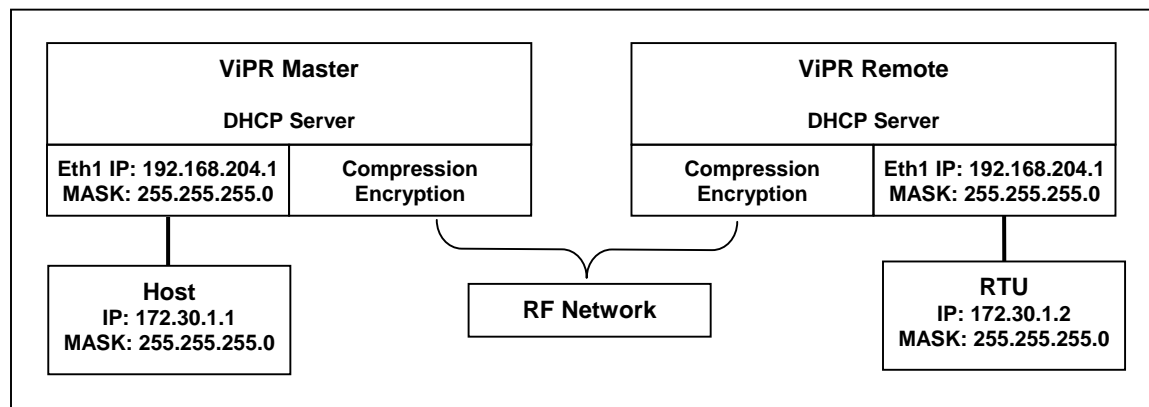

Figure 19 - Factory IP Network Settings in transparent Bridge Mode with no services

4.7.2 IP Network Settings in Bridge Mode

Referring to Figure 20, set one of the ViPR unit as a Master. Set the IP addresses and IP netmask.

In the illustration, Host, RTU, ViPR Master, and Remote are part of the same IP subnet. This setup not only acts as a transparent Bridge but also provides IP Services (web pages, Terminal Server, FTP etc...).

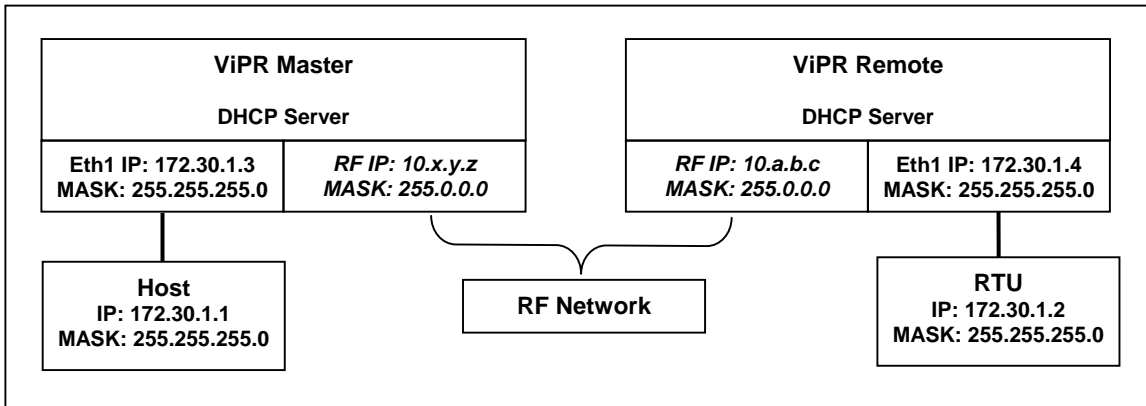

Figure 20 - IP Network Settings in transparent Bridge Mode with services

4.7.3 IP Network Settings in Router Mode (with Host)

Referring to Figure 21, set one of the ViPR unit as a Master. Set the Router mode on the Master and Remote. Set the Eth1 IP addresses and IP netmask of both Master and Remote.

Keep the RF IP setting as is if not using the 10.0.0.0 IP network on your Intranet.

Enable the Dynamic Registration on both Master and Remote.

Add routes in the Host (route add...) and add Default Gateway to RTU

In the illustration, Host and RTU are part of different IP subnet.

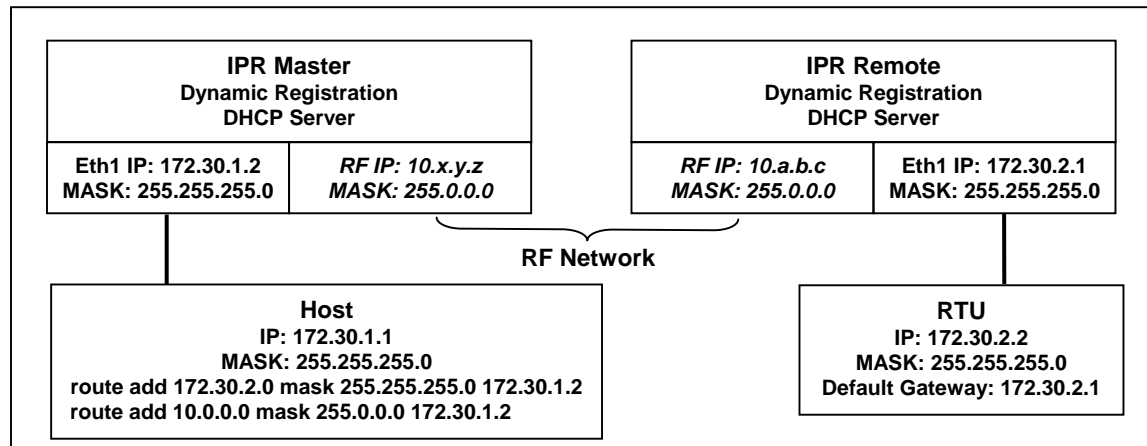

Figure 21 - IP Network Settings in Router Mode (with Host)

4.7.4 IP Network Settings in Router Mode (with Router)

Referring to Figure 22, set one of the ViPR unit as a Master. Set the Router mode on the Master and Remote. Set the Eth1 IP addresses and IP netmask of both Master and Remote.

Keep the RF IP setting as is if not using the 10.0.0.0 IP network on your Intranet.

Enable the Dynamic Registration on both Master and Remote.

Add Default Gateway to the RTU

Enable RIPv2 on Master

In the illustration, Host and RTU are part of different IP subnet.

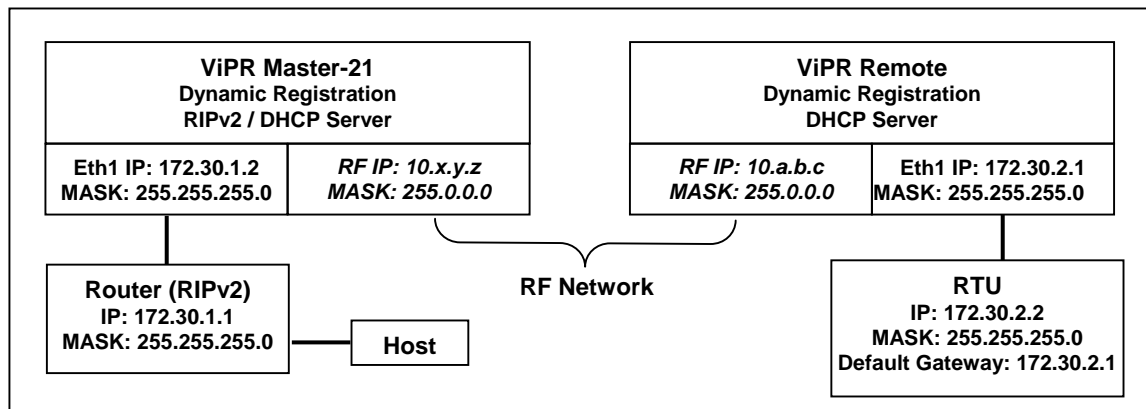

Figure 22 - IP Network Settings in Router Mode (with Router)

4.8 Advanced IP Settings

4.8.1 Unit Status

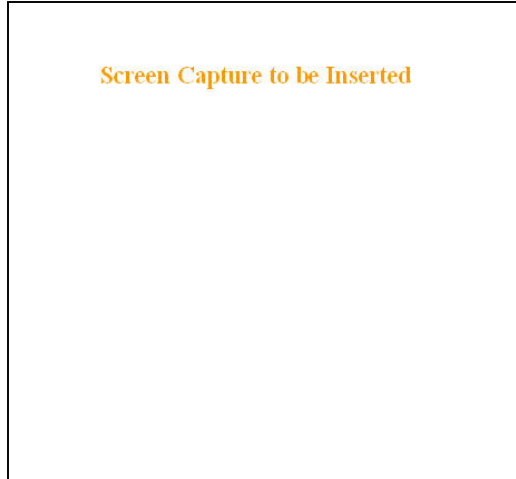

Figure 23 - Unit Status

Item	Description
Banner	Displays ViPR unit software revision information retrieved from the connected unit. Have this information handy if contacting Dataradio support.
Station Name	Displays name of connected unit. Configured under Setup Basic → General → Station Name
System ID	Displays System's unique identification number Configured under Setup Basic → General → System ID
Local Time	Displays time of configured time zone computed using UTC time and configured Time Zone
Operating mode	Displays operating mode (Remote or Master) Configured under Setup Basic → General → Operating Mode
IP Forwarding mode	Displays IP forwarding mode (Bridge or Router) Configured under Setup Basic → General → IP Forwarding Mode
Sync Status	For remote unit(s) only - Displays unit sync status in relation to Master <i>Line not present in Figure above as unit Operating Mode is Master.</i>
Temperature	Displays unit's internal temperature
Power Source	Indicates voltage input
H/W Status	<p>Summary report of hardware error checking at Power ON self-test. <i>Works in conjunction with the front panel Power LED (flashing red).</i> Displayed sentence always starts with "HW failure...". Unit will reset (as if power was cycled) 5 minutes after a self-test error is detected.</p> <p>Summary report of driver error detection. <i>Works in conjunction with the front panel Power LED (flashing green).</i> Unit will not reset.</p> <p>For both types of reports, have the displayed H/W Status message (or combination of messages) handy if contacting Dataradio support. <i>Also required if returning unit for service under RMA.</i></p>

Homologation	Factory-set. Shows the territory the unit has been configured for operation and approved by the appropriate governmental authority. Informational display: North America, New Zealand, or Australia
Clear H/W Status	Button allowing user to acknowledge and clear errors. Errors remain stored, even after cycling power, to aid in troubleshooting intermittent faults. Press the “Clear H/W Status” button to return web page displays and Power LED function to normal operation.

4.8.2 Setup (Basic)

4.8.2.1 Setup (General)

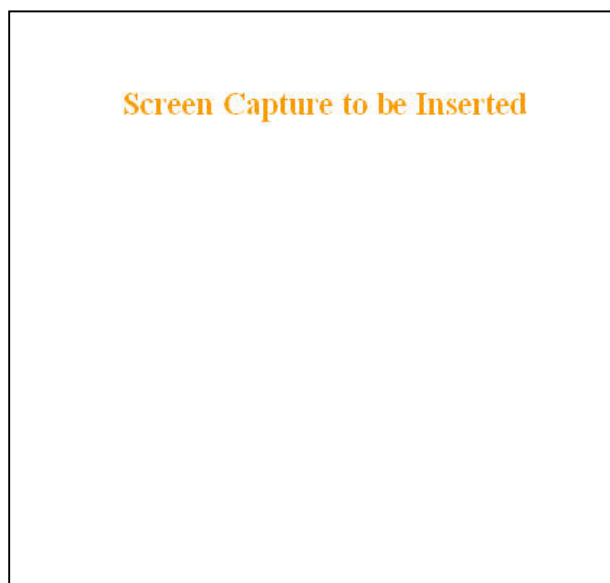

Figure 24 – Setup (Basic) General

Item	Description
Station Name	Station name identifier – Enter string up to forty characters in length
System ID	Factory default ID is zero. Dataradio recommends, for security reasons, changing it to some other value unique to each ViPR network thus preventing collision. Upper limit is 16,382
Operating mode	Remote/Master Within an ViPR network, one unit has to be configured as a master that the remotes synchronize to. It can be any unit in a system but is normally the one considered the base unit for coverage and support reasons.
IP Forwarding mode	Bridge / Router modes – Defaults to Bridge mode. Use Router for more advanced IP configurations.
Bridge Forwarding	By default, the ViPR only forwards IP and ARP packets (Ethernet II types: 0x088, 0x0806) By selecting the “Everything” setting, the ViPR will forward all 802.3 Ethernet II packets types. Use this setting to transport protocols such as IPX, 802.1Q, etc. Note that this option is not available in router mode.

4.8.2.2 Basic IP Configuration

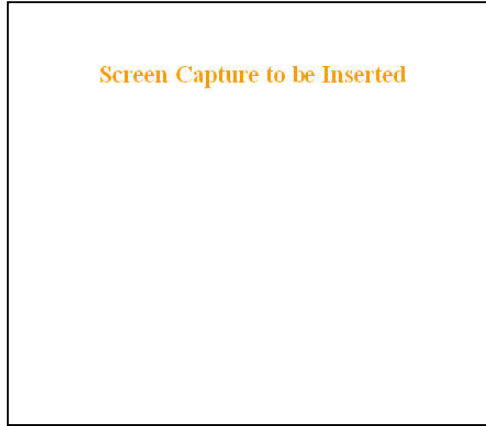

Figure 25 - Setup (Basic) – Basic IP Configuration

Item	Description
Use fixed IP settings	Enables the top three IP dialog boxes and disables the lower three. You may need to ask your network administrator for the appropriate IP settings. See section 4.7 for further details.
Use DHCP Client	To activate, select the “DHCP Client” radio button, click on the Apply button, click on the Save Config button and reboot the Host PC. On restart, the top three dialog boxes are disabled and the lower three read-only IP dialog boxes are populated with the IP settings automatically assigned (<i>if your network supports the DHCP Server capability</i>). NOTE: Activating this option will reset the unit’s IP address. If your network supports the DHCP Server capability, make sure the IP address assigned by the DHCP server will be accessible to you. If your network does not support DHCP server capability, the unit will be reset to a default (192.168.204.1) IP address within the first 2 minutes.
IP Address	In “Use fixed IP settings” window, set to valid unique IP address for each individual unit
Netmask	In “Use fixed IP settings” window, set to valid IP netmask for each individual unit (<i>may be same or different depending on customer’s IP network topology</i>).
Default Gateway	In “Use fixed IP settings” window, set to valid Default Gateway. May change for different groups or locations.

4.8.2.3 RF Setup

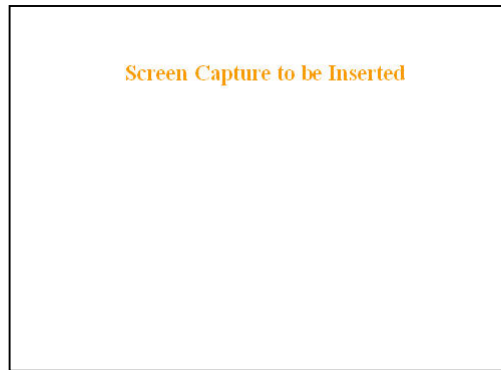

Figure 26 - Setup (Basic) – RF Setup

Item	Description
Power Level	Set power level between 30.0 dBm and 40.0 dBm (1.0 and 10 watt) Default is 40.0 dBm
Airlink speed	Sets the maximum speed the ViPR will use for data packet transmissions. <i>Slower speed preferred for longer range.</i>

4.8.2.4 Serial Ports Setup

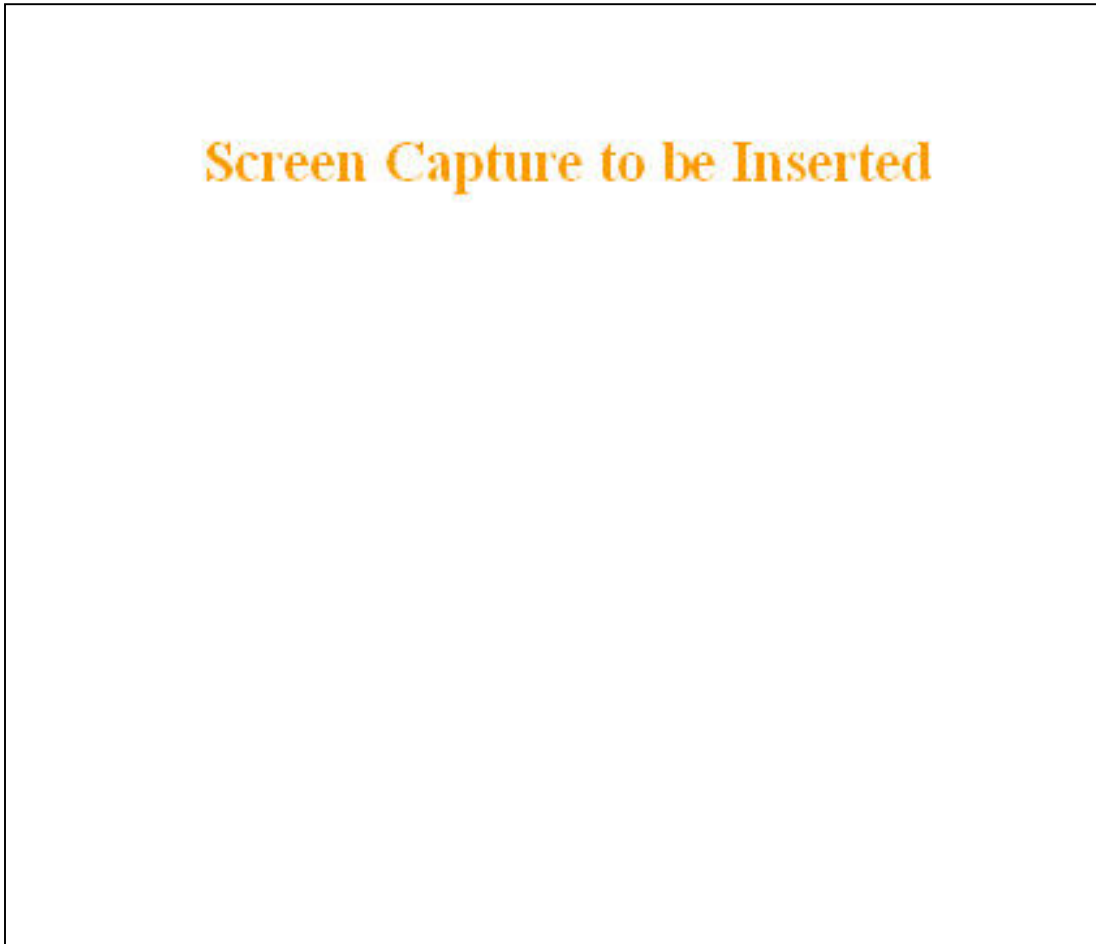

Figure 27 - Setup (Basic) – RF Setup

Item	Description
Enabled	Independent check boxes to activate SETUP PORT and/or DATA/COM PORT
Speed	Select 300, 1200, 2400, 4800, 9600, 19200, 38400, 57600, 115200 Baud Rate Default is 115200 for SETUP port and 9600 for COM port
Data Bits	Number of bits making up the data word. Set according to Host configuration. Default is 8.
Stop Bits	Mark the end of the serial port data type. Default is 1.
Parity	Added to identify the sum of bits as odd or even. Default is None.
Flow Control	Select None or CTS-based (<i>RTU dependent</i>)
Connection Control	Select Permanent (3-wire) or Switched (DTR bringup/teardown) (<i>RTU dependent</i>)
IP Gateway Service	Select one of: CLI Service (Command line interface)- RS-232 connection to Host PC <i>Access to the Command Line Interface command shell is password protected and is reserved to authorized Dataradio maintenance personnel.</i> Serial/RF bridge – IP Gateway service using UDP transport protocol (baud rate = 9600) Diagnostics – TCP/IP based RF diagnostics Custom – Choosing Custom enables the IP Gateway Transport configuration Default is CLI Service for SETUP port and Serial/RF bridge for COM port.
IP Gateway Transport	Available only if IP Gateway Service selection is Custom, choose the socket connection mode from the drop-down list box choices of TCP Server, TCP Client, or UDP.
Local IP Address	Valid unicast or multicast IP address, including the local Loopback interface address. Default local IP address is set to 0.0.0.0 and can be changed dynamically without a unit reset.
Local IP Port	For TCP Client and UDP socket connections, set to any value between 1 and 65535. For TCP Server socket connections, set to any value between 1 and 65535 but must not be set to one of the following values or fall within the following ranges of values: 20, 21, 23, 123, 520, 5002, 6254 to 6299, 7000 to 7100. Otherwise, the parameter configuration will be accepted, but no socket connection will be established to accept connection from remote endpoints. Default local port value for SETUP port is set to 1024 and can be changed dynamically without a unit reset.
Remote IP Address	Default remote IP address is the Loopback interface address, 127.0.0.1 and can be changed dynamically without a unit reset
Remote IP Port	For all socket connection modes (TCP passive, TCP active, UDP), set to any value between 1 and 65536. Default local port value for SETUP port is 23 and can be changed dynamically.

4.8.2.5 Diagnostics

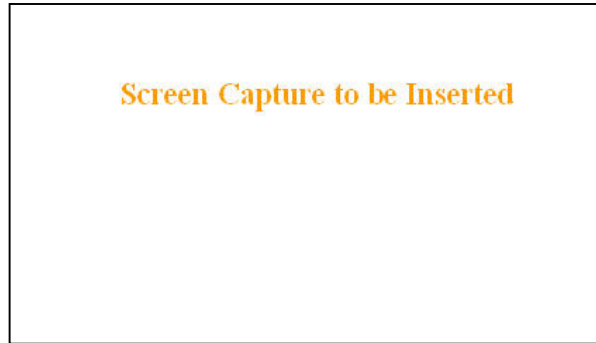

Figure 28 - Diagnostics – Thinning value

Item	Description
Thinning Value	Number of packets before a packet delivers a diagnostic message. For further Diagnostics details, see paragraph 3.2

4.8.3 Setup (Advanced)

4.8.3.1 LAN (IP)

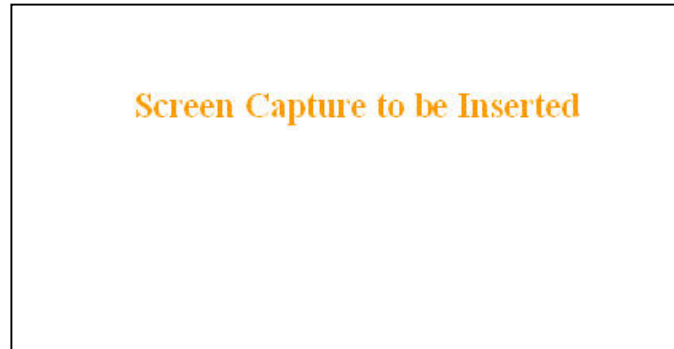

Figure 29 - Advanced IP Configuration - LAN (IP)

Item	Description
MTU	Ethernet Interface MTU - Default 1500 bytes. - Entering a value lower than 1500 may reduce system performance. Range is 576 to 1500.
MAC address	Ethernet Interface MAC address in HEX format (<i>factory-set</i>).
Default IP Gateway Control	Disabled(Default), Enabled – By design, the Sync Master unit in a typical network acts as Default IP Gateway for the remote(s). In some networks (such as store and forward), setting one of the remotes to “Enable” permits designating it as the Default IP Gateway unit.

4.8.3.2 RF (IP)

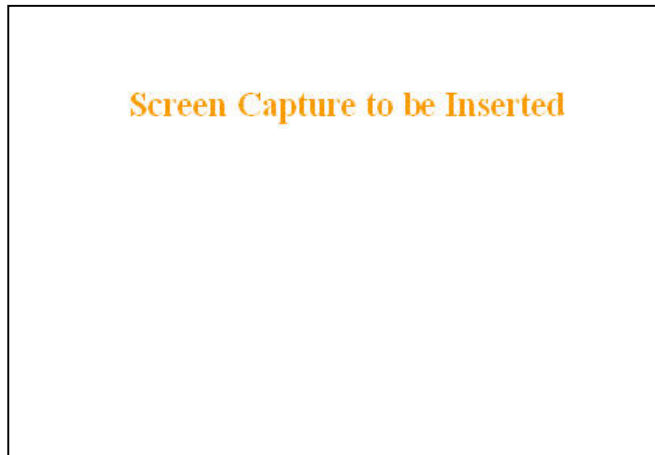

Figure 30 - Advanced IP Configuration - RF (IP)

Item	Description
RF MAC	Unit's RF MAC address
RF IP Address	Displays factory-assigned address: nnn.nnn.nnn.nnn "Factory"
	Entering 0.0.0.0 sets the RF IP Address to the factory default and highlights the "Factory" name (active address) Entering nnn.nnn.nnn.nnn (RF IP Address of your choice) overrides the factory default and highlights the "Override" name (active address)
RF Net Mask	Set to valid common IP netmask for all units within a ViPR network
RF MTU	Default 1500. Range 576 to 1500 bytes. Entering a value lower than 1500 may reduce system performance.

4.8.3.3 IP Services Setup

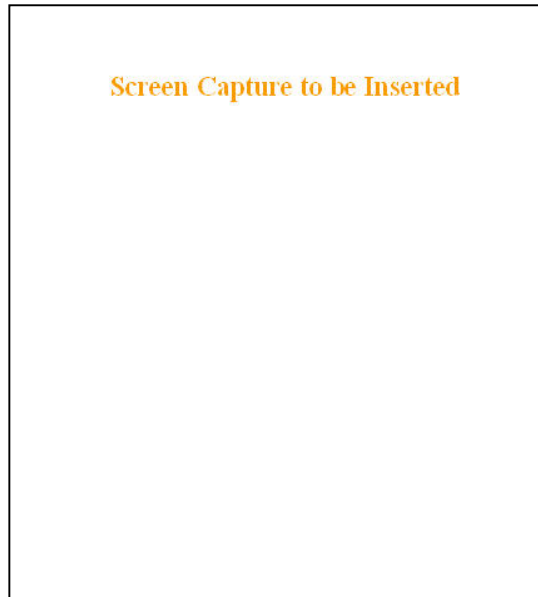

Figure 31 - Advanced IP Configuration – IP Services Setup

Server	DHCP Server Disabled, Enabled (Default). The Dynamic Host Configuration Protocol provides a framework for passing configuration information E.g.: IP address to Hosts (i.e. PC/RTU) on a TCP/IP network.
Gateway	IP addresses of the gateway assigned by the DHCP server. In router mode, the default (preset) gateway is the IP address of the unit itself. In bridge mode, the default (preset) gateway is 0.0.0.0. To override the default setting, select the “Override” radio button and enter a valid IP address in the text field.
Lease Start Address	Pool of addresses allocated for DHCP purpose. If a unit is configured as DHCP Server, this field represents the start IP address pool managed by the DHCP Server. Normally, ViPR automatically calculates the Lease Start Address (equal to Ethernet IP Address plus one)
Lease Duration	The period over which the IP Address allocated to a DHCP client is referred to as a “lease”. Lease Duration is the amount entered in minutes
Maximum number of leases	Maximum number of DHCP client(s) a unit can serve
IPSD	I/P Services Delivery – Disabled, Enabled(Default) Allows or disallows the generation of locally provided I/P Services such as online diagnostics etc...
NAT	Network Address Translation - Disabled(Default), Enabled NAT technology is a method by which IP addresses are mapped from one address space to another. In ViPR product, it is normally used on the WAN side of an IP network to hide local IP addresses from an external IP network (i.e. Internet)
RIPV2	Router Information Protocol v2 - Disabled(Default), Enabled RIPV2 is a dynamic IP routing protocol based on the distance vector algorithm and is only used in Router mode.

4.8.3.3.1 NAT Overview

The purpose of the “Network Address Translation” (NAT) protocol is to hide a private IP network from a public network. The mechanism serves both as a firewall function and to save IP address space.

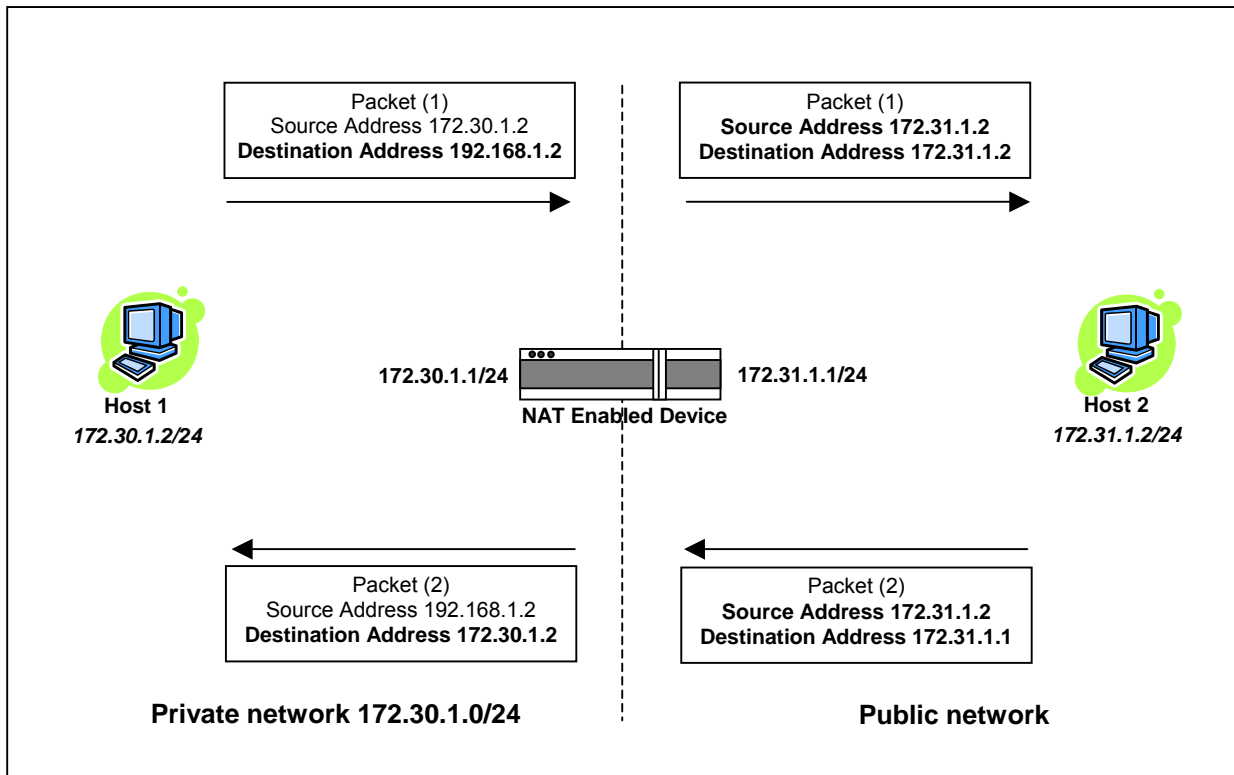

Figure 32 - Basic NAT Operations

The source address of packets transiting from the private network to the public network gets translated by the NAT enabled device. The original IP source address gets replaced by the NAT enabled device’s own IP address (address of the outgoing interface). The NAT module creates an address translation table that is used when traffic is coming back from the public network to the private network.

In our example Host 1 sends a packet to Host 2. The Host 2 device does not see the private IP address of Host 1. When Host 2 sends a reply to Host 1, he uses the destination IP address 172.31.1.1, this gets translated back to the appropriate destination IP address by the NAT enabled device.

NAT does a lot more than just translation of the IP source address. NAT does also some translation depending on the IP protocol. For the UDP and TCP protocol NAT, will also translate the source port numbers. Special handling is also done for other more specific protocol like FTP.

4.8.3.3.1.1 NAT on ViPR

When NAT is enabled on an ViPR unit, the network covered by the Ethernet interface is considered private.

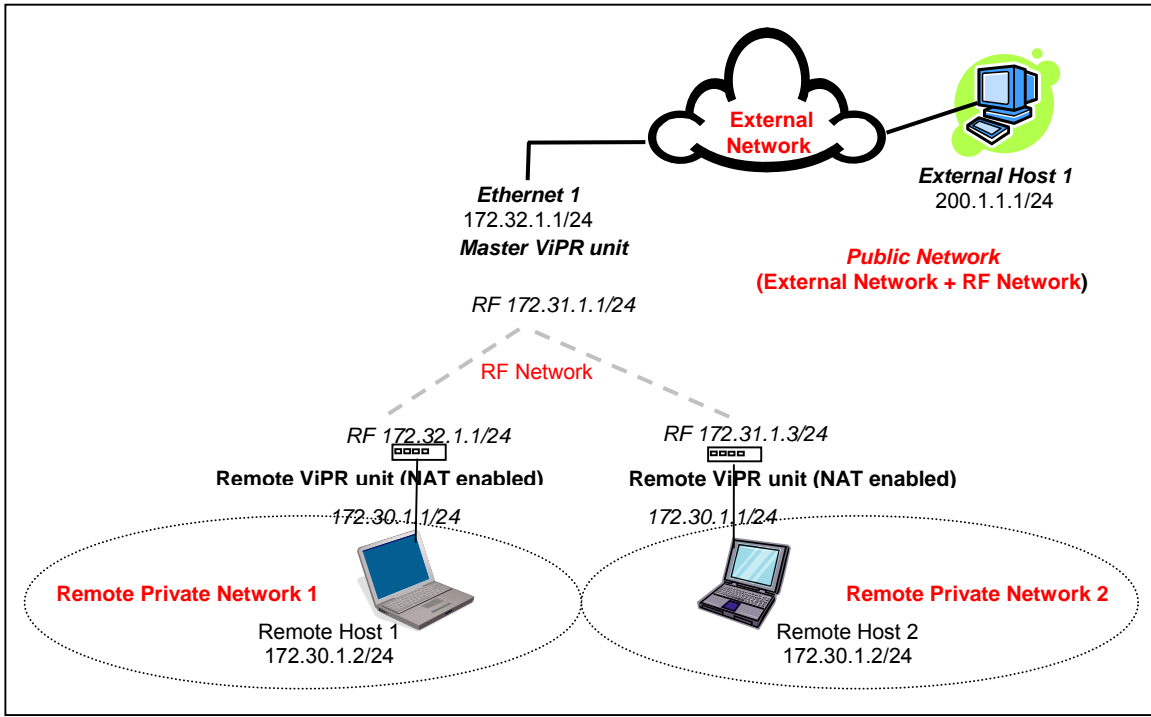

Figure 33 - NAT Enabled on ViPR

An IP packet sent from the private network towards the public network will have its source IP address replaced by the RF IP address of the ViPR unit.

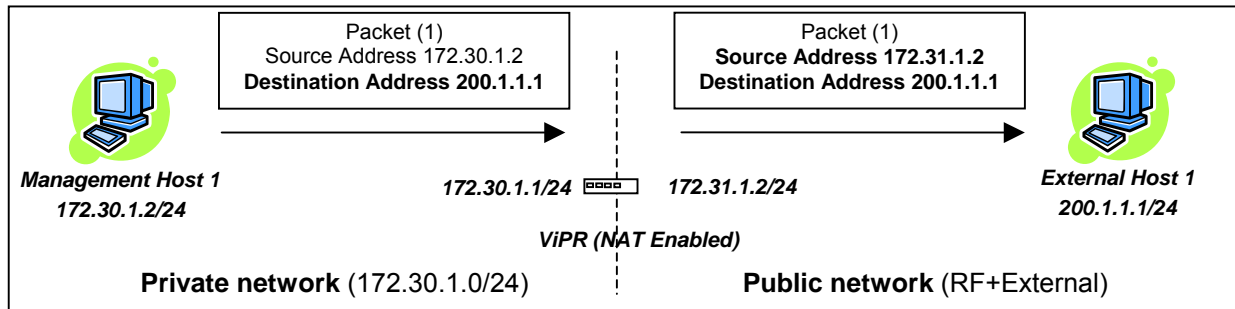

Figure 34 - Private to Public

4.8.3.4 IP addressing modes



Figure 35 - Advanced IP Configuration – IP addressing modes

Item		Description
Broadcast	Directed Broadcast	Disabled, Enabled (Default) – Controls forwarding of Directed Broadcast packets
	Limited Enable	Disabled (Default), Enabled – Controls forwarding of Limited broadcast packets
Multicast	Multicast	Disabled (Default), Enabled – Controls forwarding of Multicast packets (based on the “Multicast Address List”) Multicast can be used when “one-to-many” communication is required.
	Outbound unit address	Multicast address associated to remote unit
	Multicast Address List Add / Delete Address	To add an address to the Multicast List: Select the “Add” radio button and type in the dialog box the new address to be added to the read-only “Address List”. Note that only the valid multicast addresses will be accepted and displayed. To delete an address from the Multicast List: Select the “Delete” radio button and type in the dialog box the address to be deleted from the “Address List”.
	Address List	Read-only listing. Window expands downward as needed to show all addresses in the list. When an IP packet is received on the Ethernet side of the unit and the destination IP address matches one of the multicast IP addresses in this list, it is forwarded over the RF interface. Remote units will send it over their Ethernet interface.

4.8.3.4.1 IP Broadcast/Multicast Overview

When an IP packet needs to reach more than one unit, the destination address can be set to either a broadcast address or a multicast address.

BROADCAST - There are two types of IP broadcast address:

- **Directed broadcast**

A directed broadcast address is an IP address where the host portion is all ones (for instance 172.30.1.255 is the directed broadcast address for the network 172.30.1.0/24, 172.30.1.207 is the directed broadcast address for the network 172.30.1.192/28).

Note:

Routing equipment (to prevent broadcast storms) do not by default forward limited broadcast packets (255.255.255.255). On the other hand, directed broadcast packets are by default forwarded because these packets are routable like any other unicast packets.

- **Limited broadcast**

The limited broadcast address is 255.255.255.255.

MULTICAST - IP multicast addresses are in the range 224.0.0.0 to 239.255.255.255. These addresses are used to represent logical groups of units that may or may not reside on the same networks.

Multicast is used when “one-to-many” communication is required. For instance, a radio station might offer a music channel on the Internet in real time. To receive the music a user (host) must know the multicast group (multicast address) used by the radio station and add itself as a member of this group. In the IP realm, a host uses the IGMP protocol to do this. The routers inside the Internet are using IGMP and other multicast routing protocol to build the proper path from the sender to the receivers (a tree like path is formed from the sender to the receivers).

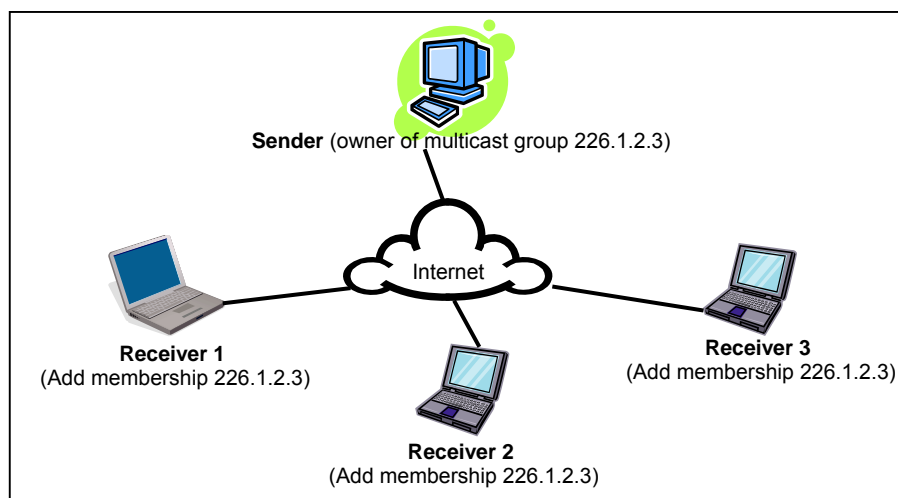

Figure 36 - Registration to multicast group (First step)

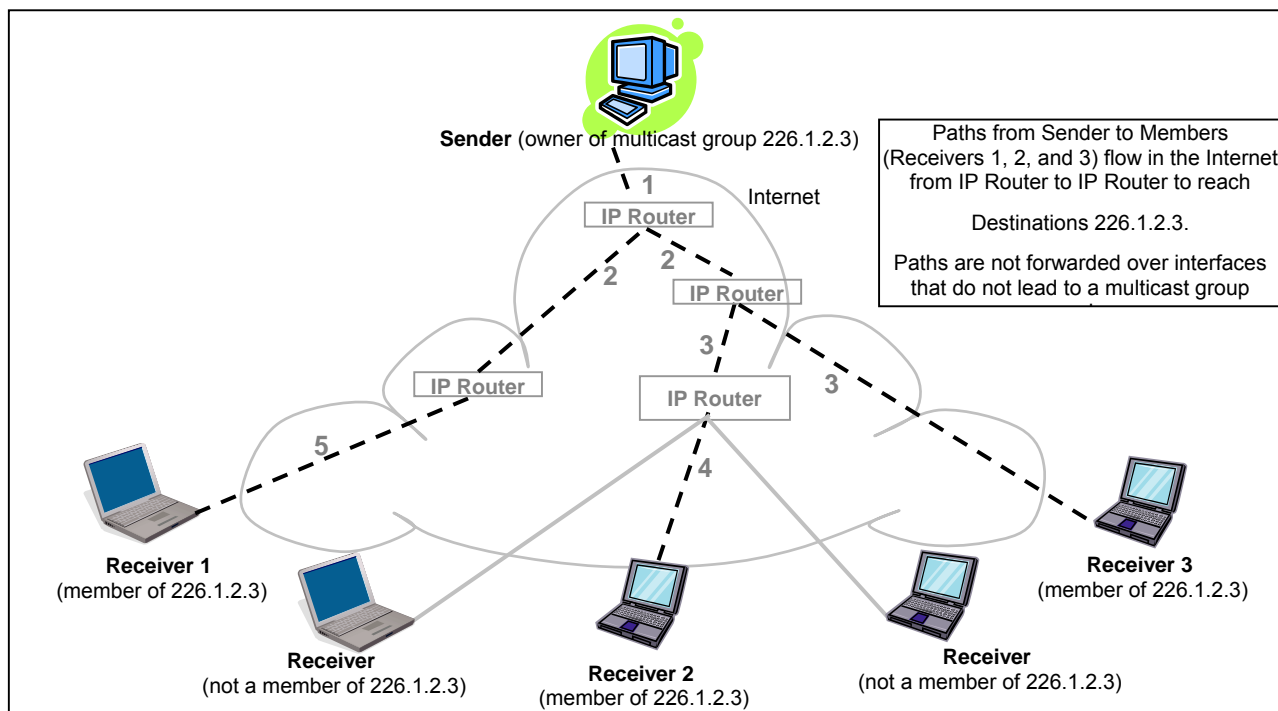

Figure 37 - Reception of multicast packets (Second step)

4.8.3.4.1.1 Broadcast



Figure 38 - Broadcast Window Detail

DIRECTED BROADCAST

Each interface of a unit has its own IP address and netmask. From the IP address and netmask, it is easy to calculate the broadcast address associated to the interface. For instance, if the Ethernet interface address of an ViPR unit is 172.30.1.1/24 and the RF interface address is 10.0.1.2/24, then the broadcast address of the Ethernet interface is 172.30.1.255 and the broadcast address of the RF interface is 10.0.1.255.

The “*Directed Broadcast*” radio buttons let the user select whether the unit must forward or not *directed broadcast* packets. Upon reception of a *directed broadcast* packet, the unit takes the following actions:

If the directed broadcast address match with one of the unit’s interface broadcast address:

- Keep a copy for itself (pass to internal applications, if any).
- If directed broadcast packets can be forwarded:
Forwards the packet according to the routing table.
- If directed broadcast packets cannot be forwarded:
Silently discards the packet.

Note:

Occasionally, the unit cannot determine that the packet is actually a **directed broadcast**. In such a case, the packet is normally routed.

LIMITED BROADCAST

The “**Limited Broadcast**” radio buttons let the user select whether the unit must forward or not *limited broadcast* packets. Upon reception of a *limited broadcast* packet, the unit takes the following actions:

- Keep a copy for itself (pass to internal applications, if any).
- If *limited broadcast* packets can be forwarded:
Sends a copy of the packet out of all the interfaces at the exception of the interface where the packet was received.
- If *limited broadcast* packets cannot be forwarded:
Silently discards the packet.

4.8.3.4.1.2 Multicast

In an ViPR environment, an outside host (Sender) might be interested in sending multicast packets to any one of the following groups:

- “All Remote ViPR” group.
- Various “Remote Host” group.

The main ViPR unit is directly connected to the outside network. ALL multicast groups MUST be identified in the main ViPR unit because it uses IGMP to register the memberships to the multicast groups on behalf of the other units and Hosts (Remote ViPR units, Remote Hosts).

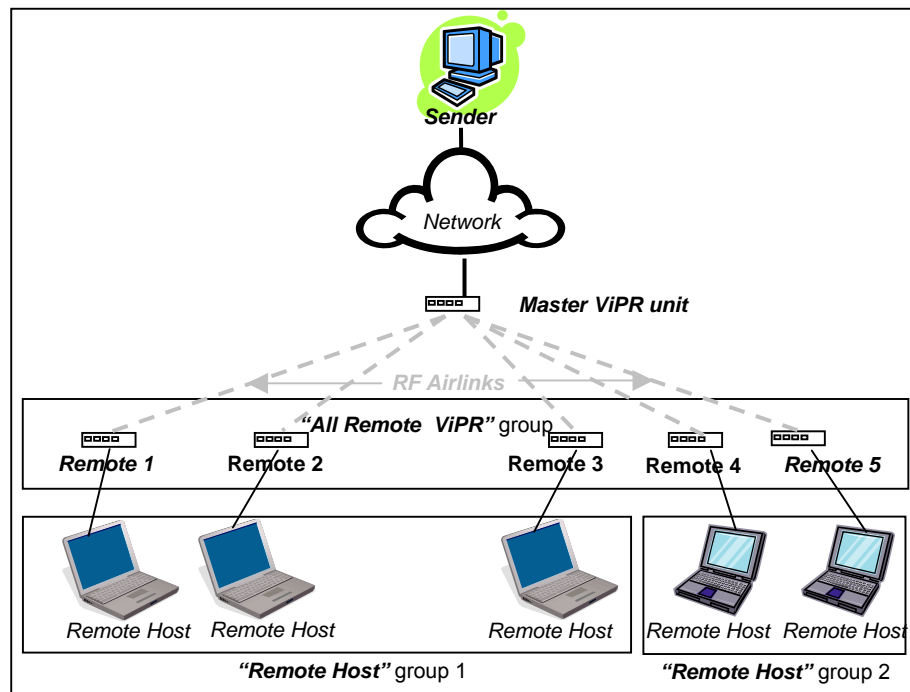

Figure 39 - Typical ViPR Multicast Groups

The following setup example would allow the “Sender” unit to communicate with different multicast groups. The settings shown in Figure 40 below, and also represented in Figure 41, would enable the Sender unit to reach all entities of the various groups. Setup is done on the Base side.



Figure 40 - Multicast Window Details (On the Main ViPR unit)

Multicast (Enabled/Disabled)	Enables or disables the registration of the multicast groups by the main ViPR unit.
Outbound unit address	Indicates the “All Remote ViPR unit” multicast group
Multicast Address List	Indicates the various “Remote Host” groups

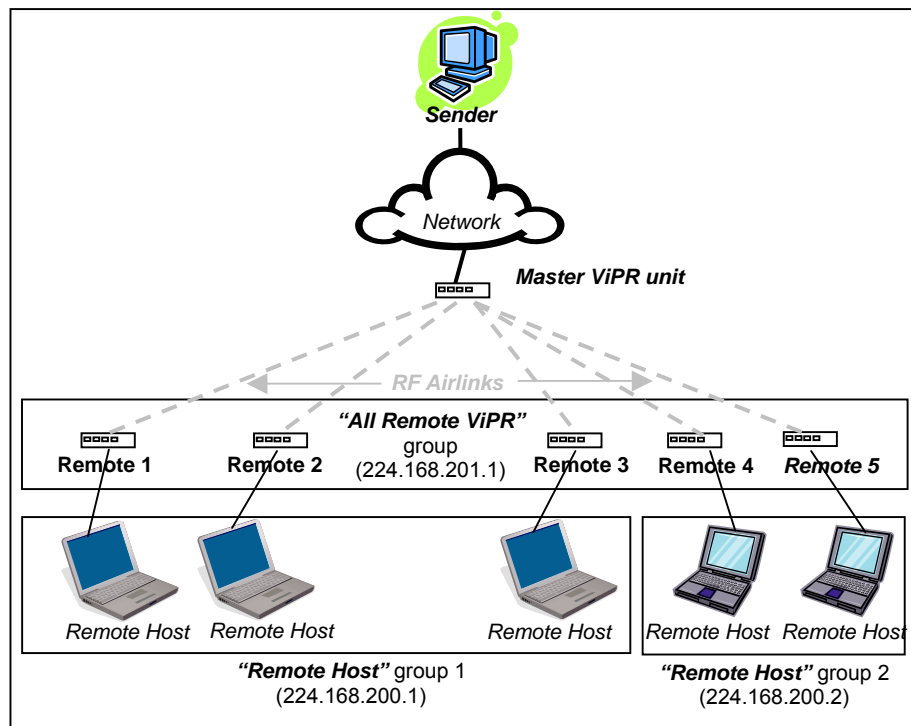

Figure 41 - Registration to multicast group

4.8.3.5 IP Optimization & Tuning

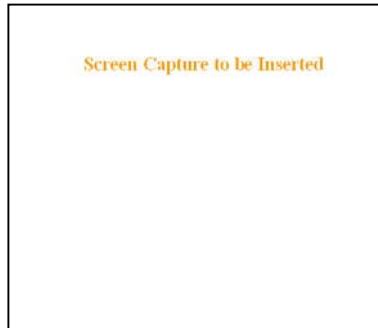

Figure 42 - Advanced IP Configuration – IP Optimization & Tuning (Router Mode)

Item	Description
RF ACK	Disabled, Enabled (Default)
OIP Retries	Number of OIP retries. Default = 1

Note: No optimizations are available in Bridge Mode. Figure 42 shows Router mode screen.

4.8.3.6 Time Source

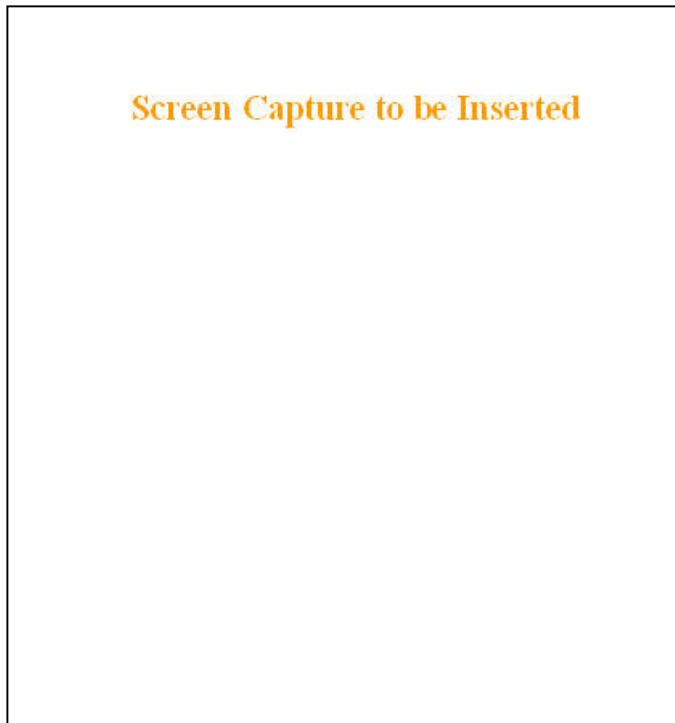

Figure 43 - Advanced IP Configuration – Time Source

	Item	Description
SNTP	Client	Disabled (Default), Enabled
	Server address	IP of the SNTP Server in dot decimal format
	Period	Period at which the SNTP Server is polled
	SNTP UTC Time	Last update received from the SNTP Server (in seconds) – Read only
	TimeZone	Select from drop-down list
	Daylight Savings	Disabled (Default), Enabled

4.8.3.7 Ethernet (PHY)

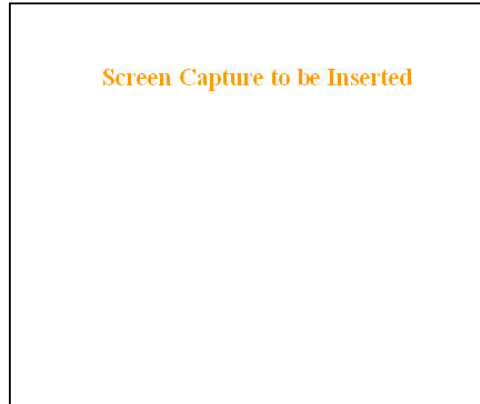

Figure 44 - Advanced IP Configuration – Ethernet (PHY)

Item	Description
PHY Bitrate	Auto Negotiate Force to 100 Mbps Force to 10 Mbps (Default)
PHY Duplex	Auto Negotiate Force to Full Duplex Force to Half Duplex (Default)

4.8.3.8 RF Link

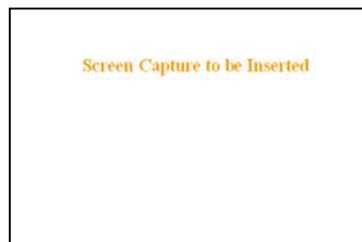

Figure 45 - Advanced IP Configuration – RF Link

Item	Description
TDD Mode	Disabled, Enabled (Default) – Normally used in a point- to- point network carrying Ethernet traffic. Maximizes RF link efficiency for carrying two-way traffic

4.8.4 Security

4.8.4.1 Pass Control

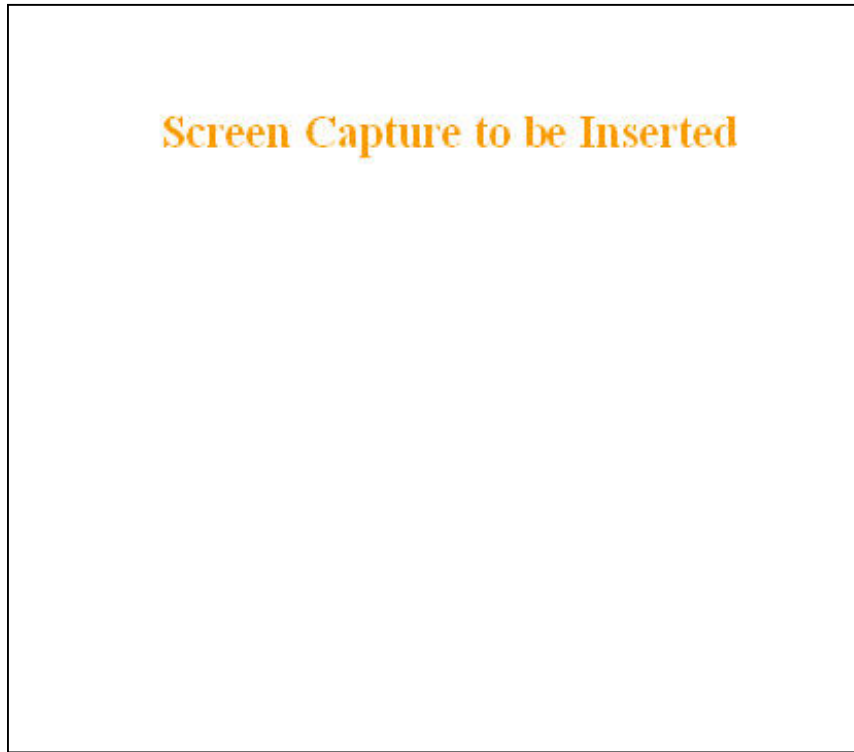

Figure 46 - Security – Pass Control

Item	Description
User ID	Enter a string of any letters or numbers of at least 1 and not exceeding 15 characters <i>The User Name entry is currently not an access-limiting factor. It only serves to identify the person gaining access. User Name may be required by future versions.</i>
Old Password	For an initial installation, enter the default Password ADMINISTRATOR (<i>all upper case letters</i>). For subsequent access, use the Password that you will have configured.
New Password	Enter a string of any letters or numbers of at least 8 and not exceeding 15 characters CAUTION: Do not lose the new password or you will not be able to gain access to the unit; you will need to contact Dataradio for support as detailed in section 1.3 earlier.
New Password (confirm)	Re-enter the new password string
Encryption	Disabled, Enabled (Default)
Encryption Pass Phrase	String of characters used to create a 128-bit AES encryption key. The Pass Phrase can be up to 160 characters long. Using a length of at least 128 characters should provide an adequate security level for most users. <i>A good pass phrase mixes alphabetic and numeric characters, and avoids simple prose and simple names.</i>
Encryption Key	All units in a network must have the same key. <i>READ ONLY - Displayed in pairs separated with spaces</i>

4.8.4.2 Access List

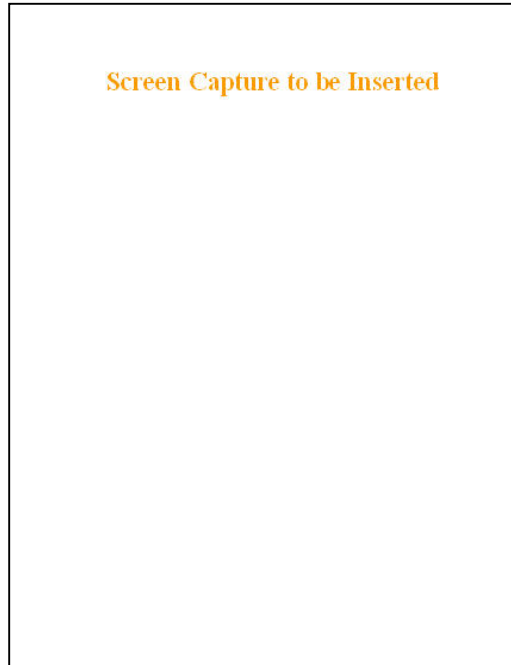

Figure 47 - Security – Access List

Item		Description
Access List Control	Access List Control	<p>Access List is used to keep unauthorized unit(s) away from Dataradio RF network. Maximum number of Access List entries = 100.</p> <p>The Access List Control takes the following values:</p> <p>Disabled (Default)</p> <p>White List – Authorized units only. Requests from any unit(s) outside this list will be rejected.</p> <p>Black List – Unauthorized units. Requests from any unit(s) that is part of this list will be rejected</p>
Access List Management	Add Entry	Adds entry in the Access Control List
	Delete Entry	Deletes entry in the Access Control List
	Import Access list from file	<p>Imports Access List from file – Populates Access Control table from the file "accesslist.acl". It is basically a text file that contains a list of RF MAC addresses.</p> <p>E.g.:</p> <p>0x1234 abcd 2345</p> <p>where, 0x1234, abcd, and 2345 represent RF MAC addresses in HEX</p> <p>To use this feature:</p> <ul style="list-style-type: none"> -Create a text file "accesslist.acl" with a list of RF MAC addresses -Upload the file from a host PC via an FTP program -Click on "Import Access list from file" button -Click on "Display Access List" button to view the imported access list
	Clear Access List	Clears entire Access Control table
	Display Access List	Clicking this button opens the access list in the message window

4.8.5 Statistics

4.8.5.1 TCP/IP

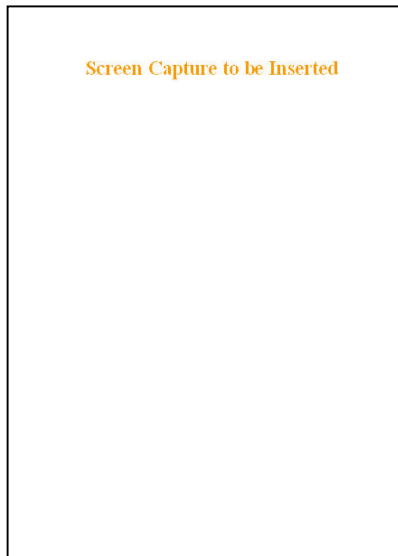

Figure 48 - Statistics – TCP/IP

Item	Description
TCP – RX Pkts	Total number of packets received by the TCP layer
TCP – TX Pkts	Total number of packets sent by the TCP layer
UDP – RX Pkts	Total number of packets received by the UDP layer
UDP – TX Pkts	Total number of packets sent by the UDP layer
ICMP – RX Pkts	Total number of packets received by the ICMP layer
ICMP – TX Pkts	Total number of packets sent by the ICMP layer
IP – RX Pkts	Total number of packets received by the IP Interface
IP – RX Pkts Forwarded	Total number of packets forwarded by the IP Interface
IP – TX Pkts	Total number of packets sent by the IP Interface

4.8.5.2 AirLink

The Airlink RF layer (*good/bad CRC*) indicates how well it receives individual packets. Missing and bad CRC counts should be minimized with respect to the good CRC count. To optimize the Airlink, refer to section 5 below.

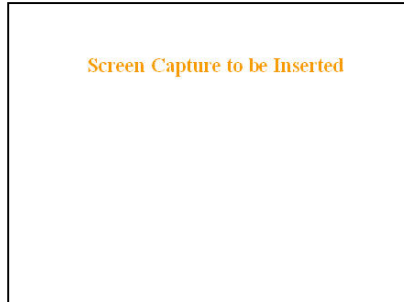

Figure 49 - Statistics – Airlink – Channel Utilization

Item		Description
Airlink statistics	Pkts Delivered	Total packets delivered over-the-air
	Pkts Received	Total packets received by over-the-air
	Pkts with Good CRC	Total packets received over-the-air with correct checksum
	Pkts with Bad CRC	Total packets received over-the-air with incorrect checksum
	Pkts with missing fragments	Total packets received over-the-air with missing fragments

4.8.5.3 Interfaces

The LAN (Ethernet) Interface layer shows reception and transmission traffic counts.

The RF(OIP) interface layer indicates the result of the RF link performance. RF errors result in RX Error counts. Transmission errors show up as retries and timeouts and appear as TX Error counts.

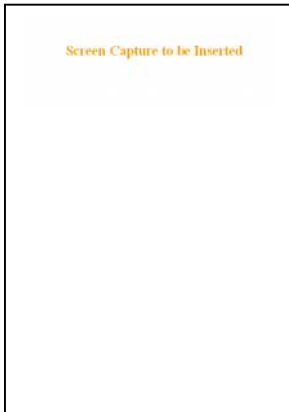

Figure 50 - Statistics – Interfaces

Item		Description
LAN(LAN)	RX Pkts	Total packets received by Ethernet interface
	TX Pkts	Total packets sent by Ethernet interface
RF(OIP)	RX Pkts	Total packets received by RF (OIP) interface
	RX Error	Total packets received by RF (OIP) interface with errors
	TX Pkts	Total packets transmitted by RF (OIP) interface
	TX Error	Total packets transmitted by RF (OIP) interface with errors

4.8.6 Maintenance

4.8.6.1 Ping Test

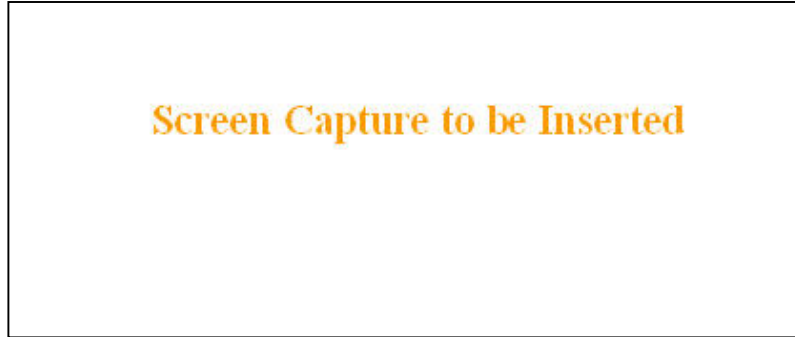

Figure 51 - Maintenance – Ping Test

Item	Description
Enter IP address	Enter IP address in dot decimal format
Execute	This button executes the ping command. Ready field displays the outcome of the ping command.

4.8.6.2 Unit Configuration Control

Important note: *Record all original ViPR radiomodem factory settings for possible future use.*

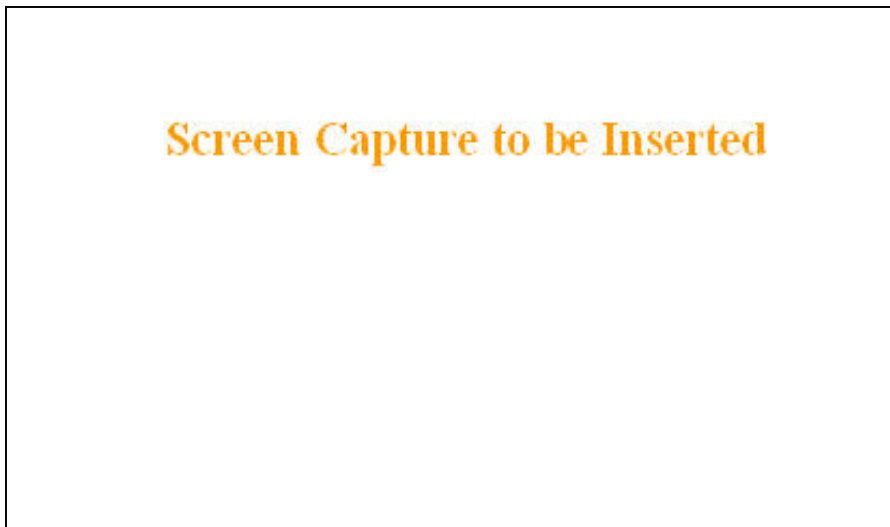

Figure 52 - Maintenance - Unit Configuration Control (Initial screen)

Item	Description
Active Configuration Description	Active Configuration Description Field – available by selecting “Checkpoint User Configuration” radio button in the “User Configuration Settings” portion of this window below.
User Configuration Settings	Checkpoint User Configuration (Save User Configuration) – saves a set of the current user configuration settings in the ViPR unit. Click on the “Checkpoint User Configuration” radio button to activate the “Active Configuration Description” field. Enter a descriptive title of up to 40 characters to help identify the configuration settings to be saved. Click on “Proceed” to save the settings to the unit. The new configuration set overwrites the factory (or previously user saved) configuration settings.
	Restore User Configuration Checkpoint (Load User Configuration) – the radio button is available if “User Configuration Settings” have been previously saved. To restore to user configuration, click the “Restore User Configuration” radio button. Check the title of the settings about to be restored in the “Active Configuration Description” field and click on “Proceed” to restore the settings to the unit.
Firmware Upgrade Settings	Merge settings bundled in upgrade package with current configuration—merges upgraded settings with the current configuration. Note: the “firmware update” process will end up replacing an existing configuration file with the one that came bundled with the firmware upgrade package.
Factory Settings	Restore Factory Settings: restores all settings do default factory configuration. Upon performing the firmware upgrade, should you decide to restore to factory settings instead of to “merge with bundled settings”, simply select the “Restore Factory Settings’ radio button right after performing the firmware upgrade and click on “Proceed”. Important note: <i>Activating “ Restore Factory Settings” will reset the IP address of the unit. Have your record of all the original ViPR factory settings handy before proceeding with restoring to factory settings.</i>

4.8.6.3 Package Control

Package Control is used for verifying the integrity of the field upgrade of the ViPR radiomodem firmware.

Click on *Maintenance/Package Control* and wait a few seconds for the results to display.

Snapshot in Figure 53 shows a “PASS” result indication. If an upgrade problem arises and persists, click the “Package Control” once more and have the resulting indications handy if contacting Dataradio System engineering.

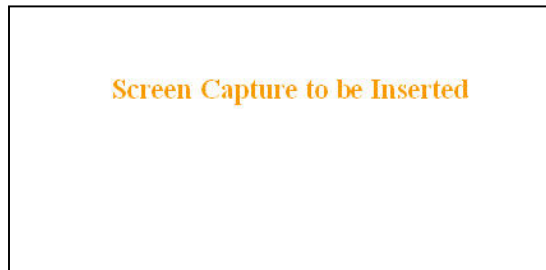

Figure 53 – Package Control

4.8.7 Radio - RF Tests

To guard against an inadvertent or accidental mishap, Dataradio strongly recommends saving the parameters to the unit BEFORE running this test. Use the “Save Config” button at the bottom of the navigation menu. This test is especially useful for testing the power output with a wattmeter.

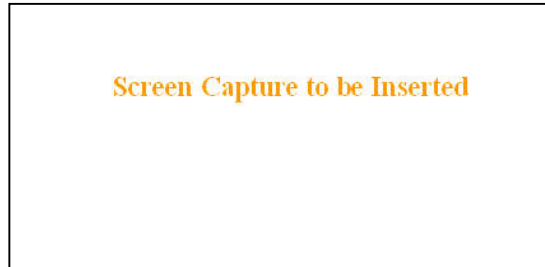

Figure 54 - RF Tests

Item	Description
Start Test	Test frequency is xxx.xxx MHz, carrier only (no modulation) RF Power will be as configured in: “Setup (Basic)” → “RF Setup” (30 to 40 dBm)
Stop Test	ViPR unit resets after 20 seconds if the Stop Test button is not pressed.

4.8.8 Help



Figure 55 - Help Icon

Item	Description
Help Icon	Click the Help Icon in the navigation pane to open a help text relating to the window being displayed.

5. Optimization & Troubleshooting

After original setup is complete, you may wish to maximize performance by first optimizing the Airlink (or *RF link*) and then optimizing the ViPR radio modem to function in the resulting environment.

5.1 Maximizing TCP/IP

If after optimizing the airlink there still appears to be an unexplained speed loss, you can look at maximizing TCP/IP.

TCP/IP throughput can be tricky to measure as performance is related not only to the RF link, but how well flow control is implemented in the TCP/IP stack and how each application is designed. The ViPR has been highly optimized with this in mind. When the TX/RX LED flashes amber, this not only indicates that data is moving but also indicates (by the LED OFF periods) when data is not moving across the RF network at full rated speed. If you get flashing RED indications on the TX/RX LED, RF reception problems are present and causing some loss of throughput. OFF periods indicate that the application has not presented data to the ViPR radio modem.

Using different client/server combinations or applications may show improvements. For instance, one FTP server may work 30% faster than another, simply because the buffer management is quicker to respond or has bigger message buffers – yet run at nearly the same speed over a pure Ethernet (no RF) link.

Network Address Translation (NAT), payload data compression and encryption have little effect other than adding a small latency to the flow of traffic.

The TDD mode should be left enabled unless highly specialized protocols are being run. Sometimes, these protocols and TDD interfere with each other and may run somewhat faster with TDD disabled.

5.2 Maximizing via Setup Pages

Further performance optimization can be done via the User Interface Setup pages. The fundamental adjustments described in the following paragraphs can be changed singularly or in conjunction with each other

Note:

Data Compression (section 4.8.3.5 above) should only be OFF while testing, thereby eliminating performance differences due only to different compression rates.

5.2.1 Use Router Mode

Selecting Router mode (see section 4.8.2.1) is highly recommended when running over a weak RF link. This mode ensures that several levels of retry mechanisms are at work, each optimized to minimize TCP flow control delays or even preventing a dropped TCP/IP link. It requires some IP route planning to and from the ViPR units but is well worth the increase in link stability over the simpler bridge mode

5.2.2 Reduce RF network bit rate

Normally the system is able to utilize the normal bit rate of **xxK** (see section 4.8.2.3). If you have a very low signal level (-90 dBm or less) or the RF signal levels are close to an elevated noise floor level, you can try running at **xxK instead of xxK** (*changeable on the fly without a reset*). It could result in better overall performance.

5.2.3 Increase OIP Retries Limit

Only available in Router mode, OIP Retries Limit is normally set to two (2). Gradually increasing it up to five (5) in extreme cases, may provide a slow but reliable link when none was possible with weak signals. *Use in conjunction with a **xxK** network bit rate.*

5.3 Troubleshooting Tools

5.3.1 Network Connectivity

- PING

The `ping` command determines whether a specific IP address is accessible. It works by sending a packet to the specified address and waiting for a reply. It is useful for troubleshooting “end-to-end” reachability, network connectivity, and network latency.

Available for MS-Windows 9x, ME, NT, 2000, and XP as well as Unix & Free BSD.

EXAMPLE:

`ping 192.168.204.1` displays the response with turn around time in milliseconds.

- TRACERT (WINDOWS)

The `tracert` command is used to visually see a network packet being sent and received and the number of hops required for that packet to get to its destination.

Available for MS-DOS 6.2, MS-Windows 9x, ME, NT, 2000, and XP.

Note:

Users with MS-Windows 2000 or XP who need additional information on network latency and network loss may also use the `pathping` command.

EXAMPLE

`tracert www.yahoo.com` at the command prompt displays the intermediate routers between local host to the `www.yahoo.com` site.

5.3.2 Configuration Information

- WINIPCFG (WIN95/98), IPCONFIG (WIN2K) or IFCONFIG (UNIX)

`Ipconfig` is a DOS utility, which can be used from MS-DOS or a MS-DOS shell to display the network settings currently assigned and given by a network. This command can be utilized to verify a network connection as well as to verify network settings.

Available for MS-DOS, MS-Windows 9x, ME, NT, 2000, and XP.

EXAMPLE

`ipconfig /all` at the command prompt displays the Ethernet MAC address, IP address, IP netmask, default IP gateway, DNS server... information.

- ARP

View and update the system ARP table

The Address Resolution Protocol (ARP) is used with the IP protocol for mapping a 32-bit Internet Protocol address to a MAC address that is recognized in the local network specified in RFC 826. Once recognized the server or networking device returns a response containing the required address.

Available for MS-Windows 9x, ME, NT, 2000, and XP.

EXAMPLE

`arp -a` displays all entries in the ARP cache. *Useful in manipulating ARP caches.*

- ROUTE

View and update the system routing table

The function and syntax of the Windows ROUTE command is similar to the UNIX or Linux route command. Use the command to manually configure the routes in the routing table.

Available for MS-Windows 9x, ME, NT, 2000, and XP.

EXAMPLE

`route ?` displays help

`route print` displays the routing table

5.3.3 Statistics Information

- NETSTAT (WINS & UNIX)

The netstat command symbolically displays the contents of various network-related data structures, i.e. IP, TCP UDP ...

Available for MS-Windows 9x, ME, NT, 2000, and XP.

EXAMPLE

`netstat ?` displays help

`netstat -a` display TCP and UDP connections and listening ports information

For further information on TCP/IP troubleshooting, please visit:

<http://www.windowsitlibrary.com/Content/466/14/1.html>

5.4 Firmware Upgrading

The ViPR radiomodem firmware is field-upgradable using the unit's Ethernet port. The process involves connecting to the IP address of the mobile from a host PC and transferring the firmware files via an FTP program.

5.4.1 Procedure

1. Using a file decompression program, such as WinZIP™ or WinXP's right-click & select the "Expand to..." option, expand the contents of the firmware upgrade package to a directory of your choice on the host PC.

Warning:

Be aware that base and mobile's firmware archives are often distributed at the same time. Files intended for the ViPR radiomodem are labeled in the form **VIPR_Vx.x_Rx.xx.zip**. Be careful not to transfer firmware into the wrong unit!

2. Using an FTP program of your choice, establish a connection to the mobile IP address. Please refer to paragraph 4.8.4.1 for "Username" and "Password" usage.
3. Transfer all the files in the upgrade package. Occasionally, long pauses, on the order of 30 to 45 seconds, are possible when storing the file in the unit's flash file system.
4. Once the file transfer is complete, cycle the mobile power and allow the unit to boot. The unit should return to the state that it was in when the update was started.

Note:

After resetting, the PWR LED remaining lit steady amber or red indicates the FTP transfer was not successful or that the firmware is corrupt. Please contact Dataradio system engineering for assistance.

5. Verify the integrity of the newly transferred files.
 - a) Connect to the mobile's IP address using an Internet browser such as IE (5.0 or later) or Mozilla.
 - b) Enter the user name and password (*in the usual manner*) and allow the **Welcome** page to load.
 - c) In the left pane, click on **Unit Status**. The **Unit Identification and Status** pane should display the newly upgraded firmware in its **Banner** (*should correspond to the upgrade package version*) and the **H/W Status** should also show **Ok**.
 - d) In the left pane, click on **Maintenance**, then on **Package Control**. Wait a few moments for the results to display. Figure 53 shows a "Pass" result indication.

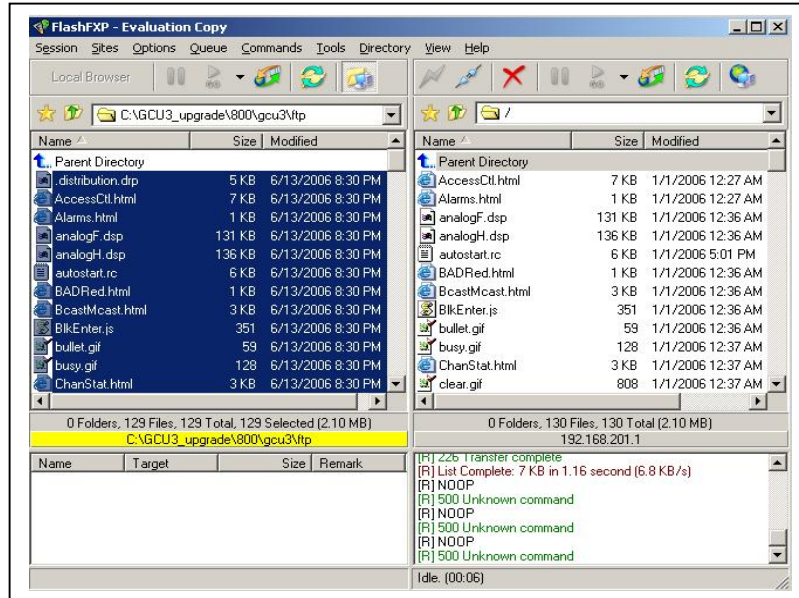

Figure 56 - Sample FTP program

5.4.1.1 File Integrity Failure

If the message in the result screen points out that file(s) failed the integrity check, retry the FTP transfer for the failed file(s) again.

If the problem persists, please have the **Package Control** result screen indications handy and contact Dataradio system engineering for assistance

6. Specifications

These specifications are subject to change without notice.

GENERAL

	UHF			
Frequency Range (MHz)	406.1 - 470 MHz 450 - 512 MHz			
Frequency Stability	0.5 ppm			
Modes of Operation	Simplex, Half-Duplex, Full Duplex			
Channel Bandwidth	6.25 kHz 12.5 kHz 25 kHz			
Frequency Increment	1.25 kHz			
Power Source	10-30 VDC, Negative GND			
RF Impedance	50 Ω			
Operating Temperature	-30° to + 60° C			
Storage Temperature	-40° to + 85° C, 95% non-condensing RH			
Operating Humidity	5% to 95% non-condensing RH			
Typical Rx Current Drain at 25°C		DC Input 10V	DC Input 20V	DC Input 30V
		480 mA	250 mA	180 mA
Typical Tx Current Drain at 25°C	Power Out	DC Input 10V	DC Input 20V	DC Input 30V
	40 dBm (10W)	4.6 A	2.04 A	1.37 A
	30 dBm (1W)	1.23 A	630 mA	440 mA
Cold start	10 seconds (typical)			
Nominal Dimensions	5.50" W x 2.125" H x 4.25" D (13.97 x 5.40 x 10.8 cm)			
Shipping Weight	2.4 lbs. (1.1 Kg)			
Mounting Options	19" Rack mount configuration, DIN-rail option, Mounting plate/pattern			

TRANSMITTER	
Tx Frequencies	406.1-470 MHz, 450-512 MHz
Carrier Output Power	1-12W Adjustable
Duty Cycle	100%
Radiated Spurious Emissions	Per FCC/Regulatory
Conducted Spurious Emissions	-65 dBc
Transmitter Stability into VSWR:	> 10:1 (Power Foldback Allowed)
RX to TX Time	< 2ms
Channel Switching Time	< 15 ms (Band-End to Band-End)

RECEIVER			
RX Frequencies	406.1-470 MHz, 450-512 MHz		
	25 kHz Channel	12.5 KHz Channel	6.25 kHz Channel
Data Sensitivity @ 10 ⁻⁶ Bit Error Rate (BER)	-112 dBm @ 16kb/s (typical) -105 dBm @ 32kb/s (typical)	-112 dBm @ 8kb/s (typical) -105 dBm @ 16kb/s (typical)	-112 dBm @ 4kb/s (typical) -96 dBm @ 8kb/s (typical)
Adjacent Channel Rejection	> 70 dB	> 60 dB	> 55 dB
Spurious Response Rejection	> 70 dB		
Intermodulation Rejection	> 70 dB		

TX to RX Time	< 1ms
Channel Switching Time	< 15ms (Band-End to Band-End)
Carrier to Data Time	None (140 µs)

Modem / Logic			
	25 kHz Channel	12.5 KHz Channel	6.25 kHz Channel
Data Rate (User Selectable)	16 kb/s 32 kb/s	8 kb/s 16 kb/s	4 kb/s 8 kb/s
Modulation Type	2FSK, 4FSK		
Addressing	IP		

SETUP and COM Port	
Interface	EIA RS-232F DE9F
Data Rate	300 – 115,200 b/s (Defaults: Setup = 115.2Kbps, COM = 9.6 Kbps)

Display	
5 Bi-color status LEDs	Power, Status, LAN Link/Activity, Collision, Rx/Tx

Connectors		
Antenna Connector	Half Duplex/Simplex: TNC female (Tx/Rx) Full Duplex: TNC female (Tx) & SMA female (Rx)	
Serial Setup Port	DE-9F	
Serial Terminal Server	DE-9F	
Ethernet RJ-45	10/100 BaseT auto-MDIX	
Power -I/O	Power Header	Power Plug
	DRL p/n 415-7108-113 (Weidmüller p/n 1615550000) 4 Pin, 3.5mm, Power Header	DRL p/n 415-7140-113 (Weidmüller p/n 1639260000) 4 Pin, 3.5mm, Power Plug

Diagnostics	
Message elements	IP or MAC Address, Thinning value, Flag/Voltage source, Voltage, Temperature, Packet Error Rate, Carrier Level, Average Background Level, Forward power, Reverse power

FCC / IC / UL Certifications			
	FCC	IC (DOC)	UL
406.1 - 512 MHz	NP4-5048300	773B-5048300	Pending



Dataradio COR Ltd. ("DRL") warrants to the original purchaser for use ("Buyer") that data telemetry products manufactured by DRL ("Products") are free from defects in material and workmanship and will conform to DRL's published technical specifications for a period of, except as noted below, two (2) years from the date of shipment to Buyer. DRL makes no warranty with respect to any equipment not manufactured by DRL, and any such equipment shall carry the original equipment manufacturer's warranty only. DRL further makes no warranty as to and specifically disclaims liability for, availability, range, coverage, grade of service or operation of the repeater system provided by the carrier or repeater operator. Any return shipping charges for third party equipment to their respective repair facilities are chargeable and will be passed on to the Buyer.

If any Product fails to meet the warranty set forth above during the applicable warranty period and is returned to a location designated by DRL. DRL, at its option, shall either repair or replace such defective Product, directly or through an authorized service agent, within thirty (30) days of receipt of same. No Products may be returned without prior authorization from DRL. Any repaired or replaced Products shall be warranted for the remainder of the original warranty period. Buyer shall pay all shipping charges, handling charges, fees and duties for returning defective Products to DRL or DRL's authorized service agent. DRL will pay the return shipping charges if the Product is repaired or replaced under warranty, exclusive of fees and duties. Repair or replacement of defective Products as set forth in this paragraph fulfills any and all warranty obligations on the part of DRL.

This warranty is void and DRL shall not be obligated to replace or repair any Products if (i) the Product has been used in other than its normal and customary manner; (ii) the Product has been subject to misuse, accident, neglect or damage or has been used other than with DRL approved accessories and equipment; (iii) unauthorized alteration or repairs have been made or unapproved parts have been used in or with the Product; or (iv) Buyer failed to notify DRL or DRL's authorized service agent of the defect during the applicable warranty period. DRL is the final arbiter of such claims.

THE AFORESAID WARRANTIES ARE IN LIEU OF ALL OTHER WARRANTIES, EXPRESSED AND IMPLIED, INCLUDING BUT NOT LIMITED TO, ANY IMPLIED WARRANTY OF MERCHANTABILITY OR FITNESS FOR A PARTICULAR PURPOSE. DRL AND BUYER AGREE THAT BUYER'S EXCLUSIVE REMEDY FOR ANY BREACH OF ANY OF SAID WARRANTIES IS AS SET FORTH ABOVE. BUYER AGREES THAT IN NO EVENT SHALL DRL BE LIABLE FOR INCIDENTAL, CONSEQUENTIAL, SPECIAL, INDIRECT OR EXEMPLARY DAMAGES WHETHER ON THE BASIS OF NEGLIGENCE, STRICT LIABILITY OR OTHERWISE. The purpose of the exclusive remedies set forth above shall be to provide Buyer with repair or replacement of non-complying Products in the manner provided above. These exclusive remedies shall not be deemed to have failed of their essential purpose so long as DRL is willing and able to repair or replace non-complying Products in the manner set forth above.

This warranty applies to all Products sold worldwide.

Some states do not allow limitations on implied warranties so the above limitations may not be applicable. You may also have other rights which vary from state to state.

EXCEPTIONS

- ONE YEAR: Labor to replace defective parts in repeaters or base stations
- THIRTYDAY: Tuning and adjustment of telemetry radios
- NOWARRANTY: Fuses, lamps and other expendable parts

Effective 01/2004

Dataradio COR Ltd. 299 Johnson Avenue, Suite 110, Waseca, MN 56093-0833; Tel: (507) 833-8819 or (800) 992-7774; Fax: (507) 833-6748 Visit us on the web at www.dataradio.com



The entire contents of this manual are Copyright 2006 by DATARADIO Inc.®
Dataradio, ViPR and PARALLEL DECODE are registered trademarks. TRUSTED WIRELESS DATA is a trademark of Dataradio Inc.