

PTP 400 Series User Guide



MOTOROLA POINT-TO-POINT WIRELESS SOLUTIONS





MOTOROLA, Inc.

Point-to-Point Wireless Bridges – PTP 400 Series

Software Release 400-09-00

System User Manual

November 24th, 2006

Ref: PHN-0872-02.07

Copyright Information

This document is the confidential property of Motorola, Inc. and without its prior written consent may not be copied or released to third parties.

MOTOROLA, the stylized M Logo and all other trademarks indicated as such herein are trademarks of Motorola, Inc.® Reg. U.S. Pat & Tm. Office. PTP 400 is a trademark of Motorola, Inc. All other product or service names are the property of their respective owners.

© 2006 Motorola, Inc. All rights reserved.

<http://www.motorola.com>

Compliance

General

Changes or modifications not expressly approved by Motorola could void the user's authority to operate the system.

NOTE: This system has achieved Type Approval in various countries around the world. This means that the system has been tested against various local technical regulations and found to comply. The frequency band in which the system operates is 'unlicensed' (except from the 4.9 Ghz product) and the system can be used provided it does not cause interference. Further, it is not guaranteed protection against interference from other products and installations.



The system has basically been shown to comply with the limits for emitted spurious radiation for a Class B digital device¹, pursuant to Part 15 of the FCC Rules in the USA as well as comparable regulations in other countries. This equipment generates uses and can radiate radio frequency energy and, if not installed and used in accordance with the instructions, may cause harmful interference to radio communications. However, there is no guarantee that interference will not occur in a particular installation.

If this equipment does cause harmful interference to other equipment, which can be determined by turning the equipment off and on, the user is encouraged to try to correct the interference by one or more of the following measures:

- Reorient or relocate the Outdoor Unit (ODU).
- Increase the separation between the equipment and ODU.
- Connect the equipment into a power outlet on a circuit different from that to which the receiver is connected.

Consult your installer or supplier for help.

Deployment and Operation

The Radio Regulations of various countries' limits constrain the operation of radio products generally. In particular the local regulator may limit the amount of conducted or radiated transmitter power and may require registration of the radio link.

The power transmitted by the PTP 400 Series is controlled by the use of Region-specific License Keys.

The following examples show how the regulatory limits apply in some specific countries at the current time. Operators should note that regulations are subject to change.

Contact your supplier/installer to ensure that your product is set for the correct License Key for your Country/Region and to ensure that you have fulfilled all the local regulatory requirements, especially if you are intending to use a link with external antennas. Footnotes to the table below indicate countries where registration of the link is currently mandatory.

¹ Class B Digital Device, A digital device that is marketed for use in a residential environment notwithstanding use in commercial, business and industrial environments.



Regulations applicable to 4.9 GHz PTP 400 Series Bridge variant (49400)

Examples of Regulatory Limits at 4.9GHz

Power/Radiated Power/Region Setting

Non-FCC and Non-ETSI	Operation not currently allowed
FCC	FCC Part 90
Canada	RSS-211
ETSI	Operation not currently allowed

Note that this product is specifically intended for professional installation. The integrated antenna version may be installed as shipped from Motorola. The Connectorized version must have the Maximum Transmit Power setting reduced if it is installed with antennas having a directional gain of >26dBi (net of cable losses). The reduction is 1dB for every 1dB that the antenna gain (net of cable losses) exceeds 26dBi. See Section 8.3.1 "System Configuration Page" and Section 8.3.5.3 "Wireless Configuration" for details on adjusting the Maximum Transmit Power.



Regulations applicable to 5.4 GHz PTP 400 Series Bridge variant (54400)

Examples of Regulatory Limits at 5.4GHz

Power/Radiated Power/Region Setting

Non-FCC and Non-ETSI ²	Equipment can be operated in any mode, best results will be obtained using Region 8 settings (Region 7 if DFS is required)
FCC	Under FCC Regulations, operation of this product is only allowed with a License Key for Region 9 (27dBm EIRP with Radar Detection)
Canada	Under IC Regulations, operation of this product is only allowed with a License Key for Region 10 (27dBm EIRP with Radar Detection and barring off the band 5600-5650MHz)
ETSI	Under ETSI Regulations, operation of this product is only allowed with a License Key for Region 9 (27dBm EIRP with Radar Detection)

General Notice Applicable to Europe

This equipment complies with the essential requirements for the EU R&TTE Directive 1999/5/EC.



² Note: In regions other than EU/USA, specific local regulations may apply. It is the responsibility of the installer/user to check that the equipment as deployed meets local regulatory requirements.



Regulations applicable to 5.8 GHz PTP 400 Series Bridge variant (58400)

Examples of Regulatory Limits at 5.8GHz

Power/Radiated Power/Region Setting

USA/ Canada/ Taiwan/ Brazil	Equipment can be operated in any mode, best results will be obtained using Region 1 settings
UK ³	Under UK Regulations, operation of this product is only allowed with a License Key for Region 4 (1W EIRP with Radar Detection)
Eire ⁴	Under Eire Regulations, operation of this product is only allowed with a License Key for Region 6 (1W EIRP)
Norway	Norwegian rules allow a 200W EIRP but also require Radar Detection (DFS) and barring of part of the band. The license key for Region 7 is required, although Region 4 could also be used for lower power requirements.
Australia	Australian laws prohibit use/operation of this product except where it is used with a License Key for Region 3 (4W EIRP)
Singapore	Under Singapore Regulations, operation of this product is only allowed with a License Key for Region 5 (100mW EIRP)
Hong Kong	Under Hong Kong Regulations, operation of this product is only allowed with a License Key for Region 3 (4W EIRP)
Korea	Under Korean regulations operation of this product is only allowed with a license key for region 11. (+20 dBm and frequency band limited to 5725 to 5825MHz).

³ UK Registration of Links – OfCom

The application form may be found at

<http://www.ofcom.org.uk/radiocomms/>

⁴ Eire Registration of Links – Commission for Communication Regulation (ComReg)

The application form may be found at

http://www.comreg.ie/5_8GHzRegPart1.asp?S=4&NavID=198&M



General Notice Applicable to Europe

This equipment complies with the essential requirements for the EU R&TTE Directive 1999/5/EC.

The use of 5.8GHz for Point-to-Point radio links is not harmonized across the EU and currently the product may only be deployed in the UK and Eire (IRL);

However, the regulatory situation in Europe is changing and the radio spectrum may become available in other countries in the near future. Please contact Motorola or the latest situation.

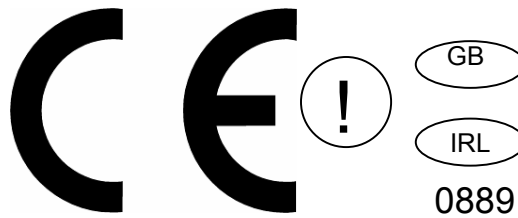

Disclaimer

The parameters quoted in this document must be specifically confirmed in writing before they become applicable to any particular order or contract. The company reserves the right to make alterations or amendments to the detail specification at its discretion. The publication of information in this document does not imply freedom from patent or other rights of Motorola, Inc. or others.



Contents

1	About This User Guide	17
1.1	Interpreting Typeface and Other Conventions	17
1.2	Getting Additional Help	19
1.3	Sending Feedback	19
2	Avoiding Hazards	20
2.1	Preventing Overexposure to RF Energy	20
2.1.1	Calculations for Separation Distances and Power Compliance Margins	20
2.1.1.1	Calculated Distances and Power Compliance Margins	21
3	Getting Started	22
3.1	For Your Safety	22
3.2	Welcome	23
3.2.1	About This Guide.....	23
3.2.2	Who Should Use This Guide.....	23
3.2.3	Contact Information.....	24
3.2.4	Repair and Service.....	24
3.3	Product Description	25
3.3.1	The Outdoor Unit (ODU)	27
3.3.2	The PIDU Plus – PTP 400 Series	28
3.3.3	Redundancy and Alternate Powering Configurations	30
3.3.3.1	External DC Supply Only	30
3.3.3.2	External DC Supply and AC Supply.....	31
3.3.3.3	External DC Supply and Redundant AC Supply	31
3.3.4	Remote LEDs and Recovery Switch.....	32
3.3.5	Cables and Connectors.....	32
3.3.6	Surge Arrestor	33
3.3.7	Mounting Brackets.....	33
3.3.8	Configuration and Management.....	34
3.4	Warranty	34
4	Product Architecture	35
5	General Considerations	37
5.1	Spectrum Planning	37
5.2	Region Codes.....	38
5.3	Operational Restrictions	39
5.3.1	Radar Avoidance.....	39

5.3.2	RTTT Avoidance and Other Channel Use Restrictions	40
5.4	4.9 GHz Specific Frequency Planning Considerations	40
5.4.1	Raster Considerations.....	40
5.4.2	Fixed Frequency Operation.....	40
5.4.3	Transmit Power Reduction at the Band Edges	41
5.5	5.4 GHz Specific Frequency Planning Considerations	41
5.5.1	Raster Considerations.....	41
5.5.2	Fixed Frequency Operation.....	41
5.5.3	Transmit Power Reduction at the Band Edges	41
5.6	5.8GHz Specific Frequency Planning Considerations	42
5.6.1	Raster Considerations.....	42
5.6.2	Fixed Frequency Operation.....	42
5.6.3	Transmit Power Reduction at the Band Edges	42
5.7	Distance	43
5.8	Networking Information	43
5.9	Lightning Protection.....	43
5.10	Electrical Requirements	44
6	Site Planning.....	45
6.1	Site Selection Criteria.....	45
6.1.1	ODU Site Selection	45
6.1.2	PTP 400 Series Bridge PIDU Plus Site Selection.....	45
6.1.3	Path Loss Considerations	46
6.1.4	Aggregate Ethernet throughput rate versus maximum link loss	46
7	Installation	49
7.1	Preparation.....	49
7.2	Installation Procedure	49
7.3	Tools Required	49
7.4	Installation Support.....	50
7.5	Legal Disclaimer.....	50
7.6	Mounting the ODUs.....	50
7.7	Connecting Up.....	52
7.7.1	Preparing The Cable — RJ45 connections.....	52
7.7.2	Making the Connection at the ODU	54
7.7.3	Routing the Cable.....	55
7.7.4	Fitting A Surge Arrestor.....	55
7.7.5	Grounding the Installation	56



7.7.6	Making the ODU Connection at the PTP 400 Series Bridge PIDU Plus	56
7.7.7	Making the Network Connection at the PIDU Plus – PTP 400 Series	57
7.7.8	Mounting the PTP 400 Series Bridge PIDU Plus	58
7.7.9	Powering Up.....	60
7.7.10	Aligning the PTP 400 Series ODUs	61
8	Web Page Reference.....	64
8.1	Home Page – PTP 400 Series Bridge.....	65
8.1.1	Home Page Alarm Display	66
8.2	System Status Page.....	68
8.3	System Administration Pages	74
8.3.1	System Configuration Page	75
8.3.2	LAN Configuration Page	78
8.3.3	Save and Restore Menu	82
8.3.4	Statistics Page.....	87
8.3.4.1	Detailed Counters Page	90
8.3.5	Install Wizard Pages.....	93
8.3.5.1	Manually Configuring the Wireless Units	94
8.3.5.2	Internet Protocol Configuration	94
8.3.5.3	Wireless Configuration	97
8.3.5.4	Confirm Configuration	102
8.3.5.5	Disarm	105
8.3.6	Graphical Install.....	107
8.3.7	Software Upgrade	108
8.3.8	Spectrum Management.....	112
8.3.8.1	Wireless Channels	112
8.3.8.2	Spectrum Management Measurements.....	112
8.3.8.3	Measurement Analysis	112
8.3.8.4	The Spectrum Management Master / Slave Relationship.....	114
8.3.8.5	Spectrum Management Configuration	116
8.3.8.6	Barring Channels.....	117
8.3.8.7	Local and Peer Channel Spectrum Graphics.....	118
8.3.8.8	Active Channel History	119
8.3.8.9	Viewing Historic Spectrum Management Metrics	120
8.3.8.10	Spectrum Management Online Help	120
8.3.9	Spectrum Management - Fixed Frequency.....	122
8.3.10	Spectrum Management Control - With Operational Restrictions	123



8.3.11	Remote Management Page	126
8.3.12	SNMP (Simple Network Management Protocol).....	127
8.3.12.1	Supported Management Information Bases (MIBS)	127
8.3.12.2	SNMP Configuration.....	127
8.3.12.3	SMTP (Simple Mail Transport Protocol).....	128
8.3.13	SNTP (Simple Network Time Protocol).....	129
8.3.14	Diagnostics	130
8.3.15	Diagnostics Plotter	131
8.3.16	Diagnostic Download	132
8.3.17	Change System Administration Password	133
8.3.18	License Key.....	134
8.3.19	Properties	135
8.3.20	Reboot.....	136
9	Fault Finding.....	137
9.1	Hardware	137
9.1.1	Power	137
9.1.2	Ethernet.....	138
9.2	Radio	140
9.2.1	No Activity	140
9.2.2	Some Activity.....	140
10	System Connections.....	141
10.1.1	ODU to PIDU Plus Connection	141
11	Lightning Protection	142
11.1	Overview	142
11.1.1	Lightning Protection Zones	142
11.2	Detailed Installation.....	143
11.3	Testing Your Installation.....	151
11.3.1	Pre-Power Testing.....	151
11.3.2	Post-Power Testing.....	152
12	Wind Loading.....	153
12.1	General.....	153
12.2	Calculation of Lateral Force	153
12.3	Capabilities of the PTP 400 Series Bridges	154
12.4	Wind Speed Statistics	154
13	PTP 400 Series Bridge - Connectorized version of the PTP 400 Series bridge.....	155
13.1	Scope	155



13.2	Product Description	155
13.2.1	Hardware	155
13.2.2	Antenna Choices – 4.9 GHz	156
13.2.3	Antenna Choices – 5.8 GHz	156
13.3	Software/Features	156
13.3.1	Status Page	157
13.3.2	Configuration Pages	158
13.3.3	Installation Pages	159
13.4	Deployment Considerations	162
13.5	Link Budget	162
13.6	Regulatory Issues	162
13.6.1	Antenna Choice (5.8GHz FCC Regions Only)	162
13.6.2	Cable Losses (5.8 GHz FCC Regions Only)	163
13.7	Antennas for 5.8GHz FCC Regions	163
13.8	Installation	165
13.8.1	Antenna Choice	165
13.8.2	Cables and Connectors	166
13.8.3	Tools	166
13.8.4	Miscellaneous supplies	166
13.8.5	Mounting	166
13.8.5.1	Connectorized version of the PTP 400 Series bridge	166
13.8.6	Antennas	167
13.8.7	Alignment Process	167
13.8.8	Dual Polar Antennas	167
13.8.9	Separate Antennas	167
13.8.10	Completing the Installation	168
13.8.11	Antenna Cable Fixing	168
13.8.12	Antenna Connection Weatherproofing	169
13.9	Additional Lightning Protection	170
13.9.1	ODU Mounted Outdoors	170
13.9.2	ODU Mounted Indoors	171
14	Wireless Link Encryption	173
14.1	Configuring Link Encryption	173
14.1.1	License Keys	173
14.1.2	Encryption Mode and Key	175
14.2	Wireless Link Encryption FAQ	176



14.2.1	Encryption data entry fields are not available	176
14.2.2	Link fails to bridge packets after enabling link encryption.....	176
15	Legal and Regulatory Notices.....	177
15.1	Important Note on Modifications	177
15.2	National and Regional Regulatory Notices – 4.9 GHz Variant	177
15.3	National and Regional Regulatory Notices – 5.8 GHz Variant	177
15.3.1	U.S. Federal Communication Commission (FCC) and Industry Canada (IC) Notification..	177
15.3.2	European Union Notification	179
15.3.3	UK Notification.....	180
15.4	Exposure	180
15.5	Legal Notices.....	180
15.5.1	Software License Terms and Conditions	180
15.5.2	Hardware Warranty in U.S.	184
15.5.3	Limit of Liability	184
16	Glossary	185
17	FAQs.....	186
18	Specifications	190
18.1	System Specifications	190
18.1.1	Wireless 4.9GHz Variant.....	190
18.1.2	Wireless 5.4GHz Variant.....	193
18.1.3	Wireless 5.8GHz Variant.....	196
18.1.4	Management	199
18.1.5	Ethernet.....	200
18.1.6	Physical	201
18.1.7	Powering	201
18.2	Safety Compliance	202
18.3	EMC Emissions Compliance.....	202
18.3.1	4.9 GHz Variant.....	202
18.3.2	5.4 GHz Variant.....	202
18.3.3	5.8 GHz Variant.....	202
18.4	EMC Immunity Compliance – Europe Only.....	203
18.5	Radio Certifications	204
18.5.1	4.9GHz Variant.....	204
18.5.2	5.4GHz Variant.....	204
18.5.3	5.8GHz Variant.....	204
18.6	Environmental Specifications	205



List of Figures

Figure 1 - Typical PTP 400 Series Bridge Deployment.....	25
Figure 2 - PTP 400 Series Bridge Outdoor Unit (ODU).....	27
Figure 3 - Power Indoor Unit (PIDU Plus) – PTP 400 Series.....	28
Figure 4 - PTP 400 Series Bridge Recovery Switch Location.....	28
Figure 5 - PTP 400 Series Bridge PIDU Plus Power Input.....	30
Figure 6 - External DC Supply Only	30
Figure 7 - External DC Supply and AC Supply.....	31
Figure 8 - External DC Supply and Redundant AC Supply	31
Figure 9 - Remote LED and Recovery Switch Wiring	32
Figure 10 - PTP 400 Series Bridge Layer Diagram.....	36
Figure 11 - 5.8 GHz UK RTTT Channel Avoidance	40
Figure 12 - 4.9 GHz Spectrum Settings.....	40
Figure 13 - 5.4 GHz Available Spectrum Settings.....	41
Figure 14 - 5.8 GHz Available Spectrum Settings.....	42
Figure 15 - 5.8 GHz Band Edge TX Power Reduction (Region Code 1 Only).....	43
Figure 16 - Mounting to pole diameters 25mm (1”) to 50mm (2”)	51
Figure 17 - Integral Safety Loop	51
Figure 18 - Completed ODU connector	53
Figure 19 - RJ45 Pin Connection	53
Figure 20 - Connections at the ODU	54
Figure 21 - Disconnecting the ODU.....	55
Figure 22 - Making the Network Connection at the PTP 400 Series Bridge PIDU Plus	57
Figure 23 - PTP 400 Series Bridge PIDU Plus Drip Loop Configuration.....	59
Figure 24 - Menu Navigation Bar.....	64
Figure 25 - PTP 400 Series Bridge Home Page	65
Figure 26 - Alarm Warning Triangle	66
Figure 27 - Status Page.....	68
Figure 28 - System Administration Login Page	74
Figure 29 - Configuration Page	75
Figure 30 - Configuration Reboot Page.....	77
Figure 31 - LAN Configuration Page	78
Figure 32 - VLAN Warning Window.....	79
Figure 33 - Additional VLAN options	80
Figure 34 - Save and Restore Configuration Page	82
Figure 35 - Save Configuration File Screen	83



Figure 36 - Example Configuration File	84
Figure 37 - Restore Configuration File Pop Up Screen.....	85
Figure 38 - Reset Configuration and Reboot Confirmation Pop-up	86
Figure 39 - System Statistics.....	87
Figure 40 - Detailed Counters	90
Figure 41 - Installation Wizard Internet Protocol Configuration.....	94
Figure 42 - VLAN Warning	95
Figure 43 - Additional VLAN Management Options	96
Figure 44 - Installation Wizard Wireless Configuration	97
Figure 45 - Fixed Frequency Operation.....	100
Figure 46 - Installation Wizard Confirm Configuration.....	102
Figure 47 - Installation Wizard Confirm Configuration – Fixed Frequency.....	103
Figure 48 - Installation Wizard Confirm Configuration – Connectorized	104
Figure 49 - Disarm Installation.....	105
Figure 50 - Optional Post Disarm Configuration 2.....	106
Figure 51 - Installation Screen.....	107
Figure 52 - Software Upgrade – Step 1	109
Figure 53 - Software Upgrade Image Check.....	110
Figure 54 - Overall Progress Tracker	110
Figure 55 - Software Upgrade Complete.....	111
Figure 56 - Spectrum Management - Master.....	115
Figure 57 - Spectrum Management – Slave.....	116
Figure 58 - Sample Spectrum Management Graphic.....	118
Figure 59 - Active Channel History Screen	119
Figure 60 - Spectrum Management Time series Plot.....	120
Figure 61 - Spectrum Management Help Page.....	121
Figure 62 - Spectrum Management Fixed Frequency Screen- Master	122
Figure 63 - Spectrum Management Fixed Frequency Screen- Slave	123
Figure 64 - Spectrum Management Master Screen with Operational Restrictions	124
Figure 65 - Spectrum Management Slave Screen with Operational Restrictions	125
Figure 66 - Remote Management.....	126
Figure 67 - Diagnostic Plotter	131
Figure 68 - CSV Download	132
Figure 69 - Password Change.....	133
Figure 70 - Software License Key Data Entry	134
Figure 71 - License Key Reboot Screen.....	135
Figure 72 - Webpage Properties	135



Figure 73 - System Reboot.....	136
Figure 74 - Main System Connections	137
Figure 75 - ODU to PIDU Plus Connection Diagram.....	141
Figure 76 - ODU mounted in Zones A & B	144
Figure 77 - Showing how the use of a Finial enables the ODU to be mounted inside Zone B	144
Figure 78 - Diagrammatically showing typical wall and mast installations	145
Figure 79 - Upper Grounding Configuration	146
Figure 80 - Lower Grounding Configuration	147
Figure 81 - Surge Arrestor ALPU-ORT Connection Illustration.....	150
Figure 82 - Simplified Circuit Diagram (Only One Transtector Shown For Clarity).....	151
Figure 83 - Connectorized version of the PTP 400 Series bridge Outdoor Unit	155
Figure 84 - Connectorized version of the PTP 400 Series bridge Status Page	157
Figure 85 - Connectorized version of the PTP 400 Series bridge 'System Configuration' Page	158
Figure 86 - Connectorized version of the PTP 400 Series bridge 'Installation Wizard' Page	159
Figure 87 - Connectorized version of the PTP 400 Series bridge 'Confirm Installation' Page.....	160
Figure 88 - Connectorized version of the PTP 400 Series bridge 'Disarm Installation' Page	161
Figure 89 - Forming a Drip Loop	169
Figure 90 - Weatherproofing the Antenna Connections	169
Figure 91 - Additional Grounding When Using Connectorized Units	170
Figure 92 - Lightning Arrestor Mounting	171
Figure 93 - Polyphaser Assembly.....	172
Figure 94 - Software License Key Data Entry	174
Figure 95 - Configuration Data Entry Page	175
Figure 96 - Configuration Reboot Screen.....	176



List of Tables

Table 1 - Font types	17
Table 2 - Admonition types	18
Table 3 - Power Compliance Margins	21
Table 4 - Contact Information	24
Table 5 - Reset Actions	29
Table 6 - PTP 400 Series Bridge Frequency Variants	37
Table 7 - PTP 400 Series Bridge Region Code Definitions	38
Table 8 - 5.4 and 5.8 GHz variants – Aggregate Ethernet Throughput Rates	47
Table 9 - 4.9 GHz variant – Aggregate Ethernet Throughput Rates	48
Table 10 - Audio indications from the ODU	61
Table 11 - PTP 400 Series Bridge Factory Configuration Values	93
Table 12 - Spectrum Management (Non UK) change state key	118
Table 13 - Spectrum Management time series key	120
Table 14 - Spectrum Management Change State Key with Operational Restrictions	125
Table 15 - Protection Requirements	145
Table 16 - Surge Arrestor ALPU-ORT Cable 1 Termination	148
Table 17 - Surge Arrestor ALPU-ORT Cable 2 Termination	149
Table 18 - Resistance Table Referenced To The RJ45 At The PIDU Plus	152
Table 19 - Cable Losses per Length	163
Table 20 - Allowed Antennas for Deployment in USA/Canada	165
Table 21 - US FCC IDs and Industry Canada certification numbers	177
Table 22 - US FCC IDs and Industry Canada certification numbers	178

List of Equations

Equation 1 - Path Loss	46
Equation 2 - Link Loss	72



1 About This User Guide

This guide covers the installation, commissioning, operation and fault finding of the Motorola PTP 400 Series of Point-to-Point Wireless Ethernet Bridges.

1.1 Interpreting Typeface and Other Conventions

This document employs distinctive fonts to indicate the type of information, as described in Table 1.

Font	Type of Information
variable width bold	Selectable option in a graphical user interface or settable parameter in a web-based interface.
<code>constant width regular</code>	Literal system response in a command-line interface.
<i>constant width italic</i>	Variable system response in a command-line interface.
constant width bold	Literal user input in a command-line interface.
<i>constant width bold italic</i>	Variable user input in a command-line interface.

Table 1 - Font types

This document employs specific imperative terminology as follows:

- Type means press the following characters.
- Enter means type the following characters and then press Enter.
- Highlight means click anywhere in a row of data to highlight the entire row.
- Select means use the mouse to click on or branch to the menu item that follows.

Use this table and the Glossary to aid in interpreting the technical acronyms used throughout this User Guide.

This document also employs a set of consistently used admonitions. Each type of admonition has a general purpose that underlies the specific information in the box. These purposes are indicated in Table 2.





Admonition Label	General Message
	<p>Note Informative content that may:</p> <ul style="list-style-type: none"> • Defy common or cursory logic. • Describe a peculiarity of the PTP 400 Series solutions implementation. • Add a conditional caveat. • Provide a reference. • Explain the reason for a preceding statement or provide background for what immediately follows. • Recommendation or suggestion for an easier, quicker, or safer action or practice.
	<p>Important Informative content that may:</p> <ul style="list-style-type: none"> • Identify an indication that you should watch for. • Advise that your action can disturb something that you may not want disturbed. • Reiterate something that you presumably know but should always keep in mind.
	<p>Caution! A notice that the risk of harm to equipment or service exists.</p>
	<p>Warning! A notice that the risk of harm to person exists.</p>

Table 2 - Admonition types



1.2 Getting Additional Help

To get information or assistance as soon as possible for problems that you encounter, use the following sequence of action:

1. Search this document, the user manuals that support the modules, and the software release notes of supported releases:
 - a. In the Table of Contents for the topic.
 - b. In the Adobe Reader® search capability for keywords that apply.⁵
2. Visit the Motorola website at www.motorola.com
3. Ask your Motorola products supplier to help.
4. Gather information from affected units such as:
 - a. the IP addresses and MAC addresses
 - b. the software releases
 - c. data from the Event Log
 - d. the configuration of software features
 - e. any available diagnostic downloads
5. Escalate the problem to Motorola Technical Support (or another Tier 3 technical support that has been designated for you) as follows. You may either:
 - a. Send e-mail to support@orthogonsystems.com
 - b. Call +1 (0) 877 515 0400

For warranty assistance, contact your reseller or distributor for the process.

1.3 Sending Feedback

We welcome your feedback on the PTP 400 Series system documentation. This includes feedback on the structure, content, accuracy, or completeness of our documents, and any other comments you have.

⁵ Reader is a registered trademark of Adobe Systems, Incorporated.

2 Avoiding Hazards

2.1 Preventing Overexposure to RF Energy



Caution To protect from overexposure to RF energy, install the radios for the 400 family of wireless solutions so as to provide and maintain the minimum separation distances from all persons as shown in Table 3.

When the system is operational, avoid standing directly in front of the antenna. Strong RF fields are present when the transmitter is on. The Outdoor Unit (ODU) must not be deployed in a location where it is possible for people to stand or walk inadvertently in front of the antenna.

At these and greater separation distances, the power density from the RF field is below generally accepted limits for the general population.



Note These are conservative distances that include compliance margins. In the case of the reflector, the distance is even more conservative because the equation used models the reflector as a point source and ignores its physical dimensions.

2.1.1 Calculations for Separation Distances and Power Compliance Margins

Limits and guidelines for RF exposure come from:

- US FCC limits for the general population. See the FCC web site at <http://www.fcc.gov>, and the policies, guidelines, and requirements in Part 1 of Title 47 of the Code of Federal Regulations, as well as the guidelines and suggestions for evaluating compliance in FCC OET Bulletin 65.
- Health Canada limits for the general population. See the Health Canada web site at <http://www.hc-sc.gc.ca/rpb> and Safety Code 6.
- ICNIRP (International Commission on Non-Ionizing Radiation Protection) guidelines for the general public. See the ICNIRP web site at <http://www.icnirp.de/> and Guidelines for Limiting Exposure to Time-Varying Electric, Magnetic, and Electromagnetic Fields.



Peak power density in the far field of a radio frequency point source is calculated as follows:

$$S = \frac{P \cdot G}{4 \pi d^2}$$

where
 S = power density in W/m²
 P = RMS transmit power capability of the radio, in W
 G = total Tx gain as a factor, converted from dB
 d = distance from point source, in m

Rearranging terms to solve for distance yields

$$d = \sqrt{\frac{P \cdot G}{4 \pi S}}$$

(Note: Allowance should be made for any TDD structure employed)

2.1.1.1 Calculated Distances and Power Compliance Margins

Table 3 shows calculated minimum separation distances *d*, recommended distances and resulting power compliance margins for each frequency band and antenna combination.

Band	Antenna	Max RMS Power in Burst (Watt)	Variable			D ¹ (m)	Recommended Distance (m)	Power Compliance Margin
			P (Watt)	G	S (W/m ²)			
4.9 GHz	Integrated	0.2 (23dBm)	0.1	158 (22dBi)	10	0.35	3	8.5
	External (max EIRP)	0.2 (23dBm)	0.1	398 (26dBi)	10	0.56	5	8.9
5.4 Ghz	Integrated	0.0025(4dBm)	0.0013	200 (23dBi)	10	0.04	1	22.4
5.7 GHz	Integrated	0.32 (25dBm)	0.16	200 (23dBi)	10	0.50	2	4.0
	External 2ft Flat Plate	0.32 (25dBm)	0.16	631 (28dBi)	10	0.90	4	4.5
	External 6ft Dish	0.32 (25dBm)	0.16	6310 (38dbl)	10	2.83	10	3.5
1. Calculated								

Table 3 - Power Compliance Margins

Notes:

1. The regulations cover the power averaged over a 6 minute period.
2. At 5.4GHz the product is generally to a fixed EIRP which can be achieved with the Integrated Antenna. If there are no EIRP limits, use the distance calculations for 5.7GHz.
3. At 5.7GHz, for antennas between 2ft and 6ft, alter the distance proportionally to the antenna gain.

3 Getting Started



3.1 For Your Safety

WARNING: Use extreme care when installing antennas near power lines.

WARNING: Use extreme care when working at heights.

WARNING: The Outdoor unit (ODU) for the PTP 400 Series Bridge must be properly grounded to protect against lightning. It is the user's responsibility to install the equipment in accordance with Section 810 of the National Electric Code, ANSI/NFPA No.70-1984 or Section 54 of the Canadian Electrical Code. These codes describe correct installation procedures for grounding the ODU, mast, lead-in wire and discharge unit, size of grounding conductors and connection requirements for grounding electrodes. It is recommended that installation of the ODU be contracted to a professional installer.

WARNING: The ODU for the PTP 400 Series Bridge **MUST** be grounded to a Protective Earth as described in Section 7.7.5 "Grounding the Installation" of this Installation Manual and in accordance with the Local Electrical Regulations.

WARNING: It is recommended that the supplied Power Indoor Plus (PIDU Plus) – PTP 400 Series is used to power the PTP 400 Series Bridge ODU. The use of other power sources may invalidate safety approval and affect your warranty.

WARNING: When using alternate DC supplies (via the PIDU Plus DC in terminals as described in Section 3.3.3 "Redundancy and Alternate Powering Configurations"), such as battery-backed DC power source, the supply **MUST** comply with the following requirements:

- The voltage and polarity is correct and is applied to the correct terminals in the PTP 400 Series Bridge PIDU Plus
- The power source is rated as SELV
- The power source is rated to supply at least 1A continuously, and
- The power source cannot provide more than the Energy Hazard Limit as defined by IEC/EN/UL6090, Clause 2.5, Limited Power (The Energy Hazard Limit is 240VA)

CAUTION: When the system is operational, avoid standing directly in front of the antenna. Strong RF fields are present when the transmitter is on. The Outdoor Unit (ODU) must not be deployed in a location where it is possible for people to stand or walk inadvertently in front of the antenna.

CAUTION: Users and installers should note that in an emergency the mains power supply is the primary disconnect device.



CAUTION: Safety will be compromised if external quality cables are not used for connections that will be exposed to the weather.

CAUTION: Safety will be compromised if a different power supply is used than the one supplied by Motorola as part of the system. This will also invalidate your warranty.

3.2 Welcome

Congratulations on the purchase of the PTP 400 Series Bridge from Motorola, Inc. The PTP 400 Series Bridge is the latest innovation in high-speed wireless networking that lets you deploy wireless networks in areas previously unattainable.

3.2.1 About This Guide

This guide covers the installation, commissioning, operation and fault finding of the PTP 400 Series Bridge.

3.2.2 Who Should Use This Guide

The guide is for use by the system installer and the end user IT professional. The system installer will require expertise in the following areas:

- Outdoor radio equipment installation
- Network configuration
- Use of web browser for system configuration, monitoring and fault finding



3.2.3 Contact Information

Postal Address:	Motorola, Inc. Unit A1, Linhay Business Park, Eastern Road, Ashburton, Devon. TQ13 7UP United Kingdom
Web Site:	http://www.motorola.com/ptp
Sales Enquires:	mailto:sales@orthogonsystems.com
North American:	mailto:usainfo@orthogonsystems.com
International:	mailto:globalinfo@orthogonsystems.com
Web Support:	http://www.motorola.com/ptp/
Email Support:	mailto:support@orthogonsystems.com
Telephone Enquiries and Global Support (Toll Free in the USA):	+1 (0) 877 515 0400

Table 4 - Contact Information

Comments or suggestions concerning this user manual may be emailed to the support team.

3.2.4 Repair and Service

For unit repair or service, contact your service provider or an authorized Motorola Point-to-Point Distributor for return material authorization (RMA) and shipping instructions.

3.3 Product Description

This User Manual is specifically written for the PTP 400 Series of point-to-point broadband wireless solutions. The PTP 400 Series Bridge has been developed to provide Point-to-Point data connectivity via a 4.9 GHz, 5.4 GHz or 5.8 GHz wireless Ethernet bridge operating at broadband data rates. The PTP 400 Series Bridge is aimed at a wide range of applications. An example application is an enterprise that has a requirement to connect together the Local Area Network (LAN) of two or more buildings as shown in Figure 1.

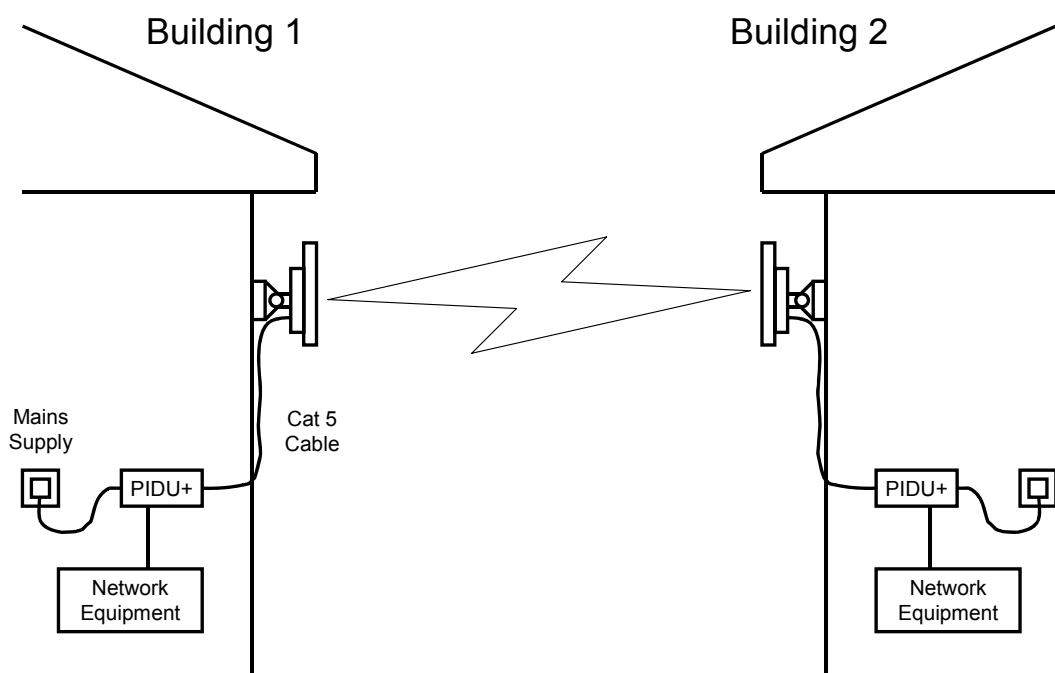

Figure 1 - Typical PTP 400 Series Bridge Deployment

The PTP 400 Series Bridge offers true non-line-of-sight (NLOS) operation by using a combination of Orthogonal Frequency Division Multiplex (OFDM) modulation and Multiple-In Multiple-Out (MIMO) techniques. These technologies enable the PTP 400 Series Bridge to drive through foliage and around buildings to such an extent that almost universal coverage can be expected at short range.

A PTP 400 Series Bridge system consists of a pair of identical devices that are deployed one at each end of the link. At installation, the user sets up one unit as the Master and the other as the Slave. Either unit can be configured as master or slave.



Each end of the link consists of:

- An integrated outdoor transceiver unit containing all the radio and networking electronics hereafter referred to as the Outdoor Unit (ODU).
- An indoor connection box containing a mains power supply, status indicators and network connection. Hereafter referred to as the Power Indoor Unit Plus (PIDU Plus).
- Units will normally be supplied pre-configured as a link.

Power is fed into the PIDU Plus from the mains via a standard “figure of eight” mains plug. The network connection is presented to the user at the PIDU Plus via an RJ45 socket. Connection between the ODU and PIDU Plus is made using standard shielded CAT5 UV resistant cable. The spare twisted pairs of the cable are used to feed power from the PIDU Plus to the ODU.

3.3.1 The Outdoor Unit (ODU)

The ODU (Figure 2) is a self-contained unit. It houses both radio and networking electronics. Also shown in Figure 2 is a Lightning protection unit, see Section 11 “Lightning Protection”. A single CAT 5 cable feeds the unit. Power is fed to the unit via the brown/brown white pair connected to pins 7 and 8 and the blue/blue white pair connected to pins 4 and 5 of the RJ45 plugs and sockets employed. It should be noted that this powering arrangement is not standard Power over Ethernet (PoE). The ODU for the PTP 400 Series Bridge should only be deployed using the supplied PTP 400 Series Bridge Power Indoor Unit (PIDU Plus).



WARNING: All four power conductors **MUST** be connected.



Figure 2 - PTP 400 Series Bridge Outdoor Unit (ODU)



3.3.2 The PIDU Plus – PTP 400 Series

The PTP 400 Series Bridge PIDU Plus is used to generate the ODU supply voltage from the mains supply. The PIDU Plus also houses a status indicator driven from the ODU.



Figure 3 - Power Indoor Unit (PIDU Plus) – PTP 400 Series

The front panel contains indicators showing the status of the power and Ethernet connections. The power indicator is illuminated when the PIDU Plus is receiving mains power.

The Ethernet indicator normally illuminates when the Ethernet link is working, flashing when there is Ethernet activity. The fact that it lights also indicates that the ODU is powered. At power up the LED will flash 10 times to indicate that a correct start up sequence has occurred. See Section 9 for further fault finding information.

The bottom of the PIDU Plus houses the Ethernet connection via RJ-45 socket, an entry point for the PIDU Plus/ODU cabling and the Recovery Switch.



Figure 4 - PTP 400 Series Bridge Recovery Switch Location

The recovery switch is used for various purposes identified in Table 5.

Recovery Button Depression	Action
More than 20 seconds, while the unit is already powered up.	This resets the configuration to factory defaults.
While connecting power for more than 40 seconds after power is applied	This resets to factory defaults and erases any user loaded software images leaving the factory-loaded image intact.
None	Power cycle by switching off at the mains. All settings remain the same.

Table 5 - Reset Actions

On the left side of the PIDU Plus 48V DC input and output connections can be found. These are used to power the PTP 400 Series Bridge from an external DC source or to provide a level of power supply redundancy as shown in Section 3.3.3 “Redundancy and Alternate Powering Configurations”. The DC input range is 36-60V. The ODU requires 36V to operate so care should be taken to account for voltage drop over the ODU to PIDU Plus cable.



WARNING: When using alternate DC supplies the supply **MUST** comply with the following requirements:

- The voltage and polarity is correct and is applied to the correct terminals in the PTP 400 Series Bridge PIDU Plus
- The power source is rated as SELV
- The power source is rated to supply at least 1A continuously, and
- The power source cannot provide more than the Energy Hazard Limit as defined by IEC/EN/UL6090, Clause 2.5, Limited Power (The Energy Hazard Limit is 240VA)

Also on the left hand side of the PTP 400 Series Bridge PIDU Plus connects and jumpers can be found that allow the remote connection of power LED, Ethernet LED and Recovery switch. The connection instructions can be found in Section 3.3.4 “Remote LEDs and Recovery Switch”

The input supply range for the PTP 400 Series Bridge PIDU Plus is 100V-240V AC, 47-63Hz. Mains connection to the PTP 400 Series Bridge PIDU Plus is made using a standard “figure of eight” mains lead as shown in Figure 5.



Figure 5 - PTP 400 Series Bridge PIDU Plus Power Input

3.3.3 Redundancy and Alternate Powering Configurations

3.3.3.1 External DC Supply Only

For use where there is no mains supply.

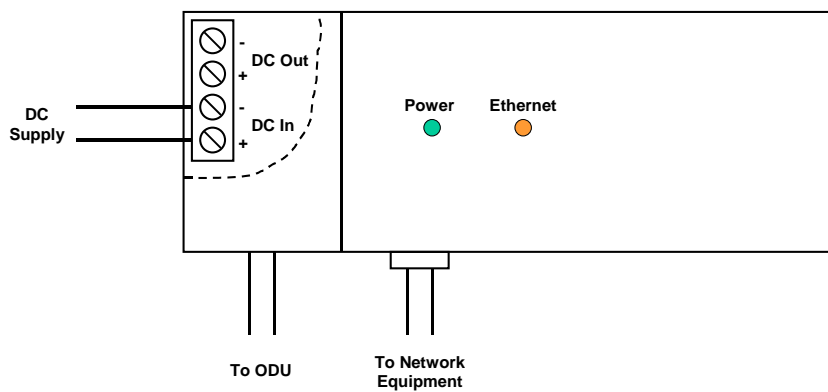

Figure 6 - External DC Supply Only

3.3.3.2 External DC Supply and AC Supply

To give redundancy through the use of mains and DC supply.

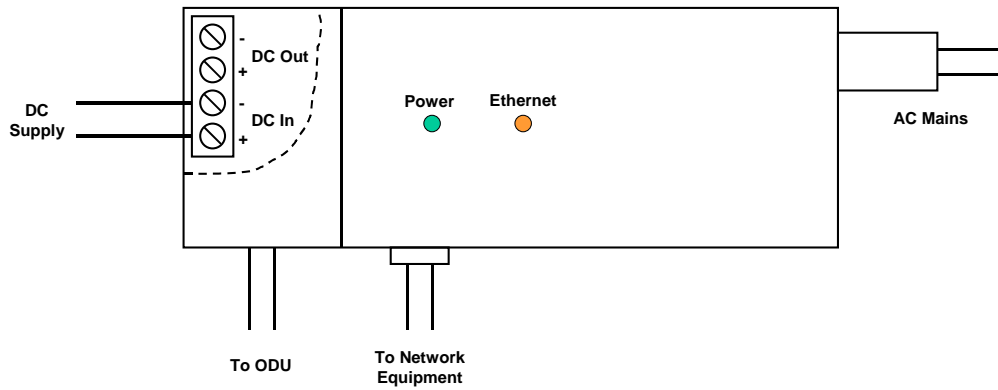

Figure 7 - External DC Supply and AC Supply

3.3.3.3 External DC Supply and Redundant AC Supply

To guard against mains failure, DC supply failure or PTP 400 Series Bridge PIDU Plus failure.

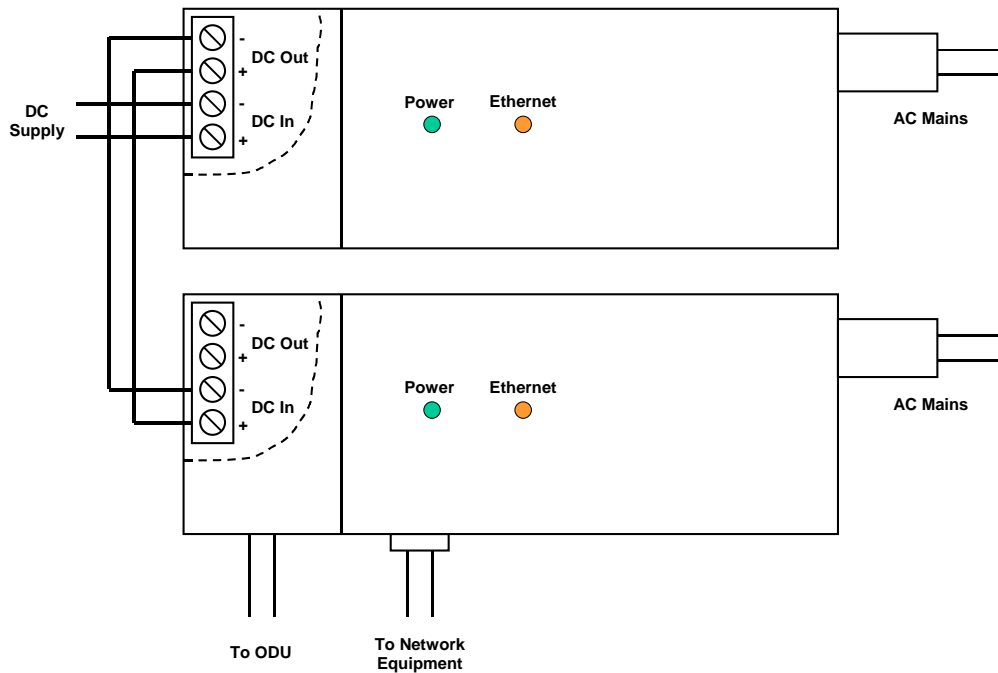

Figure 8 - External DC Supply and Redundant AC Supply

3.3.4 Remote LEDs and Recovery Switch

The PTP 400 Series Bridge PIDU Plus provides a facility to connect remote LEDs and Recovery switch allowing the PIDU Plus to be mounted inside an enclosure. At the left end of the PIDU Plus under the ODU connection cover can be found three jumpers and a PCB header. Jumpers J906 and J907 should be removed and connection to the remote LEDs and Recovery switch made to J908 as shown in Figure 9.

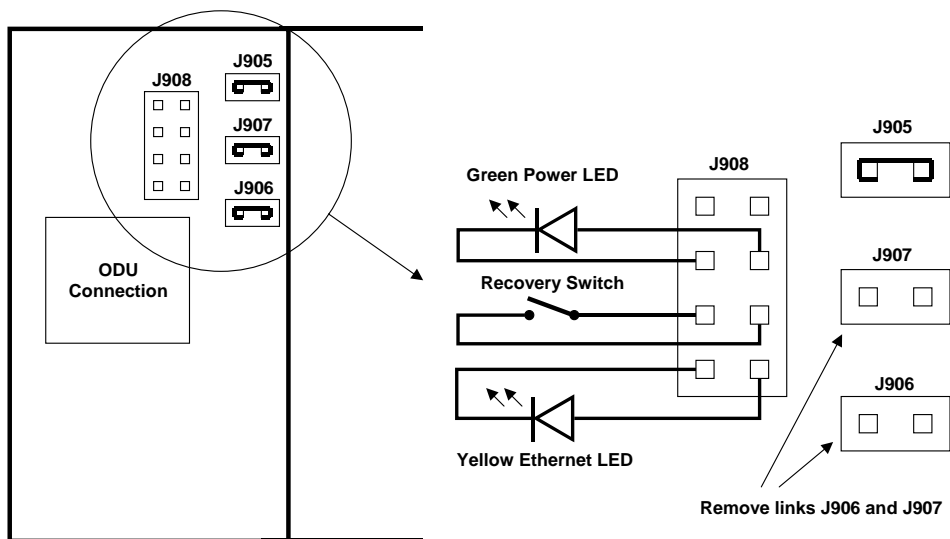

Figure 9 - Remote LED and Recovery Switch Wiring

3.3.5 Cables and Connectors

The cable used to connect the PTP 400 Series PIDU Plus to the ODU can be any standard CAT 5 type provided that it is suitable for outdoor deployment. Motorola recommends that cables to the specification below be used.

NEC/CEC: CMR (ETL) C (ETL) 75C SUN RES OIL RES II

Failure to use the recommended (or equivalent) standard of cable may invalidate the system's safety certification.

The PIDU Plus/ODU cable may be unshielded (UTP) or shielded (STP). However, unshielded cables reduce the system's ability to cope with nearby lightning strikes. If lightning activity is common in the area of deployment, the use of shielded cable is highly recommended. See Section 11 "Lightning Protection".



The connection between the PTP 400 Series Bridge PIDU Plus and the user's equipment can be made using any standard CAT5 patch cable. The RJ45 Ethernet connection is presented as a piece of network equipment. However as automatic MDI/MDI-X sensing and pair swapping is employed a crossed Ethernet patch cable can be used for connection to another piece of networking equipment or directly to end user equipment.

It should be noted that the PIDU Plus provides continuity between the screen on the ODU to PIDU Plus cable and screen on the PIDU Plus-User equipment cable. If continuity of the screening is desired from the ODU to the PIDU Plus to the user's equipment, CAT5 STP cable and connectors should be used for the latter connection. CAT5 STP cable between the PIDU Plus and the user's equipment will provide additional protection against surges induced on the Ethernet connections.

3.3.6 Surge Arrestor



The PTP 400 Series Bridge PIDU Plus does not provide lightning or surge suppression. Should lightning or surge suppression be required a separate Ethernet surge suppressor should be used and appropriately earthed. Suitable surge suppressors can be sourced from your Motorola Point-to-Point Distributor or Solutions Provider. The ODU is protected by built-in surge suppression as standard. See 11 "Lightning Protection".

3.3.7 Mounting Brackets

The PTP 400 Series Bridge is supplied with a mounting bracket suitable for mounting the ODU to a pole of 25mm (1") to 75mm (3") in diameter. For more details on mounting, see section 7 "Installation".

The bracket allows for adjustment in both azimuth and elevation.

The PIDU Plus can either be desk or wall mounted. The preference is wall mounted with the cables dressed to a cable channel. Remember to leave space for access to the recovery button. See section 7.7.6.



3.3.8 Configuration and Management

Configuration and Management of the PTP 400 Series Bridge is implemented using an inbuilt web server hosting a number of Configuration and Management web pages. This approach allows Configuration and Management to be carried out on any standard web browsing technology. The PTP 400 Series Bridge can also be managed remotely using the SNMP management protocol. Connection to the bridge is via the Ethernet connection carrying the bridge network traffic. Connection to the unit is via a preset IP address. This address can be changed via the Network Interface Configuration web page. A full explanation of the available web pages and their use can be found in section 8 “Web Page Reference”.

3.4 Warranty

Motorola’s standard hardware warranty is for one (1) year from date of shipment from Motorola or a Motorola Point-to-Point Distributor. Motorola warrants that hardware will conform to the current relevant published specifications and will be free from material defects in material and workmanship under normal use and service. Motorola shall within this time, at its own option, either repair or replace the defective product within thirty (30) days of receipt of the defective product. Repaired or replaced product will be subject to the original warranty period but not less than thirty (30) days.

Motorola’s warranty for software is for six (6) months from date of shipment from Motorola or a Motorola Point-to-Point Distributor. Motorola warrants that software will perform substantially in accordance with the published specifications for that release level of the software and will be free from material defects in material and workmanship under normal use and service. Motorola shall within this time correct or replace software to correct significant, demonstrable program or documentation errors.

IN NO EVENT SHALL MOTOROLA, INC. BE LIABLE TO YOU OR ANY OTHER PARTY FOR ANY DIRECT, INDIRECT, GENERAL, SPECIAL, INCIDENTAL, CONSEQUENTIAL, EXEMPLARY OR OTHER DAMAGE ARISING OUT OF THE USE OR INABILITY TO USE THE PRODUCT (INCLUDING, WITHOUT LIMITATION, DAMAGES FOR LOSS OF BUSINESS PROFITS, BUSINESS INTERRUPTION, LOSS OF BUSINESS INFORMATION OR ANY OTHER PECUNIARY LOSS, OR FROM ANY BREACH OF WARRANTY, EVEN IF MOTOROLA, INC. HAS BEEN ADVISED OF THE POSSIBILITY OF SUCH DAMAGES. (Some states in the USA do not allow the exclusion or limitation of incidental or consequential damages, so the above exclusion or limitation may not apply to you.) IN NO CASE SHALL MOTOROLA’S LIABILITY EXCEED THE AMOUNT YOU PAID FOR THE PRODUCT.



4 Product Architecture

The PTP 400 Series Bridge consists of an identical pair of unit's deployed one at each end of the link. The radio link operates on a single frequency channel in each direction using Time Division Duplex (TDD). One unit is deployed as a master and the other as a slave. The master unit takes responsibility for controlling the link in both directions.

The non-line-of-sight (NLOS) aspects of the product are provided by Multiple-Input Multiple-Output (MIMO), coupled with Orthogonal Frequency Division Multiplexing (OFDM) modulation.

The PTP 400 Series Bridge has been developed to operate within a selection of frequency bands.

The current product range supports:

- USA 4.9 GHz National Public Safety Band (4.940-4.990 GHz) - 49400
- ETSI 5.4 GHz license exempt band B (5.470-5.725 GHz) - 54400
- ETSI 5.8 GHz license exempt band C (5.725-5.850 GHz) and the USA 5 GHz ISM band (5.725-5.850 GHz) - 58400

The PTP 400 Series Bridge has been designed to coexist with other users of the band in an optimal fashion using a combination of Transmit Power Control (TPC), Planned Frequency Allocation or Dynamic Frequency Selection (DFS) and antenna beam shape.

In order to maintain link availability, the product employs adaptive modulation techniques that dynamically reduce the data rate in severe or adverse conditions. To the data network the PTP 400 Series Bridge is implemented as a learning bridge. A learning bridge builds up a picture of which addresses are connected to which port. This means that it will not bridge a packet if it knows that the destination address is connected to the same port on which the bridge saw the packet. Figure 10 illustrates the PTP 400 Series Bridge layer diagram.

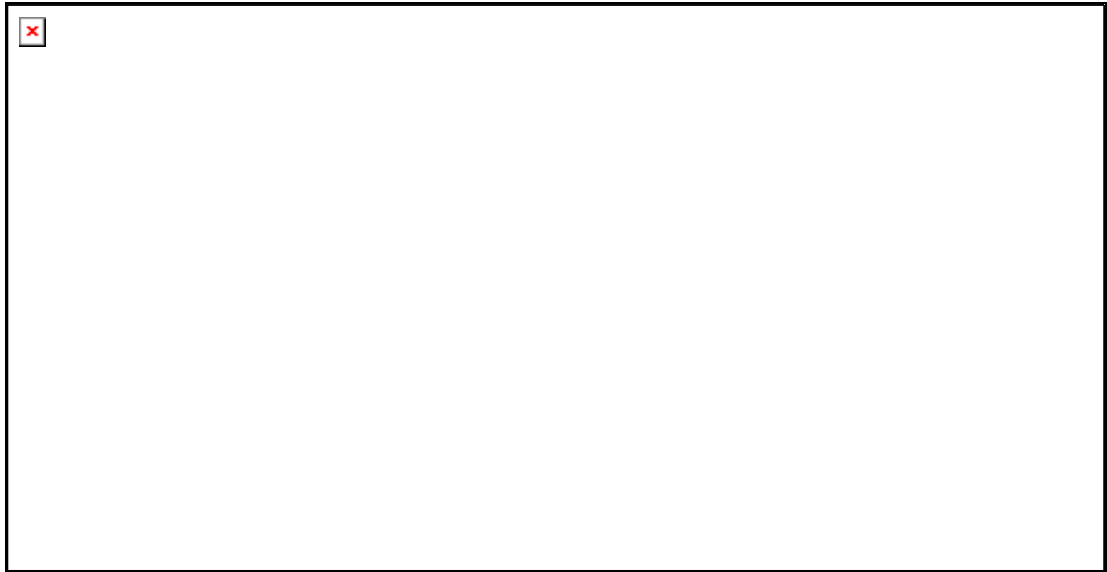

Figure 10 - PTP 400 Series Bridge Layer Diagram

The PTP 400 Series Bridge functionality has been extended to encompass the specification IEEE 802.1p. IEEE 802.1p and uses Ethernet packets extended by 4 bytes, as specified in IEEE 802.1q for VLAN tagging, to prioritize packets over the wireless interface. The PTP 400 Series Bridge will forward all VLAN tagged packets regardless of the VLAN ID value.

Each unit in the link is manageable through an IP connection. Standard IP protocols are utilized for all management functions e.g. HTTP, SNMP, etc.

The PTP 400 Series Bridge is fully software upgradeable. New software images are first downloaded from the Motorola website <http://www.motorola.com/ptp> to a convenient computer. The image is then uploaded to the ODU via the web management page described in Section 8.3.7 “Software Upgrade”. Once the image transfer has completed successfully the image is written to memory. On completion of this process the unit can be rebooted to use the newly uploaded image. Should this process fail the unit will revert to a protected image installed during manufacturing to allow the unit to be recovered.

5 General Considerations

5.1 Spectrum Planning

The PTP 400 Series Bridge has three frequency variants in its product range.

Band	Definition	Frequency Coverage	Channel Width	Channel Raster
4.9 GHz	USA National Public Safety Band	4940-4990 MHz	10 MHz	5 MHz
5.4 GHz	ETSI 5 GHz band B	5470-5725 MHz	11 MHz	12 MHz
5.8 GHz	USA ISM Band / ETSI 5 GHz band C	5725-5850 MHz	11 MHz	6 MHz

Table 6 - PTP 400 Series Bridge Frequency Variants

There are two distinct approaches to spectrum planning:

First, an operator can utilize the default spectrum management mode i-DFS (intelligent Dynamic Frequency Selection). This mode uses the PTP 400 Series Bridge's ability to measure the interference levels in all channels to build up a picture of the interference / noise levels in all channels. The PTP 400 Series Bridge uses statistical techniques to select the most appropriate transmit and receive channels. I-DFS can be influenced in its channel decision process by selectively barring channels from use. The use of this functionality is described in detail in section 8.3.8 "Spectrum Management".

Second, when detailed control of the spectrum allocation is required it is recommended that the fixed frequency mode is used to statically allocate transmit and receive channels.



5.2 Region Codes

The PTP 400 Series Bridge uses a system of Region Codes to control the operation of the radio link. The Region Code is set by a License Key.

Region Code	Applicable Country/Frequency	Max Tx Power	EIRP Limit	Operational Restrictions (see section 5.3)
1	USA, Canada, Taiwan, Brazil 5.8 GHz	25dBm	None	Reduced TX Power at Band Edges see section 5.5.3 "Transmit Power Reduction at the Band Edges"
2	China 5.8 GHz	10dBm	33dBm	
3	Australia , Hong Kong 5.8 GHz	13dBm	36dBm	
4	UK 5.8 GHz	7dBm	30dBm	Radar and RTTT (Road Transport and Traffic Telematics, 5795 to 5815 MHz) Avoidance Enabled
5	Singapore 5.8 GHz	-3dBm	20dBm	
6	Eire 5.8GHz	7dBm	30dBm	
7	Norway 5.8 GHZ	25dBm	53dBm	Radar Avoidance Enabled
7	5.4 GHz	25dBm	None	Radar Avoidance Enabled
8	5.8 GHz	25dBm	None	
8	5.4 GHz	25dBm	None	
9	ETSI 5.4 GHz	4dBm	28dBm	Radar Avoidance Enabled
10	5.4 GHz	4dBm	None	Radar Avoidance Enabled Weather Radar (5630MHz) Avoidance
10	Australia 5.4 GHz	4dBm	None	DFS Enabled - Weather Radar barred
11	Korea 5.8 GHz	20dBm	None	Band restricted to 5725 to 5825 MHz
14	4.9 GHz	23dBm		When using external antennas with a gain > 26 dBi the Tx Power must be reduced by the number of dB that 26 dbi is exceeded

Table 7 - PTP 400 Series Bridge Region Code Definitions



When shipped from the factory, units are configured as follows:

- 4.9 GHz PTP 400 Series Bridge – Region Code 14
- 5.4 GHz PTP 400 Series Bridge – Region Code 9
- 5.8 GHz PTP 400 Series Bridge – Region Code 1



WARNING To meet the regulatory requirements of your region you should set the correct Region Code by obtaining a new License Key from you reseller or distributor.

5.3 Operational Restrictions

5.3.1 Radar Avoidance

Radar Avoidance requires that equipment used in the region:

- Detects interference from other systems and avoids co-channel operation with these systems, notably radar systems.
- Provide on aggregate a uniform loading of the spectrum across all devices.

To address the primary aims the Spectrum Management algorithm implements a radar detection function which looks for impulsive interference on the active channel only. If impulsive interference is detected Spectrum Management will mark the current active channel as having detected radar and initiate a channel hop to an available channel. The previous active channel will remain in the radar detected state for thirty minutes after the last impulsive interference pulse was detected. After the thirty minutes have expired the channel will be returned to the available channel pool.

The radar detection algorithm will always scan the active channel for 60 seconds for radar interference before using the channel. This compulsory channel scan will mean that there is a 60-seconds service outage every time radar is detected and that the installation time is extended by 60 seconds even if there is found to be no radar on the channel.



NOTE: On system installation or start-up this extends the initial scan time of the Master unit by 60 seconds.

To address the “provide aggregate uniform loading of the spectrum across all devices” requirement, the channel selection algorithm will choose a channel at random from a list of available channels. The channel selection algorithm is initiated at link initialization and when radar interference is detected.



5.3.2 RTTT Avoidance and Other Channel Use Restrictions

Where regulatory restrictions apply to certain channels these channels are barred. The user should note that the number of channels barred is dependant on the channel raster selected. For example see the effect of the UK RTTT channel restrictions in Figure 11. Barred channels are indicated by a “No Entry” symbols displayed on the “Spectrum Management” web page, see section 8.3.10 “Spectrum Management Control - With Operational Restrictions”.

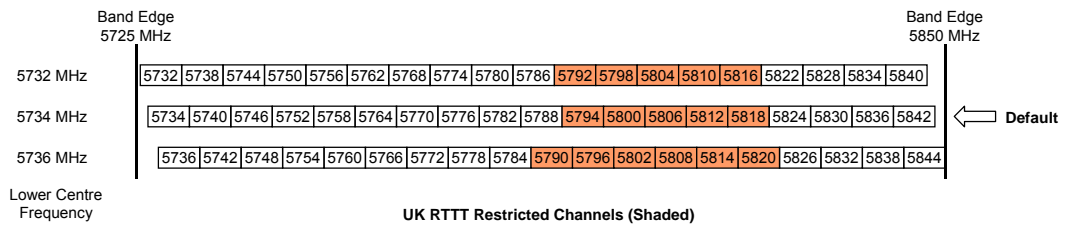

Figure 11 - 5.8 GHz UK RTTT Channel Avoidance

5.4 4.9 GHz Specific Frequency Planning Considerations

The current 4.9 GHz variant does not require the operator to adjust the lower center frequency to achieve full band coverage. The channels are set as shown in

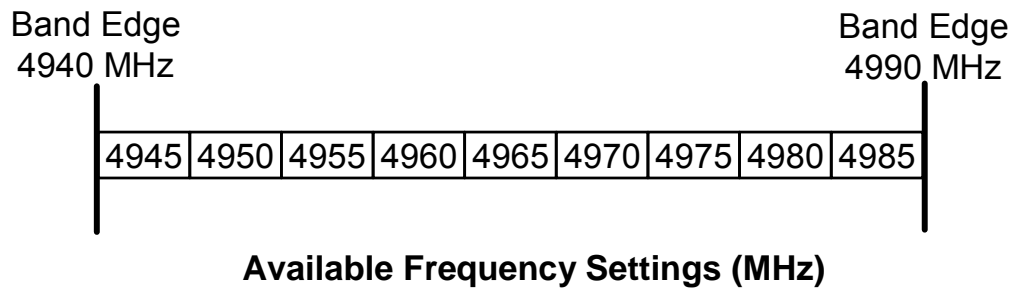

Figure 12 - 4.9 GHz Spectrum Settings

5.4.1 Raster Considerations

The 4.9 GHz variant operates on a fixed 5 MHz channel raster that is set to odd center frequencies. See Figure 12.

5.4.2 Fixed Frequency Operation

When operating in ‘Fixed Frequency’ mode (see section 8.3.5.3 “Wireless Configuration”) the operator can set the operating frequency independently in both directions to any of the center frequencies available in i-DFS mode.



5.4.3 Transmit Power Reduction at the Band Edges

The 4.9 GHz variant does not apply any band edge power reduction.

5.5 5.4 GHz Specific Frequency Planning Considerations

To fully utilize the 5.470 to 5.725 GHz of allocated spectrum the operator must adjust the lower center frequency attribute in the installation wizard, described in detail in 8.3.5 “Install Wizard Pages” Adjustment of the lower center frequency allows the operator to slide the available frequency settings up and down the 5.4 GHz band. See Figure 13.



Figure 13 - 5.4 GHz Available Spectrum Settings

5.5.1 Raster Considerations

The PTP 400 Series bridge 5.4 GHz variant operates on a 12 MHz channel raster that is set to odd center frequencies. See Figure 13.

5.5.2 Fixed Frequency Operation

When operating in ‘Fixed Frequency’ mode (see section 8.3.5.3 “Wireless Configuration”) the operator can set the operating frequency independently in both directions to any of the center frequencies available in i-DFS mode using the ‘Default Raster’ setting. For the expert user further granularity can be obtained by turning off the ‘Default Raster’. In this mode the operator is able to select any odd frequency that sets the channel in-band.

5.5.3 Transmit Power Reduction at the Band Edges

The 5.4 GHz variant does not apply any band edge power reduction.

5.6 5.8GHz Specific Frequency Planning Considerations

To fully utilize the 5.725 to 5.850 GHz of allocated spectrum the operator must adjust the lower center frequency attribute in the installation wizard, described in detail in 8.3.5 “Install Wizard Pages” Adjustment of the lower center frequency allows the operator to slide the available frequency settings up and down the 5.8 GHz band. See Figure 14

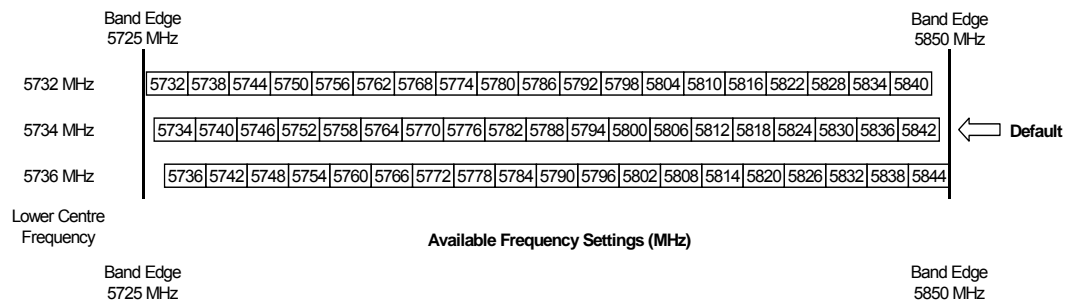

Figure 14 - 5.8 GHz Available Spectrum Settings

5.6.1 Raster Considerations

The PTP 400 Series Bridge 5.8 GHz variant operates on a 6 MHz channel raster that is set to even center frequencies. see Figure 14.

5.6.2 Fixed Frequency Operation

When operating in ‘Fixed Frequency’ mode (see section 8.3.5.3 “Wireless Configuration”) the operator can set the operating frequency independently in both directions to any of the center frequencies available in i-DFS mode using the ‘Default Raster’ setting. For the expert user further granularity can be obtained by turning off the ‘Default Raster’. In this mode the operator is able to select any even frequency that sets the channel in-band.

5.6.3 Transmit Power Reduction at the Band Edges

Operation at or near the 5.8 GHz band edges can result in a lower maximum transmit power. In some configurations the PTP 400 Series Bridge reduces the power when operating at the edge channels. The amount of reduction if any is dependant on the local regulator authority of the region of operation. These currently only affect systems configured with Region Code 1.

The power reduction in the edge channels is presented in Figure 15.

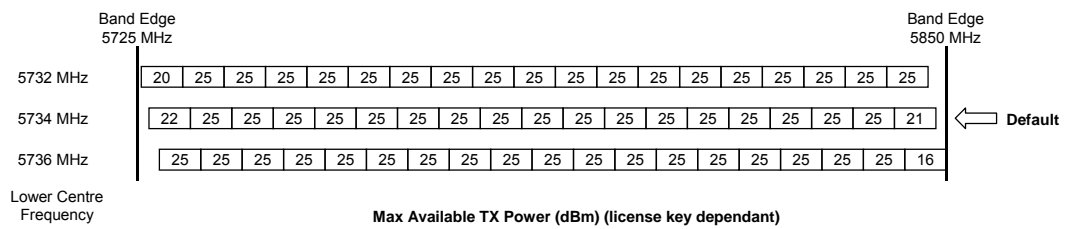

Figure 15 - 5.8 GHz Band Edge TX Power Reduction (Region Code 1 Only)

5.7 Distance

The PTP 400 Series Bridge will operate at ranges from 100 m (330 feet) to 200 km (124 miles), within four modes 0-5km, 0-40km, 0-100km and 0-200km. Operation of the system will depend on obstacles in the path between the units. Operation at 40 km (25 miles) or above will require a near line-of-sight path. Operation at 100m (330 feet) could be achieved with one unit totally obscured from the other unit, but with the penalty of transmitting at higher power in a non-optimal direction, thereby increasing interference in the band. This subject is covered in more detail in section 6.1.3 “Path Loss Considerations”.

5.8 Networking Information

The PTP 400 Series Bridge operates as a transparent Ethernet bridge. Each unit requires an IP address. This IP address is for management purposes only and it plays no part in the operation of the system. IP addresses are assigned during initial configuration as described in section 7.2 “Installation Procedure”.

5.9 Lightning Protection

The amount of lightning protection is dependent on regulatory requirements and the end user requirements. The standard ODU for the PTP 400 Series Bridge is fitted with surge limiting circuits and other features to minimize the risk of damage due to nearby lightning strikes. These standard features may require some additional equipment to be configured as part of the system installation to be fully effective. Motorola recommends the use of screened cable and surge arrestor to protect connected equipment from nearby strikes.

The PTP 400 Series Bridge is not designed to survive direct lightning strikes. For this reason the unit should not be installed as the highest point in a localized area, unless specific precautions are taken. See section 11 “Lightning Protection”.



5.10 Electrical Requirements

The PTP 400 Series Bridge is supplied with a variable input voltage (90-264V, 47-63Hz AC) inline power supply unit which is incorporated into the PTP 400 Series Power Indoor Unit (PIDU Plus). The PTP 400 Series Bridge requires one mains supply outlet at each end of the link.

Alternately, the PTP 400 Series Bridge may be powered by a DC supply (45-55V) through the terminals provided under the left cover on the PIDU Plus.



6 Site Planning

6.1 Site Selection Criteria

The following are guidelines for selecting the installation location of the ODU and PIDU Plus for the PTP 400 Series Bridge.

6.1.1 ODU Site Selection

When selecting a site for the ODU the following should be taken into consideration:

- That it is not possible for people to stand or walk inadvertently in front of the antenna.
- Height and location to achieve the best radio path
- Height in relation to other objects with regard to lightning strikes
- Protection from the weather
- Aesthetics and planning permission issues
- Distance from the PIDU Plus and connected equipment (Maximum cable run ODU to connected equipment is 100m [330 feet])
- Distance from the PIDU Plus to the ODU (Maximum cable run from the PIDU Plus to the ODU is 100m [330 feet] minus the length of the cable from the PIDU Plus to the connected equipment)

6.1.2 PTP 400 Series Bridge PIDU Plus Site Selection

When selecting a site for the PIDU Plus the following should be taken into consideration:

- Availability of a mains electricity supply
- Accessibility for viewing status indicators and pressing reset switch (See section 3.3.2 “The Power Indoor Unit (PIDU Plus)” and section 9 “Fault Finding”)



6.1.3 Path Loss Considerations

The path loss is the amount of attenuation the radio signal undergoes between the two ends of the link. The path loss is the sum of the attenuation of the path if there were no obstacles in the way (Free Space Path Loss), the attenuation caused by obstacles (Excess Path Loss) and a margin to allow for possible fading of the radio signal (Fade Margin).

$$L_{free_space} + L_{excess} + L_{fade} + L_{seasonal} < L_{capability}$$

Where

L_{free_space} Free Space Path Loss (dB)

L_{excess} Excess Path Loss (dB)

L_{fade} Fade Margin Required (dB)

$L_{seasonal}$ Seasonal Fading (dB)

$L_{capability}$ Equipment Capability (dB)

Equation 1 - Path Loss

6.1.4 Aggregate Ethernet throughput rate versus maximum link loss

The equipment capability is given in Table 8 and Table 9. It gives the Ethernet throughput rate versus link loss for the PTP 400 Series Bridge in both modes. Adaptive modulation will ensure that the highest throughput that can be achieved instantaneously will be obtained taking account of propagation and interference. The calculation of Equation 1 needs to be performed to judge whether a particular link can be installed. When the link has been installed web pages provide information about the link loss currently measured by the equipment both instantaneously and averaged. The averaged value will require maximum seasonal fading to be added and then the radio reliability of the link can be computed.

The full calculation is relatively complicated and thus Motorola has supplied a PTP Link Estimator that calculates the radio propagation and reliability of NLOS links using the PTP 400 Series Bridge equipment.



Mode	Aggregate Ethernet Throughput Rate (Mbps) ^{6 7}								5.8 GHz Max Path Budget (dB) ⁸	5.4 GHz Max Path Budget (dB) ⁷
	Hi = High Throughput Mode Lo = Low Latency Mode									
	0-5km		0-40km		0-100km		0-200km			
	Hi	Lo	Hi	Lo	Hi	Lo	Hi	Lo		
64QAM ^{7/8}	42.51	39.66	39.48	34.68	35.17	28.54	29.76	22.04	138.1	139.8
64QAM ^{3/4}	36.44	33.99	33.84	29.73	30.15	24.47	25.51	18.89	142.3	142.5
64QAM ^{2/3}	32.39	30.21	30.08	26.42	26.80	21.75	22.68	16.79	144.4	144.3
16QAM ^{3/4}	24.29	22.66	22.56	19.82	20.10	16.31	17.01	12.60	150.4	150.9
16QAM ^{1/2}	16.20	15.11	15.04	13.21	13.40	10.87	11.34	8.40	155.2	153.5
QPSK ^{2/3}	10.80	10.07	10.03	8.81	8.93	7.25	7.56	5.60	160.7	160.3
QPSK ^{1/2}	8.10	7.55	7.52	6.61	6.70	5.44	5.67	4.20	163.0	162.8
BPSK ^{1/2}	3.60	3.36	3.34	2.94	2.98	2.42	2.52	1.87	168.5	168.6

Table 8 - 5.4 and 5.8 GHz variants – Aggregate Ethernet Throughput Rates

⁶ Data rates for the Lite version of the PTP 400 Series Bridge variants are 50% of the figures shown.

⁷ These data rates are reduced when AES Encryption or ARQ (Automatic Retransmission reQuest) are enabled.

⁸ AMOD link margin of 1.5dB applied



Mode	Aggregate Ethernet Throughput Rate (Mbps) ^{9 10}				4.9 GHz Max Path Budget (dB) ¹²
	Hi = High Throughput Mode Lo = Low Latency Mode ¹¹				
	0-5km	0-40km	0-100km	0-200km	
	Hi	Hi	Hi	Hi	
64QAM $\frac{7}{8}$	34.63	32.15	28.65	24.24	136.8
64QAM $\frac{3}{4}$	29.68	27.56	24.56	20.78	139.9
64QAM $\frac{2}{3}$	26.38	24.5	21.83	18.47	141.7
16QAM $\frac{3}{4}$	18.89	17.54	15.63	13.22	146.2
16QAM $\frac{1}{2}$	12.59	11.69	10.42	8.82	149.1
QPSK $\frac{2}{3}$	8.39	7.79	6.95	5.88	155.7
QPSK $\frac{1}{2}$	6.3	5.85	5.21	4.41	156.9
BPSK $\frac{1}{2}$	2.7	2.51	2.23	1.89	163.8

Table 9 - 4.9 GHz variant – Aggregate Ethernet Throughput Rates

⁹ Data rates for the Lite version of the PTP 400 Series Bridge variants are 50% of the figures shown.

¹⁰ These data rates are reduced when AES Encryption or ARQ (Automatic Retransmission reQuest) are enabled.

¹¹ 4.9 GHz Variants do not have a Low Latency Mode

¹² AMOD link margin of 1.5dB applied



7 Installation

Motorola recommends that only qualified personnel undertake the installation of a PTP 400 Series Bridge solution.

7.1 Preparation

Before proceeding with the installation you should:

- Check the contents of all packages against the parts lists shown in the packing list.
- Ensure that you have the correct tools for the job.
- Ensure that you are qualified to undertake the work.
- Ensure that you have taken the correct safety precautions.
- Have completed the site planning as described in section 6 “Site Planning”.

7.2 Installation Procedure

The installation procedure for a PTP 400 Series system consists of the following steps:

- Mounting the ODUs, section 7.6
- Connecting up, section 7.7
- Mounting the PIDU Plus units, section 7.7.6
- Powering Up, section 7.7.9
- Aligning the ODUs, section 7.7.10

7.3 Tools Required

The following specific tools are required to install the PTP 400 Series Bridge in addition to general tools:

- 13mm Spanner / Wrenche
- RJ45 Crimp Tool
- IBM Compatible Personal Computer (PC) running Windows 98 or later with 10 or 100baseT Ethernet (Ability to change IP settings easily is recommended)
- Either Internet Explorer version 6 or higher, or Mozilla Firefox v1.5 or higher are recommended.
- Ethernet patch cable
- 6mm general purpose crimp tool for the grounding lug (optional for lightning Protection)



7.4 Installation Support

Online installation support and contact details for your regional support can be found at <http://www.motorola.com/ptp>

A Frequently Asked Questions (FAQ) section can be found in section 16.

7.5 Legal Disclaimer

IN NO EVENT SHALL MOTOROLA, INC. BE LIABLE FOR ANY INJURY TO ANY PERSONS OR ANY DAMAGE CAUSED DURING THE INSTALLATION OF THE MOTOROLA PTP 400 SERIES PRODUCT.

7.6 Mounting the ODU_s

The ODU mounting bracket is designed to ease installation by fixing the bracket to the pole and then bringing the ODU into position using a single bolt fixing. The ODU should be mounted using the following steps ensuring that the cable entry is at the bottom:

The ODU mounting bracket is designed to work with poles with diameters in the range 50mm (2") to 75mm (3").



Step 1: Mount the bracket to the pole.

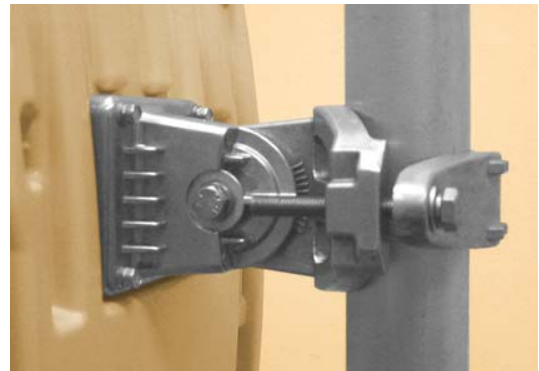

Step 2: Mate the unit to the bracket and tighten the nut and bolt.

Pole diameters of 25mm (1") to 50mm (2") can be accommodated by inverting the back of the bracket as shown in Figure 16.



Figure 16 - Mounting to pole diameters 25mm (1”) to 50mm (2”)

When adjustment is complete tighten all bolts to 14Nm (11 lb ft).



Warning: Do not over tighten the bolts as bracket failure may occur.

The enclosure and mounting brackets of the PTP 400 Series Bridge are capable of withstanding wind speeds up to 150mph (242kph). The installer should ensure that the structure to which the bridge is fixed is also capable of withstanding the prevalent wind speeds and loads. See Section 12 “Wind Loading”.



The integral safety loop should be used both for hoisting the ODU up a mast or building and into position, and also as a fixing point to secure a permanent safety lanyard from the tower/building to the ODU in case of mounting failure.

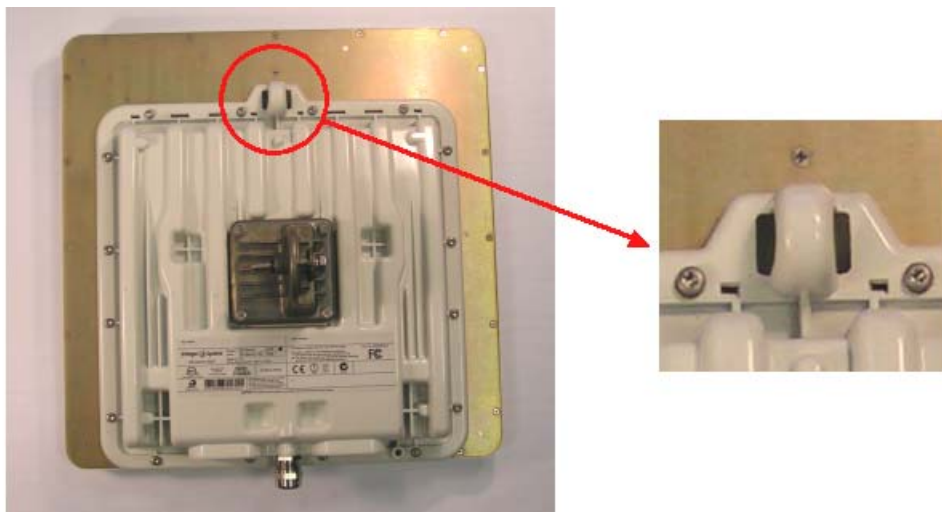

Figure 17 - Integral Safety Loop

The length of the safety lanyard must not exceed 1m (approx 3 ft) in length. The lanyard should be made from a material that does not degrade in an outdoor environment.

The safety lanyard must be fixed to a separate fixing point that is not part of the direct mounting system for the ODU.

7.7 Connecting Up

7.7.1 Preparing The Cable — RJ45 connections

Cables should be prepared using the following instructions along with the cable and connector supplier's instructions:



Step 1: Assemble gland Step on cable as shown

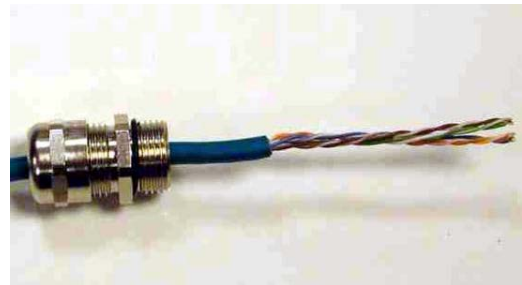

Step 2: Strip the outer insulation



Step 3: Arrange conductors as shown in Figure 19 and cut to length



Step 4: Insert conductors and crimp



Figure 18 - Completed ODU connector

Both ends of the ODU cable are terminated in the same way. The above procedure should be repeated for the PIDU Plus end of the cable when the cable routing process is complete.

Note: The PIDU Plus end of the cable does not employ a cable gland.

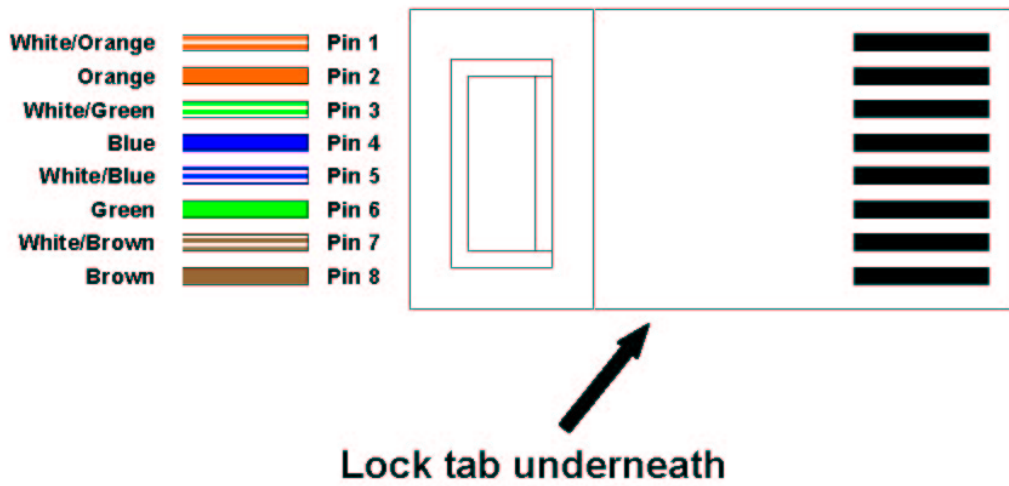

Figure 19 - RJ45 Pin Connection

7.7.2 Making the Connection at the ODU

The following procedure describes how connection is made at the ODU. It is often easier to carry out this procedure on the ground or a suitable surface prior to mounting the ODU.

Ensure no power is connected to the PIDU Plus or present on the cable before connecting the ODU.



Step 1: Assemble the cable as described in 5.7.1 above

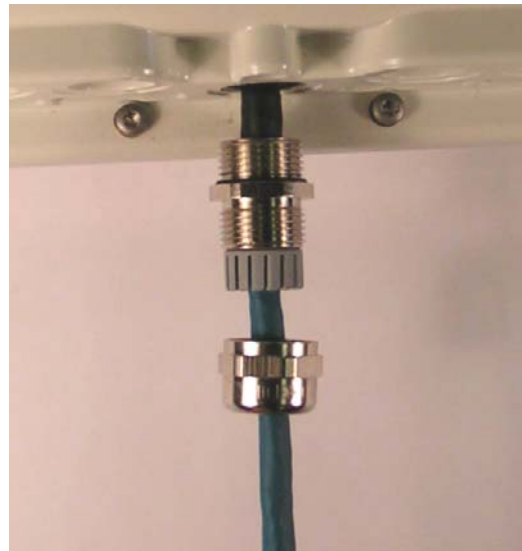

Step 2: Insert the RJ45 connector making sure that the locking tab snaps home

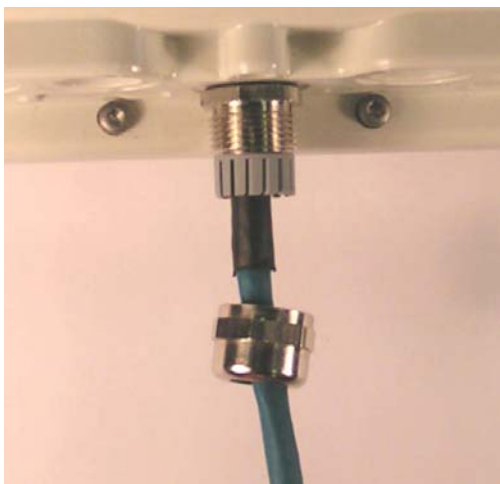

Step 3: Screw in the body of the weather proofing gland and tighten

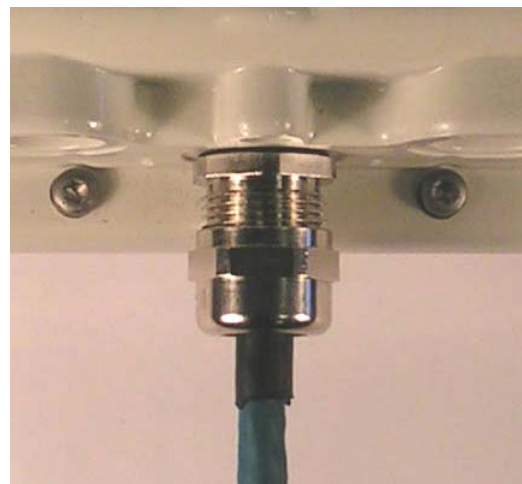

Step 4: Screw on the clamping nut and tighten

Figure 20 - Connections at the ODU

Should it be necessary to disconnect the PIDU Plus to ODU cable at the ODU this can be achieved by removing the weather proofing gland and depressing the RJ45 locking tab with a small screwdriver as shown below:

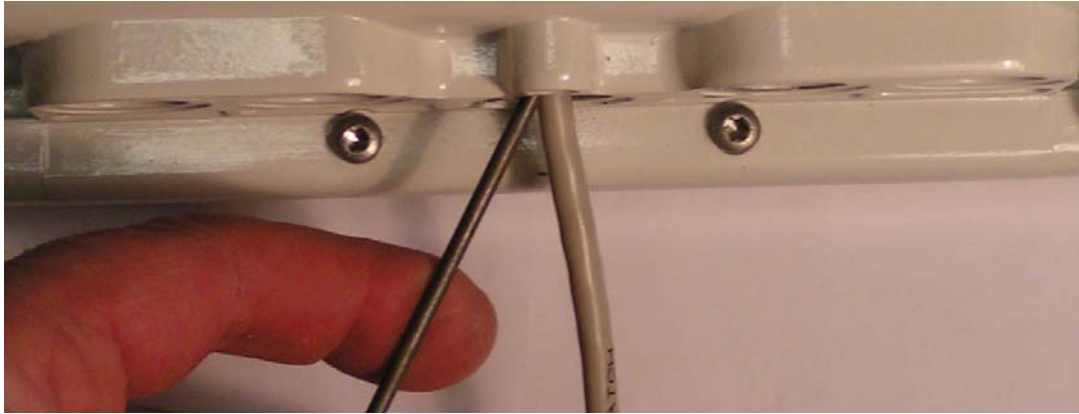

Figure 21 - Disconnecting the ODU



Warning: Ensure that power is removed from the system at the PIDU Plus to prevent damage to the ODU while making or breaking the connection.

7.7.3 Routing the Cable

After connecting the cable to the ODU it can be routed and secured using standard cable routing and securing techniques. When the cable is in place it can then be cut to the desired length at the PIDU Plus prior to connection to the PIDU Plus.

7.7.4 Fitting A Surge Arrestor

If you have opted to fit a Surge Arrestor, this should be installed by following the manufacturer's instructions. For recommended types see Section 11 "Lightning Protection"

7.7.5 Grounding the Installation

The Outdoor Unit (ODU) for the PTP 400 Series Bridge must be properly grounded to protect against power surges. It is the user's responsibility to install the equipment in accordance with Section 810 of the National Electric Code, ANSI/NFPA No.70-1984 or Section 54 of the Canadian Electrical Code or the National Electrical Code in the country of installation. These codes describe correct installation procedures for grounding the outdoor unit, mast, lead-in wire and discharge unit, size of grounding conductors and connection requirements for grounding electrodes. It is recommended that installation of the outdoor unit be contracted to a professional installer. See Section 11 "Lightning Protection" for recommended grounding kits. Failure to follow these Lightning Protection recommendations will invalidate your warranty if damage to the system is found to be caused by lightning.

7.7.6 Making the ODU Connection at the PTP 400 Series Bridge PIDU Plus

The ODU is connected to the PIDU Plus by means of a concealed RJ45 connector. The RJ45 connection has been placed inside the PIDU Plus hinged cover to prevent the user inadvertently plugging other equipment into the ODU RJ45 socket.



Warning: Plugging other equipment into the ODU RJ45 socket may damage the equipment due to the non-standard techniques employed to inject DC power into the 100BaseT connection between the PIDU Plus and ODU. Plugging the ODU into other equipment may damage the ODU and/or the other equipment.



Step 1: Undo the retaining screw and hinge back the cover.



Step 2: Plug in the ODU to PIDU Plus Cable ensuring that it snaps home



Step 3: Replace the cover and secure with the retaining screw

7.7.7 Making the Network Connection at the PIDU Plus – PTP 400 Series

The Network connection is made by connecting the user's Network Equipment directly to the PIDU Plus LAN port as shown in Figure 22.



Figure 22 - Making the Network Connection at the PTP 400 Series Bridge PIDU Plus



7.7.8 Mounting the PTP 400 Series Bridge PIDU Plus

Motorola recommends that you mount the PIDU Plus on a wall or other suitable mounting surface. This prevents the unit from being knocked or kicked and can help maintain link availability. Ensure that the reset switch can be accessed when mounting the unit.



Step 1: Fix the PIDU Plus to the wall using the lugs provided.



Step 2: Make connections as per Section 7.7.6



WARNING: The PIDU Plus is not waterproof and should be mounted away from sources of moisture. If mounted outdoors, the unit should be mounted in a rain proof enclosure, preferably ventilated.

It is also recommended that you fit a drip loop on the PIDU Plus to ODU cable to ensure that any moisture that runs down the cable into the cabinet or enclosure cannot enter the PIDU Plus. As shown in Figure 23. The network connection and mains cable should be treated in the same way if there is a risk that they can carry moisture to the PIDU Plus.

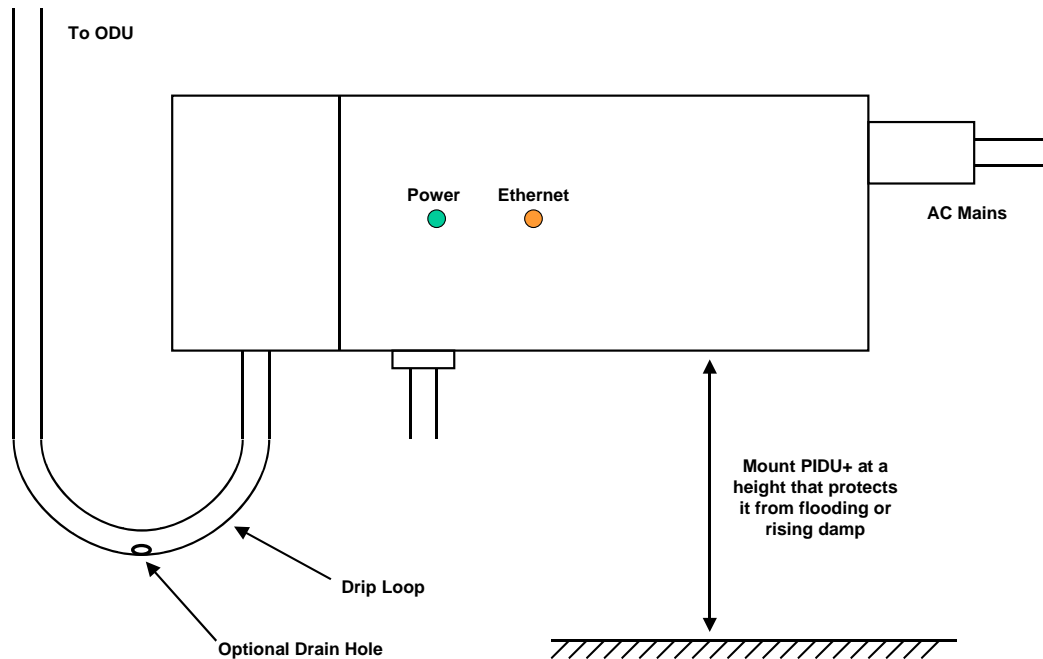

Figure 23 - PTP 400 Series Bridge PIDU Plus Drip Loop Configuration



WARNING: It is possible for moisture to enter the cable due to damage to the outer protective layer. This moisture can track down the inside of the cable, filling up the drip loop and eventually finding its way into the PIDU Plus. To protect against this the outer protective layer of the cable can be opened up at the bottom of the drip loop to allow this moisture to escape.



WARNING: Some network operators employ gel filled cables to get around the problem of moisture ingress and transmission. The PTP 400 Series Bridge has NOT been tested using these cables. Use of gel filled cables may affect the performance of PTP 400 Series Bridges.



7.7.9 Powering Up

The PTP 400 Series Bridge is supplied as a pair of matched Master/Slave units. The Master unit to be configured can now be powered up and accessed using the default URL <http://169.254.1.2/>; the Slave unit can be accessed using <http://169.254.1.1/>

Prior to powering up the PTP 400 Series Bridge, a computer with web browsing capabilities should be configured with an IP address of 169.254.n.n and subnet mask of 255.255.0.0 where n is any value between 1 and 254 but excluding 1.1 or 1.2. If the default addresses of the unit 169.254.1.1/2 clashes with an address you are already using on your LAN, or you are not sure, you should set up an isolated LAN. As the LAN connection presented at the PIDU Plus has a default configuration as a hub/switch (and auto-sensing MDI/MDIX cross over is employed) connection can be made directly to the computer using a standard CAT 5 patch cable.

Before physical installation takes place the units to be installed should be set up as described in the section 8.3.5. This process will give the installer the opportunity to set the unit's IP address to one that is in the desired address range and set each unit up with the MAC address of its peer unit ready to establish a radio link. It is recommended that this procedure be carried out on the bench before physical installation commences. Providing it is safe to do so the installer should take the process to the point where a radio link is established before proceeding to the installation site.



NOTE: It is possible that some units may not be accessed using the above default URL. This is because these units may have been previously configured with IP addresses 10.10.10.10 (Slave) and 10.10.10.11 (Master). Therefore, users must use the URL <http://10.10.10.10/> and/or URL <http://10.10.10.11/> to configure the units. Please ensure that a computer with web browsing capabilities is configured with an IP address of 10.10.10.n, where n is any value between 2 and 254 but excluding 10 and 11, to configure these units.



7.7.10 Aligning the PTP 400 Series ODUs

The following is a description of the steps taken to establish a radio link between the two units forming the bridge and align the units for the best signal strength.

The PTP 400 Series Bridge uses audible tones during installation to assist the installer with alignment. The installer should adjust the alignment of the ODU in both azimuth and elevation until highest pitch tone is achieved¹³. The tones and their meanings are as follows:

State Name	Tone Description	State Description	Pitch Indication (Higher pitch = higher power)
Band Scan	Regular beep	Executing band scan	N/A
Scanning	Slow broken tone	Not demodulating the wanted signal	Rx Power
Synchronized	Fast broken tone	Demodulating the wanted signal	Rx Power
Registered	Solid tone	Both Master and Slave units exchanging Radio layer MAC management messages	Rx Power

Table 10 - Audio indications from the ODU

The term 'wanted signal' refers to that of the peer unit being installed.

In each of the states detailed above the unit should be aligned to give the highest pitch tone. It should be noted that if, when in the Synchronized or Registered state the tone varies wildly, you may be suffering from interference or a fast fading link. Installing in this situation may not give a reliable link. The cause of the problem should be investigated.

For the ease of alignment both Master and Slave units use the install tones in the same way but with some small behavioral differences. This allows the installer to install the Slave unit first and carry out the initial alignment with the Master unit if desired. However due to the Behavioral differences of Master and Slave units it is recommended that the Master unit is installed first and the initial alignment carried out at the Slave unit.

¹³ The pitch of the alignment tone is proportional to the power of the received wireless signals. The best results are usually achieved by making small incremental movement in angular alignment.



The following behavior should be noted:

When first started up and from time to time the Master unit will carry out a band scan to determine which channels are not in use. During this time, between 10 and 15 seconds, the Master unit will not transmit and as a consequence of this neither will the Slave unit. During this time the installation tone on the master unit will drop back to the band scan state and the Slave unit will drop back to Scanning state with the pitch of the tone set be the background noise level. Alignment of the unit should cease during this time.

The master unit can take between 30 seconds in 0-5km (0-3 miles) mode to 300 seconds in 0-200km (0-124 miles) mode to determine the range of the link being installed¹⁴. The Master unit will remain in the Scanning state until the range of the link has been established. The Master unit will only move to the Synchronized state when the range of the link has been established.

If at the end of the ranging period the 'Registered' state is not achieved due to interference or other reasons, the Master unit will retry twice more on the same channel before moving to another available channel. Should this occur it might take a number of minutes to establish a link in the 'Registered' state.

The Slave unit does not have a ranging process. The slave unit will change to the Synchronized state as soon as the wanted signal is demodulated.



When the alignment process is complete the installer **MUST REMEMBER TO DISARM BOTH UNITS** in the link as described in section 8.3.5. This is necessary for the following:

- Turn off audible alignment aid.
- Enable Adaptive Modulation
- Fully enable Dynamic Frequency Selection
- Clear unwanted installation information from the various systems statistics
- Store the link range for fast link acquisition on link drop
- Enable Higher Data Rates

¹⁴ If the unit is operating where mandatory radar avoidance algorithms are implemented the ranging behavior for the 400 Series Bridge may be affected. The Master has to monitor the initially chosen channel for 60 seconds to make sure it is clear of radar signals before transmitting. If radar is detected during any of the installation phases a further compulsory 60 seconds channel scan will take place as the master unit attempts to locate a new channel that is free of radar interference.



The units will automatically disarm after 24 hours.

8 Web Page Reference

The web user interface has three main sections. The home page presents to the operator a high level summary of the PTP 400 Series Bridge point-to-point wireless link. The status page presents a more detailed set of system parameters describing the performance of the wireless link together with other key system performance metrics. The final section is the system administrator section. This section is password protected and allows the system administrator to perform all the day-to-day administrative procedures, e.g. software upgrades and configuration changes.

The following subsections give a detailed usage guide for all the web user interfaces. All the web pages are best viewed using a screen resolution of at least 1024 x 768 pixels on a PC using Microsoft Internet Explorer version 6¹⁵.

The navigation bar on the left hand side of the web page (Figure 24) is used to move between the various management pages.

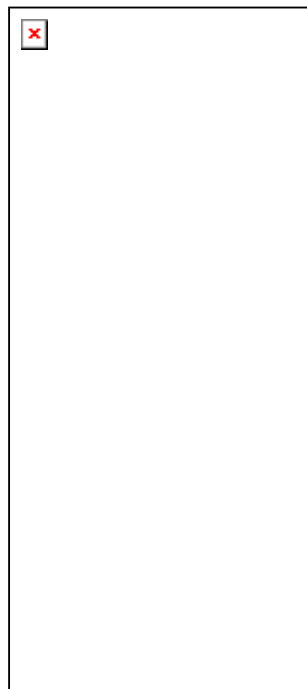

Figure 24 - Menu Navigation Bar

¹⁵ The web pages have also been tested with Mozilla Firefox 1.5. Other browsers may function correctly but have not been tested.



The currently selected page is always highlighted with a light blue background. The menu is hierarchical selecting any menu item which has associated submenu options will automatically display all sub options.

8.1 Home Page – PTP 400 Series Bridge

The home page for the PTP 400 Series Bridge has been designed to display a high level summary of the status of the wireless link and associated equipment. The home page (Figure 25) normally displays four key system attributes:

Wireless Link Status: The Wireless Link Status attribute as the name suggests displays the current status of the wireless link. A state of 'Up' on a green background indicates that a point-to-point link is established. A state of 'Down' on a red background indicates that the wireless link is not established. If the link is down for an unknown reason the system administrator should first consult the status web page for a more detailed summary of up to date system diagnostics.

Link Name: The link name attribute is a name and/or handle allocated by the system administrator to aid the identification of the unit, network or building.

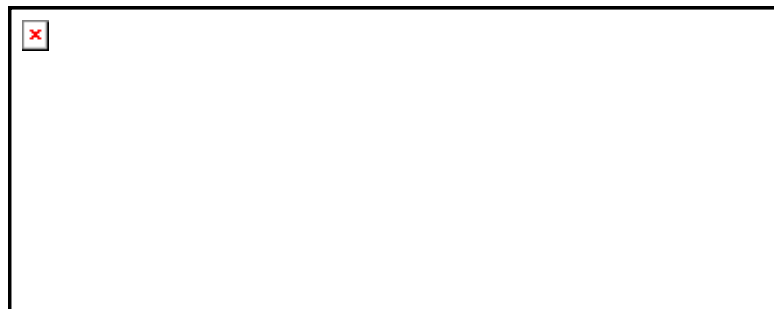

Figure 25 - PTP 400 Series Bridge Home Page

Elapsed Time Indicator: The elapsed time indicator attribute presents the total time in days, hours, minutes and seconds since the last system restart. The system can restart for several reasons, e.g. commanded reboot from the system reboot webpage, or a power cycle of the equipment.

System Clock: If the SNTP (Simple Network Time Protocol) (see section 8.3.13) is enabled a system clock attribute is displayed giving the date and time of the last page refresh. If SNTP is disabled then the system clock attribute is not displayed on the home page.

8.1.1 Home Page Alarm Display

The home page is also used to display all outstanding major system alarms. Whenever system alarms are asserted, a yellow warning triangle is displayed on the web page navigation bar. The warning triangle will be visible from all web pages. Clicking the warning triangle will cause the web page to jump back to the system home page. Figure 26 shows a sample alarm screen.

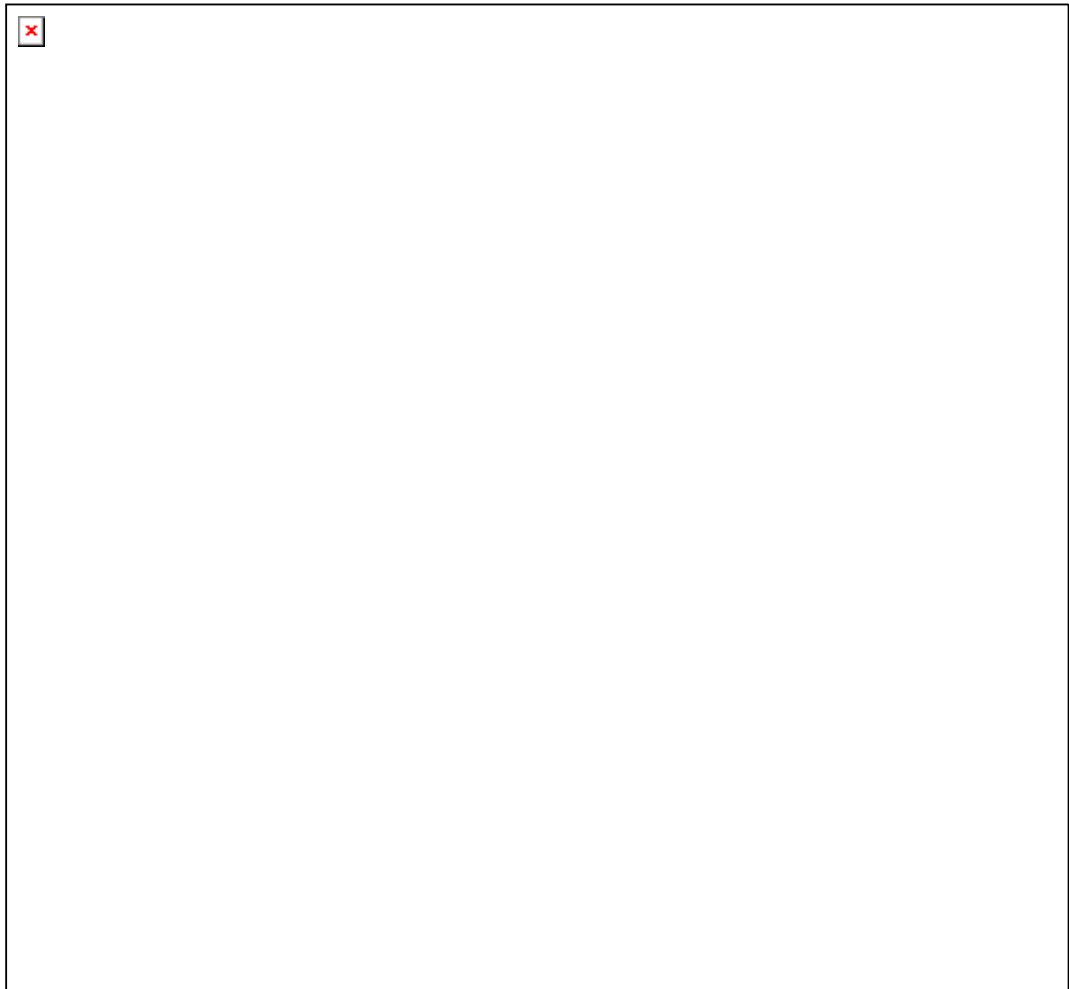

Figure 26 - Alarm Warning Triangle

The following major system alarms are defined:

Install Arm State: The Install Arm State alarm is displayed. This alarm warns when a wireless unit is in installation mode. After installation the wireless unit should be disarmed. This will increase the wireless link's data-carrying capacity and stop the installation tone generator. The wireless link is disarmed from the 'Installation Wizard' see section 8.3.5.



Install Status: If any errors are detected during the installation process, the unit will automatically raise an audible alarm. The install status alarm will be raised with an appropriate reason code, e.g. the alarm will be raised if an incorrect target MAC address is specified for the peer PTP 400 Series Bridge wireless unit.

ARQ Is Not Configured: ARQ must be enabled on both ends of the Point-to-Point link. This error message is generated if there is a mismatch in the ARQ settings between both ends of the link.

Encryption Is Not Configured On Both Units: Encryption must be enabled on both ends of the Point-to-Point link before the over-the-air packets can be successfully decrypted. This error message is generated if encryption is not configured on both units.

Ethernet Link Status: If there are any problems with the Ethernet interface this alarm will be asserted. This alarm will most likely be seen if the unit has not got an Ethernet cable plugged into its Ethernet socket.

Master And Slave Have Incompatible Region Codes: The PTP 400 Series Bridge uses region codes to comply with local regulatory requirements governing the transmission of wireless signals. Region codes can only be changed by obtaining a new PTP 400 Series Bridge license key. If this alarm is encountered the appropriate license keys from the country of operation should be obtained from your distributor. Applying license keys containing the same region codes to both ends of the link will remove the alarm.

Spectrum Management Channel Warning: The alarm warns a user when the intelligent spectrum management feature can't find a suitable wireless channel. This alarm occurs when the signal assessment features of the PTP 400 Series Bridge can't find a channel to operate on.

Ethernet Configuration Mismatch: The detection of Ethernet fragments (runt packets) when the link is in full duplex is an indication of an auto-negotiation or forced configuration mismatch.

Wireless Link Disabled Warning: Wireless traffic has been disabled via the SNMP ifAdminStatus attribute.

SNTP No Sync Warning: This warning indicates that SNTP has been enabled but that the unit is unable to synchronize with the specified SNTP server. Section 8.3.13 explains how to configure SNTP.

8.2 System Status Page

The status page has been designed to give the system administrator a detailed view of the operation of the PTP 400 Series Bridge from both the wireless and network perspectives.

The page is subdivided into three main categories Equipment, Wireless and Ethernet/Internet. The 'Equipment' section contains the entire unit's inventory and identification information. The 'Wireless' section presents the key wireless metrics displayed as a series of measurements and histograms. The 'Ethernet/Internet' section describes the unit's network identity and connectivity.

The status page can be configured to refresh itself at an operator defined rate (if the user is logged in as system administrator). The refresh period defaults to 3600 seconds and can easily be changed to refresh at any period between 2 seconds and 3600 seconds. Pressing the 'Update Page Refresh Period' button causes a new page refresh period to be adopted by the system. The page refresh mechanism uses a HTML Meta refresh command. Therefore the refresh is always initiated by the local browser and not by the PTP 400 Series Bridge at this interval.



Figure 27 - Status Page



The two PTP 400 Series Bridges are arranged in a master and slave relationship. The roles of the units in this relationship are displayed in the page title. The master unit will always have the title '- Master', and the slave will always have the '- Slave' appended to the 'Systems Status' page title.

The following section details all the attributes displayed on the status page:

Link Name: The link name is allocated by the system administrator and is used to identify the equipment on the network. The link name attribute is to a maximum size of 63 ASCII characters.

Link Location: The link location is allocated by the system administrator and can be used as a generic scratch pad to describe the location of the equipment or any other equipment related notes. The link location attribute is limited to a maximum size of 63 ASCII characters.

Software Version: The attribute describes the version of software installed on the equipment. The format of the attributes is *FFPP-XX-YY* where *FF* is the frequency variant (4.9, 5.8 or 5.4 GHz), *PP* is the product variant, *XX* is the major release version and *YY* is the minor release version.

Hardware Version: The hardware version attribute contains all the combined hardware version information. The attribute is formatted as *DX-RYY-Z* where *DXX* contain the version of the digital card, *RYY* contains the version of the RF (radio frequency) card and *Z* describes the antenna type which can be I (integrated) or C (connectorized).

Region Code: The region code is used by the system to constrain the wireless to operate within the regulatory regime of the particular country. The region code is encoded in the product license key. If the operator wishes to change the region code, a new license key must be obtained from Motorola or the local distributor / system integrator.

Elapsed Time Indicator: The elapsed time indicator attribute presents the total time in years, days, hours, minutes and seconds since the last system restart. The system can restart for several reasons, e.g. commanded reboot from the system reboot web page, or a power cycle of the equipment.

Ethernet Link Status: Current status of the Ethernet link. A state of 'Up' with a green background indicates that an Ethernet link is established. A state of 'Down' with a red background indicates that the Ethernet link is not established.

Ethernet Speed: The negotiated speed of the Ethernet interface specified in Mbps.

Ethernet Duplex: The negotiated duplex of the Ethernet interface.



Full Duplex: Full Duplex data transmission means that data can be transmitted in both directions on a signal carrier at the same time. For example, on a local area network with a technology that has full duplex transmission; one workstation can be sending data on the line while another workstation is receiving data.

Half Duplex: Half Duplex data transmission means that data can be transmitted in both directions on a signal carrier, but not at the same time. For example, on a local area network using a technology that has half duplex transmission, one workstation can send data on the line and then immediately receive data on the line from the same direction in which data was just transmitted.

MAC Address: The Medium Access Control Layer (MAC) address is used to uniquely identify the equipment on an Ethernet network.

IP Address: Internet Protocol (IP) address. This address is used by the family of Internet protocols to uniquely this identify the unit on a network

Subnet Mask: A subnet allows the flow of network traffic between hosts to be segregated based on a network configuration. By organizing hosts into logical groups, subnetting can improve network security and performance.

Gateway IP Address: The IP address of a computer on the current network that acts as a gateway. A gateway acts as an entrance / exit to packets from / to other networks.

Wireless Link Status: As the attribute name suggests, this displays the current status of the wireless link. A state of 'Up' on a green background indicates that a Point-to-Point link is established. A state of 'Down' on a red background indicates that the wireless link is not established. If the link is down for an unknown reason the system administrator should first consult the status webpage for a more detailed summary of the prevailing system diagnostics.

Target Receive Modulation Mode: The target modulation mode is used by the wireless subsystem to control the adaptive modulation algorithm. The mode is used by the PTP 400 Series Bridge as an upper limit. The system will not move to a high rate modulation mode even if the signal / interference environment will support high rate modes.

Maximum Transmit Power: The maximum Transmit Power the local wireless unit is permitted to use to sustain a link.

Remote Transmit Maximum Power: The maximum transmit power the remote wireless unit is permitted to use to sustain a link.



Transmit Power: Transmit power histogram¹⁶ is expressed in dBm and presented as: max, mean, min, and latest.

Receive Power: Receive power histogram is expressed in dBm and presented as: max, mean, min, and latest.

Vector Error: The vector error measurement compares the received signal's In phase / Quadrature (IQ) modulation characteristics to an ideal signal to determine the composite error vector magnitude. The results are stored in a histogram and expressed in dB and presented as: max, mean, min and latest. The expected range for Vector Error would be approximately 0dB (NLOS link operating at sensitivity limit on BPSK 1/2) to -29dB (short LOS link running 64QAM 7/8).

Link Loss: The link loss is the total attenuation of the wireless signal between the two point-to-point units.

¹⁶ All histograms are calculated over a one hour period. If the equipment has been running for less than one hour then the histograms are calculated over the current elapsed time.

The data used to compute the histogram statistics can be downloaded in an ASCII comma separated value (CSV) format via the diagnostics CSV Download page, see section 8.3.14 "Diagnostics".



The link loss calculation presented below:

$$P_{ll} = P_{T_x} - P_{R_x} + g_{T_x} + g_{R_x}$$

Where

P_{ll}	Link Loss (dB)
P_{T_x}	Transmit power of the remote wireless unit (dBm)
P_{R_x}	Received signal power at the local unit (dBm)
g_{T_x}, g_{R_x}	Antenna gain at the remote and local units respectively (dBi). The antenna gain of the PTP 400 Series Bridge is used unless one or both of the units is a Connectorized version. See Section 11.3 for more details

Equation 2 - Link Loss

Receive Data Rate: The data rate in the receive direction, expressed in Mbps and presented as: max, mean, min, and latest histogram format.

Transmit Data Rate: The data rate in the transmit direction, expressed in Mbps and presented as: max, mean, min, and latest histogram format.

Receive Modulation Mode: The modulation mode currently being used on the receive channel. The number in brackets after the modulation mode and coding rate string is the effective data rate available to all MAC layer protocols.

Transmit Modulation Mode: The modulation mode currently being used on the transmit channel. The number in brackets after the modulation mode and coding rate string is the effective data rate available to all MAC layer protocols.

Receive Modulation Mode Detail: The receive modulation mode detail presents to the user the reason why the wireless link is not operating at the maximum capacity (modulation mode). Values that can be presented in this field are:



- **Running at maximum receive mode:**
The wireless link is operating at its receive maximum capacity. To confirm that the wireless link is operating at its maximum transmit capacity either look at the 'Transmit Modulation Mode' on this page or look at the peer wireless units 'Receive Modulation Mode Detail' attribute.
- **Running at user-configured Target Modulation Mode:**
This indicates that the wireless link could operate at a higher capacity but has been limited in modulation mode by the user from the configuration page.
- **Restricted because Installation is armed:**
During installation the wireless link is restricted to operate in a low order modulation mode (BPSK $\frac{1}{2}$). Disarming the wireless units after installation will allow the wireless link to adaptively select its own operational modulation mode.
- **Restricted because of byte errors on the wireless link:**
During normal operation the wireless link monitors its performance. If byte errors are detected during normal data transmission / reception the wireless unit automatically changes the active modulation mode to a more robust mode in order to reduce the number of errors.
- **Restricted because a DFS channel change is in progress:**
During Spectrum Management (DFS) channel changes the wireless unit temporarily reduces the modulation mode to BPSK $\frac{1}{2}$.
- **Restricted due to the low Ethernet link speed:**
If the Ethernet link speed is less than the instantaneous wireless link capacity then the modulation mode is optimized so that the Ethernet link speed is satisfied using the most robust modulation mode.
- **Limited by the wireless conditions:**
The wireless link capacity is limited by the current wireless conditions e.g. interference, excess path loss, etc...

Range: The range¹⁷ between the peer PTP 400 Series Bridge units.

Refresh Page Period:¹⁸ - The Status page refreshes automatically according to the setting entered here (in seconds).

¹⁷ The 400 Series Bridge displays range in km by default, if the user would prefer to display range using Miles the 'Distance Units' attribute should be set to imperial, see the "Properties" web page section 8.3.19

¹⁸ This option is only available to the System Administrator

8.3 System Administration Pages

The following menu options are available for the system administrator and can be password protected. Figure 28 shows the 'System Administration Login' page. By default a system admin password is not set. Simply click the login button to access the system administration features. Once the password has been set using the 'Change Password' menu item, the system administration pages will only be available after the user has entered the correct password.

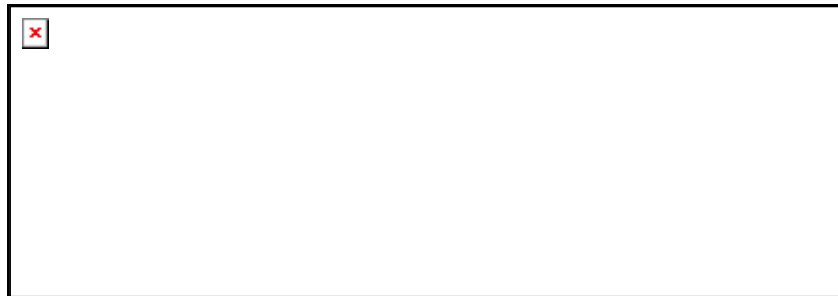

Figure 28 - System Administration Login Page

The features that are only available to the system administrator are:

- Configuration
- Statistics
- The Installation Wizard
- Software Upgrade
- Spectrum Management including DFS
- Remote Management
- Diagnostics Plotter including CSV Download
- Password Management
- License Key Management
- Properties
- System Reboot

8.3.1 System Configuration Page

The configuration page (Figure 29) is used by the system administrator to configure the PTP 400 Series Bridge.

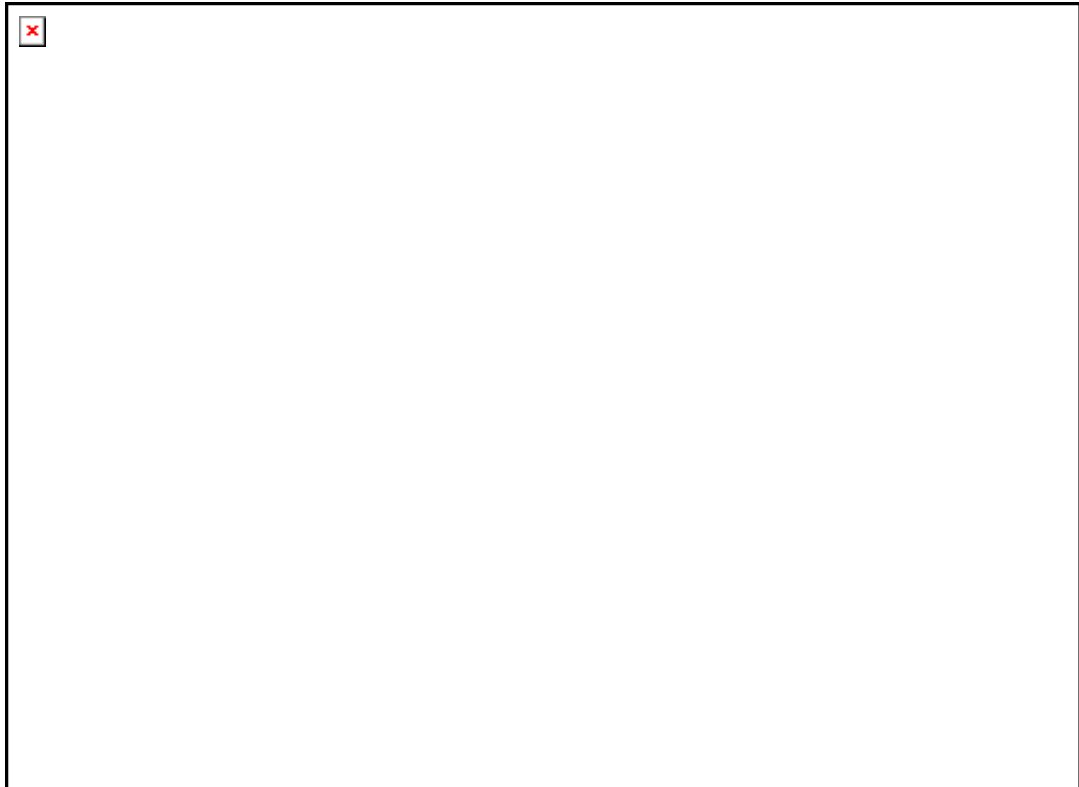

Figure 29 - Configuration Page

While the majority of the system configuration is entered during installation and should never require changing, this page offers the system administrator the ability to change the basic system parameters for link, modulation and physical components.

Link Name: User defined identity for the unit (max 63 characters).

Link Location: Can be used to describe the location of the equipment or any other equipment related notes (max 63 characters).

Master Slave Mode: The Master unit is the controlling unit with respect to the point-to-point link and its maintenance. The master transmits until the link is made, while the Slave listens for its peer and only transmits when the peer has been identified.



Link Mode Optimization: By default, Link Mode Optimization of a point-to-point link is set to 'IP Traffic'. In this configuration the wireless minimizes packet transmission errors by automatically adapting the active modulation mode based on instantaneous vector error measurements and the presence of codeword errors. This mode of operation is recommended for connection oriented IP traffic protocols where packet loss is perceived by the protocols as an indication of network congestion. It is recommended that when using this mode of operation the ARQ state is set to 'enabled'. The 'TDM Traffic' mode is recommended for E1 / T1 applications and connectionless oriented protocols. In this mode the wireless link is optimized for minimum transmission latency and preservation of data throughput by allowing the link to maintain a higher modulation mode in the presence of a limited number of codeword errors. It is recommended that when operating the link in TDM mode that the ARQ state is set to disabled and that the Spectrum Management controls are used to fix the wireless link to a single frequency. This can be achieved by using the installation wizard to configure single frequency operation. In either case, a system reboot will be required.

Link Symmetry: By default Link Symmetry of a point-to-point link is 'Symmetrical Data Rate (1:1)' in this configuration the ratio of time the wireless link spends transmitting and receiving is equal. When Link Symmetry is configured to Asymmetric Data Rate (2:1) the wireless link Master will spend twice as long transmitting as receiving. It should be noted that the data rate available to the end users might not follow these ratios exactly. The exact data rates will be dependant on the prevailing modulation modes.

Throughput Optimization: Throughput Optimization has two distinct modes:

- **Data Throughput** configures the wireless link for maximum data throughput.
- **Low Latency** configures the wireless link to minimize packet latency during transmission over the wireless link. When Low Latency mode is selected, the Link Symmetry is automatically reconfigured to a symmetric link. Link asymmetry is not supported in Low Latency mode.

Note: The "Throughput Optimization" option is not available on 4.9GHz variants.

ARQ State: Automatic Repeat reQuest (ARQ) is a mechanism where packets lost due to transmission errors over the wireless link are retransmitted rapidly. The retransmission helps to prevent TCP congestion mechanisms from inadvertently interpreting intermittent packet loss as network congestion. ARQ must be enabled on both ends of the point-to-point link for it to function.

Target Receive Modulation Mode: This is the maximum mode the unit will use as its adaptive modulation. The modulation modes available are:

- BPSK 1 / 2
- QPSK 1 / 2
- QPSK 2 / 3
- 16QAM 1 / 2
- 16QAM 3 / 4
- 64QAM 2 / 3
- 64QAM 3 / 4
- 64QAM 7 / 8

By default the Target Receive Modulation Mode is 64QAM 7/8. The value in brackets shows the maximum unidirectional data for the current modulation / ranging mode combination.

Maximum Transmit Power: This specifies the maximum transmit power in dBm of the system, it is country dependent and although the user can change this it will be limited to that country's regulations.

Ethernet Compression: When Ethernet compression is enabled all compressible Ethernet packets are transmitted over the wireless link using a compressed data format. This will have the net effect of increasing wireless link traffic throughput. Because the compression techniques used in the PTP 400 Series Bridge are CPU intensive, compression is only applied to modulation modes BPSK 1/2, QPSK 1/2 and QPSK 2/3. The net effect of compression is solely dependant on the individual packet compressibility (entropy). Random data will not produce good packet compression; however ASCII text and other non-random data sources will produce an acceptable level of compressibility.

All the above attributes are non-volatile. Once set they will be used by the unit even after a power-on reboot. A number of attributes, such as IP Address, Subnet Mask and Gateway IP Address will require a reboot before they are used. If any of these attributes are changed a reboot screen appears asking the user to verify the reboot. (See Figure 30)



Figure 30 - Configuration Reboot Page



Note: At this point you will lose connection to the unit. If you have just changed the IP Address you now have to reconnect to the unit using the address just set.

8.3.2 LAN Configuration Page

The LAN Configuration page (Figure 31) is used by the system administrator to configure the network parameters for the PTP 400 Series Bridge.

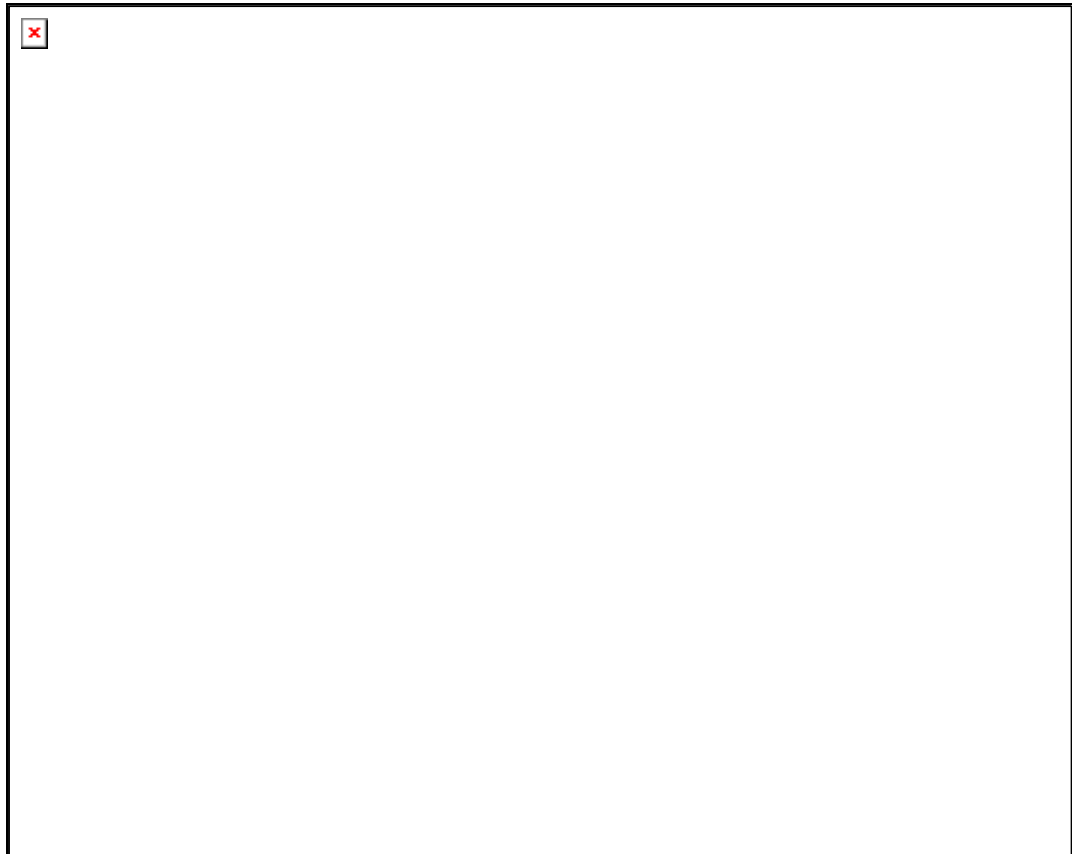

Figure 31 - LAN Configuration Page

IP Address: Internet protocol (IP) address. This address is used by the family of Internet protocols to uniquely identify this unit on a network.

Subnet Mask: A subnet allows the flow of network traffic between hosts to be segregated based on a network configuration. By organizing hosts into logical groups, subnetting can improve network security and performance.

Gateway IP Address: The IP address of a computer / router on the current network that acts as a gateway. A gateway acts as an entrance / exit to packets from / to other networks.



VLAN High Priority Traffic Threshold: If enabled, this sets the 802.1p VLAN user priority threshold at which bridged traffic will be treated as high-priority.

Use VLAN for Management Interfaces: If enabled, this allows the use of VLAN for Management Interfaces. Selecting this option presents the user with extra fields in which to enter the management VLAN ID, Priority and whether to validate the VLAN ID. The following warning message window is displayed when this option is enabled:

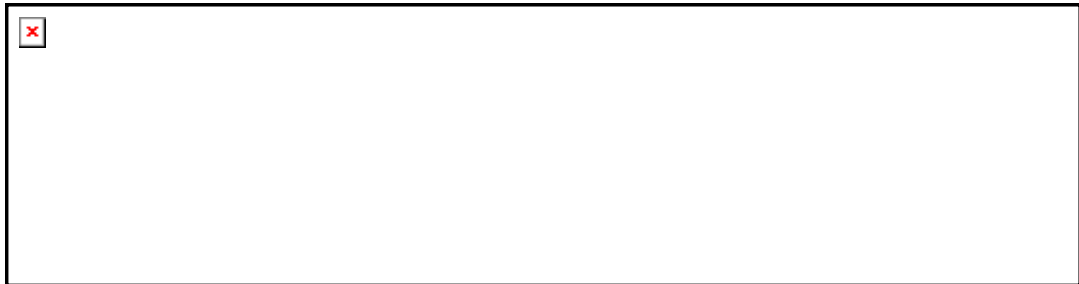

Figure 32 - VLAN Warning Window

After clicking on OK, the following VLAN options are added to the LAN Configuration window:



Figure 33 - Additional VLAN options

These parameters control whether the management interfaces (HTTP/SNMP/SMT/STP) use a VLAN. Selecting this option presents the user with extra fields in which to enter the Management VLAN ID, Priority and whether to validate the VLAN ID.

If communication with the unit is lost due to mis-configuration or the user forgot the VID that has been set. The unit can be recovered by resetting the unit to factory defaults as described in Section 3.3.2 “The PIDU Plus – ”.



Note: The internal Ethernet stack used to manage a unit does not support double VLAN tagged packets. Double VLAN tagged packets will be discarded.



Note: If you loose contact with your unit due to mis-configuration you will need to reset your unit to factory default as described in Section 3.3.2 “The PIDU Plus – ”



Ethernet Configuration: This enables the Ethernet configuration to be forced rather than auto negotiated. The configuration should only be forced if you are having problems with auto negotiation. You must ensure that you configure both this unit and the Ethernet port to which it is connected identically. If you force a fixed Ethernet Configuration on the PTP 400 Series Bridge, then you **MUST** also force the same fixed configuration on the equipment to which it is connected. If you fail to force the configuration of the connected equipment, its automatic configuration mechanisms will normally cause a duplex mismatch, and you will receive greatly reduced throughput!

Ethernet Auto Mdx: This enables/disables the Auto Medium Dependent Interface (MDI)/Medium Dependent Interface Crossover (MDIX) capability.

Drop Ethernet Link On Wireless Link Down: When enabled, this causes the Ethernet link to be dropped briefly when the Wireless link drops. This is so that spanning tree algorithms can quickly detect that there is a problem

Local Packet Filtering: When Local Packet Filtering is Enabled, the bridge learns the source MAC addresses of devices transmitting Ethernet packets on the local Ethernet network, and only bridges packets to the remote unit if the destination MAC address has not been learned as a 'local' device. When Local Packet Filtering is Disabled the bridge does not learn the source MAC addresses of devices transmitting Ethernet packets on the local Ethernet network, and bridges ALL Ethernet packets received to the remote unit. Local Packet Filtering should be enabled when no external switching/routing hardware is present.

8.3.3 Save and Restore Menu

The save and restore feature of a PTP 400 Series bridge allows the system administrator to backup the operation configuration of the wireless unit. It is recommended that this facility is used immediately after a successful PTP 400 Series bridge installation or prior to any software upgrade. In the unlikely event that a unit has to be replaced in the field, the replacement unit can be reconfigured by simply playing back the saved configuration file.

To save the configuration file click on the 'Save Configuration File' button (Figure 34 and Figure 35) and save the configuration file (.cfg) to the hard drive of your computer^{19, 20}.

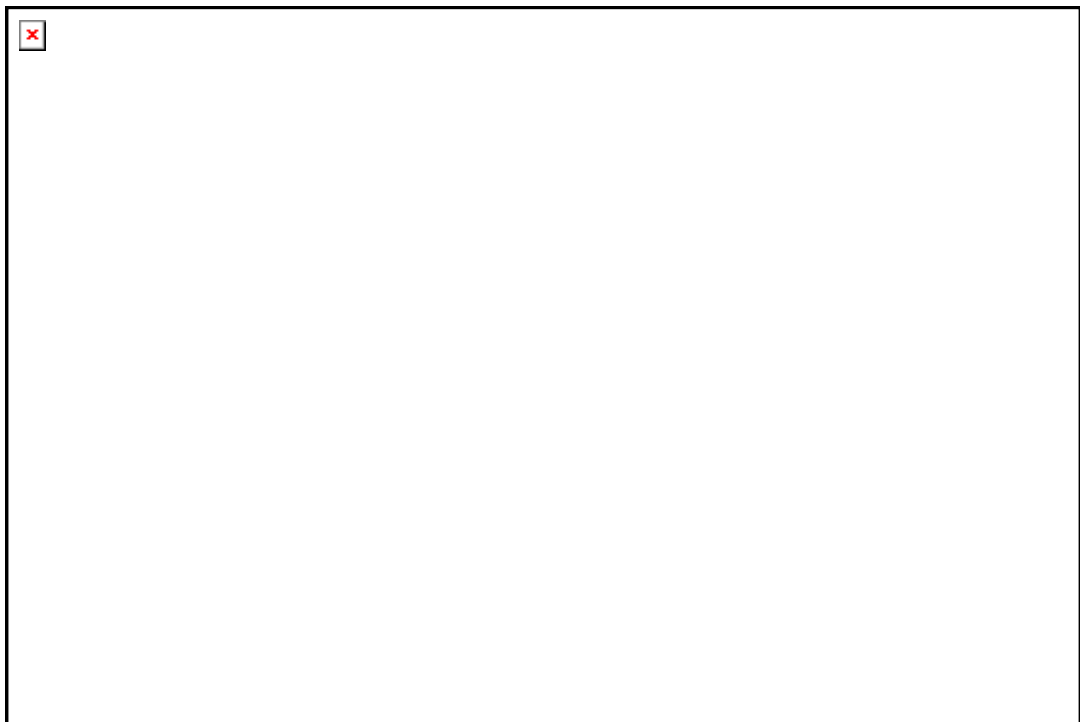

Figure 34 - Save and Restore Configuration Page

¹⁹ There is a feature of Internet Explorer (all versions) that will always look at the content of any downloadable file as make an assessment whether to treat the file as an ASCII or binary file. Unfortunately the configuration file is always treated as ASCII and the browser attempts to display it instead of downloading it. Firefox (all versions) makes no such assumptions.

²⁰ The configuration file name format is MAC-mm-mm-mm_IP-iii-iii-iii-iii.cfg where mm and iii are the lower 3 bytes of the MAC address and the unit IP address respectively.

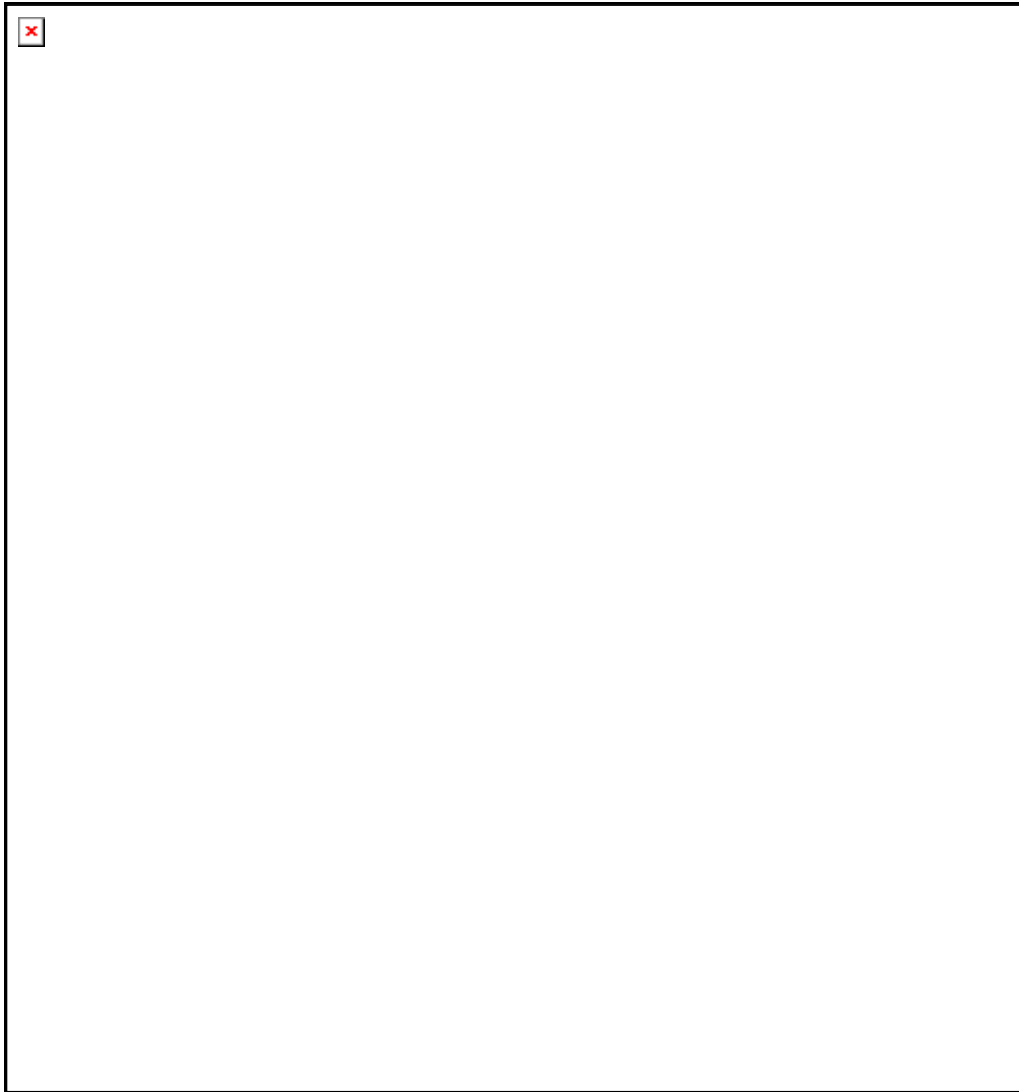

Figure 35 - Save Configuration File Screen



The configuration file is encoded using an ASCII encoding scheme. An example is show in Figure 36.

```
# Motorola PTP 400 Series Configuration file
#
# MAC Address      :- 00:04:56:00:20:a2
# IP Address       :- 169.254.1.1
# License Key      :- 3D3D-92D5-3FD3-1AF1
# Software Version :- 04-00
# Creation Date    :- 17-Nov-06 20:03:23
#
# To playback this configuration file into the unit, use the Save and Restore configuration
# webpage:
#
<config>+.BP9)7HC;O)DS.UNPAGUTLIHJ:","K.J"3F6'0*XR14+>) !3-MZ-VF
...
</config>
```

Figure 36 - Example Configuration File



WARNING: The configuration file is currently restricted to a single software version and can only be restored into a wireless unit operating the software version indicated in the configuration file header.

The configuration file can also be used when swapping out a faulty wireless unit. If one of the wireless units is replaced on a wireless link a configuration file captured from the faulty unit can be replaced into the new unit to speed up replacement. It should be noted that when placing a configuration file into a wireless unit with a different MAC Address the license key will not be restored and may need to be entered. This can be obtained either from the Quick Install guide supplied with replacement wireless unit or directly from Motorola. Please note that the target MAC address at the other end will need to change.



The restoration of configuration files can be performed using the Restore configuration tool. Using the browser button to locate the configuration file you wish to restore then click the 'Restore Configuration File and Reboot' button (Figure 37). The user will then be prompted to confirm the action (Figure 38).

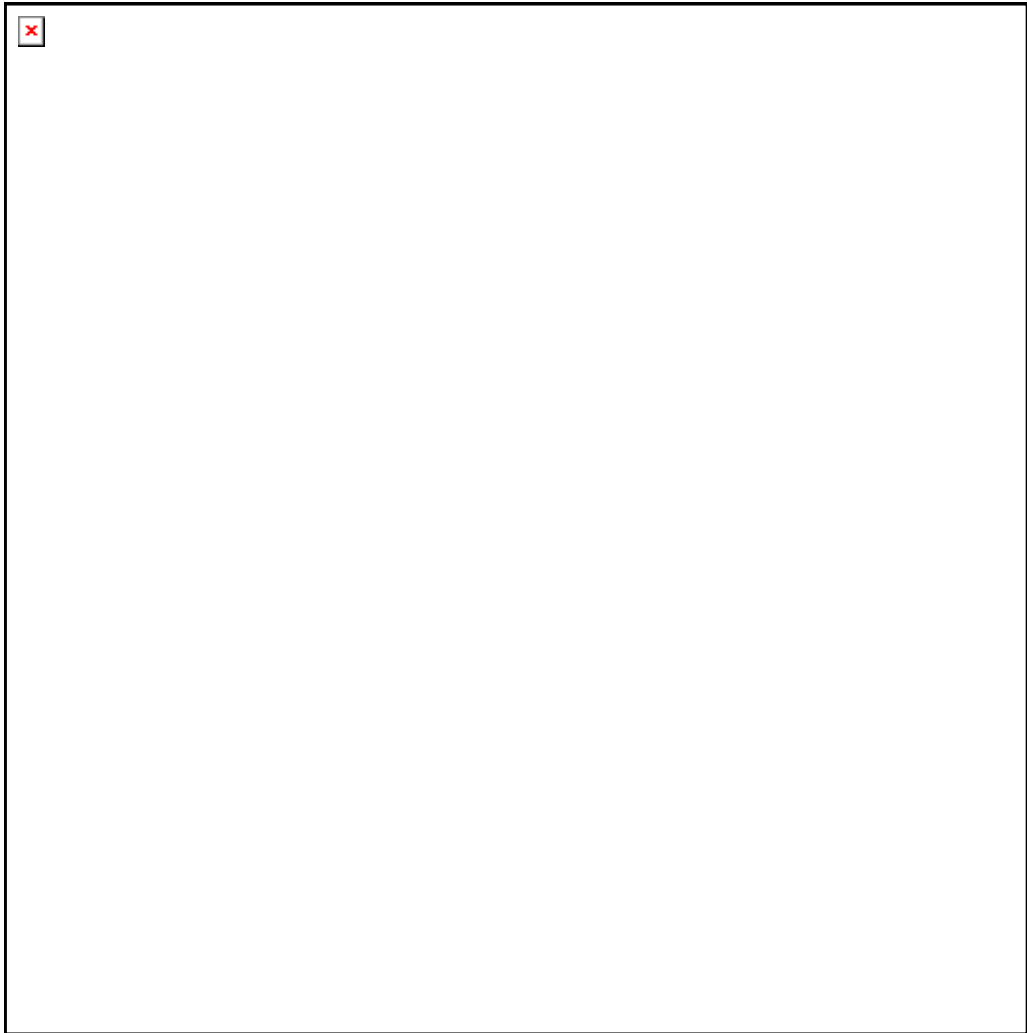

Figure 37 - Restore Configuration File Pop Up Screen

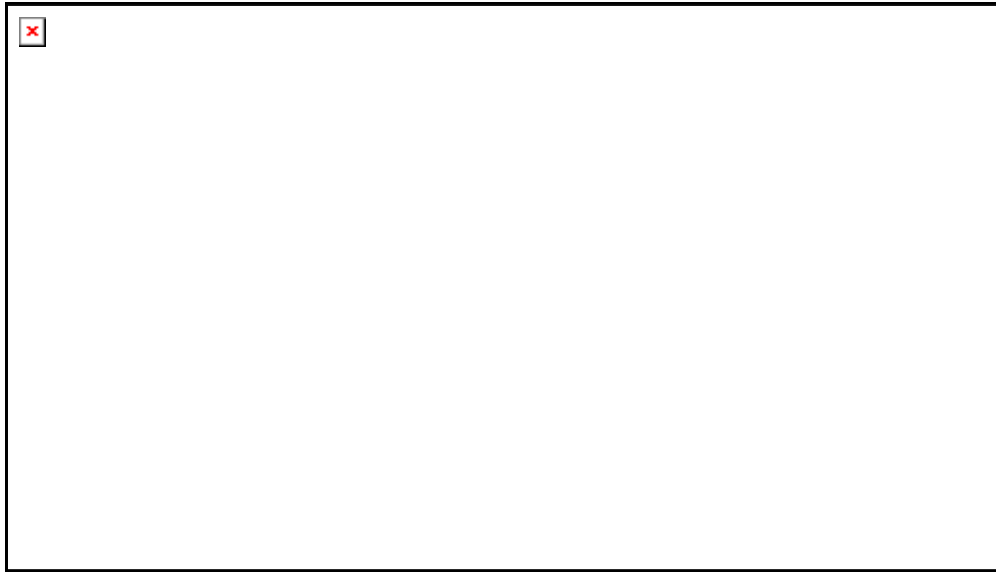

Figure 38 - Reset Configuration and Reboot Confirmation Pop-up

On confirmation the PTP 400 Series bridge will:

- Upload the configuration file
- Perform data integrity checking
- Erase previous configuration
- Apply the new configuration
- Restart

After the unit has restarted the entire configuration from the configuration file will now be active. Note: The IP address of the unit may have also been changed. The user can check the new IP address by reading the header of the configuration file, Figure 36.



WARNING: A reboot is always required to restore a configuration file.



8.3.4 Statistics Page

The PTP 400 Series Bridge statistics page is designed to display some key statistics of the Ethernet Bridge and the underlying wireless performance.

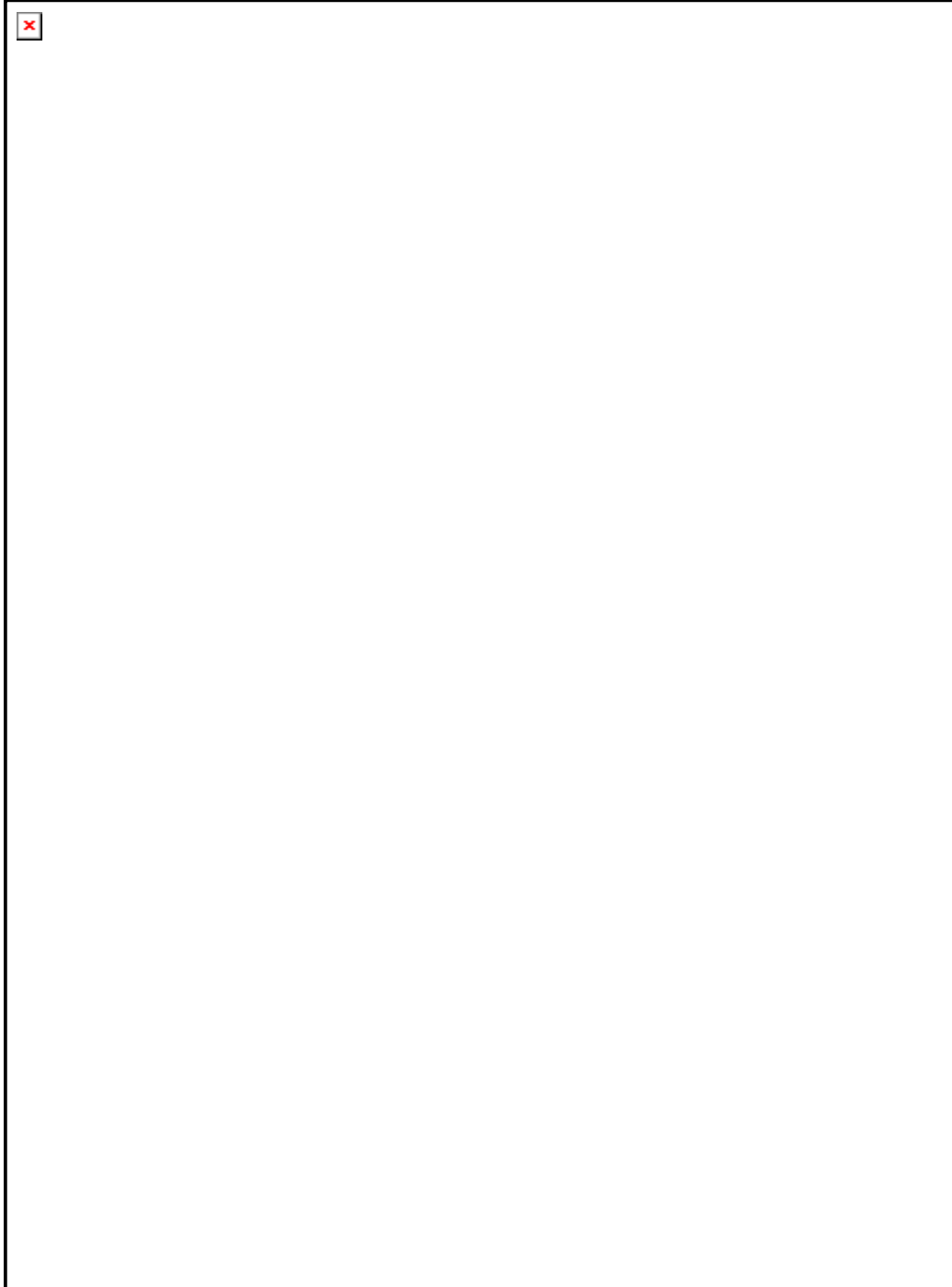

Figure 39 - System Statistics



Wireless Good Tx Packets: Total number of good packets the bridge has sent for transmission by the wireless interface²¹.

Wireless Good Rx Packets: Total number of good packets the bridge has received from the wireless interface (see note 21).

Packets To Internal Stack: This displays the total number of good packets the bridge has transmitted to the internal stack (e.g. ARP requests, PING requests, HTTP requests). See note 21.

Packets From Internal Stack: This displays the total number of good packets the bridge has received from the internal stack (e.g. ARP responses, PING replies, HTTP responses). See note 21.

Ethernet Rx Fragments: Total number of short frames (<64 bytes, sometimes called runts) received from the local Ethernet interface. On a half-duplex link, these packets are the result of collisions and are to be expected. If you have forced the Ethernet configuration to full-duplex and are getting such packets then you probably have a duplex mismatch (the device you have connected is running in half-duplex). See note 21.

L2 Source Mac Address Conflicts: The number of times a packet received over the wireless link had the Layer 2 (Ethernet) Source MAC Addresses of a device that had previously been transmitting on the 'local' Ethernet network. This could indicate the presence of a traffic loop or of L2 MAC Address spoofing on the network. See note 21.

ARQ Retransmitted Rx Packets: Total number of ARQ retransmitted packets that have been received. See note 21.

Transmit Data Rate: The data rate in the transmit direction, expressed in Mbps and presented as: max, mean, min, and latest histogram format. (See note 16)

The histogram is calculated over a one hour period. If the equipment has been running for less than one hour then the histogram is calculated over the current elapsed time.

Receive Data Rate: The data rate in the receive direction, expressed in Mbps and presented as: max, mean, min, and latest histogram format. See note 21.

Aggregate Data Rate: The aggregate data rate, expressed in Mbps and presented as: max, mean, min, and latest histogram format. See note 16.

²¹ The number in (+nn) displays the number of packets transmitted since the last page refresh.



Transmit Modulation Mode: Current active transmit modulation mode.

Receive Modulation Mode: Current active receive modulation mode.

Signal Strength Ratio: The Signal Strength Ratio, is the ratio of the power received by the Vertical / Horizontal receivers.

Wireless Link Availability: Expresses the link availability as a percentage of time since the first successful registration after a system restart. It is expressed as a percentage to four decimal places.

Code Word Error Ratio: The ratio of detected codeword errors to the total number of codewords since the last system counter reset.

PHY Code Word Error Counter: The wireless link uses error correction techniques to enable reconstruction of packets where there is a certain level of data corruption. This counter displays the total number of packets that were so badly corrupted that they could not be reconstructed. See note 21.

Elapsed Time Indicator: Elapsed Time Indicator is the time in days, hours, minutes and seconds since the wireless unit was last rebooted.

Statistics Page Refresh Period: The statistics page refreshes automatically according to the setting entered here (in seconds).

The two buttons described below are also displayed:

Reset System Counters: By pressing this button all counters in the system are reset to zero.

Reset System Histograms: All histograms are reset, and the calculation period is restarted.

8.3.4.1 Detailed Counters Page

The Detailed Counters Page provides:

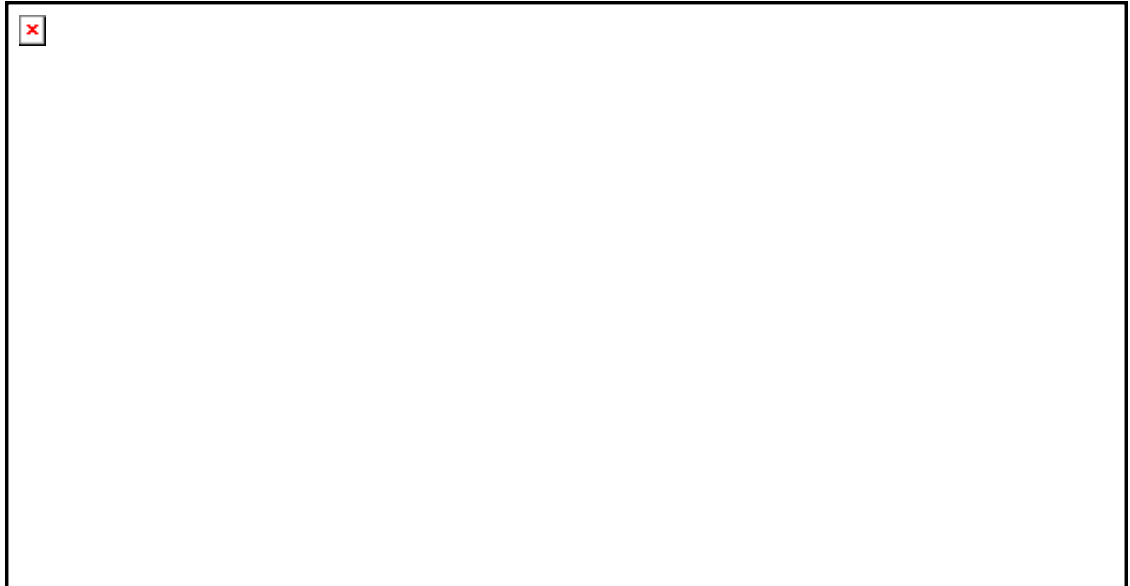

Figure 40 - Detailed Counters

Ethernet Good Rx Packets: Total number of good Ethernet packets transmitted to the local Ethernet interface. See note 21.

Ethernet Rx Fragments: Total number of short frames (<64 bytes, sometimes called runts) received from the local Ethernet interface. On a half-duplex link, these packets are the result of collisions and are to be expected. If you have forced the Ethernet configuration to full-duplex and are getting such packets then you probably have a duplex mismatch (the device you have connected to is running in half-duplex). See note 21.

Ethernet Bad FCS Rx Packets: Total number of Ethernet packets received from the local Ethernet interface that contained an invalid Frame Check Sequence (checksum). See note 21.

Ethernet Invalid Rx Packets: Total number of invalid Ethernet packets received from the local Ethernet interface See note 21.

Ethernet Good Tx Packets: Total number of good Ethernet packets transmitted to the local Ethernet interface. See note 21.

Ethernet Dropped Tx Packets: Total number of Ethernet packets that were bridged to the local unit but could not be transmitted because the local Ethernet link was down See note 21.



Packets To Internal Stack: Total number of good packets the bridge has transmitted to the internal TCP/IP stack. See note 21.

Packets From Internal Stack: Total number of good packets the bridge has received from the internal TCP/IP stack. See note 21.

L2 Source MAC Address Conflicts: The number of times a packet received over the wireless link had the Layer 2 (Ethernet) Source MAC Addresses of a device that had previously been transmitting on the 'local' Ethernet network. This could indicate the presence of a traffic loop or of L2 MAC Address spoofing on the network. See note 21.

Num ARQ Nacks Sent: Total number of ARQ requests sent.

Num ARQ Nacked Packets: Total number of ARQ Ethernet packets sent in reply to an ARQ request.

ARQ Retransmitted Rx Packets: Total number of ARQ retransmitted packets that have been received.

Statistics Page Refresh Period: Refresh the page at this rate

Wireless Good Rx Packets: Total number of good packets the bridge has received from the wireless interface. See note 21.

Wireless Bad Rx Packets: Total number of corrupt packets the bridge has received from the wireless interface See note 21.

Wireless Good Tx Packets: Total number of good packets the bridge has sent for transmission by the wireless interface. See note 21.

Wireless Dropped Tx Packets: Total number of packets that the local unit could not bridge to the remote unit because either the wireless link was down or because Ethernet packets are being received faster than they can be transmitted over the wireless link. See note 21.

Wireless Rx Bytes: Total number of bytes that were received by the wireless interface. See note 21.

Wireless Tx Bytes: Total number of bytes that were transmitted by the wireless interface. See note 21.

Wireless Tx Compressible Bytes: Total number of bytes which the system has attempted to compress - compression is dependant on modulation mode and packet size. See note 21.

Wireless Tx Compressed Bytes: Total number of compressed bytes sent by the wireless interface. See note 21.



Wireless Tx Uncompressed Bytes: Total number of 'compressible' bytes that were sent uncompressed by the wireless interface because compression was inefficient. See note 21.

Num ARQ Nacks Received: Total number of ARQ NACK packets received.

Num ARQ Nacked Packets Requested: Total number of NACKed packets requested to be retransmitted by ARQ.

Num ARQ Nacked Packets Requeued: Total number of NACKed packets still available in the ARQ buffer and successfully requeued by ARQ.



8.3.5 Install Wizard Pages

These pages are used during system installation. There follows a description of the install pages along with their use during the installation configuration process. The actual installation process is described in section 7.7.10 “Aligning the ODUs”.

All wireless links are shipped as paired units. They are pre-configured at the factory so that they can be installed without the user supplying any configuration. Each wireless link is shipped with a Quick Start Guide. Attached to the Quick Start Guide is a summary of the default configuration data. Table 11 shows a sample link configuration. The values **highlighted** have been committed to the wireless units non-volatile storage.

<u>Example PTP 400 Series Bridge Configuration Data</u>	
For your convenience these two units have been pre-configured as a link	
<u>Units:</u>	
ODU serial number	ODU serial number
0167800002BE	0167800002BF
Ethernet MAC address	Ethernet MAC address
00:04:56:00:02:BE	00:04:56:00:02:BF
<u>Configured as:</u>	
Master	Slave
Target MAC address	Target MAC address
00:04:56:00:02:BF	00:04:56:00:02:BE
License Key	License Key
A471-FE88-428D-E1F3	534F-4F54-D1B0-E2DA
IP Address	IP Address
169.254.1.2	169.254.1.1

Table 11 - PTP 400 Series Bridge Factory Configuration Values

The factory default configuration is written to the ‘semi-permanent’ configuration bank.



WARNING: The factory default configuration is limited in range to 40 Km (25 miles). If you wish to install a wireless link with a range of > 40 Km (> 25 miles) and < 200 Km (< 124 miles) you must follow the ‘Manually Configuring the Wireless Units’ in section 8.3.5.1.



8.3.5.1 Manually Configuring the Wireless Units

If the installer / system administrator wishes, they may modify the default installation configuration. If only the IP addresses are incorrect it is recommended that the values are changed via the configuration menu (Section 8.3.1). If any other parameters require modification then it is recommended that the system administrator use the Installation Wizard.

The operational software for the PTP 400 Series Bridge requires a license key to enable the wireless bridging capability and program region code specific parameters in to the unit.

Please refer to Section 8.3.18 for more information on how to enter and validate a license key into the unit.

8.3.5.2 Internet Protocol Configuration

Step 1 of the installation wizard requires the installer to enter the Internet Protocol (IP) configuration.

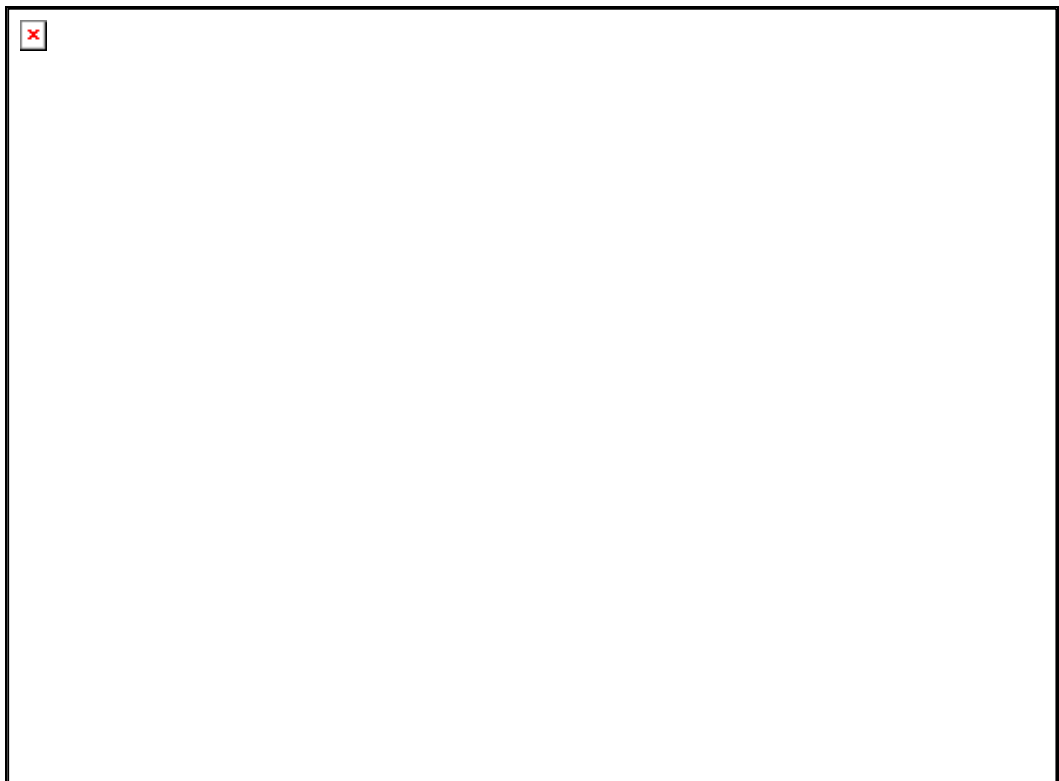

Figure 41 - Installation Wizard Internet Protocol Configuration.



IP Address: Internet protocol (IP) address. This address is used by the family of Internet protocols to uniquely identify this unit on a network.

Subnet Mask: A subnet allows the flow of network traffic between hosts to be segregated based on a network configuration. By organizing hosts into logical groups, subnetting can improve network security and performance.

Gateway IP Address: The IP address of a computer / router on the current network that acts as a gateway. A gateway acts as an entrance / exit to packets from / to other networks.

Use VLAN Management Interface: This controls whether the management interfaces (HTTP/SNMP/SMTP/SNTP) use a VLAN. Selecting this option first presents the user with the warning box shown in Figure 42, then presents the user with extra fields in which to enter the Management VLAN ID, Priority and whether to validate the VLAN ID, as shown in Figure 43.



Figure 42 - VLAN Warning

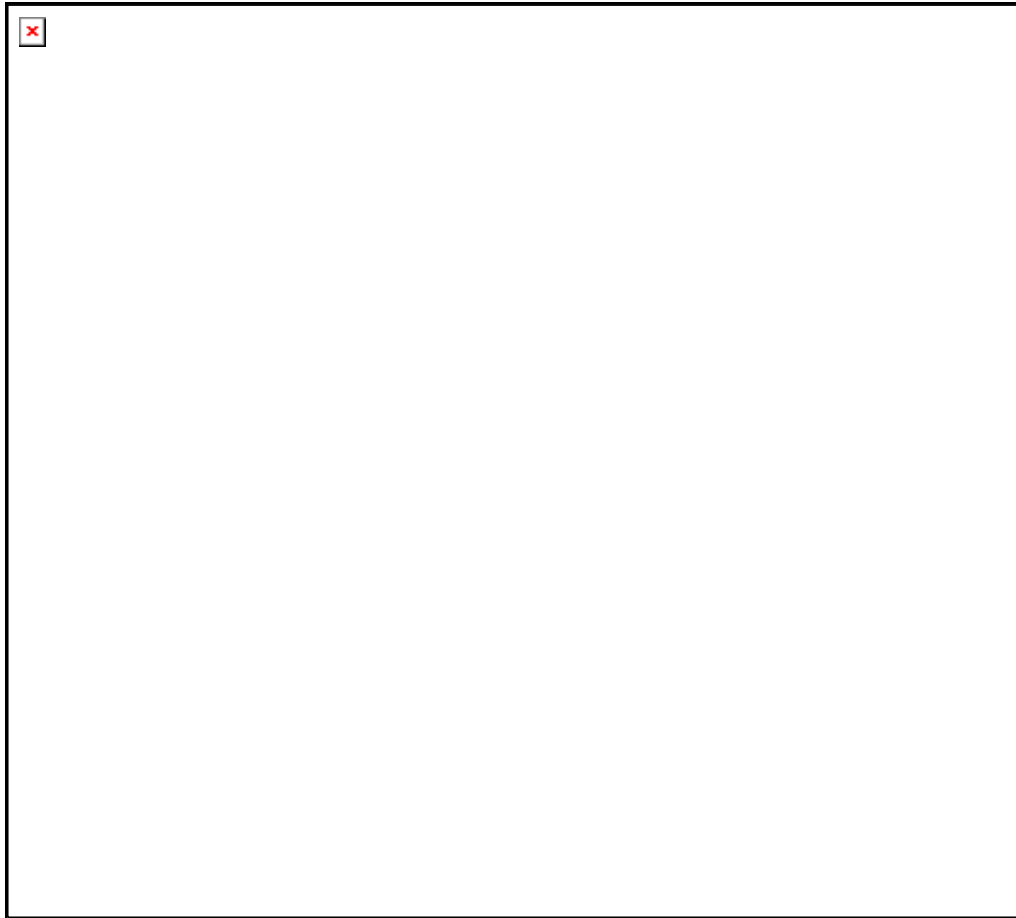

Figure 43 - Additional VLAN Management Options

Once complete click the 'Submit Internet Protocol Configuration' button or the 'Next' link.



Note: The internal Ethernet stack used to manage a unit does not support double VLAN tagged packets. Double VLAN tagged packets will be discarded.



Note: If you loose contact with your unit due to mis-configuration you will need to reset your unit to factory default as described in Section 3.3.2 "The PIDU Plus –"



8.3.5.3 Wireless Configuration

A discussion of the wireless configuration and its relationship to the band of operations is contained in section 5 “General Considerations”. It is recommended that the installer reads this section before commencing with the product installation.

Step 2 of the installation wizard requires the installer to enter the wireless configuration parameters:



Figure 44 - Installation Wizard Wireless Configuration

Target MAC Address: The MAC Address of the peer unit that will be at the other end of the wireless link. This is used by the system to ensure the unit establishes a wireless link to the correct peer.

The MAC Address can be found embedded within the serial number of the unit. The last six characters of the serial number are the last three bytes of the unit’s MAC address.

Note: A PTP 400 Series system is shipped as a pair of units with pre-loaded correct MAC addresses. MAC addresses will only need to be entered if an existing unit has to be replaced in the field or the units configuration has been erased.



Master Slave Mode: At this point it is necessary to decide which end will be designated as Master. The Master unit is the controlling unit with respect to the point-to-point link and its maintenance. The master transmits until the link is made, while the Slave listens for its peer and only transmits when the peer has been identified.

Link Mode Optimization: By default Link Mode Optimization of a point-to-point link is set to 'IP Traffic'. In this configuration the wireless minimizes packet transmission errors by automatically adapting the active modulation mode based on instantaneous vector error measurements and / or the presence of codeword errors. This mode of operation is recommended for connection oriented IP traffic protocols where packet loss is perceived by the protocols as an indication of network congestion. It is recommended that when using this mode of operation that the ARQ state is set to enabled. The 'TDM Traffic' mode of link optimization is recommended for T1 / E1 applications and non-connection oriented protocols. In this mode the wireless link is optimized for minimum transmission latency and preservation of data throughput by allowing the link to maintain a higher modulation mode in the presence of a limited number of codeword errors. It is recommended that when operating the link in TDM mode that both ARQ state is set to disabled and the Spectrum Management controls are used to fix the wireless link to a single frequency. This can be achieved by using the installation wizard to configure single frequency operation (system reboot will be required) or by using the Spectrum Management channel barring (a system reboot will not be required).

Link Symmetry: By default Link Symmetry of a point-to-point link is 'Symmetrical Data Rate (1:1)' in this configuration the ratio of time the wireless link spends transmitting and receiving is equal. When Link Symmetry is configured to Asymmetric Data Rate (2:1) the wireless link Master will spend twice as long transmitting as receiving. It should be noted that the data rate available to the end users might not follow these ratios exactly. The exact data rates will be dependant on the prevailing modulation. If the direction you want to install the link asymmetry is not achievable in the current configuration then the master and slave modes of both PTP 400 Series Bridges will need to be reversed.

Throughput Optimization: Throughput Optimization has two distinct modes:

- **Data Throughput** configures the wireless link for maximum data throughput.
- **Latency Optimized** configures the wireless link to minimize packet latency during transmission over the wireless link.

Note: The Throughput Optimization option is not available on 4.9GHz variants.



ARQ State: Automatic Repeat reQuest (ARQ) is a mechanism where packets lost due to transmission errors over the wireless link are retransmitted rapidly. The retransmission helps to prevent TCP congestion mechanisms from inadvertently interpreting intermittent pack loss as network congestion. ARQ must be enabled on both ends of the point-to-point link for it to function.

Max Transmit Power: This attribute controls the maximum transmit power the unit is permitted to use when installing and executing the wireless link. The maximum setting for a particular region or country is controlled by the License Key.

Ranging Mode: During installation the wireless units perform automatic ranging. The ranging mode allows the installer to control the behavior of the systems automatic ranging algorithms. The default value is 0 to 40 km²² (0 to 25 miles). If the installer is required to install a link of greater than 40 km (25 miles) then the ranging mode attribute MUST be configured to '0 to 100km' (0 to 62 miles) or '0 to 200km' (0 to 134 miles) mode depending on the range of the link. Likewise selecting the 0 to 5 km (0 to 3 miles) mode for links under 5 km (3 miles) will give you optimal performance.

Target Range: Installers that know the range between the two wireless units to within ± 1 km (± 0.62 mile) can use the target range mode. The main advantage of the target range mode is that it reduces the time taken by the units to range. To use the target range mode the installer MUST select Target Range as the ranging mode and enter the approximate range in km in the Target range data entry field at both ends of the link.

Spectrum Management Control: Is used to configure the PTP 400 Series Bridge Spectrum Management features, see section 8.3.8 for more details. I-DFS is the abbreviation for intelligent Dynamic Frequency Selection. This feature continually monitors the spectrum looking for a the channel with the lowest level of on channel and co-channel interference. Fixed frequency mode allows the installer to fix the transmit and receive frequencies on the units. The frequencies may be configured symmetrically or asymmetrically.

Lower Center Frequency: The software for the PTP 400 Series Bridge allows a user to optionally adjust the channel center frequencies. See section 5 "General Considerations" for further information. This field is only available in i-DFS mode on 5.4 GHz and 5.8 GHz variants.

²² If preferred 400 Series Bridge range functions can be configured to operate in miles, see the Properties page in section 8.3.19.



Warning: The lower center frequency attribute must be configured to the same value for both the master and slave. Failure to do so will cause the wireless link to fail re-establishment. The only way to recover from this situation is to modify the Lower Center Frequency attribute so that they are identical on both the master and slave unit.

Fixed Transmit Frequency, Fixed Receive Frequency: The software for the PTP 400 Series Bridge allows a user to optionally fix transmit and receive frequencies for a wireless link. The settings must be compatible at each end of the link. Once configured the spectrum management software will not attempt to move the wireless link to a channel with lower co-channel or adjacent channel interference. Therefore this mode of operation is only recommended for deployments where the installer has a good understanding of the prevailing interference environment.



Warning: Ensure that the Rx and Tx frequencies are correct.

Figure 45 shows a sample fixed frequency configuration. See section 5 “General Considerations” for further information.



Figure 45 - Fixed Frequency Operation



Default Raster: When the Default Raster option is enabled the pull down selection menus displayed for Fixed Tx Frequency and Fixed Rx Frequency allow the selection of frequencies available within the default channel raster. When this option is not enabled the pull down selection menus display all available channel centre frequencies. This option is provided to ease the selection of fixed channel frequencies.

Fixed Tx Frequency: This field controls the units Transmit frequency.

Fixed Rx Frequency: This field controls the units Receive frequency.

Installation Tones: This option allows the operator to enable or disable the audible installation tones.



8.3.5.4 Confirm Configuration

Step 3 of the installation wizard allows the installer to review and confirm the installation information before committing the information to non-volatile memory, as shown for different configuration in Figure 46, Figure 47 and Figure 48.

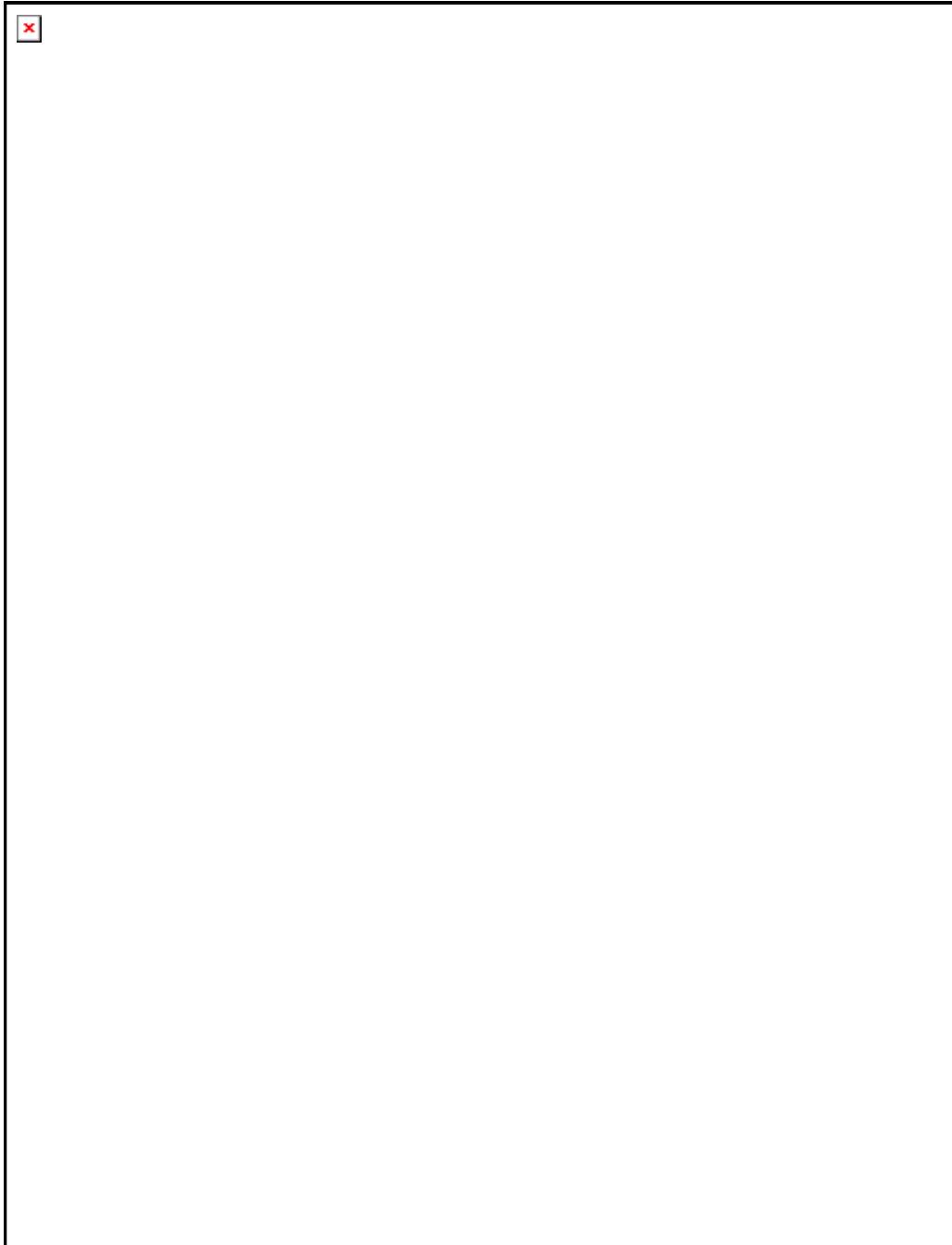

Figure 46 - Installation Wizard Confirm Configuration

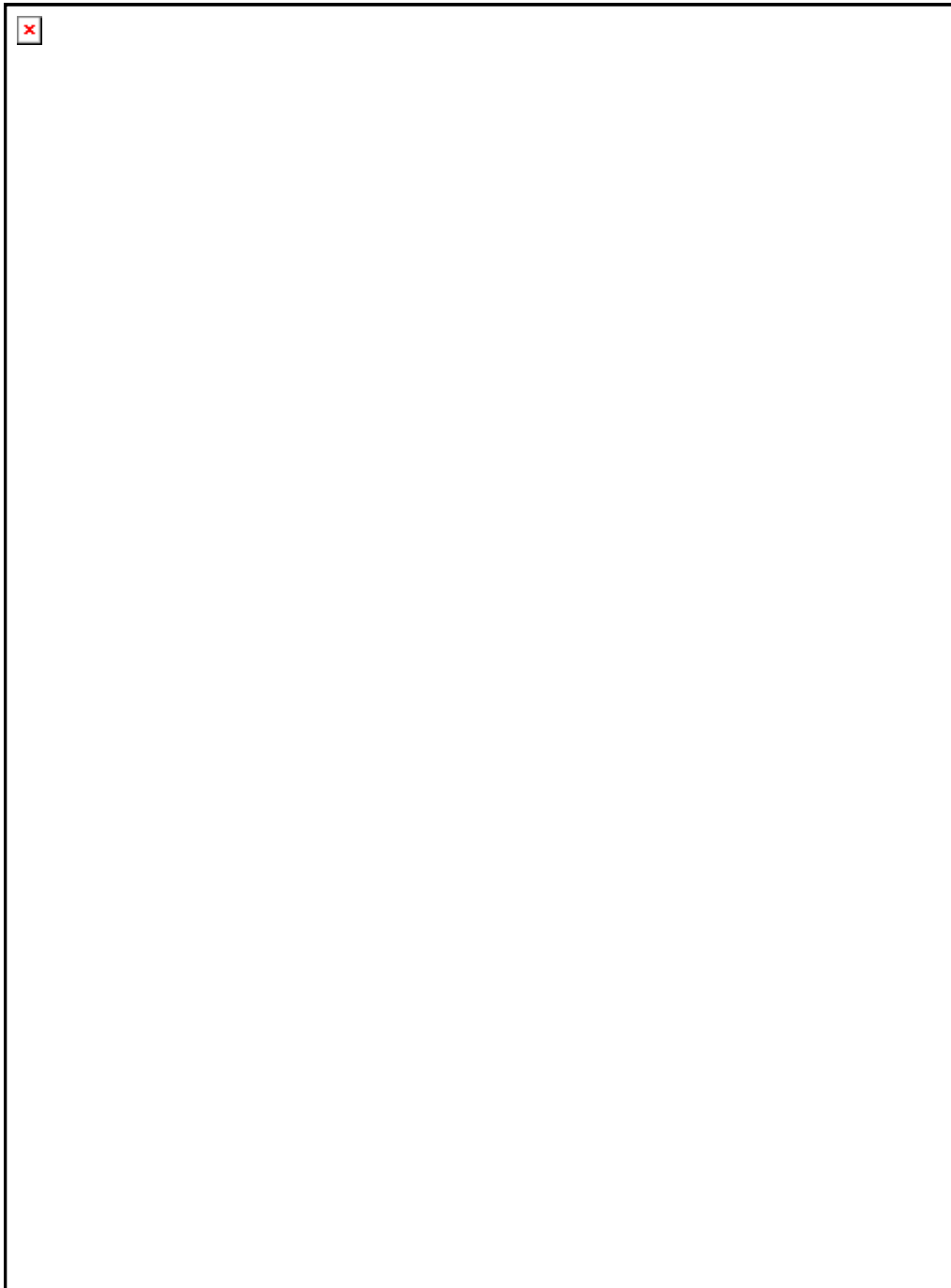

Figure 47 - Installation Wizard Confirm Configuration – Fixed Frequency

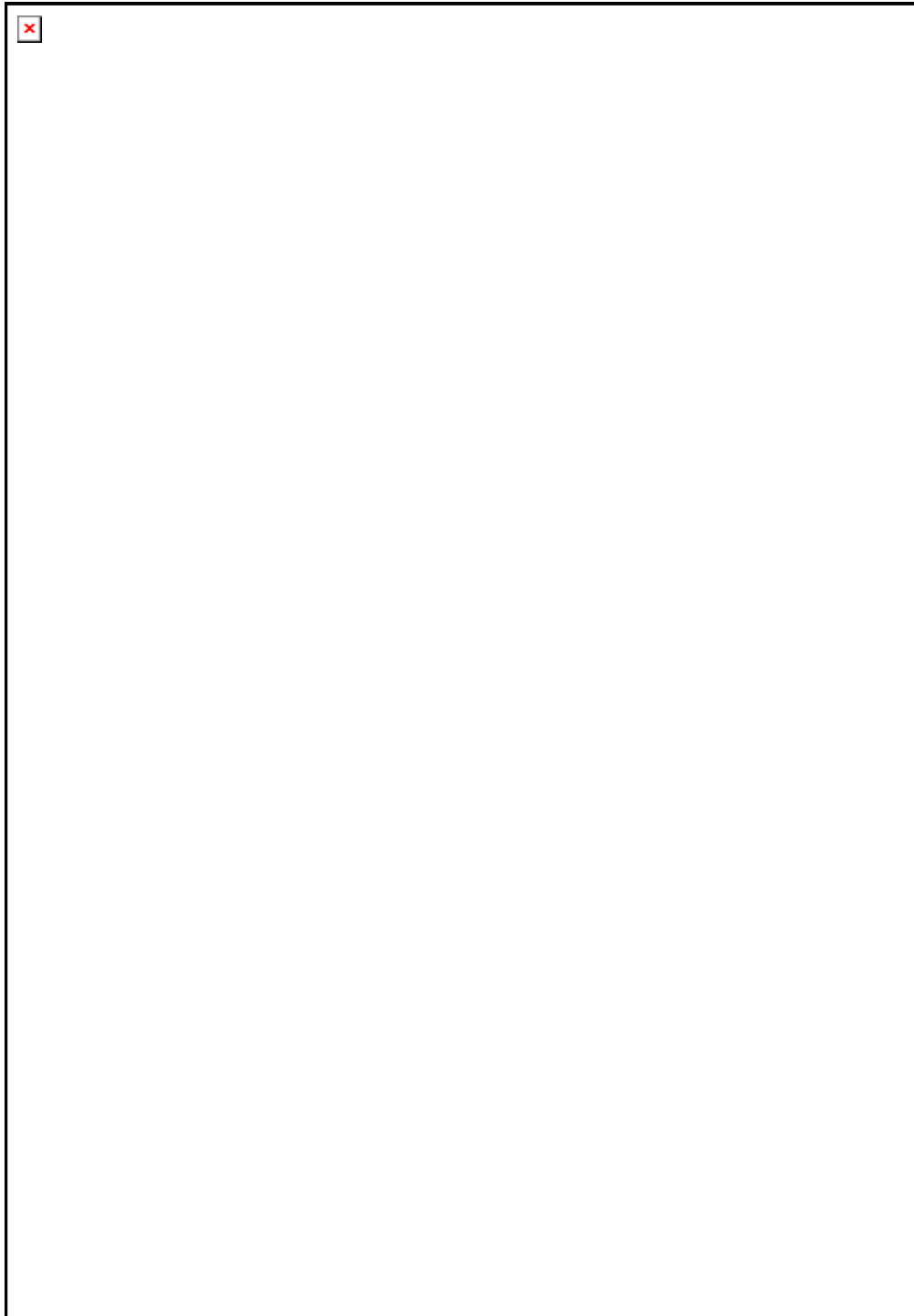

Figure 48 - Installation Wizard Confirm Configuration – Connectorized



If all the settings are correct and appropriate click the “Confirm Configuration and Reboot Unit” button. All the attributes are committed to non-volatile memory. Immediately following the write to non-volatile memory the unit is reset.

Note: If you have changed the Ethernet parameters you must reconnect using the correct network and address settings.

If the installer wishes to modify the installation configuration then the ‘Back’ link can be used to access the installation wizard steps described above.

8.3.5.5 Disarm

The next step of the installation wizard is the Disarm Phase.

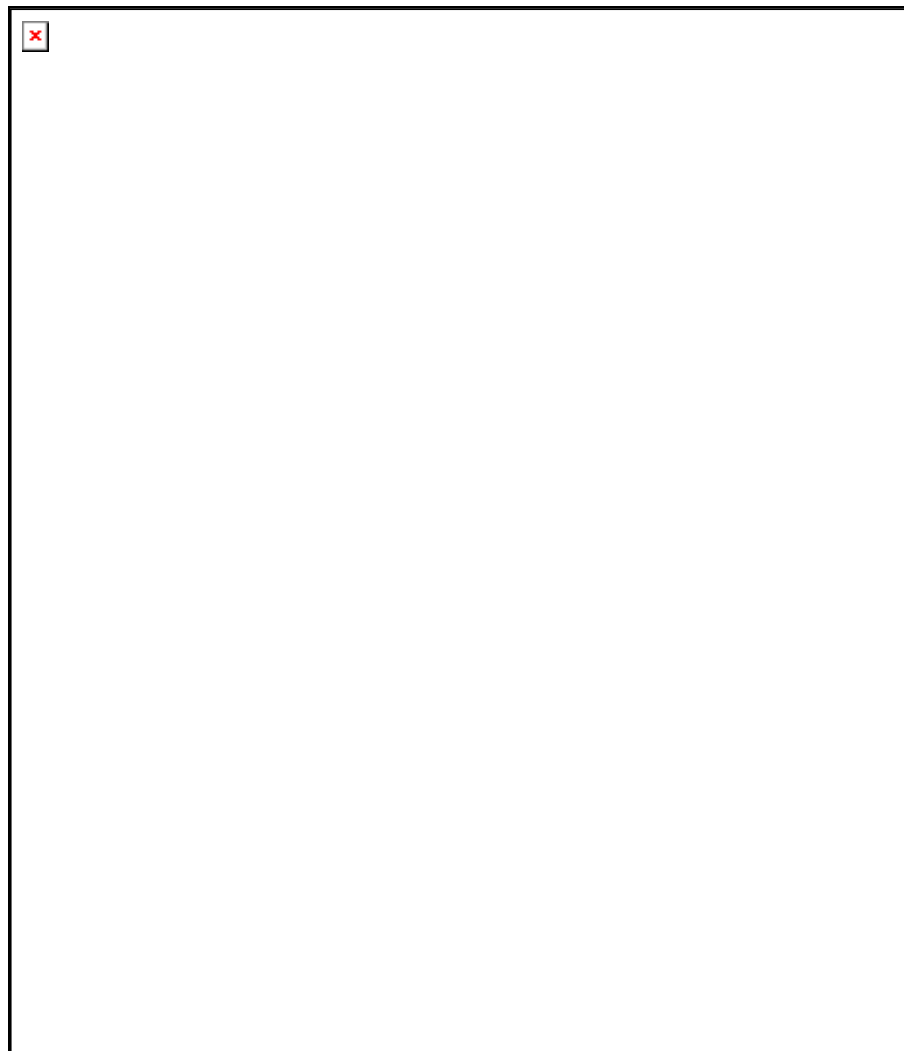

Figure 49 - Disarm Installation.



Once section 7.7.10 “Aligning the ODUs” is complete pressing the “Disarm Installation Agent” button completes the installation process²³ and the audible installation tone will be switched off.

After disarming the wireless link the user is presented with an optional configuration page see Figure 50. The screen presents hyperlinks to the main configuration and spectrum management pages.



Figure 50 - Optional Post Disarm Configuration 2

Once the installer is satisfied with the wireless configuration options then the ‘Submit Wireless Configuration’ button or the ‘Next’ link should be clicked.

²³ The installation process is completed when both ends of the link are ‘disarmed’.

8.3.6 Graphical Install

To aid the installation of wireless links two graphical installation aids have been included:

- A PDA installation screen
- A larger installation screen available from the main HTTP management interface.

The design of the installation screen has been deliberately kept simple and uncluttered. An example of the installation screen is shown in Figure 51. Both the PDA and the large format installation screen have the same content and only differ in size. The PDA installation screen is 232 by 220 pixels to be compatible with the average size of a PDA screen.

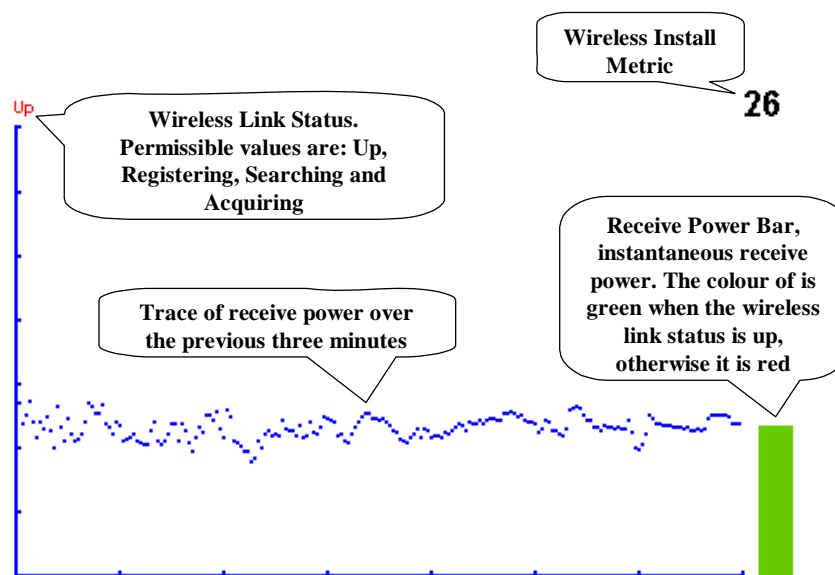

Figure 51 - Installation Screen

The screen displays the receive power of the last three minutes. This will allow the installer to slowly sweep the antenna during installation and monitor the variation in signal strength with angular position. The screen automatically refreshes every three seconds.

The screen also displays the current state of the wireless link in two ways. First, the actual state of the wireless link is written in the top left corner of the screen. The instantaneous receive power bar also encodes the state of the wireless link using green to signify that the wireless link is up and red for all other states.

For the more technically aware the installation metric is simply the instantaneous receive power in dBm + 100.



The PDA installation tool is accessed via a hidden URL `http://<ip-address>/pda.cgi`. It should be noted that this link is only available after the user has logged in as system administrator.

The large screen version of the graphical user interface is available as a submenu option of the installation wizard.

8.3.7 Software Upgrade

The PTP 400 Series Bridge system has two software image banks; one is a fixed image which is stored in protected non-volatile memory and cannot be modified by the user. The second bank is used by the system administrator to upgrade the firmware as and when necessary.

The 'Fixed' image is only used if disaster recovery is required, i.e. if an upgrade process is interrupted or the units are reset to their factory defaults.

These pages are used to update a unit's operational software. The software image to be uploaded should be downloaded to local storage from the [Motorola web site](#). The software image is delivered by Motorola as a compressed zip file. Once the zip file has been downloaded the user should extract the PTP 400 Series Bridge Software image, identifiable by its '.dld' file extension.

The "Browse" button is used to locate the software image previously downloaded to local storage from the [Motorola web site](#). Once the image is located the user should press the "Upload image to wireless unit" button to start the software upgrade process. The following figures detail the upgrade process:

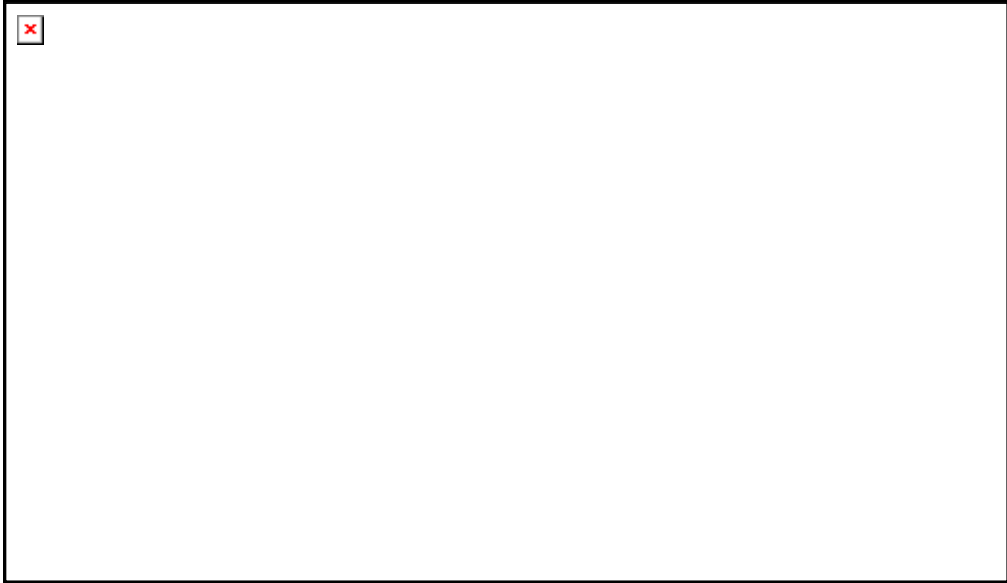

Figure 52 - Software Upgrade – Step 1

The software image will now be uploaded to the unit. This upload should only take a few seconds. Once complete the image is verified and validated to ensure that no errors occurred during transfer and the image is valid to run on the current platform. If there are any problems a warning screen will appear.

The unit being upgraded will now display information about the build it currently has stored in the image bank and the one that's just been uploaded, as shown in Figure 53. If the image is not correct, the user has the option to go back and reload a new image, as shown in Figure 52.

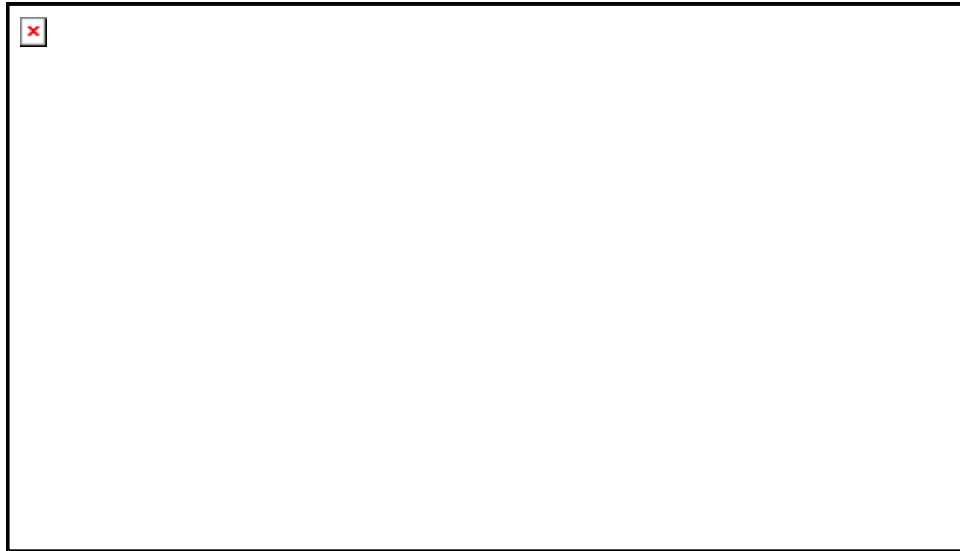

Figure 53 - Software Upgrade Image Check

The user should ensure that the correct image is shown before pressing the “Program Software Image into Non-Volatile Memory” button. Once this button has been pressed the image is stored into non-volatile memory. This process can take up to 60 seconds and must not be interrupted. A progress tracking web page will be presented to the user during the erasure and programming of non-volatile memory.



WARNING: If the upgrade process is interrupted during the erasure of the image bank or during the reprogramming of the image bank the image bank will be left in a corrupt state. If this occurs the software must be reloaded. On power up, if the software image is invalid, for any reason, the PTP 400 Series bridge will use a known good fixed image. If this occurs the user must attempt to reload the correct version of software.

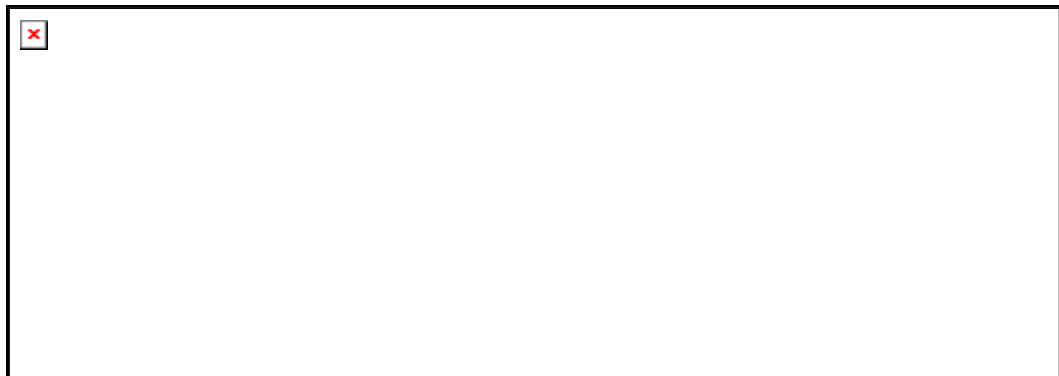

Figure 54 - Overall Progress Tracker



Once the Overall Update Progress bar has reached 100%, proceed to the next step.

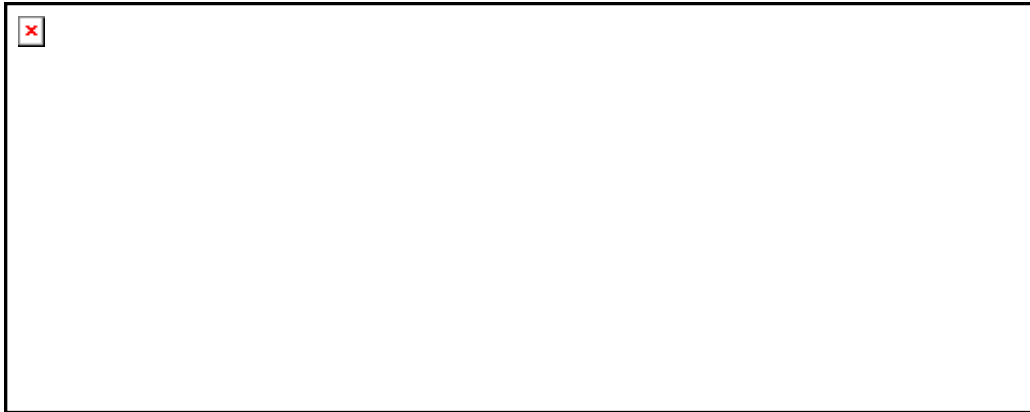

Figure 55 - Software Upgrade Complete

When the software image has been written to memory Figure 55 will be displayed showing the status of the software upload.

Reboot the unit by clicking the “Reboot Wireless Unit” button. This will reboot the unit within 30 seconds, and during this time you will not be able to communicate with the unit. The unit is now fully functional.

If this screen is not displayed after 60 seconds it could indicate a problem with the memory update process.

The user should now power cycle the unit to start using the new software image. The unit's boot software will automatically determine the health of the newly uploaded software image. If any problems were encountered the boot code will revert to a protected fixed software image

After the power cycle the user should check that the required software image is loaded and running by re-entering the Upgrade page where the software bank status will be displayed.



8.3.8 Spectrum Management

Spectrum Management Selection (also referred to by the acronym DFS) is the PTP 400 Series Bridge wireless feature that monitors the available wireless spectrum and directs both ends of the wireless link to operate on a channel with a minimum level of co-channel and adjacent channel interference.

8.3.8.1 Wireless Channels

The PTP 400 Series Bridge operates using a set of predefined channels. Section 5 "General Considerations" contains detailed information on this subject with regards each product variant. It should be noted that some product variants have a channel raster smaller than their channel size. In these cases the channels overlap and the Spectrum Management displays should be read accordingly.

The default channelization can be modified by varying the lower center frequency attribute in the installation wizard – see Section 8.3.5.3 "Wireless Configuration" - **Lower Center Frequency**.

8.3.8.2 Spectrum Management Measurements

The PTP 400 Series Bridge performs four Spectrum Management measurements per TDD cycle, per channel. The measurements are subdivided into two signal peak measurements and two mean signal measurements. The peak measurements represent the peak received signal power with a resolution down to 100 ns. The mean measurement represents the mean received signal power for the 40 μ s measurement period.

The Spectrum Management algorithm collects measurements equally from all channels. This process is called the Channel Availability Check (hereafter referred to by the acronym CAC). The CAC uses a round-robin channel select selection process to collect an equal amount of measurements from each channel. It is important to note that the CAC measurement process is not altered by channel barring process. Measurements are still collected for all channels irrespective of the number of barred channels.

8.3.8.3 Measurement Analysis

Spectrum Management uses statistical analysis to process the received peak and mean measurement. The statistical analysis is based on a fixed, one minute, measurement quantization period. Spectrum Management collects data for the specified quantization period and only at the end of the period is the statistical analysis performed.



The analysis produces four key metrics for each channel:

- Peak of Peaks
- Peak of Means
- 99.9% Percentile of the Means
- Mean of Means

Peak of Peaks: is the largest peak interference measurement encountered during the quantization period. This metric is useful for detecting large short duration spikes in the interference environment.

Peak of Means: is the largest mean interference measurement encountered during the quantization period. The peak of means is similar to the peak of peaks and is useful for detecting slightly longer duration spikes in the interference environment.

99.9% Percentile of the Means: is the value of mean interference measurement for which 99.9% of all mean measurements fall below during the quantization period. The 99.9% percentile metric is useful for detecting short duration repetitive interference that by its very nature has a minimal affect on the mean of means.

Mean of Means: is the arithmetic mean²⁴ of the measured means during a quantization period. The mean of means is a coarse measure of signal interference and gives an indication of the average interference level measured during the quantization period. The metric is not very good at predicting intermittent interference and is included to show the spread between the mean of means, the 99.9% percentile and the peak of means.

Note: Spectrum Management uses the 99.9% percentile as the prime interference measurement. All subsequent references to interference level refer to this percentile measurement.

The display of statistical measurement on the spectrum management page always shows a statistical summary of all channel measurement. The statistical summary is controlled by the Statistics Window attribute. This attribute defaults to a value of twenty minutes, which means that the mean and percentile values displayed for each channel are calculated over the 20 minute period. All channel decisions are made using the values computed over the statistics window period.

²⁴ The arithmetic mean is the true power mean and not the mean of the values expressed in dBm.



8.3.8.4 The Spectrum Management Master / Slave Relationship

By default Spectrum Management operates in a master / slave relationship. The master is assumed to be the link master configured during installation. All Spectrum Management configuration changes **MUST** be performed from the master. To enforce this, the Spectrum Management web page has a different appearance depending if you are viewing the data from the master or slave.

Figure 56 shows a sample Spectrum Management web page as seen from the master.

All configuration changes are applied at the master only. These changes are then messaged from the master to the slave. Any Spectrum Management configuration messages received at the slave are stored in non-volatile memory. This enables both master and slave to keep identical copies of Spectrum Management configuration data in their non-volatile memories. It is therefore possible to swap master and slave roles on an active point-to-point link without modifying Spectrum Management configuration.

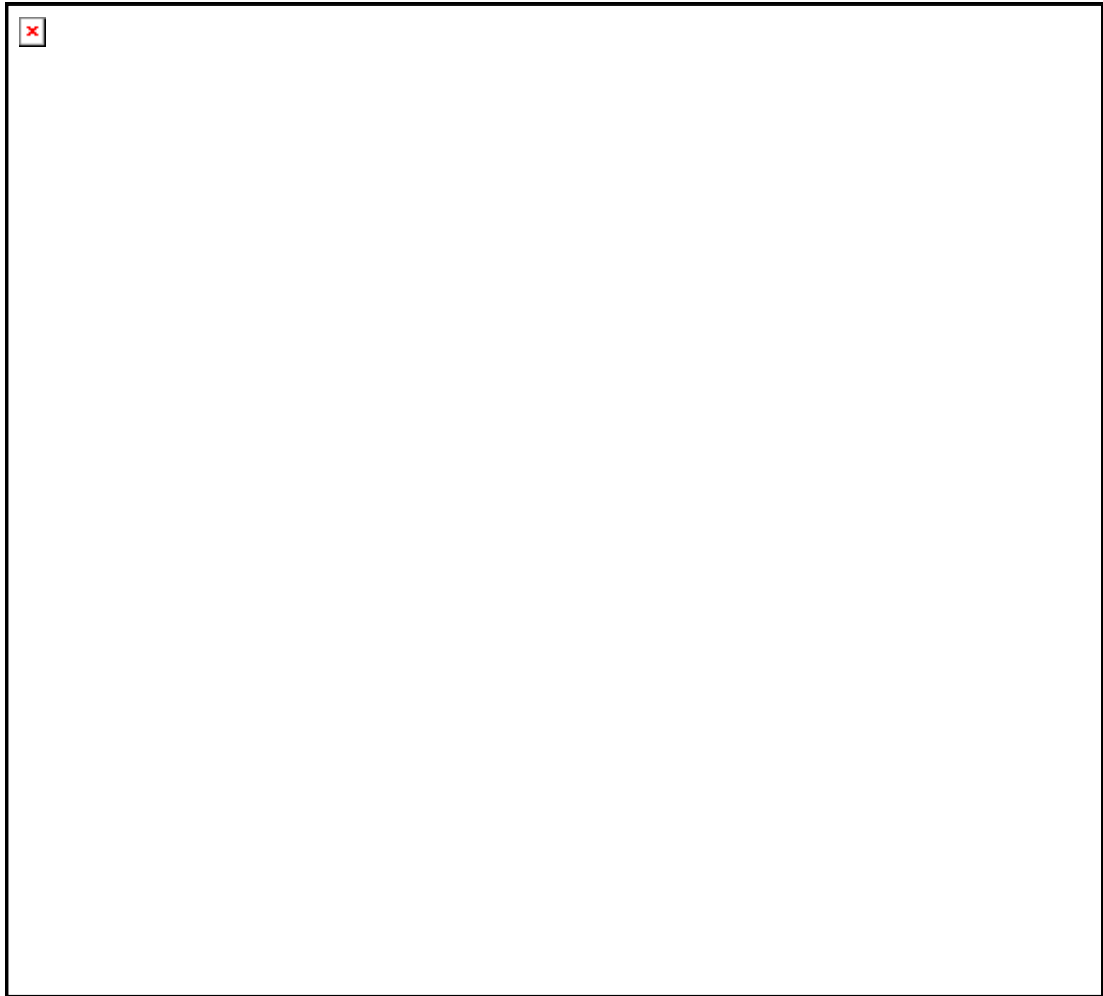

Figure 56 - Spectrum Management - Master

Figure 57 shows a sample PTP 400 Series Spectrum Management web page as seen from the slave. It should be noted that all the key configuration attributes are not available on the slave web page.

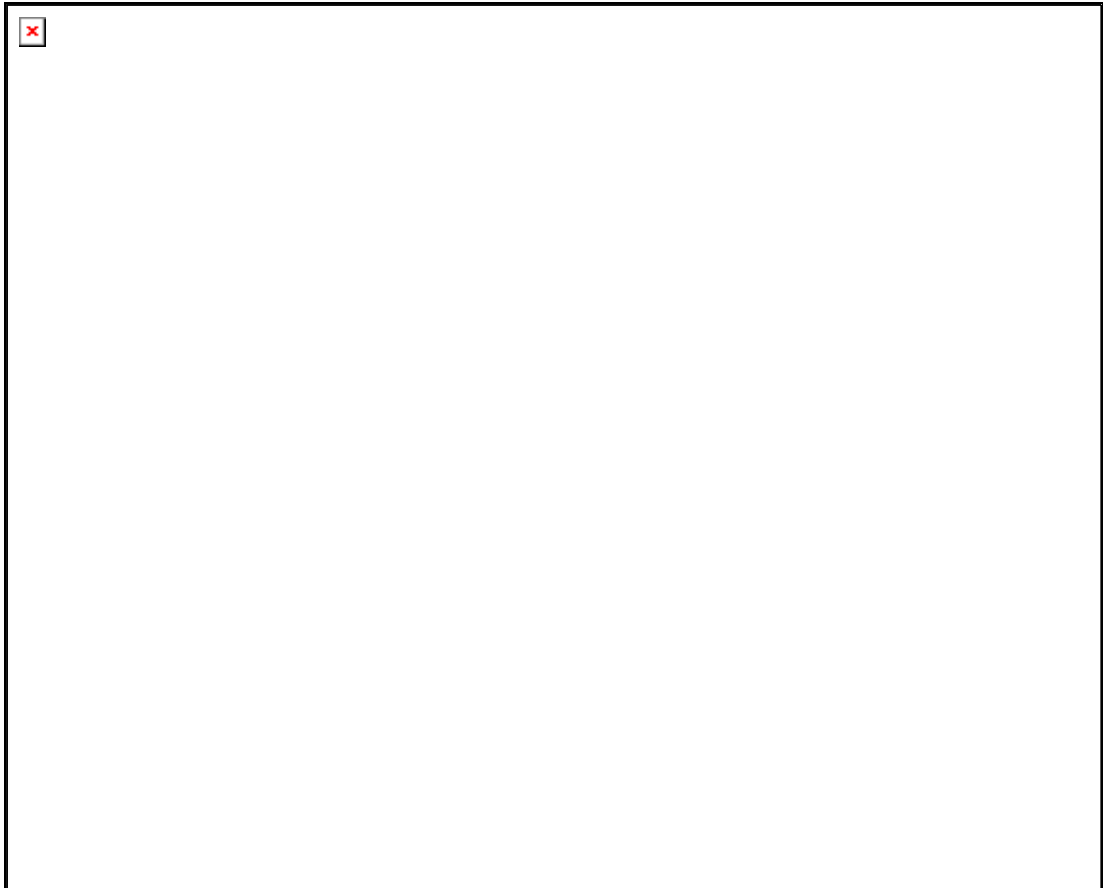

Figure 57 - Spectrum Management – Slave

8.3.8.5 Spectrum Management Configuration

The following section describes the user modifiable configuration accessible from the Spectrum Management web page. It is recommended that the default values are maintained. If the user believes that the performance of the Spectrum Management algorithm requires some modifications this should only be done after consulting your Motorola Point-to-Point distributor or one of the system field support engineers.

Refresh Page Period: The page refreshes automatically according to the setting entered here (in seconds).

Hopping Period: The Spectrum Management algorithm evaluates the metrics every 'Hopping Period' seconds (180 seconds by default) looking for a channel with lower levels of interference. If a better channel is located, Spectrum Management performs an automated channel hop. If SNMP and or SMTP alerts are enabled an SNMP TRAP and/or an email alert is sent, warning the system administrator of the channel change.



Hopping Margin: Spectrum Management uses this margin when making a channel hop decision. The channel to hop to has to have an interference level 3 dBs (default) better than the current active channel. **Hopping Counter** is used to record the number of channel hops. The number in the “(+)” brackets indicates the number of channel changes since the last screen refresh.

Hopping Counter: Indicates the number of automatic channel changes that have occurred.

Asymmetric DFS: When disabled this option constrains the link to operate symmetrically using the same transmit and receive channels. When in symmetric mode the slave unit will always follow the master. If the master moves to a new channel the slave will hop to the same channel. When the Point-to-Point link is configured as an asymmetric link both the master and slave are free to select the best channel from their own set of local interference metrics. (Default Enabled).

Interference Threshold: Spectrum Management uses the interference threshold to perform instantaneous channel hops. If the measured interference on a channel exceeds the specified threshold then Spectrum Management will instruct the wireless to immediately search for a better channel. If a better channel cannot be found, the PTP 400 Series Bridge will continue to use the current active channel. (Default -85 dBm)

8.3.8.6 Barring Channels

Channels can only be barred / unbarred by the system administrator from the master Spectrum Management web page. The barring / unbarring operations are disabled on the slave web page. If an attempt to bar / unbar a channel is made at the slave a warning dialog is generated.

Barring / Unbarring of channels is performed by clicking the appropriate channel on the local or peer channel spectrum plots on the master web page. Each bar / unbar attempt will be preceded by a conformation dialog. It should be noted that the channel bar will take effect immediately and is not related to the measurement quantization period.

8.3.8.7 Local and Peer Channel Spectrum Graphics

Spectrum Management presents its computed statistical measurements in a graphical display on both the master and slave DFS web page.



Figure 58 - Sample Spectrum Management Graphic

The X-axis shows a stylized view of the selectable wireless channels. See section 5 “General Considerations” for further information. The display separates the display of channels to help the clarity of the resultant display. The axis is labeled using the channel center frequencies in MHz.

The Y-axis shows the interference power levels from –100 to –40 dBm.

The active channel (channel 1 in Figure 58) is always marked using hatched green and white lines. The width of the hatching is directly proportional to the spectral occupancy of the channel.

The individual channel metrics are displayed using a colored bar, an ‘I’ bar and a peak symbol. The colored bar represents the following channel state:

Green	Active	The channel is currently in use hosting the Point-to-Point wireless link
Orange	Interference	The channel has interference above the interference threshold
Blue	Available	The channel has an interference level below the interference threshold and is considered by the Spectrum Management algorithm suitable for hosting the Point-to-Point link
Grey	Barred	The system administrator has barred this channel from use. Because the low signal levels encountered when a unit is powered up in a laboratory environment prior to installation (which makes the grey of the channel bar difficult to see). An additional red ‘lock’ symbol is used to indicate that a channel is barred.

Table 12 - Spectrum Management (Non UK) change state key

The top of the colored bar represents the 99.9% percentile metric for specific channel.



The 'I' Bar is used to display the mean of means and peak of means metrics. The lower horizontal bar represents the mean of means and the upper horizontal bar represents the peak of means. The vertical bar is used as a visual cue to highlight the statistical spread between the peak and the mean of the statistical distribution.

The peak symbol (the upper small triangle above each channel 'I' bar) is used to indicate the peak of peaks interference measurement.

8.3.8.8 Active Channel History

The active channel history is a time series display of the channels used by the PTP 400 Series Bridge over the last 25 hours. The active channel history is activated from the main Spectrum Management page using the 'Active Channel History' hyperlink. An example of the active channel history display is shown in Figure 59. Where there are parallel entries on the display this signifies that the wireless link occupied this channel during the measurement period. The measurement periods are one minute from zero to sixty minutes and twenty minutes from 60 minutes to twenty five hours.

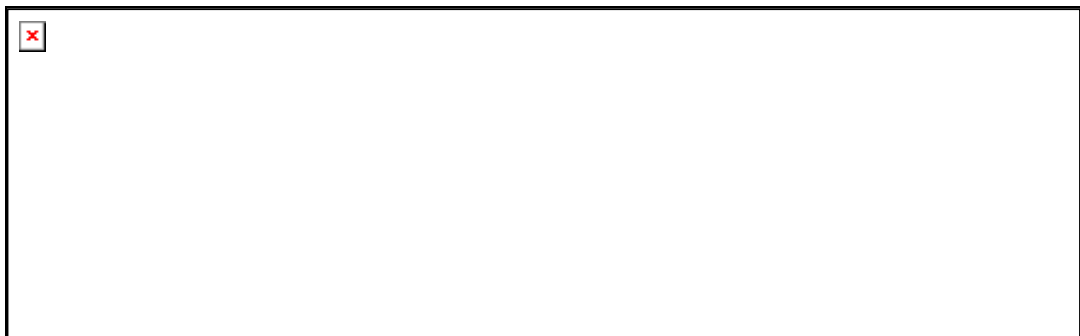

Figure 59 - Active Channel History Screen

8.3.8.9 Viewing Historic Spectrum Management Metrics

Spectrum Management allows the system administrator to view the results of previous measurement quantization periods. Holding down the shift key and clicking the appropriate channel on the local channel spectrum plots activates this feature. This feature is available on both the master and slave webpage.

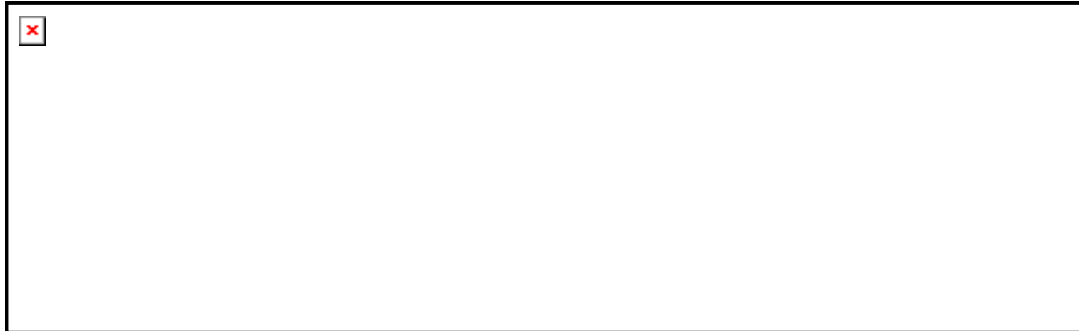

Figure 60 - Spectrum Management Time series Plot

Figure 60 shows a sample time series plot. A time series plot displays the previous 145 measurement quantization periods. If the PTP 400 Series Bridge has not been running for 145 quantization periods then only the number of measurement quantization periods that are available are displayed.

RED	Peak of Peaks interference measurement
GREEN	Peak of Means interference measurement
BLACK	99.9% percentile of means interference measurement
BLUE	Mean of Means interference measurement

Table 13 - Spectrum Management time series key

8.3.8.10 Spectrum Management Online Help

Because the Spectrum Management displays contain a large amount of data, symbols and color references, an online help screen has been provided see Figure 61. This screen is accessible from both the master and slave web pages.

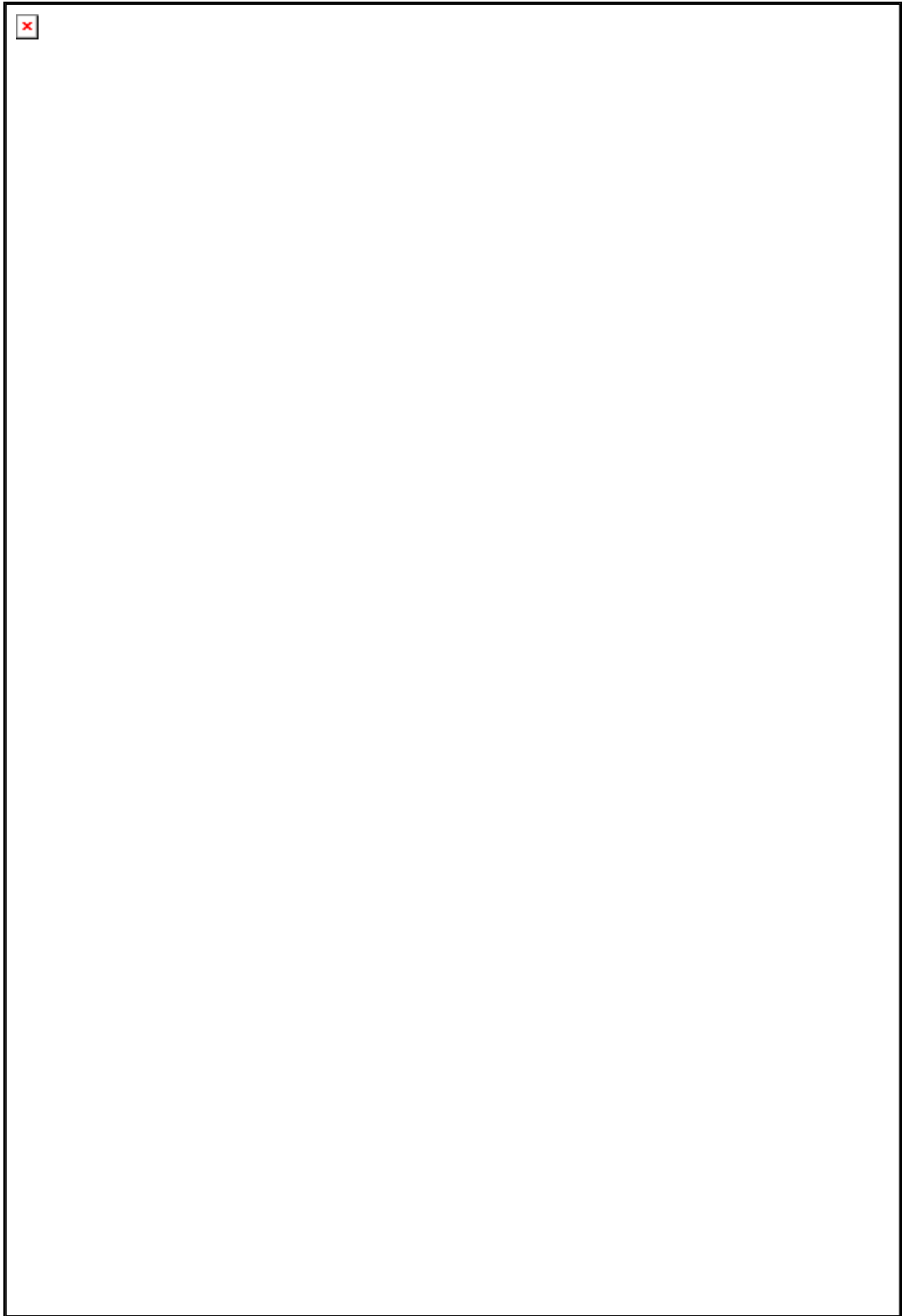

Figure 61 - Spectrum Management Help Page

8.3.9 Spectrum Management - Fixed Frequency

The software for the PTP 400 Series Bridge allows a user to optionally fix transmit and receive frequencies for a wireless link. Once configured the spectrum management software will not attempt to move the wireless link to a channel with lower co- and adjacent channel interference. Therefore this mode of operation is only recommended for deployments where the installer has a good understanding of the prevailing interference environment. (See Section 8.3.5.3 “Wireless Configuration” - **Fixed Transmit Frequency, Fixed Receive Frequency**). Care must also be taken to ensure that the frequency allocations at each end of the link are compatible. To help the user when identifying the mode of operation Spectrum Management uses two visual cues. See Figure 62. The main page title identifies the mode of operation using the ‘- Fixed Frequency Mode’ postfix., and the selected channels are identified by a red capital ‘F’.

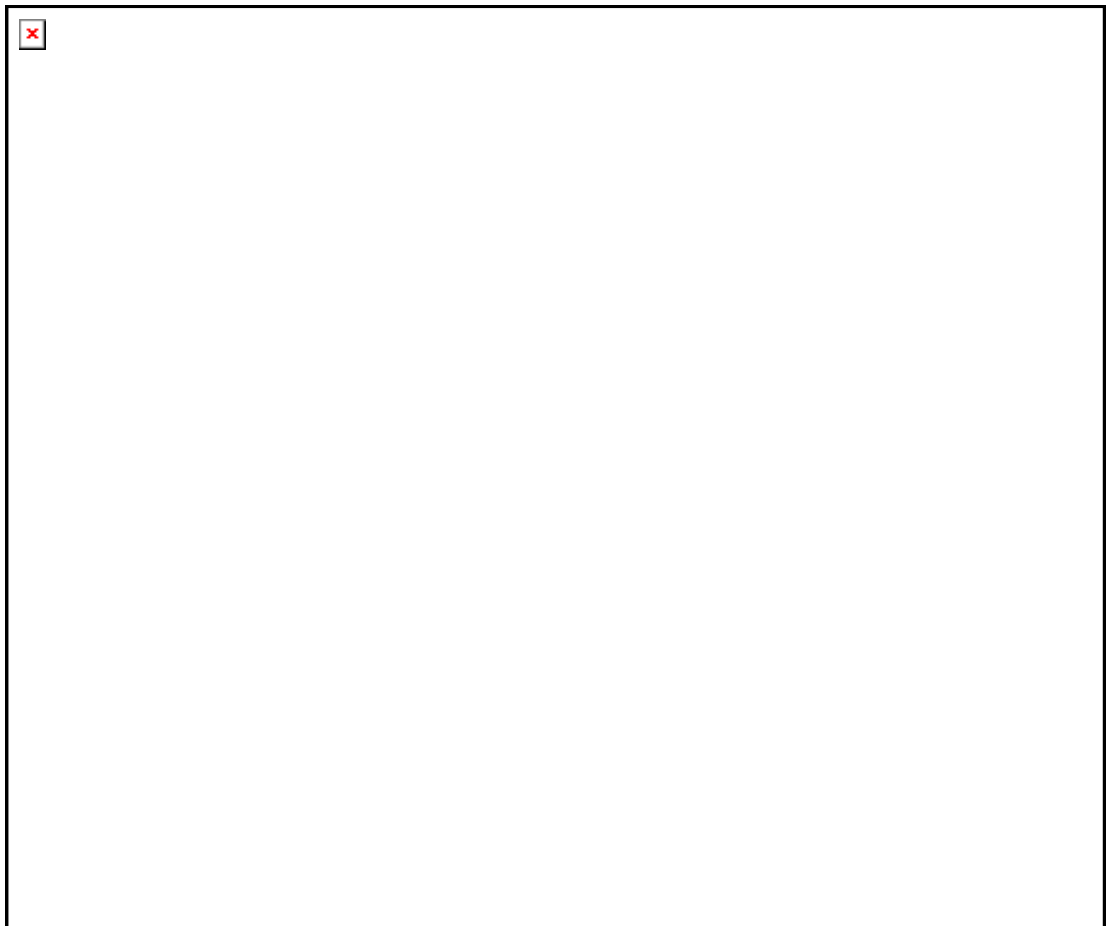

Figure 62 - Spectrum Management Fixed Frequency Screen- Master

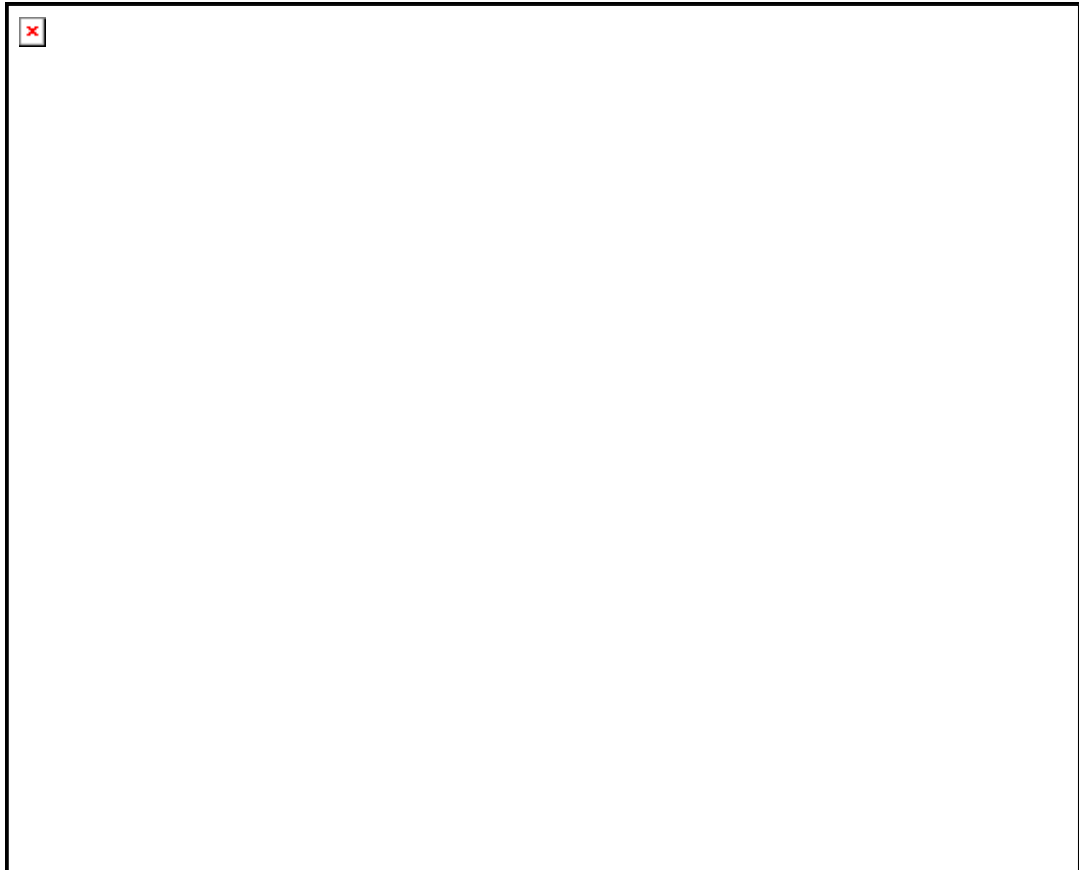

Figure 63 - Spectrum Management Fixed Frequency Screen- Slave

Channel barring is disabled in fixed frequency mode; it is not required as dynamic channel hopping is prohibited in this mode.

The only control available to the master is the Interference Threshold attribute. This has no effect on the operation of the wireless link and will only affect the generation of the channel spectrum graphics. The active channel history menu is removed in this mode of operation as channel hopping is prohibited.

8.3.10 Spectrum Management Control - With Operational Restrictions

When operating with Radar Avoidance enabled the following variances in operation apply:

- The words “Radar Avoidance” are appended to the “Spectrum Management” title at the top of the screen. See Figure 64 and Figure 65.
- The only controls available to the master are the Interference Threshold attribute. This has no affect on the operation of the wireless link and will only affect the generation of the channel spectrum graphics. See Figure 64.
- Extra color coding of the interference histogram is provided. See Table 14.



When operating with RTTT Avoidance enabled or other regulatory restrictions on channel usage the following variances apply:

- A channels marked with a 'no entry' symbol with their associated statistics colored black are the prohibited channels. See Figure 64 and Figure 65. These channels are never used to host the wireless link, but interference measurements are still taken so that adjacent channel biases can be calculated correctly and so the user can see if other equipment is in use.

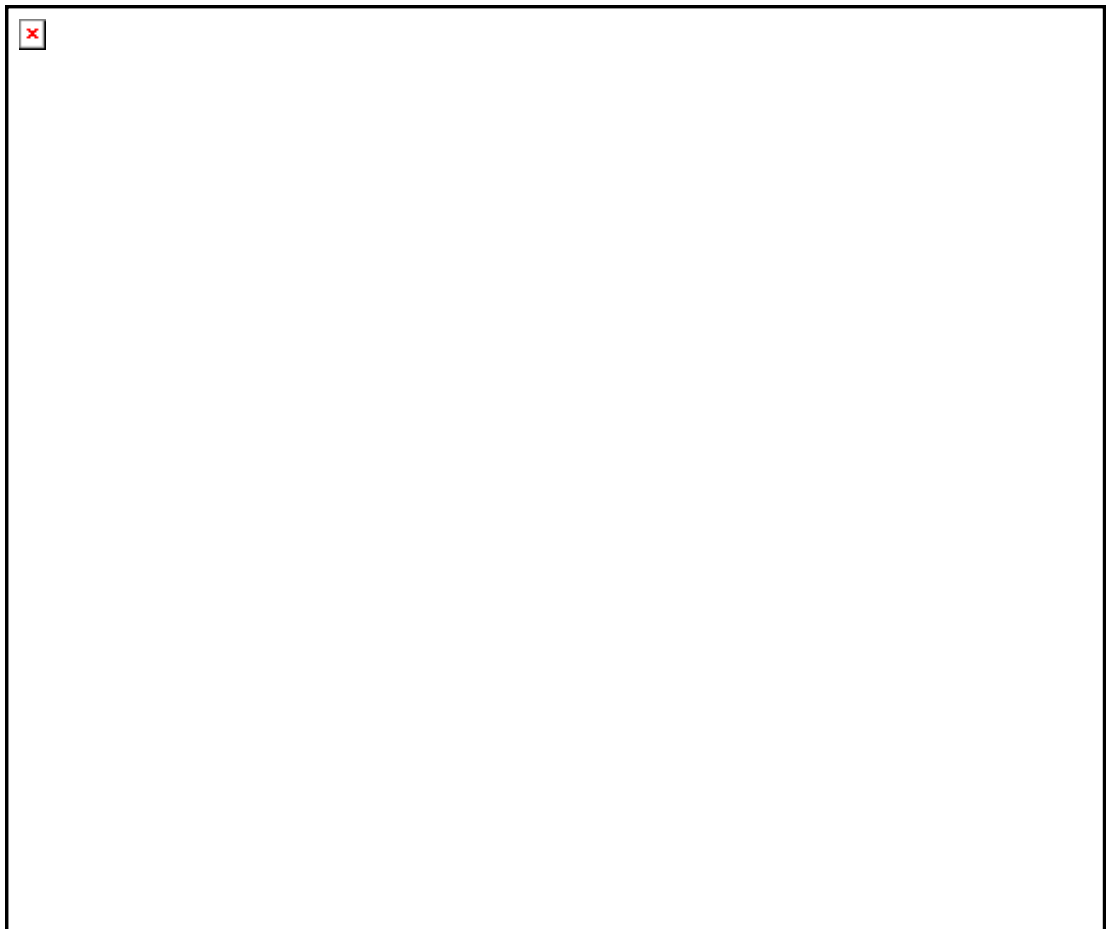

Figure 64 - Spectrum Management Master Screen with Operational Restrictions



Figure 65 - Spectrum Management Slave Screen with Operational Restrictions

The colored bar represents the following channel state:

Green	Active	The channel is currently in use hosting the Point-to-Point wireless link
Orange	Interference	The channel has interference above the interference threshold
Blue	Available	The channel has an interference level below the interference threshold and is considered by the Spectrum Management algorithm suitable for hosting the Point-to-Point link
Grey	Barred	The system administrator has barred this channel from use. Because the low signal levels encountered when a unit is powered up in a laboratory environment prior to installation (which makes the gray of the channel bar difficult to see). An additional red 'lock' symbol is used to indicate that a channel is barred.
Red	Radar Detected	Impulsive Radar Interference has been detected on this channel.
Region Bar	Region Bar	This channel has been barred from use by the local region regulator

Table 14 - Spectrum Management Change State Key with Operational Restrictions



8.3.11 Remote Management Page

The Remote Management page (Figure 66) allows the system administrator to configure the remote management of the PTP 400 Series Bridge.

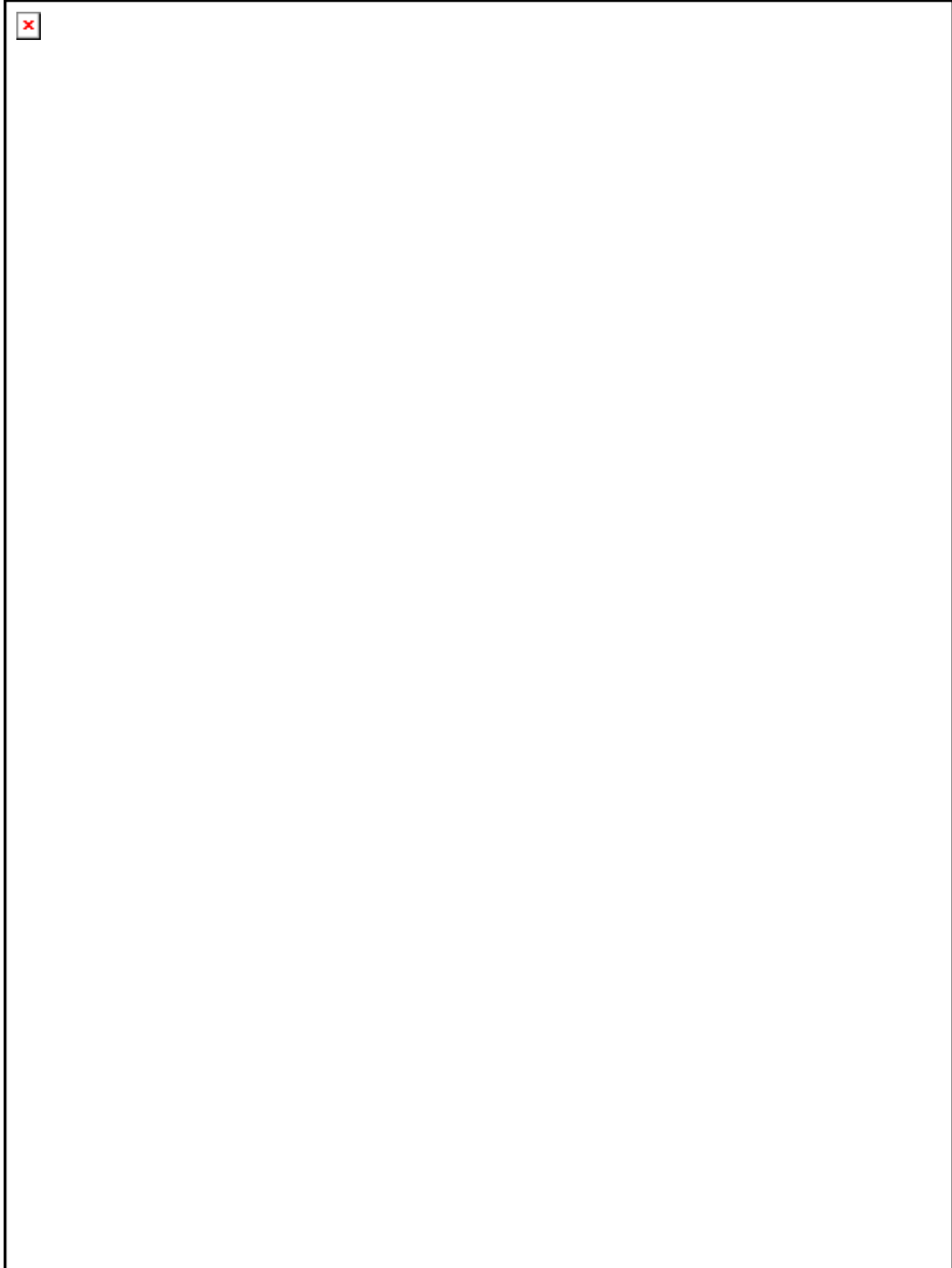

Figure 66 - Remote Management



8.3.12 SNMP (Simple Network Management Protocol)

The industry standard remote management technique is SNMP (Simple Network Management Protocol). The PTP 400 Series Bridge supports version 1 and version 2c of the SNMP protocol.

8.3.12.1 Supported Management Information Bases (MIBS)

The industry standard remote management technique is SNMP (Simple Network Management Protocol). The PTP 400 Series Bridge supports SNMP version 1 and version 2.

The PTP 400 Series Bridge SNMP stack currently supports four distinct MIBs:

1. MIB-II, RFC-1213, The PTP 400 Series Bridge supports the 'System Group' and 'Interfaces Group'.
2. Bridge MIB, RFC-1493, The PTP 400 Series Bridge supports the 'dot1dBase Group' and the 'dot1dBasePortTable Group'.
3. PTP 400 Series Bridge proprietary MIB
4. WiMAX MIB

SNMP TRAPs supported:

- Cold Start
- Link Up
- Link Down
- DFS Channel Change
- DFS Impulsive Interference

For a copy of the Motorola proprietary version 1 and version 2 MIB RFCs please consult the installation CD.

8.3.12.2 SNMP Configuration

SNMP State: The SNMP state attribute controls the creation of the SNMP features. Changing the SNMP state attribute requires a mandatory reboot of the unit. Only when the SNMP state is enabled at system start-up will the SNMP processor task be created.

SNMP Enabled Traps: The SNMP Enabled Traps attribute controls which SNMP traps the unit will send.

SNMP Trap Version: This determines which SNMP trap version the unit will send: version 1 or version 2c.



SNMP Community String: The SNMP community string acts like a password between the networks SNMP management entity and the distributed SNMP clients (PTP 400 Series Bridge). Only if the community string is configured correctly on all SNMP entities can the flow of management information take place. By convention the default value is set to 'public'. When the community string is changed the system requires a mandatory reboot before the new string or phrase is adopted.

SNMP Port Number: The SNMP port number used by the agent for all GET, SET, WALK PDUs.

SNMP Trap IP Address: Is the address of either the network SNMP manager or Trap receiver. When asynchronous events (Traps in SNMP terminology) are generated the client unicasts these to this IP Address. When the address is changed the system requires a mandatory reboot before the setting is adopted

SNMP Trap Port Number: The SNMP Trap Port Number is the port number of either the networked SNMP manager or Trap receiver. By convention the default value for the port number is 162. When the port number is changed the system requires a mandatory reboot before the setting is adopted.

WiMAX Control: Enables and Disables the WiMAX (802.16) MIB. This control is only displayed when 'Fixed Frequency' is selected during installation.

8.3.12.3 SMTP (Simple Mail Transport Protocol)

The SMTP client is an alternative method for the PTP 400 Series Bridge to alert the outside world when there are or have been system errors

SMTP Email Alert: This attribute controls the activation of the SMTP client.

SMTP Enabled Messages: The SMTP Enabled Messages attribute controls which email alerts the unit will send.

SMTP IP Address: The IP address of the networked SMTP server.

SMTP Port Number: The SMTP Port Number is the port number used by the networked SMTP server. By convention the default value for the port number is 25.

SMTP Source Email Address: The email address used by the PTP 400 Series Bridge to log into the SMTP server. This must be a valid email address that will be accepted by your SMTP Server

SMTP Destination Email Address: The email address to which the PTP 400 Series Bridge will send the alert messages.



8.3.13 SNTP (Simple Network Time Protocol)

The SNTP client allows the PTP 400 Series Bridge to obtain accurate date and time updates from a networked timeserver. The resultant time information is used by the SNMP, web page and System Reboot tasks.

SNTP State: The SNTP state attribute controls the creation of the SNTP features.

When enabled the following options are available:

SNTP IP Address: The IP address of the networked SNTP server.

SNTP Port Number: The port number of the networked SNTP server. By convention the default value for the port number is 123.

SNTP Poll Interval: The period at which the SNTP client polls the server for time correction updates. Default 1 hour. If for any reason an SNTP poll fails the client will automatically perform 3 retries before waiting for the user defined poll period.

SNTP Sync: Displays whether the SNTP client is in sync with the specified SNTP server.

SNTP Last Sync: The timestamp of the last time the SNTP client successfully synchronized with the SNTP server.

System Clock: Displays the current system clock.

SNTP Time Zone: The SNTP time zone is a fixed offset from GMT that is added to the correct time to allow the expression of time in all geographic time zones.

When disabled the following options are available:

Set Time: Field used to set the current time (HH:MM:SS).

Set Date: Pull down menus to set the current date.

Time Zone: The time zone is a fixed offset from GMT that is added to the correct time to allow the expression of time in all geographic time zones.

Daylight Saving: Enables daylight saving by adding one hour to the displayed system clock timestamp.



8.3.14 Diagnostics

Link performance data is stored as a set of cascaded histograms:

- Histogram 1: the last hour at a resolution of 1 second
- Histogram 2: the last day (24 hours) at a resolution of 1 minute
- Histogram 3: the last month (30 days) at a resolution of 1 hour

The histograms are linked together by cascading data from one to the next: As a histogram fills up, the data overflow is used as input to the next histogram in the chain.

For example, raw data is collected at a 1 second resolution and stored in Histogram 1.

Once Histogram 1 fills up, every minute the oldest minute of data (i.e. the 60 oldest seconds) are analyzed and removed from the histogram (to make room for new data). The maximum, minimum and mean values are computed and inserted as the next data set in Histogram 2.

Once Histogram 2 fills up, every hour the oldest hour of data (i.e. the 60 oldest minutes) are analyzed and removed from the histogram (to make room for new data). The maximum, minimum and mean values are computed and inserted as the next data set in Histogram 3.

Once Histogram 3 fills up, every hour the oldest hour of data is discarded.

8.3.15 Diagnostics Plotter

The system has the diagnostics plotter facility shown in Figure 67.

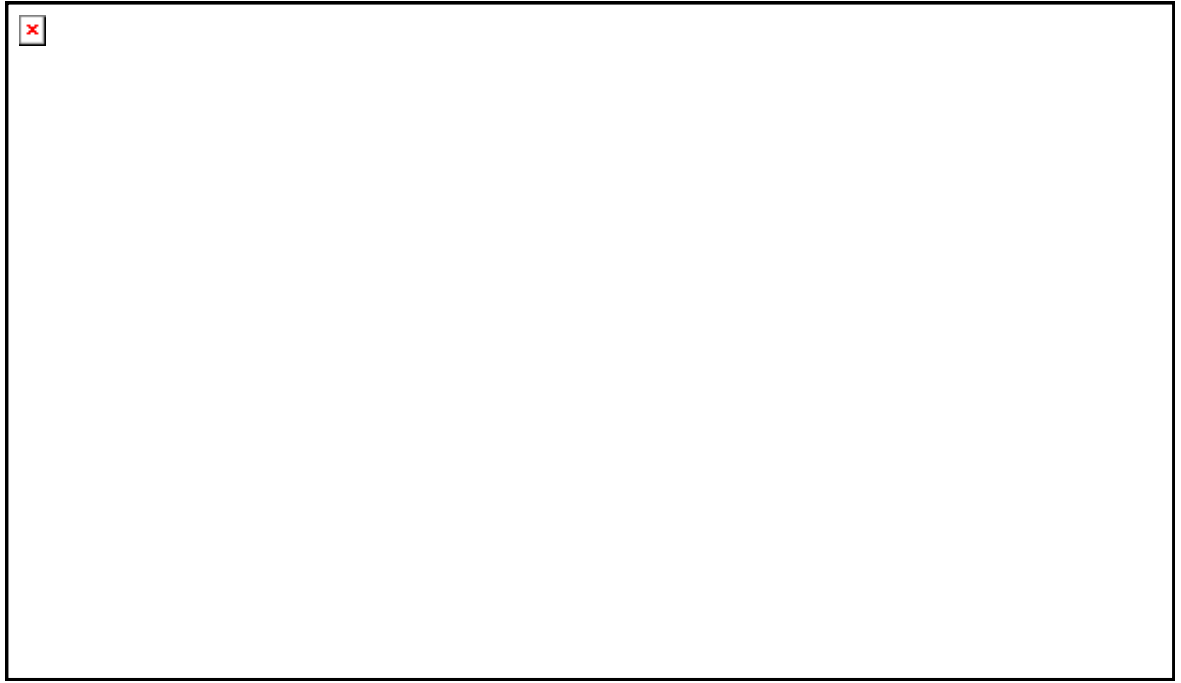

Figure 67 - Diagnostic Plotter

The diagnostic plotter allows the system administrator to view the cascading histogram data in an easily accessible graphical form. The plot always displays three traces, maximum, minimum and mean by default.

The diagnostic selector allows the user to select the various categories of histogram. The available histograms are:

- Vector Error
- Rx Power
- Tx Power
- Signal Strength Ratio V/H
- Link Loss
- Rx Data Rate
- Tx Data Rate
- Aggregate Data Rate
- Receive SNR
- Rx Gain



The diagnostic plotter displays all of the data from the cascaded Histograms 1, 2 and 3. It uses a bespoke x-axis with a compressed timeline so that resolution is not sacrificed. The most recent data is shown to the right, and the oldest data to the left.

The most recent hour's worth of data from Histogram 1 is displayed between 0 minutes (0m) and 60 minutes (60m) to the right of the x-axis; Data for the previous 24 hours from Histogram 2 is displayed between 60 minutes (60m) and 25 hours (25h) in the middle of the x-axis; Data for the previous 30 days from Histogram 3 is displayed between 25 hours (25h) and 31 days (31d) to the left of the x-axis.

The Trace selection allows the user to control which traces are plotted.

As with other management pages the page refresh period can be used to interactively monitor the wireless link.

8.3.16 Diagnostic Download

The diagnostics Download page allows the system administrator to download snapshots of system diagnostics.

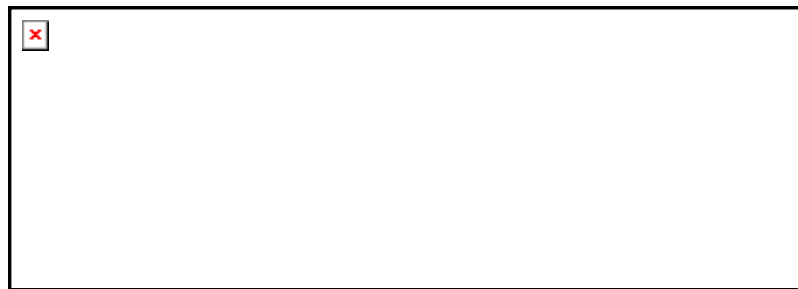

Figure 68 - CSV Download

The following diagnostics are available:

- Vector Error
- Rx Power
- Tx Power
- Signal Strength Ratio V/H
- Link Loss
- Rx Data Rate
- Tx Data Rate
- Aggregate Data Rate
- Receive SNR
- Rx Gain



All diagnostics are extracted from the associated status and statistics web page histograms. They are translated in a CSV file containing at most 5784²⁵ entries.

8.3.17 Change System Administration Password

This page (Figure 69) is used to change the password for the system administration (The factory default is blank).



Figure 69 - Password Change

To change the password any combination of alphanumeric characters, up to 31 characters in length, can be used.

²⁵ 5784 entries comprises 3600 entries for the first hour, 1440 entries for the next 24 hours and 744 entries for the next 31 days.

8.3.18 License Key

The License Key data entry page allows the system administrator to update the PTP 400 Series Bridge license key. Figure 70 shows a sample license key data entry page.



Figure 70 - Software License Key Data Entry

The user must enter the license key and click the 'Validate License Key' button to check that the key is valid and store it in non-volatile memory.

A license key is programmed into each unit during production and can be found written on the Configuration Data Summary Label which is attached to the Quick Start Guide. If subsequently the license key has been mislaid, replacement keys can be applied for online.

If a valid license key is not detected in the unit's non-volatile memory, the user is prompted to enter a valid key. It should be noted that PTP 400 Series Bridge are shipped as link pairs and as such, valid license keys are entered during the production process. Hence the user should never see the Software License Key screen (Figure 70).

To enter a license key simply type or paste the license key into the data entry box and click the 'validate license key' button.



If a valid license key is detected, the user will be presented with a message to say that the key is valid and that the system needs rebooting, as shown in Figure 71.



Figure 71 - License Key Reboot Screen

8.3.19 Properties

The web page properties screen allows the user to configure the web page interface.



Figure 72 - Webpage Properties

WEB Properties: Disable Front Page Login Allows access to homepage and status page web pages without forcing a login as the system administrator.

WEB Properties: Disable HTTP NO-CACHE META data Removes the HTTP NO-CACHE META clause from all dynamically created web pages.

Auto Logout Timer: Configures the time in minutes that the system administrator is automatically logged out if no web page activity is detected.



Distance Units: Swaps the default metric display of distance in to imperial units. For example Km into Miles.

Use Long Integer Comma Formatting: Enables long integer command formatting, i.e. 1234567 is presented as 1,234,457.

8.3.20 Reboot

The reboot page allows the system administrator to perform commanded reboots of the wireless unit. The reboot page also allows the system administrator to view a list of past reboot reasons. The reasons for the reboot field has been implemented as a drop down selection box, where the latest reason for reboot is located at the top of the list.

If the SNTP service from the remote management section above is active then the command reboot commands will be accompanied by the date and time the reboot was requested.

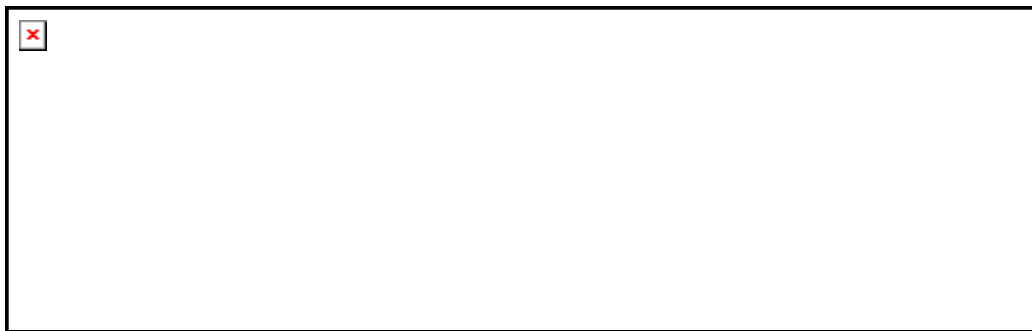

Figure 73 - System Reboot

9 Fault Finding

If communication has been lost with the unit at the near end of the link, there may be a hardware fault with the wiring, network or hardware. Go to the hardware section below. If communication with the far end of the link is lost then go to the radio section below.

9.1 Hardware

If there are problems suspected with the link hardware the following procedure is recommended. The following diagram illustrates the main system connections.

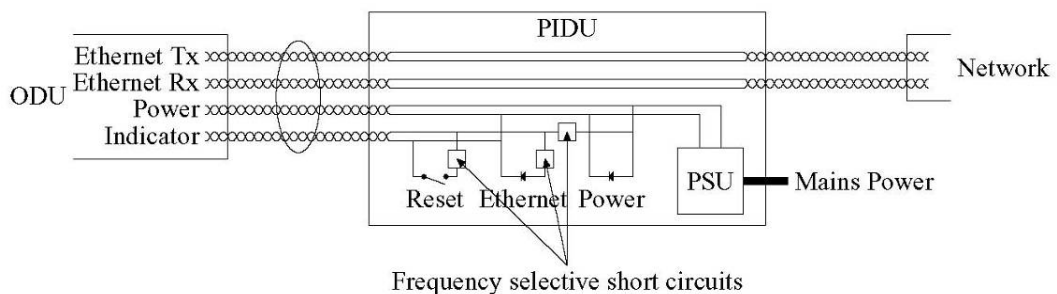

Figure 74 - Main System Connections

9.1.1 Power

Check the power LED at each end of the link. If the power lights are illuminated go to the Ethernet section below. If at either end they are not illuminated then²⁶ check the Ethernet LED. If neither is illuminated then there is no voltage on the power wires to the ODU.

1. Check that the mains power is connected and switched on.
2. Check that the lamp illuminates if the ODU connector is disconnected at the PTP 400 Series Bridge PIDU Plus. (Remove the PIDU Plus cover).
 - a. If it does illuminate then either the ODU is drawing too much current, or the power wiring to the ODU is short circuited or the PSU is supplying insufficient power. The likely fault can be determined by removing the jumper (J905), found inside the removable cover of the PIDU Plus, and measuring the current taken with an ammeter placed across the 2 jumper pins. This is normally 10mA without the ODU connected and 300mA to 1A when the ODU is connected.

²⁶ The power indicator LED should be continually illuminated.



- b. If it does not illuminate then recheck that power is applied to the PIDU Plus by measuring the voltage across +55V and 0V pads inside the removable cover in the PIDU Plus. Check that the PIDU Plus is not short circuited by measuring the impedance across the Power connector. Is the lamp faulty?

9.1.2 Ethernet

The Ethernet LED is driven from the ODU processor and thus is capable of informing you of many conditions using different flash sequences. If the Ethernet indicator does not illuminate at all there are four possible conditions:

1. There is no power reaching the ODU because of a wiring fault
2. The ODU is faulty
3. The PIDU Plus is faulty
4. The Ethernet network side is faulty

Look at the following table to check the LED response for power up, disconnect the power and reapply and note what happens.

Differentiating between 1--3 and 4 can be achieved by cycling the mains power. Watch the Ethernet indicator for 1 minute, if it never flashes then the problem is 1—3. Take the jumper (J905) out of the PIDU Plus and check the current taken by the ODU. This should be 300mA to 1A when starting through to running normally.

If the Ethernet indicator flashes initially but then stops flashing, the ODU is powered and software loaded but Ethernet connectivity has been lost between the ODU and the users connected equipment. All Ethernet connections should be rechecked.



Power Indoor Unit LED check chart:

Mode	Green LED	Yellow LED No Ethernet Cable Connected	Yellow LED Ethernet Cable Connected between PIDU Plus and NIC/Switch/Hub
No Power Applied	Off	Off	Off
Power Applied	On	Will flash once per second regularly approximately 16 seconds after power applied for 10 seconds then will go out and stay out	Will flash regularly once per second approximately 16 seconds after power applied for 10 seconds then operate as Ethernet Link/Activity LED
Valid Ethernet Link and no traffic	On	N/A	Will be on solid for a valid link.
Valid Ethernet Link with traffic	On	N/A	Will be on solid, but will blink randomly as traffic passes through
While Recovery Switch Pressed	On	Off	Off
Recovery Switch Pressed and released within 10 seconds during normal operation	On	Off	Off while switch pressed but returns to LINK/Activity state when released. No reset will take place
Recovery Switch Pressed and held for > 20 seconds during normal operation	On	Off while switch pressed. One second after release, flashes twice per second regularly for 10 seconds, then erases non-volatile configuration data and resets. The erasure will reset all the unit's configuration apart from the last known wireless link configuration. This ensures that after a reset the wireless link SHOULD re-establish without any user intervention. The IP address will be reset to 169.254.1.1 ²⁷	
Recovery Switch Pressed and held for >40 seconds from power on (Recovery is pressed while power is applied)	On	Off while switch pressed. One second after release, flashes regularly twice per second for 10 seconds. Then erases non-volatile configuration data & the downloaded image and resets. The erasure will reset all the unit's configuration apart from the last known wireless link configuration. This ensures that after a reset the wireless link SHOULD re-establish without any user intervention. The IP address will be reset to 169.254.1.1 and the unit will boot the fixed software image.	

²⁷ It is possible that some units may have been previously configured with IP addresses 10.10.10.10 (Slave) and 10.10.10.11 (Master). Therefore the IP address will be reset to 10.10.10.10/11.



9.2 Radio

9.2.1 No Activity

If communication over the radio link has been lost and the unit at the other end of the link can be managed on its local network, the following procedure should be adopted:

If there is no wireless activity then the configuration should be checked. It is essential that the following items are correct

- Check for Alarm conditions on Home page
- Check that the software at each end of the link is the same version
- Check that the Target Mac address has not been mis-configured at each end of the link.
- Check Range
- Check Tx Power
- Check License key
- Check Master Slave
- Check that the link has not been further obscured or the ODU misaligned.
- Check the Spectrum Management page at each end of the link and establish that there is a quiet wireless channel to use.

If there are no faults found in the configuration and there is absolutely no wireless signal retry the installation procedure. If this doesn't work then the ODU may be faulty.

9.2.2 Some Activity

If there is some activity but the link is unreliable or doesn't achieve the data rates required then

- Check that the interference has not increased using the DFS measurements
- If a quieter channel is available check that it is not barred
- Check that the path loss is low enough for the communication rates required
- Check that the ODU has not become misaligned
- Check that one or both ends of the link are not in installation mode (ARMED)

10 System Connections

The following describes the interconnections between the system components:

10.1.1 ODU to PIDU Plus Connection

Figure 75 shows the interconnections between the ODU and PIDU Plus modules.

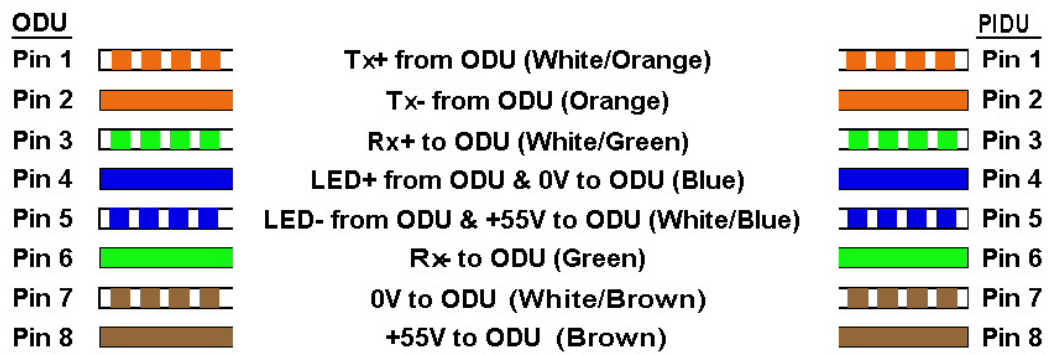

Figure 75 - ODU to PIDU Plus Connection Diagram



11 Lightning Protection

EMD (Lightning) damage is not covered under warranty

The recommendations in this user manual when installed correctly give

the user the best protection from the harmful effects of **EMD**

However 100% protection is not implied or possible

11.1 Overview

The idea of lightning protection is to protect structures, equipment and people against lightning by conducting the lightning current to ground via a separate preferential solid path and by reducing the electromagnetic field.

The following should be treated as a guide only, the actual degree of lightning protection required depends on local conditions and weather patterns and applicable local regulations. Full details of lightning protection methods and requirements can be found in the international standards IEC 61024-1 and IEC 61312-1, the U.S. National Electric Code ANSI/NFPA No. 70-1984 or section 54 of the Canadian Electric Code.

11.1.1 Lightning Protection Zones

The installation of the ODU can be classified into two different lightning protection zones.

Zone A — in this zone a direct lightning strike is possible.

Zone B — in this zone a direct lightning strike is unusual, but the un-attenuated electromagnetic field is still present.

The zones are determined using the 'rolling sphere method', an imaginary sphere, typically 50 meters (164 feet) in radius is rolled over the structure. All structure points that contact the sphere, (Zone A) indicate the zone where a direct strike is possible. Similarly points that do not contact the sphere indicate a zone (zone B) where a direct strike is less likely.

The following diagrams (Figure 76 and Figure 77) show this zoning pictorially:



Equipment mounted in Zone A should be capable of carrying the full lightning current. Mounting of the ODU in Zone A is not recommended, and should only be carried out observing the rules governing installations in Zone A²⁸. Failure to do so may put structures, equipment and life at risk.

Equipment mounted in Zone B should be grounded using grounding wire of at least 8 AWG. This grounding wire should be connected to a grounding rod or the building grounding system before entry in to building.

The ODU grounding point for the PTP 400 Series Bridge can be found on the bottom of the unit, and is supplied with an appropriate grounding lug for attachment to the ODU.

11.2 Detailed Installation

The recommended components for an installation protected for nearby strikes are:

- Grounding Kits — Andrew Type 223158 (www.andrew.com)
- Screened CAT 5e Cable also known as Shielded CAT 5e or CAT 5e STP (Shielded Twisted Pair)
- Surge Arrestor: Transtector Type ALPU-ORT - 4 per link (www.transtector.com)
- Grounding Stake
- RJ45 screened connectors
- 8 AWG Grounding Cable – Minimum size, preferably 6 or 4
- NB: There may be a local regulatory requirement to cross bond the CAT 5e cable at regular intervals to the mast. This may be as frequent as every 10 meters (33 feet)

²⁸ Local regulations may also require the fitting of the 8 AWG ground wire referred below.

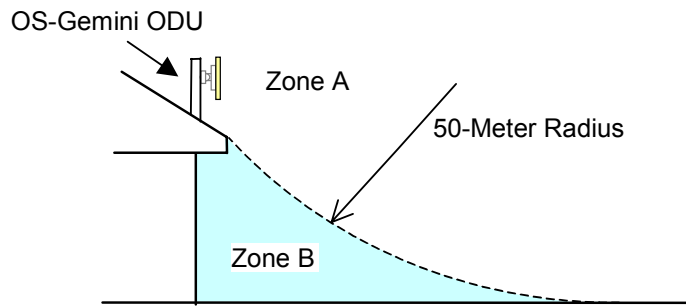
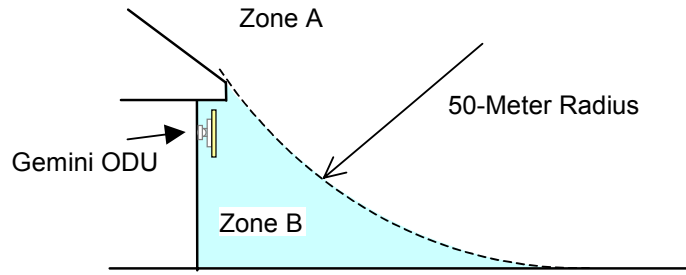

Figure 76 - ODU mounted in Zones A & B

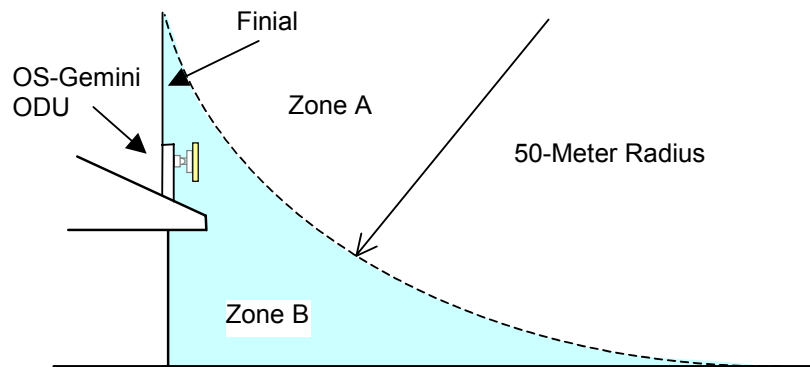

Figure 77 - Showing how the use of a Finial enables the ODU to be mounted inside Zone B

	Zone A	Zone B
Earth ODU	Mandatory	Mandatory
Screen Cable	Mandatory	Mandatory
Surge Arrestor Unit at ODU – ALPU-ORT	Mandatory	Mandatory
Earth Cable at Building Entry	Mandatory	Mandatory
Surge Arrestor Unit at Building Entry – ALPU-ORT	Mandatory	Mandatory

Table 15 - Protection Requirements

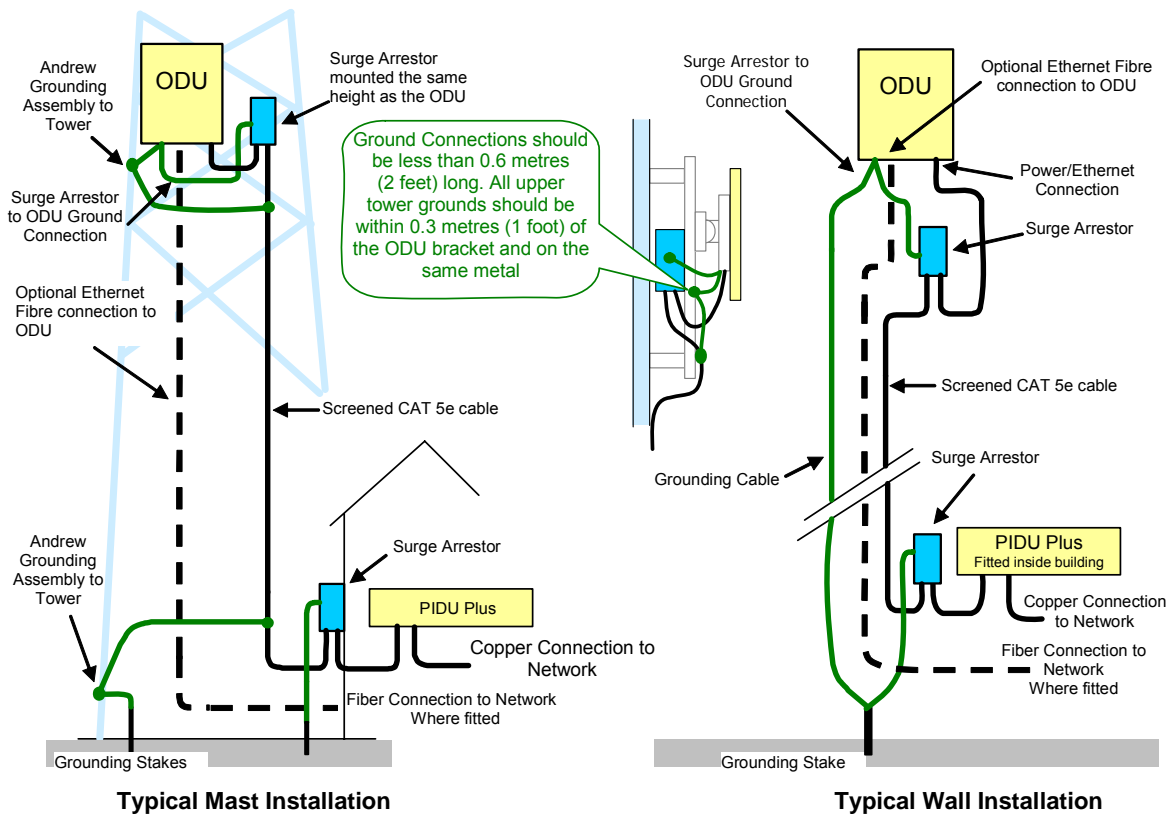

Figure 78 - Diagrammatically showing typical wall and mast installations

A typical installation is shown in Figure 79 and Figure 80.

Note: Grounding Points are shown unprotected for clarity. Grounding points should be adequately weatherproofed to prevent corrosion and possible loss of ground continuity.



Figure 79 - Upper Grounding Configuration

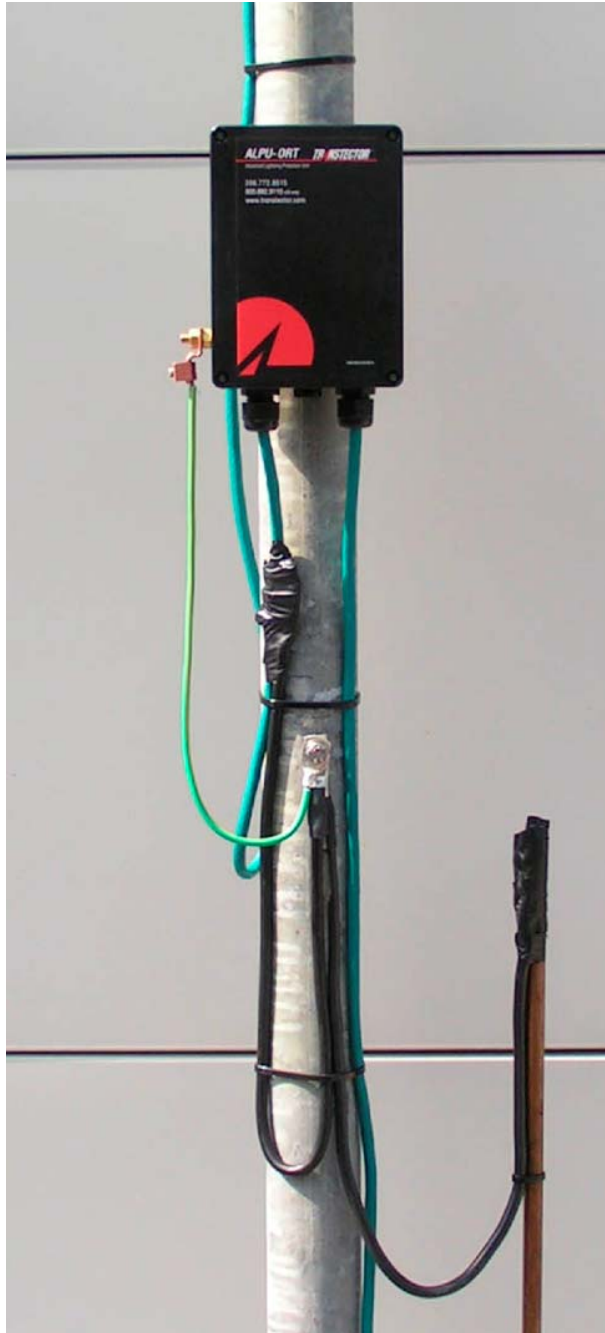

Figure 80 - Lower Grounding Configuration

The Andrew Grounding Kit at the ODU is optional providing a Surge Arrestor Unit is located at the ODU and is reliably grounded. However, it may be a regulatory requirement to cross-bond the screened CAT-5 at regular intervals up the mast. Refer to local regulatory requirements for further details.



The PTP 400 Series Bridge PIDU Plus to ODU cable requires Surge Arrestor Units mounted at both ends of the cable. At the ODU, the Surge Arrestor Unit should be mounted within 0.3m (1 foot) of the ODU and must be grounded to the ODU. For most installations, the Surge Arrestor Unit should be mounted at the same height as the ODU.

The lower Surge Arrestor Unit should be mounted at the building entry point and must be grounded.

The termination of the CAT-5 Cable into the Surge Arrestor Unit is illustrated in Table 16, Table 17 and Figure 81. The screen from the cable must be terminated into the ground terminal within the unit to ensure the continuity of the screen. Earth Sleeving should be used to cover the shield ground connection to prevent internal shorting within the unit.

Terminal Identification	Conductor	RJ45 Pin
CON3 Pin 1	Orange/White	1
CON3 Pin 2	Orange	2
CON3 Pin 3	Green/White	3
CON3 Pin 6	Green	6
CON1 Pin 4	Blue	4
CON1 Pin 5	Blue/White	5
CON1 Pin 7	Brown/White	7
CON1 Pin 8	Brown	8

Table 16 - Surge Arrestor ALPU-ORT Cable 1 Termination



Terminal Identification	Conductor	RJ45 Pin
CON4 Pin 1	Orange/White	1
CON4 Pin 2	Orange	2
CON4 Pin 3	Green/White	3
CON4 Pin 6	Green	6
CON2 Pin 4	Blue	4
CON2 Pin 5	Blue/White	5
CON2 Pin 7	Brown/White	7
CON2 Pin 8	Brown	8

Table 17 - Surge Arrestor ALPU-ORT Cable 2 Termination

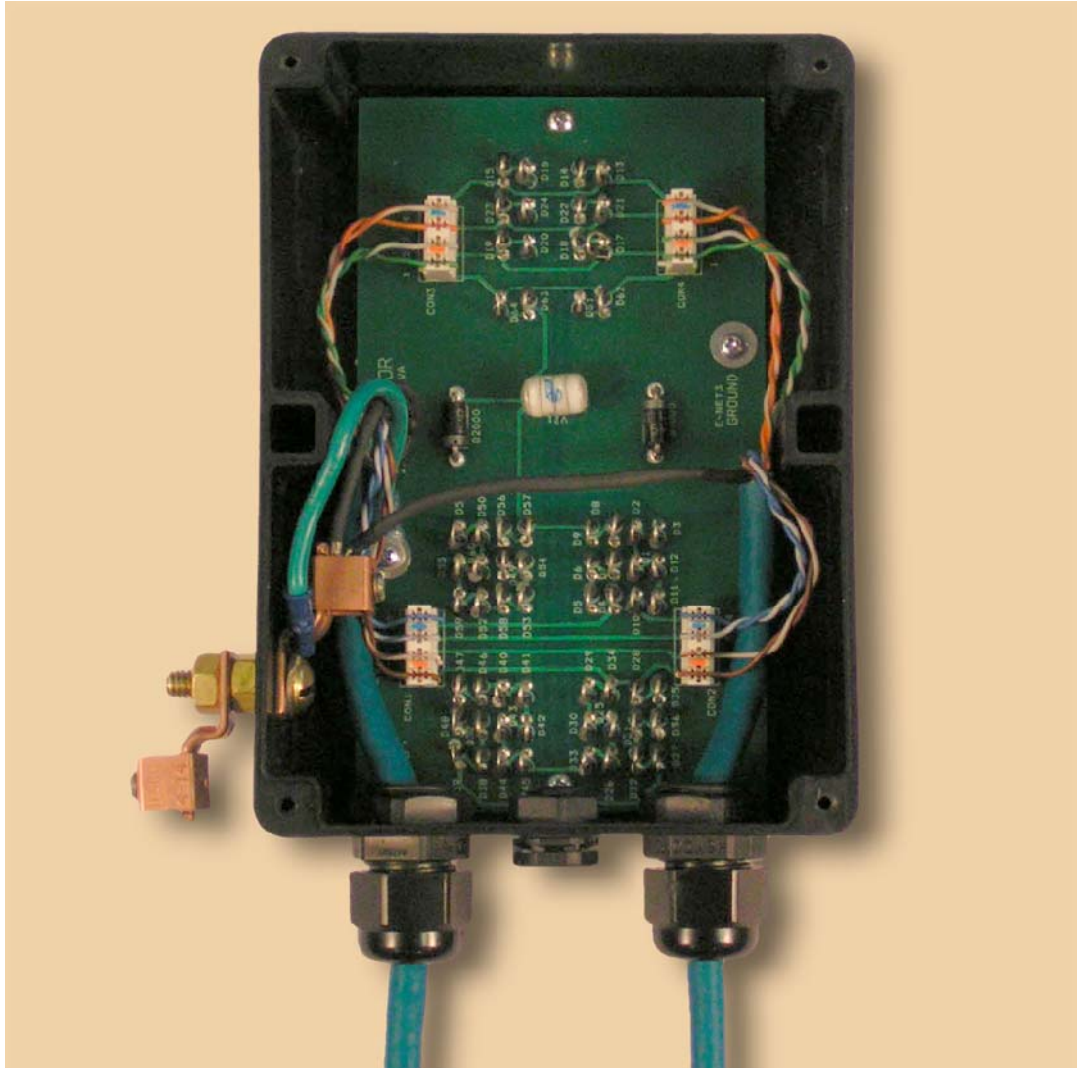

Figure 81 - Surge Arrester ALPU-ORT Connection Illustration

Note: Cable screens have been sleeved.

11.3 Testing Your Installation

If you have followed the above instructions you will have wired your system to the following diagram:

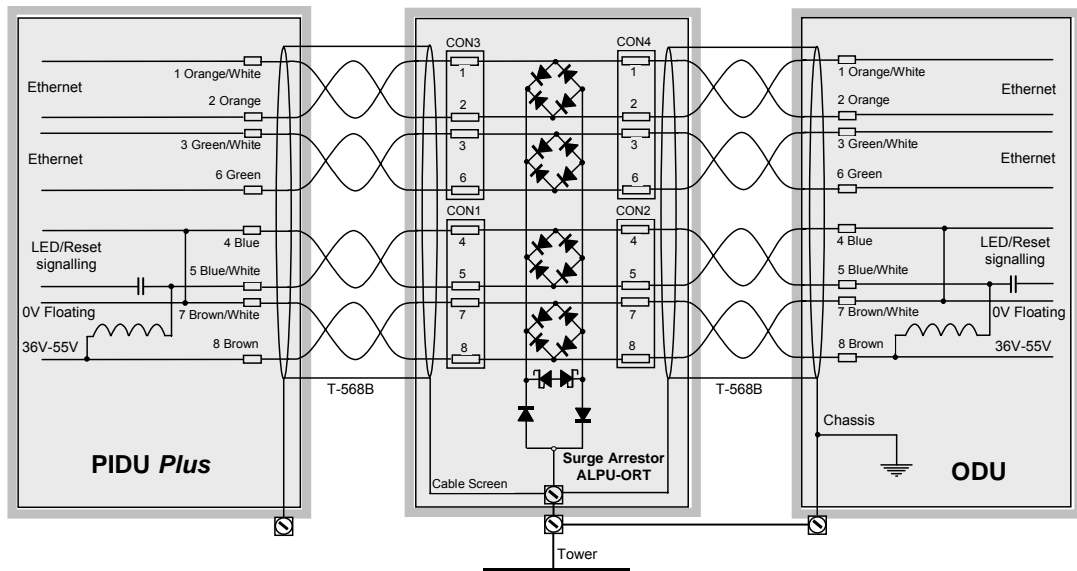

Figure 82 - Simplified Circuit Diagram (Only One Transtector Shown For Clarity)

11.3.1 Pre-Power Testing

Before plugging in the RJ45 to the PIDU Plus, check the following impedances at the RJ45:

1. Check the cable resistance between pins 7 and 4 at the RJ45. Check against column 2 in the Table 18.
2. Check the resistance between pins 8 and 5 at the RJ45. Check against column 3 in the Table 18.
3. Check the resistance between pins 7 and 8 at the RJ45. The value should be greater than 1000 ohms.

CAT-5 Length meters	Resistance pins 4-7 ohms	Resistance pins 8-5 ohms
0	0.0	2.3
10	1.7	4.0
20	3.4	5.7
30	5.1	7.4
40	6.8	9.1
50	8.5	10.8
60	10.2	12.5
70	11.9	14.2
80	13.6	15.9
90	15.3	17.6
100	17.0	19.3

Table 18 - Resistance Table Referenced To The RJ45 At The PIDU Plus

11.3.2 Post-Power Testing

- 1 Connect the RJ45 to the PIDU and apply power. The power LED should be illuminated continuously. If the power LED does not illuminate unplug the ODU connection from the PIDU and check the power LED illumination. If the power LED still does not light then check the power source.
- 2 The Ethernet LED should be observed starting with 10 slow flashes, 30 seconds after powering. This confirms that the ODU has the correct power connections, if the Ethernet LED does not light check the wiring to pins 4 & 5 and 7 & 8.
- 3 If a computer, switch or router is connected to the LAN side of the PIDU Plus then the Ethernet LED should flash with network activity. If the Ethernet LED does not show Ethernet activity then the network equipment and the Ethernet cables need to be checked, specifically continuity through to the ODU of pins 1 & 2 and 3 & 6.



12 Wind Loading

12.1 General

Antennas and electronic equipment mounted on towers or pole mounted on buildings will subject the mounting structure to lateral forces when there is appreciable wind. Antennas are normally specified by the amount of force (in pounds) for specific wind strengths.

The magnitude of the force depends on both the wind strength and size of the antenna.

12.2 Calculation of Lateral Force

The PTP 400 Series Bridge with or without the integral antenna is essentially a flat structure and so the magnitude of the lateral force can be estimated from:

$$\text{Force (in pounds)} = 0.0042 \cdot A \cdot v^2$$

Where A is the surface area in square feet and v is the wind speed in miles per hour. The lateral force produced by a single PTP 400 Series Bridge Unit at different wind speeds is shown below:

Item	Largest Surface Area (sq ft)	Lateral Force (pounds) at wind speed (mph)				
		80	100	120	140	150
PTP 400 Series Bridge - integrated antenna	1.36	37	57	82	112	129
PTP 400 Series Bridge - Connectorized	1.00	27	42	60	82	95

The equivalent table in metric units is:

Item	Largest Surface Area (metres ²)	Lateral Force (kg) at wind speed (meters/sec)				
		30	40	50	60	70
PTP 400 Series Bridge - integrated antenna	0.1300	12	22	34	49	66
PTP 400 Series Bridge - Connectorized	0.0930	9	16	24	35	48



Note: When the connectorized version of PTP 400 Series Bridge is used with external antennas, the figures from the antenna manufacturer for lateral force should be included to calculate to total loading on the mounting structure.

12.3 Capabilities of the PTP 400 Series Bridges

The structure and mounting brackets of PTP 400 Series Bridge systems are capable of withstanding wind speeds up to 150mph (242kph). The installer should ensure that the structure to which the PTP 400 Series Bridge is fixed to is also capable of withstanding the prevalent wind speeds and loads.

12.4 Wind Speed Statistics

Installers are recommended to contact the national meteorological office for the country concerned to identify the likely wind speeds prevalent at the proposed location. This will enable the installer to estimate the total wind loading on the support structures. Examples of the sort of statistics that are available are:

- USA Reported Fastest Single Wind Velocities for Selected U.S. Cities (Source: National Weather Service)

City, State	Wind Velocity (mph)
Bismarck, North Dakota	72
Buffalo, New York	91
Chicago, Illinois	87
Hatteras, North Carolina	110
Miami, Florida	132
New York, New York	99
Pensacola, Florida	114

- UK Meteorological Office (www.met.gov.uk), peak wind speed contour maps can be found as Fig 3a/3b at: <http://www.met.gov.uk/education/historic/1987.html>



13 PTP 400 Series Bridge - Connectorized version of the PTP 400 Series bridge

13.1 Scope

This section details the changes and additional features relevant to the Connectorized version of the PTP 400 Series bridge.

13.2 Product Description

13.2.1 Hardware

The Connectorized version of the PTP 400 Series Bridge is a variant designed to provide the system integrator and installer with the ability to provide extra capability to cope with very difficult radio links compared to the PTP 400 Series Integrated product. The variant allows the use of a variety of externally mounted antennas, either Flat Plate or Dish, which have higher gains than provided by the integrated antenna that is normally used.



Figure 83 - Connectorized version of the PTP 400 Series bridge Outdoor Unit



Note: Connectorized version of the PTP 400 Series bridge are supplied without Antennas



13.2.2 Antenna Choices – 4.9 GHz

The integrated antenna has a gain of 22dBi.

In FCC/Industry Canada regions when using antennas with >26 dBi of gain it is necessary to turn down the TX Power by the number of dB that 26 dBi has been exceeded.

13.2.3 Antenna Choices – 5.8 GHz

The integrated antenna has a gain of 23.5 dBi.

In non-FCC regions antenna choice is not restricted but any region specific EIRP limit should be obeyed, see Table 7 in section 5.2 “Region Codes”

In FCC regions external antennas from the list in Section 13.7 “Antennas for 5.8GHz FCC Regions” can be used with the Connectorized version of the PTP 400 Series bridge. These are approved by the FCC for use with the product and are basically constrained by the following limits:

- Single Polarization Flat Plate Antennas – up to 28dBi per antenna.
- Single/Dual Polarization Parabolic Dish Antennas – up to 37.7dBi per polarization or antenna.

In FCC regions when using external antennas – cable loss between the Connectorized version of the PTP 400 Series bridge and the antenna ports must not be less than 1.2dB

13.3 Software/Features

The variant operates in the same way as the basic PTP 400 Series Bridge product and is released initially with the feature set of the Connectorized version of the PTP 400 Series bridge. The areas where the functionality is modified are:

13.3.1 Status Page

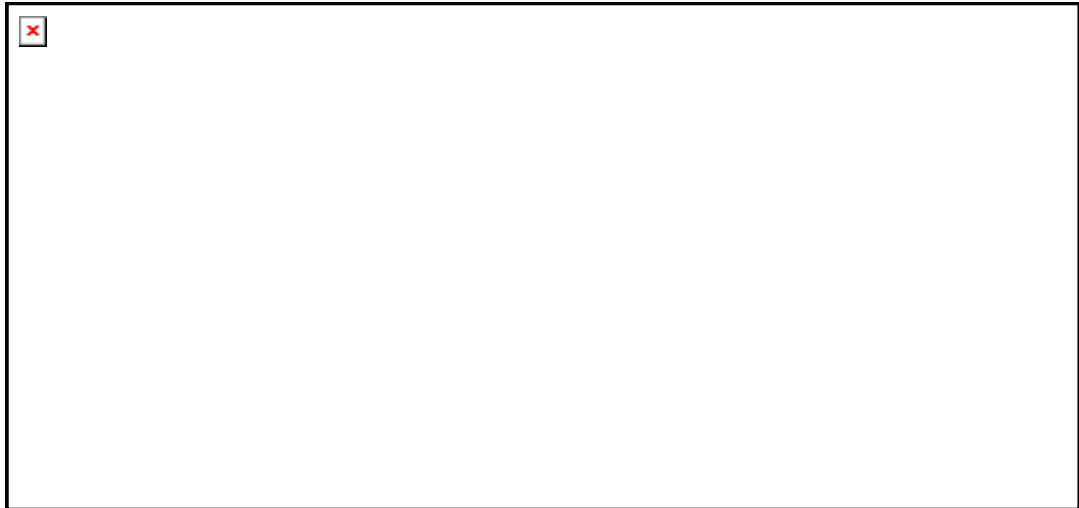

Figure 84 - Connectorized version of the PTP 400 Series bridge Status Page

The link loss calculation presented on the Status Page on the management interface has to be modified to allow for the increased antenna gains at each end of the link. The manufacturing process of the Connectorized version of the PTP 400 Series bridge configures the standard hardware of the unit for use with external antennas. The installer is prompted, as part of the installation process, to enter the gain of the external antenna(s) and cable losses at each end of the link. Peer-2-Peer messaging is used to pass the effective antenna gain to each end of the link so that the link loss calculations can be correctly computed.

13.3.2 Configuration Pages

The amended Configuration Web page is shown below as Figure 85.



Figure 85 - Connectorized version of the PTP 400 Series bridge 'System Configuration' Page

Antenna Gain: Gain of the antenna you are connecting to the unit, see Table 20 - Allowed Antennas for Deployment in USA/Canada.

Note: The default Antenna gain for the 4.9 GHz variant is 22 dBi.

Cable Loss: in the cable between the ODU and the antenna. Note: In the event that there is a significant difference in length of the antenna cables for the two antenna ports, then the average value should be entered.

EIRP: (Effective Isotropic Radiated Power) This field indicates the EIRP, in dBm, for the Entered "Max Transmit Power", "Antenna Gain" and "Cable Loss" parameters.



13.3.3 Installation Pages

The installer is prompted to enter the Antenna Gain and Cable Loss (Connectorized version of the PTP 400 Series bridge to antenna) at each end of the link. The Installation Page(s) is shown as Figure 86 to Figure 88.



Figure 86 - Connectorized version of the PTP 400 Series bridge 'Installation Wizard' Page

Additional fields on this page are "Antenna Gain", "Cable Loss" and "EIRP". See the previous section for more detail.

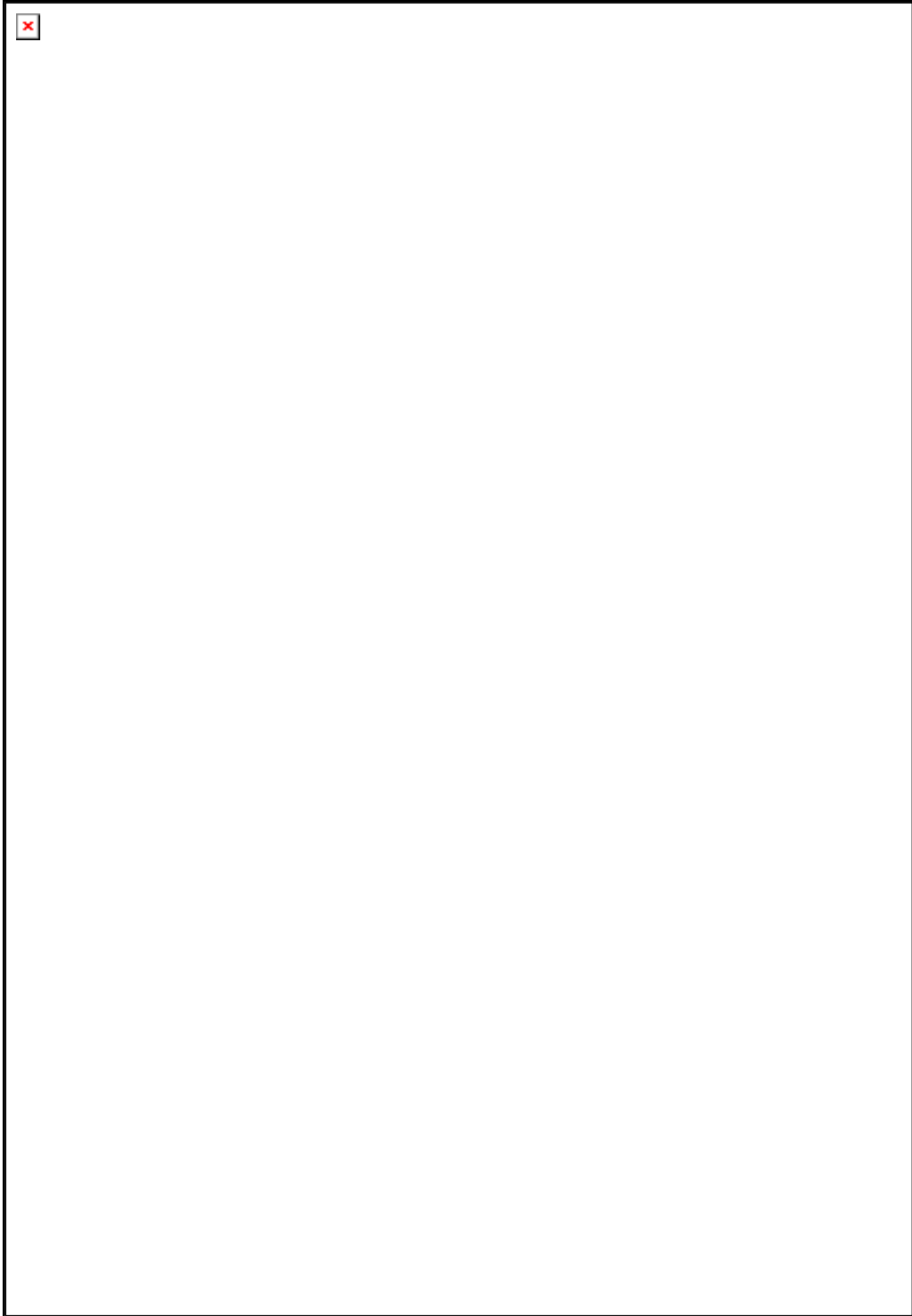

Figure 87 - Connectorized version of the PTP 400 Series bridge 'Confirm Installation'
Page

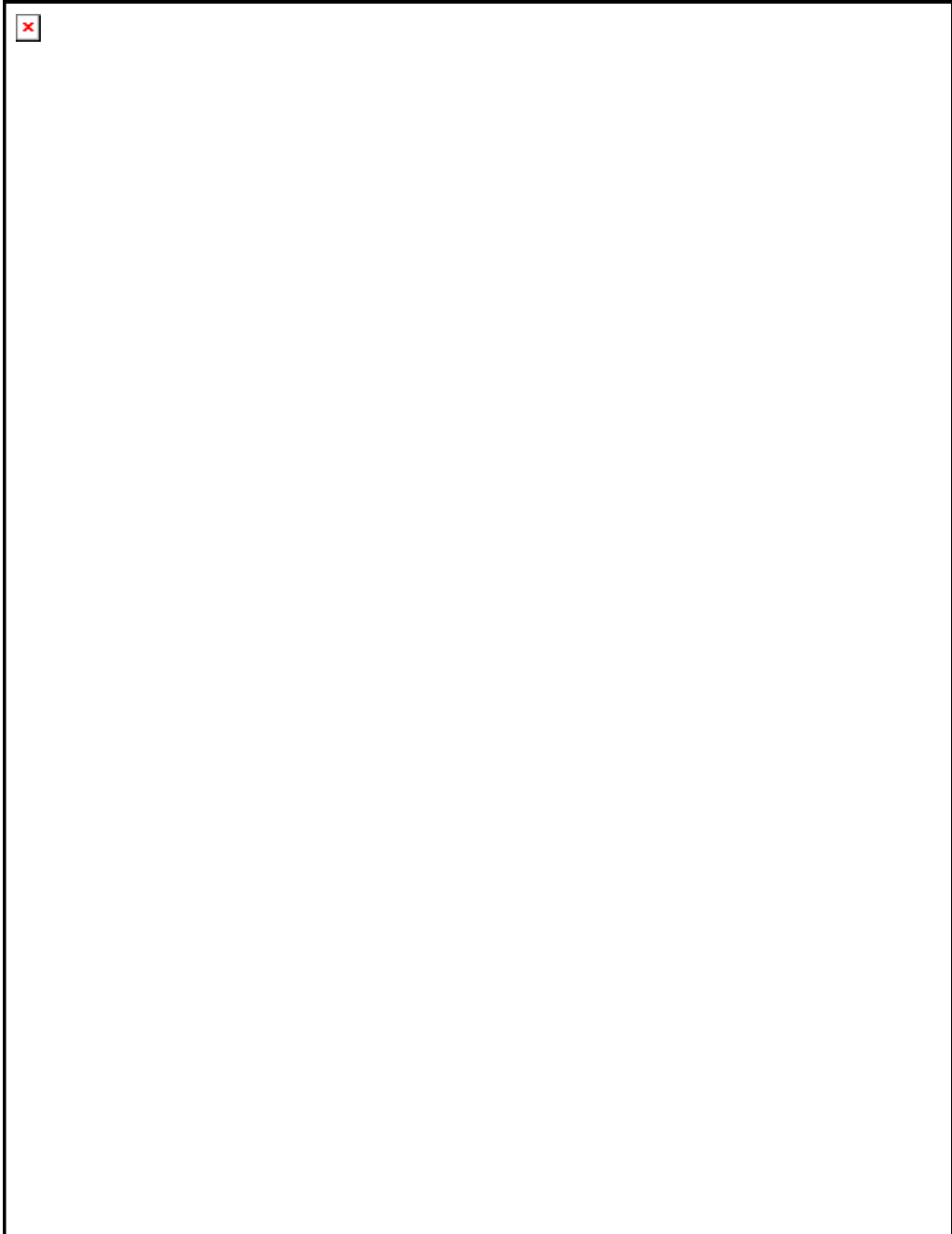

Figure 88 - Connectorized version of the PTP 400 Series bridge 'Disarm Installation'
Page



13.4 Deployment Considerations

The majority of radio links can be successfully deployed with the PTP 400 Series Bridge. It should only be necessary to use external antennas where the Link Budget Calculator indicates marginal performance for a specific link – for example, when the link is heavily obscured by dense woodland on an NLOS link or extremely long LOS links (>80km or > 50 miles) over water.

The external antennas can be either dual-polarization (as the integrated antenna) or two single polarized antennas can be used in a spatially diverse configuration. It is expected that the dual-polarization antennas would normally be used to simplify the installation process; spatially diverse antennas may provide additional fade margin on very long LOS links where there is evidence of correlation of the fading characteristics on Vertical and Horizontal polarizations.

Dual polarization antennas (with a gain greater than the integrated antenna) are currently only available in parabolic dish form.

13.5 Link Budget

An estimate of the link budget for a specific application can be obtained by using the Motorola link estimation tools. For more information see the Motorola web site.

13.6 Regulatory Issues

In countries where FCC regulations are not relevant, installations should conform to any applicable local regulations for the Equivalent Isotropic Radiated Power (EIRP).

Ensuring compliance becomes more complex when the Connectorized unit is used with external antennas, which may be locally sourced. With higher gain external antennas fitted, the Maximum Transmit power may need to be reduced for operation in specific countries.

See Table 7 in section 5.2 “Region Codes” for any EIRP restrictions that may apply in your region.

13.6.1 Antenna Choice (5.8GHz FCC Regions Only)

The antennas which can be deployed with the Connectorized version of the PTP 400 Series bridge are shown in Table 20.



13.6.2 Cable Losses (5.8 GHz FCC Regions Only)

The FCC approval for the product is based on tests with a cable loss between the units of 1.2dB at 5.8GHz. The use of lower cable losses would result in the installation being outside the FCC rules.

As an indication, 1.2dB of cable loss corresponds to the following cable lengths excluding connector losses (source: Times Microwave).

Cable	Length for 1.2dB Cable Loss at 5.8GHz	
	(ft)	(m)
LMR100	1.9	0.6
LMR200	4.6	1.4
LMR300	7.25	2.2
LMR400	11.1	3.4

Table 19 - Cable Losses per Length

13.7 Antennas for 5.8GHz FCC Regions

Manufacturer	Antenna Type	Gain (dBi)	Flat Plate	Parabolic Dish
Andrew	Andrew 1-foot Flat Panel, FPA5250D12-N (23.6dBi)	23.6	Y	
Andrew	Andrew 2-foot Flat Panel, FPA5250D24-N (28dBi)	28	Y	
Gabriel	Gabriel 1-foot Flat Panel, DFPD1-52 (23.5dBi)	23.5	Y	
Gabriel	Gabriel 2-foot Flat Panel, DFPD2-52 (28dBi)	28	Y	
MTI	MTI 17 inch Diamond Flat Panel, MT-485009 (23dBi)	23	Y	
MTI	MTI 15 inch Dual-Pol Flat Panel, MT-485025/NVH (23dBi)	23	Y	
MTI	MTI 2 ft Directional Flat Panel, MT-20004 (28dBi)	28	Y	
MTI	MTI 2 ft Flat Panel, MT-486001 (28dBi)	28	Y	
RFS	RFS 1-foot Flat Panel, MA0528-23AN (23dBi)	23	Y	
RFS	RFS 2-foot Flat Panel, MA0528-28AN (28dBi)	28	Y	
Telectronics	Telectronics 2-foot Flat Plate Antenna, ANT-P5828 (28dBi)	28	Y	
Andrew	Andrew 2-foot Parabolic, P2F-52 (29.4dBi)	29.4		Y
Andrew	Andrew 2-foot Dual-Pol Parabolic, PX2F-52 (29.4dBi)	29.4		Y



Manufacturer	Antenna Type	Gain (dBi)	Flat Plate	Parabolic Dish
Andrew	Andrew 3-foot Parabolic, P3F-52 (33.4dBi)	33.4		Y
Andrew	Andrew 3-foot Dual-Pol Parabolic, PX3F-52 (33.4dBi)	33.4		Y
Andrew	Andrew 4-foot Parabolic, P4F-52 (34.9dBi)	34.9		Y
Andrew	Andrew 4-foot Dual-Pol Parabolic, PX4F-52 (34.9dBi)	34.9		Y
Andrew	Andrew 6-foot Parabolic, P6F-52 (37.6dBi)	37.6		Y
Andrew	Andrew 6-foot Dual-Pol Parabolic, PX6F-52 (37.6dBi)	37.6		Y
Gabriel	Gabriel 2-foot High Performance QuickFire Parabolic, HQF2-52-N	28.2		Y
Gabriel	Gabriel 4-foot High Performance QuickFire Parabolic, HQF4-52-N	34.4		Y
Gabriel	Gabriel 6-foot High Performance QuickFire Parabolic, HQF6-52-N	37.4		Y
Gabriel	Gabriel 2-foot High Performance Dual QuickFire Parabolic, HQFD2-52-N	28.1		Y
Gabriel	Gabriel 4-foot High Performance Dual QuickFire Parabolic, HQFD4-52-N	34.3		Y
Gabriel	Gabriel 6-foot High Performance Dual QuickFire Parabolic, HQFD6-52-N	37.3		Y
Gabriel	Gabriel 2-foot Standard QuickFire Parabolic, QF2-52-N	28.5		Y
Gabriel	Gabriel 2-foot Standard QuickFire Parabolic, QF2-52-N-RK	28.5		Y
Gabriel	Gabriel 2.5-foot Standard QuickFire Parabolic, QF2.5-52-N	31.2		Y
Gabriel	Gabriel 4-foot Standard QuickFire Parabolic, QF4-52-N	34.8		Y
Gabriel	Gabriel 4-foot Standard QuickFire Parabolic, QF4-52-N-RK	34.8		Y
Gabriel	Gabriel 6-foot Standard QuickFire Parabolic, QF6-52-N	37.7		Y
Gabriel	Gabriel 2-foot Standard Dual QuickFire Parabolic, QFD2-52-N	28.4		Y
Gabriel	Gabriel 2.5-foot Standard Dual QuickFire Parabolic, QFD2.5-52-N	31.1		Y
Gabriel	Gabriel 2-foot Standard Dual QuickFire Parabolic, QFD2-52-N-RK	28.4		Y
Gabriel	Gabriel 4-foot Standard Dual QuickFire Parabolic, QFD4-52-N	34.7		Y
Gabriel	Gabriel 4-foot Standard Dual QuickFire Parabolic, QFD4-52-N-RK	34.7		Y
Gabriel	Gabriel 6-foot Standard Dual QuickFire Parabolic, QFD6-52-N	37.7		Y
RadioWaves	Radio Waves 2-foot Dual-Pol Parabolic, SPD2-5.2 (28.1dBi)	28.1		Y



Manufacturer	Antenna Type	Gain (dBi)	Flat Plate	Parabolic Dish
RadioWaves	Radio Waves 2-foot Parabolic, SP2-5.2 (29.0dBi)	29		Y
RadioWaves	Radio Waves 3-foot Dual-Pol Parabolic, SPD3-5.2 (31.1dBi)	31.1		Y
RadioWaves	Radio Waves 3-foot Parabolic, SP3-5.2 (31.4dBi)	31.4		Y
RadioWaves	Radio Waves 4-foot Dual-Pol Parabolic, SPD4-5.2 (34.4dBi)	34.4		Y
RadioWaves	Radio Waves 4-foot Parabolic, SP4-5.2 (34.8dBi)	34.8		Y
RadioWaves	Radio Waves 6-foot Dual-Pol Parabolic, SPD6-5.2 (37.5dBi)	37.5		Y
RadioWaves	Radio Waves 6-foot Parabolic, SP6-5.2 (37.7dBi)	37.7		Y
RadioWaves	Radio Waves 2-foot Parabolic, SP2-2/5 (28.3dBi)	28.3		Y
RadioWaves	Radio Waves 3-foot Parabolic, SP3-2/5 (31.4dBi)	31.4		Y
RadioWaves	Radio Waves 4-foot Parabolic, SP4-2/5 (34.6dBi)	34.6		Y
RadioWaves	Radio Waves 6-foot Parabolic, SP6-2/5 (37.7dBi)	37.7		Y
RFS	RFS 2-foot Parabolic, SPF2-52AN or SPFX2-52AN (27.9dBi)	27.9		Y
RFS	RFS 3-foot Parabolic, SPF3-52AN or SPFX3-52AN(31.4dBi)	31.4		Y
RFS	RFS 4-foot Parabolic, SPF4-52AN or SPFX4-52AN(33.9dBi)	33.9		Y
RFS	RFS 6-foot Parabolic, SPF6-52AN or SPFX6-52AN (37.4dBi)	37.4		Y
RFS	RFS 2-foot HP Parabolic, SDF2-52AN or SDFX2-52AN (31.4dBi)	31.4		Y
RFS	RFS 4-foot HP Parabolic, SDF4-52AN or SDFX4-52AN (33.9dBi)	33.9		Y
RFS	RFS 6-foot HP Parabolic, SDF6-52AN or SDFX6-52AN (37.4dBi)	37.4		Y
StellaDoradus	StellaDoradus 45 inch Parabolic Antenna, 58PSD113	33.8		Y

Table 20 - Allowed Antennas for Deployment in USA/Canada

13.8 Installation

This section covers the generic installation instructions for the bridge point-to-point wireless Ethernet bridges. The actual installation procedure will depend on antenna choice, cable choice, required antenna separation etc.

13.8.1 Antenna Choice

There are a wide variety of antennas that can be used with the Connectorized version of the PTP 400 Series bridges. The main selection criteria will be the required antenna gain. The secondary criteria should be the ease of mounting and alignment.



13.8.2 Cables and Connectors

Cables should be selected using the above criteria. However it should be noted that a cable of a type similar to LMR400 is a lot more difficult to handle and route than a cable of a type similar to LMR100.

Motorola recommends the use of weatherproof connectors -- preferably ones that come supplied with an adhesive lined heat shrink sleeve that is fitted over the cable/connector interface.

The connectors required at the Connectorized version of the PTP 400 Series Bridge end of the antenna cables are N-Type Male.

The connectors required at the antenna end of the antenna cables is dependant on the antenna type chosen.

13.8.3 Tools

The tools required for mounting an Connectorized version of the PTP 400 Series Bridge are the same as those required for an Integrated PTP 400 Series Bridge unit detailed in section 7.3 "Tools Required". The tools required for mounting the antennas are specific to the antenna chosen. The installer should refer to the antenna manufacturer's instructions.

13.8.4 Miscellaneous supplies

The following miscellaneous supplies will be required:

- Cable ties, cable cleats – for securing cables
- Self amalgamating tape – to weatherproof the RF connectors
- PVC tape – for additional protection of the RF connectors

13.8.5 Mounting

13.8.5.1 Connectorized version of the PTP 400 Series bridge

A Connectorized version of the PTP 400 Series Bridge ODU is shipped with the same bracket as is supplied with an Integrated ODU. Details on the use of this bracket can be found in section 3.3.7 "Mounting Brackets". The ODU should be mounted in a position that gives it maximum protection from the elements but still allows easy access for making off the various connections and applying the recommended weatherproofing.



When using dual polar antennas the ODU should be mounted in such a position as to minimize the cable length keeping losses to a minimum (taking into account the minimum cable lengths required by the FCC regulations, see section 13.7 "Antennas for 5.8GHz FCC Regions").

When using separate antennas the ODU should be mounted in such a position as to minimize both cable runs between the ODU and the antennas. It is not necessary to mount the ODU at the mid point between the antennas.

13.8.6 Antennas

The Antennas should be mounted according to the manufacturer's instructions. Actual antenna position will depend on the available mounting positions and link requirements. It may be necessary to mount the antennas 20m (66 feet) apart or at a certain distance from the ground to get the desired results.

13.8.7 Alignment Process

When aligning antennas deployed with a Connectorized version of the PTP 400 Series Bridge, it may not be possible to hear the alignment tone emanating from the ODU. In this case it may be necessary for a second installer to assist in the operation. Alternately it may be possible to extend the tube on the supplied stethoscope to give a longer reach.

Tip: Fine antenna alignment can sometimes be achieved by tightening and loosening the bolts on either side of the antenna mounting bracket, rather than trying to turn the whole bracket on the mounting pole.

13.8.8 Dual Polar Antennas

The process for aligning a dual polar antenna is the same as aligning an Integrated unit with an integrated antenna. This procedure is detailed in section 7.7.10 "Aligning the PTP 400 Series ODUs".

13.8.9 Separate Antennas

When using separate antennas to achieve special diversity it is recommended that one be mounted with Horizontal polarization and the other with Vertical polarization.

The following steps should be followed:

Step 1: Mount the Antennas

Step 2: Mount the ODU



- Step 3: Route and make off the ends of the Antenna cables
- Step 4: Connect the antenna cables at the antennas
- Step 5: Connect one of the antenna cables at the ODU
- Step 6: Connect the ODU to PIDU Plus cable and configure the unit as described in section 7.7 “Connecting Up”.
- Step 7: Align the connected antenna using the tones as described in section 7.7.10 “Aligning the PTP 400 Series ODUs”.
- Step 8: Connect the other antenna to the ODU.
- Step 9: Disconnect the cable to the already aligned antenna.
- Step 10: Align the second antenna using the tones as described in section 7.7.10 “Aligning the PTP 400 Series ODUs”.
- Step 11: Re-connect the second antenna to the ODU (Note: you will notice the tone pitch increase as you re-connect the second antenna due to the additional received signal).
- Step 12: Use the relevant status web pages to check that you are getting the results you expect from your link planning.
- Step 13: Complete the installation as detailed below.

13.8.10 Completing the Installation

The installation should be completed by checking all mounting nuts bolts and screws, securing all cables and weatherproofing the installation.



WARNING: Final tightening of the antenna mountings may cause the antenna alignment to be altered due to distortion in the mounting bracket caused by tightening. It is recommended that the installation tone be left turned on (armed) during this process so that any movement can be noticed and counter acted by tightening the other side of the bracket.

13.8.11 Antenna Cable Fixing

Cables should be secured in place using cable ties, cleats or PVC tape. Care should be taken to ensure that no undue strain is placed on the connectors on both the Connectorized version of the PTP 400 Series Bridge unit and the Antennas and also to ensure that the cables do not flap in the wind. Flapping cables are prone to damage and induce unwanted vibrations in the mast to which the units are attached.

13.8.12 Antenna Connection Weatherproofing

Where a cable connects to an antenna or unit from above, a drip loop should be left to ensure that water is not constantly channeled towards the connector.

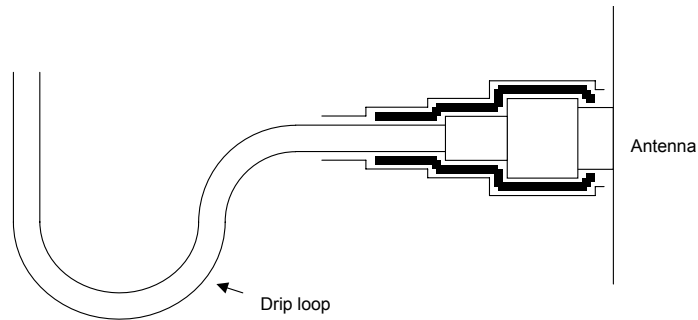

Figure 89 - Forming a Drip Loop

All joints should be weatherproofed using self-amalgamating tape. It is recommended that a layer of PVC tape be placed over the self-amalgamating tape to protect the joint while the self-amalgamating tape cures and give additional protection. Figure 90 shows this diagrammatically for the Connectorized version of the PTP 400 Series bridge unit end of the antenna cables. If the antenna manufacturer has not supplied guidance on this matter the same technique should be employed at the antenna end of the cables.

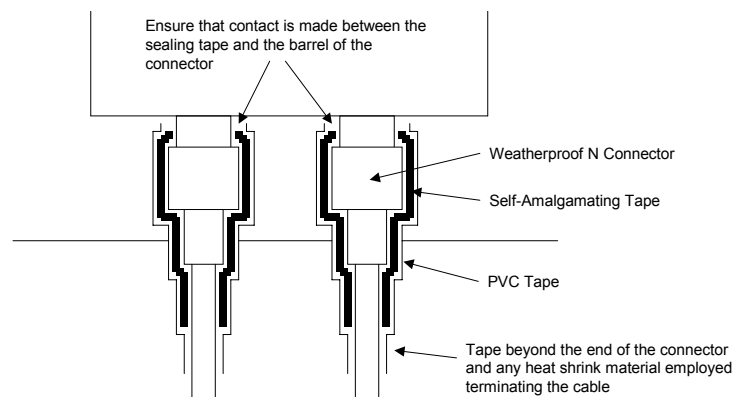

Figure 90 - Weatherproofing the Antenna Connections

13.9 Additional Lightning Protection

The following guidelines should be applied in addition to those described in Section 11 "Lightning Protection".

13.9.1 ODU Mounted Outdoors

Where the ODU is mounted outdoors and is mounted some distance from the antenna it is advisable to add additional grounding by utilizing Andrew Assemblies (such as Andrew Type 223158 www.andrew.com) as shown in Figure 91.

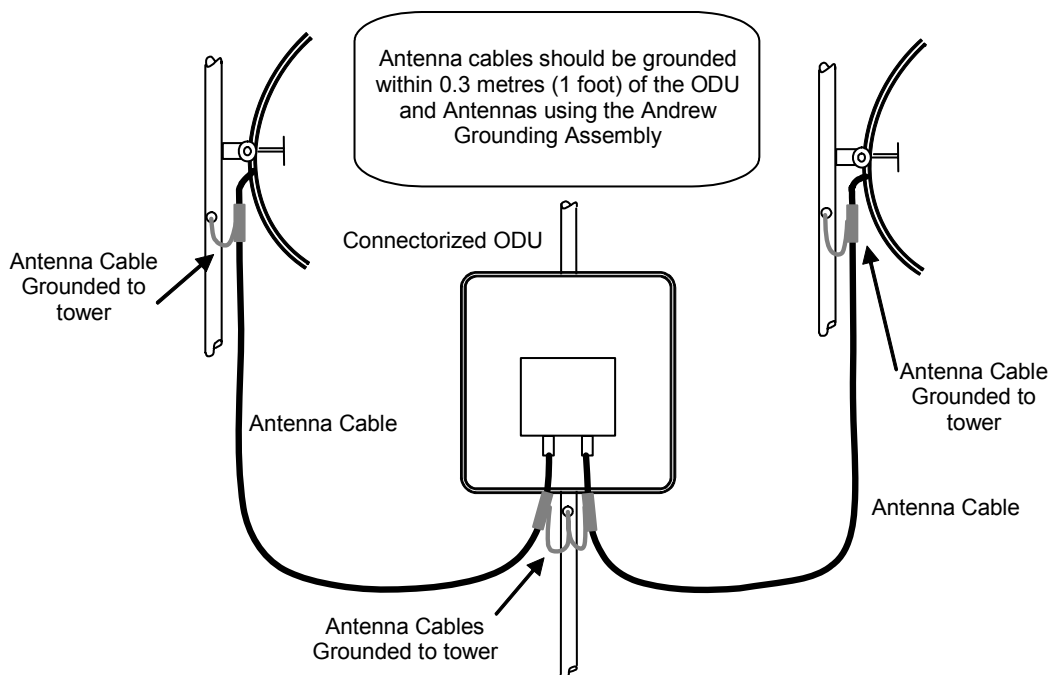

Figure 91 - Additional Grounding When Using Connectorized Units

13.9.2 ODU Mounted Indoors

Where the ODU is mounted indoors, lightning arrestors should be deployed where the antenna cables enter the building as shown in Figure 92.

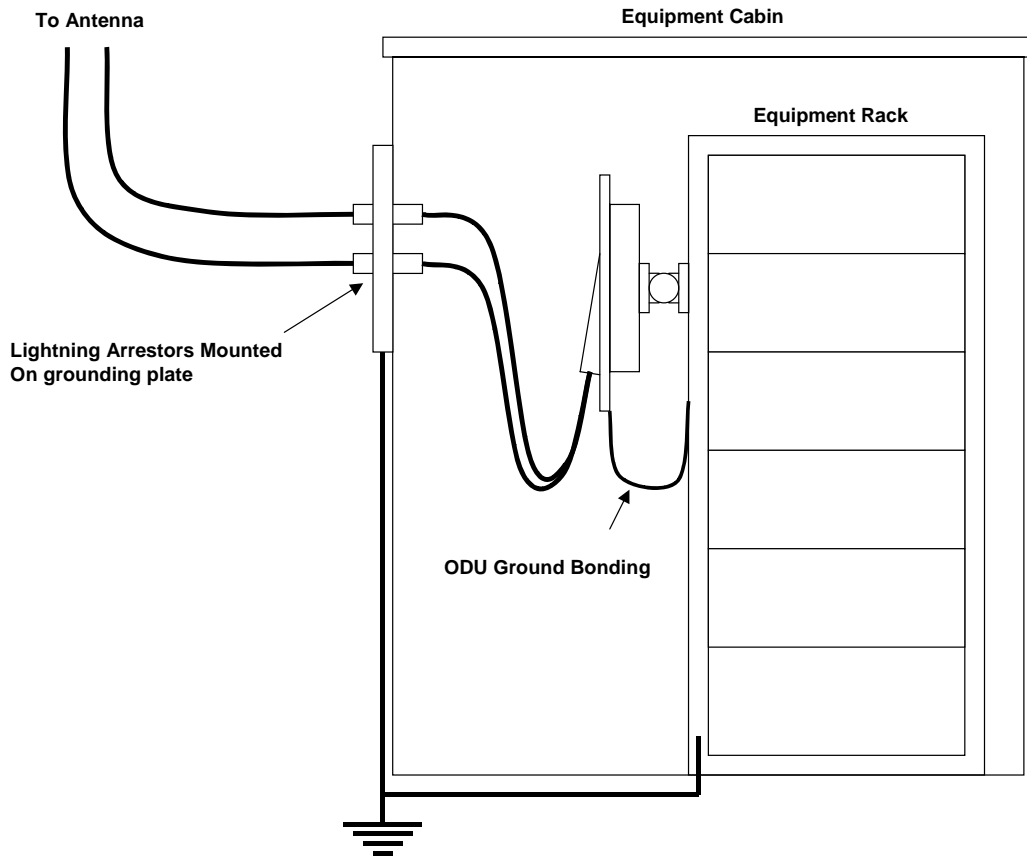

Figure 92 - Lightning Arrester Mounting

The lightning arrestors should be ground bonded to the building ground at the point of entry. Motorola recommends Polyphaser LSXL-ME or LSXL lightning arrestors. These should be assembled as show in Figure 93.

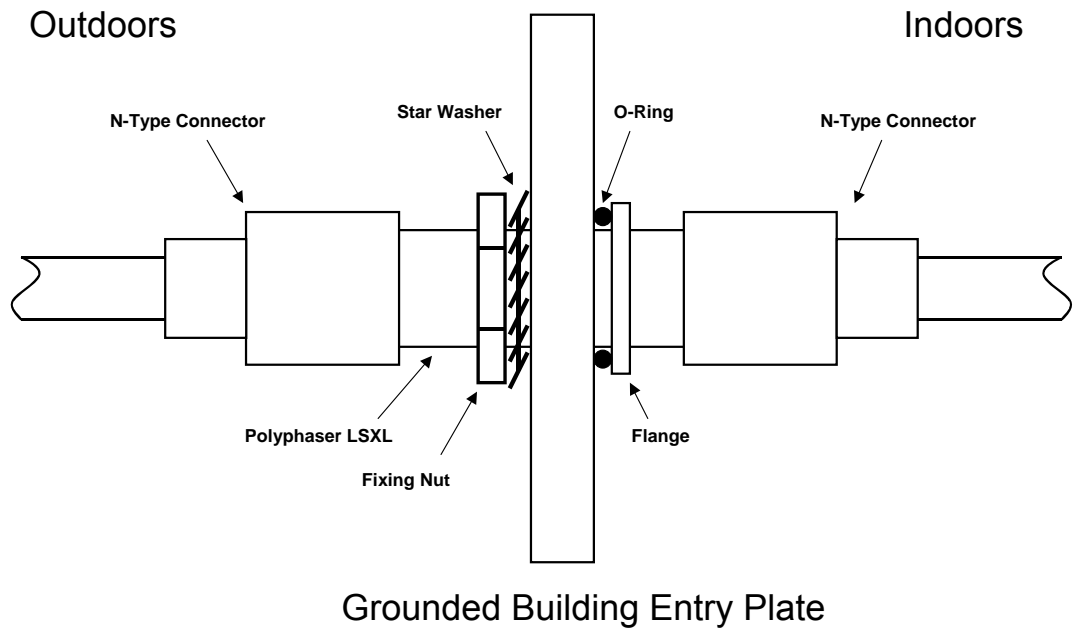

Figure 93 - Polyphaser Assembly



14 Wireless Link Encryption

The PTP 400 Series Bridge system supports link encryption using the NIST approved Advanced Encryption Standard, [FIPS-197](#). This standard specifies AES (Rijndael) as a FIPS-approved symmetric encryption algorithm that may be used by U.S. Government organizations (and others) to protect sensitive information.

Link Encryption is not available in the standard PTP 400 Series Bridge. A license key to enable link encryption can be purchased from your Motorola Point-to-Point Solutions Provider or Distributor. AES can be activated on receipt of the activation on the [Motorola License Key Generator page](#).

14.1 Configuring Link Encryption

After purchasing AES encryption for the PTP 400 Series Bridge, two new license keys will be issued, one for each end of the wireless link. The following configuration process gives a step by step guide to enabling AES link encryption on a PTP 400 Series Bridge wireless link.

14.1.1 License Keys

The first step when configuring link encryption is to enter the new license keys in both PTP 400 Series Bridge wireless units.

Figure 94 shows the license key data entry screen. This screen can only be accessed by the system administrator. If you do not have access to the PTP 400 Series Bridge system administration pages, please contact your designated system administrator.

It must be noted that configuring link encryption will necessitate a PTP 400 Series Bridge service outage. Therefore it is recommended that the configuration process is scheduled during an appropriate period of low link utilization.

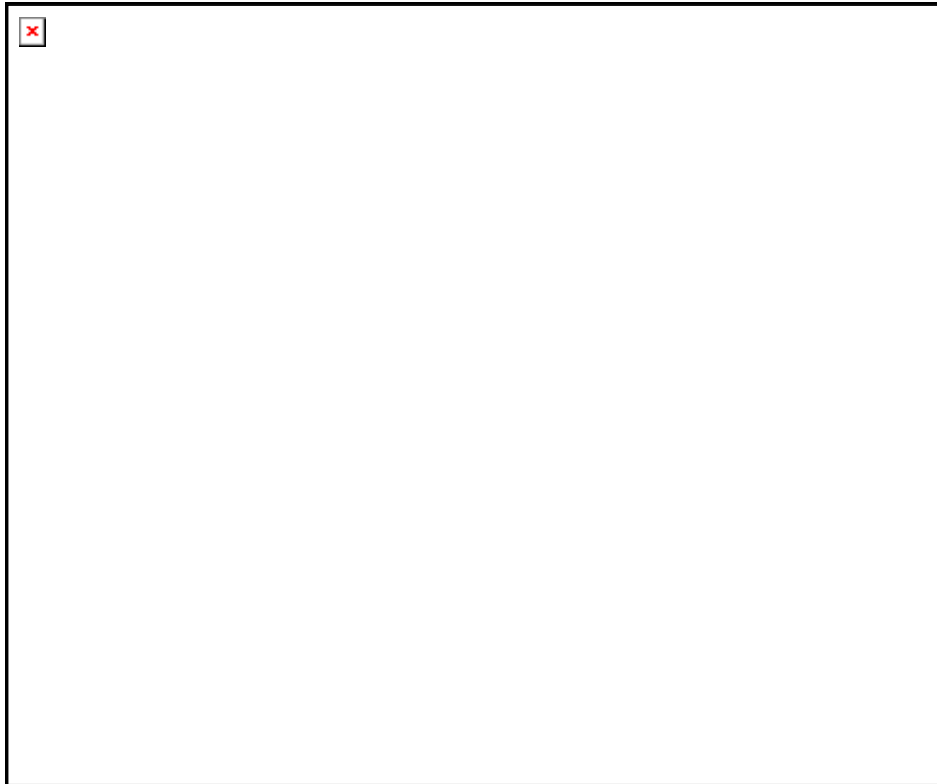

Figure 94 - Software License Key Data Entry

Motorola recommends the following process for entering new license keys and minimizing service outage.

1. Open two browsers, one for each end of the link
2. Navigate to the 'License Key' data entry page for each end of the link
3. Enter the license keys and click the 'Validate license key' button at each end of the link. This will allow the software to validate the license key prior to the system reset. (DO NOT CLICK ARE YOU SURE POPUP DIALOG)
4. When both license keys have been successfully validated confirm the reboot for both ends of the link. The software is designed to allow five seconds so that a user can command both ends of the link to reset before the wireless link drops.
5. The link will automatically re-establish.

14.1.2 Encryption Mode and Key

Entering the license keys only does not initialize AES link encryption. Link encryption can only be enabled via the Configuration or Installation Wizard pages. Motorola recommends that the Configuration page Figure 95 be used to configure AES link encryption.



Figure 95 - Configuration Data Entry Page

Motorola recommends the following process for entering AES link encryption configuration:-

1. Open two browsers one for each end of the link
2. Navigate to the 'Configuration' data entry page for each end of the link
3. At both ends of the link select 'AES (Rijndael)' Encryption Algorithm.
4. At both ends of the link enter a 128-bit encryption key. Note the key consists of 32 case insensitive hexadecimal characters. The same Key must be entered at both ends of the link. Failure to enter the same key will cause the link to fail.
5. Submit configuration on both ends of the link, but do not reboot.



6. Reboot both ends of the link Figure 96. The software is designed to allow five seconds so that a user can command both ends of the link to reboot before the wireless link drops.

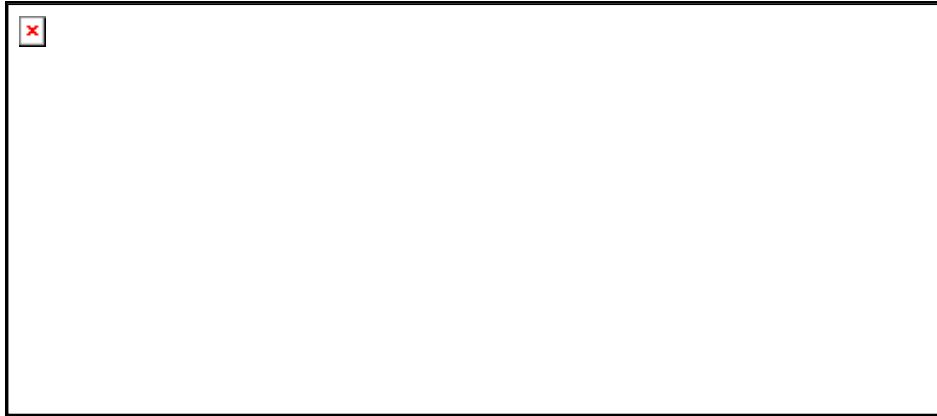

Figure 96 - Configuration Reboot Screen

14.2 Wireless Link Encryption FAQ

14.2.1 Encryption data entry fields are not available

Check that the correct license key has been inserted into the unit. The current license key is displayed on the 'License Key' data entry page.

14.2.2 Link fails to bridge packets after enabling link encryption

If the wireless link status on the status web page indicates that the link is UP, and you can browse to the local end of the link but not to the remote end, then check that the same encryption algorithm and key have been entered at both ends of the link. Failure to enter the same algorithm and key will result in received packets not being decrypted correctly.



15 Legal and Regulatory Notices

15.1 Important Note on Modifications

Intentional or unintentional changes or modifications to the equipment must not be made unless under the express consent of the party responsible for compliance. Any such modifications could void the user's authority to operate the equipment and will void the manufacturer's warranty.

15.2 National and Regional Regulatory Notices – 4.9 GHz Variant

The system has been approved under FCC Part 90 and Industry Canada RSS-211 for Public Safety Agency usage. The installer/operator is responsible for obtaining the appropriate site licenses before installing/using the system.

FCC IDs and Industry Canada Certification Numbers are listed in Table 21.

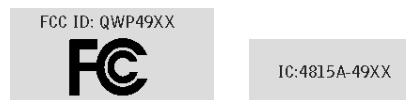

Table 21 - US FCC IDs and Industry Canada certification numbers

15.3 National and Regional Regulatory Notices – 5.8 GHz Variant

15.3.1 U.S. Federal Communication Commission (FCC) and Industry Canada (IC) Notification

This system has achieved Type Approval in various countries around the world. This means that the system has been tested against various local technical regulations and found to comply. The frequency band in which the system operates is 'unlicensed' and the system is allowed to be used provided it does not cause interference. Further, it is not guaranteed protection against interference from other products and installations.

This device complies with part 15 of the US FCC Rules and Regulations and with RSS-210 of Industry Canada. Operation is subject to the following two conditions: (1) This device may not cause harmful interference, and (2) This device must accept any interference received, including interference that may cause undesired operation. In Canada, users should be cautioned to take note that high power radars are allocated as primary users (meaning they have priority) of 5250 – 5350 MHz and 5650 – 5850 MHz and these radars could cause interference and/or damage to license-exempt local area networks (LELAN).



This equipment has been tested and found to comply with the limits for a Class B digital device, pursuant to Part 15 of the US FCC Rules and with RSS-210 of Industry Canada. These limits are designed to provide reasonable protection against harmful interference in a residential installation. This equipment generates, uses, and can radiate radio-frequency energy and, if not installed and used in accordance with these instructions, may cause harmful interference to radio communications. If this equipment does cause harmful interference to radio or television reception, which can be determined by turning the equipment on and off, the user is encouraged to correct the interference by one or more of the following measures:

- Increase the separation between the affected equipment and the unit;
- Connect the affected equipment to a power outlet on a different circuit from that which the receiver is connected to;
- Consult the dealer and/or experienced radio/TV technician for help.
- FCC IDs and Industry Canada Certification Numbers are listed in Table 22

This device complies with Part 15 of the FCC Rules. Operation is subject to the following two conditions: 1 This device may not cause harmful interference, and 2 This device must accept any interference received, including interference that may cause undesired operation.	FCC ID: QWP58XX-S 	IC:4815A-58XXS
--	--	----------------

Table 22 - US FCC IDs and Industry Canada certification numbers

Where necessary, the end user is responsible for obtaining any National licenses required to operate this product and these must be obtained before using the product in any particular country. Contact the appropriate national administrations for details on the conditions of use for the bands in question and any exceptions that might apply. Also see www.ero.dk for further information.



15.3.2 European Union Notification

The 5.8 GHz product is a two-way radio transceiver suitable for use in Broadband Wireless Access System (WAS), Radio Local Area Network (RLAN), or Fixed Wireless Access (FWA) systems. It is a Class 2 device and uses operating frequencies that are not harmonized throughout the EU member states. The operator is responsible for obtaining any national licenses required to operate this product and these must be obtained before using the product in any particular country.

This equipment complies with the essential requirements for the EU R&TTE Directive 1999/5/EC.

The use of 5.8GHz for Point to Point radio links is not harmonized across the EU and currently the product may only be deployed in the UK and Eire (IRL). However, the regulatory situation in Europe is changing and the radio spectrum may become available in other countries in the near future.

This equipment is marked



to show compliance with the European R&TTE directive 1999/5/EC.

The relevant Declaration of Conformity can be found at www.motorola.com

European Union (EU) Waste of Electrical and Electronic Equipment (WEEE) directive

The European Union's WEEE directive requires that products sold into EU countries must have the crossed out trash bin label on the product (or the package in some cases). As defined by the WEEE directive, this cross-out trash bin label means that customers and end-users in EU countries should not dispose of electronic and electrical equipment or accessories in household waste. Customers or end-users in EU countries should contact their local equipment supplier representative or service center for information about the waste collection system in their country.



15.3.3 UK Notification

The 5.8 GHz product has been notified for operation in the UK, and when operated in accordance with instructions for use it is compliant with UK Interface Requirement IR2007. For UK use, installations must conform to the requirements of IR2007 in terms of EIRP spectral density against elevation profile above the local horizon in order to protect Fixed Satellite Services. The frequency range 5795-5815 MHz is assigned to Road Transport & Traffic Telematics (RTTT) in the U.K. and shall not be used by FWA systems in order to protect RTTT devices. UK Interface Requirement IR2007 specifies that radiolocation services shall be protected by a Dynamic Frequency Selection (DFS) mechanism to prevent co-channel operation in the presence of radar signals.

Important Note

This equipment operates as a secondary application, so it has no rights against harmful interference, even if generated by similar equipment, and cannot cause harmful interference on systems operating as primary applications.

15.4 Exposure

See **Preventing Overexposure to RF** on Page 20.

15.5 Legal Notices

15.5.1 Software License Terms and Conditions

ONLY OPEN THE PACKAGE, OR USE THE SOFTWARE AND RELATED PRODUCT IF YOU ACCEPT THE TERMS OF THIS LICENSE. BY BREAKING THE SEAL ON THIS DISK KIT / CDROM, OR IF YOU USE THE SOFTWARE OR RELATED PRODUCT, YOU ACCEPT THE TERMS OF THIS LICENSE AGREEMENT. IF YOU DO NOT AGREE TO THESE TERMS, DO NOT USE THE SOFTWARE OR RELATED PRODUCT; INSTEAD, RETURN THE SOFTWARE TO PLACE OF PURCHASE FOR A FULL REFUND. THE FOLLOWING AGREEMENT IS A LEGAL AGREEMENT BETWEEN YOU (EITHER AN INDIVIDUAL OR ENTITY), AND MOTOROLA, INC. (FOR ITSELF AND ITS LICENSORS). THE RIGHT TO USE THIS PRODUCT IS LICENSED ONLY ON THE CONDITION THAT YOU AGREE TO THE FOLLOWING TERMS.

Now, therefore, in consideration of the promises and mutual obligations contained herein, and for other good and valuable consideration, the receipt and sufficiency of which are hereby mutually acknowledged, you and Motorola agree as follows:



Grant of License. Subject to the following terms and conditions, Motorola, Inc., grants to you a personal, revocable, non-assignable, non-transferable, non-exclusive and limited license to use on a single piece of equipment only one copy of the software contained on this disk (which may have been pre-loaded on the equipment)(Software). You may make two copies of the Software, but only for backup, archival, or disaster recovery purposes. On any copy you make of the Software, you must reproduce and include the copyright and other proprietary rights notice contained on the copy we have furnished you of the Software.

Ownership. Motorola (or its supplier) retains all title, ownership and intellectual property rights to the Software and any copies, including translations, compilations, derivative works (including images) partial copies and portions of updated works. The Software is Motorola's (or its supplier's) confidential proprietary information. This Software License Agreement does not convey to you any interest in or to the Software, but only a limited right of use. You agree not to disclose it or make it available to anyone without Motorola's written authorization. You will exercise no less than reasonable care to protect the Software from unauthorized disclosure. You agree not to disassemble, decompile or reverse engineer, or create derivative works of the Software, except and only to the extent that such activity is expressly permitted by applicable law.

Termination. This License is effective until terminated. This License will terminate immediately without notice from Motorola or judicial resolution if you fail to comply with any provision of this License. Upon such termination you must destroy the Software, all accompanying written materials and all copies thereof, and the sections entitled Limited Warranty, Limitation of Remedies and Damages, and General will survive any termination.

Limited Warranty. Motorola warrants for a period of ninety (90) days from Motorola's or its customer's shipment of the Software to you that (i) the disk(s) on which the Software is recorded will be free from defects in materials and workmanship under normal use and (ii) the Software, under normal use, will perform substantially in accordance with Motorola's published specifications for that release level of the Software. The written materials are provided "AS IS" and without warranty of any kind. Motorola's entire liability and your sole and exclusive remedy for any breach of the foregoing limited warranty will be, at Motorola's option, replacement of the disk(s), provision of downloadable patch or replacement code, or refund of the unused portion of your bargained for contractual benefit up to the amount paid for this Software License.



THIS LIMITED WARRANTY IS THE ONLY WARRANTY PROVIDED BY MOTOROLA, AND MOTOROLA AND ITS LICENSORS EXPRESSLY DISCLAIM ALL OTHER WARRANTIES, EITHER EXPRESS OF IMPLIED, INCLUDING BUT NOT LIMITED TO IMPLIED WARRANTIES OF MERCHANTABILITY AND FITNESS FOR A PARTICULAR PURPOSE AND NONINFRINGEMENT. MOTOROLA DOES NOT WARRANT THAT THE OPERATION OF THE SOFTWARE WILL BE UNINTERRUPTED OR ERROR-FREE, OR THAT DEFECTS IN THE SOFTWARE WILL BE CORRECTED. NO ORAL OR WRITTEN REPRESENTATIONS MADE BY MOTOROLA OR AN AGENT THEREOF SHALL CREATE A WARRANTY OR IN ANY WAY INCREASE THE SCOPE OF THIS WARRANTY. MOTOROLA DOES NOT WARRANT ANY SOFTWARE THAT HAS BEEN OPERATED IN EXCESS OF SPECIFICATIONS, DAMAGED, MISUSED, NEGLECTED, OR IMPROPERLY INSTALLED. BECAUSE SOME JURISDICTIONS DO NOT ALLOW THE EXCLUSION OR LIMITATION OF IMPLIED WARRANTIES, THE ABOVE LIMITATIONS MAY NOT APPLY TO YOU.

Limitation of Remedies and Damages. Regardless of whether any remedy set forth herein fails of its essential purpose, IN NO EVENT SHALL MOTOROLA OR ANY OF THE LICENSORS, DIRECTORS, OFFICERS, EMPLOYEES OR AFFILIATES OF THE FOREGOING BE LIABLE TO YOU FOR ANY CONSEQUENTIAL, INCIDENTAL, INDIRECT, SPECIAL OR SIMILAR DAMAGES WHATSOEVER (including, without limitation, damages for loss of business profits, business interruption, loss of business information and the like), whether foreseeable or unforeseeable, arising out of the use or inability to use the Software or accompanying written materials, regardless of the basis of the claim and even if Motorola or a Motorola representative has been advised of the possibility of such damage. Motorola's liability to you for direct damages for any cause whatsoever, regardless of the basis of the form of the action, will be limited to the price paid for the Software that caused the damages. THIS LIMITATION WILL NOT APPLY IN CASE OF PERSONAL INJURY ONLY WHERE AND TO THE EXTENT THAT APPLICABLE LAW REQUIRES SUCH LIABILITY. BECAUSE SOME JURISDICTIONS DO NOT ALLOW THE EXCLUSION OR LIMITATION OF LIABILITY FOR CONSEQUENTIAL OR INCIDENTAL DAMAGES, THE ABOVE LIMITATION MAY NOT APPLY TO YOU.

Maintenance and Support. Motorola shall not be responsible for maintenance or support of the software. By accepting the license granted under this agreement, you agree that Motorola will be under no obligation to provide any support, maintenance or service in connection with the Software or any application developed by you. Any maintenance and support of the Related Product will be provided under the terms of the agreement for the Related Product.



Transfer. In the case of software designed to operate on Motorola equipment, you may not transfer the Software to another party except: (1) if you are an end-user, when you are transferring the Software together with the Motorola equipment on which it operates; or 2) if you are a Motorola licensed distributor, when you are transferring the Software either together with such Motorola equipment or are transferring the Software as a licensed duly paid for upgrade, update, patch, new release, enhancement or replacement of a prior version of the Software. If you are a Motorola licensed distributor, when you are transferring the Software as permitted herein, you agree to transfer the Software with a license agreement having terms and conditions no less restrictive than those contained herein. You may transfer all other Software, not otherwise having an agreed restriction on transfer, to another party. However, all such transfers of Software are strictly subject to the conditions precedent that the other party agrees to accept the terms and conditions of this License, and you destroy any copy of the Software you do not transfer to that party. You may not sublicense or otherwise transfer, rent or lease the Software without our written consent. You may not transfer the Software in violation of any laws, regulations, export controls or economic sanctions imposed by the US Government.

Right to Audit. Motorola shall have the right to audit annually, upon reasonable advance notice and during normal business hours, your records and accounts to determine compliance with the terms of this Agreement.

Export Controls. You specifically acknowledge that the software may be subject to United States and other country export control laws. You shall comply strictly with all requirements of all applicable export control laws and regulations with respect to all such software and materials.

US Government Users. If you are a US Government user, then the Software is provided with "RESTRICTED RIGHTS" as set forth in subparagraphs (c)(1) and (2) of the Commercial Computer Software-Restricted Rights clause at FAR 52 227-19 or subparagraph (c)(1)(ii) of the Rights in Technical Data and Computer Software clause at DFARS 252.227-7013, as applicable.



Disputes. You and Motorola hereby agree that any dispute, controversy or claim, except for any dispute, controversy or claim involving intellectual property, prior to initiation of any formal legal process, will be submitted for non-binding mediation, prior to initiation of any formal legal process. Cost of mediation will be shared equally. Nothing in this Section will prevent either party from resorting to judicial proceedings, if (i) good faith efforts to resolve the dispute under these procedures have been unsuccessful, (ii) the dispute, claim or controversy involves intellectual property, or (iii) interim relief from a court is necessary to prevent serious and irreparable injury to that party or to others.

General. Illinois law governs this license. The terms of this license are supplemental to any written agreement executed by both parties regarding this subject and the Software Motorola is to license you under it, and supersedes all previous oral or written communications between us regarding the subject except for such executed agreement. It may not be modified or waived except in writing and signed by an officer or other authorized representative of each party. If any provision is held invalid, all other provisions shall remain valid, unless such invalidity would frustrate the purpose of our agreement. The failure of either party to enforce any rights granted hereunder or to take action against the other party in the event of any breach hereunder shall not be deemed a waiver by that party as to subsequent enforcement of rights or subsequent action in the event of future breaches.

15.5.2 Hardware Warranty in U.S.

Motorola U.S. offers a warranty covering a period of one year from the date of purchase by the customer. If a product is found defective during the warranty period, Motorola will repair or replace the product with the same or a similar model, which may be a reconditioned unit, without charge for parts or labor.

15.5.3 Limit of Liability

IN NO EVENT SHALL MOTOROLA BE LIABLE TO YOU OR ANY OTHER PARTY FOR ANY DIRECT, INDIRECT, GENERAL, SPECIAL, INCIDENTAL, CONSEQUENTIAL, EXEMPLARY OR OTHER DAMAGE ARISING OUT OF THE USE OR INABILITY TO USE THE PRODUCT (INCLUDING, WITHOUT LIMITATION, DAMAGES FOR LOSS OF BUSINESS PROFITS, BUSINESS INTERRUPTION, LOSS OF BUSINESS INFORMATION OR ANY OTHER PECUNIARY LOSS, OR FROM ANY BREACH OF WARRANTY, EVEN IF MOTOROLA HAS BEEN ADVISED OF THE POSSIBILITY OF SUCH DAMAGES. (Some states do not allow the exclusion or limitation of incidental or consequential damages, so the above exclusion or limitation may not apply to you.) IN NO CASE SHALL MOTOROLA'S LIABILITY EXCEED THE AMOUNT YOU PAID FOR THE PRODUCT.

16 Glossary

AES	Advanced Encryption Standard	NLOS	non-line-of-sight
ARP	Address Resolution Protocol	ODU	Outdoor Unit
ARQ	Automatic Repeat reQuest	OFDM	Orthogonal Frequency Division Multiplexing
BPSK	Binary Phase Shift Keying		
DC	Direct Current	PC	IBM Compatible Personal Computer
DFS	Dynamic Frequency Selection	PIDU Plus	Power Indoor Unit
ETSI	European Telecommunications Standards Institute	PING	Packet Internet Groper
FAQ	Frequently Asked Question	POE	Power over Ethernet
GPS	Global Positioning System	PSU	Power Supply Unit
HTTP	Hypertext Transfer Protocol	PTP	Point-to-Point
ID	Identity	QAM	Quadrature Amplitude Modulation
IEEE	Institute of Electrical and Electronic Engineers	RAM	Random Access Memory
IP	Internet Protocol	STC	Space Time Coding
IQ	In phase / Quadrature	STP	Shielded Twisted Pair
ISM	Industrial Scientific and Medical	TCP	Transmission Control Protocol
ITU	International Telecommunications Union	TPC	Transmit Power Control
LAN	Local Area Network	URL	Universal Resource Location
MAC	Medium Access Control Layer	USA	United States of America
MDI	Medium Dependent Interface	UTP	Unshielded Twisted Pair
MDIX	Medium Dependent Interface Crossover	UV	Ultraviolet
		VLAN	Virtual Local Area Network



17 FAQs

Q: *Can I source and use my own PoE adaptor with the PTP 400 Series Bridge?*

No. The PTP 400 Series Bridge uses a non-standard PoE configuration. Failure to use the Motorola supplied Power Indoor Unit (PIDU Plus – PTP 400 Series) could result in equipment damage and will invalidate the safety certification and may cause a safety hazard.

Q: *Who is Motorola?*

Motorola, Inc. is a specialist wireless manufacturer with a high quality engineering team that is developing advanced radio solutions that allows high capacity building-to-building bridges to be established even in deep non-Line-of-Sight conditions.

Q: *Why has Motorola launched the PTP 400 Series Bridge?*

The PTP 400 Series Bridge is the first product in this band to feature Multiple-Input Multiple-Output (MIMO). The PTP 400 Series solutions allow wireless connections of up to 200km (124 miles) in near line-of-sight conditions and up to 10km (6 miles) in deep non-line-of-sight conditions.

Q: *What is Multiple-Input Multiple-Output (MIMO)?*

The PTP 400 Series Bridge radiates multiple beams from the antenna - which significantly protects against fading and radically increases the probability that the receiver will decode a usable signal. When the effects of MIMO are combined with those of OFDM techniques and a best-in-class link budget, there is a significant improvement to the probability of a robust connection over a non-line-of-sight path.

Q: *What do you mean by “non-Line-of-sight”?*

This term refers to a wireless connection between two points without optical line-of-sight. i.e. with obstructions in between the antennas but the transmitted signal is still able to reach the receiver and produce a good quality link.



Q: *What else is special about the PTP 400 Series Bridge?*

There are many special features built-in to the hardware of the PTP 400 Series Bridge. The product offers the highest system gain in its class through high sensitivity antennas for improved signal recovery. It also features a Software Defined Radio system that operates on ultra fast digital signal processors but is controlled by firmware giving the ability to download new firmware when enhancements become available. The PTP 400 Series Bridge has a built-in web server for advanced management capabilities including detailed radio signal diagnosis.

Q: *In which frequency band does the PTP 400 Series Bridge operate?*

The Motorola point-to-point PTP 400 Series Bridges operate in the 4.9 GHz USA National Public Safety Band, the unlicensed 5.4 GHz (ETSI Band B) and 5.8 GHz (ETSI Band C and FCC ISM band).

Q: *Why does the PTP 400 Series Bridge operate in the 5 GHz band?*

The 5 GHz band offers the dual benefits of high data throughput and good radio propagation characteristics. The wide band of spectrum available is subdivided into several channels such that multiple systems can operate in the vicinity without causing interference to one another.

Q: *Is the PTP 400 Series Bridge an 802.11a device?*

No. Although similar, the PTP 400 Series Bridge uses different encoding and radio transmission systems than 802.11a. In areas where 802.11a systems are operating, the PTP 400 Series Bridge will detect the 802.11a radio signals and choose a clean channel away from any interference.

Q: *How much power does the PTP 400 Series Bridge transmit?*

At all times the PTP 400 Series Bridge operates within country / region specific regulations for radio power emissions. In addition, the PTP 400 Series Bridge uses a technique known as Transmit Power Control (TPC) to ensure that it only transmits sufficient radio power such that the other antenna can receive a high quality signal.

Q: *How does the PTP 400 Series Bridge avoid interference from other devices nearby?*

At initialization, the PTP 400 Series Bridge monitors the available frequency channels to find a channel that is clean from interference. In operation, the PTP 400 Series Bridge continuously monitors the spectrum to ensure it is operating on the cleanest channel.



Q: *How does the PTP 400 Series Bridge integrate into my data network?*

The PTP 400 Series Bridge acts as a transparent bridge between two segments of your network. In this sense, it can be treated like a virtual wired connection between the two buildings. The PTP 400 Series Bridge forwards 802.3 Ethernet packets destined for the other part of the network and filters packets it does not need to forward. The system is transparent to higher-level management systems such as VLANs and Spanning Tree.

Q: *How does the PTP 400 Series Bridge provide security for data traffic?*

The PTP 400 Series Bridge has a range of security features. At installation time each link must be programmed with the serial ID of its partner. The two ends of the link will only communicate with one another, eliminating any chance of "man in the middle" attacks. Over-the-air security is achieved through a proprietary scrambling mechanism that cannot be disabled, spoofed or snooped by commercial tools. If further security is required the user is now able to optionally augment the existing high security by encoding the air interface using AES.

Q: *How is the Advanced Encryption Standard (AES) enabled?*

The AES facility is enabled by the user obtaining a license key from Motorola. Entering the key will turn on the AES option from which the user will be able to turn on AES. The default setting for AES is off.

Q: *How do I manage the PTP 400 Series Bridge?*

The PTP 400 Series Bridge has a built-in web server. At installation, the unit is configured with an IP address so that the web server can then be accessed from any browser equipped terminal. For security, access can be password protected, meaning only the network administrator can access the web based management tools. SNMP V2c is also available and the unit can be configured to send traps or email notifications via SMTP.

Q: *Can I use Apple Macintosh OS X to control and monitor my PTP 400 Series Bridge?*

Yes, but there are some restrictions. Mozilla 1.6 is recommended. There are some issues with Internet Explorer 5.2(IE) and Safari, which could mislead the user.



Q: *How will my investment be protected as new features are developed?*

Future enhancements can be downloaded to the unit, meaning advances in technology or changes in regulations can quickly be applied to the system without any further hardware investment.

Q: *Why can't I change the channel raster centre frequencies on a PTP 49400?*

The PTP 49400 provides full band coverage without moving the channel raster. Therefore this option is not provided.

Q: *Why does the PTP 49400 not have a Latency vs. Throughput option?*

Due to the narrow channel Low Latency Mode and Throughput mode have the same latency and throughput. Therefore this option is not provided.

Q: *Why is the PTP 49400 Maximum TX power 23 dBm rather than 25 dBm?*

The maximum TX power is restricted to 23 dBm due to Type Approval power restrictions.



18 Specifications

18.1 System Specifications

18.1.1 Wireless 4.9GHz Variant

Radio Technology	Specification	
RF Band	4.940-4990 MHz	
Channel Selection	By dynamic frequency control and manual intervention Automatic detection on start-up and continual adaptation to avoid interference.	
Dynamic Frequency Control	Initial capture 10-15 sec. Out of service on interference 100 ms. (+60 seconds when Radar Detection is operational)	
Channel size	10 MHz	
Tx power @ Antenna ports	Mode	Maximum Power Output (region dependant) ²⁹
	BPSK Mode	23 dBm
	QPSK Modes	22 dBm
	16QAM Modes	19 dBm
	64QAM Modes	19 dBm
Transmit Power Control	Loop bandwidth 1 Hz, Range 30dB typical	
Manual Power Control	Maximum power can be controlled lower than the power limits shown above in order to control interference to other users of the band.	
Receiver Noise Figure	Typically 6 dB	

Note: Power limits are subject to regulatory approval, currently pending.

²⁹ As specified by FCC Part 90.1215 and RSS211



The receive sensitivities and system gains for each mode are as follows:

Mode	RX Sensitivity	TX Power	System Gain
BPSK 1/2	-96.4 dBm	23 dBm	163.4 dB
QPSK 1/2	-90.9 dBm	22 dBm	156.9 dB
QPSK 2/3	-89.8 dBm	22 dBm	155.8 dB
16QAM 1/2	-86.1 dBm	19 dBm	149.1 dB
16QAM 3/4	-83.2 dBm	19 dBm	146.2 dB
64QAM 2/3	-78.8 dBm	19 dBm	141.8 dB
64QAM 3/4	-76.9 dBm	19 dBm	139.9 dB
64QAM 7/8	-73.7 dBm	19 dBm	136.7 dB

The un-shaded value above (BPSK) is a static receive sensitivity measurement. The shaded values above are static receive sensitivity measurements with an Adaptive Modulation (AMOD) threshold applied. The AMOD threshold applied is for a benign radio channel.



Antenna	
Antenna Type	Integrated flat plate antenna
Antenna Gain	22 dBi typical
Antenna Beamwidth	8 Degrees

Wireless PHY	
Max Path Loss	163.8dB
Duplex Scheme	TDD, Symmetric (1:1) and Asymmetric (2:1)
Range	124 miles (200km) optical Line-of-Sight 6 miles (10km) non-Line-of-Sight
Over-the-Air Encryption	Proprietary scrambling mechanism. Optional AES – via license update.
Weather Sensitivity	Sensitivity at higher modes may be reduced during high winds through trees due to Adaptive Modulation Threshold changes
Error Correction	FEC and ARQ



18.1.2 Wireless 5.4GHz Variant

Radio Technology	Specification	
RF Band	5.470-5.725GHz	
Channel Selection	By dynamic frequency control and manual intervention Automatic detection on start-up and continual adaptation to avoid interference.	
Dynamic Frequency Control	Initial capture 10-15 sec. Out of service on interference 100 ms. (+60 seconds when Radar Detection is operational)	
Channel size	11 MHz	
Tx power @ Antenna ports	Mode	Maximum Power Output (region dependant) ³⁰
	BPSK Mode	25 dBm
	QPSK Modes	23 dBm
	16QAM Modes	21 dBm
	64QAM Modes	19 dBm
Transmit Power Control	Loop bandwidth 1 Hz, Range 30dB typical	
Manual Power Control	Maximum power can be controlled lower than the power limits shown above in order to control interference to other users of the band.	
Receiver Noise Figure	Typically 6 dB	

³⁰ As specified by FCC Part 15.407 and ETSI EN 301893



The receive sensitivities and system gains for each mode are as follows:

Mode	RX Sensitivity	TX Power	System Gain
BPSK 1/2	-96.6 dBm	25 dBm	168.6 dB
QPSK 1/2	-92.8 dBm	23 dBm	162.8 dB
QPSK 2/3	-90.3 dBm	23 dBm	160.3 dB
16QAM 1/2	-85.5 dBm	21 dBm	153.5 dB
16QAM 3/4	-82.9 dBm	21 dBm	150.9 dB
64QAM 2/3	-78.3 dBm	19 dBm	144.3 dB
64QAM 3/4	-76.5 dBm	19 dBm	142.5 dB
64QAM 7/8	-73.8 dBm	19 dBm	139.8 dB

The un-shaded value above (BPSK) is a static receive sensitivity measurement. The shaded values above are static receive sensitivity measurements with an Adaptive Modulation (AMOD) threshold applied. The AMOD threshold applied is for a benign radio channel.



Antenna	
Antenna Type	Integrated flat plate antenna
Antenna Gain	23.5 dBi typical
Antenna Beamwidth	8 Degrees

Wireless PHY	
Max Path Loss	168 dB
Duplex Scheme	TDD, Symmetric (1:1) and Asymmetric (2:1)
Range	124 miles (200km) optical Line-of-Sight 6 miles (10km) non-Line-of-Sight
Over-the-Air Encryption	Proprietary scrambling mechanism. Optional AES – via license update.
Weather Sensitivity	Sensitivity at higher modes may be reduced during high winds through trees due to Adaptive Modulation Threshold changes
Error Correction	FEC and ARQ



18.1.3 Wireless 5.8GHz Variant

Radio Technology	Specification	
RF Band	5.725-5.850GHz	
Channel Selection	By dynamic frequency control and manual intervention Automatic detection on start-up and continual adaptation to avoid interference.	
Dynamic Frequency Control	Initial capture 10-15 sec. Out of service on interference 100 ms. (+60 seconds when Radar Detection is operational)	
Channel size	11 MHz	
Tx power @ Antenna ports	Mode	Maximum Power Output (region dependant) ³¹
	BPSK Mode	25 dBm
	QPSK Modes	23 dBm
	16QAM Modes	21 dBm
	64QAM Modes	19 dBm
Transmit Power Control	Loop bandwidth 1 Hz, Range 30dB typical	
Manual Power Control	Maximum power can be controlled lower than the power limits shown above in order to control interference to other users of the band.	
Receiver Noise Figure	Typically 6 dB	

³¹ As specified by FCC Part 15.247



The receive sensitivities and system gains for each mode are as follows:

Mode	RX Sensitivity	TX Power	System Gain
BPSK 1/2	-96.5 dBm	25 dBm	168.5 dB
QPSK 1/2	-93.0 dBm	23 dBm	163.0 dB
QPSK 2/3	-90.7 dBm	23 dBm	160.7 dB
16QAM 1/2	-87.2 dBm	21 dBm	155.2 dB
16QAM 3/4	-82.4 dBm	21 dBm	150.4 dB
64QAM 2/3	-78.4 dBm	19 dBm	144.4 dB
64QAM 3/4	-76.3 dBm	19 dBm	142.3 dB
64QAM 7/8	-72.1 dBm	19 dBm	138.1 dB

The un-shaded value above (BPSK) is a static receive sensitivity measurement. The shaded values above are static receive sensitivity measurements with an Adaptive Modulation (AMOD) threshold applied. The AMOD threshold applied is for a benign radio channel.



Antenna	
Antenna Type	Integrated flat plate antenna
Antenna Gain	23.5 dBi typical
Antenna Beamwidth	8 Degrees

Wireless PHY	
Max Path Loss	168dB
Duplex Scheme	TDD, Symmetric (1:1) and Asymmetric (2:1)
Range	124 miles (200km) optical Line-of-Sight 6 miles (10km) non-Line-of-Sight
Over-the-Air Encryption	Proprietary scrambling mechanism. Optional AES – via license update.
Weather Sensitivity	Sensitivity at higher modes may be reduced during high winds through trees due to Adaptive Modulation Threshold changes
Error Correction	FEC and ARQ



18.1.4 Management

Management	
Status Indication	<p>Power status</p> <p>Ethernet Link Status</p> <p>Data activity</p>
Installation	<p>Web server and browser for setup</p> <p>Audio tone feedback during installation</p> <p>Web server for confirmation</p>
Radio Performance and Management	<p>Via web server and browser, SNMP</p> <p>The PTP 400 Series Bridge SNMP stack currently supports four distinct MIBs:</p> <ol style="list-style-type: none"> 1. MIB-II, RFC-1213, The PTP 400 Series Bridge supports the 'System Group' and 'Interfaces Group'. 2. Bridge MIB, RFC-1493 3. PTP 400 Series Bridge proprietary MIB 4. WiMAX MIB
Alarms	Via configurable email alerts, SNMP



18.1.5 Ethernet

Ethernet Bridging			
Protocol	IEEE802.1; IEEE802.1p; IEEE802.3 compatible		
Interface	10/100BaseT (RJ-45), Supports MDI/MDIX Auto Crossover		
Single Direction Data Rate	Mode	5.4 and 5.8 GHz	4.9 GHz
0 – 5 km Mode Data Rate Optimized Symmetric TDD (1:1)	BPSK 1/2 QPSK 1/2 QPSK 2/3 16QAM 1/2 16QAM 3/4 64QAM 2/3 64QAM 3/4 64QAM 7/8	1.80 Mbps 4.05 Mbps 5.40 Mbps 8.10Mbps 12.15 Mbps 16.20 Mbps 18.22 Mbps 21.26 Mbps	1.35 Mbps 3.15 Mbps 4.20 Mbps 6.30 Mbps 9.44 Mbps 13.19 Mbps 14.84 Mbps 17.31 Mbps
0 – 5 km Mode Latency Optimized Symmetric TDD (1:1)	BPSK 1/2 QPSK 1/2 QPSK 2/3 16QAM 1/2 16QAM 3/4 64QAM 2/3 64QAM 3/4 64QAM 7/8	1.68 Mbps 3.78 Mbps 5.04 Mbps 7.55 Mbps 11.23 Mbps 15.11 Mbps 17.00 Mbps 19.83 Mbps	Not Applicable
0 – 5 km Mode Data Rate Optimized Asymmetric TDD (2:1)	BPSK 1/2 QPSK 1/2 QPSK 2/3 16QAM 1/2 16QAM 3/4 64QAM 2/3 64QAM 3/4 64QAM 7/8	2.34 Mbps 5.27 Mbps 7.03 Mbps 10.54 Mbps 15.82 Mbps 21.09 Mbps 23.72 Mbps 27.68 Mbps	1.76 Mbps 4.10 Mbps 5.46 Mbps 8.2 Mbps 12.29 Mbps 17.17 Mbps 19.32 Mbps 22.54 Mbps
Other Range Modes Data Rate Optimized Symmetric TDD (1:1)	0 – 40 km [0-25 miles] Rate reduces by 7.2% 0 – 100 km [0-62 miles] Rate reduces by 17.3% 0 – 200 km [0-124 miles] Rate reduces by 30%		
Other Range Modes Latency Optimized Symmetric TDD (1:1)	0 – 40 km [0-25 miles] Rate reduces by 12.5% 0 – 100 km [0-62 miles] Rate reduces by 28% 0 – 200 km [0-124 miles] Rate reduces by 44.4%		
Other Range Modes Data Rate Optimized Asymmetric TDD (2:1)	0 – 40 km [0-25 miles] Rate reduces by 9.1% 0 – 100 km [0-62 miles] Rate reduces by 21.4% 0 – 200 km [0-124 miles] Rate reduces by 35.8%		



Notes:

1. Data rates for the Lite version of the PTP 400 Series Bridge are 50% of the figures shown in the above table.
2. Data rates above are with ARQ disabled and AES disabled.
3. Practical Ethernet rates will depend on network configuration, higher layer protocols and platforms used.

18.1.6 Physical

Physical Integrated	
Dimensions	Width 14.5" (370mm), Height 14.5" (370mm), Depth 3.75" (95mm)
Weight	12.1 lbs (5.5 Kg) including bracket

Physical Connectorized	
Dimensions	Width 12" (305mm), Height 12" (305mm), Depth 4.1" (105mm)
Weight	9.1 lbs (4.3 Kg) including bracket

18.1.7 Powering

Power Supply	Separate power supply unit (included)
Dimensions	Width 9.75" (250mm), Height 1.5" (40mm), Depth 3" (80mm)
Weight	1.9 lbs (864 g)
Power source	90 – 264 VAC, 50 – 60 Hz / 36 – 60 VDC
Power consumption	55 W max



18.2 Safety Compliance

Region	Specification
USA	UL 60950
Canada	CSA C22.2 No.60950
International	CB certified & certificate to IEC 60950

18.3 EMC Emissions Compliance

18.3.1 4.9 GHz Variant

Region	Specification
USA	FCC Part 2, FCC Part 15.207 and 15.209
Canada	RSS-111

18.3.2 5.4 GHz Variant

Region	Specification
Europe	EN55022 CISPR 22

18.3.3 5.8 GHz Variant

Region	Specification
USA	FCC Part 15 Class B
Canada	CSA Std C108.8, 1993 Class B
Europe	EN55022 CISPR 22

18.4 EMC Immunity Compliance – Europe Only

Top-level Specification ETSI 301-489.

Specification	Comment
EN 55082-1 Generic EMC and EMI requirements for Europe	
EN 61000-4-2: 1995 Electro Static Discharge (ESD), Class 2, 8 kV air, 4 kV contact discharge	
EN 61000-4-3: 1995 ENV50140: 1993 (radiated immunity) 3 V/m	
EN 61000-4-4: 1995 (Bursts/Transients), Class 4, 4 kV level (power lines AC & DC)	Signal lines @ 0.5 kV open circuit voltage.
EN 6100045:1995, (Surge Immunity)	Requires screened connection to users network
EN 61000-4-6: 1996 (Injected RF), power line, Class 3 @ 10 V/m	Signal lines, Class 3 @ 3 V RMS un-modulated.



18.5 Radio Certifications

18.5.1 4.9GHz Variant

Region	Specification (Type Approvals)
USA	FCC Part 90
Canada	RSS-211

18.5.2 5.4GHz Variant

Region	Specification (Type Approvals)
USA	N/A
EU	EN301 893 V1.2.3/V1.3.1

18.5.3 5.8GHz Variant

Region	Specification (Type Approvals)
USA	FCC Part 15.247
UK	VNS 2107
Eire	ComReg 03/42



18.6 Environmental Specifications

Category	Specification
Temperature	ODU: -40°F(-40°C) to 140°F (+60°C) PIDU Plus: -40°F(-40°C) to 140°F (+60°C)
Wind Loading	150mph Max (242kph)
Humidity	100% Condensing
Waterproof	IP65 (ODU), IP53 (PIDU Plus)
UV Exposure	10 year operational life (UL746C test evidence)



Unit A1, Linhay Business Park
Eastern Road, Ashburton
Devon, TQ 13 7UP, UK

Outside of North America: +44 1364 655500

In North America: +1 877 515-0400

www.motorola.com/ptp